

LEGJENDE

- Shtylle ndricimi
- Pusete Elektrike Ndricimi
- Tub Fleksibel elektrik, ndricim $\phi=80\text{mm}$
- Tub Fleksibel telefoni $\phi=80\text{mm}$
- Pusete kontrolli



BASHKIA KAMEZ

DREJTORIA E SHERBIMEVE PUBLIKE
DREJTORIA E PROJEKTEVE DHE INVESTIMEVE
DEPARTAMENTI I PROJEKTEVE

Dr. e Projekteve e Investimeve FLORA MUCA

STAFI TEKNIK
PROJEKTUES

Ing.	ARJOLA KURTI
Ing.	ERBLIN LALA
Ing.	DENIS PRENCI
Ing.	RAMADAN HYSA

Titulli i Projektit
NDERTIM RRUGET
"PARALEL ME RRUGEN "LIDHJA E PRIZRENIT"
DHE PARALEL ME RRUGEN "IBRAHIM RUGOVA"

Emertimi i Fletes
PLANRILEVIMI I RRUGES

Faza e Projektit
PROJEKT ZBATIMI

Data e Implementimit:



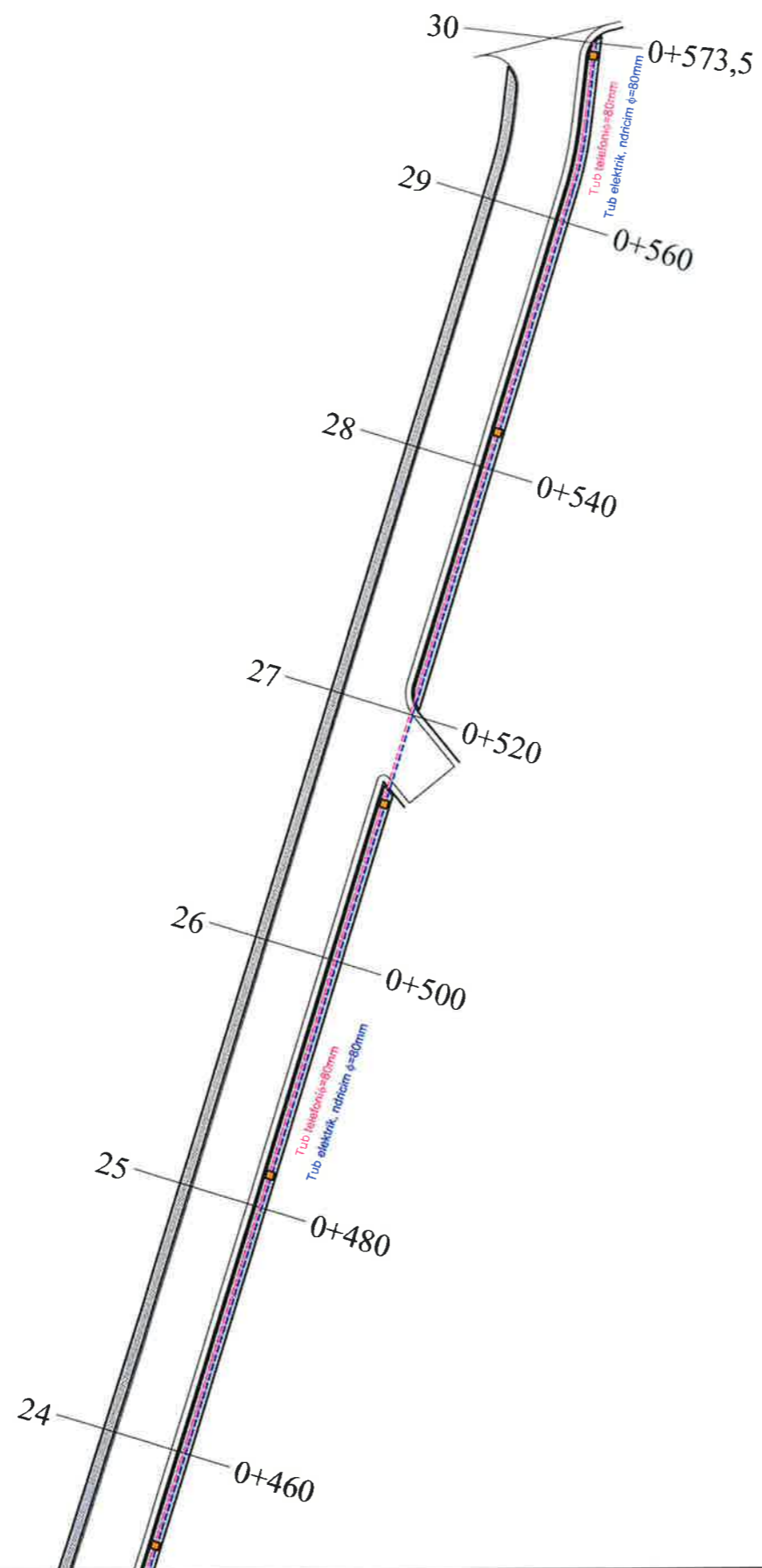

Shkalla e Vizatimit
1:500

Fleta Nr.

04



LEGJENDE

-  Shtylle ndricimi
-  Pusete Elektrike Ndricimi
-  Tub Fleksibel elektriku, ndricim $\phi=80\text{mm}$
-  Tub Fleksibel telefoni $\phi=80\text{mm}$
-  Pusete kontrolli



BASHKIA KAMEZ

DREJTORIA E SHERBIMEVE PUBLIKE
DREJTORIA E PROJEKTEVE DHE INVESTIMEVE
DEPARTAMENTI I PROJEKTEVE

Dr. e Projekteve e Investimeve FLORA MUCA

STAFI TEKNIK
PROJEKTUES

Ing.	ARJOLA KURTI
Ing.	ERBLIN LALA
Ing.	DENIS PRENCI
Ing.	RAMADAN HYSA

Titulli i Projektit
NDERTIM RRUGET
"PARALEL ME RRUGEN "LIDHJA E PRIZRENIT"
DHE PARALEL ME RRUGEN "IBRAHIM RUGOVA"

Faza e Projektit
PROJEKT ZBATIMI

Data e implementimit :

Emertimi i Fletes
PLANRILEVIMI I RRUGES

Shkalla e Vizatimit
1:500

Fleta Nr.
05



BASHKIA KAMEZ

PROJEKT ZBATIMI

OBJEKTI:

NDERTIM RRUGET

**"PARALEL ME RRUGEN "LIDHJA E PRIZRENIT"
DHE PARALEL ME RRUGEN "IBRAHIM RUGOVA"**

PLANIMETRIA E KUB & KUZ



BASHKIA KAMEZ

DREJTORIA E SHERBIMEVE PUBLIKE
DREJTORIA E PROJEKTEVE DHE INVESTIMEVE
DEPARTAMENTI I PROJEKTEVE

Dr. e Projekteve e Investimeve FLORA MUCA

STAFI TEKNIK	Ing.	ARJOLA KURTI
PROJEKTUES	Ing.	ERBLIN LALA
	Ing.	DENIS PRENCI
	Ing.	RAMADAN HYSA

Titulli i Projektit
NDERTIM RRUGET
"PARALEL ME RRUGEN "LIDHJA E PRIZRENIT"
DHE PARALEL ME RRUGEN "IBRAHIM RUGOVA"

Emertimi i Fletes
KAPAK

Faza e Projektit
PROJEKT ZBATIMI

Data e implementimit :

Shkalla e Vizatimit

Fleta Nr.

PIKE SHKARKIMI

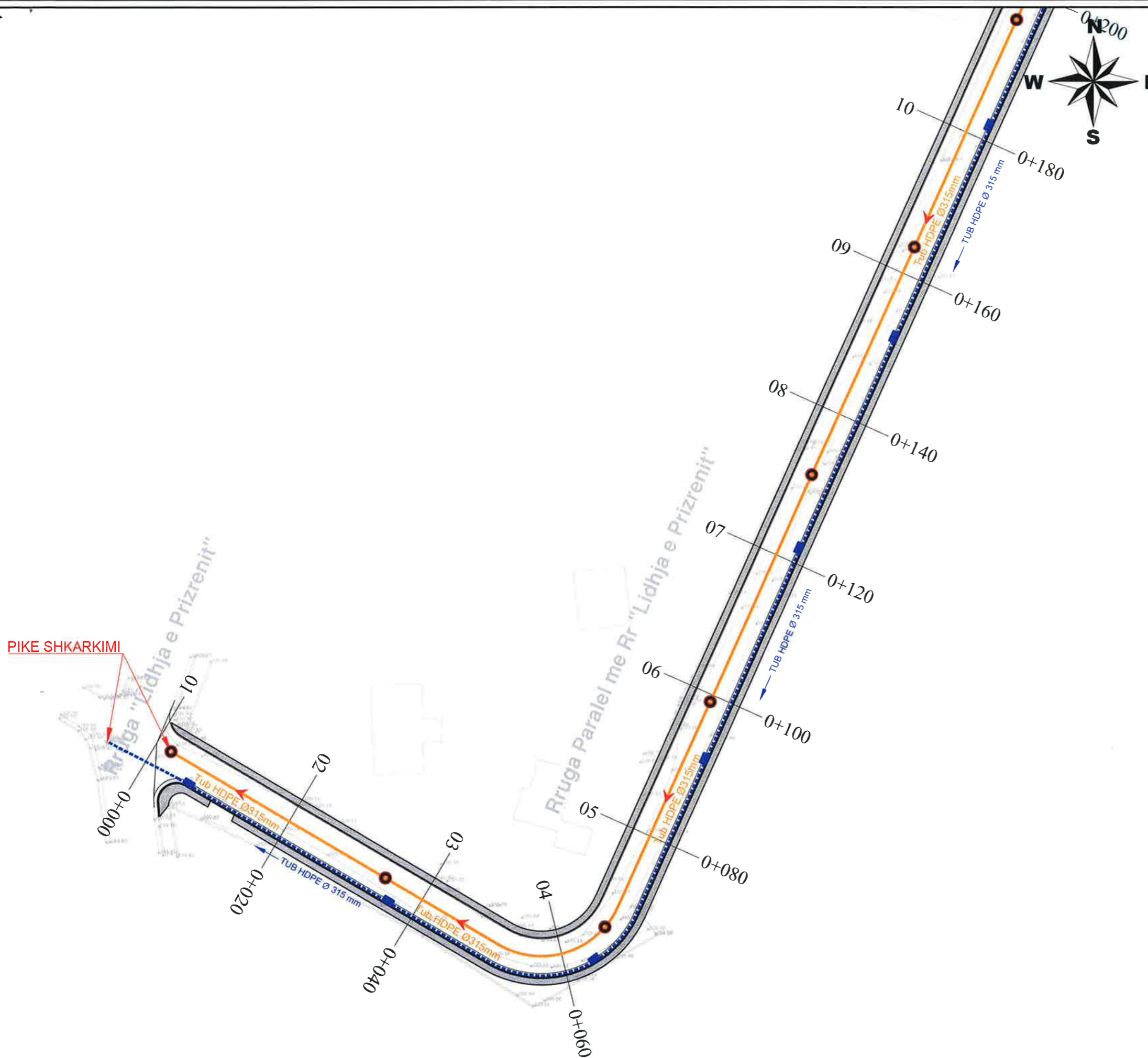

LEGJENDE

- Tub H.D.P.E $\Phi=315$ KUB
- Tub H.D.P.E $\Phi=315$ KUZ
- PUSETE KONTROLLI 1x1x1.5
- PUSETE KUB
- DREJTIMI I RRJEDHES KUB
- DREJTIMI I RRJEDHES



BASHKIA KAMEZ

DREJTORIA E SHERBIMEVE PUBLIKE
DREJTORIA E PROJEKTEVE DHE INVESTIMEVE
DEPARTAMENTI I PROJEKTEVE

Dr. e Projekteve e Investimeve		FLORA MUCA
STAFI TEKNIK PROJEKTES	Ing.	ARJOLA KURTI
	Ing.	ERBLIN LALA
	Ing.	DENIS PRENCI
	Ing.	RAMADAN HYSA

Titulli i Projektit	Faza e Projektit
NDERTIM RRUGET "PARALEL ME RRUGEN "LIDHJA E PRIZRENIT" DHE PARALEL ME RRUGEN "IBRAHIM RUGOVA"	PROJEKT ZBATIMI
Emertimi i Fietes	Shkalla e Vizatimit
PLANRILEVIMI I RRUGES	1:500
	Fleta Nr.
	01

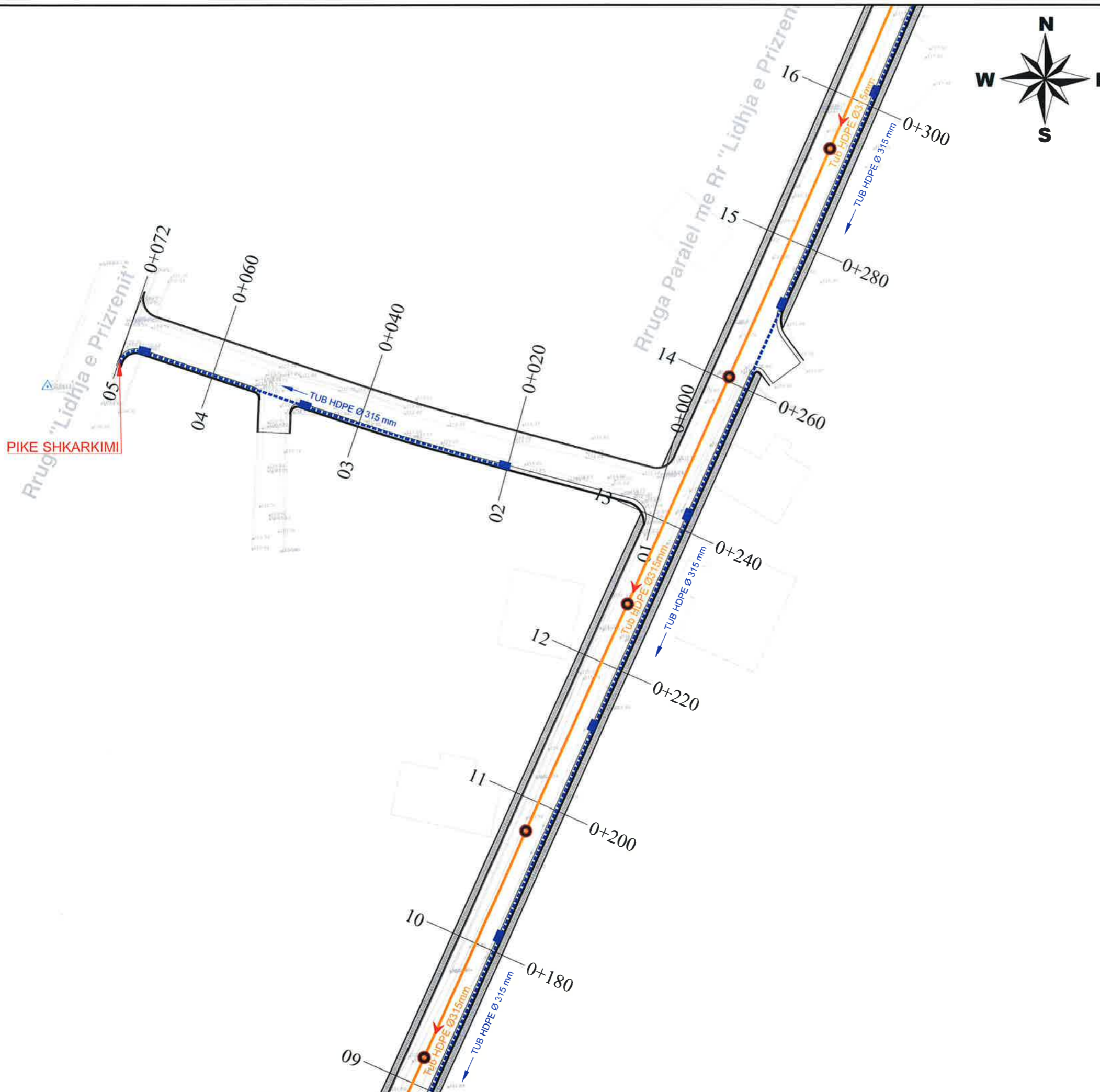

LEGJENDE

- Tub H.D.P.E $\Phi=315$ KUB
- Tub H.D.P.E $\Phi=315$ KUZ
- PUSETE KONTROLLI 1x1x1.5
- PUSETE KUB
- DREJTIMI I RRJEDHES KUB
- DREJTIMI I RRJEDHES



BASHKIA KAMEZ

DREJTORIA E SHERBIMEVE PUBLIKE
DREJTORIA E PROJEKTEVE DHE INVESTIMEVE
DEPARTAMENTI I PROJEKTEVE

Dr. e Projekteve e Investimeve		FLORA MUCA	
STAFI TEKNIK PROJEKTUES	Ing.	ARJOLA KURTI	
	Ing.	ERBLIN LALA	
	Ing.	DENIS PRENCI	
	Ing.	RAMADAN HYSA	

Titulli i Projektit	Faza e Projektit
NDERTIM RRUGET "PARALEL ME RRUGEN "LIDHJA E PRIZRENIT" DHE PARALEL ME RRUGEN "IBRAHIM RUGOVA"	PROJEKT ZBATIMI
Emertimi i Fletes	Data e Implementimit:
PLANRILEVIMI I RRUGES	Shkalla e Vizatimit: 1:500
	Fleta Nr. 02

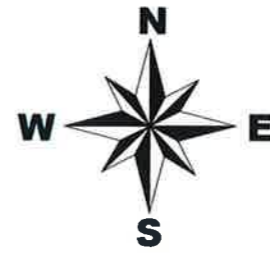
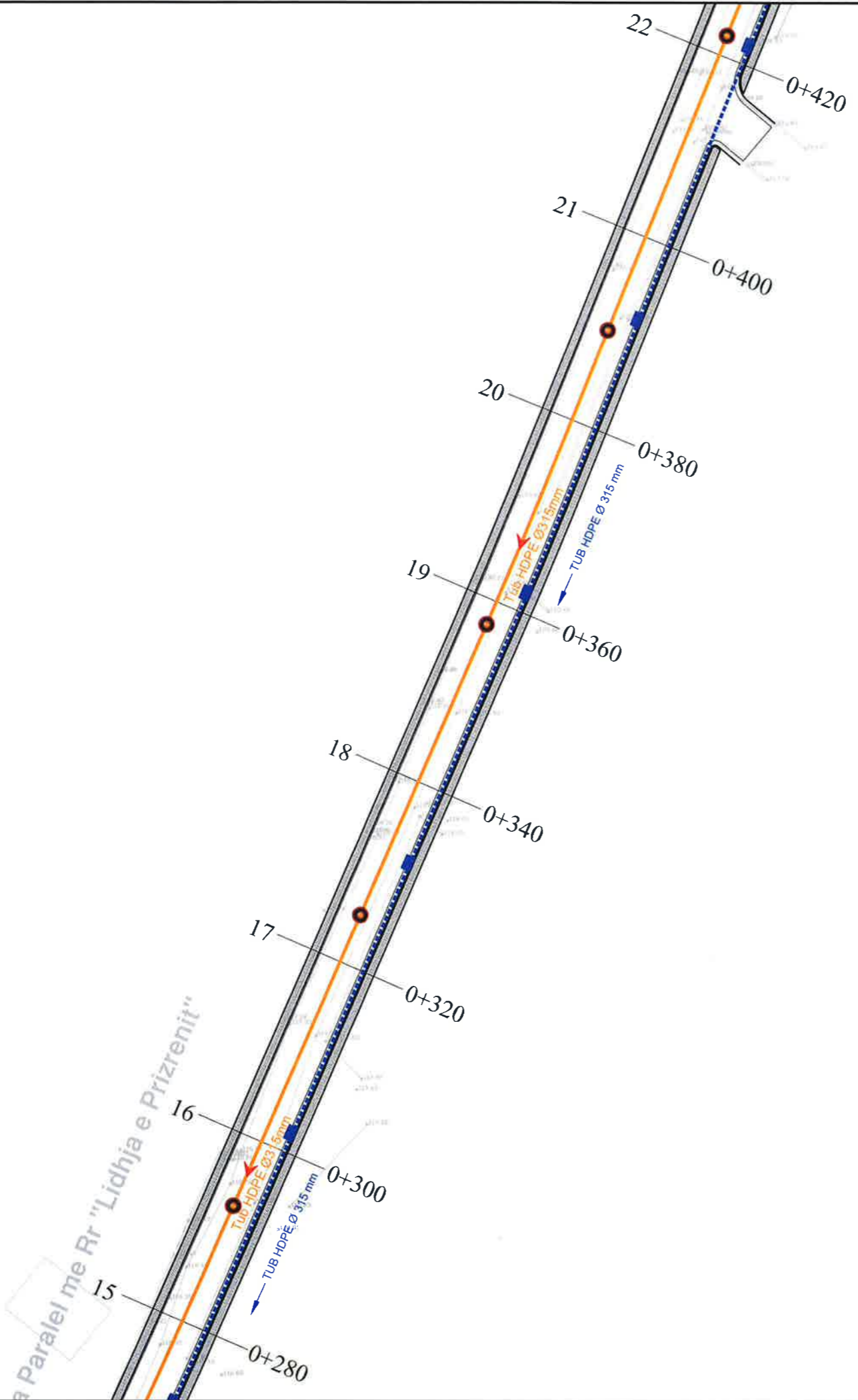

LEGJENDE	
	Tub H.D.P.E Ø=315 KUB
	Tub H.D.P.E Ø=315 KUZ
	PUSETE KONTROLLI 1x1x1.5
	PUSETE KUB
	DREJTIMI I RRJEDHES KUB
	DREJTIMI I RRJEDHES

BASHKIA KAMEZ
 DREJTORIA E SHERBIMEVE PUBLIKE
 DREJTORIA E PROJEKTEVE DHE INVESTIMEVE
 DEPARTAMENTI I PROJEKTEVE

Dr. e Projekteve e Investimeve	FLORA MUCA
STAFI TEKNIK PROJEKTUES	Ing. ARJOLA KURTI Ing. ERBLIN LALA Ing. DENIS PRENCI Ing. RAMADAN HYSA

Titulli i Projektit	NDERTIM RRUGET "PARALEL ME RRUGEN "LIDHJA E PRIZRENIT" DHE PARALEL ME RRUGEN "IBRAHIM RUGOVA"	Faza e Projektit	PROJEKT ZBATIMI
Emertimi i Fletes	PLANRILEVIMI I RRUGES	Data e Implementimit :	
		Shkalla e Vizatimit	1:500
		Fleta Nr.	03

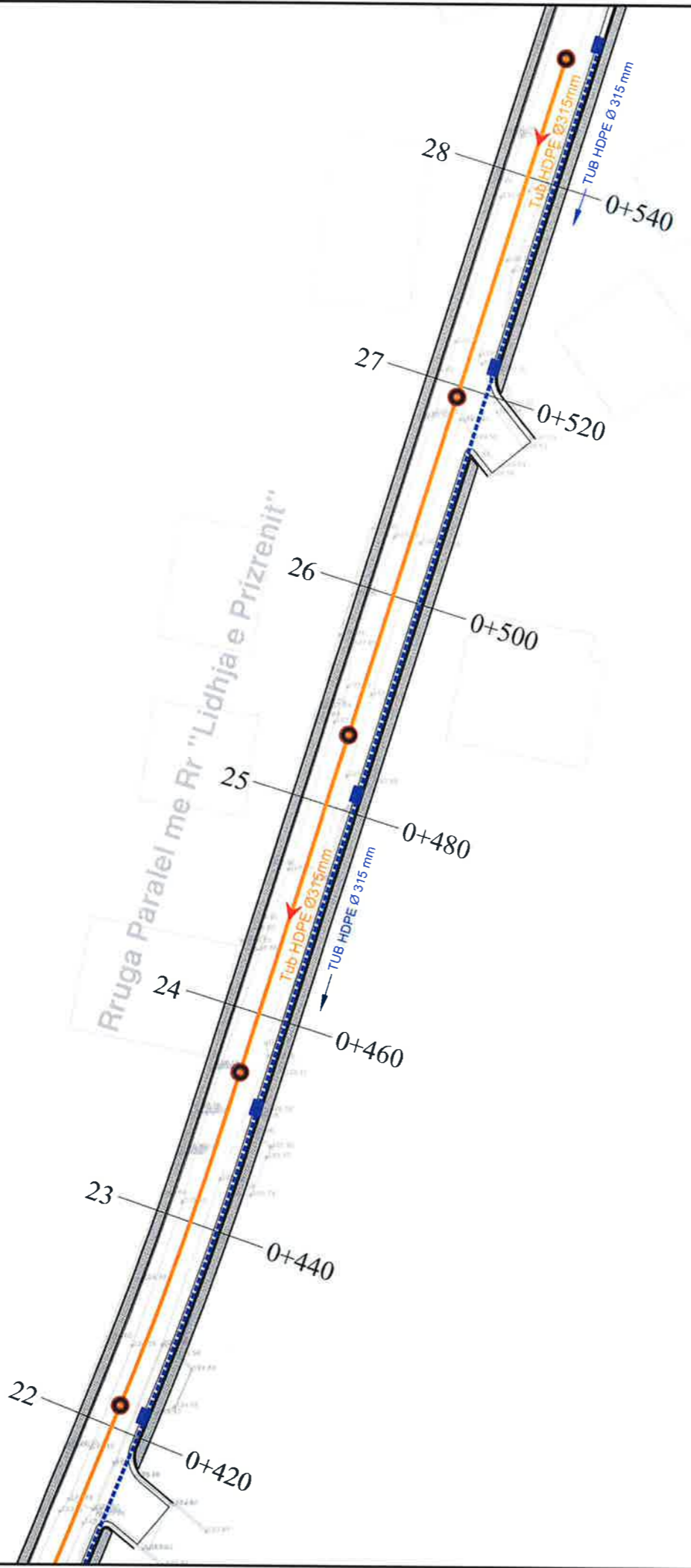

LEGJENDE	
	Tub H.D.P.E Ø=315 KUB
	Tub H.D.P.E Ø=315 KUZ
	PUSETE KONTROLLI 1x1x1.5
	PUSETE KUB
	DREJTIMI I RRJEDHES KUB
	DREJTIMI I RRJEDHES

BASHKIA KAMEZ
 DREJTORIA E SHERBIMEVE PUBLIKE
 DREJTORIA E PROJEKTEVE DHE INVESTIMEVE
 DEPARTAMENTI I PROJEKTEVE

Dr. e Projekteve e Investimeve	FLORA MUCA
STAFI TEKNIK	Ing. ARJOLA KURTI
PROJEKTUES	Ing. ERBLIN LALA
	Ing. DENIS PRENCI
	Ing. RAMADAN HYSA

Titulli i Projektit	Faza e Projektit
NDERTIM RRUGET "PARALEL ME RRUGEN "LIDHJA E PRIZRENIT" DHE PARALEL ME RRUGEN "IBRAHIM RUGOVA"	PROJEKT ZBATIMI
Emertimi i Fletes	Data e Implementimit :
PLANRILEVIMI I RRUGES	Shkalla e Vizatimit
	1:500
	Fleta Nr.
	04

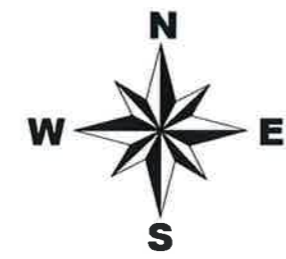
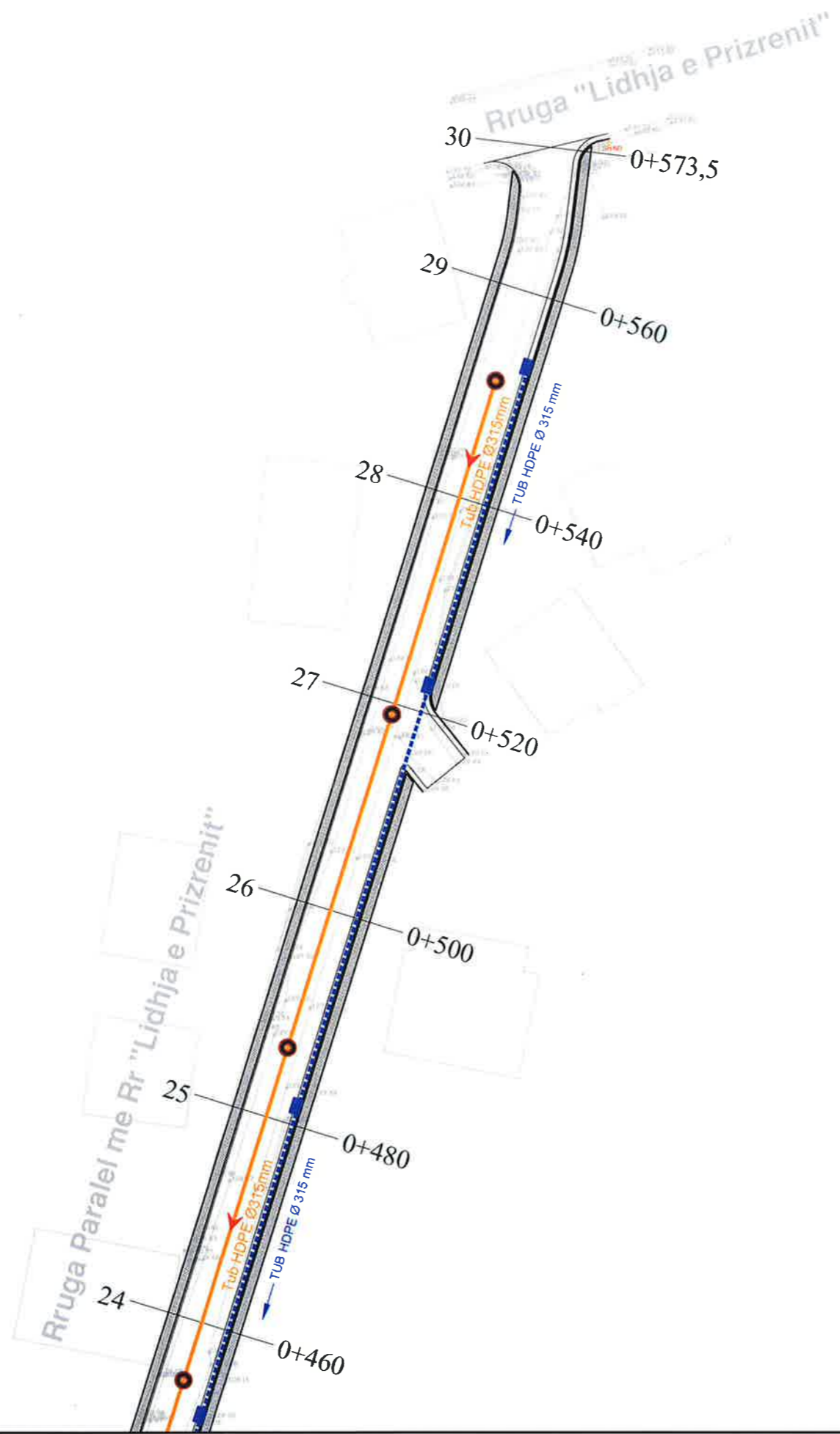

LEGJENDE	
	Tub H.D.P.E $\Phi=315$ KUB
	Tub H.D.P.E $\Phi=315$ KUZ
	PUSETE KONTROLI 1x1x1.5
	PUSETE KUB
	DREJTIMI I RRJEDHES KUB
	DREJTIMI I RRJEDHES



BASHKIA KAMEZ

DREJTORIA E SHERBIMEVE PUBLIKE
DREJTORIA E PROJEKTEVE DHE INVESTIMEVE
DEPARTAMENTI I PROJEKTEVE

Dr. e Projekteve e Investimeve		FLORA MUCA
STAFI TEKNIK PROJEKTES	Ing.	ARJOLA KURTI
	Ing.	ERBLIN LALA
	Ing.	DENIS PRENCI
	Ing.	RAMADAN HYSA

Titulli i Projektit NDERTIM RRUGET "PARALEL ME RRUGEN "LIDHJA E PRIZRENIT" DHE PARALEL ME RRUGEN "IBRAHIM RUGOVA"	Faza e Projektit PROJEKT ZBATIMI Data e Implementimit: Sihalla e Vizatimit 1:500 Fleta Nr. 05
Emertimi i Fletes PLANRILEVIMI I RRUGES	



BASHKIA KAMEZ

PROJEKT ZBATIMI

OBJEKTI:

NDERTIM RRUGET

**"PARALEL ME RRUGEN "LIDHJA E PRIZRENIT"
DHE PARALEL ME RRUGEN "IBRAHIM RUGOVA"**

PROFILI TERTHOR TIP



BASHKIA KAMEZ

DREJTORIA E SHERBIMEVE PUBLIKE
DREJTORIA E PROJEKTEVE DHE INVESTIMEVE
DEPARTAMENTI I PROJEKTEVE

Dr. e Projekteve e Investimeve FLORA MUCA

STAFI TEKNIK	Ing.	ARJOLA KURTI
PROJEKTUES	Ing.	ERBLIN LALA
	Ing.	DENIS PRENCI
	Ing.	RAMADAN HYSA

Titulli i Projektit
NDERTIM RRUGET
"PJESHKORE, VELIPOJE, + RRUGICAT, BALLSHI,
VALIAS
PINGUL ME HEKURAN DEKEN LAKNAS"

Emertimi i Fietes
KAPAK

Piza e Projektit
PROJEKT ZBATIMI

Data e Implementimit :

Shkalla e Vizatimit

Fleta Nr.

PROFIL TERTHOR TIP 1
Rruga Paralel me Rrugen "Lidhja e Prizrenit"
Sh-1:50

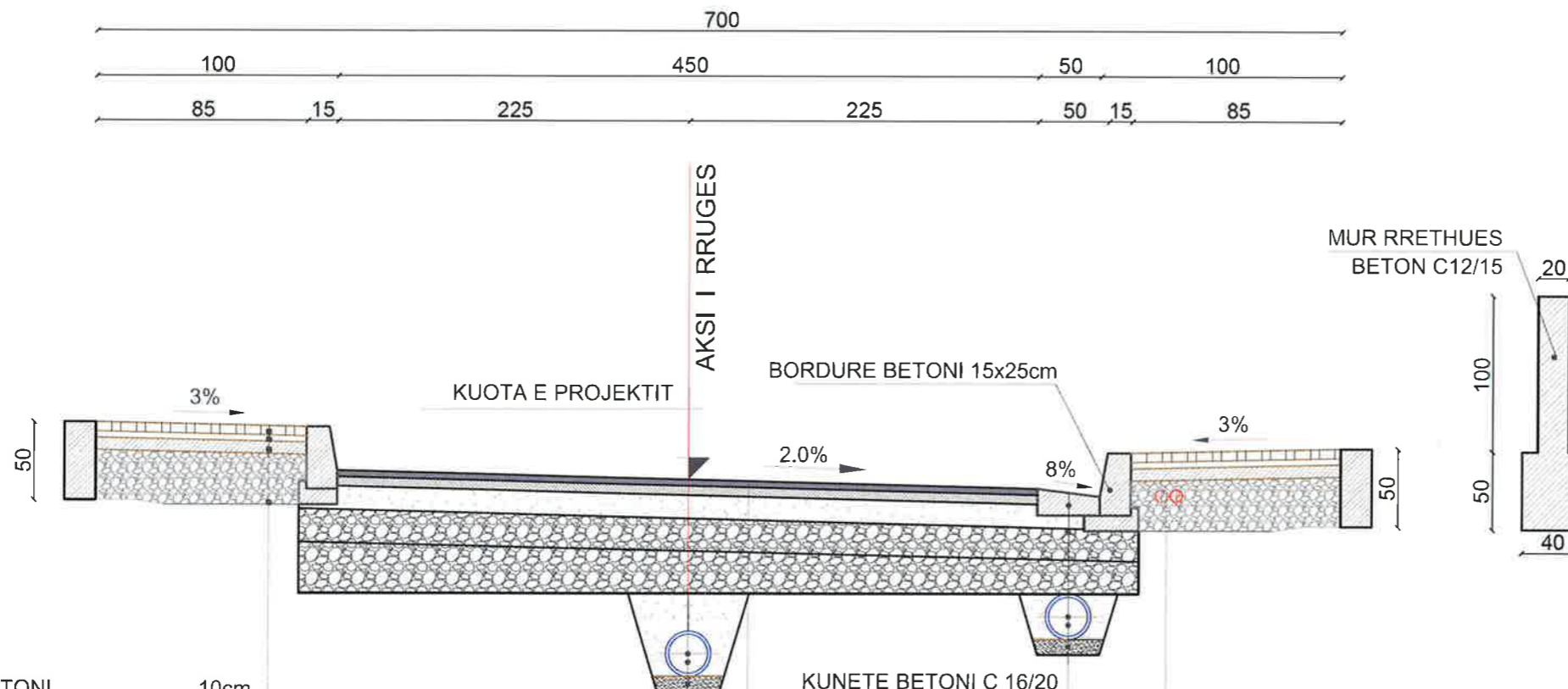

SHTRESE BETONI	10cm
SHTRESE STABILIZANT	10cm
SHTRESE ÇAKELLI	10cm
MBUSHJE ME ÇAKELL	10cm

TUB Ø 315 PER K.U.Z.
MBUSHJE ME ÇAKELL
JASTEK RERE 10cm
SHTRESE ASFALTOBETONI 4cm
SHTRESE BINDERI 6cm
SHTRESE STABILIZANTI 10cm
ÇAKELL MAKINERIE 20cm
MBUSHJE ÇAKELL GUR KAVE

KUNETE BETONI C 16/20
ÇAKELL
TUB Ø 315 PER K.U.B.
MBUSHJE ME ÇAKELL
JASTEK RERE 10cm
TUB Ø 80 P.V.C PER NDRIÇIM
TUB Ø 80 P.V.C PER TELEFONI

BASHKIA KAMEZ
DREJTORIA E SHERBIMEVE PUBLIKE
DREJTORIA E PROJEKTEVE DHE INVESTIMEVE
DEPARTAMENTI I PROJEKTEVE

Dr. e Projekteve e Investimeve	FLORA MUCA
STAFI TEKNIK	Ing. ARJOLA KURTI
PROJEKTUES	Ing. ERBLIN LALA
	Ing. DENIS PRENCI
	Ing. RAMADAN HYSA

Titulli i Projektit	Fazë e Projektit
NDERTIM RRUGET "PARALEL ME RRUGEN "LIDHJA E PRIZRENIT" DHE PARALEL ME RRUGEN "IBRAHIM RUGOVA"	PROJEKT ZBATIMI
Emertimi i Fletes	Shkalla e Vizatimit
PROFILI TERTHOR TIP	1:50
	Fleta Nr.
	01

PROFIL TERTHOR TIP 2
Degezim Rruga Paralel me Rrugen "Lidhja e Prizrenit"
Sh-1:50

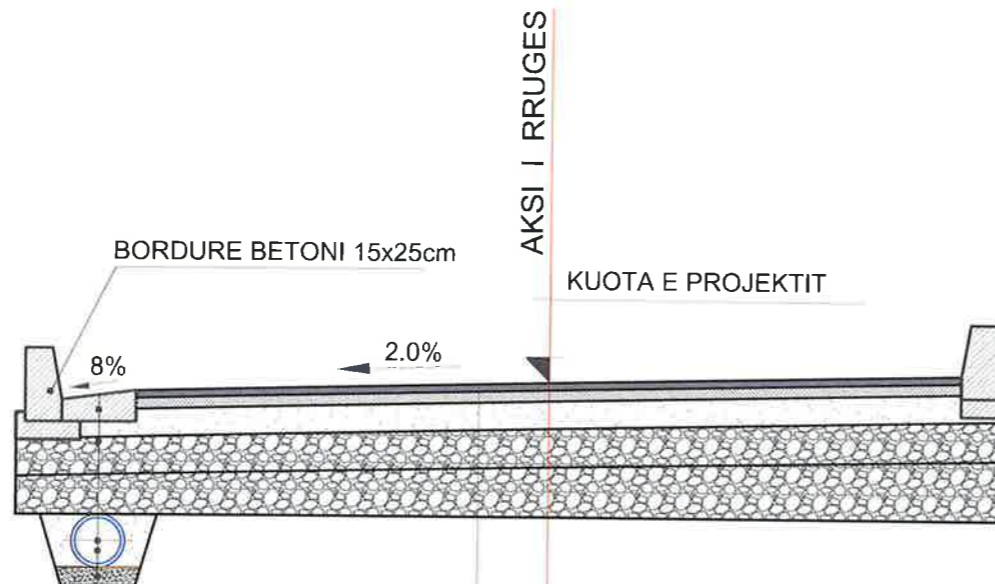
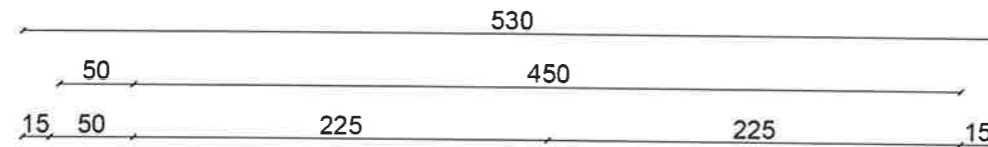

KUNETE BETONI C 16/20
 ÇAKELL
 TUB Ø 315 PER K.U.B.
 MBUSHJE ME ÇAKELL
 JASTEK RERE 10cm

SHTRESE ASFALTOBETONI 4cm
 SHTRESE BINDERI 6cm
 SHTRESE STABILIZANTI 10cm
 ÇAKELL MAKINERIE 20cm
 MBUSHJE ÇAKELL GUR KAVE

BASHKIA KAMEZ
 DREJTORIA E SHERBIMEVE PUBLIKE
 DREJTORIA E PROJEKTEVE DHE INVESTIMEVE
 DEPARTAMENTI I PROJEKTEVE

Dr. e Projekteve e Investimeve		FLORA MUCA
STAFI TEKNIK PROJEKTUES	Ing.	ARJOLA KURTI
	Ing.	ERBLIN LALA
	Ing.	DENIS PRENCI
	Ing.	RAMADAN HYSA

Titulli i Projektit	Faza e Projektit
NDERTIM RRUGET "PARALEL ME RRUGEN "LIDHJA E PRIZRENIT" DHE PARALEL ME RRUGEN "IBRAHIM RUGOVA"	PROJEKT ZBATIMI
Emertimi i Fletes	Data e Implementimit :
PROFILI TERTHOR TIP	Sihalla e Vizatimit 1:50
	Fleta Nr. 02

PROFIL TERTHOR TIP 3
 Rruga Paralel me Rrugen "Ibrahim Rugova"
 AKSI 1&2
 Sh-1:50

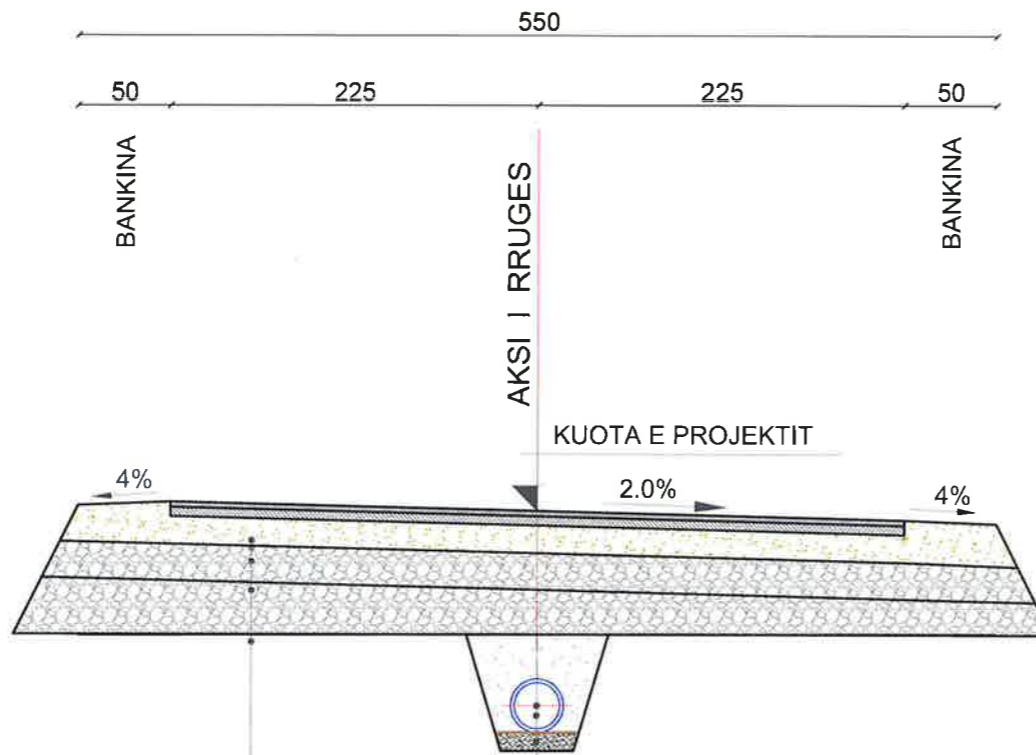

TUB Ø 315 PER K.U.Z.
 MBUSHJE ME ÇAKELL
 JASTEK RERE 10cm

SHTRESE ASFALTOBETONI	4 cm
SHTRESE BINDERI	6cm
SHTRESE STABILIZANTI	10cm
SHTRESE ÇAKELL	20cm
MBUSHJE ME ÇAKELL	



BASHKIA KAMEZ

DREJTORIA E SHERBIMEVE PUBLIKE
 DREJTORIA E PROJEKTEVE DHE INVESTIMEVE
 DEPARTAMENTI I PROJEKTEVE

Dr. e Projekteve e Investimeve FLORA MUCA

STAFI TEKNIK PROJEKTES	Ing.	ARJOLA KURTI
	Ing.	ERBLIN LALA
	Ing.	DENIS PRENCI
	Ing.	RAMADAN HYSA

Titulli i Projektit
 NDERTIM RRUGET
 "PARALEL ME RRUGEN "LIDHJA E PRIZRENIT"
 DHE PARALEL ME RRUGEN "IBRAHIM RUGOVA"

Emertimi i Fletes
 PROFILI TERTHOR TIP

Faza e Projektit
 PROJEKT ZBATIMI

Data e Implementimit :

Shkalla e Vizatimit
 1:50

Fleta Nr.

03



BASHKIA KAMEZ

PROJEKT ZBATIMI

OBJEKTI:

NDERTIM RRUGET

"PARALEL ME RRUGEN "LIDHJA E PRIZRENIT"
DHE PARALEL ME RRUGEN "IBRAHIM RUGOVA""

PROFILI GJATESOR I RRUGES



BASHKIA KAMEZ

DREJTORIA E SHERBIMEVE PUBLIKE
DREJTORIA E PROJEKTEVE DHE INVESTIMEVE
DEPARTAMENTI I PROJEKTEVE

Dr. e Projekteve e Investimeve FLORA MUCA

STAFI TEKNIK
PROJEKTUES
Ing. ARJOLA KURTI
Ing. ERBLIN LALA
Ing. DENIS PRENCI
Ing. RAMADAN HYSA

Titulli i Projektit
NDERTIM RRUGET
"PARALEL ME RRUGEN "LIDHJA E PRIZERENIT"
DHE PARALEL ME RRUGEN "IBRAHIM RUGOVA""

Emertimi i Fletes
KAPAK

Paiza e Projektit
PROJEKT ZBATIMI

Data e Implementimit:

Shkalla e Vizatimit:

Fleta Nr.

**RRUGA PARALEL ME
RR"LIDHJA E PRIZERENIT"**

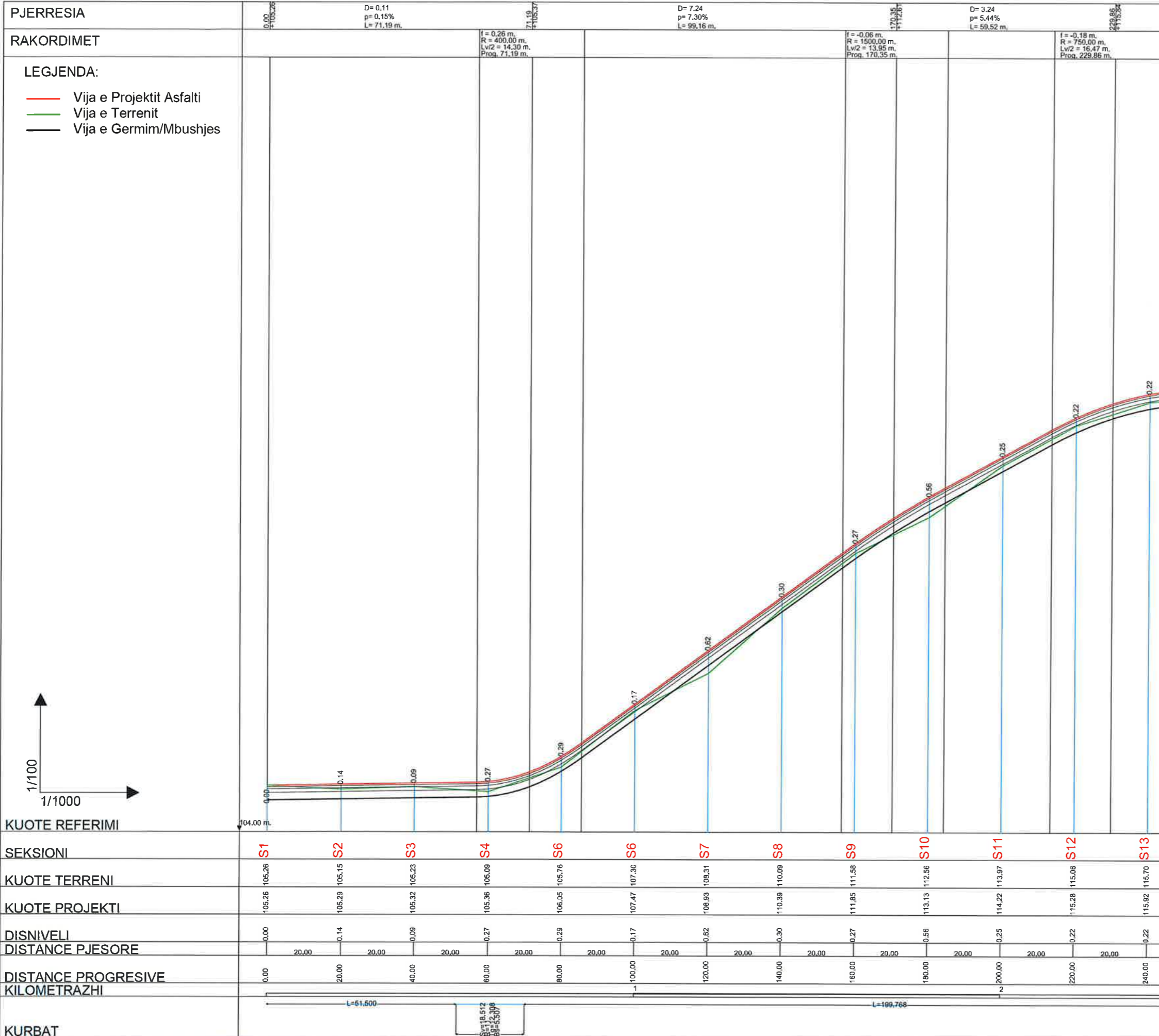

1/100
1/1000

KUOTE REFERIMI	104.00 m													
SEKSIONI	S1	S2	S3	S4	S6	S6	S7	S8	S9	S10	S11	S12	S13	
KUOTE TERRENI	105.26	105.15	105.23	105.09	105.76	107.30	108.31	110.09	111.58	112.56	113.97	115.06	115.70	
KUOTE PROJEKTI	105.26	105.29	105.32	105.36	106.05	107.47	108.93	110.39	111.85	113.13	114.22	115.28	115.92	
DISNIVELI	0.00	0.14	0.09	0.27	0.29	0.17	0.62	0.30	0.27	0.56	0.25	0.22	0.22	
DISTANCE PJESORE	20.00	20.00	20.00	20.00	20.00	20.00	20.00	20.00	20.00	20.00	20.00	20.00	20.00	
DISTANCE PROGRESIVE KILOMETRAZHI	0.00	20.00	40.00	60.00	80.00	100.00	120.00	140.00	160.00	180.00	200.00	220.00	240.00	
KURBAT	L=51.500		L=18.512 L=12.308 L=5.507		L=199.768									

BASHKIA KAMEZ
DREJTORIA E SHERBIMEVE PUBLIKE
DREJTORIA E PROJEKTEVE DHE INVESTIMEVE
DEPARTAMENTI I PROJEKTEVE

Dr. e Projekteve e Investimeve	FLORA MUCA
STAFI TEKNIK PROJEKTES	Ing. ARJOLA KURTI Ing. ERBLIN LALA Ing. DENIS PRENCI Ing. RAMADAN HYSA

PROFILI GJATESOR I RRUGES

Emertimi i Fietes

Skalla e Vizimit: H-1:1000 V-1:100
Fleta Nr. 01

RRUGA PARALEL ME RR"LIDHJA E PRIZERENIT"

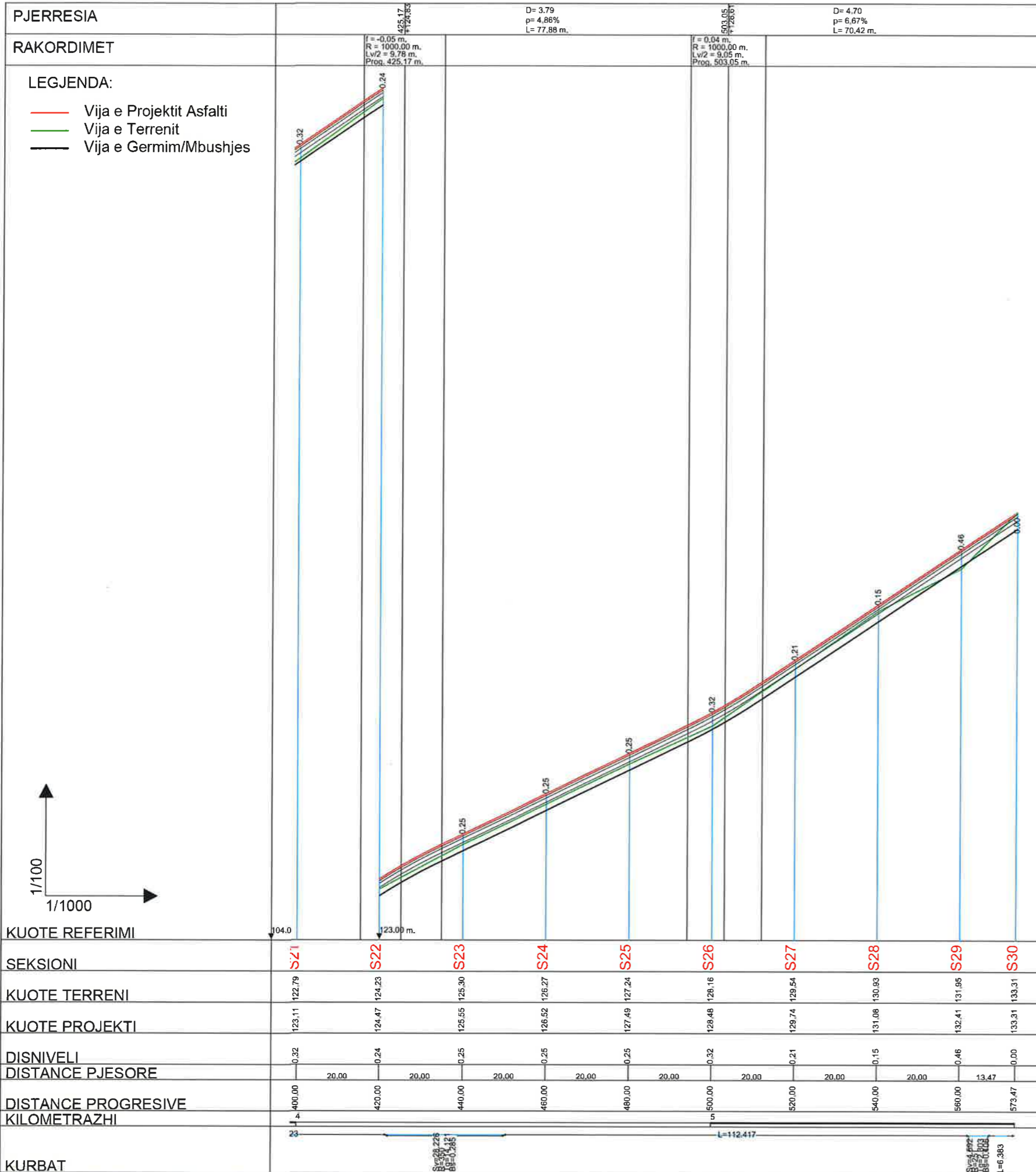

BASHKIA KAMEZ
 DREJTORIA E SHERBIMEVE PUBLIKE
 DREJTORIA E PROJEKTEVE DHE INVESTIMEVE
 DEPARTAMENTI I PROJEKTEVE

Dr. e Projekteve e Investimeve	FLORA MUCA
STAFI TEKNIK PROJEKTES	Ing. ARJOLA KURTI Ing. ERBLIN LALA Ing. DENIS PRENCI Ing. RAMADAN HYSA

Titulli i Projektit
 NDERTIM RRUGET
 "PARALEL ME RRUGEN "LIDHJA E PRIZERENIT"
 DHE PARALEL ME RRUGEN "IBRAHIM RUGOVA"

Faza e Projektit
 PROJEKT ZBATIMI

Shkalla e Vizatimit
 H-1:1000 V-1:100

Emeritimi i Pjeses
 PROFILI GJATESOR I RRUGES

Fleta Nr.
 03

**RRÛGA PARALEL ME
RR"IBRAHIM RUGOVA" AKSI 1**

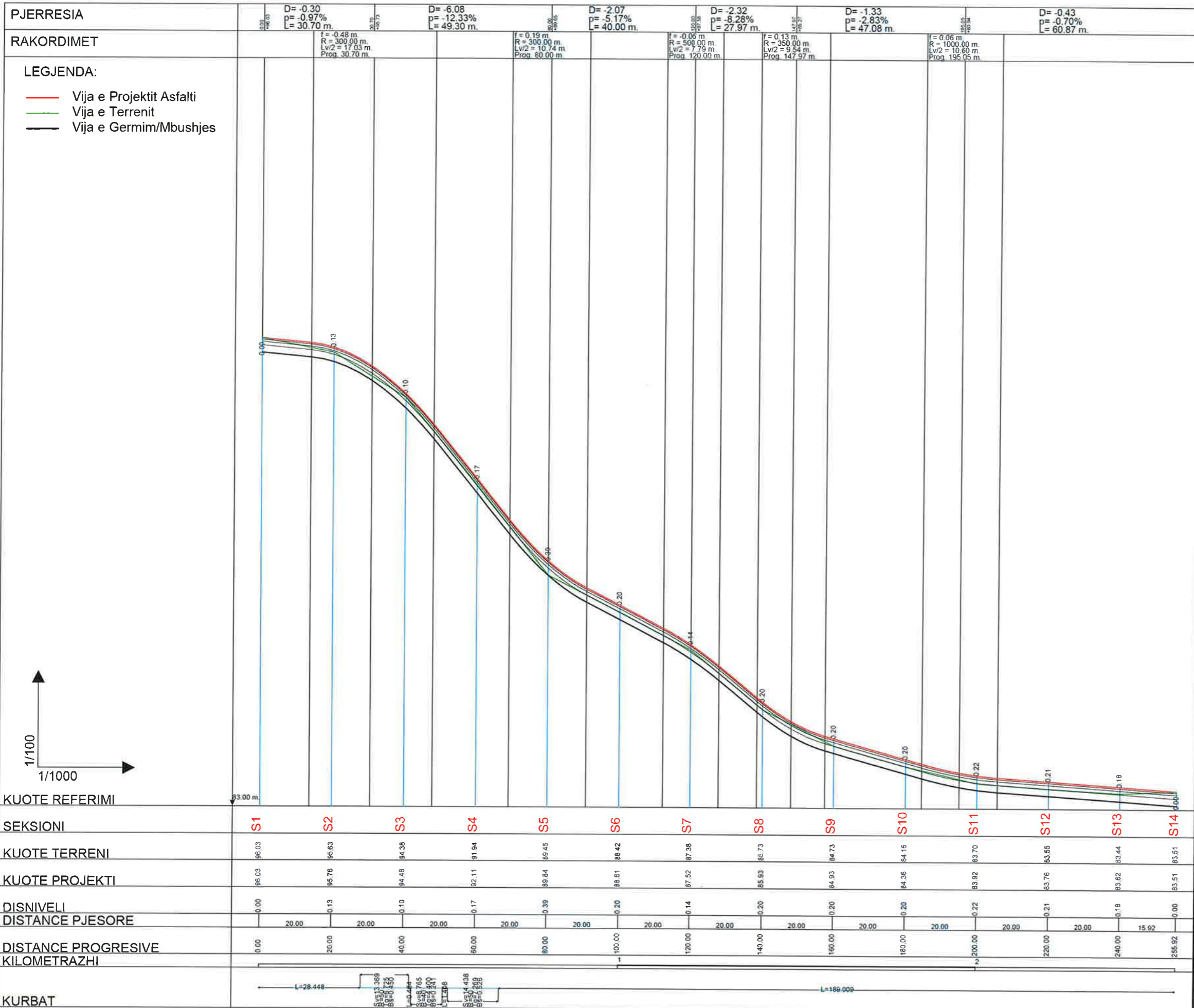

BASHKIA KAMEZ
DREJTORIA E SHERBIMEVE PUBLIKE
DREJTORIA E PROJEKTEVE DHE INVESTIMEVE
DEPARTAMENTI I PROJEKTEVE

Dr. e Projekteve e Investimeve	FLORA MUCA
STAFI TEKNIK	Ing. ARJOLA KURTI
PROJEKTUES	Ing. ERBLIN LALA
	Ing. DENIS PRENCI
	Ing. RAMADAN HYSA

Titulli i Projektit
NDERTIM RRUGET
"PARALEL ME RRUGEN "LIDHJA E PRIZRENIT"
DHE PARALEL ME RRUGEN "IBRAHIM RUGOVA"

Faza e Projektit
PROJEKT ZBATIMI

Data e Implementimit:

Shkalla e Vizatimit
H-1:1000 V-1:100

Emertimi i Fietes
PROFILI GJATESOR I RRUGES

Fleta Nr.
04

RRUGA PARALEL ME
RR"IBRAHIM RUGOVA" AKSI 2

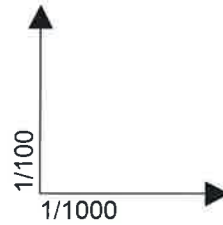
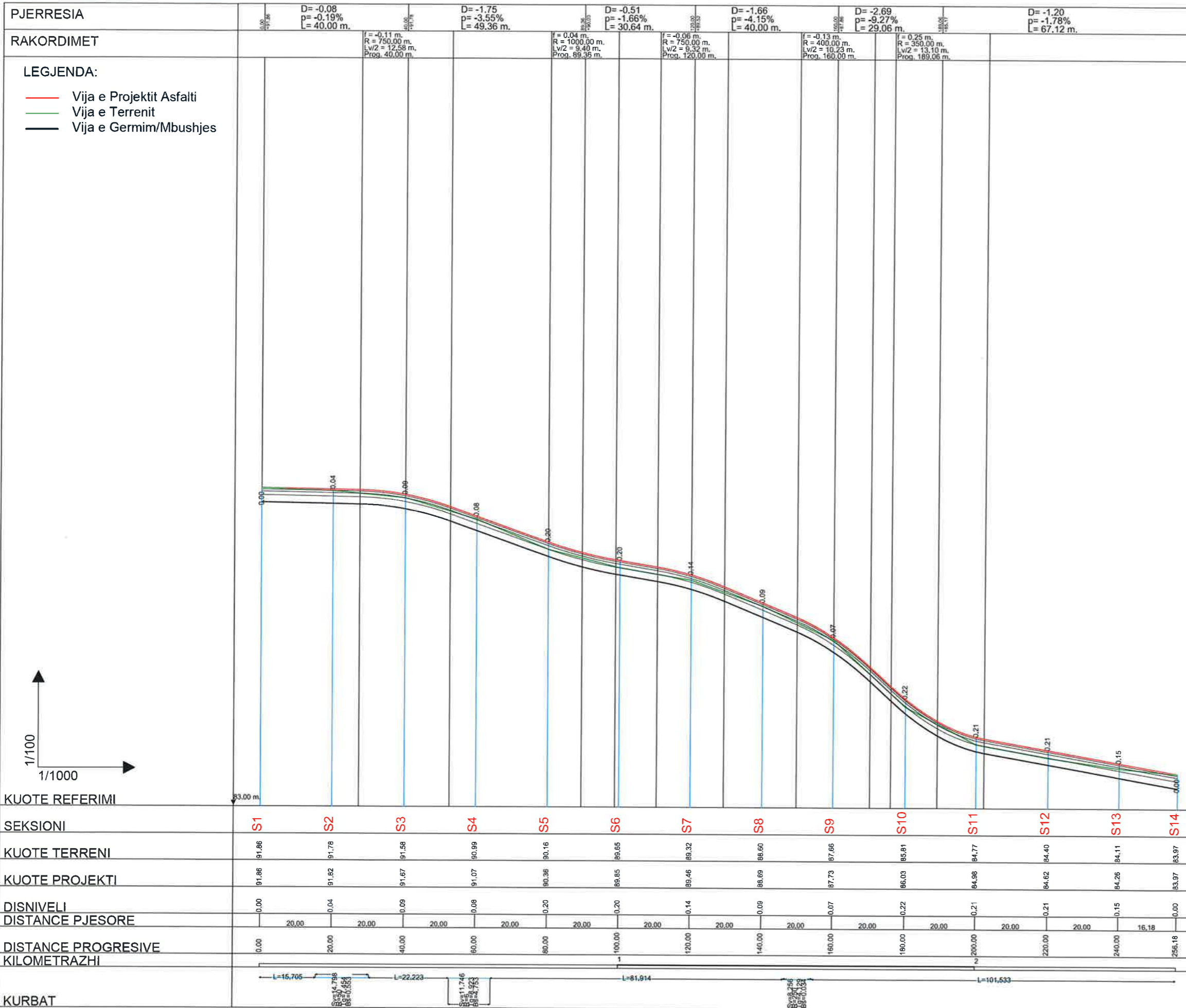

BASHKIA KAMEZ
DREJTORIA E SHERBIMEVE PUBLIKE
DREJTORIA E PROJEKTEVE DHE INVESTIMEVE
DEPARTAMENTI I PROJEKTEVE

Dr. e Projekteve e Investimeve	FLORA MUCA
STAFI TEKNIK PROJEKTUES	Ing. ARJOLA KURTI Ing. ERBLIN LALA Ing. DENIS PRENCI Ing. RAMADAN HYSA

Titulli i Projektit
NDERTIM RRUGET
"PARALEL ME RRUGEN "LIDHJA E PRIZRENIT"
DHE PARALEL ME RRUGEN "IBRAHIM RUGOVA"

Faza e Projektit
PROJEKT ZBATIMI

Data e implementimit:

Shkalla e Vizatimit
H-1:1000 V-1:100

Emersimi i Fletes
PROFILI GJATESOR I RRUGES

Fleta Nr.
05



BASHKIA KAMEZ

PROJEKT ZBATIMI

OBJEKTI:

NDERTIM RRUGET

"PARALEL ME RRUGEN "LIDHJA E PRIZRENIT"
DHE PARALEL ME RRUGEN "IBRAHIM RUGOVA""

PROFILET TERTHORE



BASHKIA KAMEZ

DREJTORIA E SHERBIMEVE PUBLIKE
DREJTORIA E PROJEKTEVE DHE INVESTIMEVE
DEPARTAMENTI I PROJEKTEVE

Dr. e Projekteve e Investimeve		FLORA MUCA	
STAFI TEKNIK PROJEKTUES	Ing.	ARJOLA KURTI	
	Ing.	ERBLIN LALA	
	Ing.	DENIS PRENCI	
	Ing.	RAMADAN HYSA	

Titulli i Projektit NDERTIM RRUGET "PARALEL ME RRUGEN "LIDHJA E PRIZRENIT" DHE PARALEL ME RRUGEN "IBRAHIM RUGOVA"	Titulli i Projektit PROJEKT ZBATIMI
Emertimi i Filetit KAPAK	Data e Implementimit: Shkalla e Vizimit: Faza Nr.:

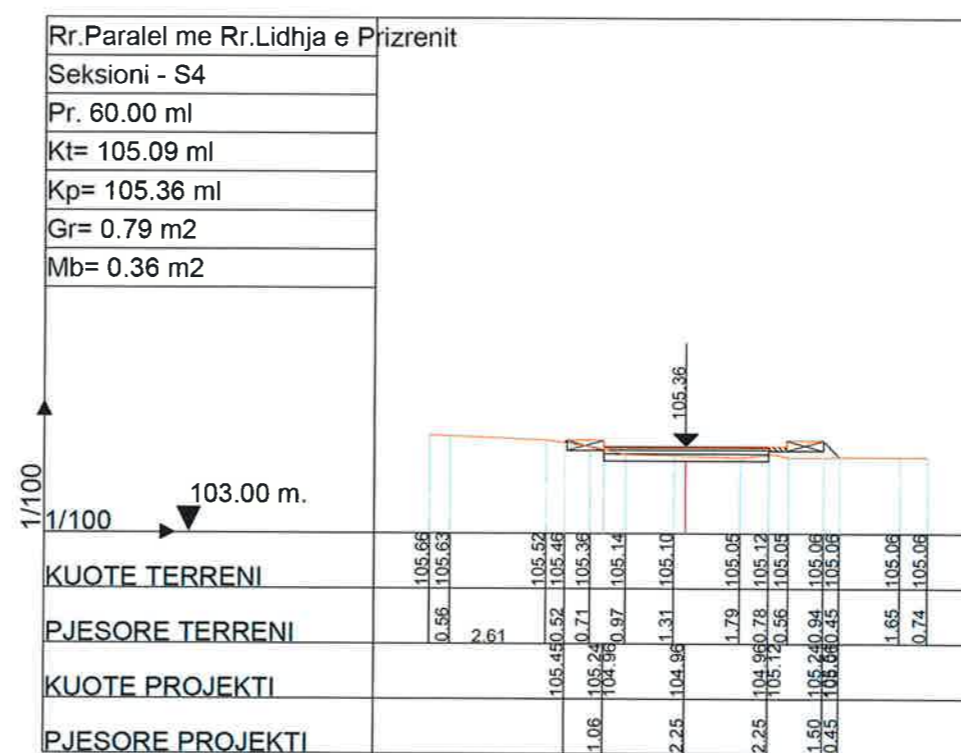
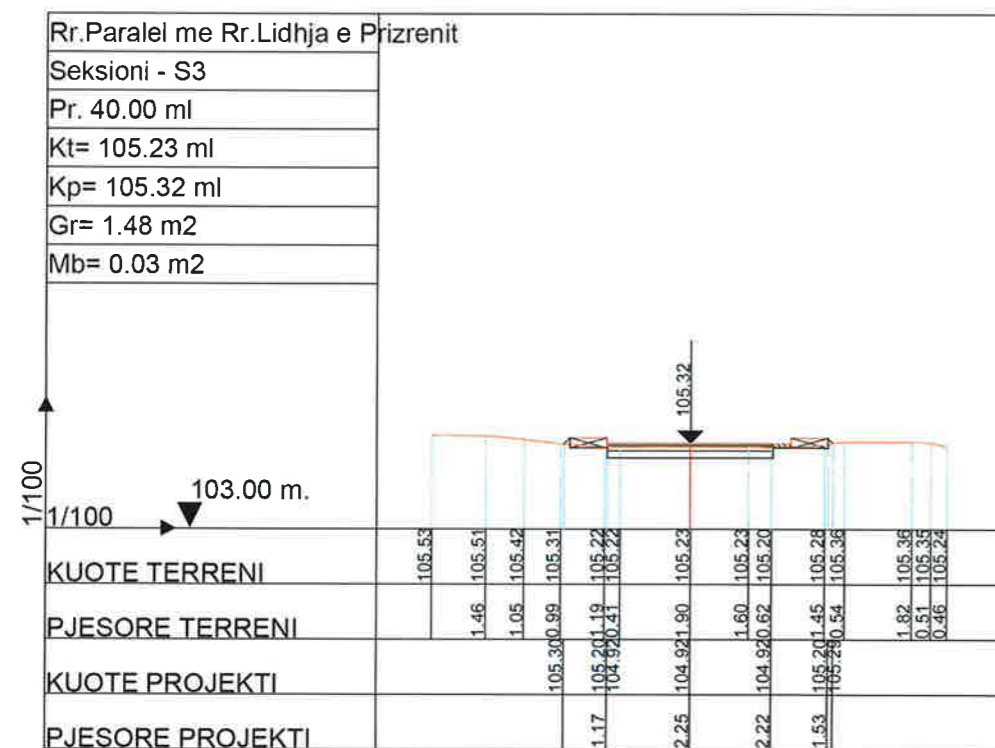
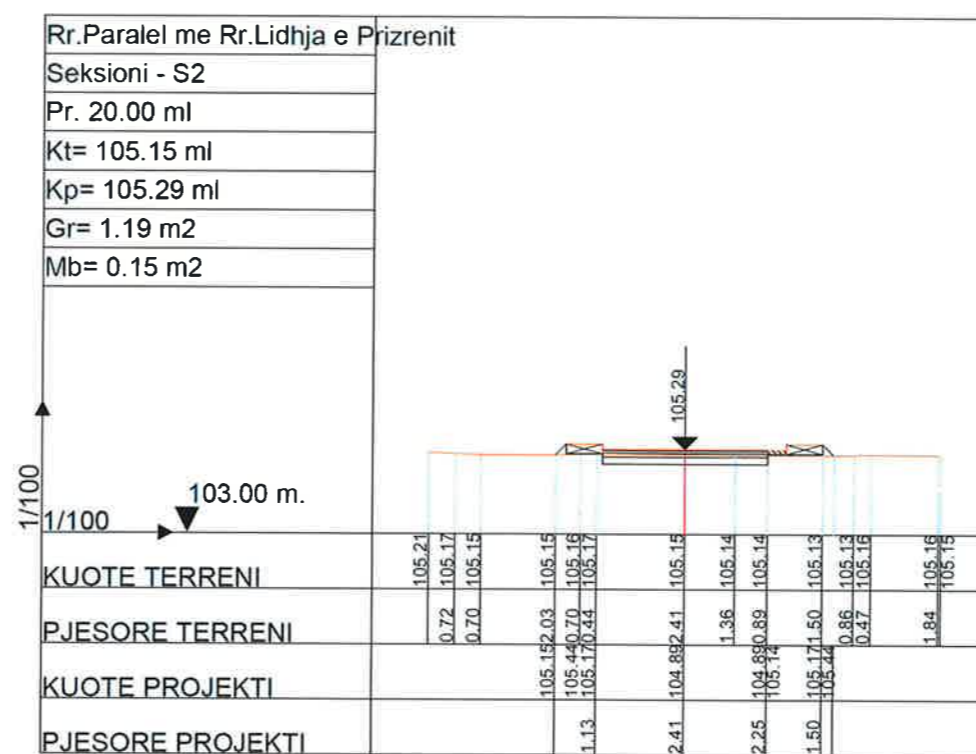
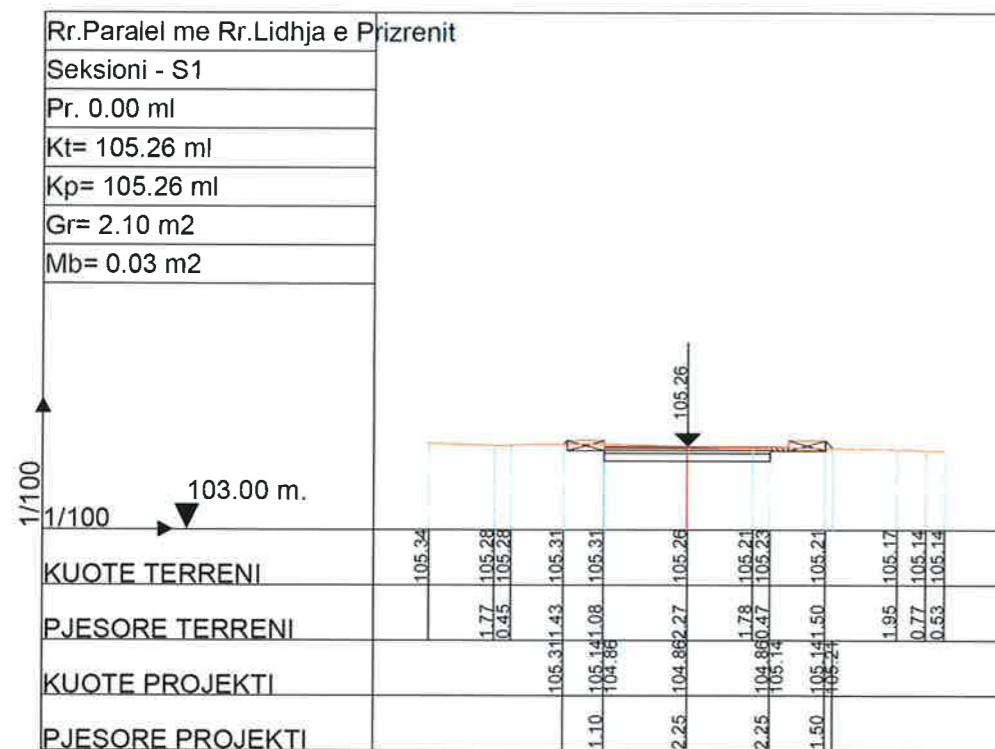

BASHKIA KAMEZ

DREJTORIA E SHERBIMEVE PUBLIKE
DREJTORIA E PROJEKTEVE DHE INVESTIMEVE
DEPARTAMENTI I PROJEKTEVE

Dr. e Projekteve e Investimeve	FLORA MUCA								
STAFI TEKNIK PROJEKTES	<table style="width: 100%; border-collapse: collapse;"> <tr><td style="width: 20%; font-size: x-small;">Ing.</td><td>ARJOLA KURTI</td></tr> <tr><td style="font-size: x-small;">Ing.</td><td>ERBLIN LALA</td></tr> <tr><td style="font-size: x-small;">Ing.</td><td>DENIS PRENCI</td></tr> <tr><td style="font-size: x-small;">Ing.</td><td>RAMADAN HYSA</td></tr> </table>	Ing.	ARJOLA KURTI	Ing.	ERBLIN LALA	Ing.	DENIS PRENCI	Ing.	RAMADAN HYSA
Ing.	ARJOLA KURTI								
Ing.	ERBLIN LALA								
Ing.	DENIS PRENCI								
Ing.	RAMADAN HYSA								
Titulli i Projektit	Faza e Projektit								
NDERTIM RRUGET "PARALEL ME RRUGEN "LIDHJA E PRIZRENIT" DHE PARALEL ME RRUGEN "IBRAHIM RUGOVA"	PROJEKT ZBATIMI								
Emertimi i Fletes	Data e Implementimit :								
PROFILET TERTHORE	Challa e Vizimit 1:200								
	Fleta Nr. 01								

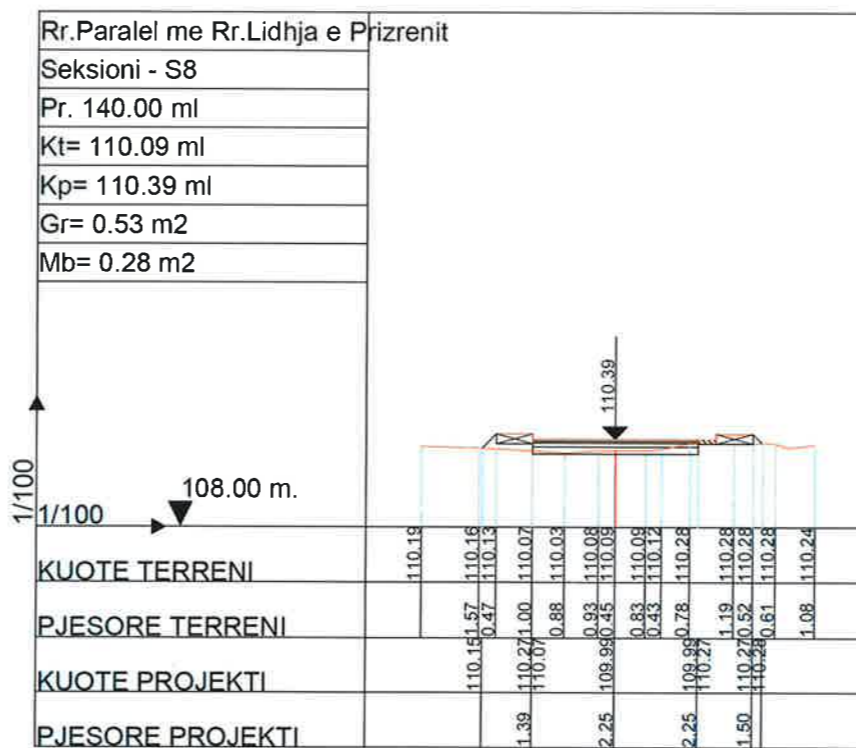
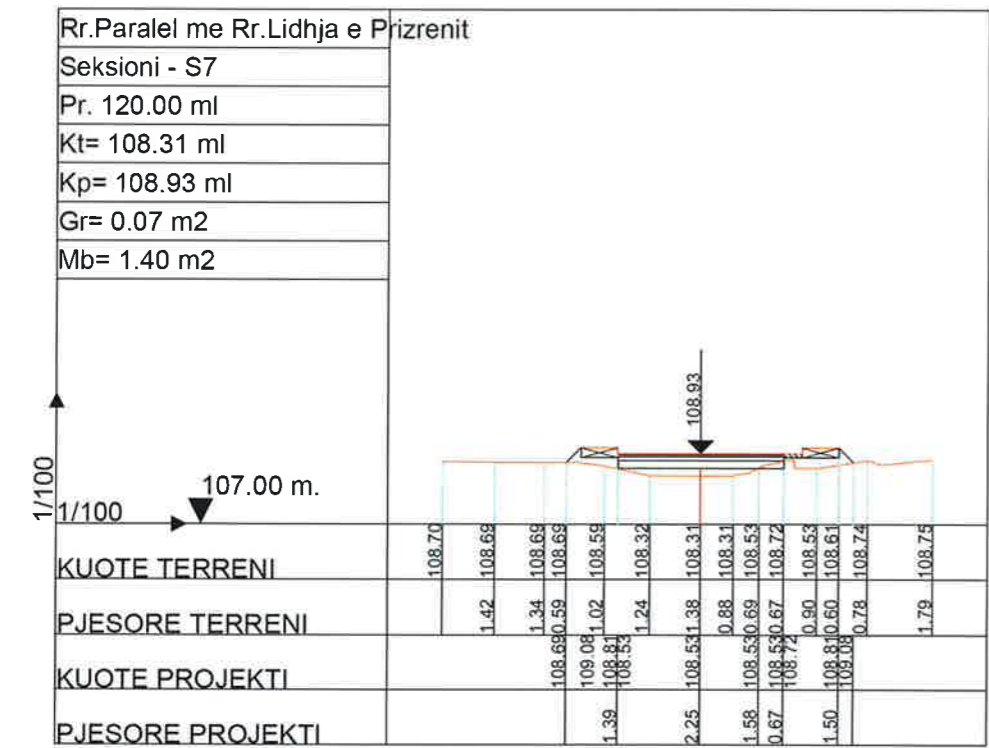
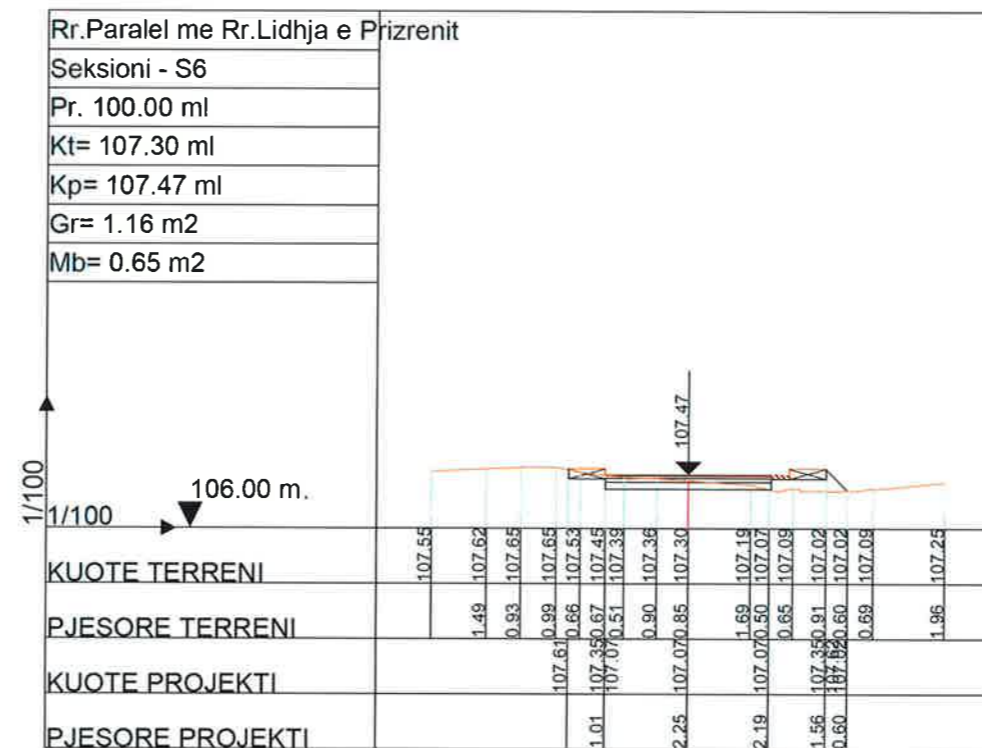
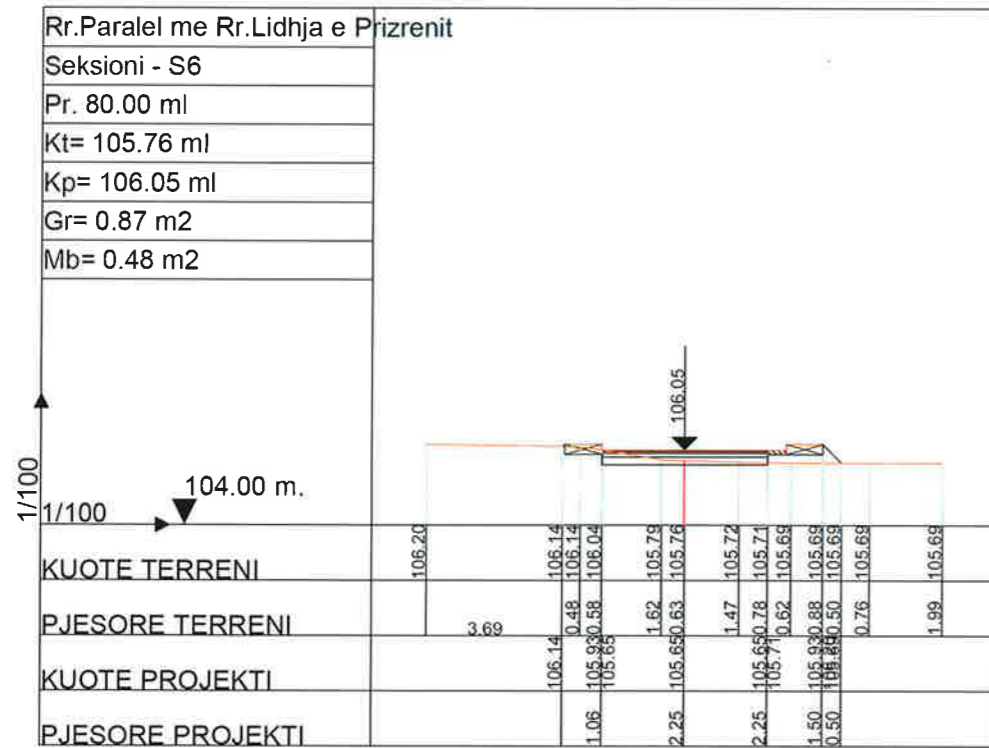

BASHKIA KAMEZ

DREJTORIA E SHERBIMEVE PUBLIKE
DREJTORIA E PROJEKTEVE DHE INVESTIMEVE
DEPARTAMENTI I PROJEKTEVE

Dr. e Projekteve e Investimeve	FLORA MUCA
STAFI TEKNIK PROJEKTES	<ul style="list-style-type: none"> Ing. ARJOLA KURTI Ing. ERBLIN LALA Ing. DENIS PRENCI Ing. RAMADAN HYSA
Titulli i Projektit	Faza e Projektit
NDERTIM RRUGET "PARALEL ME RRUGEN "LIDHJA E PRIZRENIT" DHE PARALEL ME RRUGEN "IBRAHIM RUGOVA"	PROJEKT ZBATIMI
Emertimi i Fletes	Data e Implementimit :
PROFLET TERTHORE	Shkalle e Vizimit 1:200
	Fieta Nr. 02

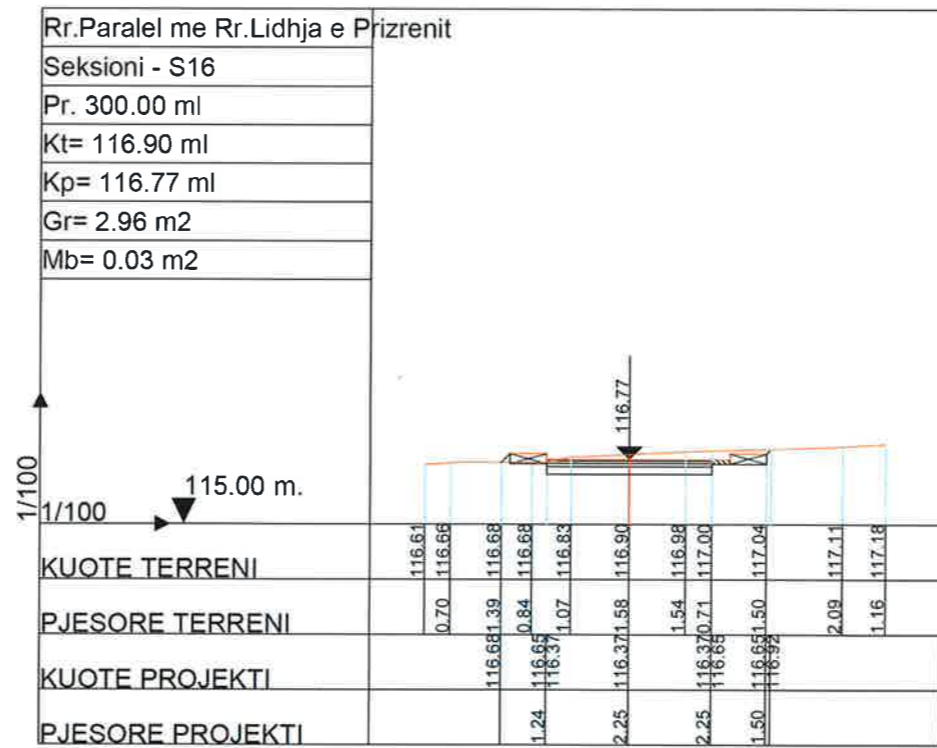
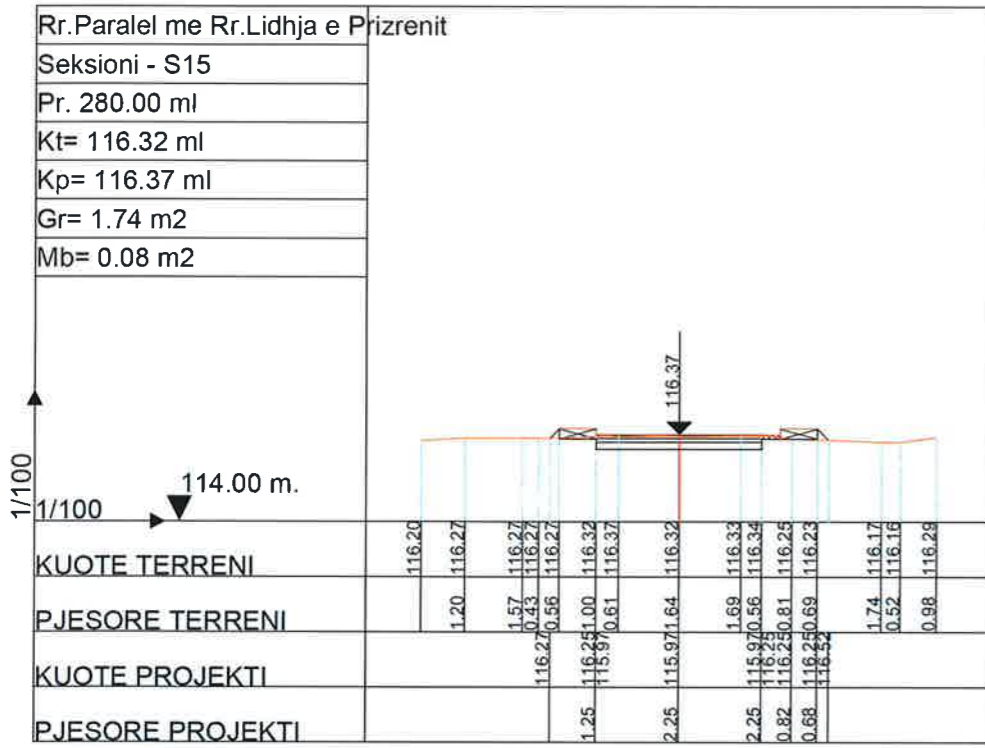
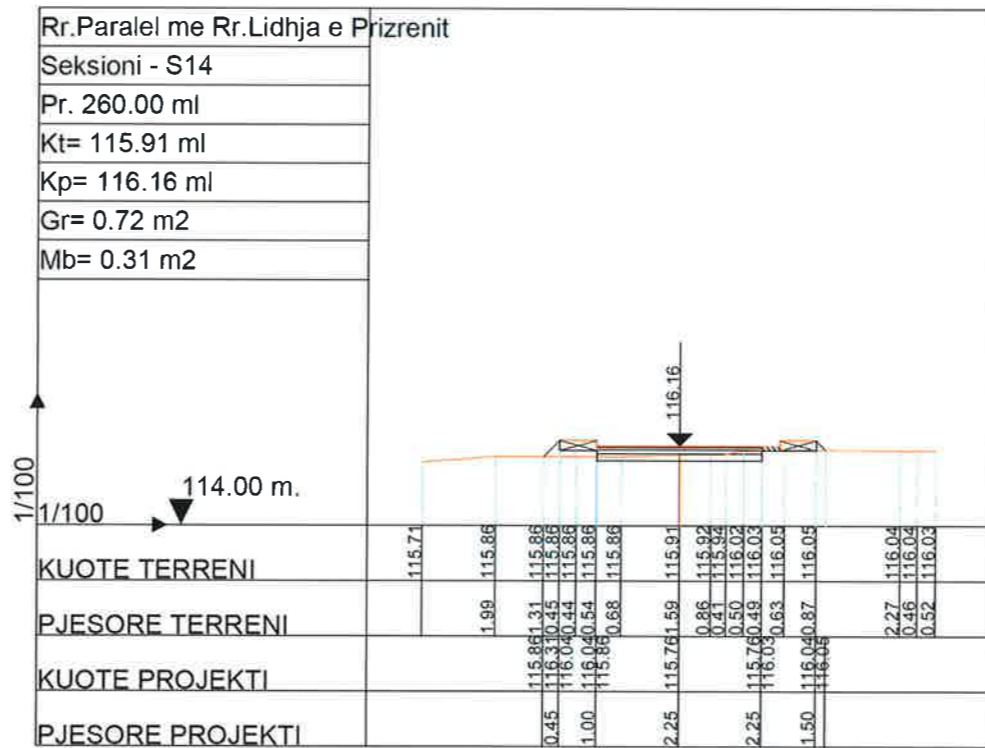
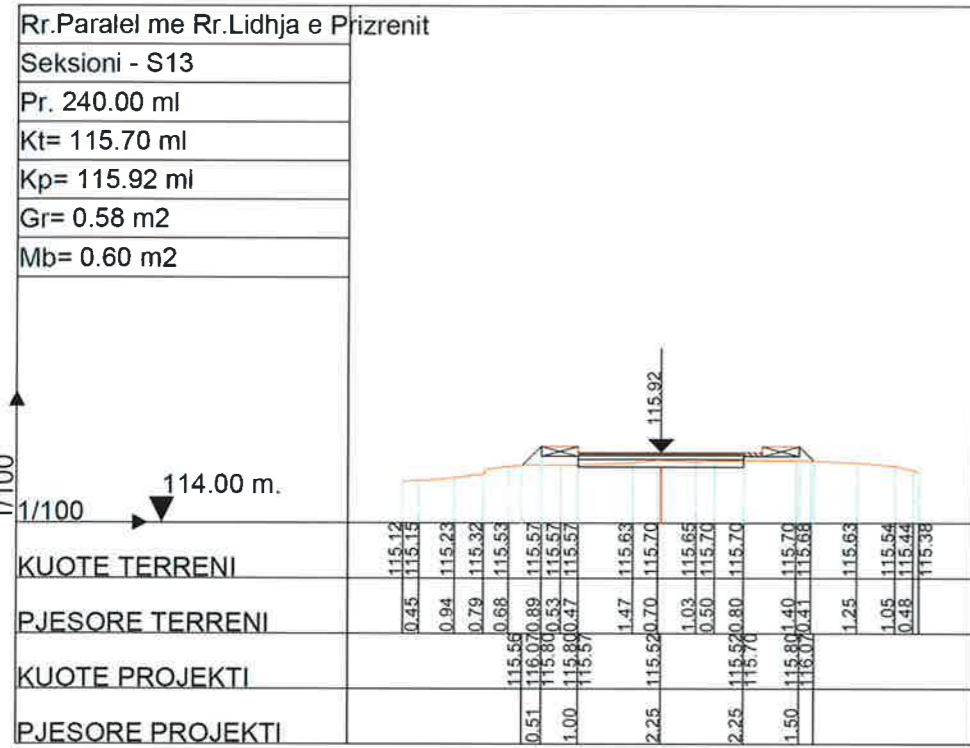



BASHKIA KAMEZ

DREJTORIA E SHERBIMEVE PUBLIKE
DREJTORIA E PROJEKTEVE DHE INVESTIMEVE
DEPARTAMENTI I PROJEKTEVE

Dr. e Projekteve e Investimeve		FLORA MUCA
STAFI TEKNIK PROJEKTES	Ing.	ARJOLA KURTI
	Ing.	ERBLIN LALA
	Ing.	DENIS PRENCI
	Ing.	RAMADAN HYSA
Titulli i Projektit		Faza e Projektit
NDERTIM RRUGET "PARALEL ME RRUGEN "LIDHJA E PRIZRENIT" DHE PARALEL ME RRUGEN "IBRAHIM RUGOVA"		PROJEKT ZBATIMI
Emertimi i Fletes		Data e Implementimit:
PROFILET TERTHORE		Shkalle e Vizatimit
		1:200
		Fleta Nr.
		04

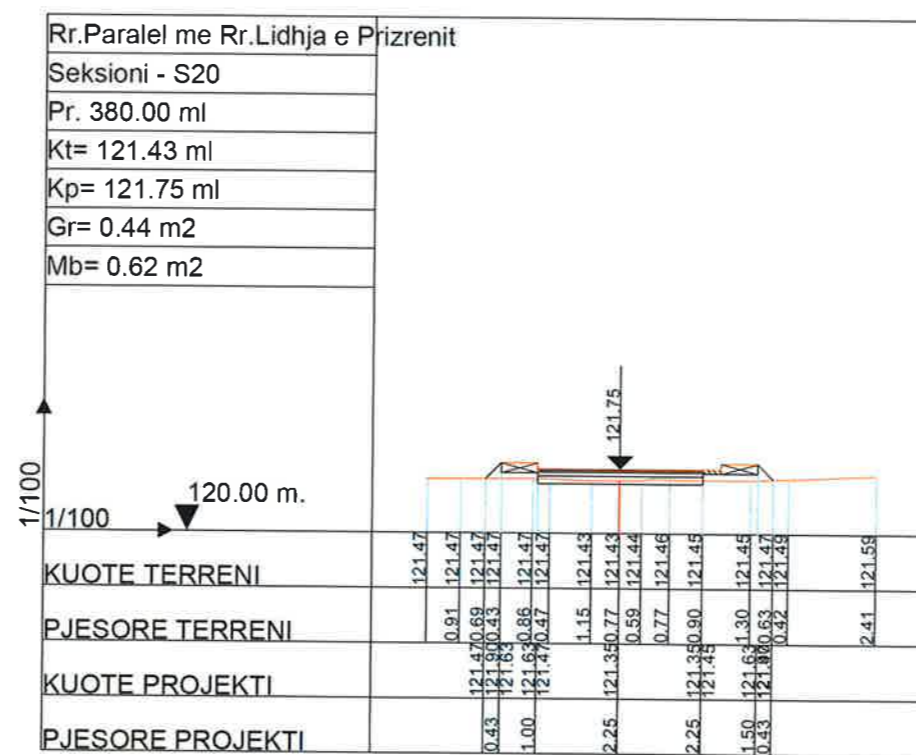
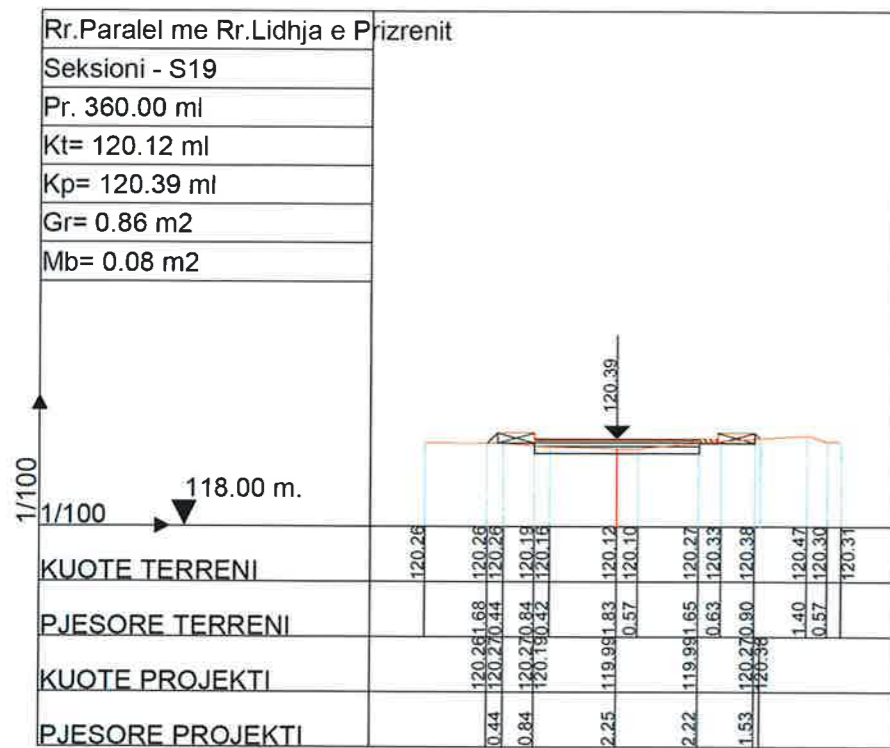
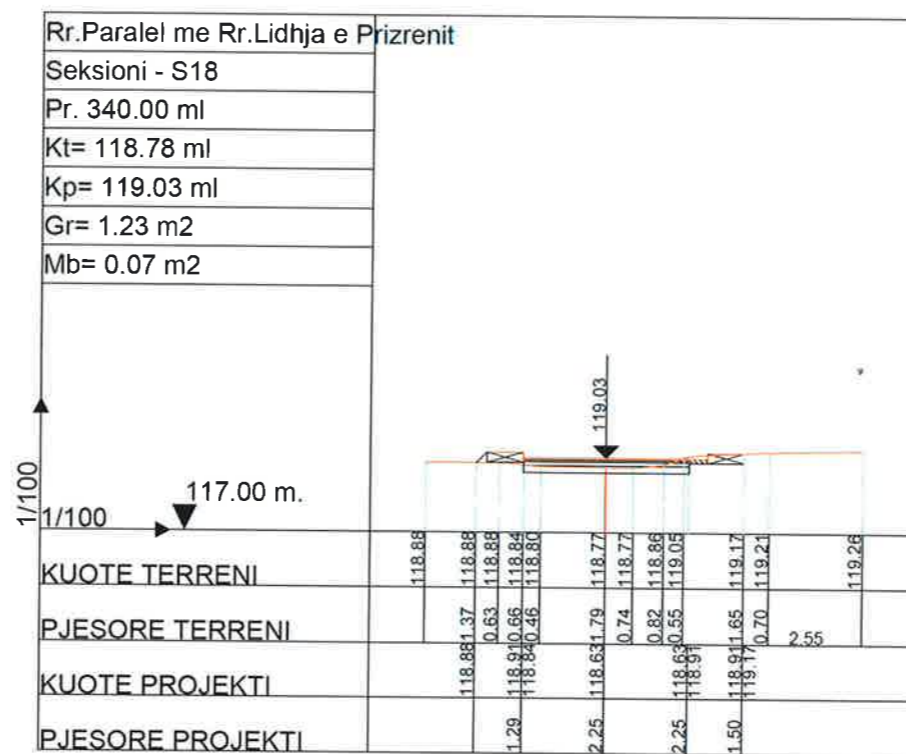
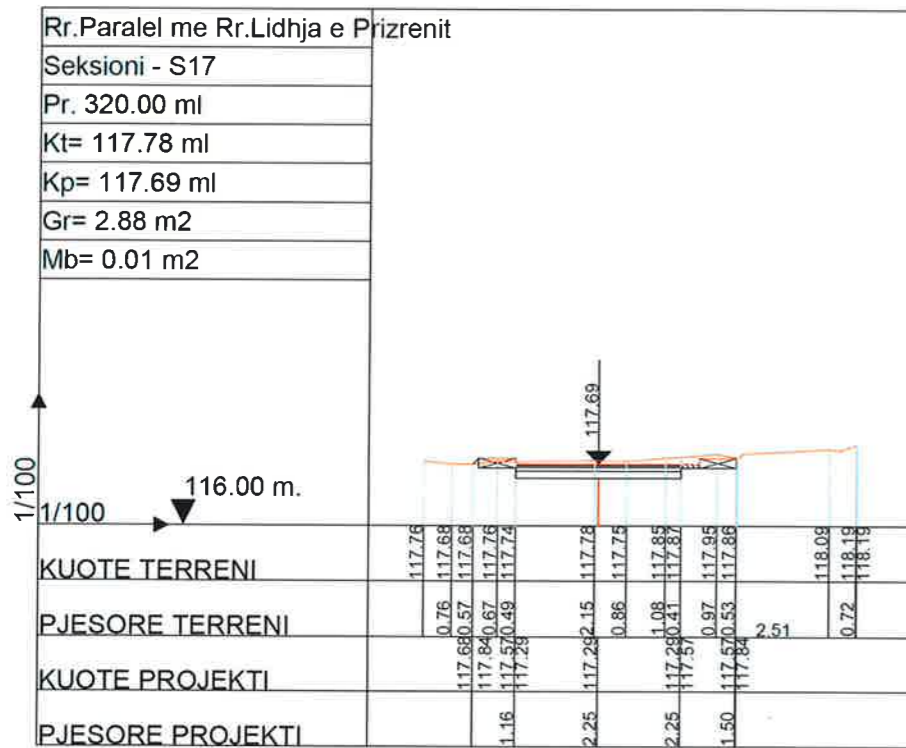

BASHKIA KAMEZ

DREJTORIA E SHERBIMEVE PUBLIKE
DREJTORIA E PROJEKTEVE DHE INVESTIMEVE
DEPARTAMENTI I PROJEKTEVE

Dr. e Projekteve e Investimeve		FLORA MUCA	<i>[Signature]</i>
STAFI TEKNIK PROJEKTES	Ing.	ARJOLA KURTI	<i>[Signature]</i>
	Ing.	ERBLIN LALA	
	Ing.	DENIS PRENCI	
	Ing.	RAMADAN HYSA	
Titulli i Projektit		Faza e Projektit	
NDERTIM RRUGET "PARALEL ME RRUGEN "LIDHJA E PRIZRENIT" DHE PARALEL ME RRUGEN "IBRAHIM RUGOVA"		PROJEKT ZBATIMI	
Emertimi i Fletes		Shkalle e Vizatimit	
PROFILET TERTHORE		1:200	
Fleta Nr.		05	

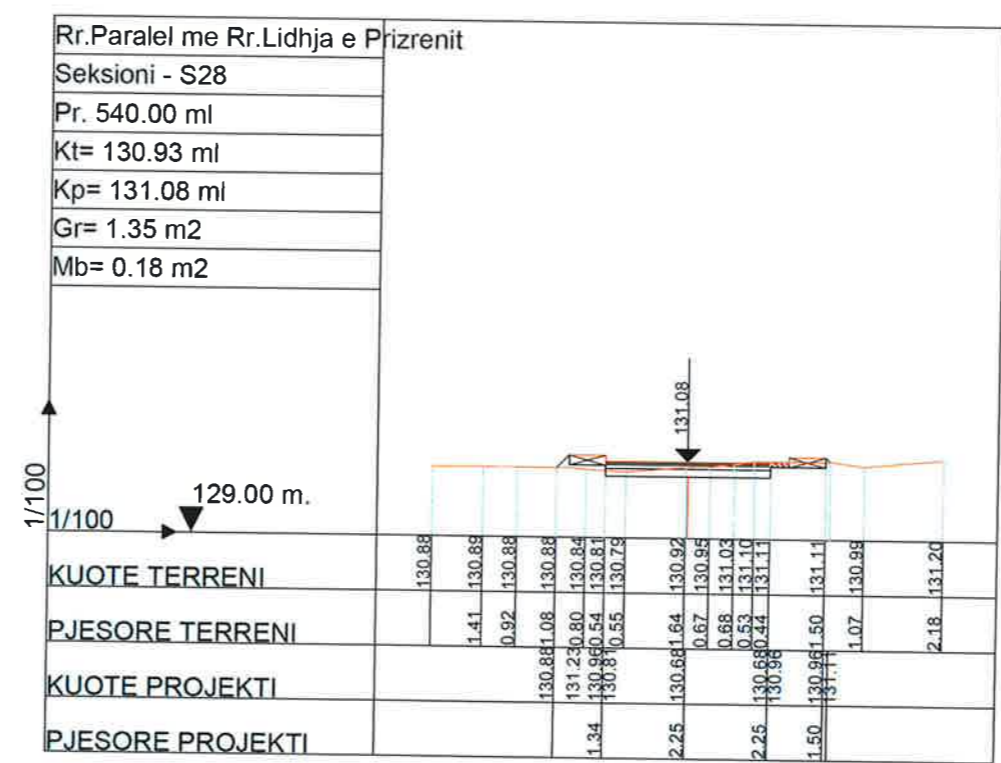
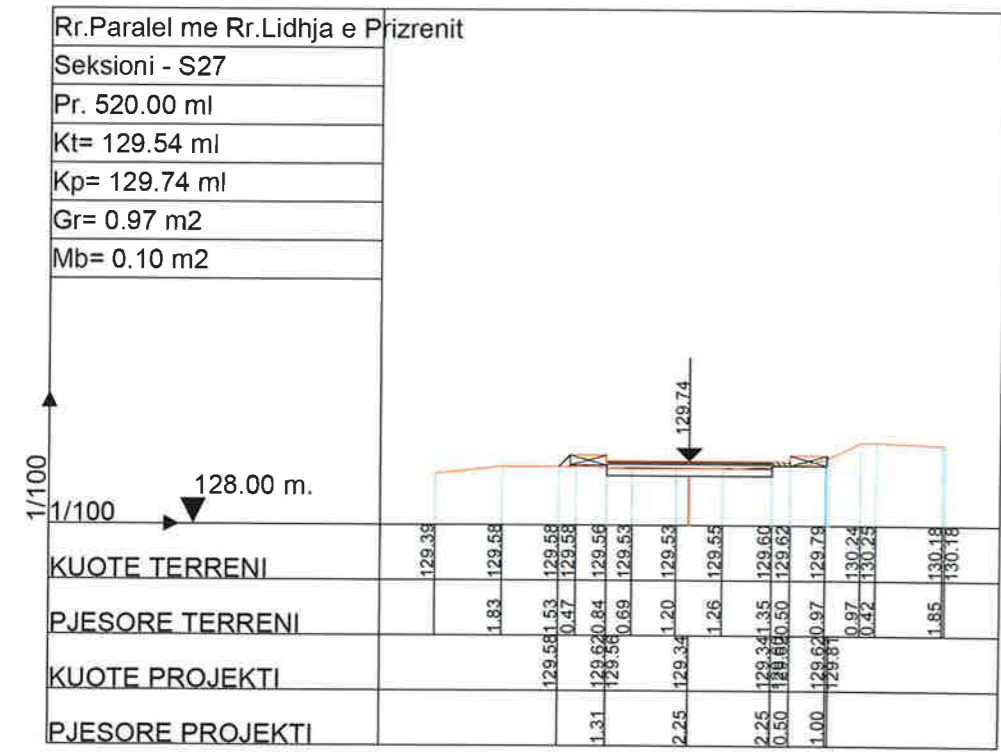
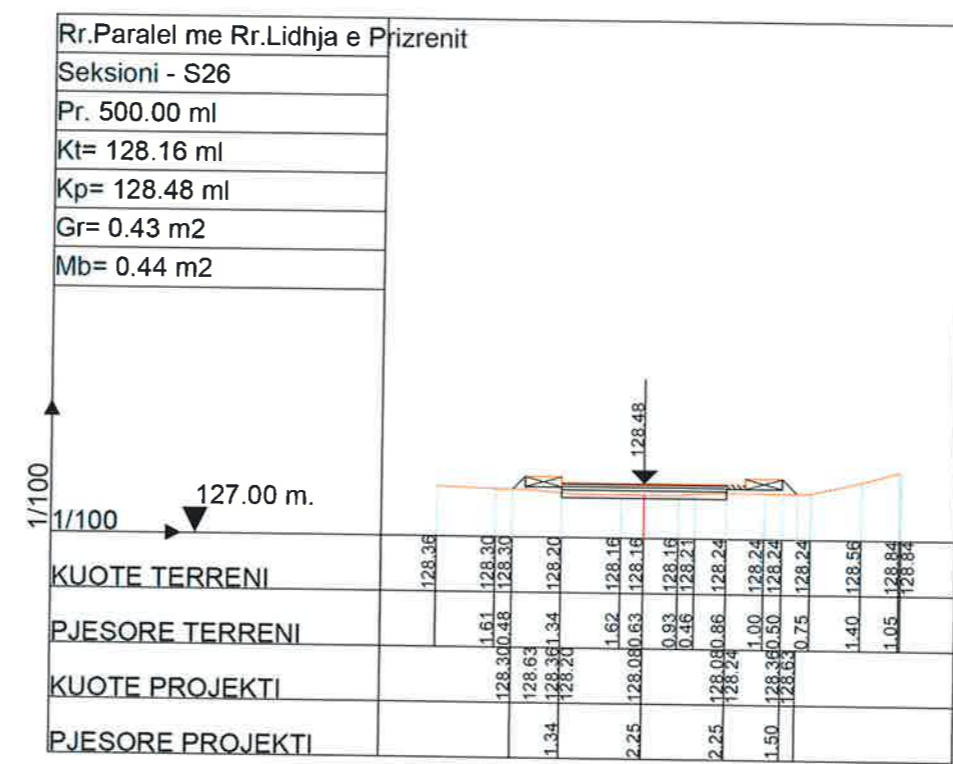
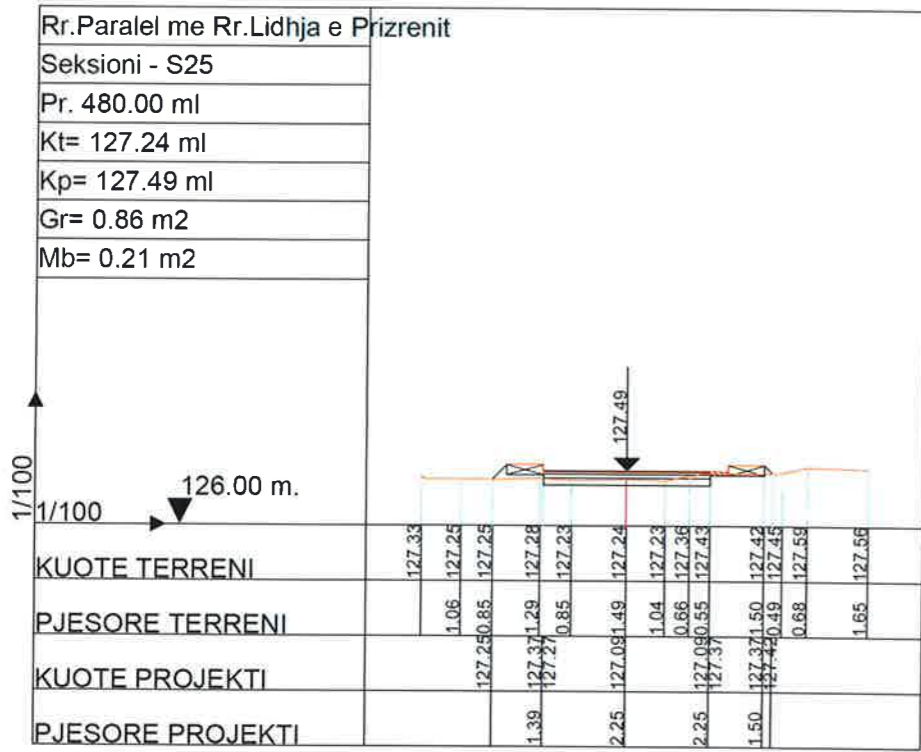



BASHKIA KAMEZ

DREJTORIA E SHERBIMEVE PUBLIKE
DREJTORIA E PROJEKTEVE DHE INVESTIMEVE
DEPARTAMENTI I PROJEKTEVE

Dr. e Projekteve e Investimeve	FLORA MUCA
--------------------------------	------------

STAFI TEKNIK PROJEKTES	Ing.	ARJOLA KURTI
	Ing.	ERBLIN LALA
	Ing.	DENIS PRENCI
	Ing.	RAMADAN HYSA

Titulli i Projektit	Faza e Projektit
NDERTIM RRUGET "PARALEL ME RRUGEN "LIDHJA E PRIZRENIT" DHE PARALEL ME RRUGEN "IBRAHIM RUGOVA"	PROJEKT ZBATIMI
Emertimi i Fietes	Shkalla e Vizimit
PROFILET TERTHORE	1:200
	Fleta Nr.
	07

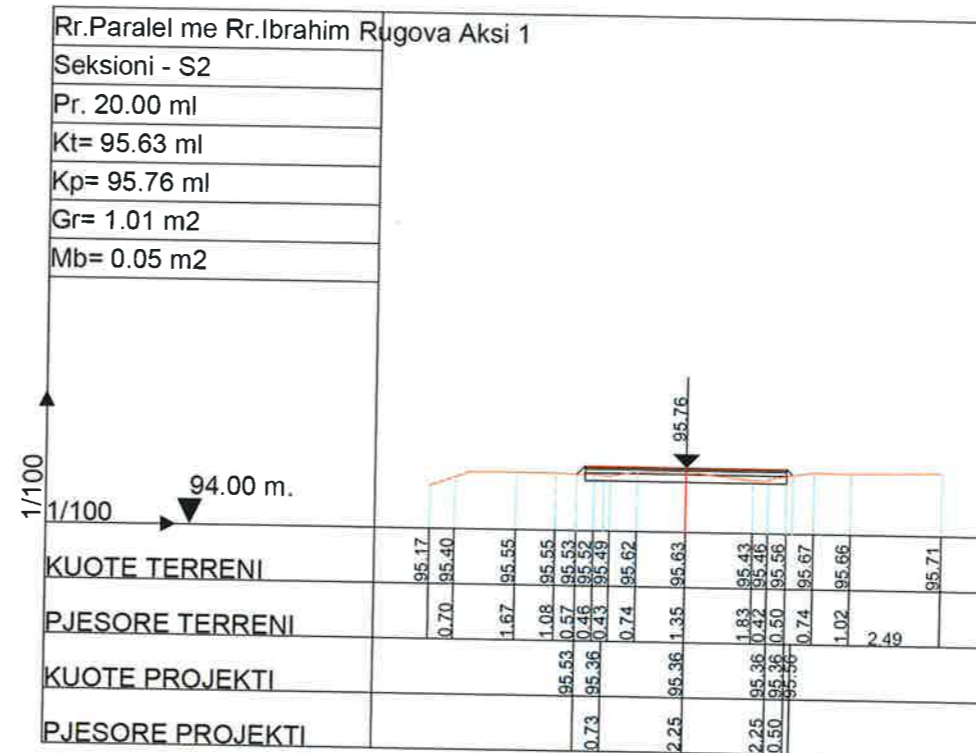
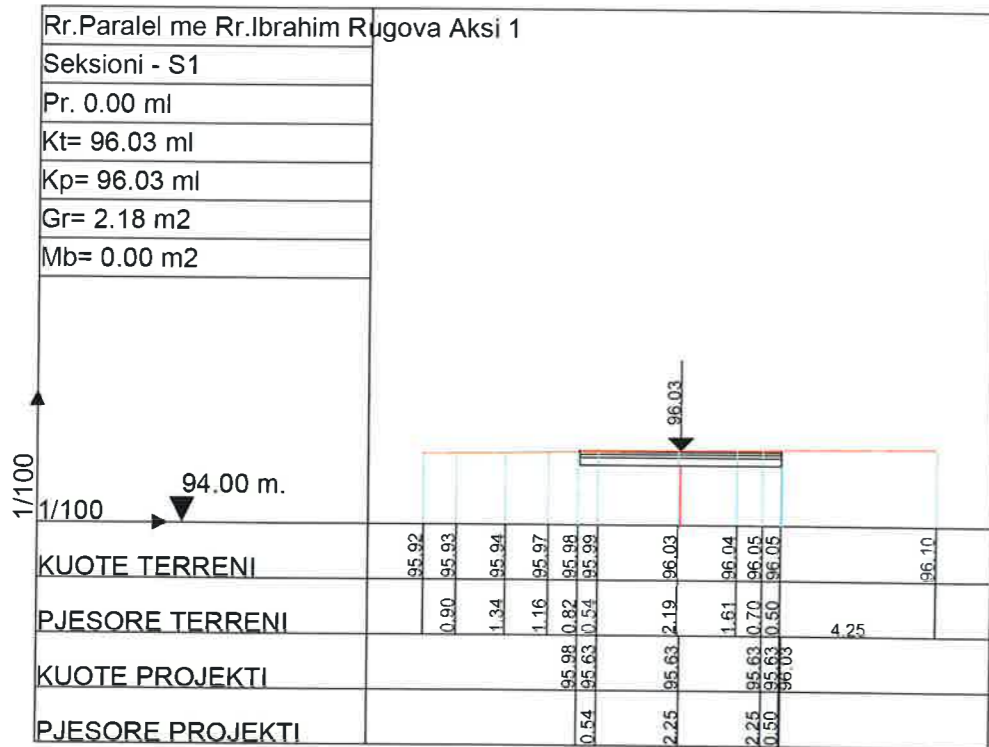
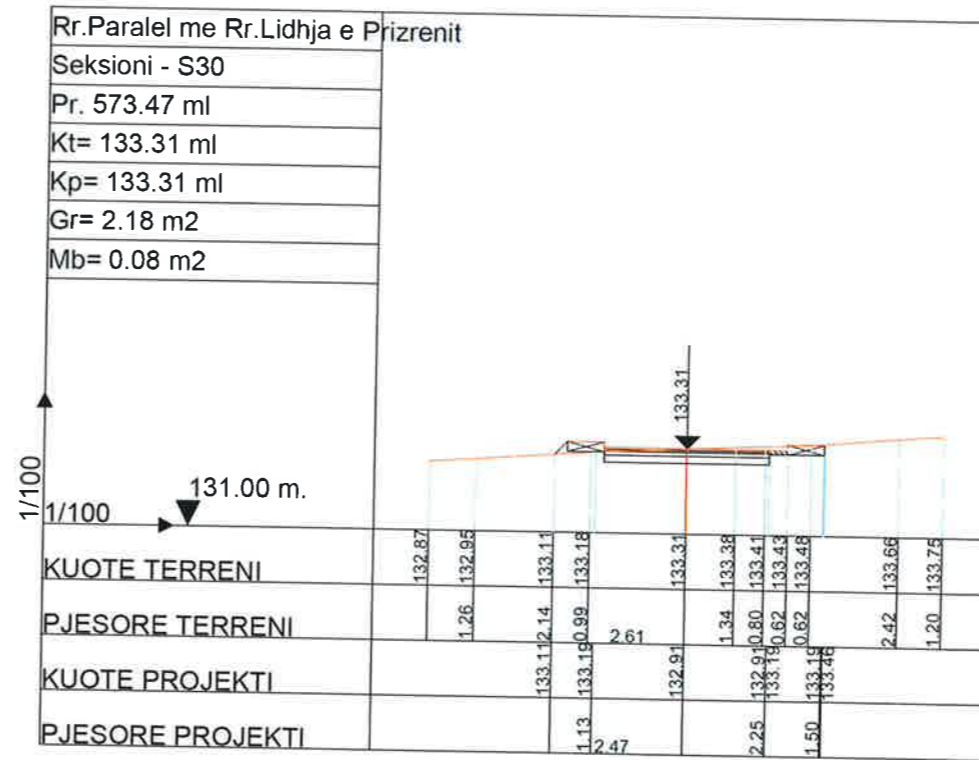
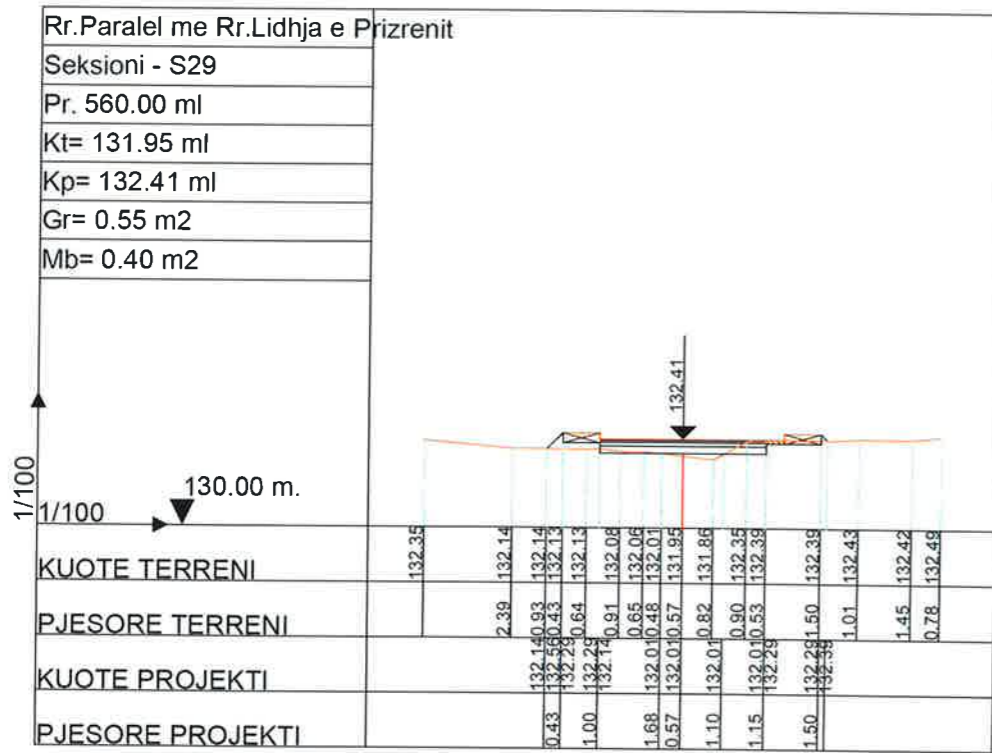

BASHKIA KAMEZ

DREJTORIA E SHERBIMEVE PUBLIKE
DREJTORIA E PROJEKTEVE DHE INVESTIMEVE
DEPARTAMENTI I PROJEKTEVE

Dr. e Projekteve e Investimeve		FLORA MUCA
STAFI TEKNIK PROJEKTUES	Ing. ARJOLA KURTI Ing. ERBLIN LALA Ing. DENIS PRENCI Ing. RAMADAN HYSA	<i>(Signatures)</i>
Titulli i Projektit	NDERTIM RRUGET "PARALEL ME RRUGEN "LIDHJA E PRIZRENIT" DHE PARALEL ME RRUGEN "IBRAHIM RUGOVA"	
Emertimi i Fietes	PROFILET TERTHORE	
Faza e Projektit	PROJEKT ZBATIMI	
Data e Implementimit		
Shkalla e Vizatimit	1:200	
Fleta Nr.	08	

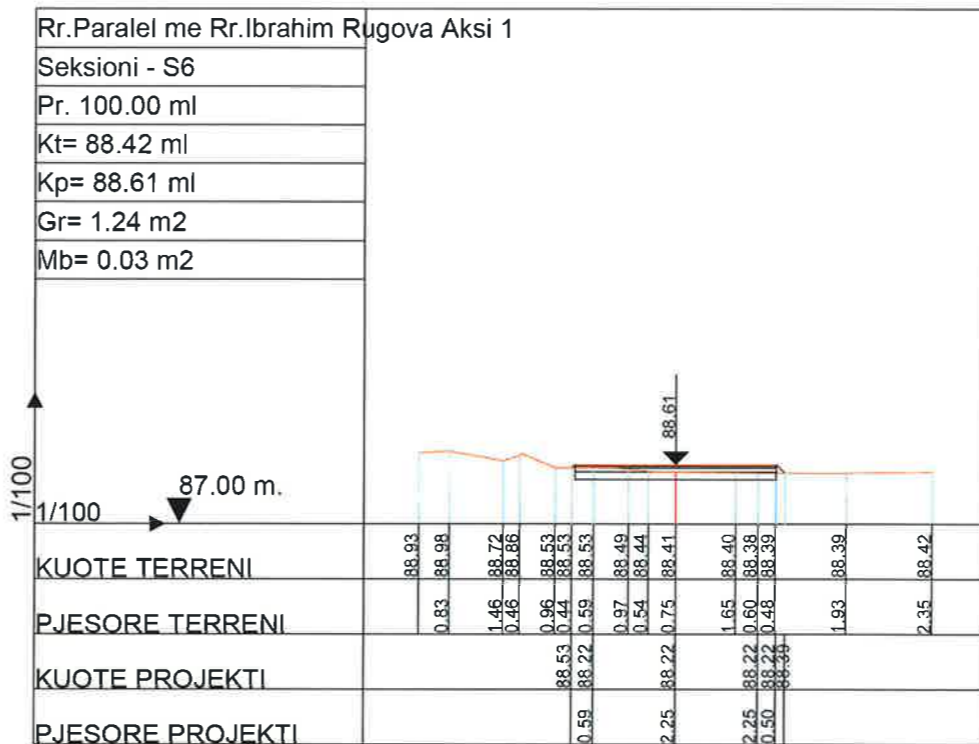
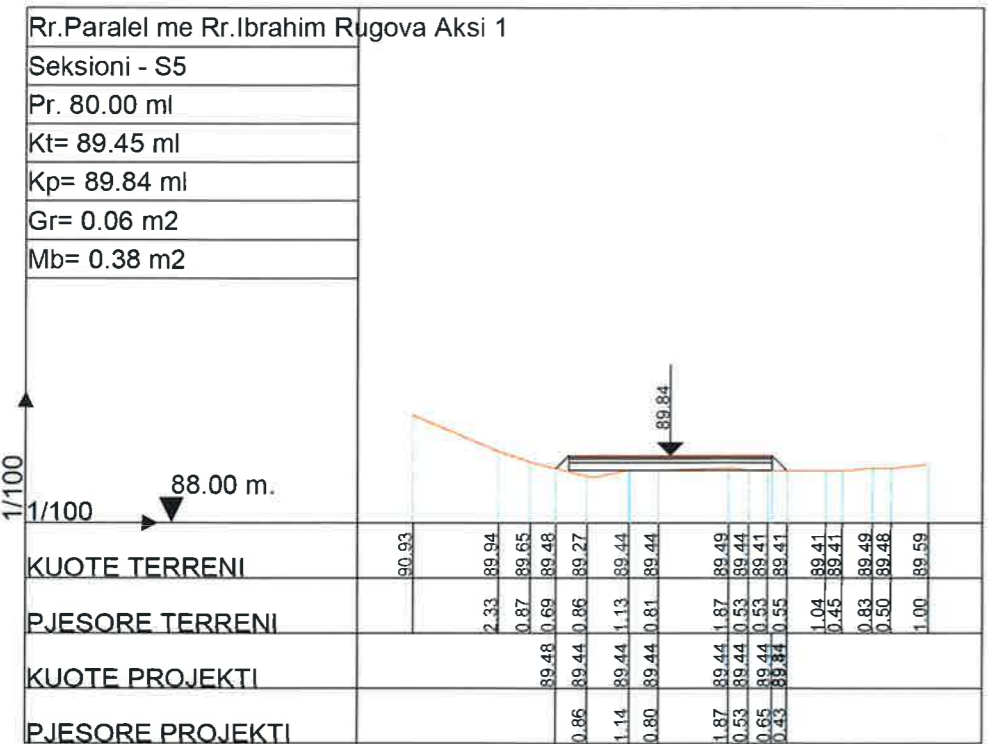
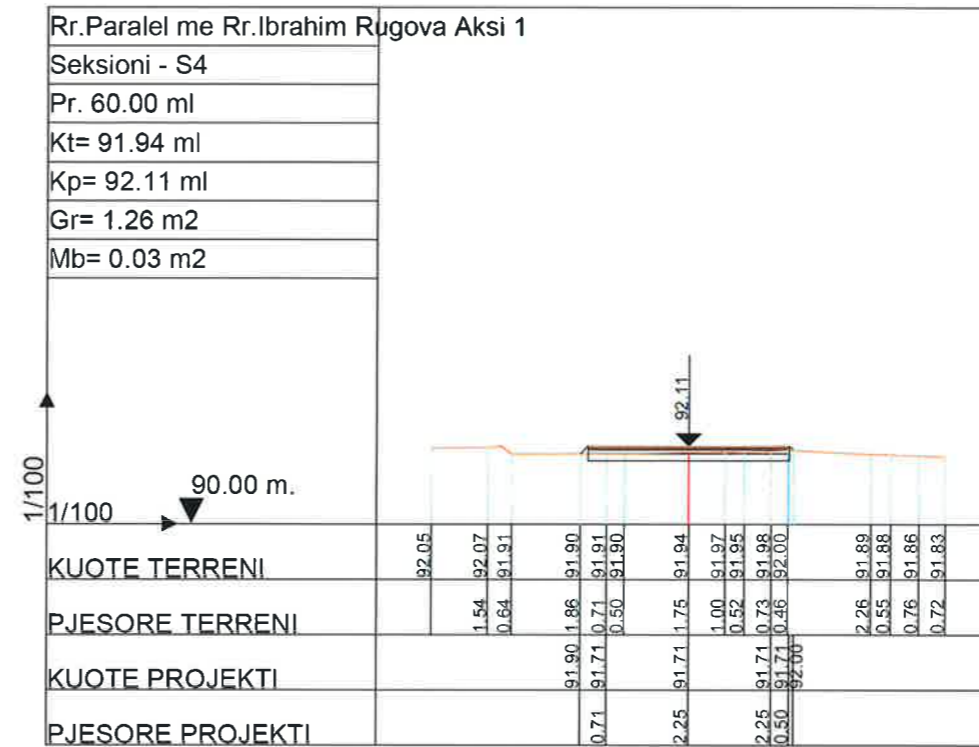
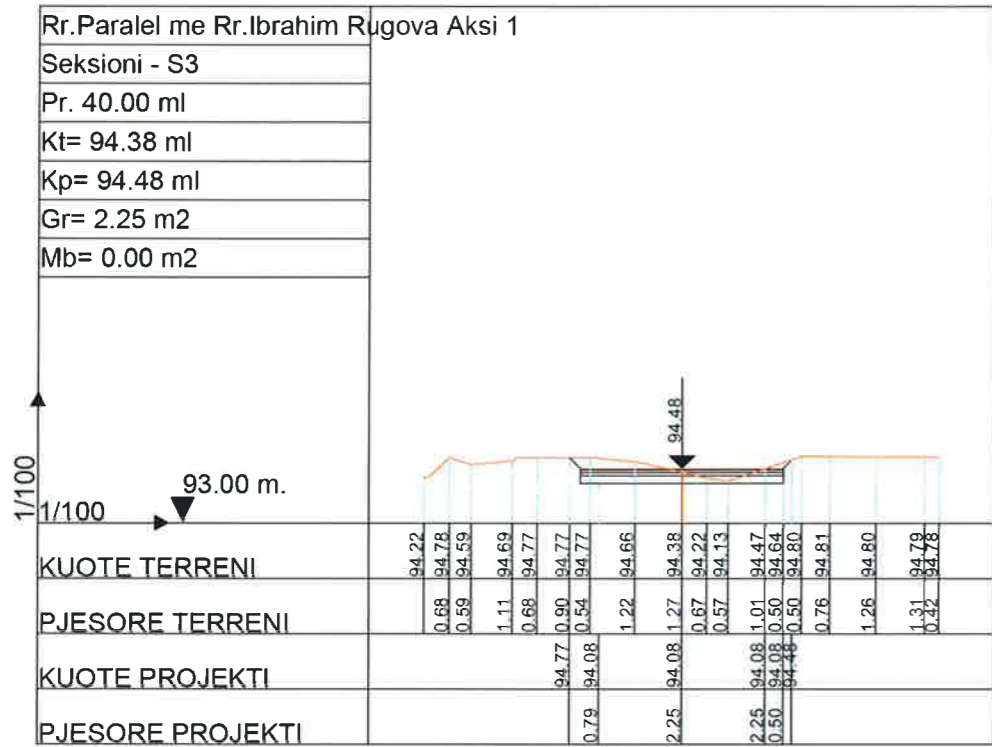



BASHKIA KAMEZ

DREJTORIA E SHERBIMEVE PUBLIKE
DREJTORIA E PROJEKTEVE DHE INVESTIMEVE
DEPARTAMENTI I PROJEKTEVE

Dr. e Projekteve e Investimeve		FLORA MUCA
STAFI TEKNIK PROJEKTES	Ing.	ARJOLA KURTI
	Ing.	ERBLIN LALA
	Ing.	DENIS PRENCI
	Ing.	RAMADAN HYSA
Titulli i Projektit		Faza e Projektit
NDERTIM RRUGET "PARALEL ME RRUGEN "LIDHJA E PRIZRENIT" DHE PARALEL ME RRUGEN "IBRAHIM RUGOVA"		PROJEKT ZBATIMI
Emertimi i Fletes		Data e Implementimit:
PROFILET TERTHORE		Shkalla e Vizatimit: 1:200
		Fleta Nr. 09

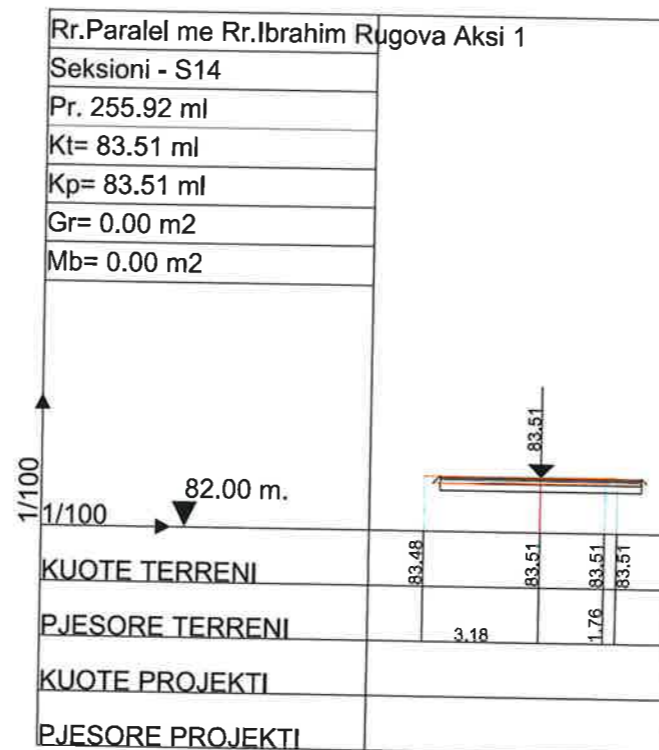
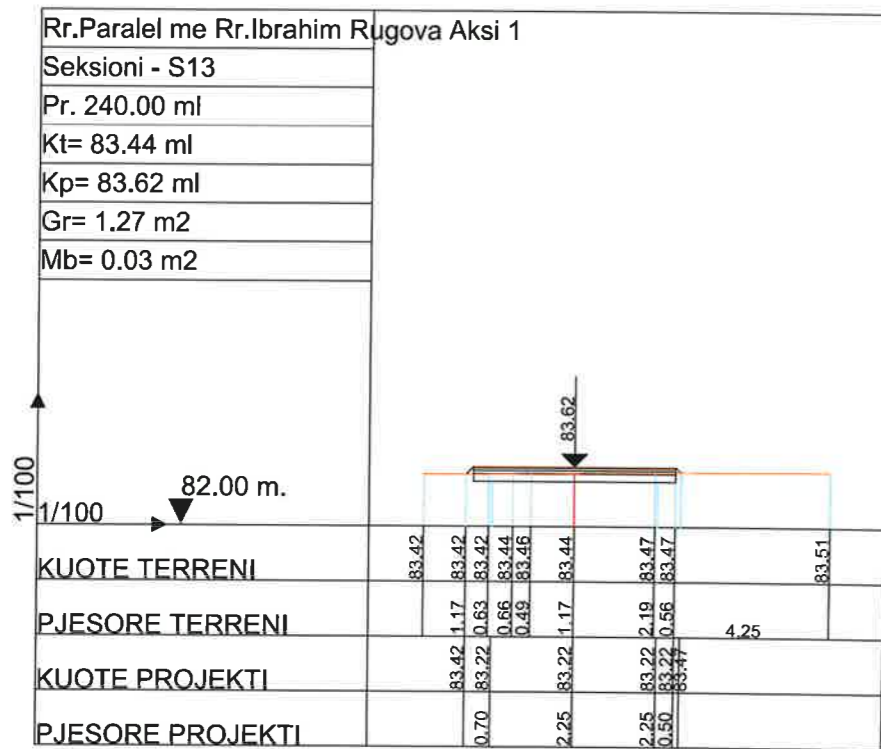
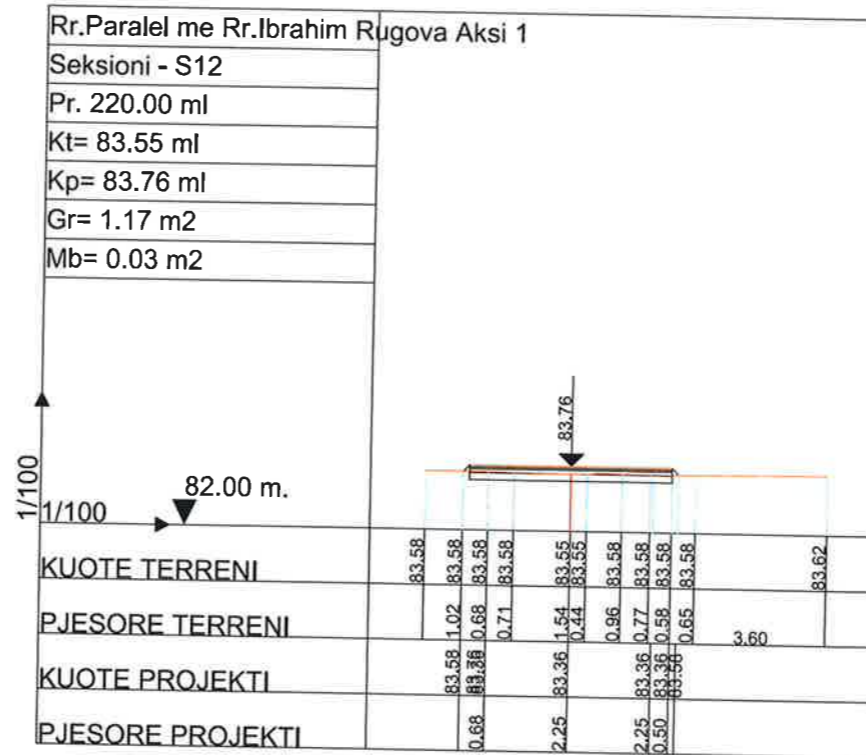
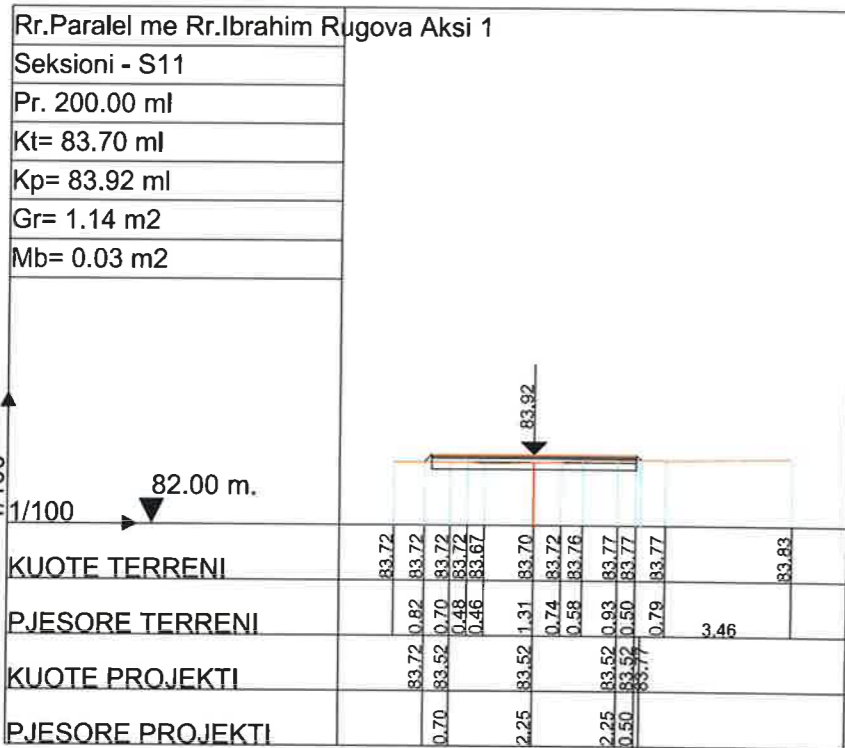

		BASHKIA KAMEZ	
DREJTORIA E SHERBIMEVE PUBLIKE DREJTORIA E PROJEKTEVE DHE INVESTIMEVE DEPARTAMENTI I PROJEKTEVE			
Dr. e Projekteve e Investimeve		FLORA MUCA	
STAFI TEKNIK PROJEKTUES	Ing.	ARJOLA KURTI	
	Ing.	ERBLIN LALA	
	Ing.	DENIS PRENCI	
	Ing.	RAMADAN HYSA	
Titulli i Projektit		Faza e Projektit	
NDERTIM RRUGET "PARALEL ME RRUGEN "LIDHJA E PRIZRENIT" DHE PARALEL ME RRUGEN "IBRAHIM RUGOVA"		PROJEKT ZBATIMI	
Emertimi i Fletes		Data e Implementimit:	
PROFILET TERTHORE		Shkalla e Vizatimit:	
		1:200	
		Fleta Nr.	
		11	

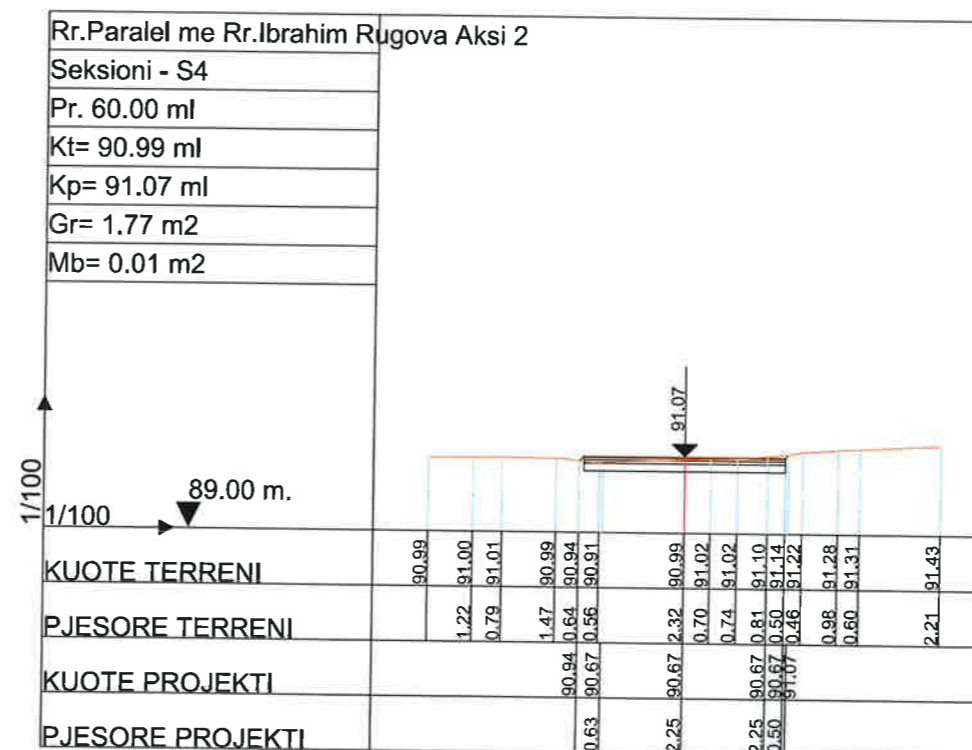
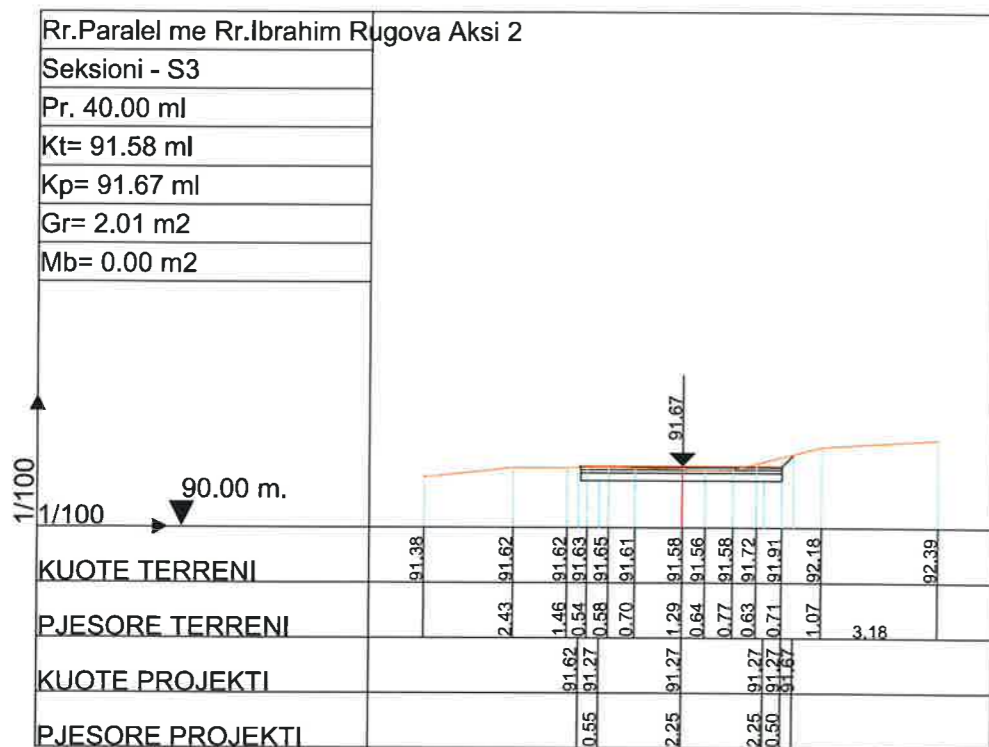
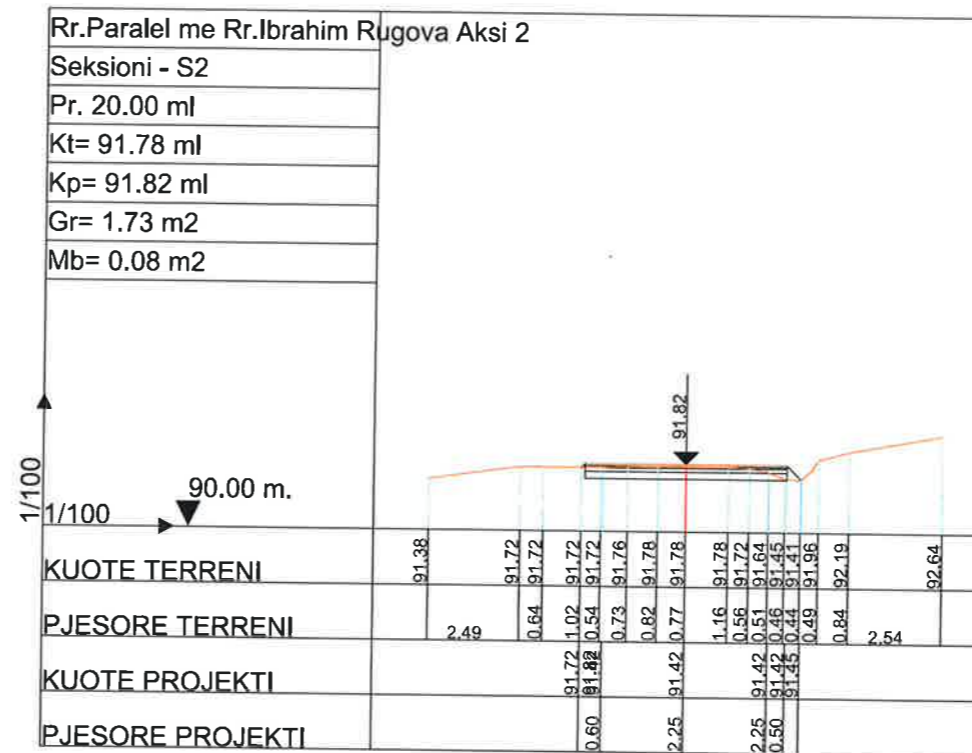
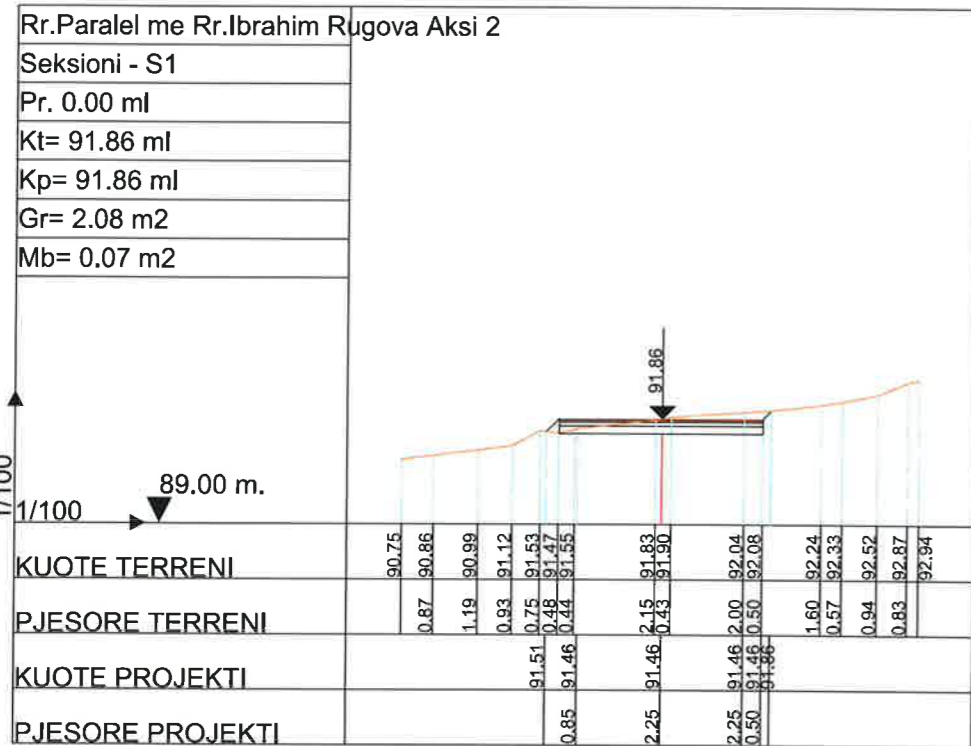

BASHKIA KAMEZ

DREJTORIA E SHERBIMEVE PUBLIKE
DREJTORIA E PROJEKTEVE DHE INVESTIMEVE
DEPARTAMENTI I PROJEKTEVE

Dr. e Projekteve e Investimeve	FLORA MUCA
--------------------------------	------------

STAFI TEKNIK	Ing. ARJOLA KURTI
PROJEKTES	Ing. ERBLIN LALA
	Ing. DENIS PRENCI
	Ing. RAMADAN HYSA

Titulli i Projektit
NDERTIM RRUGET
"PARALEL ME RRUGEN "LIDHJA E PRIZRENIT"
DHE PARALEL ME RRUGEN "IBRAHIM RUGOVA"

Emertimi i Pletes
PROFILET TERTHORE

Faza e Projektit
PROJEKT ZBATIMI

Data e Implementimit

Shkalla e Vizimit
1:200

Fleta Nr.
12

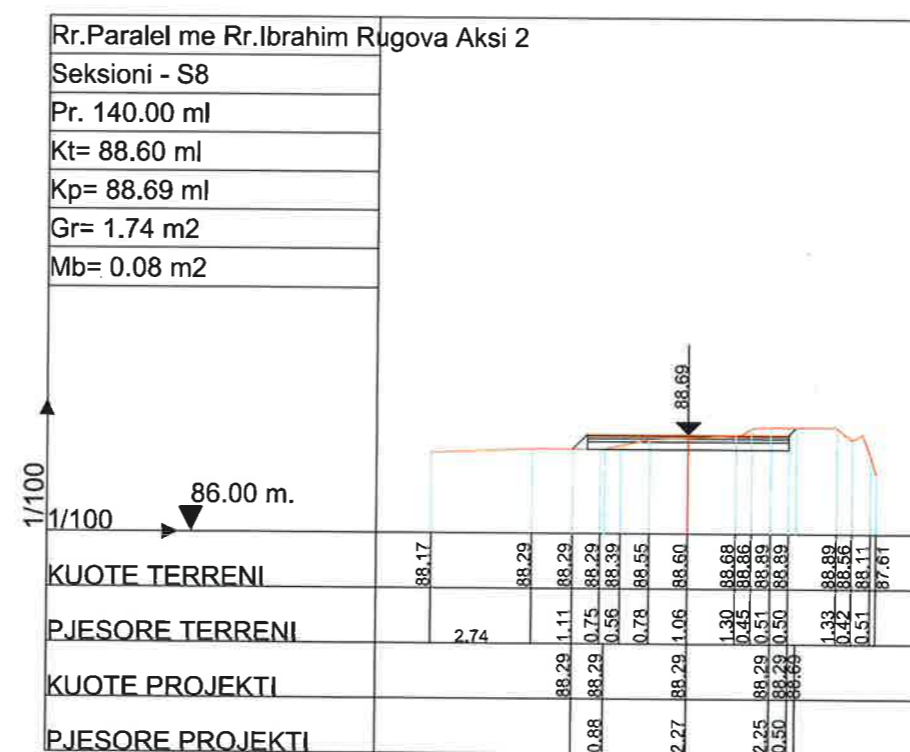
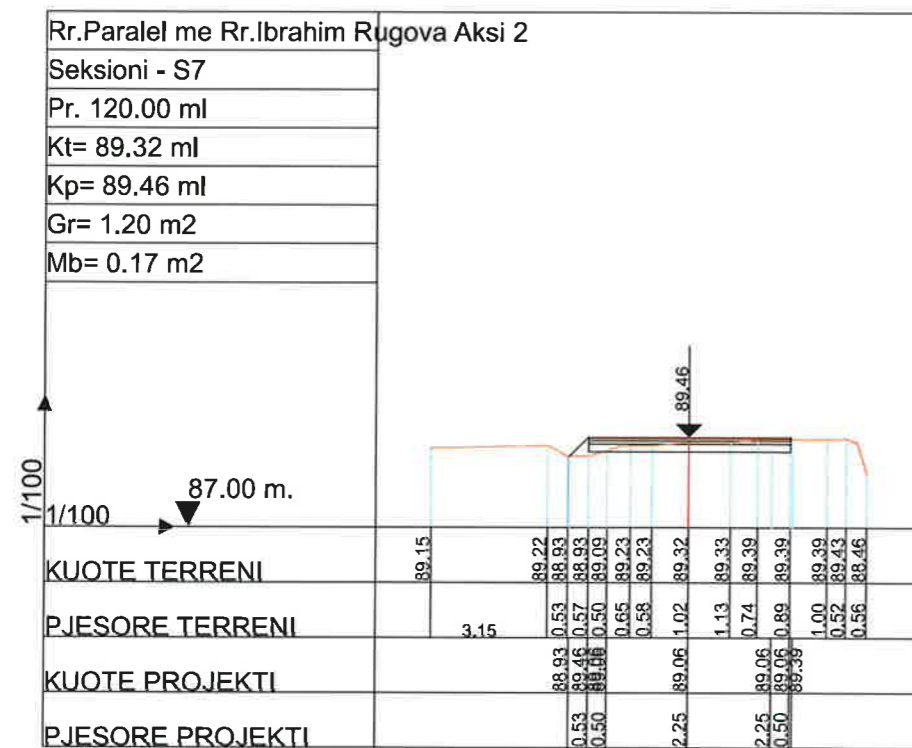
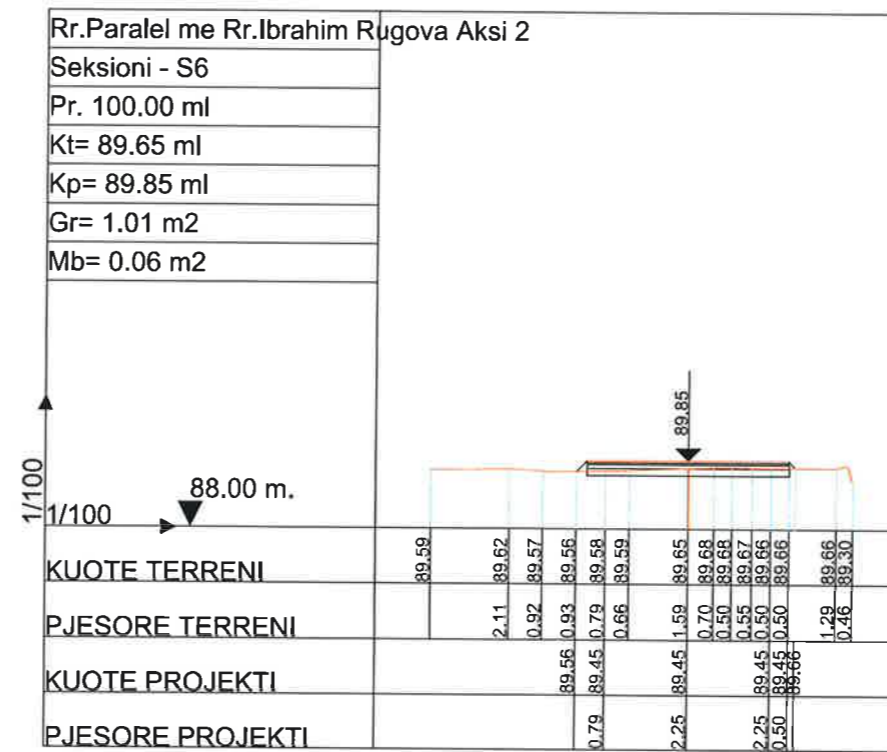
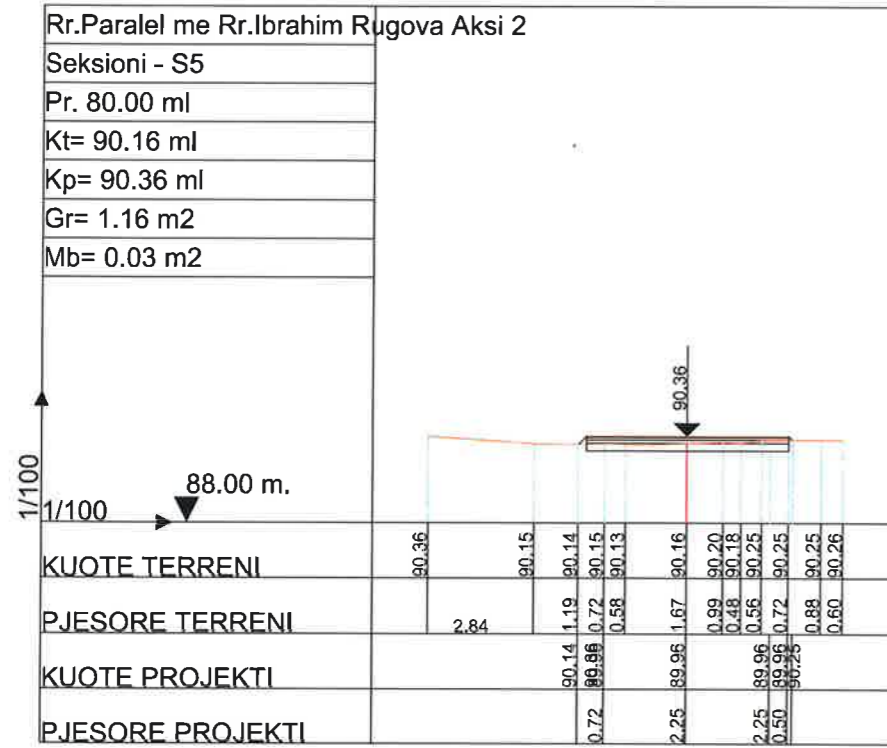

		BASHKIA KAMEZ	
DREJTORIA E SHERBIMEVE PUBLIKE		DREJTORIA E PROJEKTEVE DHE INVESTIMEVE	
DEPARTAMENTI I PROJEKTEVE			
Dr. e Projekteve e Investimeve		FLORA MUCA	
STAFI TEKNIK PROJEKTES	Ing.	ARJOLA KURTI	
	Ing.	ERBLIN LALA	
	Ing.	DENIS PRENCI	
	Ing.	RAMADAN HYSA	
Titulli i Projektit		Faza e Projektit	
NDERTIM RRUGET "PARALEL ME RRUGEN "LIDHJA E PRIZRENIT" DHE PARALEL ME RRUGEN "IBRAHIM RUGOVA"		PROJEKT ZBATIMI	
Emerimi i Fietes		Data e Implementimit :	
PROFLET TERTHORE		Shkalla e Vizimit	
		1:200	
		Flete Nr.	
		13	

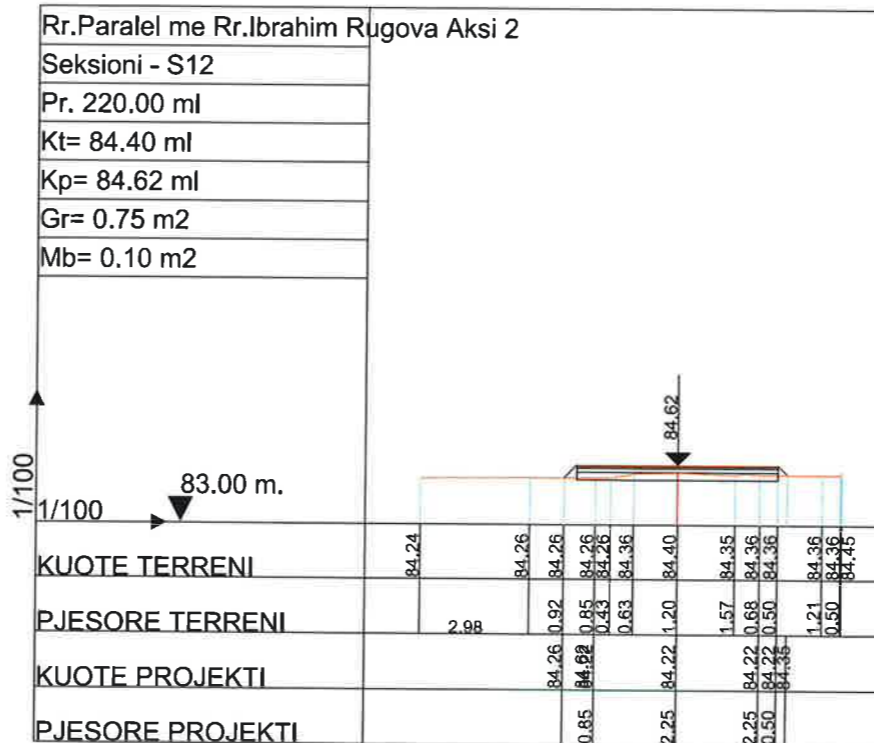
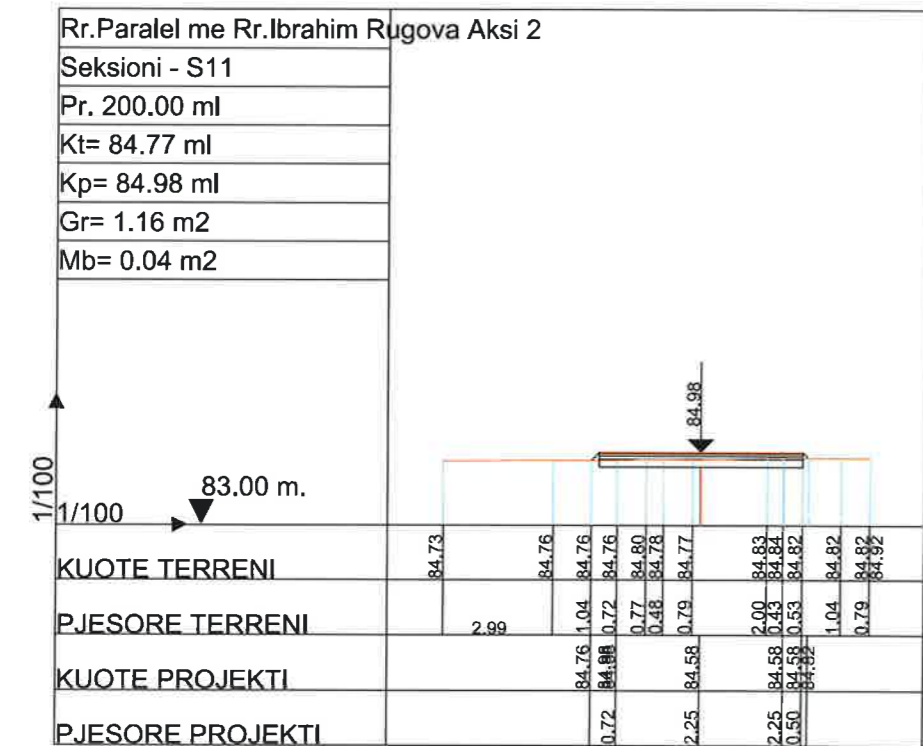
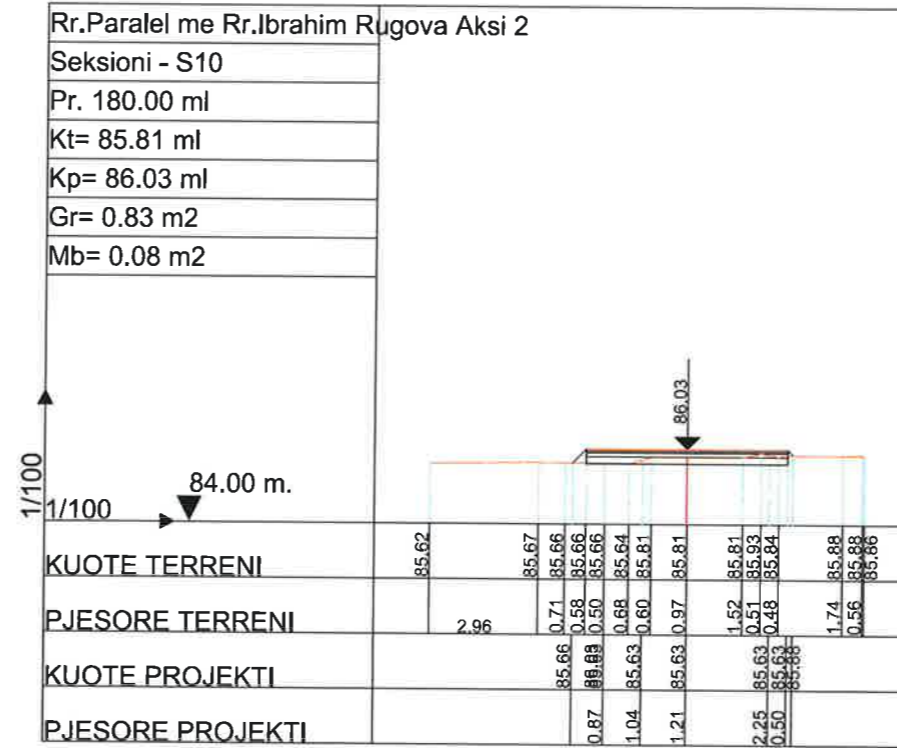
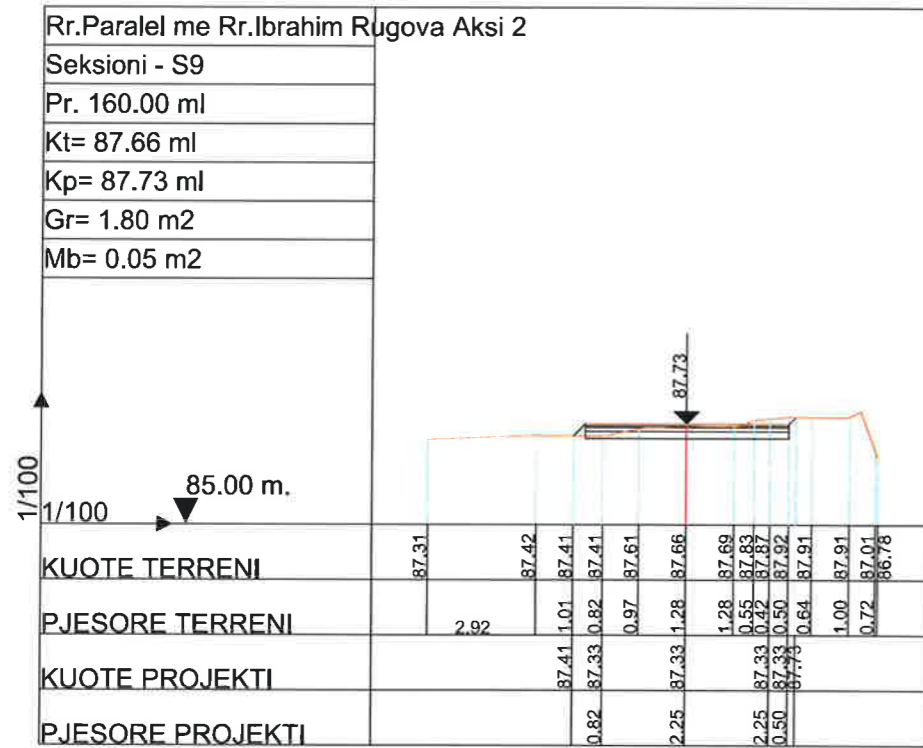

		BASHKIA KAMEZ	
DREJTORIA E SHERBIMEVE PUBLIKE		DREJTORIA E PROJEKTEVE DHE INVESTIMEVE	
DEPARTAMENTI I PROJEKTEVE			
Dr. e Projekteve e Investimeve		FLORA MUCA	
STAFI TEKNIK	Ing. ARJOLA KURTII		
PROJEKTUES	Ing. ERBLIN LALA		
	Ing. DENIS PRENCI		
	Ing. RAMADAN HYSA		
Titulli i Projektit		Faza e Projektit	
NDERTIM RRUGET		PROJEKT ZBATIMI	
"PARALEL ME RRUGEN "LIDHJA E PRIZRENIT"		Data e Implementimit:	
DHE PARALEL ME RRUGEN "IBRAHIM RUGOVA"		Shkalla e Vizatimit:	
Emertimi i Fletes		1:200	
PROFILET TERTHORE		Fleta Nr.	
		14	

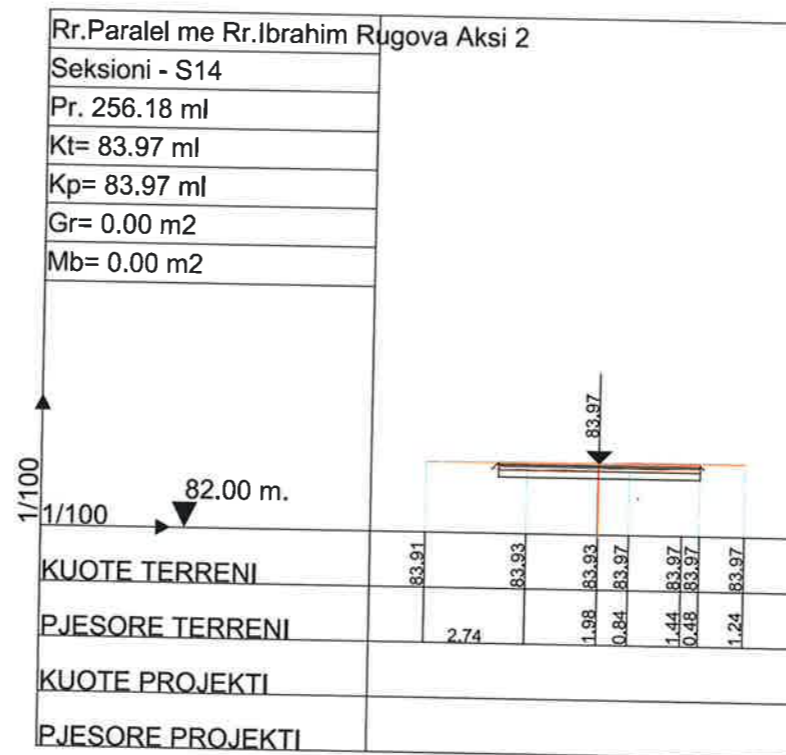
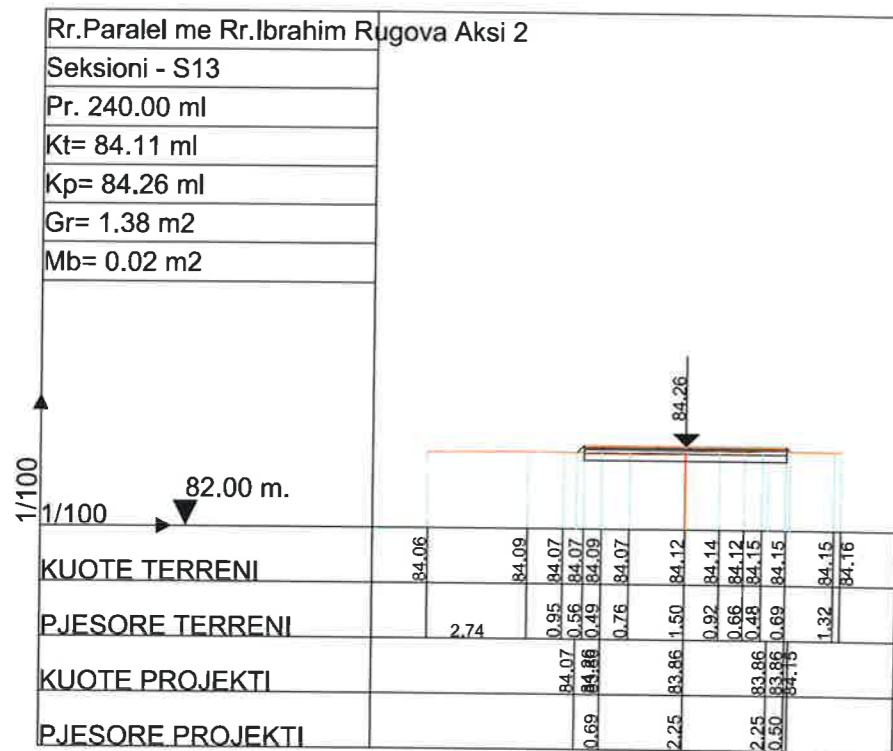

 BASHKIA KAMEZ DREJTORIA E SHERBIMEVE PUBLIKE DREJTORIA E PROJEKTEVE DHE INVESTIMEVE DEPARTAMENTI I PROJEKTEVE			
		Dr. e Projekteve e Investimeve	
		FLORA MUCA	
STAFI TEKNIK PROJEKTUES	Ing.	ARJOLA KURTI	
	Ing.	ERBLIN LALA	
	Ing.	DENIS PRENCI	
	Ing.	RAMADAN HYSA	
Titulli i Projektit		Faza e Projektit	
NDERTIM RRUGET "PARALEL ME RRUGEN "LIDHJA E PRIZRENIT" DHE PARALEL ME RRUGEN "IBRAHIM RUGOVA"		PROJEKT ZBATIMI	
Emertimi i Fletes		Data e Implementimit:	
PROFILET TERTHORE		Shkalla e Vizatimit	
		1:200	
		Fleta Nr.	
		15	

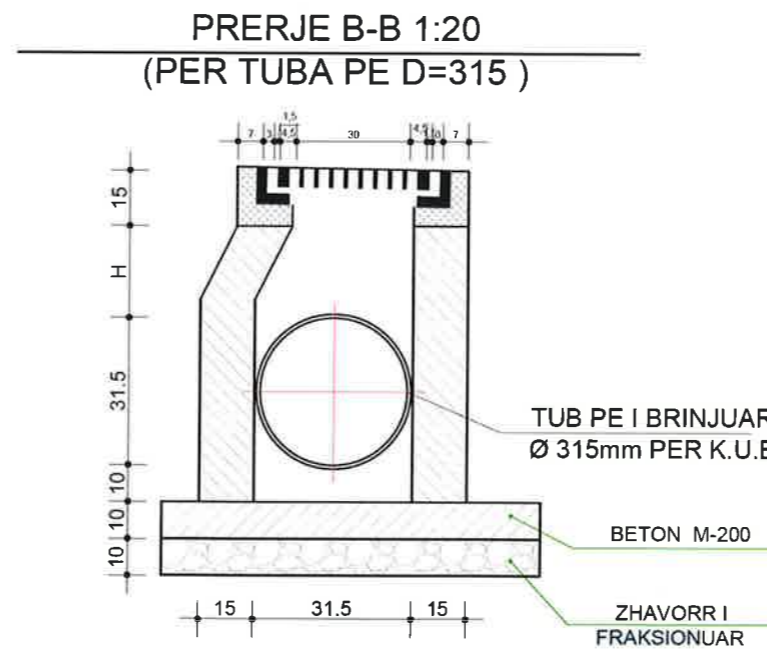
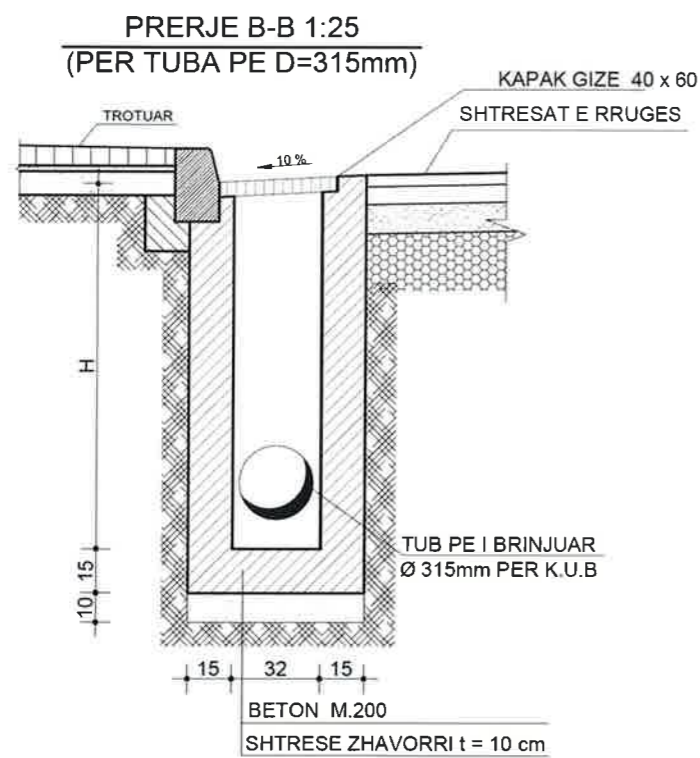
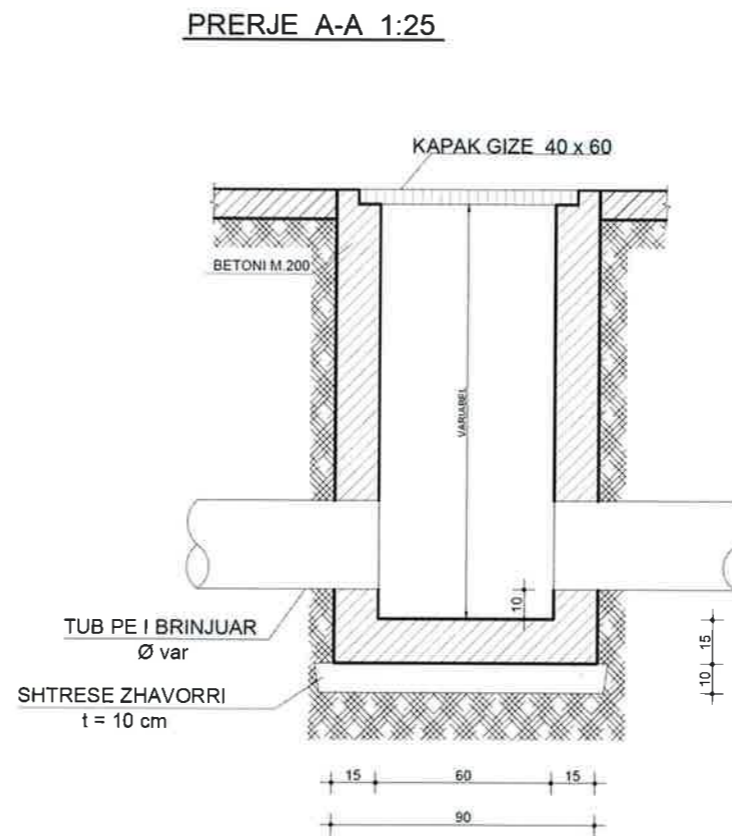
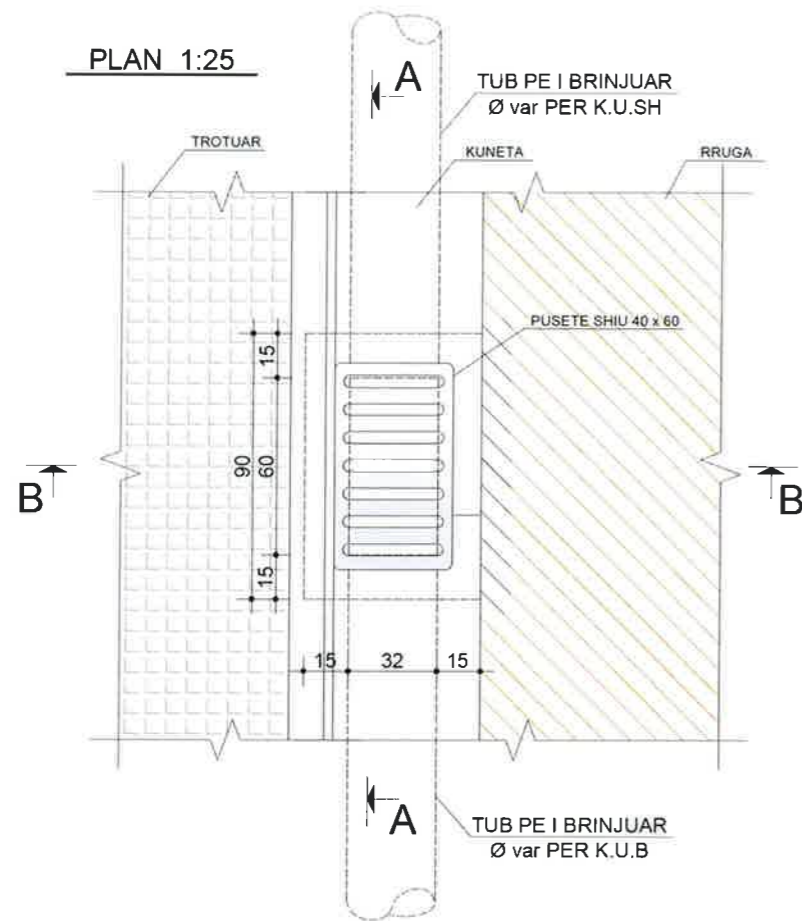

BASHKIA KAMEZ

DREJTORIA E SHERBIMEVE PUBLIKE
DREJTORIA E PROJEKTEVE DHE INVESTIMEVE
DEPARTAMENTI I PROJEKTEVE

Dr. e Projekteve e Investimeve		FLORA MUCA
STAFI TEKNIK PROJEKTUES	Ing.	ARJOLA KURTI
	Ing.	ERBLIN LALA
	Ing.	DENIS PRENCI
	Ing.	RAMADAN HYSA

Titulli i Projektit		Faza e Projektit
NDERTIM RRUGET "PARALEL ME RRUGEN "LIDHJA E PRIZRENIT" DHE PARALEL ME RRUGEN "IBRAHIM RUGOVA"		PROJEKT ZBATIMI
Emerzimi i Fletes		Data e Implementimit :
DETAJE		Shkalla e Vizatimit 1:50
		Fleta Nr. 01

DETAJI PANDUSIT

PRERJA A-A SHK.1:50

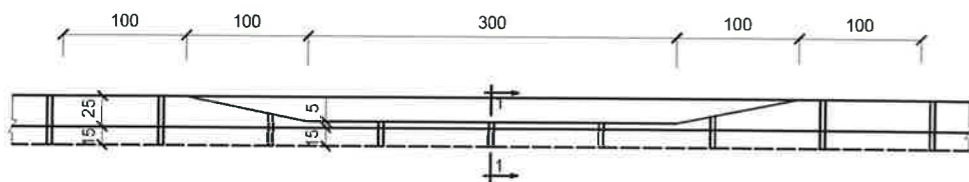

PLAN SHK.1:50

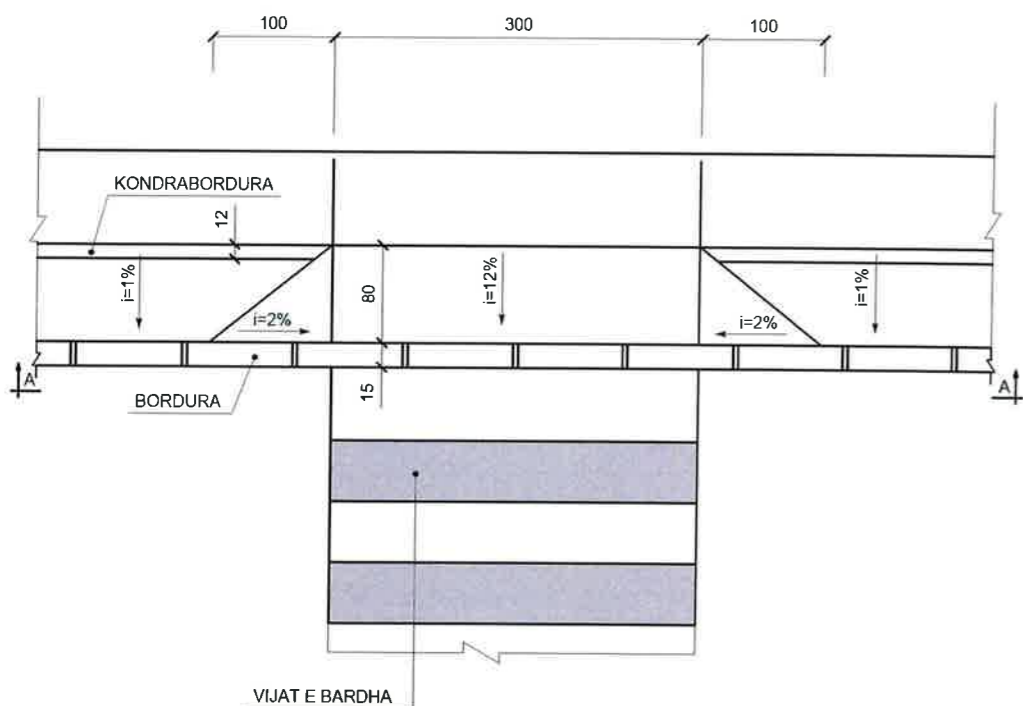

Shënim:
NE CDO PIKE KU KRYQEZOHET RRUGA KRYESORE ME RRUGET DYTESORE DO TE VENDOSEN
PANDUSET E TROTUAREVE

DETAJI I PRERJES SE RRUGES ME PANDUS Sh 1:15

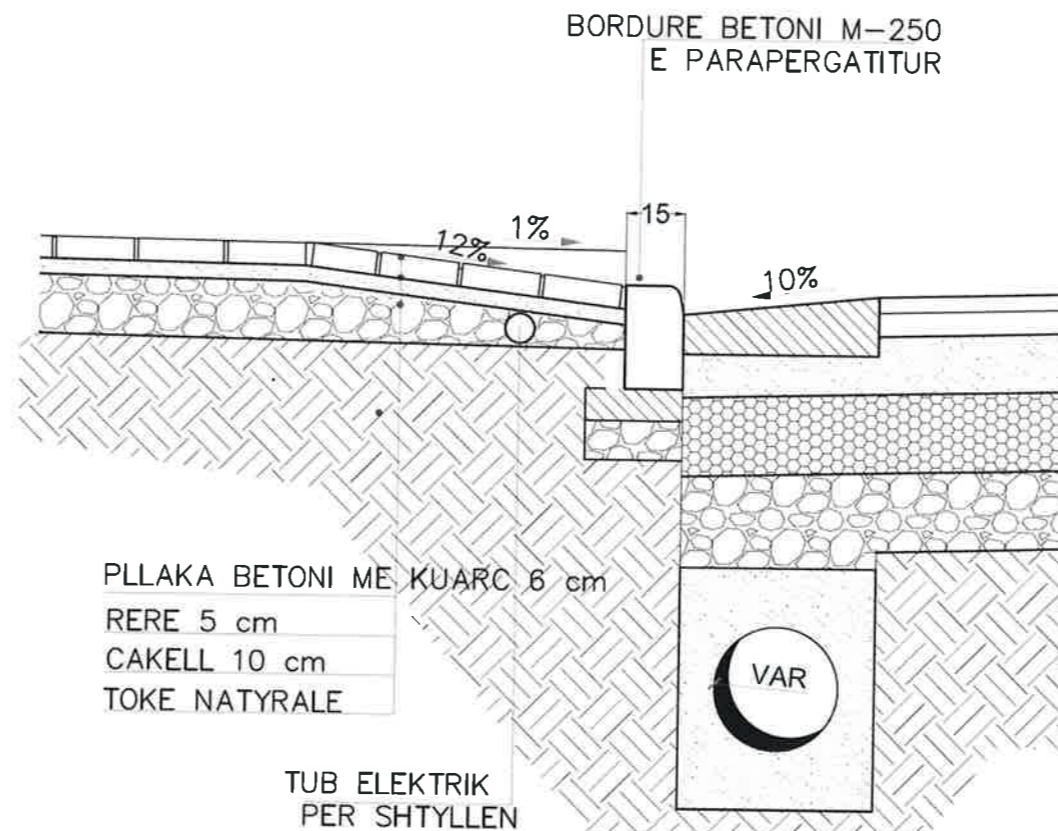

TUB ELEKTRIK
PER SHTYLLEN

Detaji i Bordurës dhe kunetes Sh 1:15

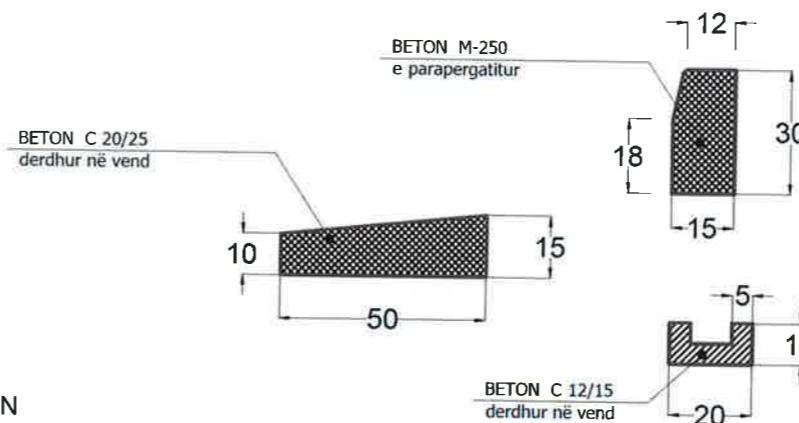

BASHKIA KAMEZ

DREJTORIA E SHERBIMEVE PUBLIKE
DREJTORIA E PROJEKTEVE DHE INVESTIMEVE
DEPARTAMENTI I PROJEKTEVE

Dr. e Projekteve e Investimeve FLORA MUCA

STAFI TEKNIK
PROJEKTUES
Ing. ARJOLA KURTI
Ing. ERBLIN LALA
Ing. DENIS PRENCI
Ing. RAMADAN HYSA

Titulli i Projektit
NDERTIM RRUGET
"PARALEL ME RRUGEN "LIDHJA E PRIZRENIT"
DHE PARALEL ME RRUGEN "IBRAHIM RUGOVA"

Faza e Projektit
PROJEKT ZBATIMI

Data e Implementimit:

Shkalla e Vizatimit:
1:50

Emertimi i Fletes
DETAJE

Fleta Nr.

02

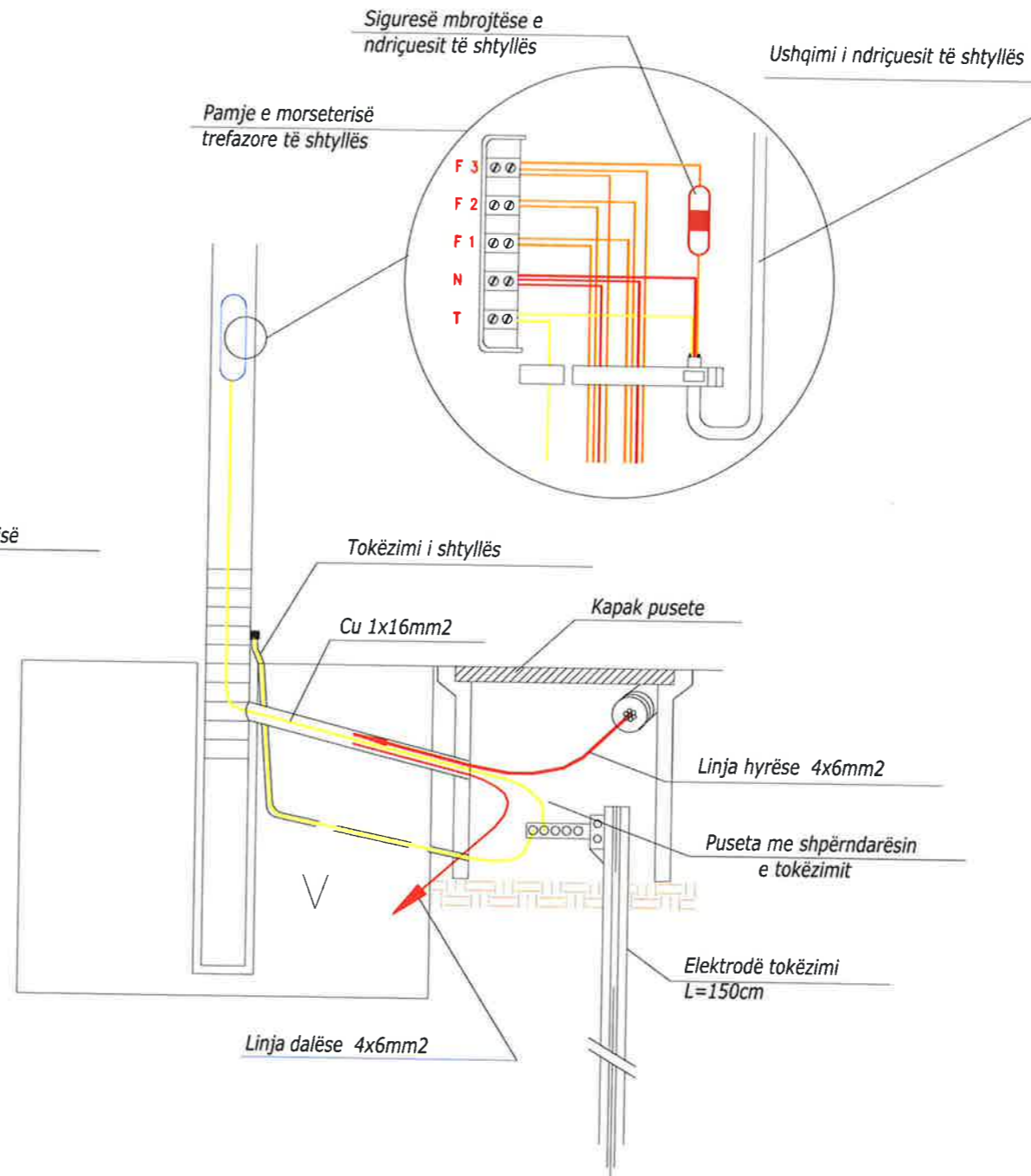
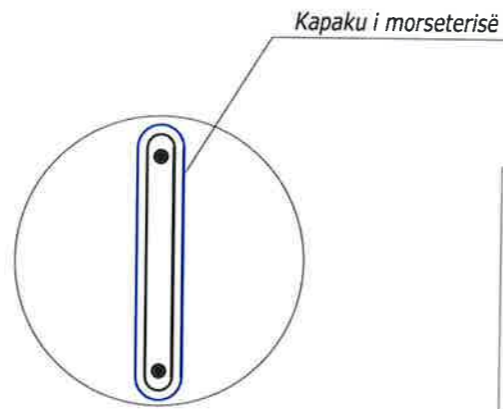
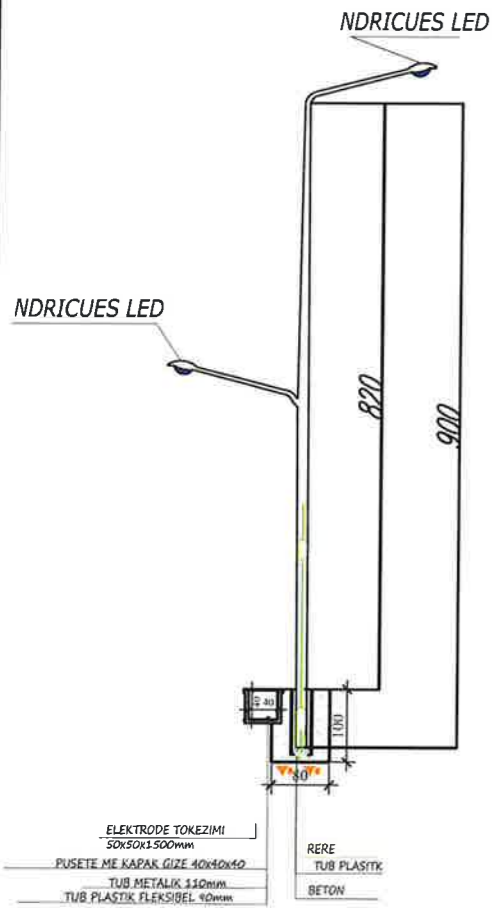

BASHKIA KAMEZ
 DREJTORIA E SHERBIMEVE PUBLIKE
 DREJTORIA E PROJEKTEVE DHE INVESTIMEVE
 DEPARTAMENTI I PROJEKTEVE

Dr. e Projekteve e Investimeve		FLORA MUCA
STAFI TEKNIK PROJEKTES	Ing.	ARJOLA KURTI
	Ing.	ERBLIN LALA
	Ing.	DENIS PRENCI
	Ing.	RAMADAN HYSA

Titulli i Projektit	Faza e Projektit
NDERTIM RRUGET "PARALEL ME RRUGEN "LIDHJA E PRIZRENIT" DHE PARALEL ME RRUGEN "IBRAHIM RUGOVA"	PROJEKT ZBATIMI
Emertimi i Fotos	Data e Implementimit:
DETAJE	Shkalla e Vizatimit 1:50
	Fleta Nr. 03

Detaj i tokëzimit të shtyllës së ndriçimit

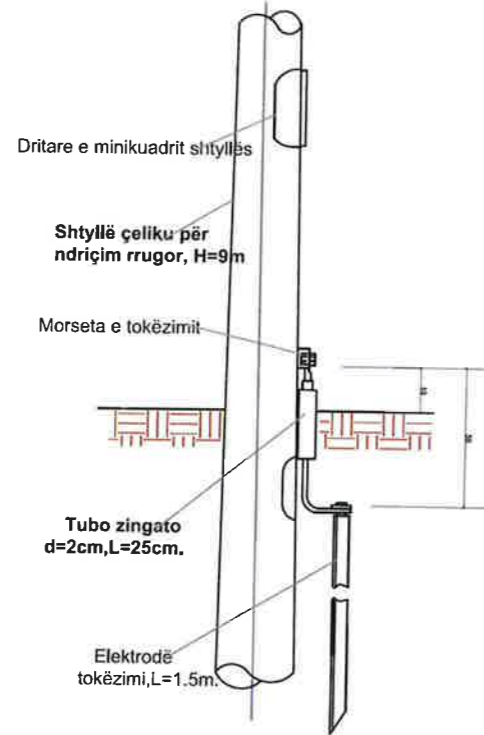

Konstruksioni morseterisë

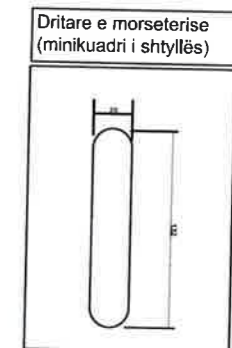
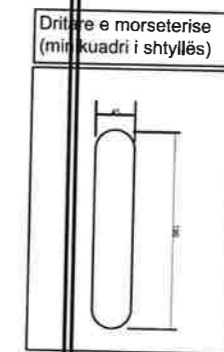
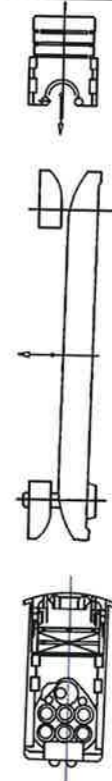
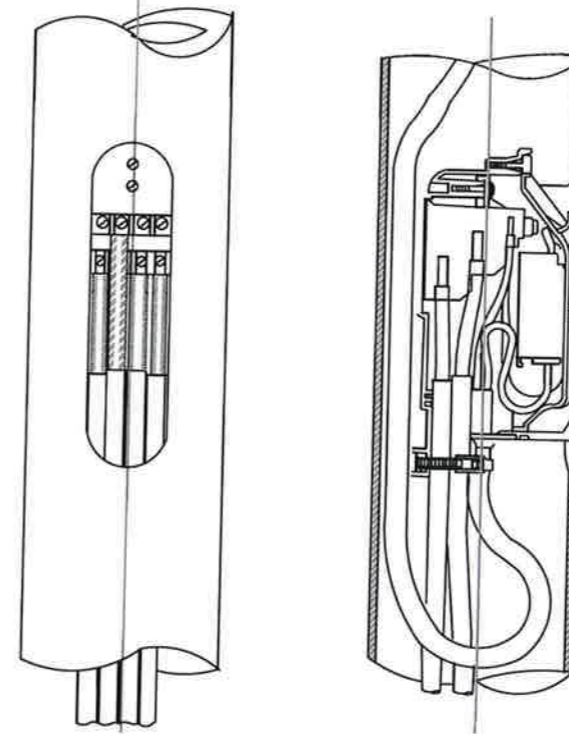

Kabël FG7OR 4x6mm²

Kabël FG7OR 4x6mm²

Pusetë betoni me kapak gize 40x40x40cm

Kabëll FROR 3x1.5 mm²

Kabëll tokëzimi 1x16mm²

Kuadri i ndricuesit në shtyllë

Automat 10 A

1x182W

Elektrodë tokëzimi L=150cm

BASHKIA KAMEZ
 DREJTORIA E SHERBIMEVE PUBLIKE
 DREJTORIA E PROJEKTEVE DHE INVESTIMEVE
 DEPARTAMENTI I PROJEKTEVE

Dr. e Projekteve e Investimeve		FLORA MUCA
STAFI TEKNIK PROJEKTUES	Ing.	ARJOLA KURTI
	Ing.	ERBLIN LALA
	Ing.	DENIS PRENCI
	Ing.	RAMADAN HYSA

Titulli i Projektit		Faza e Projektit
NDERTIM RRUGET "PARALEL ME RRUGEN "LIDHJA E PRIZRENIT" DHE PARALEL ME RRUGEN "IBRAHIM RUGOVA"		PROJEKT ZBATIMI
Emertimi i Fietes		Data e Implementimit:
DETAJE		Skalia e Vizimit 1:50
		Fleta Nr. 04

Prerje e kapakut prej gize

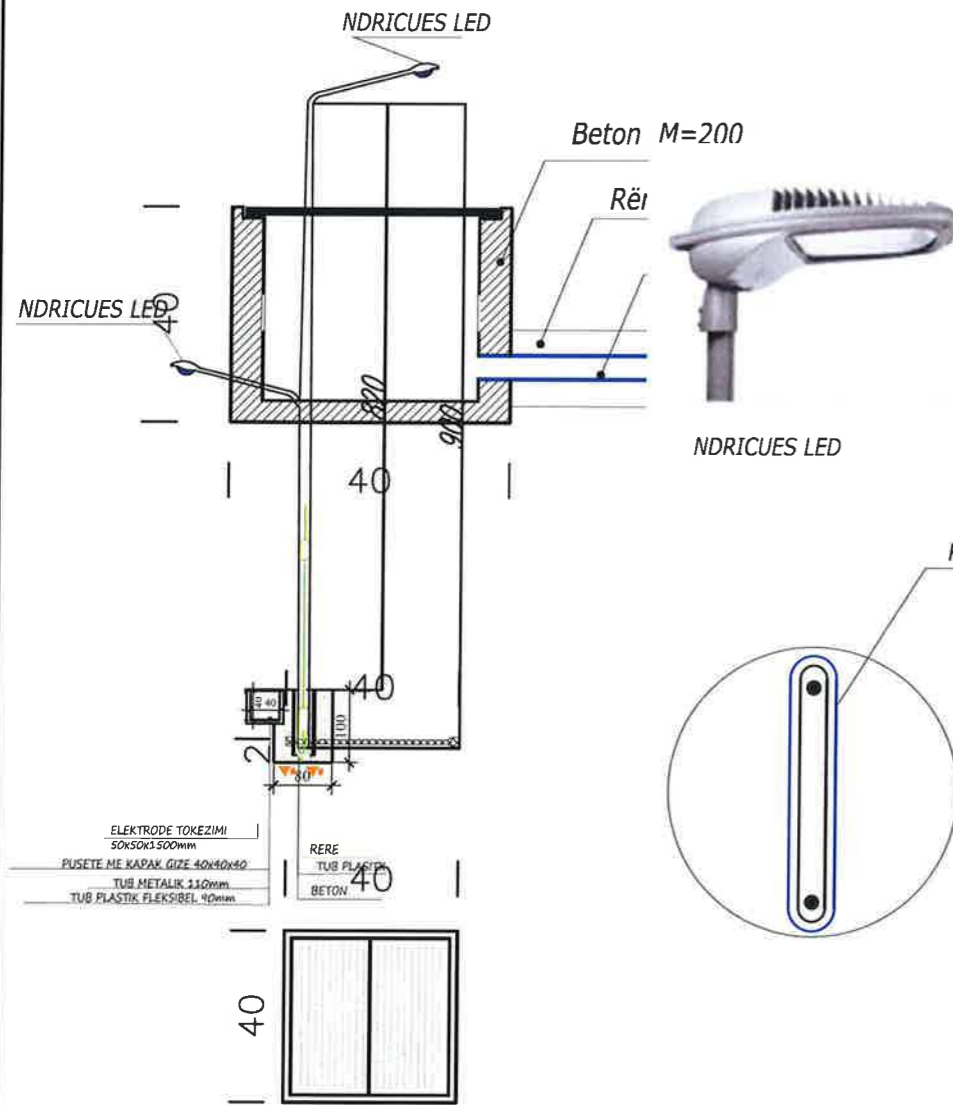

Kapaku i pusetës prej gize

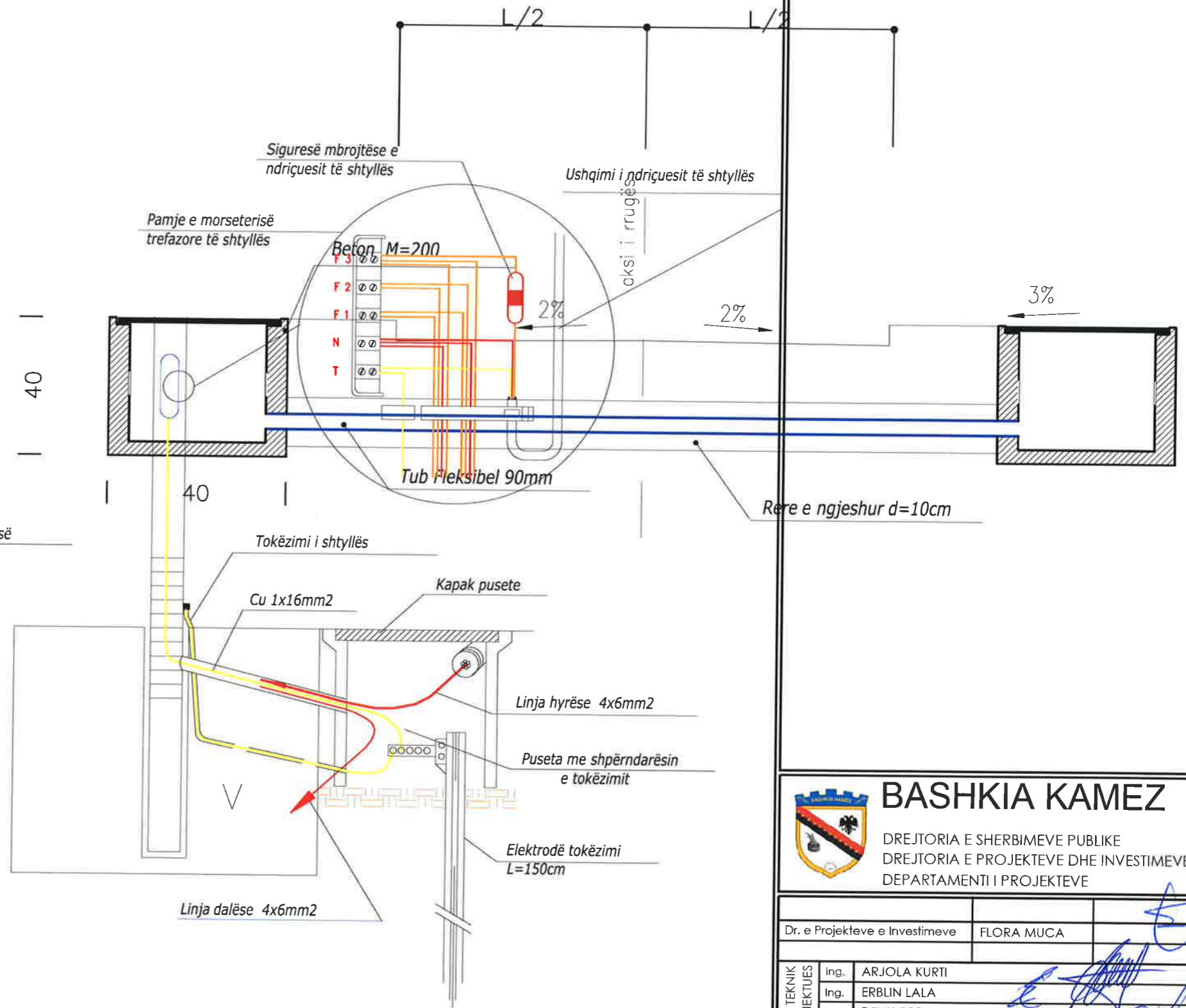

Prerje e vendosjes së pusetave

BASHKIA KAMEZ
 DREJTORIA E SHERBIMEVE PUBLIKE
 DREJTORIA E PROJEKTEVE DHE INVESTIMEVE
 DEPARTAMENTI I PROJEKTEVE

Dr. e Projekteve e Investimeve	FLORA MUCA
STAFI TEKNIK PROJEKTUES	Ing. ARJOLA KURTI Ing. ERBLIN LALA Ing. DENIS PRENCI Ing. RAMADAN HYSA
Titulli i Projektit	NDERTIM RRUGET "PARALEL ME RRUGEN "LIDHJA E PRIZRENIT" DHE PARALEL ME RRUGEN "IBRAHIM RUGOVA"
Faza e Projektit	PROJEKT ZBATIMI
Emertimi i Fletës	DETAJE
Shkalla e Vizimit	1:50
Fleta Nr.	05

Hollësi e inkastrimit të kolonës së ndriçuesit me lartësi H=9m

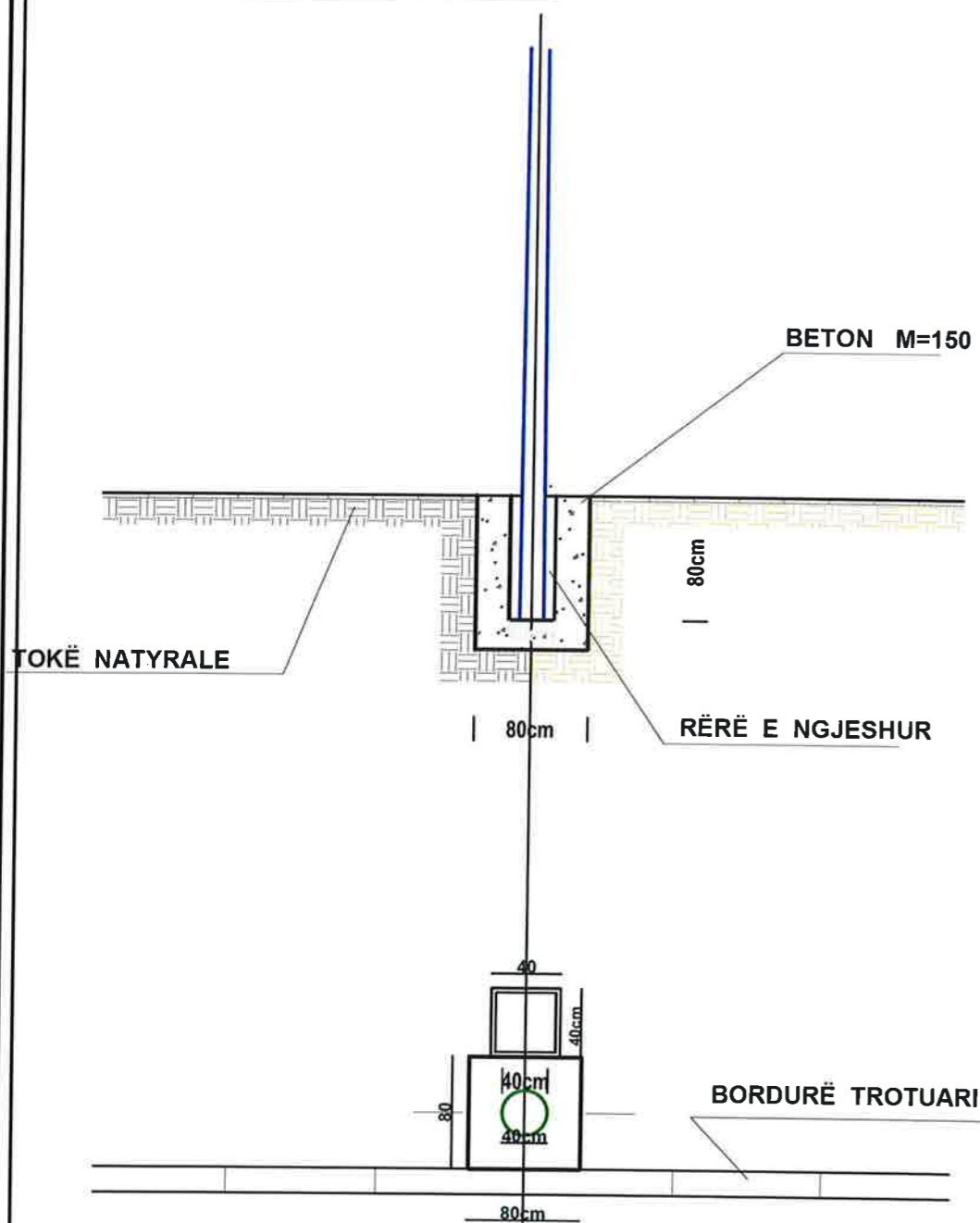

Hollësi e vendosjes së pusetës për Tub fleksibel 90mm

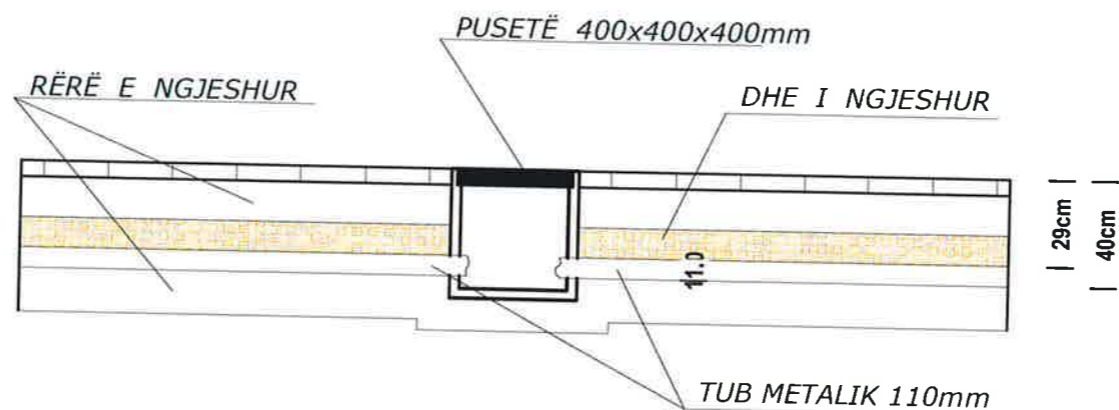

Hollësi e vendosjes së pusetës për Tub metalik 110mm

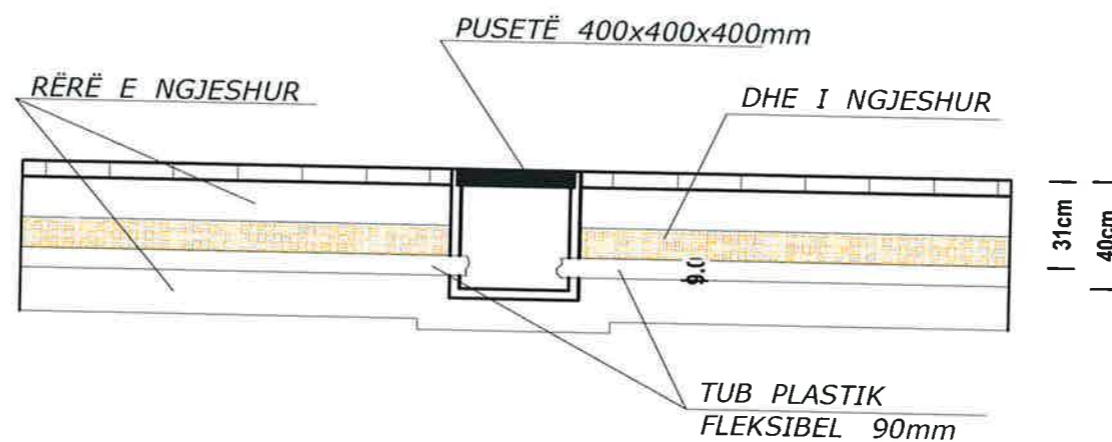

BASHKIA KAMEZ
 DREJTORIA E SHERBIMEVE PUBLIKE
 DREJTORIA E PROJEKTEVE DHE INVESTIMEVE
 DEPARTAMENTI I PROJEKTEVE

Dr. e Projekteve e Investimeve	FLORA MUCA
STAFI TEKNIK PROJEKTUES	Ing. ARJOLA KURTI Ing. ERBLIN LALA Ing. DENIS PRENCI Ing. RAMADAN HYSA

Thull i Projektit	Faza e Projektit
NDERTIM RRUGET "PARALEL ME RRUGEN "LIDHJA E PRIZRENIT" DHE PARALEL ME RRUGEN "IBRAHIM RUGOVA"	PROJEKT ZBATIMI
Emersimi i Fletës	Data e Implementimit:
DETAJE	Shkallë e Vizimit: 1:50
	Fleta Nr. 06

Planimetria e instalimit të rrjetit kabllor të ndriçimit,

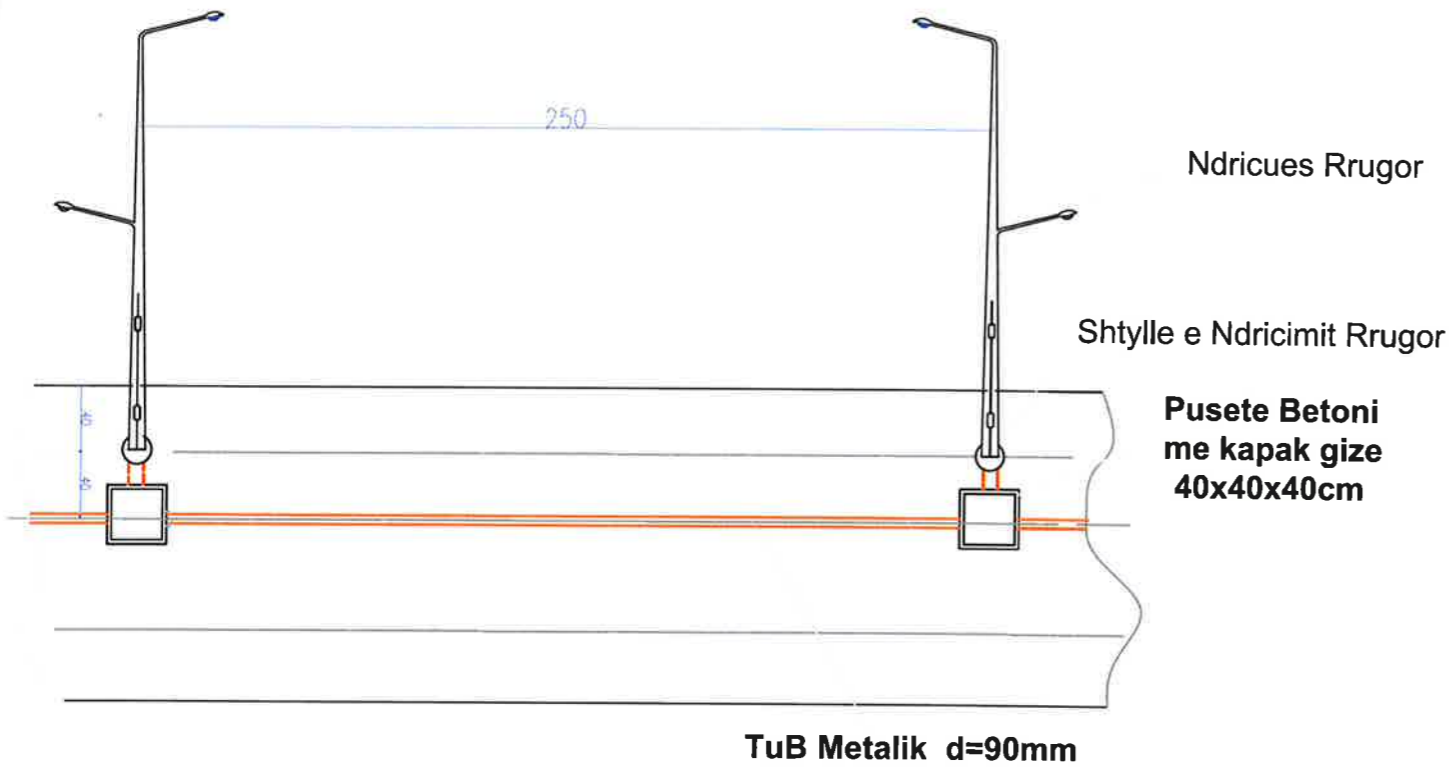

Shtrimi i kabllave te TU ne TP.direkt ne toke

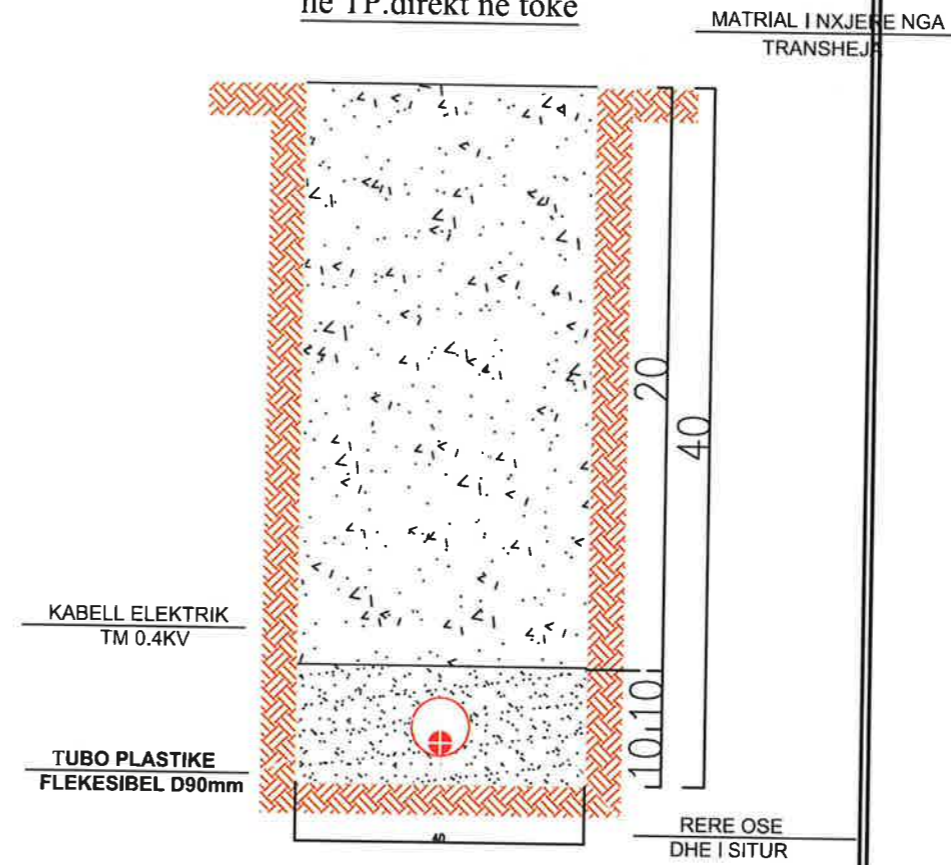

Detaj i montimit te pusetes dhe tokezimit te shtylles

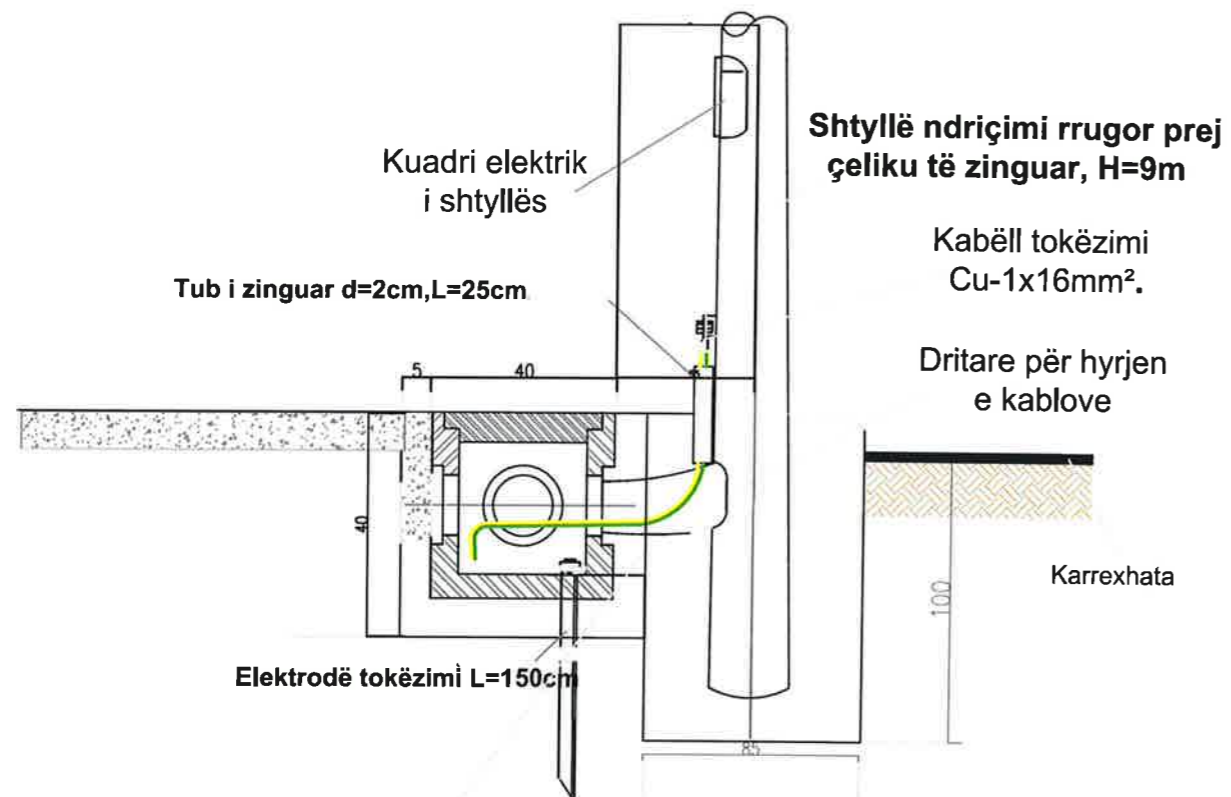

BASHKIA KAMEZ
 DREJTORIA E SHERBIMEVE PUBLIKE
 DREJTORIA E PROJEKTEVE DHE INVESTIMEVE
 DEPARTAMENTI I PROJEKTEVE

Dr. e Projekteve e Investimeve	FLORA MUCA
STAFI TEKNIK PROJEKTES	Ing. ARJOLA KURTI Ing. ERBLIN LALA Ing. DENIS PRENCI Ing. RAMADAN HYSA

Titulli i Projektit NDERTIM RRUGET "PARALEL ME RRUGEN "LIDHJA E PRIZRENIT" DHE PARALEL ME RRUGEN "IBRAHIM RUGOVA"	Faza e Projektit PROJEKT ZBATIMI
Emertimi i Planos DETAJE	Shkalla e Vizatimit 1:50
	Plota Nr. 07

VENDOSJA DHE MONTIMI I SHENJES RRUGORE SHENJA LAJMERUESE

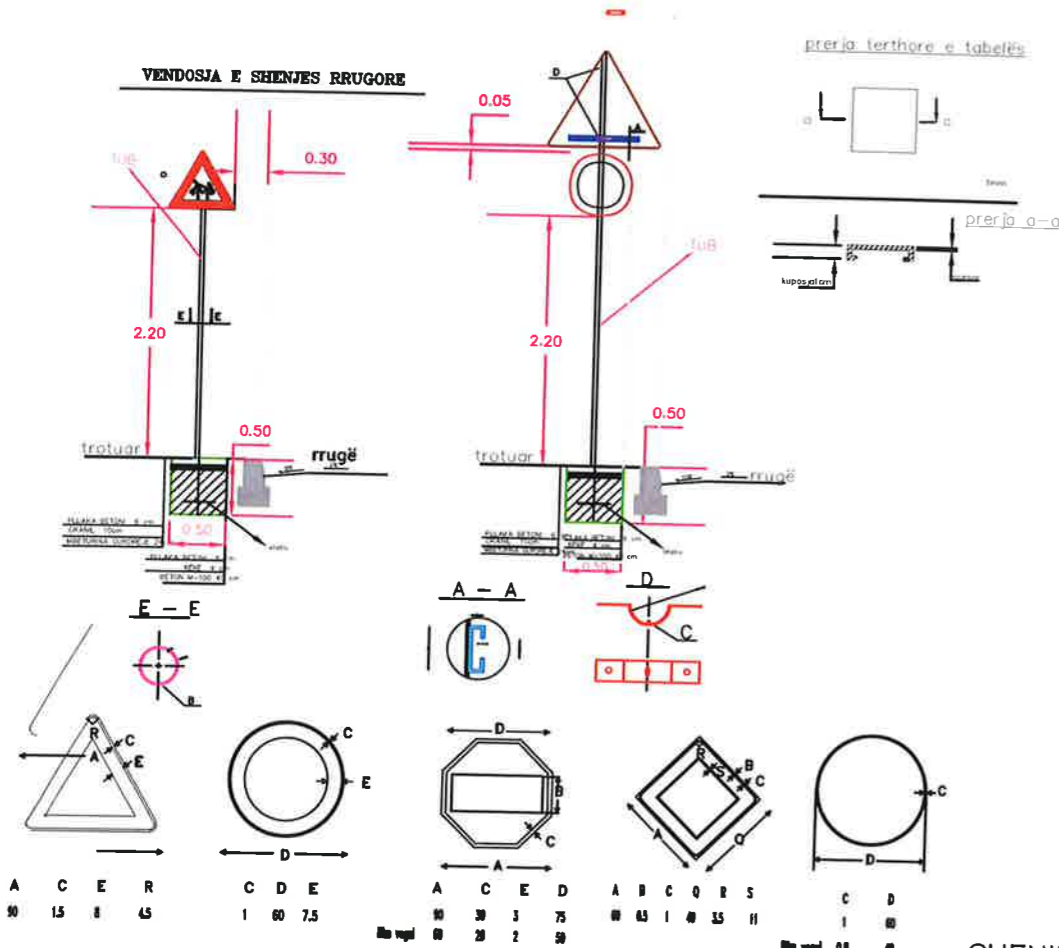

LAJMERIM PER NDERPRERJE NGA RRUGE DYTESORE, KTHESAT E KURBEZUARA, FEMIJET, KEMBESORET DHE PER NDALJE/DHENIE RRUGE

trekëndeshi: e kuqe reflektuese
sfondi: i zi
Simboli: e bardhe reflektuese



Triangle: red reflective
Background: white reflective
Symbol: black

SHENJA NDALUESE

shenjat per kufirin e shpejtesise dhe ndalim parakalimin

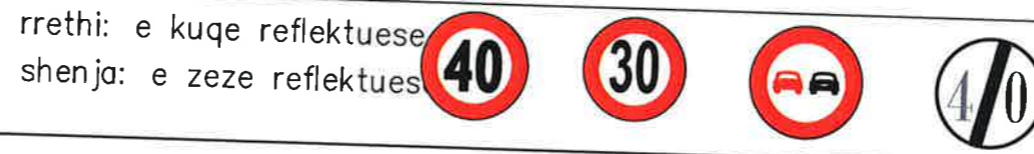

SHENIM: Shenjat rrugore per nga forma, madhesia, ngjyra reflektiviteti duhet te jene sipas Kodit Rrugor te Republikes se Shqiperise. Materiali praparefektiv duhet te kete jetegjatesi 10vjet per Clasin 2 dhe 7 vjet per Clasin 1. Simboli brenda shenjes rrugore duhet te jete i realizuar me boje te trajtuar me pjekje e cila nuk humbet treguesit e saj. Shenja rrugore realizohet me llamarine çeliku e cila lyhet me boje opake kundrandra korozionit dhe trajtohet me pjekje.

DETAJE Kurrizë artificiale h-5cm

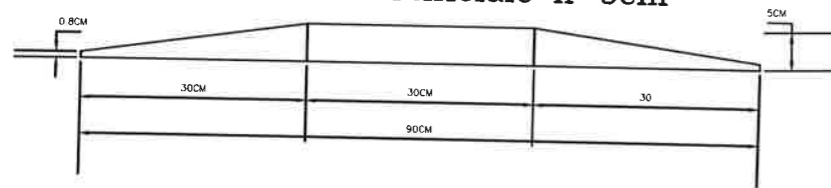

SHENJA DETYRUESE

Anet & Shigjetat: E bardhe reflektuese
Edge & arrow: white reflective



SHENJA PLOTESUESE

SHENJA E KTHESES NE NJE DREJTIM DY DREJTME

Shenja : e bardhe reflektuese
Sfondi: e zeze



SHENJA INFORMUESE

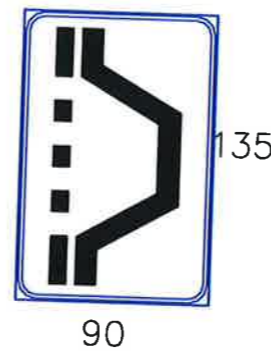

BASHKIA KAMEZ
DREJTORIA E SHERBIMEVE PUBLIKE
DREJTORIA E PROJEKTEVE DHE INVESTIMEVE
DEPARTAMENTI I PROJEKTEVE

Dr. e Projekteve e Investimeve	FLORA MUCA
STAFI TEKNIK PROJEKTES	Ing. ARJOLA KURTI Ing. ERBLIN LALA Ing. DENIS PRENCI Ing. RAMADAN HYSA

Thulli i Projektit	NDERTIM RRUGET "PARALEL ME RRUGEN "LIDHJA E PRIZRENIT" DHE PARALEL ME RRUGEN "IBRAHIM RUGOVA"
Faza e Projektit	PROJEKT ZBATIMI
Data e Implementimit:	
Shkalla e Vizatimit	1:50
Fleta Nr.	08

PUSETE TIP D=100cm

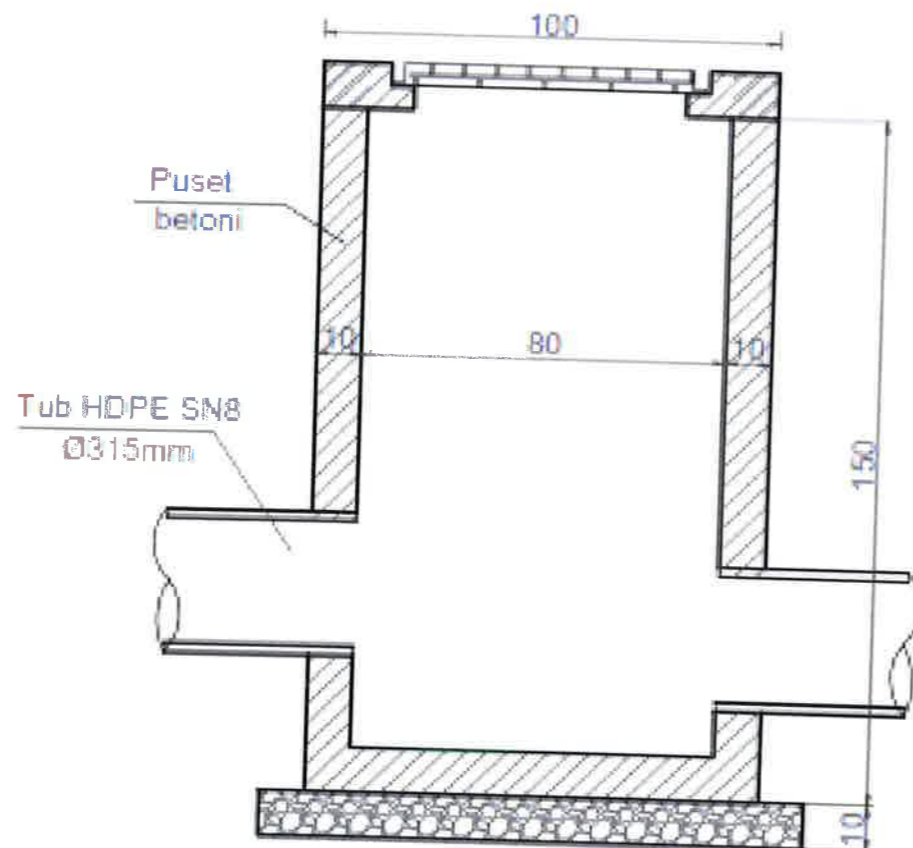
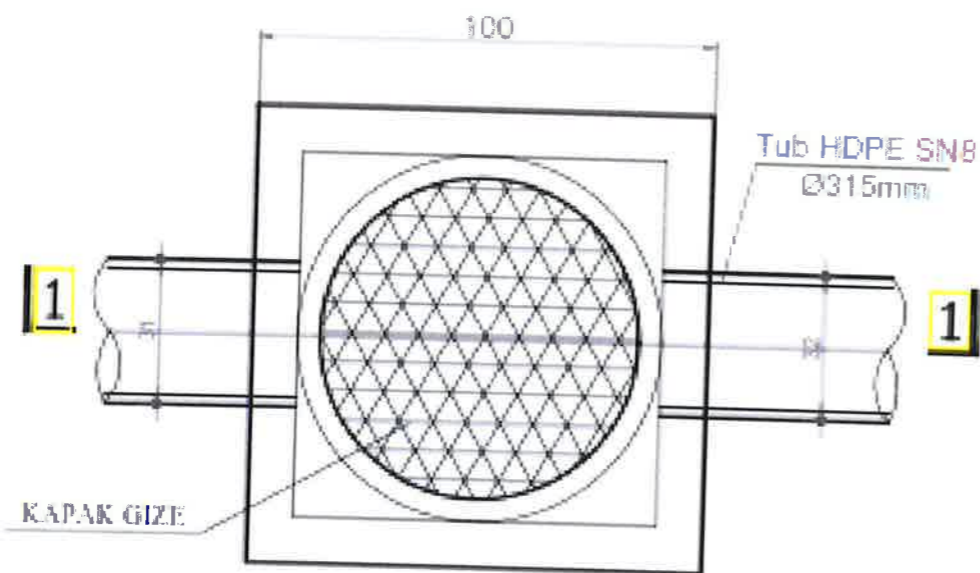

BASHKIA KAMEZ
 DREJTORIA E SHERBIMEVE PUBLIKE
 DREJTORIA E PROJEKTEVE DHE INVESTIMEVE
 DEPARTAMENTI I PROJEKTEVE

Dr. e Projekteve e Investimeve	FLORA MUCA
STAFI TEKNIK PROJEKTORES	Ing. ARJOLA KURTI Ing. ERBLIN LALA Ing. DENIS PRENCI Ing. RAMADAN HYSA

Titulli i Projektit	Faza e Projektit
NDERTIM RRUGET "PARALEL ME RRUGEN "LIDHJA E PRIZRENIT" DHE PARALEL ME RRUGEN "IBRAHIM RUGOVA"	PROJEKT ZBATIMI
Emertimi i Fletes	Data e Implementimit :
DETAJE	Shkalla e Vizatimit 1:50
	Fleta Nr. 13

NGRTIJE PUSETE

PRERJE 1-1 Sh 1:20

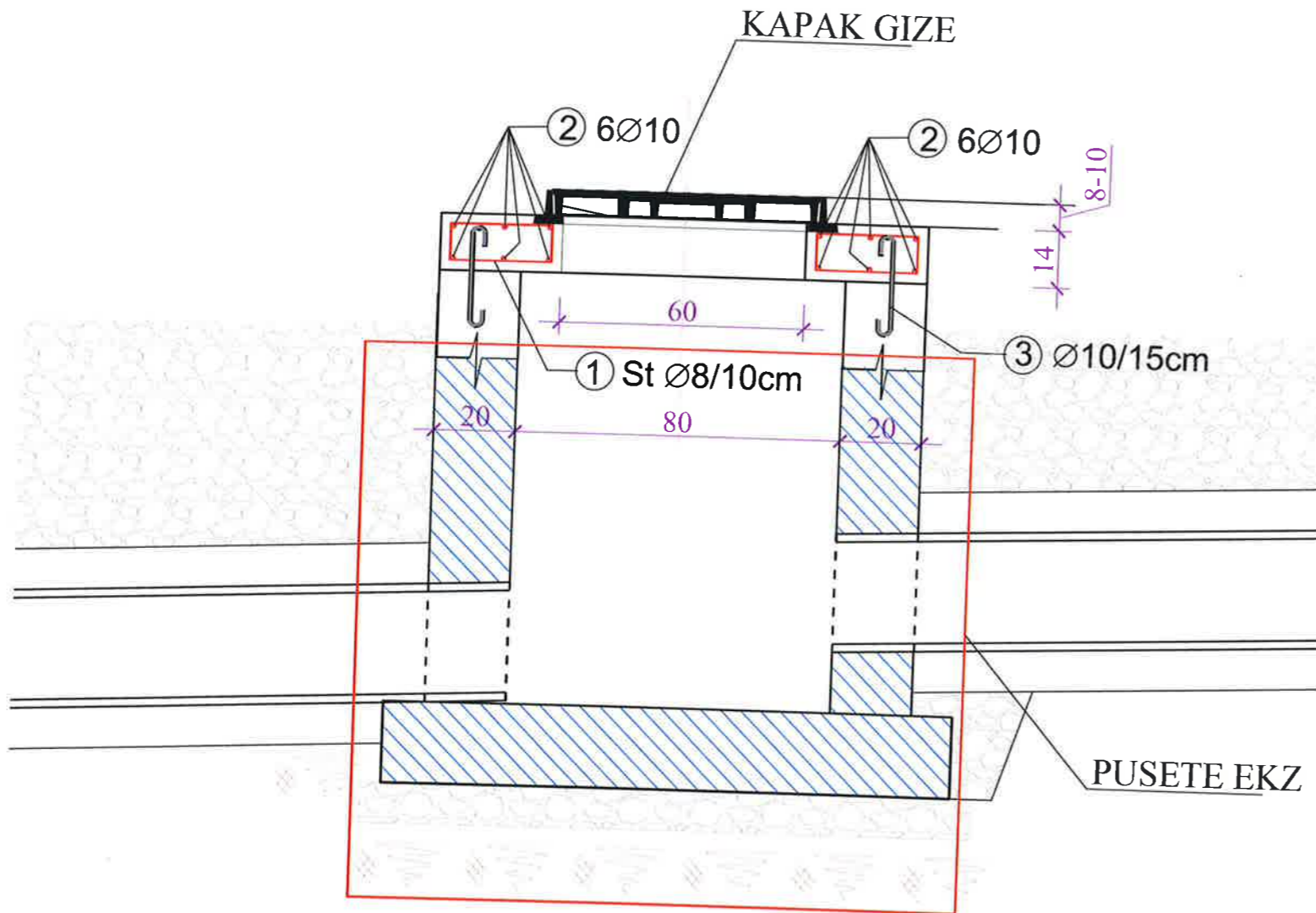

PRERJE 1-1 Sh 1:20

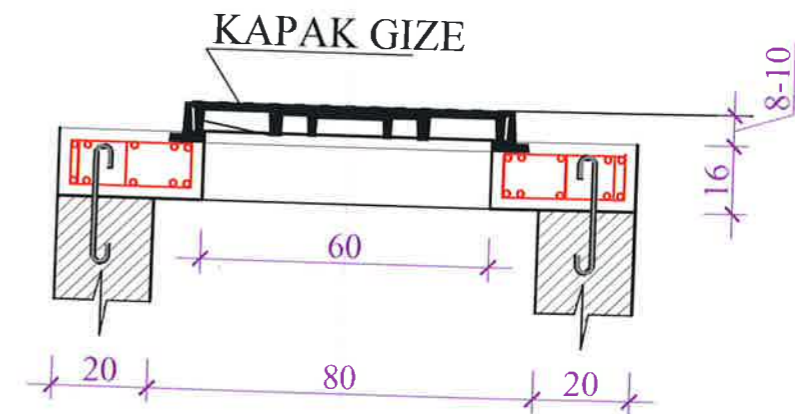

BASHKIA KAMEZ
 DREJTORIA E SHERBIMEVE PUBLIKE
 DREJTORIA E PROJEKTEVE DHE INVESTIMEVE
 DEPARTAMENTI I PROJEKTEVE

Dr. e Projekteve e Investimeve		FLORA MUCA	
STAFI TEKNIK PROJEKTUES	Ing.	ARJOLA KURTI	
	Ing.	ERBLIN LALA	
	Ing.	DENIS PRENCI	
	Ing.	RAMADAN HYSA	

Ndertimi i Projektit		Faza e Projektit
NDERTIM RRUGET "PARALEL ME RRUGEN "LIDHJA E PRIZRENIT" DHE PARALEL ME RRUGEN "IBRAHIM RUGOVA"		PROJEKT ZBATIMI
Emertimi i Fletes		Data e implementimit:
DETAJE		Shkalla e Vizatimit
		Fleta Nr.