

PROJEKT ZBATIMI

Objekti: "Ndertimi i rrjetit te kanalizimeve te ujrave te zeza te lagjeve perreth ujembledhesit te Paskuqanit dhe ndertimi i vazhdimit te Rruges "Ali Demi"



BASHKIA KAMËZ

MIRATOI

KRYETAR I BASHKISË KAMËZ

Z. RAKIP SULI

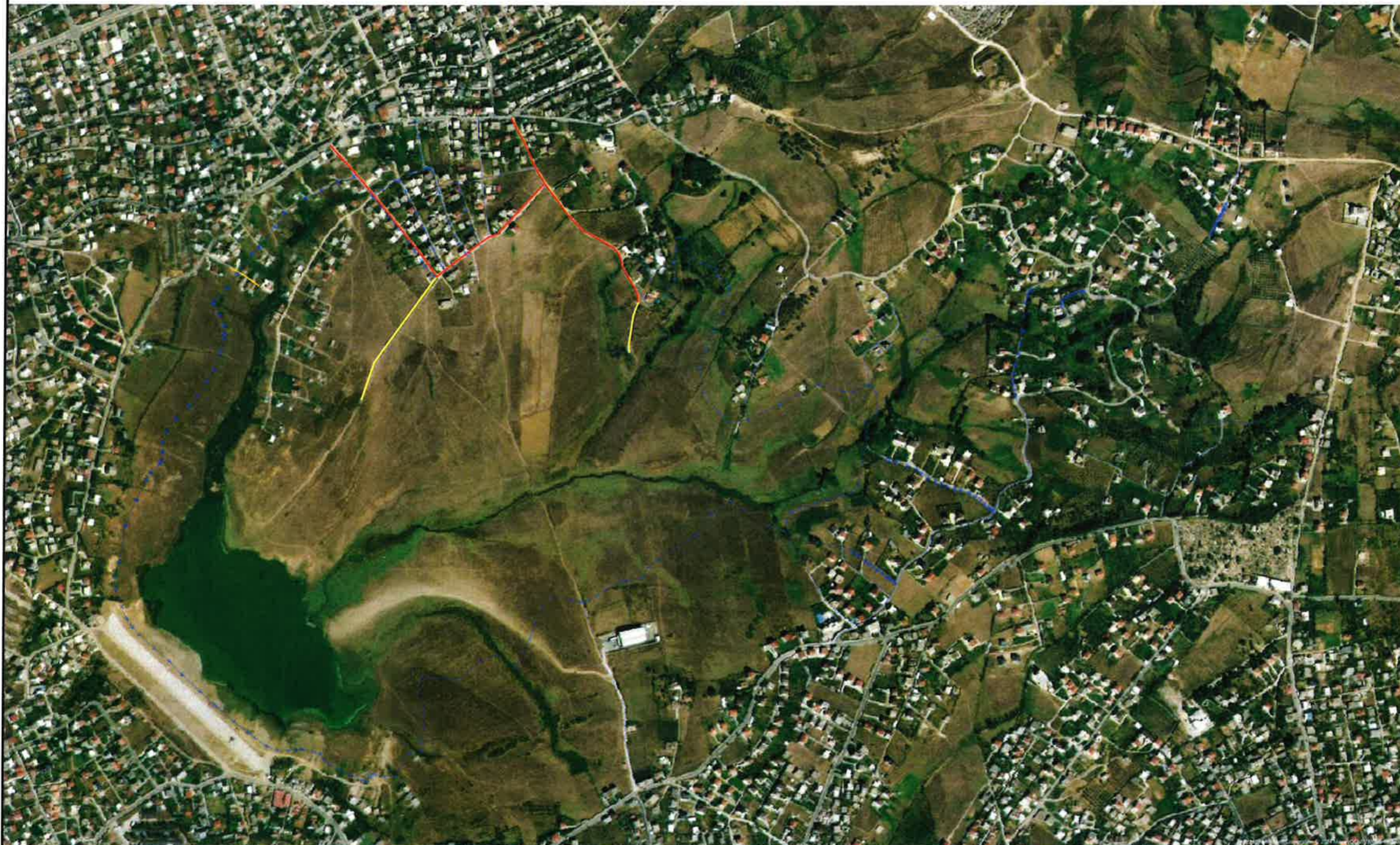

		BASHKIA KAMËZ	
		DREJTORIA E PROJEKTEVE DHE INVESTIMEVE DEPARTAMENTI I PROJEKTEVE	
Dr. e Projekteve e Investimeve		FLORA MUÇA	
Prgj. e Projekteve		EMANUELA MEZIU	
STAFI TEKNIK PROJEKTUES	Ing. Konstruktor	DENIS	PRENÇI
	Ing. Gjeoinformatik	ERBLIN	LALA
	Ing. Konstruktor	EGLANTINA	DISHA
	Topograf	RAMADAN	HYSA
Titulli i Projektit		Faza e Projektit	
"Ndertimi i rrjetit te kanalizimeve te ujrave te zeza te lagjeve perreth ujembledhesit te Paskuqanit dhe ndertimi i vazhdimit te Rruges "Ali Demi"		PROJEKT ZBATIMI	
Emertimi i Fletes		Data e Implementimit:	
KAPAKU		Shkalla e Vizatimit:	
		Fleta Nr.	
		A-00	

Objekti: "Ndertimi i rrjetit te kanalizimeve te ujrave te zeza te lagjeve perreth ujembledhesit te Paskuqanit dhe ndertimi i vazhdimit te Rruges "Ali Demi"

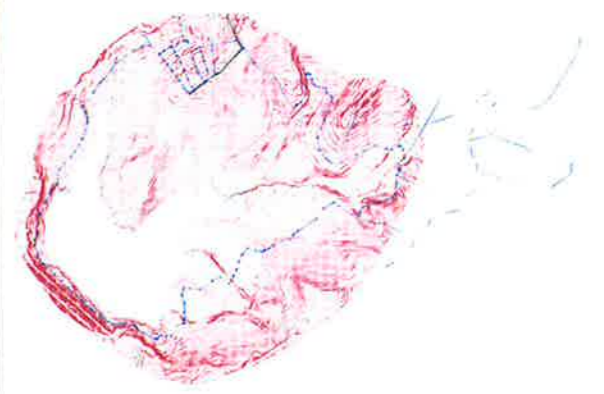
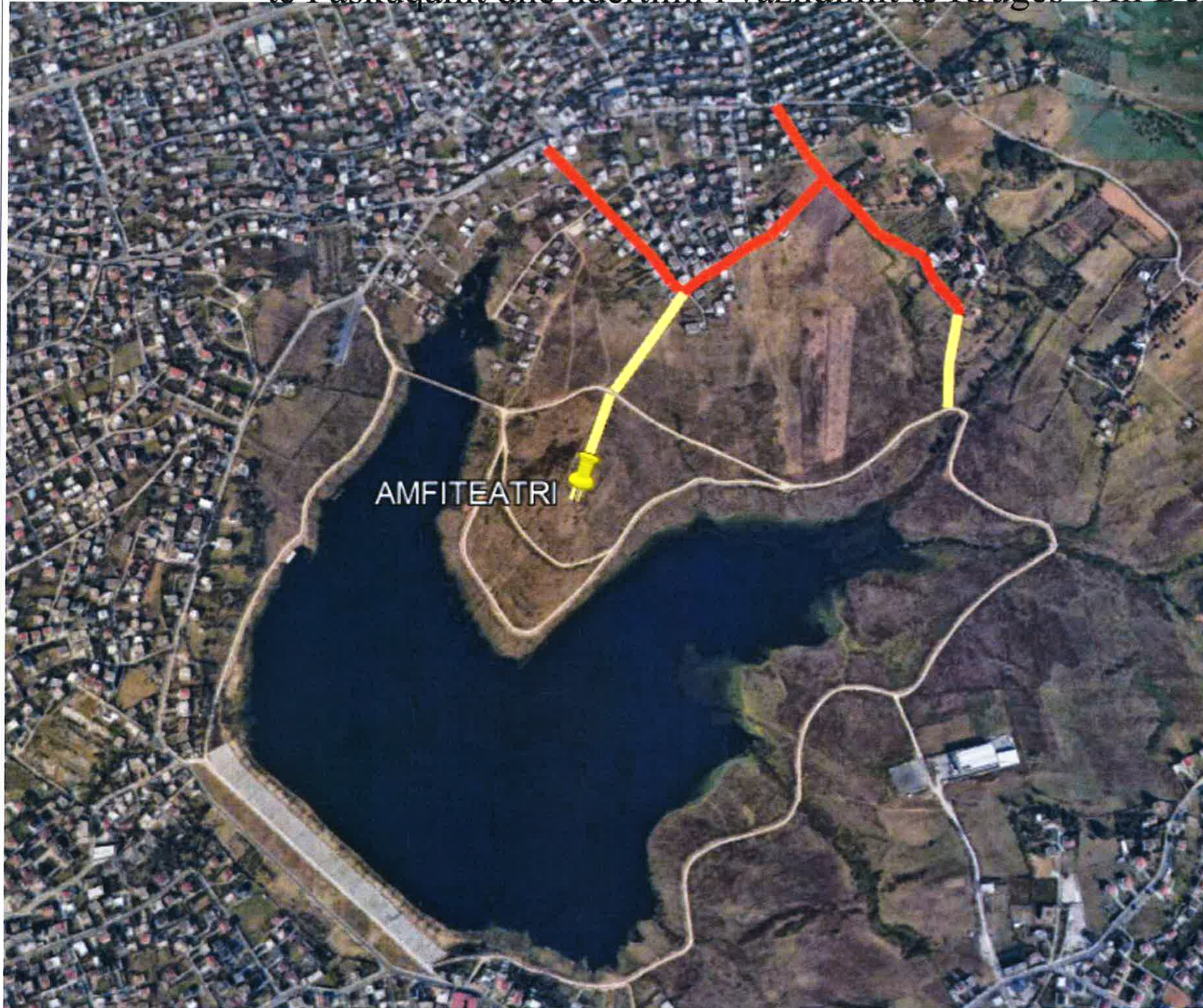

BASHKIA KAMEZ
DREJTORIA E PROJEKTEVE DHE INVESTIMEVE
DEPARTAMENTI I PROJEKTEVE

Dr. e Projekteve e Investimeve	FLORA MUÇA		
Prgj. e Projekteve	EMANUELA MEZIU		
STAFI TEKNIK PROJEKTES	Ing. Konstruktur	DENIS PRENÇI	
	Ing. Gjeoinformatik	ERBLIN LALA	
	Ing. Preventivues	EGLANTINA DISHA	
	Topograf	RAMADAN HYSA	

Titulli i Projektit:
"Ndertimi i rrjetit te kanalizimeve te ujrave te zeza te lagjeve perreth ujembledhesit te Paskuqanit dhe ndertimi i vazhdimit te Rruges "Ali Demi"
Faza e Projektit:
PROJEKT ZBATIMI
Data e Implementimit:

Emertimi i Fletes:
ORTOFOTO
Shkalla e Vizimit: 1:1000
Fleta Nr. S-01

Objekti: "Ndertimi i rrjetit te kanalizimeve te ujrave te zeza te lagjeve perreth ujembledhesit te Paskuqanit dhe ndertimi i vazhdimit te Rruges "Ali Demi"

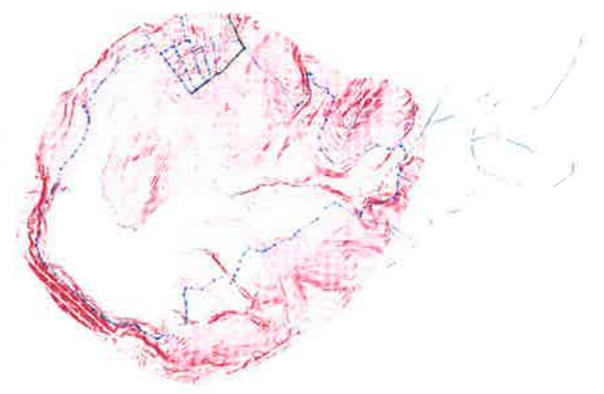

BASHKIA KAMEZ
DREJTORIA E PROJEKTEVE DHE INVESTIMEVE
DEPARTAMENTI I PROJEKTEVE

Dr. e Projekteve e Investimeve FLORA MUÇA
Prgj. e Projekteve EMANUELA MEZIU

STAFI TEKNIK PROJEKTES	Ing. Konstruktor	DENIS	PRENÇI
	Ing. Gjeoinformatik	ERBLIN	LALA
	Ing. Preventivues	EGLANTINA	DISHA
	Topograf	RAMADAN	HYSA

Titulli i Projektit:
"Ndertimi i rrjetit te kanalizimeve te ujrave te zeza te lagjeve perreth ujembledhesit te Paskuqanit dhe ndertimi i vazhdimit te Rruges "Ali Demi"
Faza e Projektit:
PROJEKT ZBATIMI
Data e Implementimit:

Emertimi i Fletes:
RRJETI K.U.N TE LAGJEVE PERRETH UJEMBLEDHESIT SE LIQENIT TE PASKUQANIT
Shkalla e Vizatimit: 1:1000
Fleta Nr.: S-01

Objekti: "Ndertimi i rrjetit te kanalizimeve te ujrave te zeza te lagjeve perreth ujembledhesit te Paskuqanit dhe ndertimi i vazhdimit te Rruges "Ali Demi"

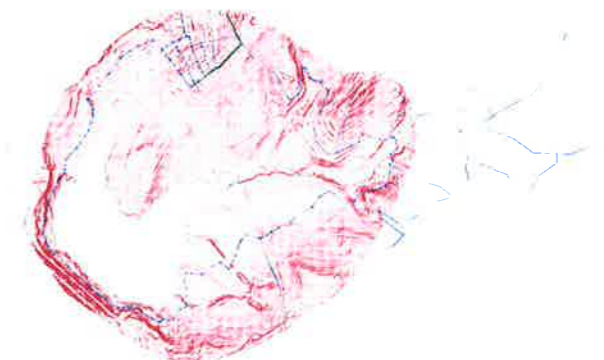
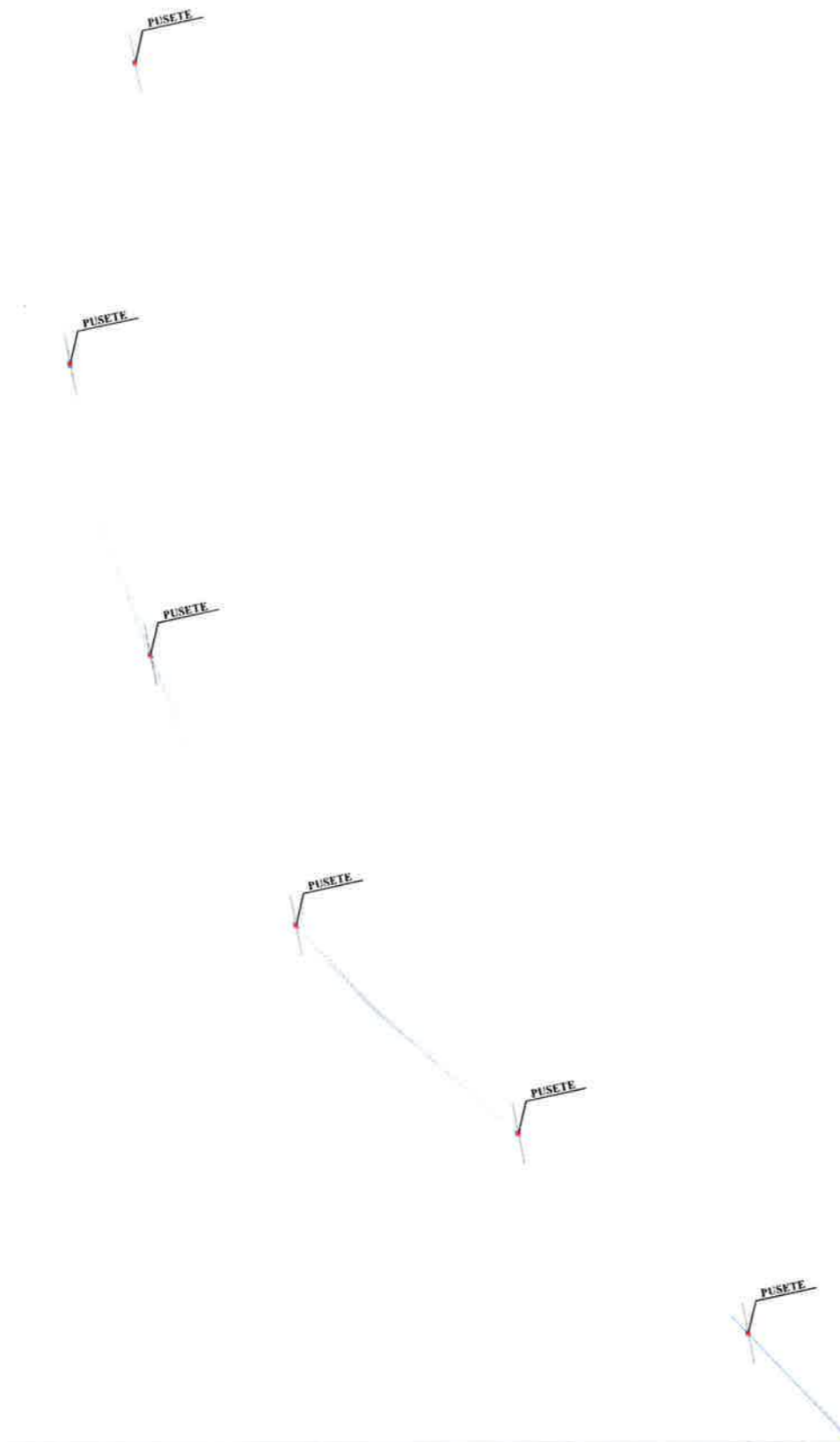

BASHKIA KAMEZ

DREJTORIA E PROJEKTEVE DHE INVESTIMEVE
DEPARTAMENTI I PROJEKTEVE

Dr. e Projekteve e Investimeve FLORA MUÇA
Prgj. e Projekteve EMANUELA MEZIU

STAFI TEKNIK PROJEKTUES	Ing. Konstruktor	DENIS	PRENÇI
	Ing. Gjeoinformatik	ERBLIN	LALA
	Ing. Preventivues	EGLANTINA DISHA	
	Topograf	RAMADAN HYSA	

Titulli i Projektit:
"Ndertimi i rrjetit te kanalizimeve te ujrave te zeza te lagjeve perreth ujembledhesit te Paskuqanit dhe ndertimi i vazhdimit te Rruges "Ali Demi"

Faza e Projektit:
PROJEKT ZBATIMI

Data e Implementimit:

Shkalla e Vizatimit: 1:1000

Emertimi i Fletes:
RRJETI K.U.N TE LAGJEVE PERRETH
UJEMBLEDHESIT SE LIQENIT TE PASKUQANIT

Fleta Nr.

S-02

Objekti: "Ndertimi i rrjetit te kanalizimeve te ujrave te zeza te lagjeve perreth ujembledhesit te Paskuqanit dhe ndertimi i vazhdimit te Rruges "Ali Demi"

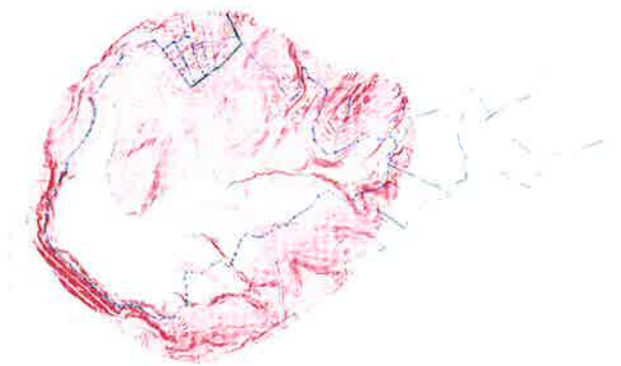
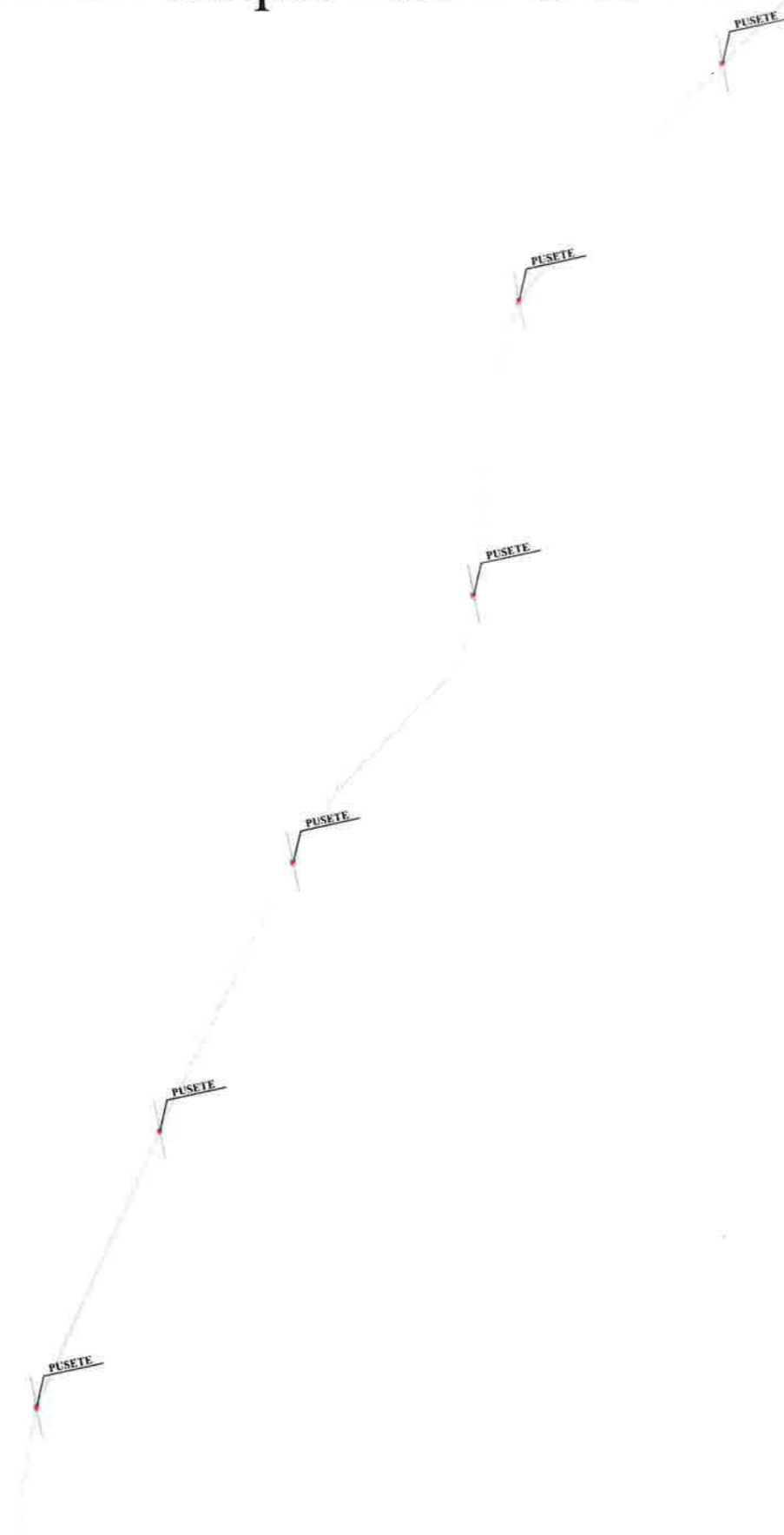

BASHKIA KAMEZ

DREJTORIA E PROJEKTEVE DHE INVESTIMEVE
DEPARTAMENTI I PROJEKTEVE

Dr. e Projekteve e Investimeve FLORA MUÇA
Prgj. e Projekteve EMANUELA MEZIU

STAFI TEKNIK PROJEKTUES	Ing. Konstruktor	DENIS	PRENÇI
	Ing. Gjeoinformatik	ERBLIN	LALA
	Ing. Preventivues	EGLANTINA	DISHA
	Topograf	RAMADAN	HYSA

Titulli i Projektit:
"Ndertimi i rrjetit te kanalizimeve te ujrave te zeza te lagjeve perreth ujembledhesit te Paskuqanit dhe ndertimi i vazhdimit te Rruges "Ali Demi"

Faza e Projektit:
PROJEKTI ZBATIM

Data e Implementimit:

Shkalla e Vizatimit: 1:1000

Emertimi i Fletes:

RRJETI K.U.N TE LAGJEVE PERRETH
UJEMBLEDHESIT SE LIQENIT TE PASKUQANIT

Fleta Nr.

S-03

Objekti: "Ndertimi i rrjetit te kanalizimeve te ujrave te zeza te lagjeve perreth ujembledhesit te Paskuqanit dhe ndertimi i vazhdimit te Rruges "Ali Demi"

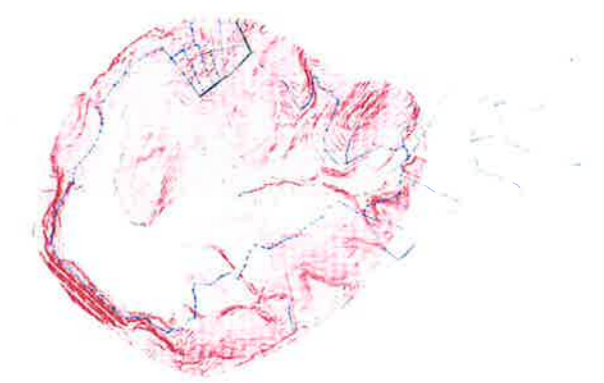
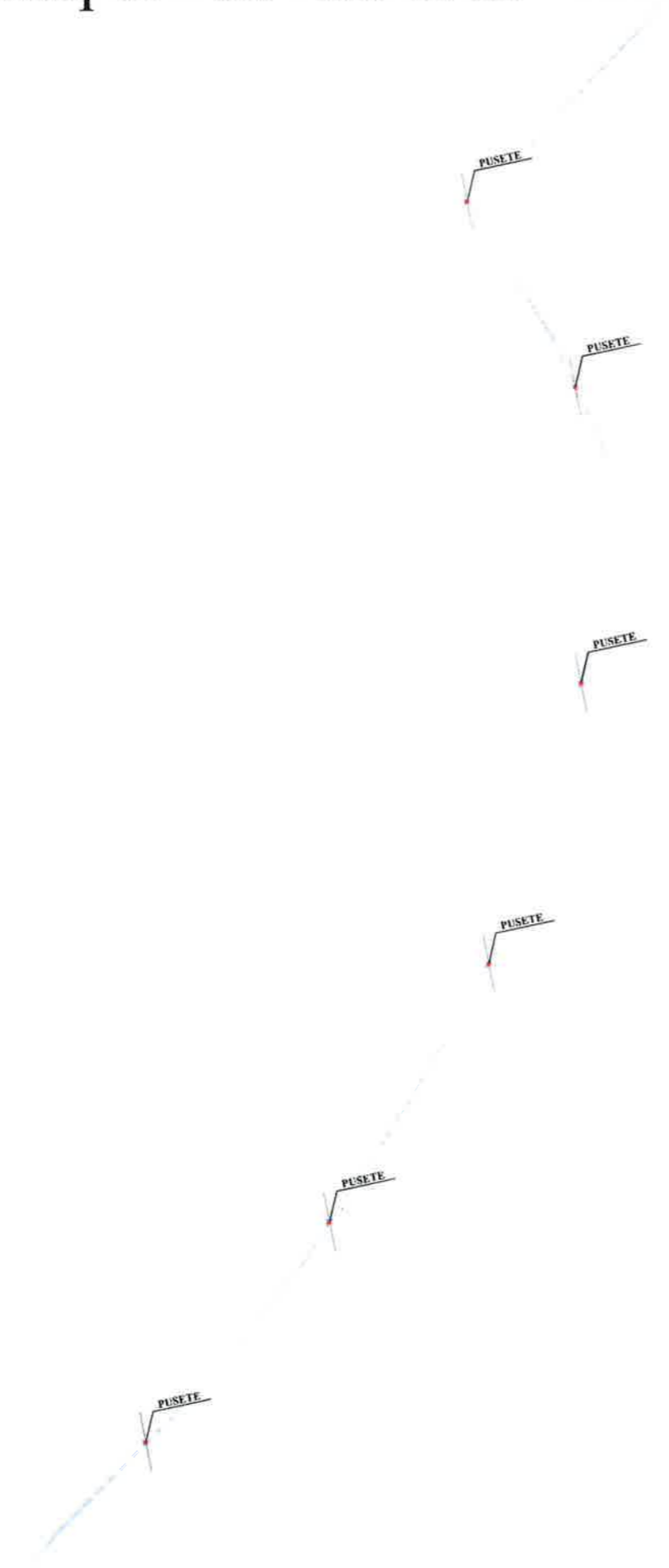

BASHKIA KAMEZ
DREJTORIA E PROJEKTEVE DHE INVESTIMEVE
DEPARTAMENTI I PROJEKTEVE

Dr. e Projekteve e Investimeve FLORA MUÇA
Prgj. e Projekteve EMANUELA MEZIU

STAFI TEKNIK PROJEKTES	Ing. Konstruktor	DENIS	PRENÇI
	Ing. Gjeoinformatik	ERBLIN	LALA
	Ing. Preventivues	EGLANTINA	DISHA
	Topograf	RAMADAN	HYSA

Titulli i Projektit:
"Ndertimi i rrjetit te kanalizimeve te ujrave te zeza te lagjeve perreth ujembledhesit te Paskuqanit dhe ndertimi i vazhdimit te Rruges "Ali Demi"

Emertimi i Fletes:
RRJETI K.U.N TE LAGJEVE PERRETH UJEMBLEDHESIT SE LIQENIT TE PASKUQANIT

(Handwritten signatures and initials)

Faza e Projektit: PROJEKT ZBATIMI

Data e Implementimit:

Shkalla e Vizatimit: 1:1000

Fleta Nr. S-04

Objekti: "Ndertimi i rrjetit te kanalizimeve te ujrave te zeza te lagjeve perreth ujembledhesit te Paskuqanit dhe ndertimi i vazhdimit te Rruges "Ali Demi"

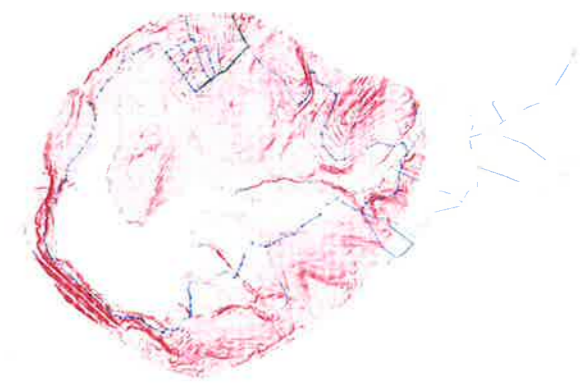
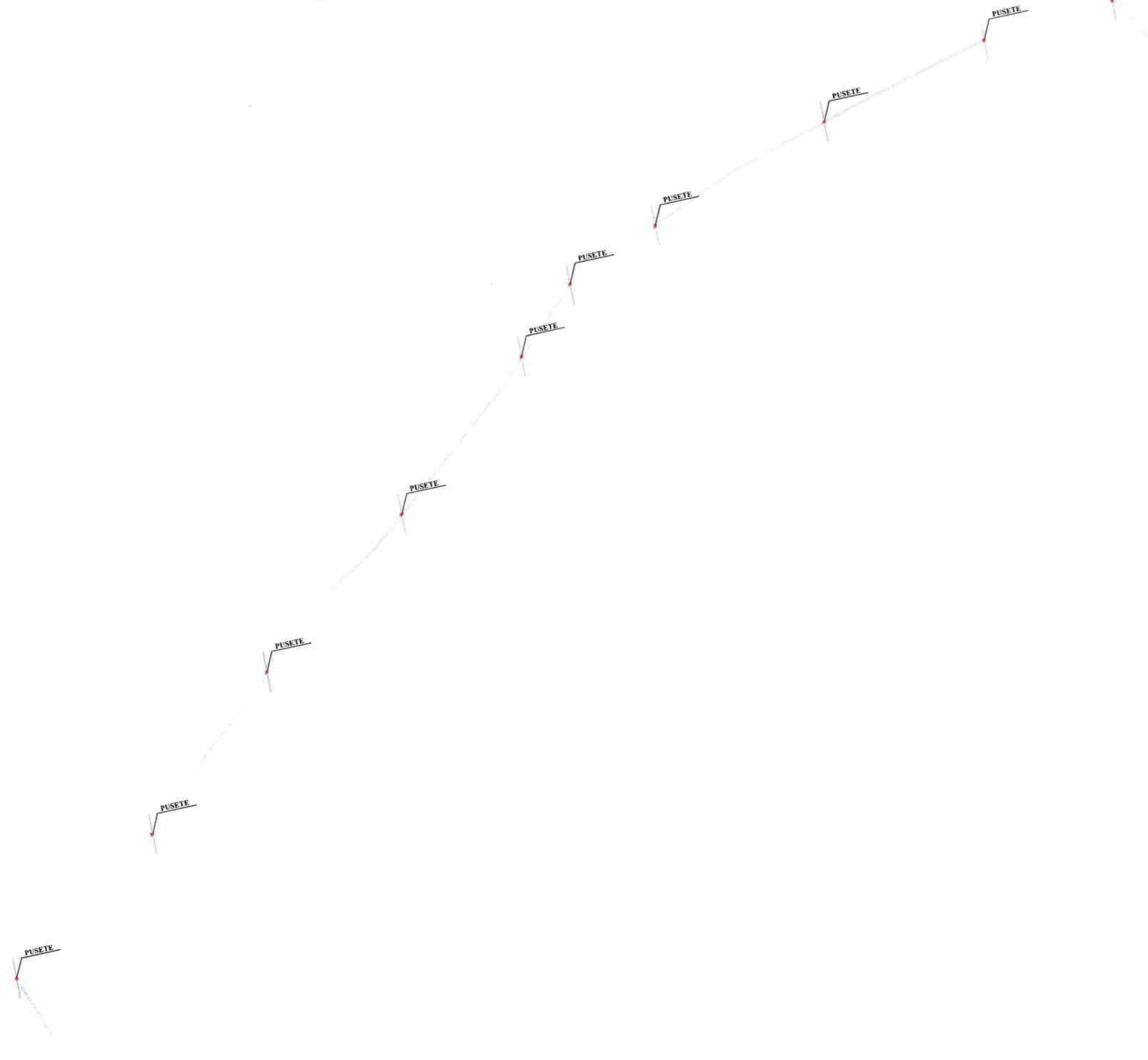

BASHKIA KAMEZ
 DREJTORIA E PROJEKTEVE DHE INVESTIMEVE
 DEPARTAMENTI I PROJEKTEVE

Dr. e Projekteve e Investimeve FLORA MUÇA
 Prgj. e Projekteve EMANUELA MEZIU

STAFI TEKNIK
 PROJEKTUES
 Ing. Konstruktor DENIS PRENÇI
 Ing. Gjeoinformatik ERBLIN LALA
 Ing. Preventivues EGLANTINA DISHA
 Topograf RAMADAN HYSA

Titulli i Projektit:
 "Ndertimi i rrjetit te kanalizimeve te ujrave te zeza te lagjeve perreth ujembledhesit te Paskuqanit dhe ndertimi i vazhdimit te Rruges "Ali Demi"
 Faza e Projektit:
 PROJEKT ZBATIMI
 Data e Implementimit:

Emertimi i Foles:
 RRJETI K.U.N TE LAGJEVE PERRETH UJEMBLEDHESIT SE LIQENIT TE PASKUQANIT
 Shkalla e Vizatimit: 1:1000
 Fleta Nr.
S-05

Objekti: "Ndertimi i rrjetit te kanalizimeve te ujrave te zeza te lagjeve perreth ujembledhesit te Paskuqanit dhe ndertimi i vazhdimit te Rruges "Ali Demi"

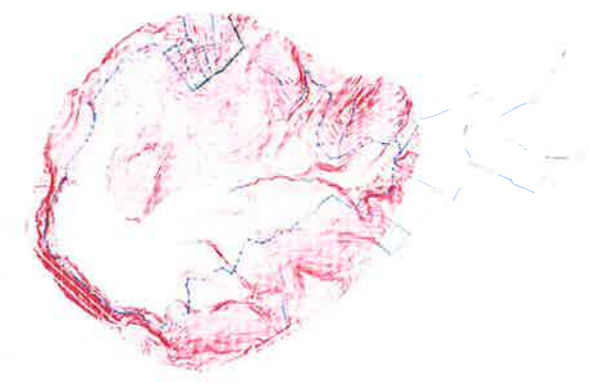
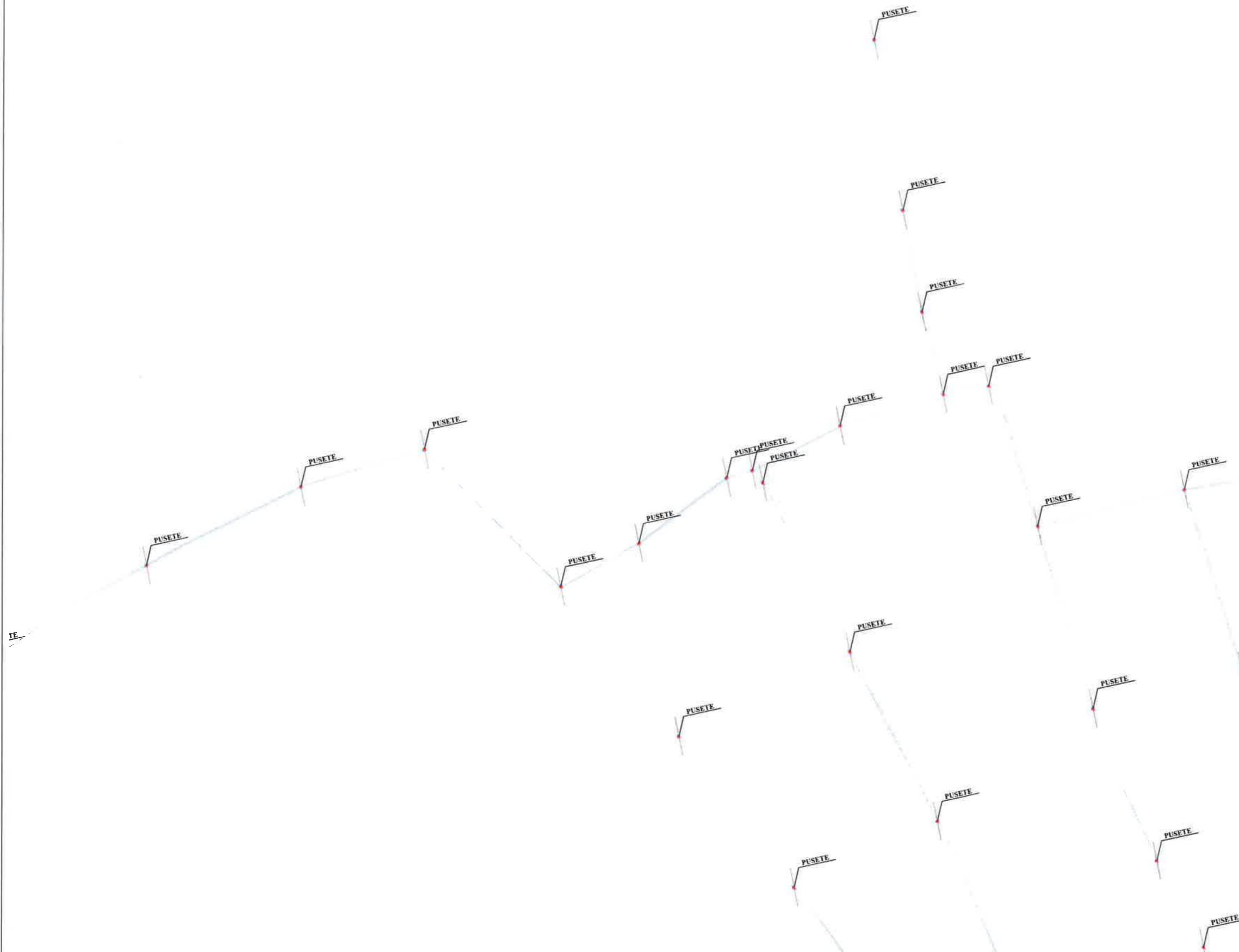

BASHKIA KAMEZ
DREJTORIA E PROJEKTEVE DHE INVESTIMEVE
DEPARTAMENTI I PROJEKTEVE

Dr. e Projekteve e Investimeve FLORA MUÇA
Prgj. e Projekteve EMANUELA MEZIU

STAFI TEKNIK PROJEKTUES	Ing. Konstruktor	DENIS	PRENÇI
	Ing. Gjeoinformatik	ERBLIN	LALA
	Ing. Preventivues	EGLANTINA	DISHA
	Topograf	RAMADAN	HYSA

Titulli i Projektit:
"Ndertimi i rrjetit te kanalizimeve te ujrave te zeza te lagjeve perreth ujembledhesit te Paskuqanit dhe ndertimi i vazhdimit te Rruges "Ali Demi"

Emerrimi i Fletes:
RRJETI K.U.N TE LAGJEVE PERRETH UJEMBLEDHESIT SE LIQENIT TE PASKUQANIT

Faza e Projektit:
PROJEKT ZBATIMI

Data e Implimentimit:

Shkalla e Vizatimit: 1:1000

Plota Nr.:
S-06

Objekti: "Ndertimi i rrjetit te kanalizimeve te ujrave te zeza te lagjeve perreth ujembledhesit te Paskuqanit dhe ndertimi i vazhdimit te Rruges "Ali Demi"

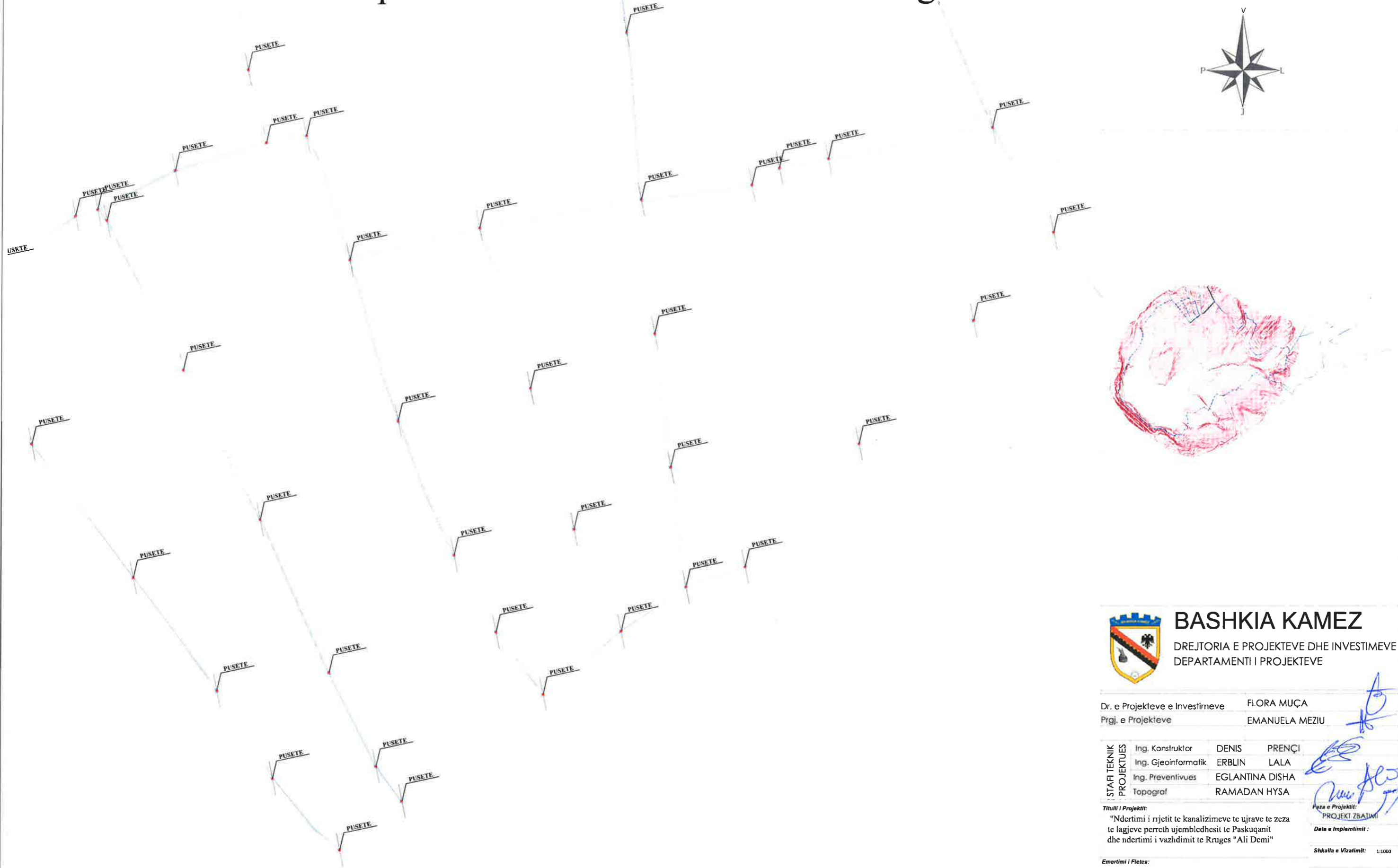

 **BASHKIA KAMEZ**
DREJTORIA E PROJEKTEVE DHE INVESTIMEVE
DEPARTAMENTI I PROJEKTEVE

Dr. e Projekteve e Investimeve FLORA MUÇA
Prgj. e Projekteve EMANUELA MEZIU

STAFI TEKNIK PROJEKTES	Ing. Konstruktor	DENIS	PRENÇI
	Ing. Gjeoinformatik	ERBLIN	LALA
	Ing. Preventivues	EGLANTINA	DISHA
	Topograf	RAMADAN	HYSA

Titulli i Projektit:
"Ndertimi i rrjetit te kanalizimeve te ujrave te zeza te lagjeve perreth ujembledhesit te Paskuqanit dhe ndertimi i vazhdimit te Rruges "Ali Demi"
Paiza e Projektit:
PROJEKTI ZBATIMI
Data e Implementimit:

Emertimi i Fletes:
RRJETI K.U.N TE LAGJEVE PERRETH
UJEMBLEDHESIT SE LIQENIT TE PASKUQANIT
Shkalla e Vizatimit: 1:5000

Fleta Nr.
S-07

Objekti: "Ndertimi i rrjetit te kanalizimeve te ujrave te zeza te lagjeve perreth ujembledhesit te Paskuqanit dhe ndertimi i vazhdimit te Rruges "Ali Demi"

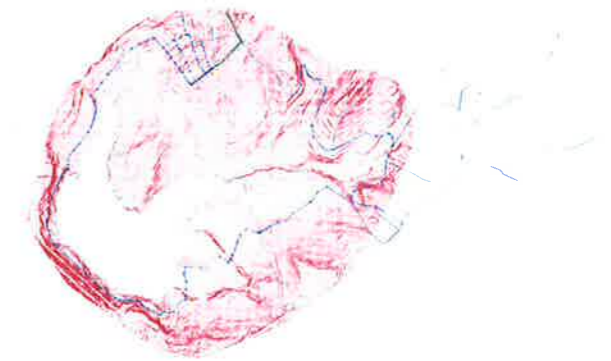
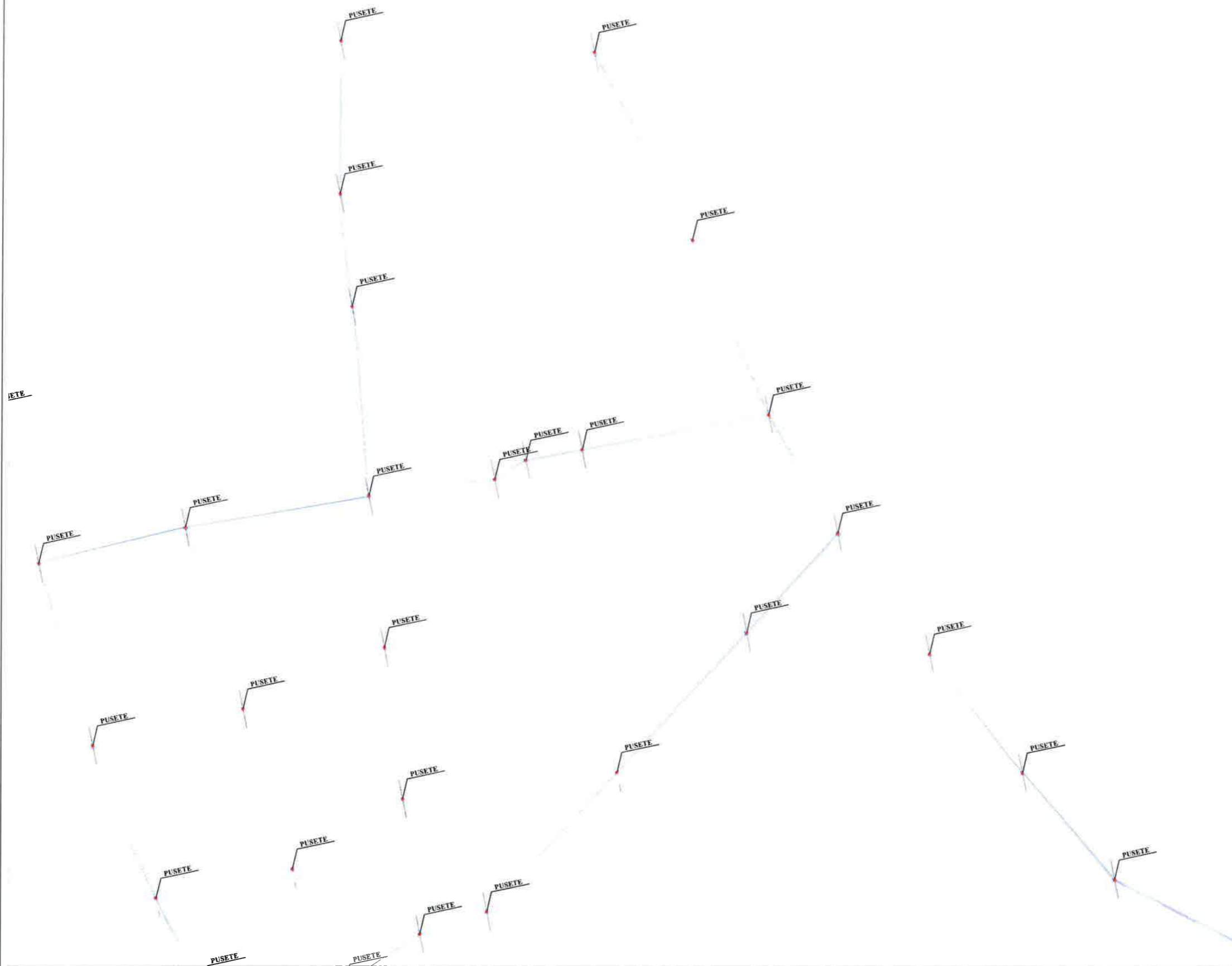

BASHKIA KAMEZ

DREJTORIA E PROJEKTEVE DHE INVESTIMEVE
DEPARTAMENTI I PROJEKTEVE

Dr. e Projekteve e Investimeve FLORA MUÇA
Prgj. e Projekteve EMANUELA MEZIU

STAFI TEKNIK PROJEKTES	Ing. Konstruktor	DENIS	PRENÇI
	Ing. Gjeoinformatik	ERBLIN	LALA
	Ing. Preventivues	EGLANTINA	DISHA
	Topograf	RAMADAN	HYSA

Titulli i Projektit:
"Ndertimi i rrjetit te kanalizimeve te ujrave te zcra te lagjeve perreth ujembledhesit te Paskuqanit dhe ndertimi i vazhdimit te Rruges "Ali Demi"

Faza e Projektit:
PROJEKT ZBATIMI

Data e Implementimit:

Shkalla e Vizatimit: 1:1000

Emertimi i Fletes:

RRJETI I K.U.N TE LAGJEVE PERRETH
UJEMBLEDHESIT SE LIQENIT TE PASKUQANIT

Fleta Nr.

S-08

Objekti: "Ndertimi i rrjetit te kanalizimeve te ujrave te zeza te lagjeve perreth ujembledhesit te Paskuqanit dhe ndertimi i vazhdimit te Rruges "Ali Demi"

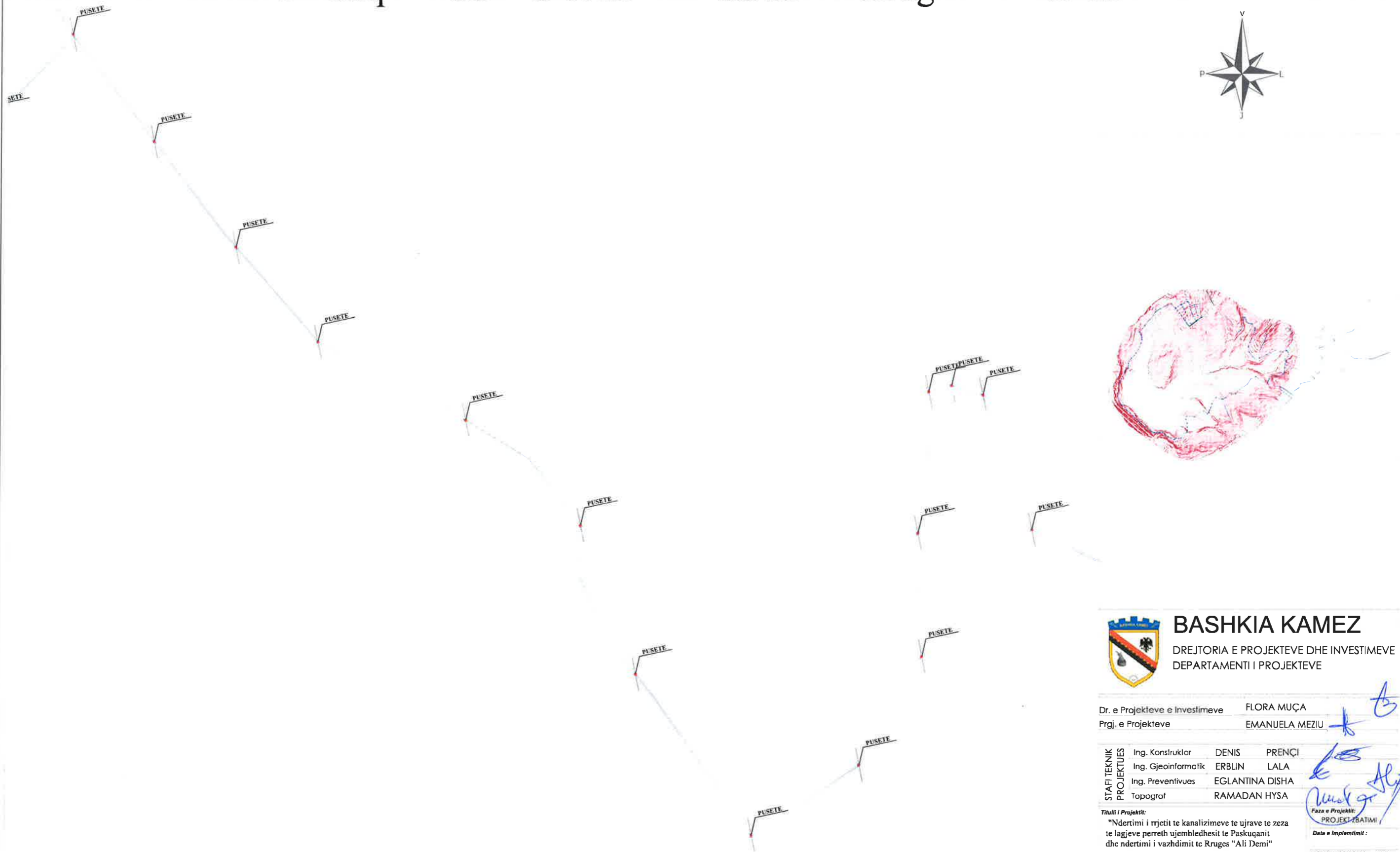

BASHKIA KAMEZ
DREJTORIA E PROJEKTEVE DHE INVESTIMEVE
DEPARTAMENTI I PROJEKTEVE

Dr. e Projekteve e Investimeve FLORA MUÇA
Prqj. e Projekteve EMANUELA MEZIU

STAFI TEKNIK PROJEKTUES	Ing. Konstruktor	DENIS	PRENÇI
	Ing. Gjeoinformatik	ERBLIN	LALA
	Ing. Preventivues	EGLANTINA	DISHA
	Topograf	RAMADAN	HYSA

Titulli i Projektit:
"Ndertimi i rrjetit te kanalizimeve te ujrave te zeza te lagjeve perreth ujembledhesit te Paskuqanit dhe ndertimi i vazhdimit te Rruges "Ali Demi"
Faza e Projektit:
PROJEKT-IBATIMI

Emertimi i Foles:
RRJETI K.U.N TE LAGJEVE PERRETH UJEMBLEDHESIT SE LIQENIT TE PASKUQANIT
Data e Implementimit:
Shkalla e Vizimit: 1:1000
Fleta Nr.
S-09

Objekti: "Ndertimi i rrjetit te kanalizimeve te ujrave te zeza te lagjeve perreth ujembledhesit te Paskuqanit dhe ndertimi i vazhdimit te Rruges "Ali Demi"

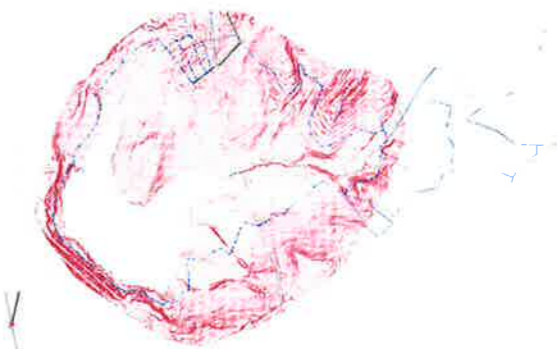
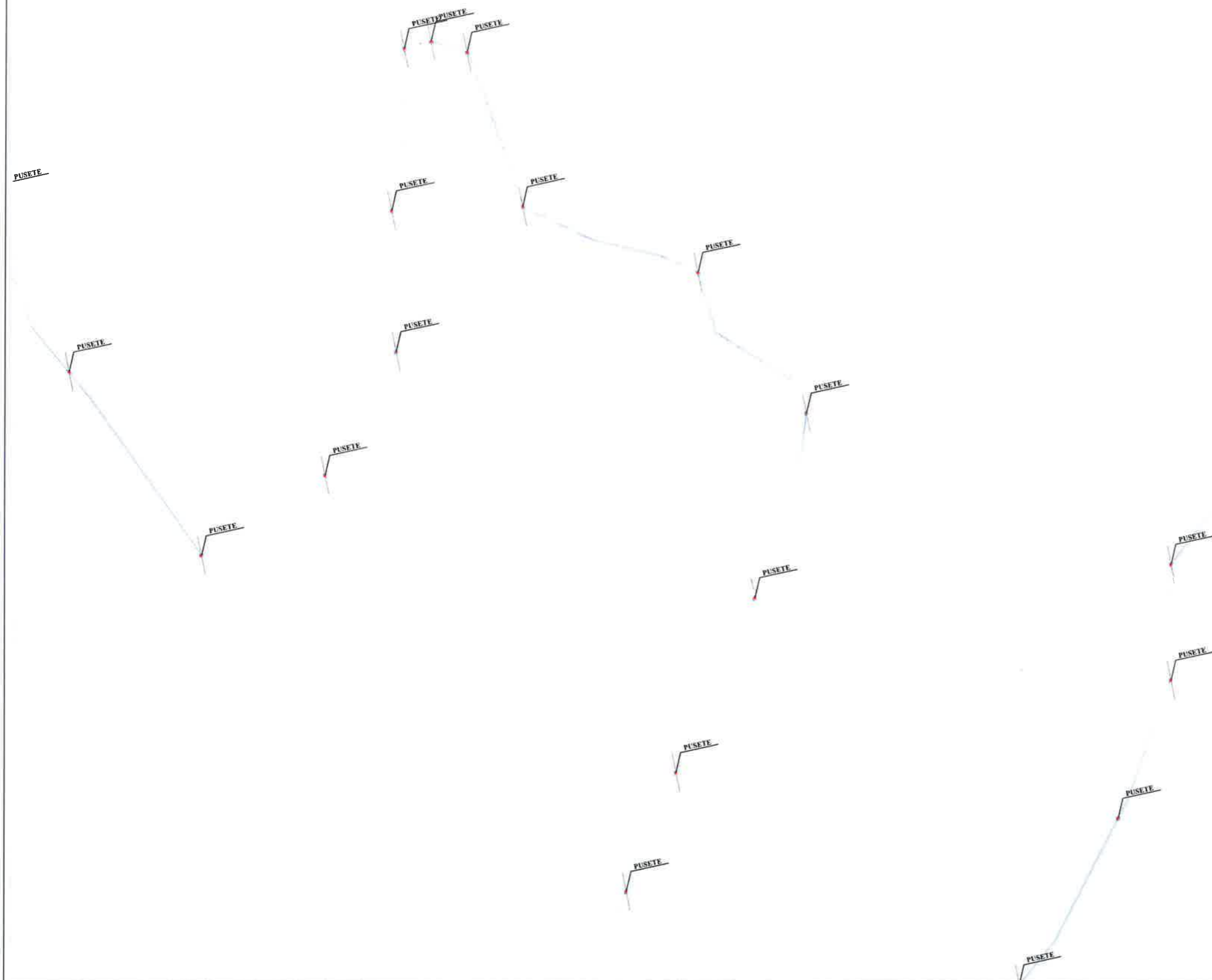

BASHKIA KAMEZ
 DREJTORIA E PROJEKTEVE DHE INVESTIMEVE
 DEPARTAMENTI I PROJEKTEVE

Dr. e Projekteve e Investimeve	FLORA MUÇA
Prgj. e Projekteve	EMANUELA MEZIU
STAFI TEKNIK PROJEKTORES	Ing. Konstruktor DENIS PRENÇI
	Ing. Gjeoinformatik ERBLIN LALA
	Ing. Preventivues EGLANTINA DISHA
	Topograf RAMADAN HYSA

Titulli i Projektit:
 "Ndertimi i rrjetit te kanalizimeve te ujrave te zeza te lagjeve perreth ujembledhesit te Paskuqanit dhe ndertimi i vazhdimit te Rruges "Ali Demi"
Faza e Projektit:
 PROJEKLIBATIMI
Date e Implementimit:

Emertimi i Fildes:
 RRJETI K.U.N TE LAGJEVE PERRETH UJEMBLEDHESIT SE LIQENIT TE PASKUQANIT
Shkalla e Vizatimit: 1:1000
Fila Nr.
S-10

Objekti: "Ndertimi i rrjetit te kanalizimeve te ujrave te zeza te lagjeve perreth ujembledhesit te Paskuqanit dhe ndertimi i vazhdimit te Rruges "Ali Demi"

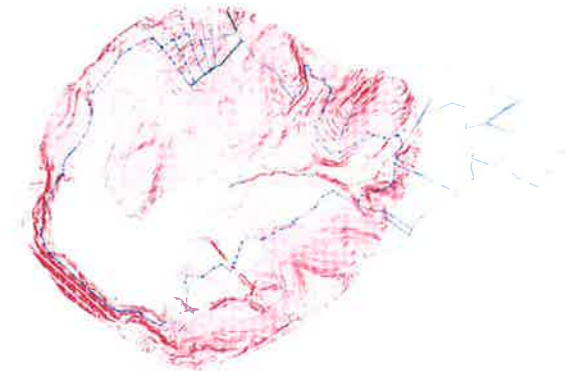
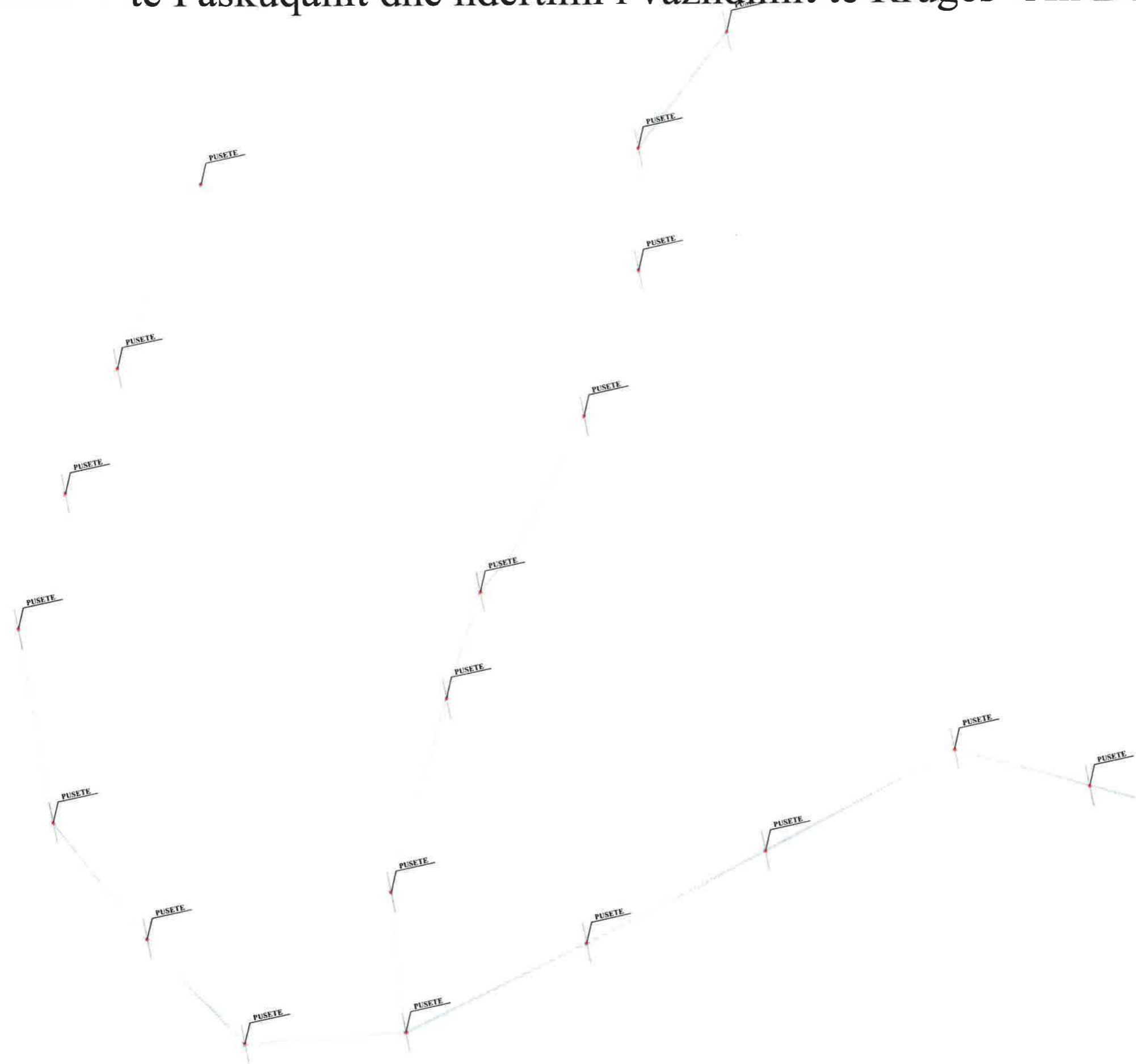
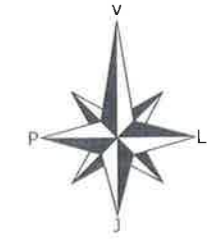

BASHKIA KAMEZ

DREJTORIA E PROJEKTEVE DHE INVESTIMEVE
DEPARTAMENTI I PROJEKTEVE

Dr. e Projekteve e Investimeve FLORA MUÇA
Prgj. e Projekteve EMANUELA MEZIU

STAFI TEKNIK
PROJEKTUES
Ing. Konstruktor DENIS PRENÇI
Ing. Gjeoinformatik ERBLIN LALA
Ing. Preventivues EGLANTINA DISHA
Topograf RAMADAN HYSA

Titulli i Projektit:
"Ndertimi i rrjetit te kanalizimeve te ujrave te zeza te lagjeve perreth ujembledhesit te Paskuqanit dhe ndertimi i vazhdimit te Rruges "Ali Demi"

Emertimi i Fletes:
RRJETI K.U.N TE LAGJEVE PERRETH UJEMBLEDHESIT SE LIQENIT TE PASKUQANIT

Faza e Projektit:
PROJEKT ZBATIMI
Data e Implementimit:

Shkalla e Vizatimit: 1:1000

Fleta Nr.
S-11

Objekti: "Ndertimi i rrjetit te kanalizimeve te ujrave te zeza te lagjeve perreth ujembledhesit te Paskuqanit dhe ndertimi i vazhdimit te Rruges "Ali Demi"

SETE

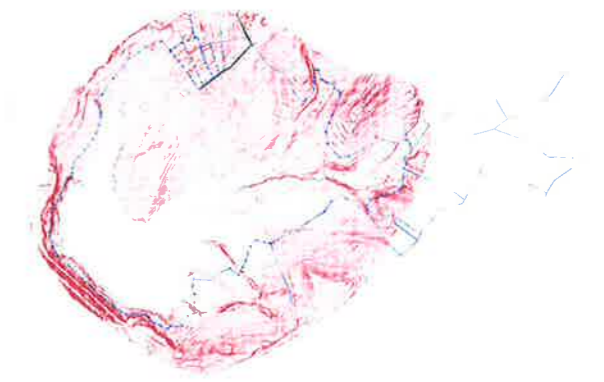
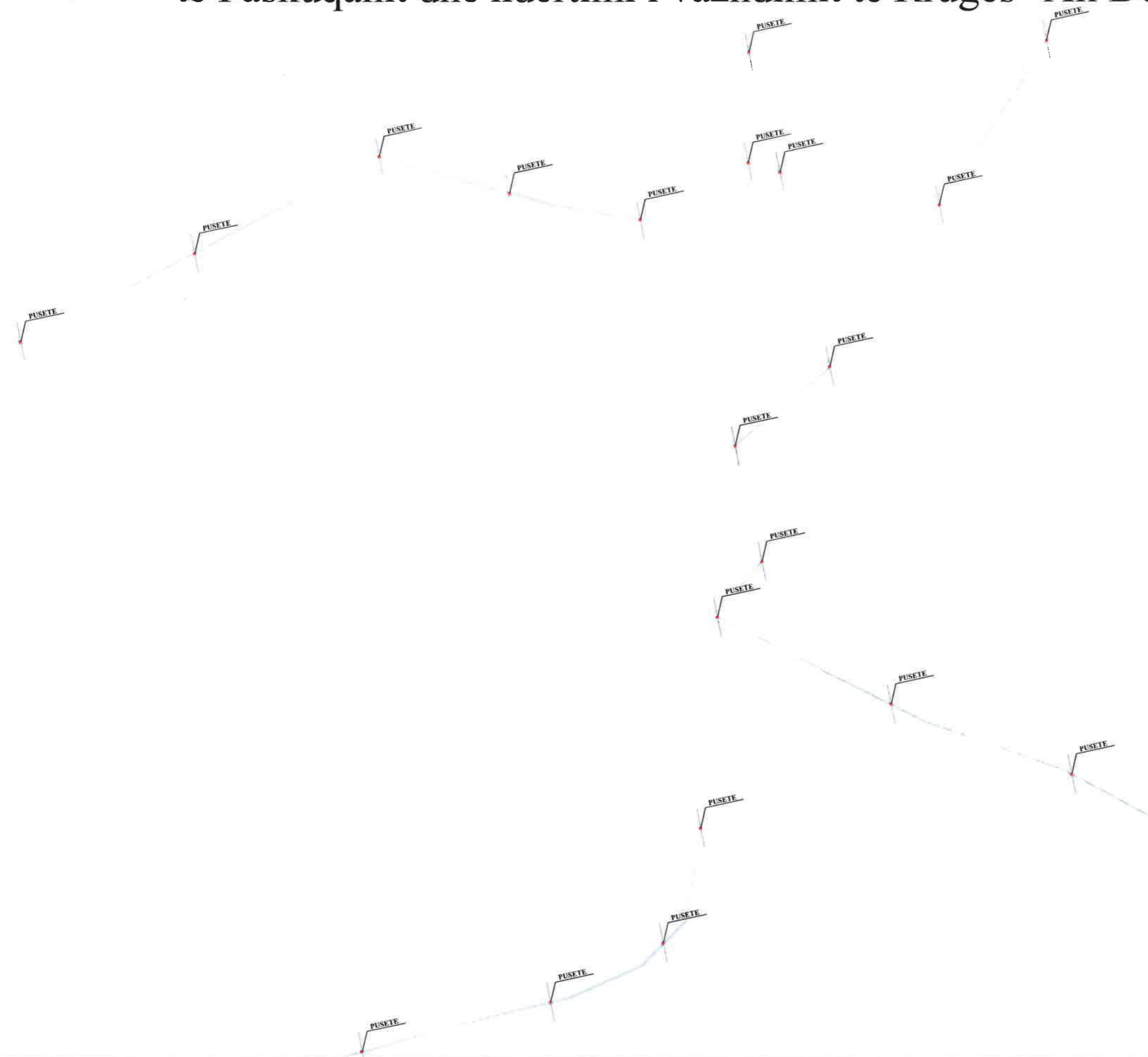
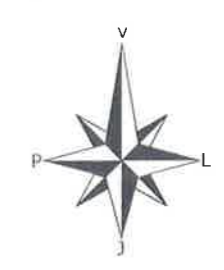

BASHKIA KAMEZ
 DREJTORIA E PROJEKTEVE DHE INVESTIMEVE
 DEPARTAMENTI I PROJEKTEVE

Dr. e Projekteve e Investimeve	FLORA MUÇA
Prgj. e Projekteve	EMANUELA MEZIU
STAFI TEKNIK PROJEKTUES	Ing. Konstruktor DENIS PRENÇI Ing. Gjeoinformatik ERBLIN LALA Ing. Preventivues EGLANTINA DISHA Topograf RAMADAN HYSA
Titulli i Projektit:	"Ndertimi i rrjetit te kanalizimeve te ujrave te zeza te lagjeve perreth ujembledhesit te Paskuqanit dhe ndertimi i vazhdimit te Rruges "Ali Demi"
Faza e Projektit:	PROJEKTI ZBATIMI
Data e Implementimit:	
Shkalla e Vizatimit:	1:1000
Emertimi i Fletes:	RRJETI K.U.N TE LAGJEVE PERRETH UJEMBLEDHESIT SE LIQENIT TE PASKUQANIT
Flota Nr.	S-12

Objekti: "Ndertimi i rrjetit te kanalizimeve te ujrave te zeza te lagjeve perreth ujembledhesit te Paskuqanit dhe ndertimi i vazhdimit te Rruges "Ali Demi"

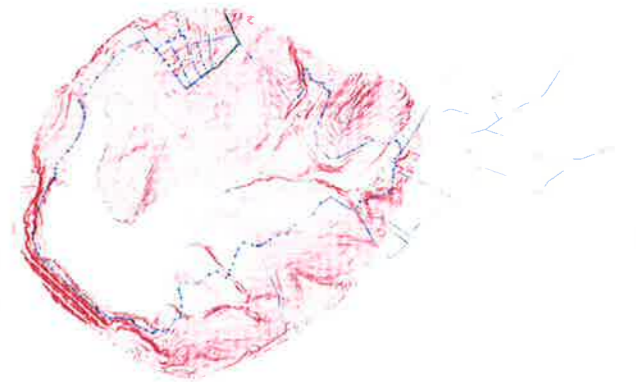
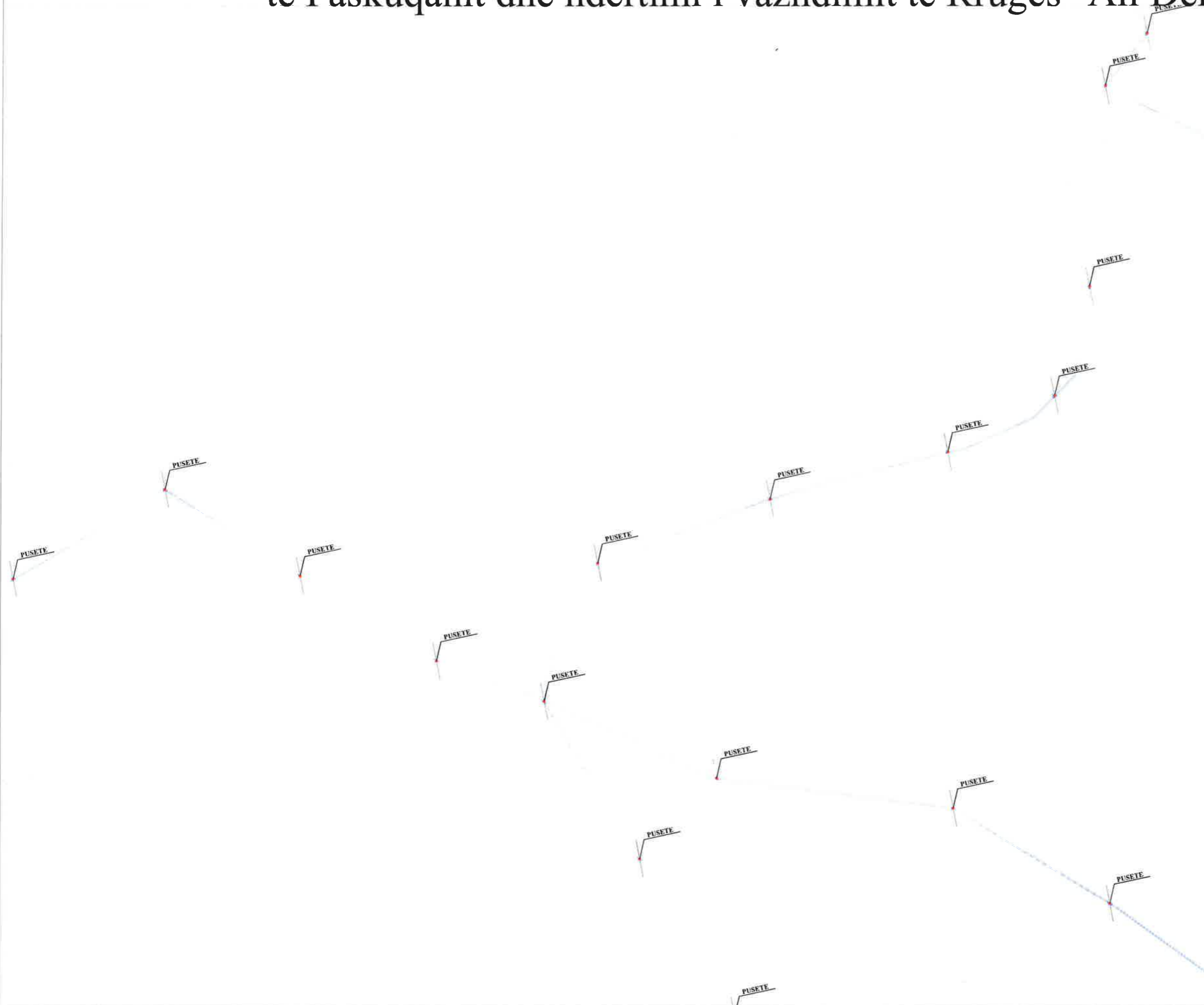

BASHKIA KAMEZ
DREJTORIA E PROJEKTEVE DHE INVESTIMEVE
DEPARTAMENTI I PROJEKTEVE

Dr. e Projekteve e Investimeve	FLORA MUÇA		
Prgj. e Projekteve	EMANUELA MEZIU		
STAFI TEKNIK PROJEKTES	Ing. Konstruktor	DENIS	PRENÇI
	Ing. Gjeoinformatik	ERBLIN	LALA
	Ing. Preventivues	EGLANTINA	DISHA
	Topograf	RAMADAN	HYSA
Titulli i Projektit:	"Ndertimi i rrjetit te kanalizimeve te ujrave te zeza te lagjeve perreth ujembledhesit te Paskuqanit dhe ndertimi i vazhdimit te Rruges "Ali Demi"		
Emertimi i Fletes:	RRJETI K.U.N TE LAGJEVE PERRETH UJEMBLEDHESIT SE LIQENIT TE PASKUQANIT		
Faza e Projektit:	PROJEKT ZBATIMI		
Data e Implementimit:			
Shkalla e Vizatimit:	1:1000		
Fleta Nr.	S-13		

Objekti: "Ndertimi i rrjetit te kanalizimeve te ujrave te zeza te lagjeve perreth ujembledhesit te Paskuqanit dhe ndertimi i vazhdimit te Rruges "Ali Demi"

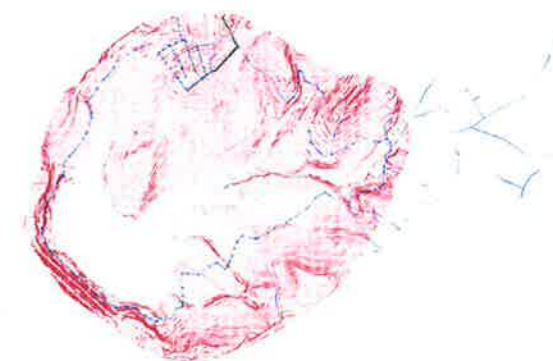

BASHKIA KAMEZ

DREJTORIA E PROJEKTEVE DHE INVESTIMEVE
DEPARTAMENTI I PROJEKTEVE

Dr. e Projekteve e Investimeve FLORA MUÇA
Prgj. e Projekteve EMANUELA MEZIU

STAFI TEKNIK PROJEKTUES	Ing. Konstruktor	DENIS	PRENÇI
	Ing. Gjeoinformatik	ERBLIN	LALA
	Ing. Preventivues	EGLANTINA	DISHA
	Topograf	RAMADAN	HYSA

Titulli i Projektit:
"Ndertimi i rrjetit te kanalizimeve te ujrave te zeza te lagjeve perreth ujembledhesit te Paskuqanit dhe ndertimi i vazhdimit te Rruges "Ali Demi"

Faza e Projektit:
PROJEKTI-ZBATIMI

Data e Implementimit:

Shkalla e Vizimit: 1:1000

Emertimi i Flotes:

RRJETI I K.U.N TE LAGJEVE PERRETH
UJEMBLEDHESIT SE LIQENIT TE PASKUQANIT

Flota Nr.

S-14

Objekti: "Ndertimi i rrjetit te kanalizimeve te ujrave te zeza te lagjeve perreth ujembledhesit te Paskuqanit dhe ndertimi i vazhdimit te Rruges "Ali Demi"

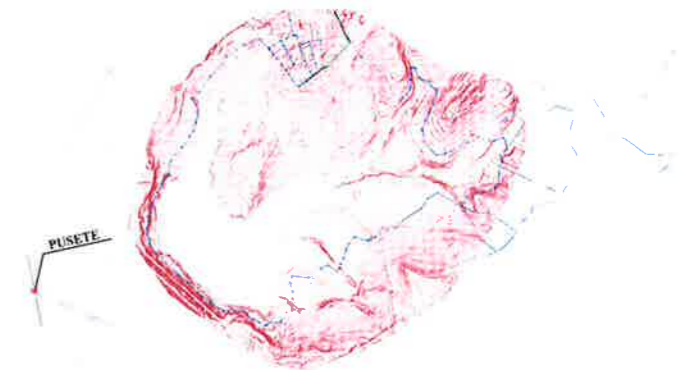
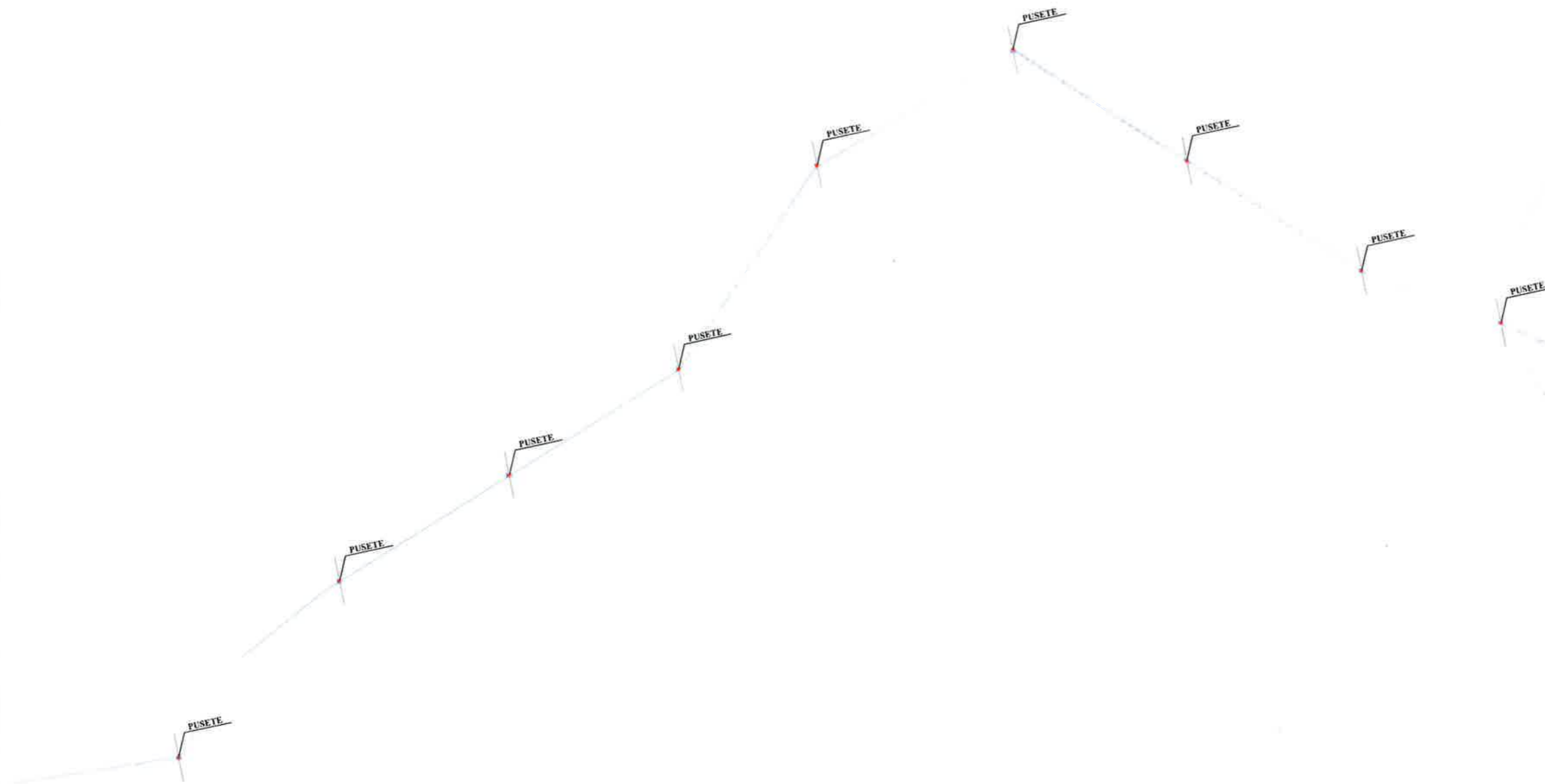

BASHKIA KAMEZ

DREJTORIA E PROJEKTEVE DHE INVESTIMEVE
DEPARTAMENTI I PROJEKTEVE

Dr. e Projekteve e Investimeve FLORA MUÇA
Prgj. e Projekteve EMANUELA MEZIU

STAFI TEKNIK PROJEKTUES	Ing. Konstruktore	DENIS	PRENÇI
	Ing. Gjeoinformatik	ERBLIN	LALA
	Ing. Preventivues	EGLANTINA	DISHA
	Topograf	RAMADAN	HYSA

Titulli i Projektit:
"Ndertimi i rrjetit te kanalizimeve te ujrave te zeza te lagjeve perreth ujembledhesit te Paskuqanit dhe ndertimi i vazhdimit te Rruges "Ali Demi"

Faza e Projektit:
PROJEKT ZBATIMI

Data e Implementimit:

Shkalla e Vizatimit: 1:1000

Emerlimi i Fletes:

RRJETI K.U.N TE LAGJEVE PERRETH
UJEMBLEDHESIT SE LIQENIT TE PASKUQANIT

Fleta Nr.

S-15

Objekti: "Ndertimi i rrjetit te kanalizimeve te ujrave te zeza te lagjeve perreth ujembledhesit te Paskuqanit dhe ndertimi i vazhdimit te Rruges "Ali Demi"

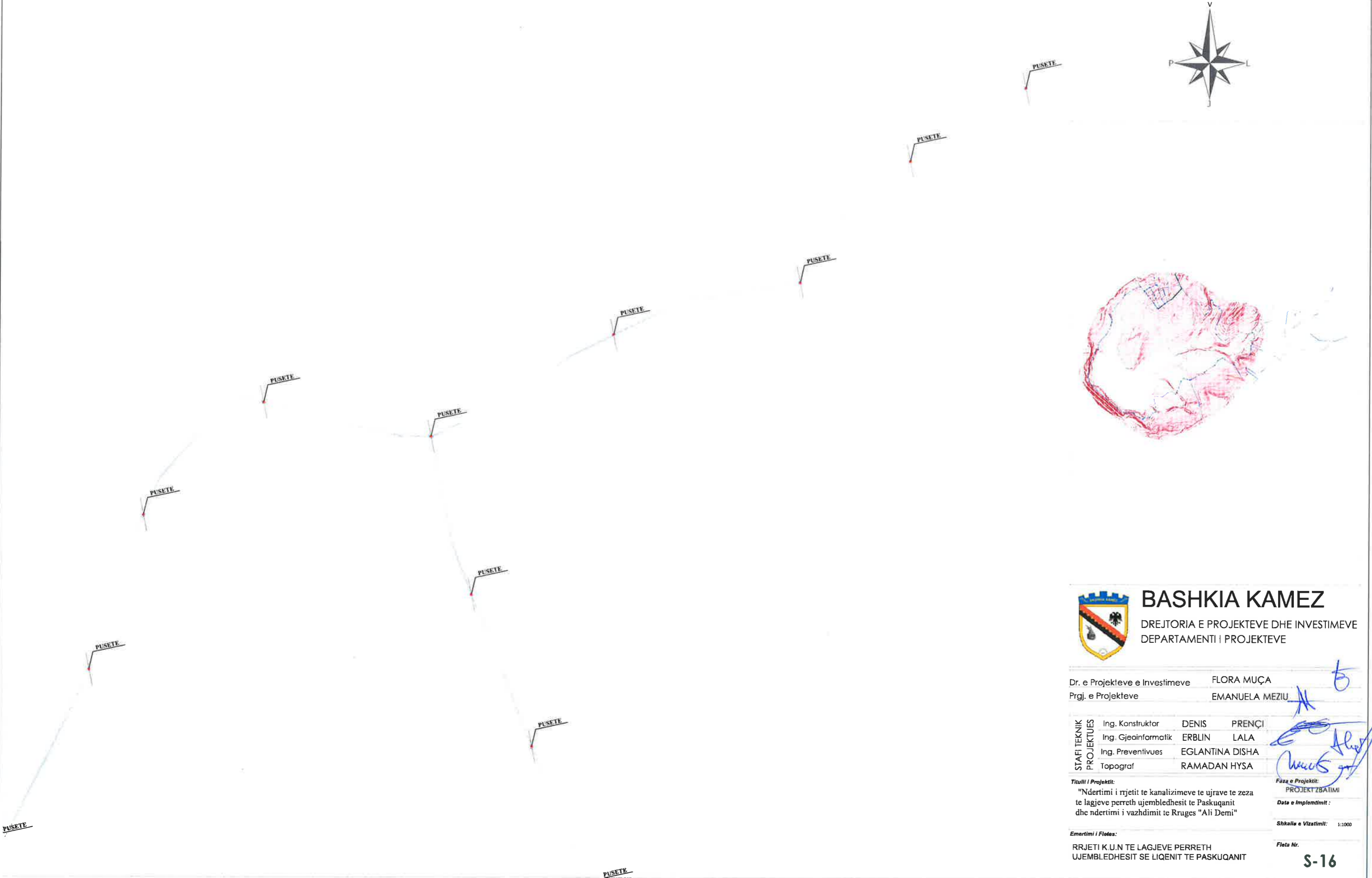

BASHKIA KAMEZ
 DREJTORIA E PROJEKTEVE DHE INVESTIMEVE
 DEPARTAMENTI I PROJEKTEVE

Dr. e Projekteve e Investimeve FLORA MUÇA
 Prgj. e Projekteve EMANUELA MEZIU

STAFI TEKNIK PROJEKTUES	Ing. Konstruktor	DENIS	PRENÇI
	Ing. Gjeoinformatik	ERBLIN	LALA
	Ing. Preventivues	EGLANTINA	DISHA
	Topograf	RAMADAN	HYSA

Titulli i Projektit:
 "Ndertimi i rrjetit te kanalizimeve te ujrave te zeza te lagjeve perreth ujembledhesit te Paskuqanit dhe ndertimi i vazhdimit te Rruges "Ali Demi"

Faza e Projektit:
 PROJEKT ZBATIMI

Data e Implementimit:

Shkalla e Vizatimit: 1:1000

Emertimi i Flotas:
 RRJETI K.U.N TE LAGJEVE PERRETH
 UJEMBLEDHESIT SE LIQENIT TE PASKUQANIT

(Handwritten signatures and initials)

Objekti: "Ndertimi i rrjetit te kanalizimeve te ujrave te zeza te lagjeve perreth ujembledhesit te Paskuqanit dhe ndertimi i vazhdimit te Rruges "Ali Demi"



1E

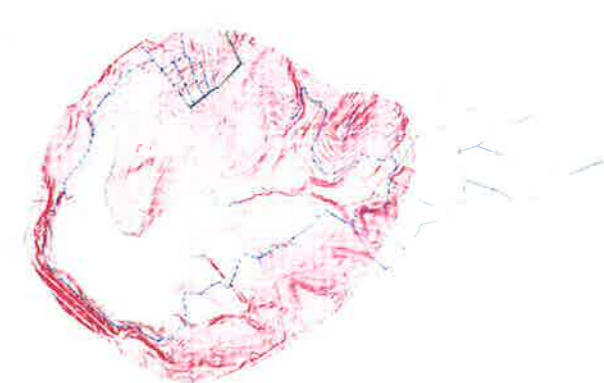
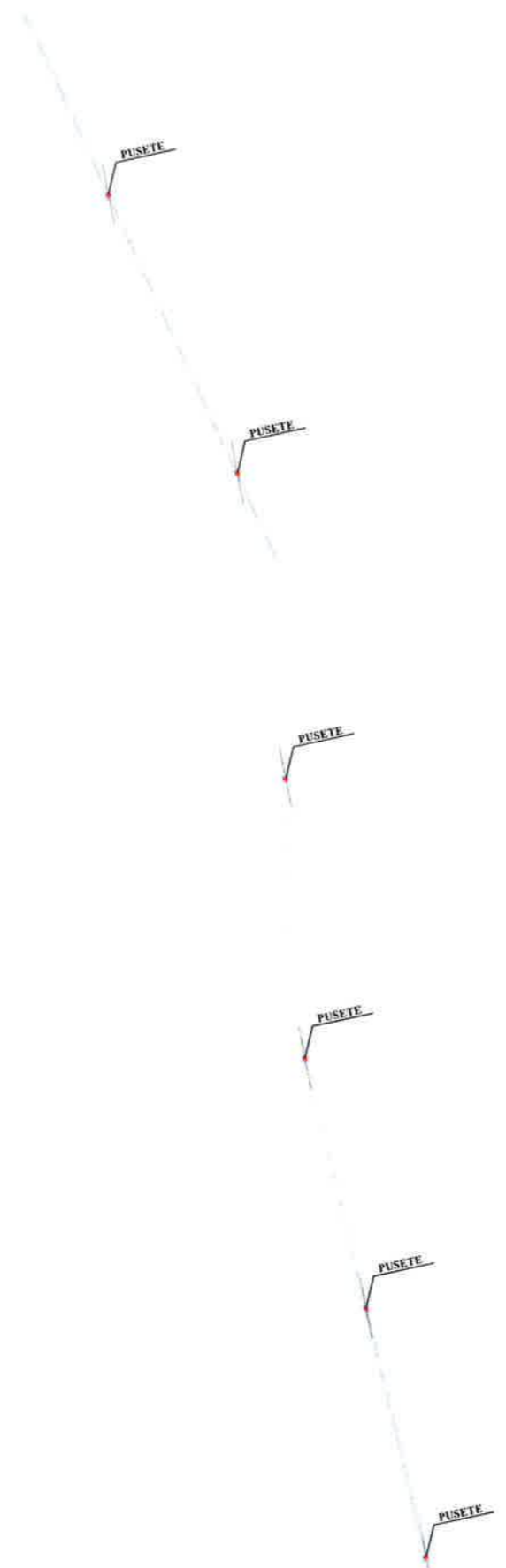

BASHKIA KAMEZ
DREJTORIA E PROJEKTEVE DHE INVESTIMEVE
DEPARTAMENTI I PROJEKTEVE

Dr. e Projekteve e Investimeve FLORA MUÇA
Prgj. e Projekteve EMANUELA MEZIU

STAFI TEKNIK PROJEKTES	Ing. Konstruktor	DENIS	PRENÇI
	Ing. Gjeoinformatik	ERBLIN	LALA
	Ing. Preventivues	EGLANTINA DISHA	
	Topograf	RAMADAN HYSA	

Titulli i Projektit: "Ndertimi i rrjetit te kanalizimeve te ujrave te zeza te lagjeve perreth ujembledhesit te Paskuqanit dhe ndertimi i vazhdimit te Rruges "Ali Demi"
Faza e Projektit: PROJEKT-ZBATIMI
Data e Implimitimit:

Emartimi i Fletes: RRJETI K.U.N TE LAGJEVE PERRETH UJEMBLEHESIT SE LIQENIT TE PASKUQANIT
Shkalla e Vizatimit: 1:1000

Fleta Nr. S-17

Objekti: "Ndertimi i rrjetit te kanalizimeve te ujrave te zeza te lagjeve perreth ujembledhesit te Paskuqanit dhe ndertimi i vazhdimit te Rruges "Ali Demi"

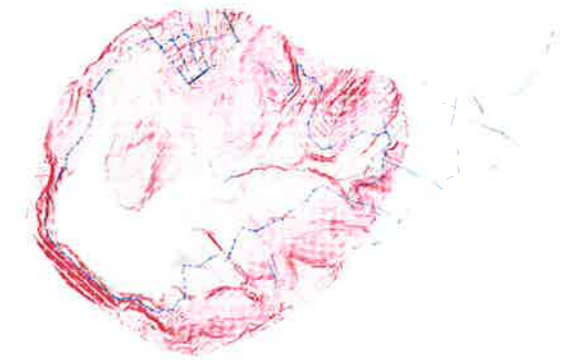
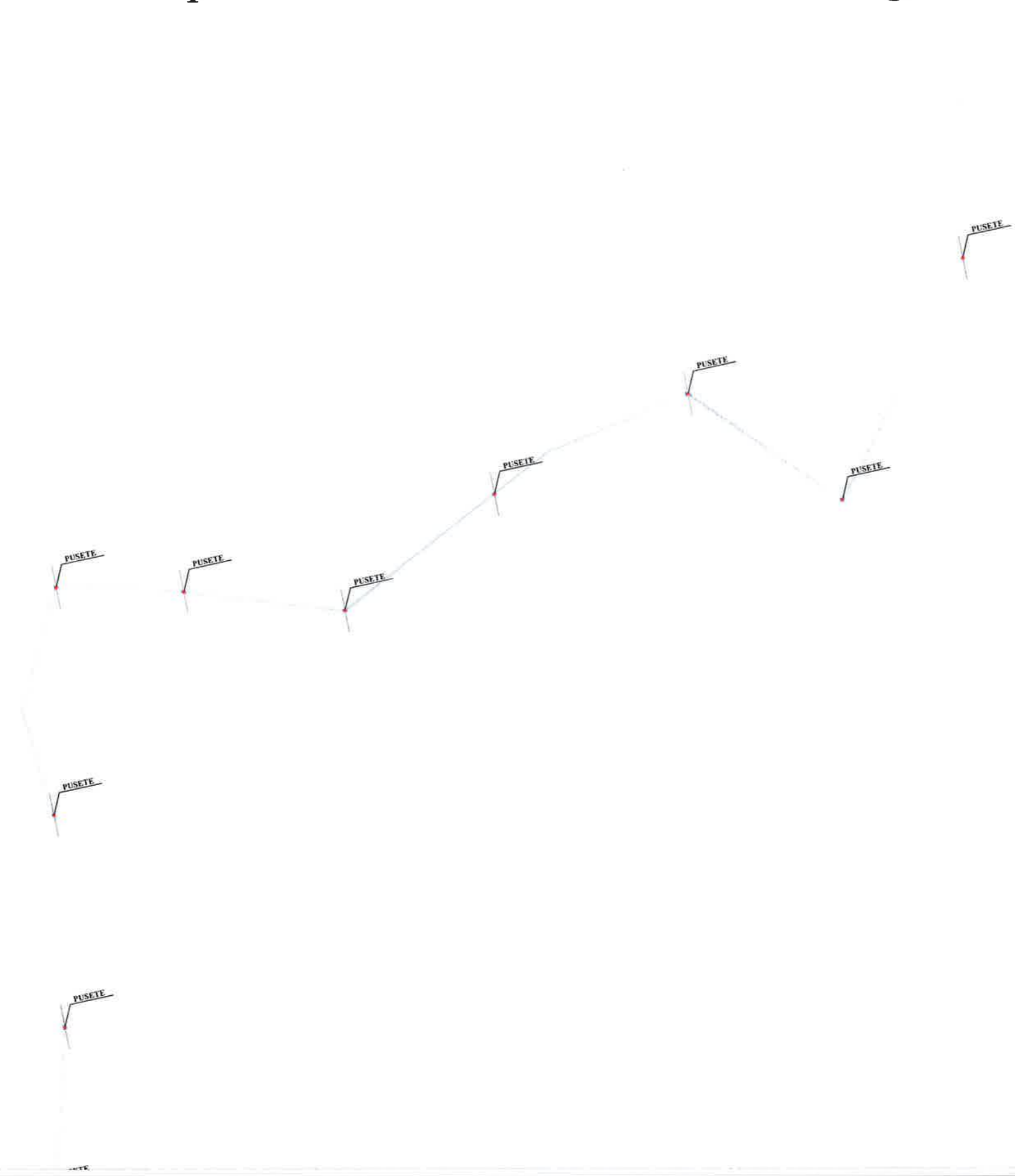

BASHKIA KAMEZ
DREJTORIA E PROJEKTEVE DHE INVESTIMEVE
DEPARTAMENTI I PROJEKTEVE

Dr. e Projekteve e Investimeve FLORA MUÇA
Prgj. e Projekteve EMANUELA MEZIU

STAFI TEKNIK PROJEKTUES	Ing. Konstruktor	DENIS	PRENÇI
	Ing. Gjeoinformatik	ERBLIN	LALA
	Ing. Preventivues	EGLANTINA DISHA	
	Topograf	RAMADAN HYSA	

Titulli i Projektit:
"Ndertimi i rrjetit te kanalizimeve te ujrave te zeza te lagjeve perreth ujembledhesit te Paskuqanit dhe ndertimi i vazhdimit te Rruges "Ali Demi"

Faza e Projektit:
PROJEKT ZBATIMI

Data e Implementimit:

Shkalla e Vizatimit: 1:1000

Emertimi i Fletes:
RRJETI K.U.N TE LAGJEVE PERRETH UJEMBLEDHESIT SE LIQENIT TE PASKUQANIT

Fleta Nr.:
S-18

Objekti: "Ndertimi i rrjetit te kanalizimeve te ujrave te zeza te lagjeve perreth ujembledhesit te Paskuqanit dhe ndertimi i vazhdimit te Rruges "Ali Demi"

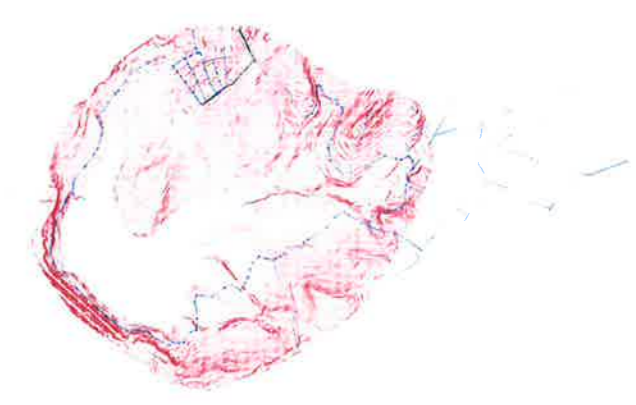
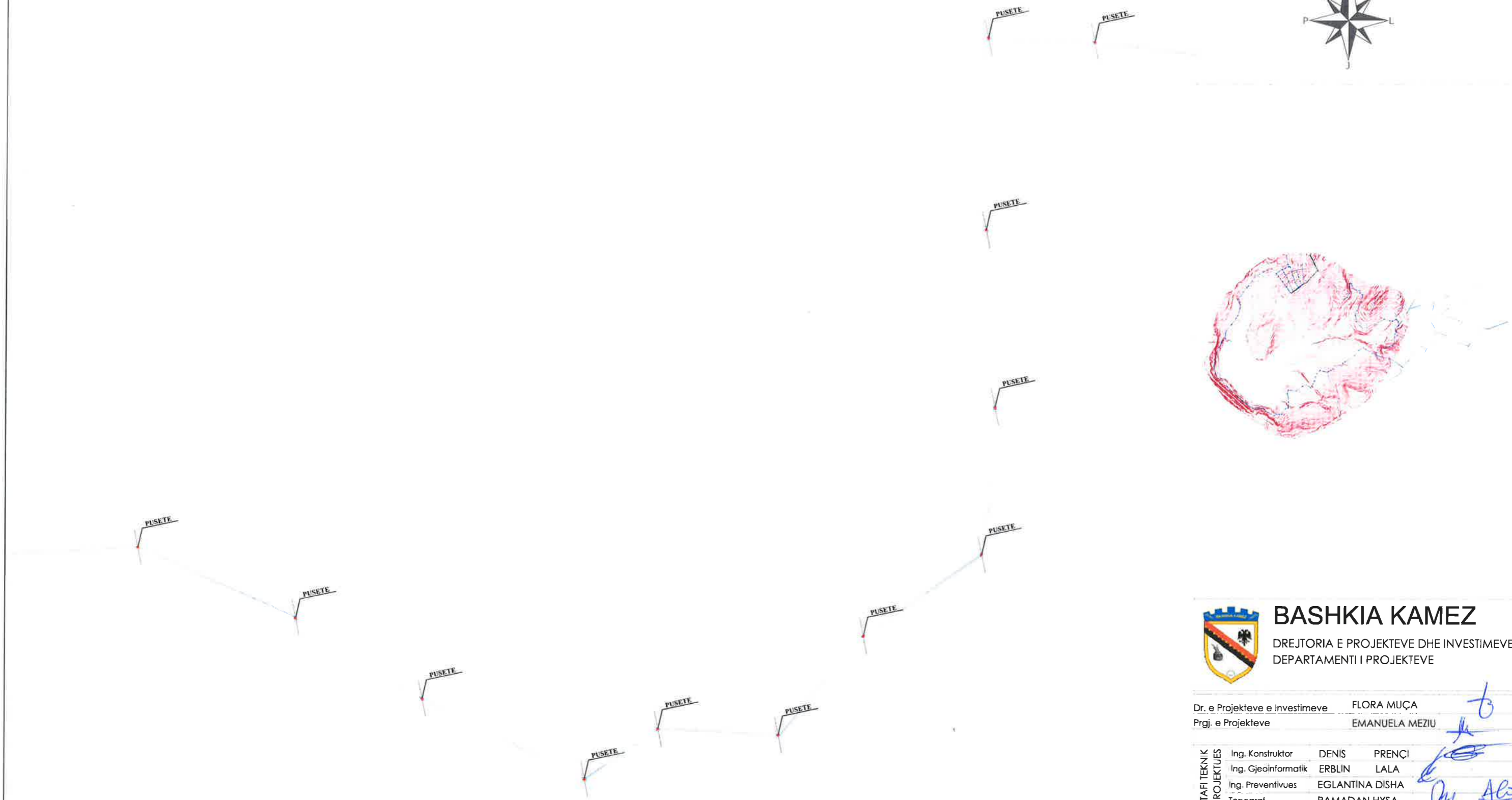

BASHKIA KAMEZ
 DREJTORIA E PROJEKTEVE DHE INVESTIMEVE
 DEPARTAMENTI I PROJEKTEVE

Dr. e Projekteve e Investimeve	FLORA MUÇA
Prgj. e Projekteve	EMANUELA MEZIU
STAFI TEKNIK	Ing. Konstruktor DENIS PRENÇI
PROJEKTUES	Ing. Gjeoinformatik ERBLIN LALA
	Ing. Preventivues EGLANTINA DISHA
	Topograf RAMADAN HYSA

Titulli i Projektit:
 "Ndertimi i rrjetit te kanalizimeve te ujrave te zeza te lagjeve perreth ujembledhesit te Paskuqanit dhe ndertimi i vazhdimit te Rruges "Ali Demi"

Faza e Projektit:
 PROJEKT ZBATIMI

Data e Implementimit:

Shkalla e Vizatimit: 1:1000

Emertimi i Flotes:
 RRJETI K.U.N TE LAGJEVE PERRETH UJEMBLEDHESIT SE LIQENIT TE PASKUQANIT

Flota Nr.:
S-19

Objekti: "Ndertimi i rrjetit te kanalizimeve te ujrave te zeza te lagjeve perreth ujembledhesit te Paskuqanit dhe ndertimi i vazhdimit te Rruges "Ali Demi"

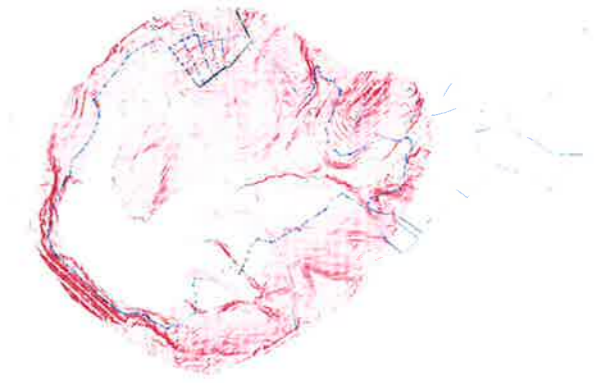

BASHKIA KAMEZ

DREJTORIA E PROJEKTEVE DHE INVESTIMEVE
DEPARTAMENTI I PROJEKTEVE

Dr. e Projekteve e Investimeve	FLORA MUÇA
Prgj. e Projekteve	EMANUELA MEZIU
STAFI TEKNIK	Ing. Konstruktor DENIS PRENÇI
PROJEKTUES	Ing. Gjeoinformatik ERBLIN LALA
	Ing. Preventivues EGLANTINA DISHA
	Topograf RAMADAN HYSA

Titulli i Projektit:
"Ndertimi i rrjetit te kanalizimeve te ujrave te zeza te lagjeve perreth ujembledhesit te Paskuqanit dhe ndertimi i vazhdimit te Rruges "Ali Demi"

Faza e Projektit:
PROJEKT ZBATIMI

Data e Implementimit:

Shkalla e Vizatimit: 1:1000

Emertimi i Fletes:
RRJETI K.U.N TE LAGJEVE PERRETH UJEMBLEDHESIT SE LIQENIT TE PASKUQANIT

Fleta Nr.

S-20

Objekti: "Ndertimi i rrjetit te kanalizimeve te ujrave te zeza te lagjeve perreth ujembledhesit te Paskuqanit dhe ndertimi i vazhdimit te Rrugës "Ali Demi"



BASHKIA KAMEZ

DREJTORIA E PROJEKTEVE DHE INVESTIMEVE
DEPARTAMENTI I PROJEKTEVE

Dr. e Projekteve e Investimeve FLORA MUÇA
Prqj. e Projekteve EMANUELA MEZIU

STAFI TEKNIK
PROJEKTUES
Ing. Konstruktor DENIS PRENÇI
Ing. Gjeoinformatik ERBLIN LALA
Ing. Preventivues EGLANTINA DISHA
Topograf RAMADAN HYSA

Titulli i Projektit:
"Ndertimi i rrjetit te kanalizimeve te ujrave te zeza te lagjeve perreth ujembledhesit te Paskuqanit dhe ndertimi i vazhdimit te Rrugës "Ali Demi"

Emertimi i Fletes:
RRJETI K.U.N TE LAGJEVE PERRETH UJEMBLEDHESIT SE LIQENIT TE PASKUQANIT

Faza e Projektit:
PROJEKT-ZBATIMI

Data e Implementimit:

Shkalla e Vizatimit: 1:1000

Fleta Nr.

S-21

Objekti: "Ndertimi i rrjetit te kanalizimeve te ujrave te zeza te lagjeve perreth ujembledhesit te Paskuqanit dhe ndertimi i vazhdimit te Rruges "Ali Demi"

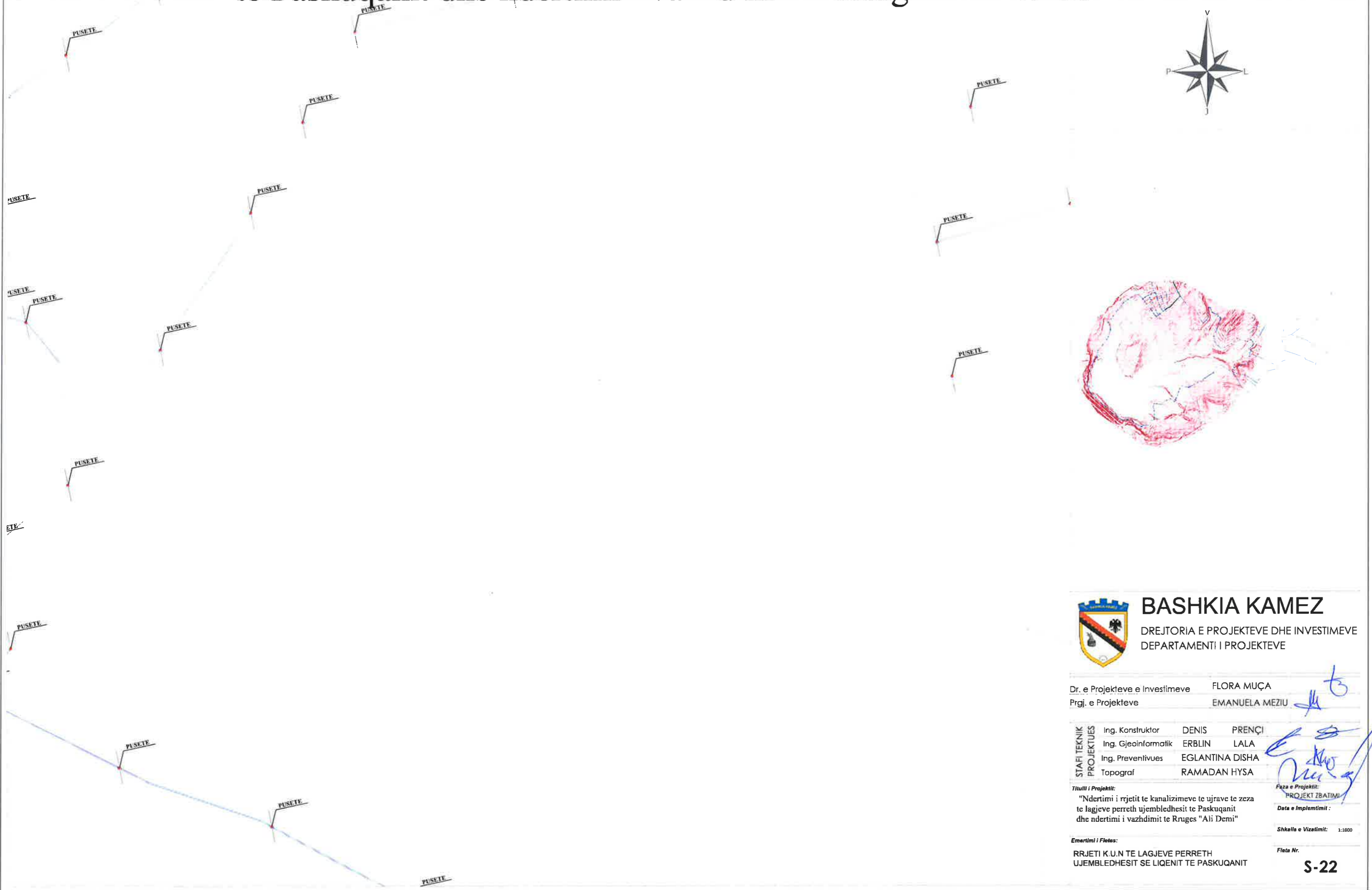

BASHKIA KAMEZ
 DREJTORIA E PROJEKTEVE DHE INVESTIMEVE
 DEPARTAMENTI I PROJEKTEVE

Dr. e Projekteve e Investimeve FLORA MUÇA
 Prgj. e Projekteve EMANUELA MEZIU

STAFI TEKNIK PROJEKTUES	Ing. Konstruktor	DENIS	PRENÇI
	Ing. Gjeoinformatik	ERBLIN	LALA
	Ing. Preventivues	EGLANTINA	DISHA
	Topograf	RAMADAN	HYSA

Titulli i Projektit:
 "Ndertimi i rrjetit te kanalizimeve te ujrave te zeza te lagjeve perreth ujembledhesit te Paskuqanit dhe ndertimi i vazhdimit te Rruges "Ali Demi"

Emertimi i Fletes:
 RRJETI K.U.N TE LAGJEVE PERRETH
 UJEMBLEDHESIT SE LIQENIT TE PASKUQANIT

Faza e Projektit:
 PROJEKTI ZBATIM

Data e Implementimit:

Shkalla e Vizimit: 1:1000

Fleta Nr.:
S-22

Objekti: "Ndertimi i rrjetit te kanalizimeve te ujrave te zeza te lagjeve perreth ujembledhesit te Paskuqanit dhe ndertimi i vazhdimit te Rrugës "Ali Demi"

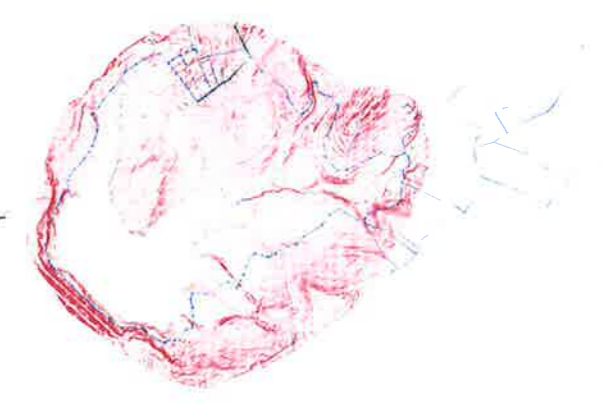
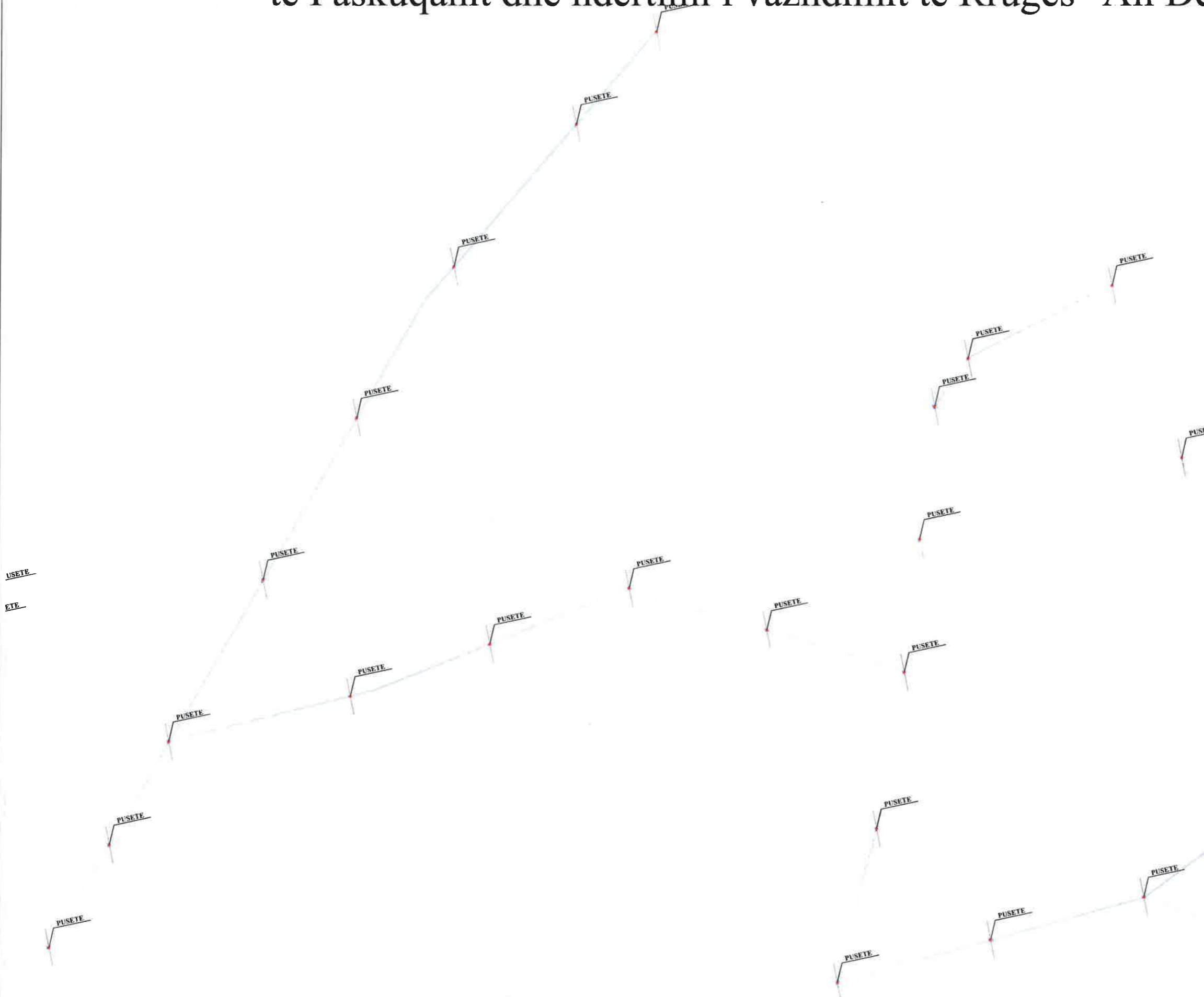
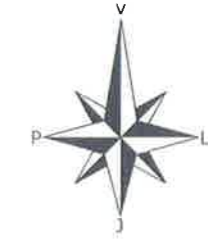

BASHKIA KAMEZ

DREJTORIA E PROJEKTEVE DHE INVESTIMEVE
DEPARTAMENTI I PROJEKTEVE

Dr. e Projekteve e Investimeve FLORA MUÇA
Prgj. e Projekteve EMANUELA MEZIU

STAFI TEKNIK PROJEKTUES	Ing. Konstruktor	DENIS	PRENÇI
	Ing. Gjeoinformatik	ERBLIN	LALA
	Ing. Preventivues	EGLANTINA	DISHA
	Topograf	RAMADAN	HYSA

Titulli i Projektit:
"Ndertimi i rrjetit te kanalizimeve te ujrave te zeza te lagjeve perreth ujembledhesit te Paskuqanit dhe ndertimi i vazhdimit te Rrugës "Ali Demi"

Emertimi i Fletës:
RRJETI K.U.N TE LAGJEVE PERRETH UJEMBLEDHESIT SE LIQENIT TE PASKUQANIT

Faza e Projektit:
PROJEKT ZBATIMI

Data e Implimentimit:

Shkalla e Vizatimit: 1:1000

Fleta Nr.

Objekti: "Ndertimi i rrjetit te kanalizimeve te ujrave te zeza te lagjeve perreth ujembledhesit te Paskuqanit dhe ndertimi i vazhdimit te Rruges "Ali Demi"



BASHKIA KAMEZ
 DREJTORIA E PROJEKTEVE DHE INVESTIMEVE
 DEPARTAMENTI I PROJEKTEVE

Dr. e Projekteve e Investimeve FLORA MUÇA
 Prgj. e Projekteve EMANUELA MEZIU

STAFI TEKNIK
 PROJEKTUES
 Ing. Konstruktor DENIS PRENÇI
 Ing. Gjeoinformatik ERLIN LALA
 Ing. Preventivues EGLANTINA DISHA
 Topograf RAMADAN HYSA

Titulli i Projektit:
 "Ndertimi i rrjetit te kanalizimeve te ujrave te zeza te lagjeve perreth ujembledhesit te Paskuqanit dhe ndertimi i vazhdimit te Rruges "Ali Demi"
Faza e Projektit:
 PROJEKT ZBATIMI
Data e Implementimit:

Shkalla e Vizatimit: 1:1000
Emertimi i Fletes:
 RRJETI K.U.N TE LAGJEVE PERRETH
 UJEMBLEDHESIT SE LIQENIT TE PASKUQANIT
Fleta Nr.
S-24

Objekti: "Ndertimi i rrjetit te kanalizimeve te ujrave te zeza te lagjeve perreth ujembledhesit te Paskuqanit dhe ndertimi i vazhdimit te Rruges "Ali Demi"

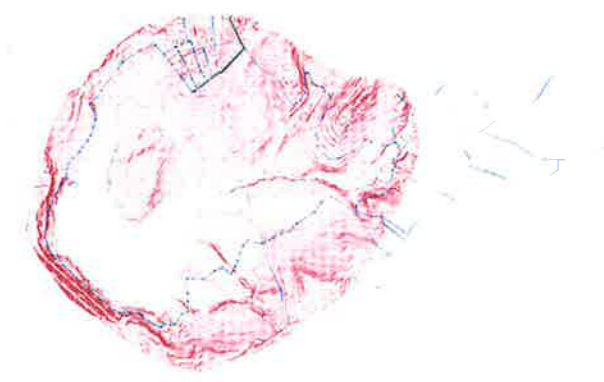
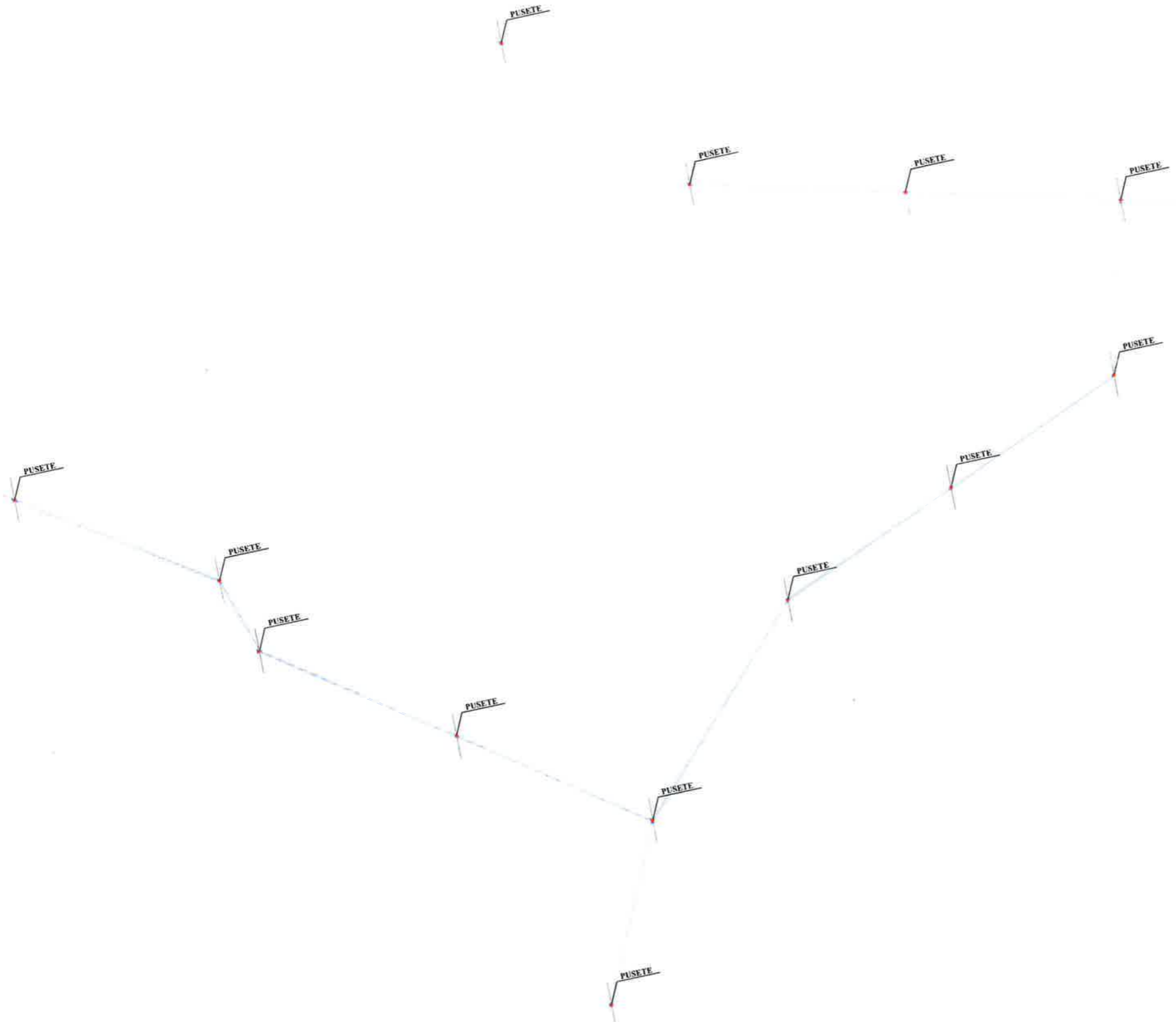

BASHKIA KAMEZ
 DREJTORIA E PROJEKTEVE DHE INVESTIMEVE
 DEPARTAMENTI I PROJEKTEVE

Dr. e Projekteve e Investimeve FLORA MUÇA
 Prgj. e Projekteve EMANUELA MEZIU

STAFI TEKNIK PROJEKTUES	Ing. Konstruktor	DENIS	PRENÇI
	Ing. Gjeoinformatik	ERBLIN	LALA
	Ing. Preventivues	EGLANTINA	DISHA
	Topograf	RAMADAN	HYSA

Titulli i Projektit:
 "Ndertimi i rrjetit te kanalizimeve te ujrave te zeza te lagjeve perreth ujembledhesit te Paskuqanit dhe ndertimi i vazhdimit te Rruges "Ali Demi"

Faza e Projektit:
 PROJEKT ZBATIMOR

Data e Implementimit:

Shkalla e Vizatimit: 1:1000

Emertimi i Flotes:
 RRJETI K.U.N TE LAGJEVE PERRETH
 UJEMBLEDHESIT SE LIQENIT TE PASKUQANIT

Flota Nr.:
S-25

Objekti: "Ndertimi i rrjetit te kanalizimeve te ujrave te zeza te lagjeve perreth ujembledhesit te Paskuqanit dhe ndertimi i vazhdimit te Rruges "Ali Demi"



BASHKIA KAMEZ

DREJTORIA E PROJEKTEVE DHE INVESTIMEVE
DEPARTAMENTI I PROJEKTEVE

Dr. e Projekteve e Investimeve FLORA MUÇA
Prgj. e Projekteve EMANUELA MEZIU

STAFI TEKNIK PROJEKTUES	Ing. Konstruktor	DENIS	PRENÇI
	Ing. Gjeoinformatik	ERBLIN	LALA
	Ing. Preventivues	EGLANTINA	DISHA
	Topograf	RAMADAN	HYSA

Titulli i Projektit:
"Ndertimi i rrjetit te kanalizimeve te ujrave te zeza te lagjeve perreth ujembledhesit te Paskuqanit dhe ndertimi i vazhdimit te Rruges "Ali Demi"

Faza e Projektit:
PROJEKT-ZBATIMI

Data e Implementimit:

Shkalla e Vizatimit: 1:1000

Emertimi i Fletes:
RRJETI K.U.N TE LAGJEVE PERRETH
UJEMBLEDHESIT SE LIQENIT TE PASKUQANIT

Fleta Nr.

S-26

Objekti: "Ndertimi i rrjetit te kanalizimeve te ujrave te zeza te lagjeve perreth ujembledhesit te Paskuqanit dhe ndertimi i vazhdimit te Rruges "Ali Demi"

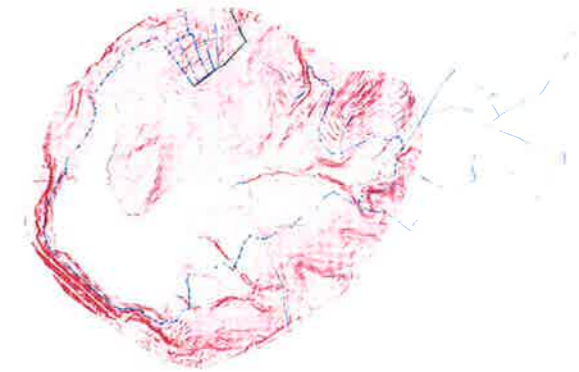
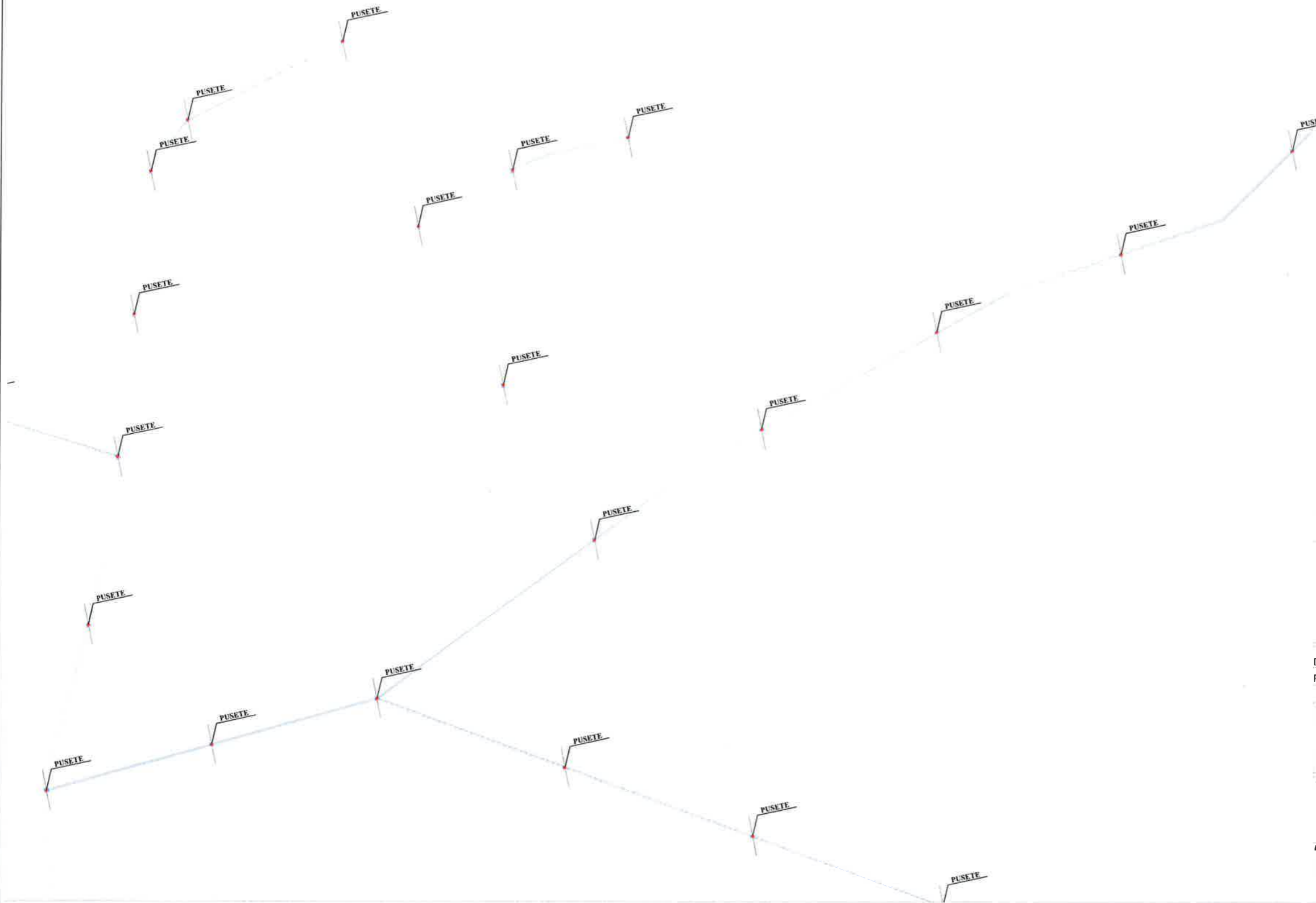

BASHKIA KAMEZ

DREJTORIA E PROJEKTEVE DHE INVESTIMEVE
DEPARTAMENTI I PROJEKTEVE

Dr. e Projekteve e Investimeve FLORA MUÇA
Prgj. e Projekteve EMANUELA MEZIU

STAFI TEKNIK PROJEKTUES	Ing. Konstruktore	DENIS	PRENÇI
	Ing. Gjeoinformatik	ERBLIN	LALA
	Ing. Preventivues	EGLANTINA	DISHA
	Topograf	RAMADAN	HYSA

Titulli i Projektit:
"Ndertimi i rrjetit te kanalizimeve te ujrave te zeza te lagjeve perreth ujembledhesit te Paskuqanit dhe ndertimi i vazhdimit te Rruges "Ali Demi"

Faza e Projektit:
PROJEKT-ZBATIMI

Data e Implementimit:

Shkalla e Vizatimit: 1:1000

Emertimi i Fletes:

RRJETI K.U.N TE LAGJEVE PERRETH
UJEMBLEDHESIT SE LIQENIT TE PASKUQANIT

Fleta Nr.

S-27

Objekti: "Ndertimi i rrjetit te kanalizimeve te ujrave te zeza te lagjeve perreth ujembledhesit te Paskuqanit dhe ndertimi i vazhdimit te Rrugës "Ali Demi"

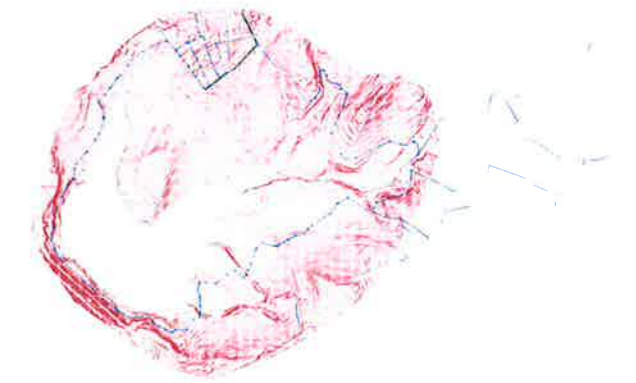
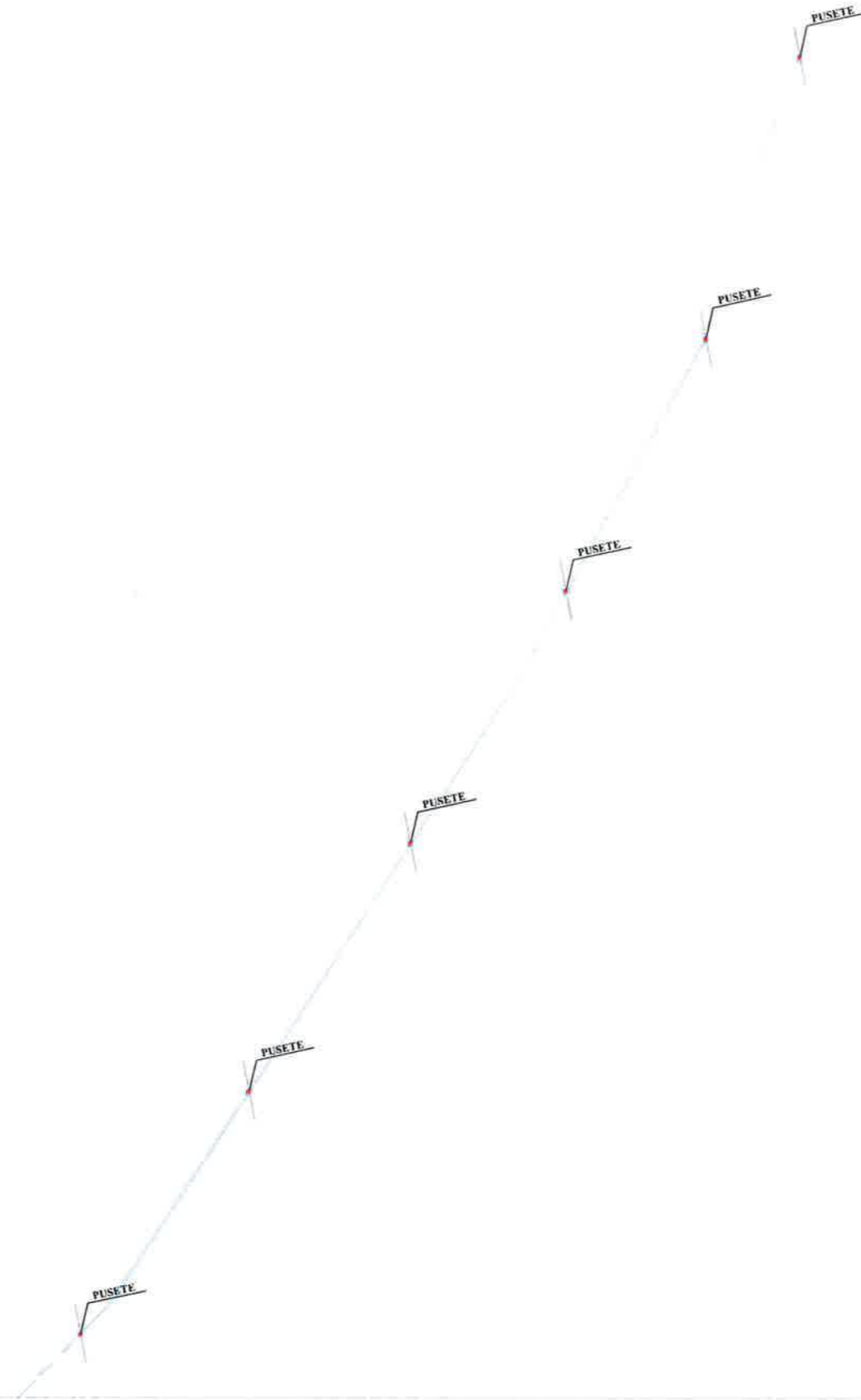

BASHKIA KAMEZ
DREJTORIA E PROJEKTEVE DHE INVESTIMEVE
DEPARTAMENTI I PROJEKTEVE

Dr. e Projekteve e Investimeve FLORA MUÇA
Prgj. e Projekteve EMANUELA MEZIU

STAFI TEKNIK PROJEKTES	Ing. Konstruktor	DENIS	PRENÇI
	Ing. Gjeoinformatik	ERBLIN	LALA
	Ing. Preventivues	EGLANTINA	DISHA
	Topograf	RAMADAN	HYSA

Titulli i Projektit:
"Ndertimi i rrjetit te kanalizimeve te ujrave te zeza te lagjeve perreth ujembledhesit te Paskuqanit dhe ndertimi i vazhdimit te Rrugës "Ali Demi"



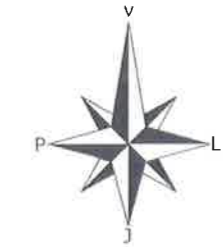
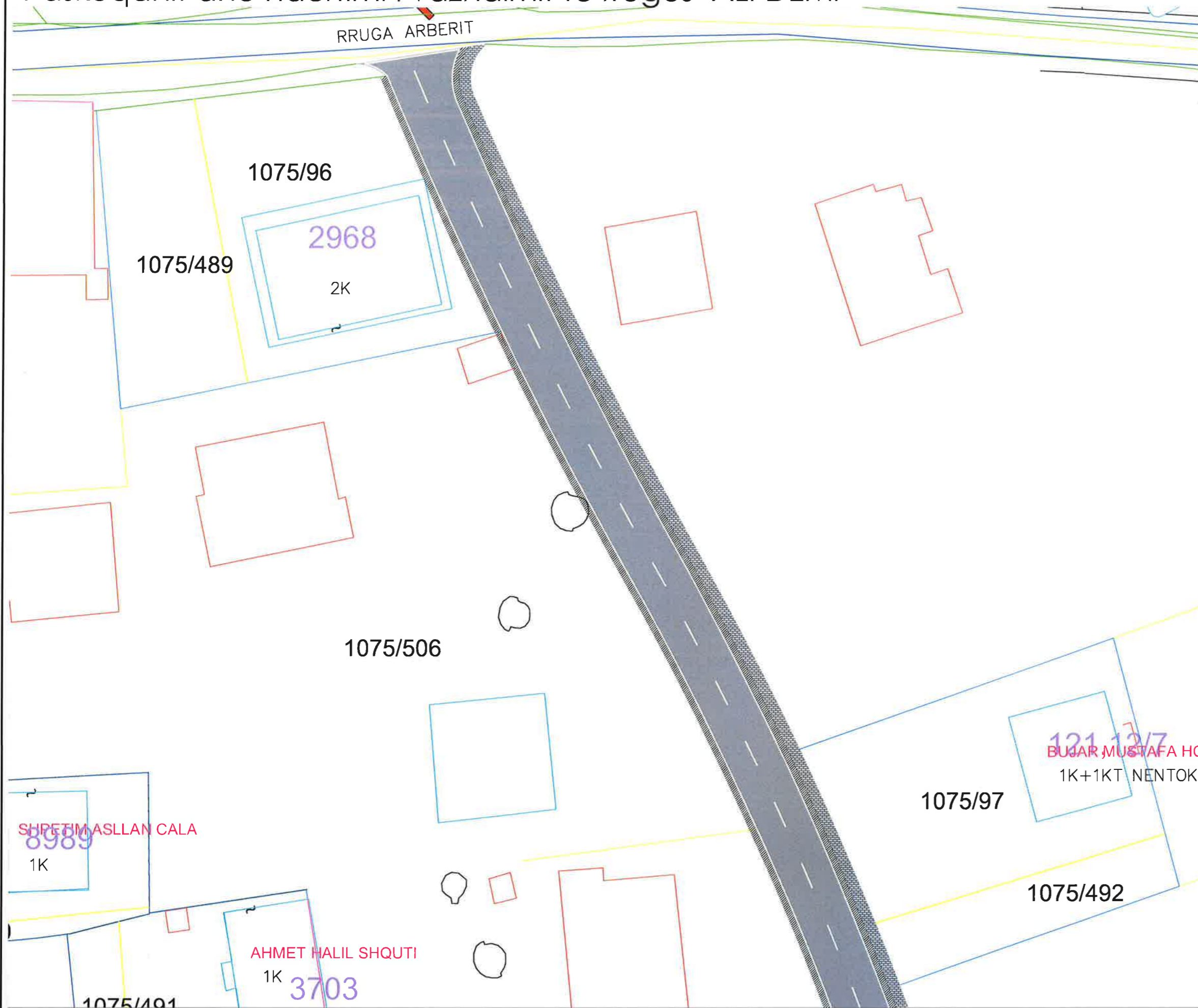

Emortimi i Fletes:
RRJETI K.U.N TE LAGJEVE PERRETH UJEMBLEDHESIT SE LIQENIT TE PASKUQANIT

Faza e Projektit:
PROJEKT ZBATIMI
Data e Implementimit :
Shkalla e Vizatimit: 1:1000
Fleta Nr.
S-28

OBJEKTI: "Ndertimi i rrjetit te kanalizimeve te ujrave te zeza te lagjeve perreth ujembledhesit te Paskuqanit dhe ndertimi i vazhdimit te rruges "ALI DEMI"



LEGJENDA

-  SIPERFAQE ASFALTI
-  OBJEKTE
-  RRUGE EKZISTUESE
-  KUNETE
-  TROTUAR



BASHKIA KAMEZ

DREJTORIA E SHERBIMEVE PUBLIKE
DREJTORIA E PROJEKTEVE DHE INVESTIMEVE
DEPARTAMENTI I PROJEKTEVE

Dr. e Projekteve e Investimeve FLORA MUÇA
Pergj, Depart. Sektori te Projekteve EMANUELA MEZIU

STAFI TEKNIK PROJEKTES	Ing.	DENIS	PRENCI
	Ing.	ERBLIN	LALA
	Ing.	EGLANTINA	DISHA
	Ing.	RAMADAN	HYSA

Titulli i Projektit:
OBJEKTI: "Ndertimi i rrjetit te kanalizimeve te ujrave te zeza te lagjeve perreth ujembledhesit te Paskuqanit dhe ndertimi i vazhdimit te rruges "ALI DEMI"

Faza e Projektit:
PROJEKT ZBATIMI

Data e Implementimit:

Shkalla e Vizatimit:

Emertimi i Fletes:

PLANIMETRI ASFALTI
Rruga te Liqeni i Paskuqanit

Fleta Nr.
01

OBJEKTI: "Ndertimi i rrjetit te kanalizimeve te ujrave te zeza te lagjeve perreth ujembledhesit te Paskuqanit dhe ndertimi i vazhdimit te rruges "ALI DEMI"

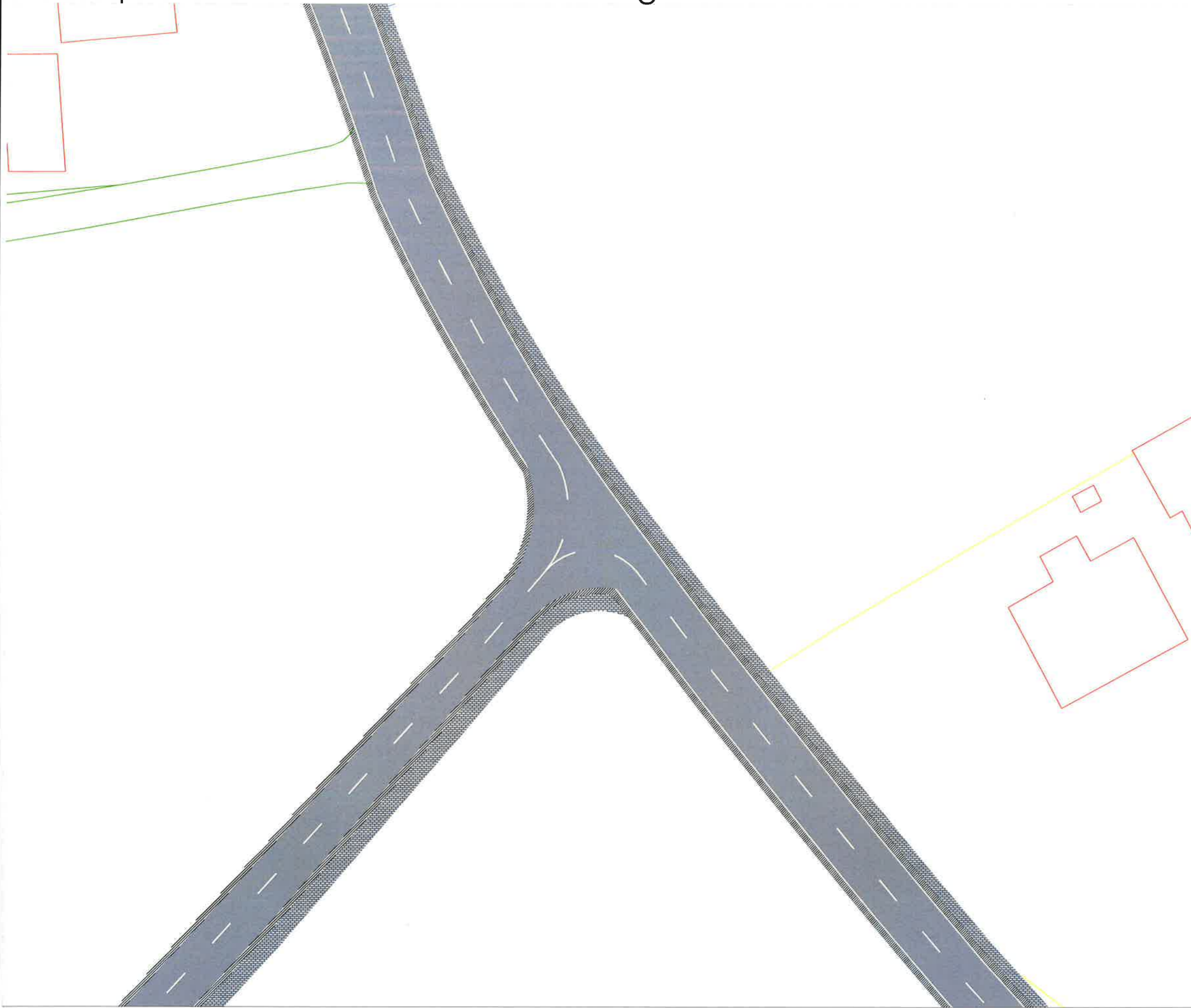

LEGJENDA

 SIPERFAQE ASFALTI

 OBJEKTE

 RRUGE EKZISTUESE

 KUNETE

 TROTUAR



BASHKIA KAMEZ

DREJTORIA E SHERBIMEVE PUBLIKE
DREJTORIA E PROJEKTEVE DHE INVESTIMEVE
DEPARTAMENTI I PROJEKTEVE

Dr. e Projekteve e Investimeve FLORA MUÇA

Pergi, Depart. Sektori te Projekteve EMANUELA MEZIU

STAFI TEKNIK PROJEKTUES	Ing.	DENIS	PRENCI
	Ing.	ERBLIN	LALA
	Ing.	EGLANTINA	DISHA
	Ing.	RAMADAN	HYSA

Titulli i Projektit:
OBJEKTI: "Ndertimi i rrjetit te kanalizimeve te ujrave te zeza te lagjeve perreth ujembledhesit te Paskuqanit dhe ndertimi i vazhdimit te rruges "ALI DEMI"

Faza e Projektit:
PROJEKT ZBATIMI

Data e Implementimit:

Emertimi i Fletes:

PLANIMETRI ASFALTI
Rruga te Liqeni i Paskuqanit

Shkalla e Vizatimit:





Fleta Nr.

02

OBJEKTI: "Ndertimi i rrjetit te kanalizimeve te ujrave te zeza te lagjeve perreth ujembledhesit te Paskuqanit dhe ndertimi i vazhdimit te rruges "ALI DEMI"



LEGJENDA

-  SIPERFAQE ASFALTI
-  OBJEKTE
-  RRUGE EKZISTUESE
-  KUNETE
-  TROTUAR



BASHKIA KAMEZ

DREJTORIA E SHERBIMEVE PUBLIKE
DREJTORIA E PROJEKTEVE DHE INVESTIMEVE
DEPARTAMENTI I PROJEKTEVE

Dr. e Projekteve e Investimeve FLORA MUÇA
Pergj. Depart. Sektori te Projekteve. EMANUELA MEZIU

STAFI TEKNIK PROJEKTUES	Ing.	DENIS	PRENCI
	Ing.	ERBLIN	LALA
	Ing.	EGLANTINA	DISHA
	Ing.	RAMADAN	HYSA

Titulli i Projektit:
OBJEKTI: "Ndertimi i rrjetit te kanalizimeve te ujrave te zeza te lagjeve perreth ujembledhesit te Paskuqanit dhe ndertimi i vazhdimit te rruges "ALI DEMI"

Faza e Projektit:
PROJEKT ZBATIMI

Data e Implementimit:

Emertimi i Fletes:

Shkalla e Vizatimit:



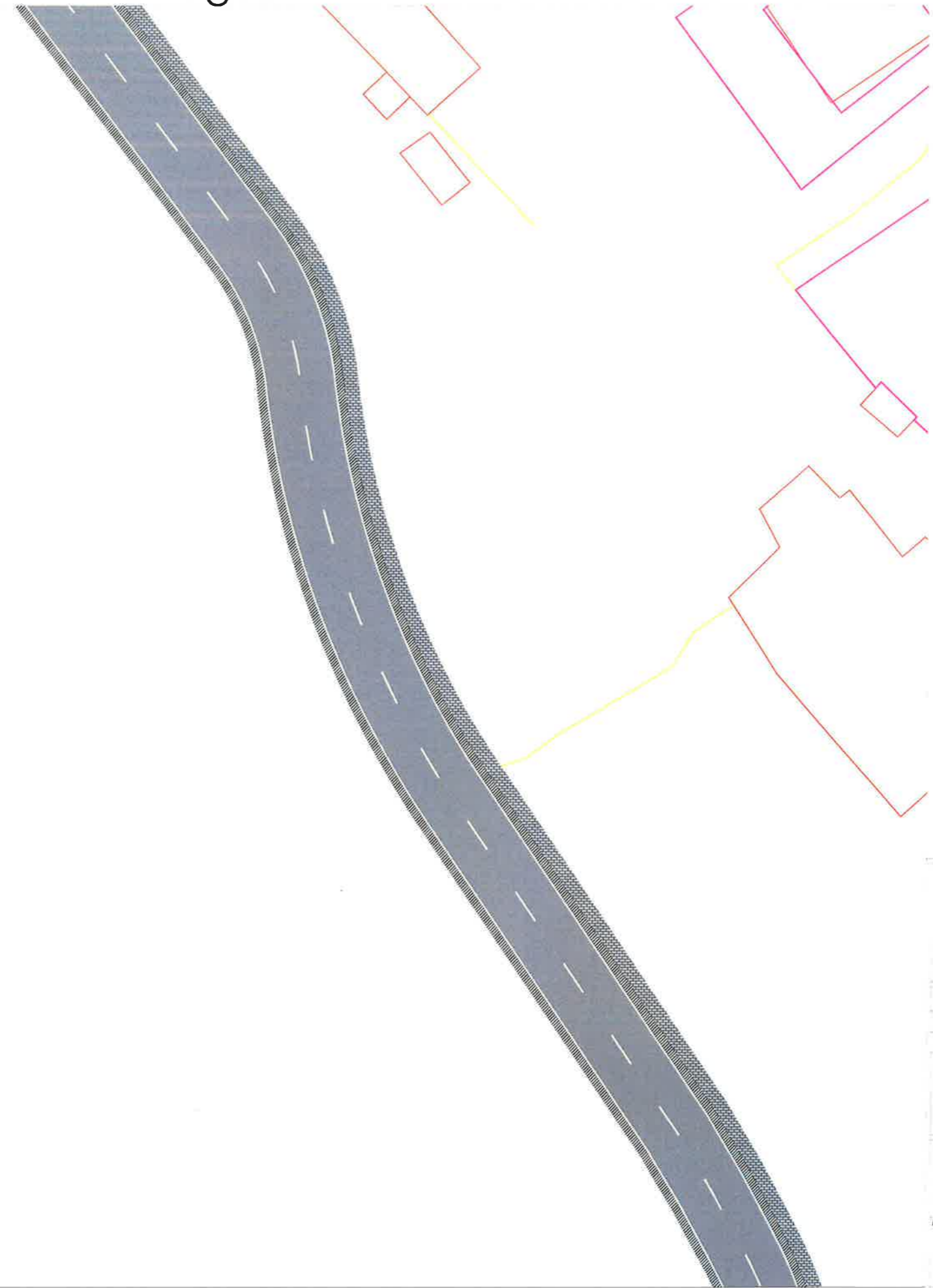

PLANIMETRI ASFALTI
Rruga te Liqeni i Paskuqanit

Fleta Nr.
02

OBJEKTI: "Ndertimi i rrjetit te kanalizimeve te ujrave te zeza te lagjeve perreth ujembledhesit te Paskuqanit dhe ndertimi i vazhdimit te rruges "ALI DEMI"



LEGJENDA

-  SIPERFAQE ASFALTI
-  OBJEKTE
-  RRUGE EKZISTUESE
-  KUNETE
-  TROTUAR



BASHKIA KAMEZ

DREJTORIA E SHERBIMEVE PUBLIKE
DREJTORIA E PROJEKTEVE DHE INVESTIMEVE
DEPARTAMENTI I PROJEKTEVE

Dr. e Projekteve e Investimeve FLORA MUÇA

Pergj,Depart, Sektori te Projekteve EMANUELA MEZIU

STAFI TEKNIK PROJEKTES	Ing.	DENIS	PRENCI
	Ing.	ERBLIN	LALA
	Ing.	EGLANTINA	DISHA
	Ing.	RAMADAN	HYSA

Titulli i Projektit:

OBJEKTI: "Ndertimi i rrjetit te kanalizimeve te ujrave te zeza te lagjeve perreth ujembledhesit te Paskuqanit dhe ndertimi i vazhdimit te rruges "ALI DEMI"

Faza e Projektit:
PROJEKT ZBATIMI

Data e Implementimit:

Emertimi i Fletes:

PLANIMETRI ASFALTI
Rruga te Liqeni i Paskuqanit



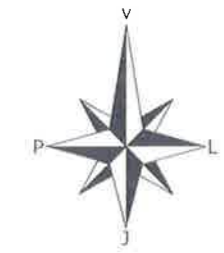

Fleta Nr.

04

OBJEKTI: "Ndertimi i rrjetit te kanalizimeve te ujrave te zeza te lagjeve perreth ujembledhesit te Paskuqanit dhe ndertimi i vazhdimit te rruges "ALI DEMI"

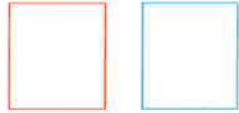

LEGJENDA

-  SIPERFAQE ASFALTI
-  OBJEKTE
-  RRUGE EKZISTUESE
-  KUNETE
-  TROTUAR

 **BASHKIA KAMEZ**
 DREJTORIA E SHERBIMEVE PUBLIKE
 DREJTORIA E PROJEKTEVE DHE INVESTIMEVE
 DEPARTAMENTI I PROJEKTEVE

Dr. e Projekteve e Investimeve FLORA MUÇA
 Pergj. Depart. Sektori te Projekteve EMANUELA MEZIU

STAFI TEKNIK PROJEKTUES	Ing.	DENIS	PRENCI
	Ing.	ERBLIN	LALA
	Ing.	EGLANTINA	DISHA
	Ing.	RAMADAN	HYSA

Titulli i Projektit: **OBJEKTI:** "Ndertimi i rrjetit te kanalizimeve te ujrave te zeza te lagjeve perreth ujembledhesit te Paskuqanit dhe ndertimi i vazhdimit te rruges "ALI DEMI"
Faza e Projektit: PROJEKT ZBATIMI
Data e Implementimit:

Emertimi i Fletes: **Shkalla e Vizatimit:**

PLANIMETRI ASFALTI
 Rruga te Liqeni i Paskuqanit **Fieta Nr. 05**

OBJEKTI: "Ndertimi i rrjetit te kanalizimeve te ujrave te zeza te lagjeve perreth ujembledhesit te Paskuqanit dhe ndertimi i vazhdimit te rruges "ALI DEMI"

BLOKUES TRAFIKU



LEGJENDA

 SIPERFAQE ASFALTI

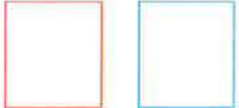
 OBJEKTE

 RRUGE EKZISTUESE

 KUNETE

 TROTUAR



BASHKIA KAMEZ

DREJTORIA E SHERBIMEVE PUBLIKE
DREJTORIA E PROJEKTEVE DHE INVESTIMEVE
DEPARTAMENTI I PROJEKTEVE

Dr. e Projekteve e Investimeve FLORA MUÇA

Pergj, Depart, Sektori te Projekteve EMANUELA MEZIU

STAFI TEKNIK PROJEKTES	Ing.	DENIS	PRENCI
	Ing.	ERBLIN	LALA
	Ing.	EGLANTINA	DISHA
	Ing.	RAMADAN	HYSA

Titulli i Projektit:
OBJEKTI: "Ndertimi i rrjetit te kanalizimeve te ujrave te zeza te lagjeve perreth ujembledhesit te Paskuqanit dhe ndertimi i vazhdimit te rruges "ALI DEMI"
Faza e Projektit: PROJEKT ZBATIMI
Data e Implementimit:

Emertimi i Fletes:

PLANIMETRI ASFALTI
Rruga te Liqeni i Paskuqanit

Fleta Nr.
06

OBJEKTI: "Ndertimi i rrjetit te kanalizimeve te ujrave te zeza te lagjeve perreth ujembledhesit te Paskuqanit dhe ndertimi i vazhdimit te rruges "ALI DEMI"



LEGJENDA

 SIPERFAQE ASFALTI

 OBJEKTE

 RRUGE EKZISTUESE

 KUNETE

 TROTUAR



BASHKIA KAMEZ

DREJTORIA E SHERBIMEVE PUBLIKE
DREJTORIA E PROJEKTEVE DHE INVESTIMEVE
DEPARTAMENTI I PROJEKTEVE

Dr. e Projekteve e Investimeve FLORA MUÇA
Pergj. Depart. e Sektorit te Projekteve EMANUELA MEZIU

STAFI TEKNIK PROJEKTUES	Ing.	DENIS	PRENCI
	Ing.	ERBLIN	LALA
	Ing.	EGLANTINA	DISHA
	Ing.	RAMADAN	HUSA

Titulli i Projektit:
OBJEKTI: "Ndertimi i rrjetit te kanalizimeve te ujrave te zeza te lagjeve perreth ujembledhesit te Paskuqanit dhe ndertimi i vazhdimit te rruges "ALI DEMI"

Faza e Projektit:
PROJEKT ZBATIMI

Data e Implementimit:

Emertimi i Fletes:





PLANIMETRI ASFALTI
Rruga te Liqeni i Paskuqanit

Fleta Nr.
07

OBJEKTI: "Ndertimi i rrjetit te kanalizimeve te ujrave te zeza te lagjeve perreth ujembledhesit te Paskuqanit dhe ndertimi i vazhdimit te rruges "ALI DEMI"



LEGJENDA

-  SIPERFAQE ASFALTI
-  OBJEKTE
-  RRUGE EKZISTUESE
-  KUNETE
-  TROTUAR



BASHKIA KAMEZ

DREJTORIA E SHERBIMEVE PUBLIKE
DREJTORIA E PROJEKTEVE DHE INVESTIMEVE
DEPARTAMENTI I PROJEKTEVE

Dr. e Projekteve e Investimeve FLORA MUÇA

Pergj. Depart. Sektori te Projekteve EMANUELA MEZIU

STAFI TEKNIK PROJEKTUES	Ing.	DENIS	PRENCI
	Ing.	ERBLIN	LALA
	Ing.	EGLANTINA	DISHA
	Ing.	RAMADAN	HYSA

Titulli i Projektit: *Exa e Projektit:* PROJEKT ZBATIMI
OBJEKTI: "Ndertimi i rrjetit te kanalizimeve te ujrave te zeza te lagjeve perreth ujembledhesit te Paskuqanit dhe ndertimi i vazhdimit te rruges "ALI DEMI"
Data e Implementimit:



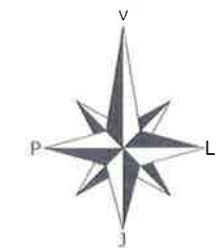
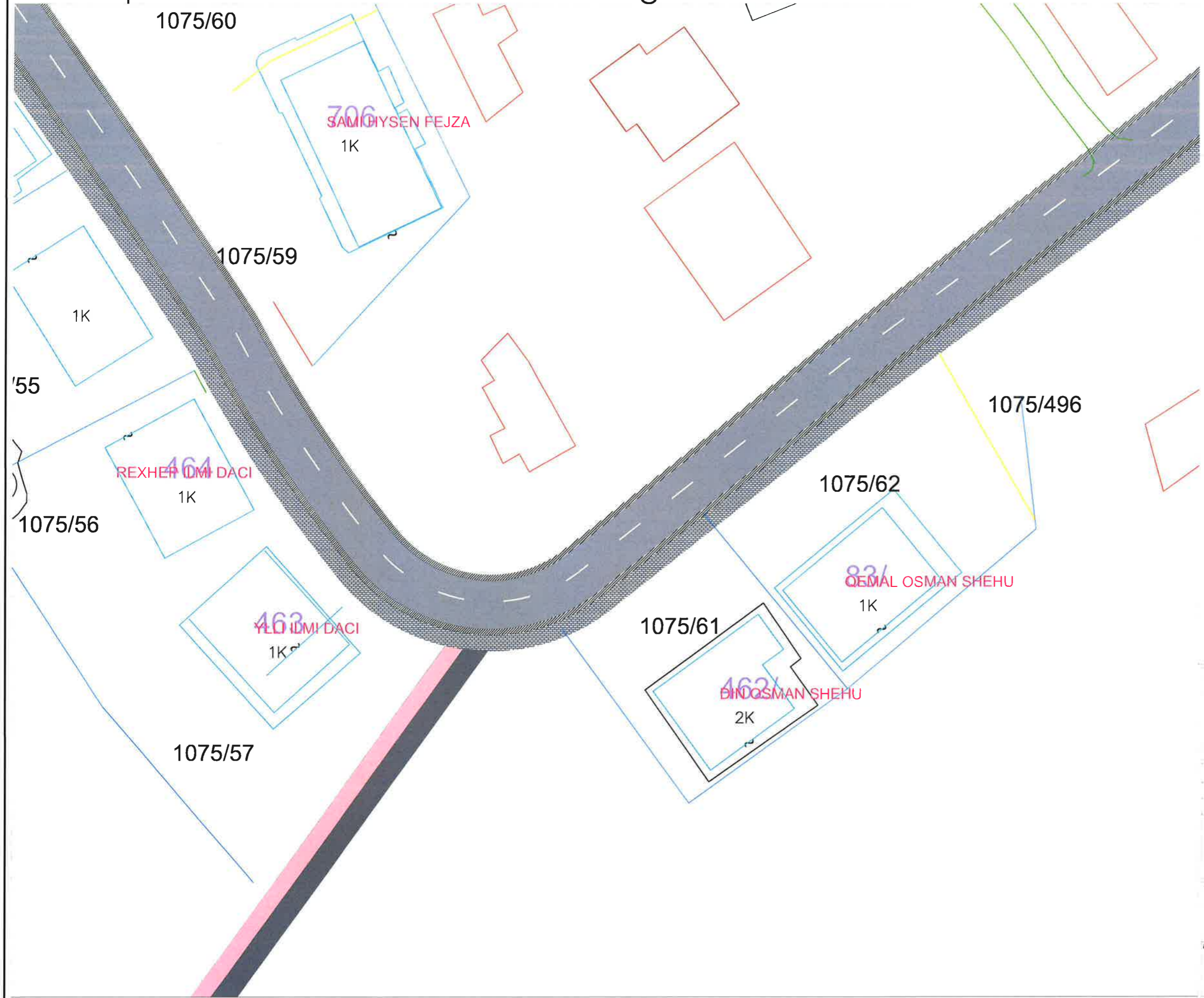

Emertimi i Fletes:
PLANIMETRI ASFALTI
Rruga te Liqeni i Paskuqanit

Shkalla e Vizimit:
Fleta Nr.
08

OBJEKTI: "Ndertimi i rrjetit te kanalizimeve te ujrave te zeza te lagjeve perreth ujembledhesit te Paskuqanit dhe ndertimi i vazhdimit te rruges "ALI DEMI"



LEGJENDA

-  SIPERFAQE ASFALTI
-  OBJEKTE
-  RRUGE EKZISTUESE
-  KUNETE
-  TROTUAR



BASHKIA KAMEZ

DREJTORIA E SHERBIMEVE PUBLIKE
DREJTORIA E PROJEKTEVE DHE INVESTIMEVE
DEPARTAMENTI I PROJEKTEVE

Dr. e Projekteve e Investimeve FLORA MUÇA
Pergj, Depart. Sektori te Projekteve EMANUELA MEZIU

STAFI TEKNIK PROJEKTES	Ing.	DENIS	PRENCI
	Ing.	ERBLIN	LALA
	Ing.	EGLANTINA	DISHA
	Ing.	RAMADAN	HYSA

Titulli i Projektit:
OBJEKTI: "Ndertimi i rrjetit te kanalizimeve te ujrave te zeza te lagjeve perreth ujembledhesit te Paskuqanit dhe ndertimi i vazhdimit te rruges "ALI DEMI"

Faza e Projektit:
PROJEKT ZBATIMI

Data e Implementimit:

Emertimi i Fletes:

PLANIMETRI ASFALTI
Rruga te Liqeni i Paskuqanit





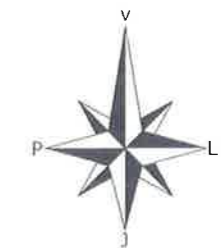

Fleta Nr.

08

OBJEKTI: "Ndertimi i rrjetit te kanalizimeve te ujrave te zeza te lagjeve perreth ujembledhesit te Paskuqanit dhe ndertimi i vazhdimit te rruges "ALI DEMI"



LEGJENDA

-  SIPERFAQE ASFALTI
-   OBJEKTE
-  RRUGE EKZISTUESE
-  KUNETE
-  TROTUAR



BASHKIA KAMEZ
 DREJTORIA E SHERBIMEVE PUBLIKE
 DREJTORIA E PROJEKTEVE DHE INVESTIMEVE
 DEPARTAMENTI I PROJEKTEVE

Dr. e Projekteve e Investimeve FLORA MUÇA
 Pergj. Depart. Sektori te Projekteve EMANUELA MEZIU

STAFI TEKNIK PROJEKTES	Ing.	DENIS	PRENCI
	Ing.	ERBLIN	LALA
	Ing.	EGLANTINA	DISHA
	Ing.	RAMADAN	HYSA

Titulli i Projektit:
 OBJEKTI: "Ndertimi i rrjetit te kanalizimeve te ujrave te zeza te lagjeve perreth ujembledhesit te Paskuqanit dhe ndertimi i vazhdimit te rruges "ALI DEMI"
 Faza e Projektit: PROJEKT ZBATIMI
 Data e Implementimit:

Shkalla e Vizatimit:
 Emertimi i Fletes:
PLANIMETRI ASFALTI
 Rruga te Liqeni i Paskuqanit
 Fleta Nr. **08**

OBJEKTI: "Ndertimi i rrjetit te kanalizimeve te ujrave te zeza te lagjeve perreth ujembledhesit te Paskuqanit dhe ndertimi i vazhdimit te rruges "ALI DEMI"

ARTAN ZEF VLADI



LEGJENDA

 SIPERFAQE ASFALTI

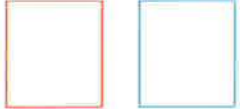
 OBJEKTE

 RRUGE EKZISTUESE

 KUNETE

 TROTUAR

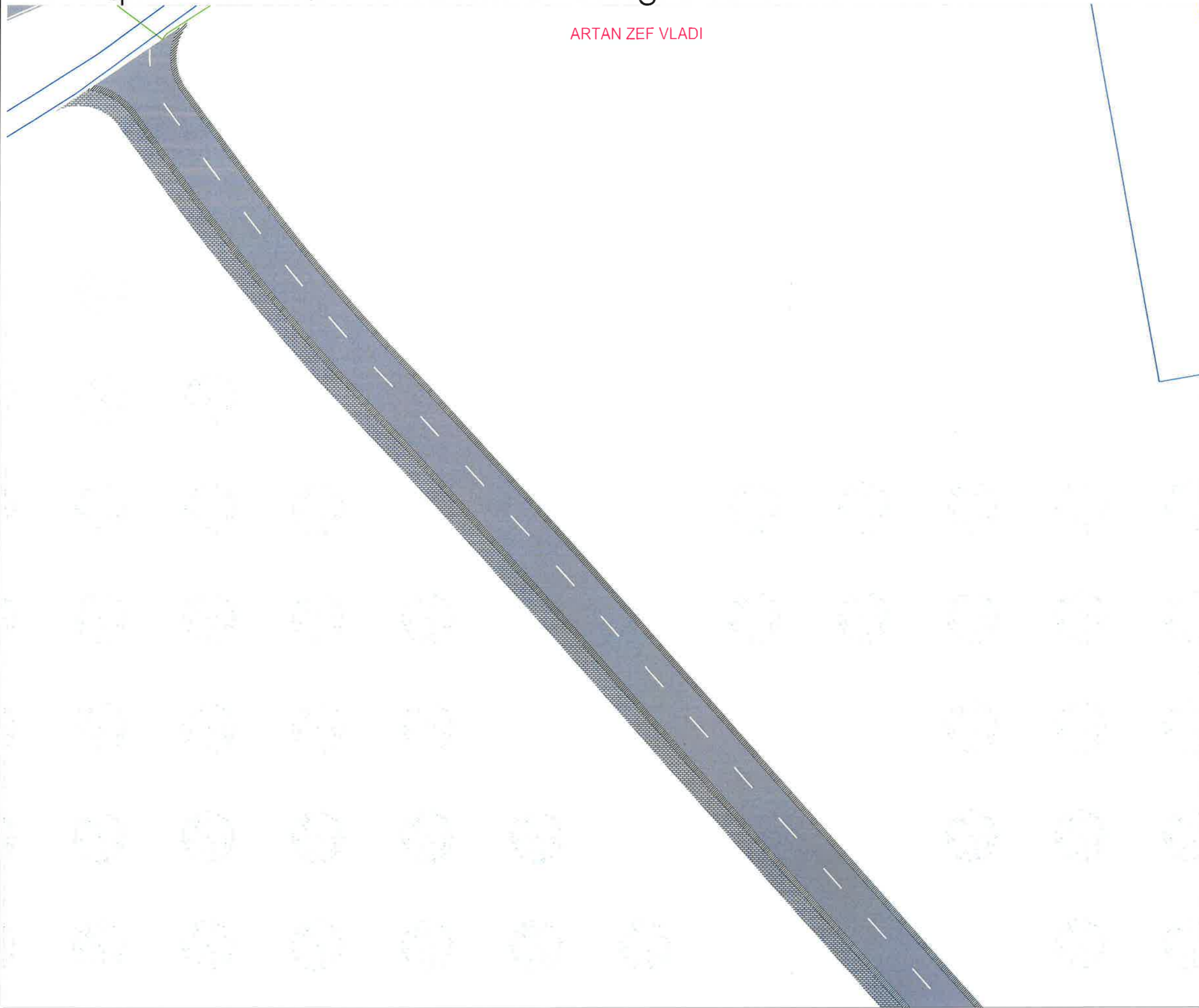

BASHKIA KAMEZ

DREJTORIA E SHERBIMEVE PUBLIKE
DREJTORIA E PROJEKTEVE DHE INVESTIMEVE
DEPARTAMENTI I PROJEKTEVE

Dr. e Projekteve e Investimeve FLORA MUÇA

Pergj. Depart. Sektori te Projekteve EMANUELA MEZIU

STAFI TEKNIK PROJEKTUES	Ing.	DENIS	PRENCI
	Ing.	ERBLIN	LALA
	Ing.	EGLANTINA	DISHA
	Ing.	RAMADAN	HYSA

Titulli i Projektit:

OBJEKTI: "Ndertimi i rrjetit te kanalizimeve te ujrave te zeza te lagjeve perreth ujembledhesit te Paskuqanit dhe ndertimi i vazhdimit te rruges "ALI DEMI"

Faza e Projektit:
PROJEKT ZBATIMI

Data e Implementimit:

Emertimi i Fletes:

PLANIMETRI ASFALTI
Rruga te Liqeni i Paskuqanit





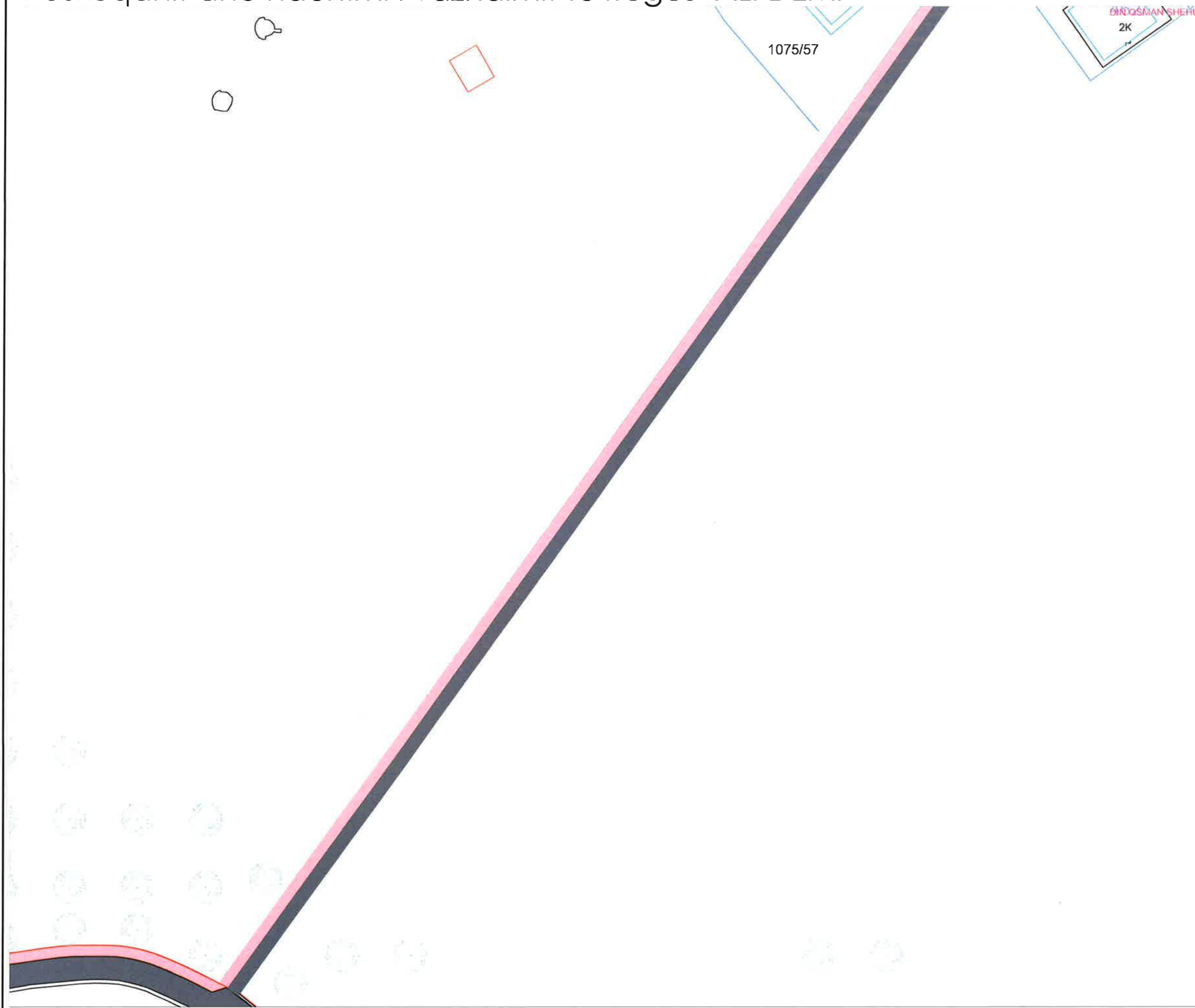

Fleta Nr.

11

OBJEKTI: "Ndertimi i rrjetit te kanalizimeve te ujrave te zeza te lagjeve perreth ujembledhesit te Paskuqanit dhe ndertimi i vazhdimit te rruges "ALI DEMI"



LEGJENDA

-  SIPERFAQE ASFALTI
-   OBJEKTE
-  RRUGE EKZISTUESE
-  KUNETE
-  TROTUAR



BASHKIA KAMEZ

DREJTORIA E SHERBIMEVE PUBLIKE
DREJTORIA E PROJEKTEVE DHE INVESTIMEVE
DEPARTAMENTI I PROJEKTEVE

Dr. e Projekteve e Investimeve FLORA MUÇA

Pergj. Depart. Sektori te Projekteve EMANUELA MEZIU

STAFI TEKNIK PROJEKTUES	Ing.	DENIS	PRENCI
	Ing.	ERBLIN	LALA
	Ing.	EGLANTINA	DISHA
	Ing.	RAMADAN	HYSA

Titulli i Projektit:
OBJEKTI: "Ndertimi i rrjetit te kanalizimeve te ujrave te zeza te lagjeve perreth ujembledhesit te Paskuqanit dhe ndertimi i vazhdimit te rruges "ALI DEMI"

Faza e Projektit:
PROJEKT ZBATIMI
Data e Implementimit:

Emertimi i Fletes:

PLANIMETRI ASFALTI
Rruga te Liqeni i Paskuqanit





Fleta Nr.
12

OBJEKTI: "Ndertimi i rrjetit te kanalizimeve te ujrave te zeza te lagjeve perreth ujembledhesit te Paskuqanit dhe ndertimi i vazhdimit te rruges "ALI DEMI"

ARTAN ZEF VLADI

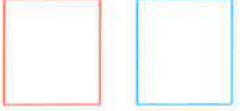

LEGJENDA

-  SIPERFAQE ASFALTI
-  OBJEKTE
-  RRUGE EKZISTUESE
-  KUNETE
-  TROTUAR



BASHKIA KAMEZ

DREJTORIA E SHERBIMEVE PUBLIKE
DREJTORIA E PROJEKTEVE DHE INVESTIMEVE
DEPARTAMENTI I PROJEKTEVE

Dr. e Projekteve e Investimeve FLORA MUÇA
Pergj. Depart. Sektori te Projekteve EMANUELA MEZIU

STAFI TEKNIK
PROJEKTES
Ing. DENIS PRENCI
Ing. ERBLIN LALA
Ing. EGLANTINA DISHA
Ing. RAMADAN HYSA

Titulli i Projektit:
OBJEKTI: "Ndertimi i rrjetit te kanalizimeve te ujrave te zeza te lagjeve perreth ujembledhesit te Paskuqanit dhe ndertimi i vazhdimit te rruges "ALI DEMI"

Faza e Projektit:
PROJEKT ZBATIMI

Data e Implementimit:

Emertimi i Fletes:

PLANIMETRI NDRICIMI
Rruga te Liqeni i Paskuqanit



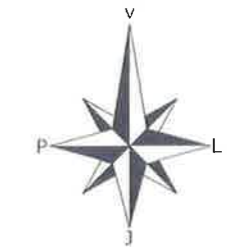
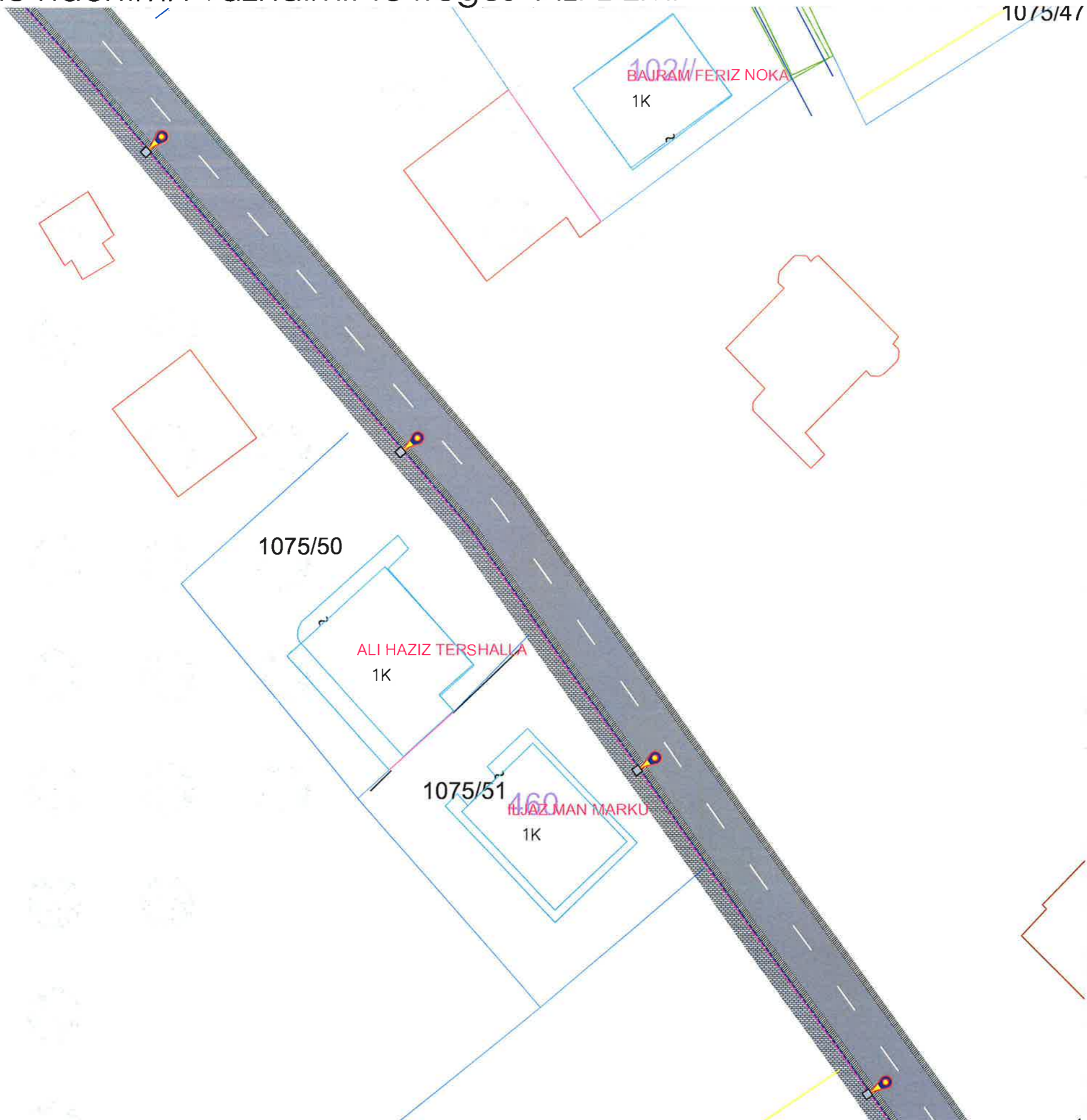

Fleta Nr.

13

OBJEKTI: "Ndertimi i rrjetit te kanalizimeve te ujrave te zeza te lagjeve perreth ujembledhesit te Paskuqanit dhe ndertimi i vazhdimit te rruges "ALI DEMI"



LEGJENDA

-  SIPERFAQE ASFALTI
-  OBJEKTE
-  RRUGE EKZISTUESE
-  KUNETE
-  TROTUAR



BASHKIA KAMEZ

DREJTORIA E SHERBIMEVE PUBLIKE
DREJTORIA E PROJEKTEVE DHE INVESTIMEVE
DEPARTAMENTI I PROJEKTEVE

Dr. e Projekteve e Investimeve FLORA MUÇA
Pergj. Depart. Sektori te Projekteve EMANUELA MEZIU

STAFI TEKNIK
PROJEKTES

Ing.	DENIS	PRENCI
Ing.	ERBLIN	LALA
Ing.	EGLANTINA	DISHA
Ing.	RAMADAN	HYSA

Titulli i Projektit:
OBJEKTI: "Ndertimi i rrjetit te kanalizimeve te ujrave te zeza te lagjeve perreth ujembledhesit te Paskuqanit dhe ndertimi i vazhdimit te rruges "ALI DEMI"

Faza e Projektit:
PROJEKT ZBATIMI

Data e Implementimit:

Shkalla e Vizimit:

Emeritimi i Fletes:

PLANIMETRI NDRICIMI
Rruga te Liqeni i Paskuqanit



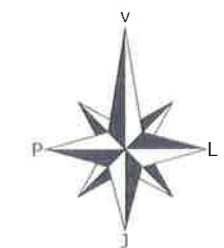

Fleta Nr.

14

OBJEKTI: "Ndertimi i rrjetit te kanalizimeve te ujrave te zeza te lagjeve perreth ujembledhesit te Paskuqanit dhe ndertimi i vazhdimit te rruges "ALI DEMI"



LEGJENDA

-  SIPERFAQE ASFALTI
-  OBJEKTE
-  RRUGE EKZISTUESE
-  KUNETE
-  TROTUAR



BASHKIA KAMEZ

DREJTORIA E SHERBIMEVE PUBLIKE
DREJTORIA E PROJEKTEVE DHE INVESTIMEVE
DEPARTAMENTI I PROJEKTEVE

Dr. e Projekteve e Investimeve FLORA MUÇA
Pergj. Depart. Sektori te Projekteve EMANUELA MEZIU

STAFI TEKNIK PROJEKTUES	Ing.	DENIS	PRENCI
	Ing.	ERBLIN	LALA
	Ing.	EGLANTINA	DISHA
	Ing.	RAMADAN	HYSA

Titulli i Projektit:
OBJEKTI: "Ndertimi i rrjetit te kanalizimeve te ujrave te zeza te lagjeve perreth ujembledhesit te Paskuqanit dhe ndertimi i vazhdimit te rruges "ALI DEMI"

Faza e Projektit:
PROJERT ZBATIMI
Data e Implementimit:

Emertimi i Fletes:





PLANIMETRI NDRICIMI
Rruga te Liqeni i Paskuqanit

Shkalla e Vizimit:
Fleta Nr.
15

OBJEKTI: "Ndertimi i rrjetit te kanalizimeve te ujrave te zeza te lagjeve perreth ujembledhesit te Paskuqanit dhe ndertimi i vazhdimit te rruges "ALI DEMI"



LEGJENDA

-  SIPERFAQE ASFALTI
-  OBJEKTE
-  RRUGE EKZISTUESE
-  KUNETE
-  TROTUAR



BASHKIA KAMEZ

DREJTORIA E SHERBIMEVE PUBLIKE
DREJTORIA E PROJEKTEVE DHE INVESTIMEVE
DEPARTAMENTI I PROJEKTEVE

Dr. e Projekteve e Investimeve FLORA MUÇA

Pergj. Depart. Sektori te Projekteve EMANUELA MEZIU

STAFI TEKNIK
PROJEKTUES
Ing. DENIS PRENCI
Ing. ERBLIN LALA
Ing. EGLANTINA DISHA
Ing. RAMADAN HYSA

Titulli i Projektit:
OBJEKTI: "Ndertimi i rrjetit te kanalizimeve te ujrave te zeza te lagjeve perreth ujembledhesit te Paskuqanit dhe ndertimi i vazhdimit te rruges "ALI DEMI"

Faza e Projektit:
PROJEKT ZBATIMI

Data e Implementimit:

Emertimi i Fletes:

PLANIMETRI NDRICIMI
Rruga te Liqeni i Paskuqanit



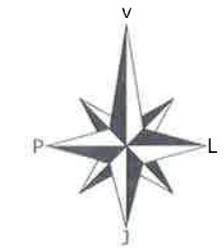
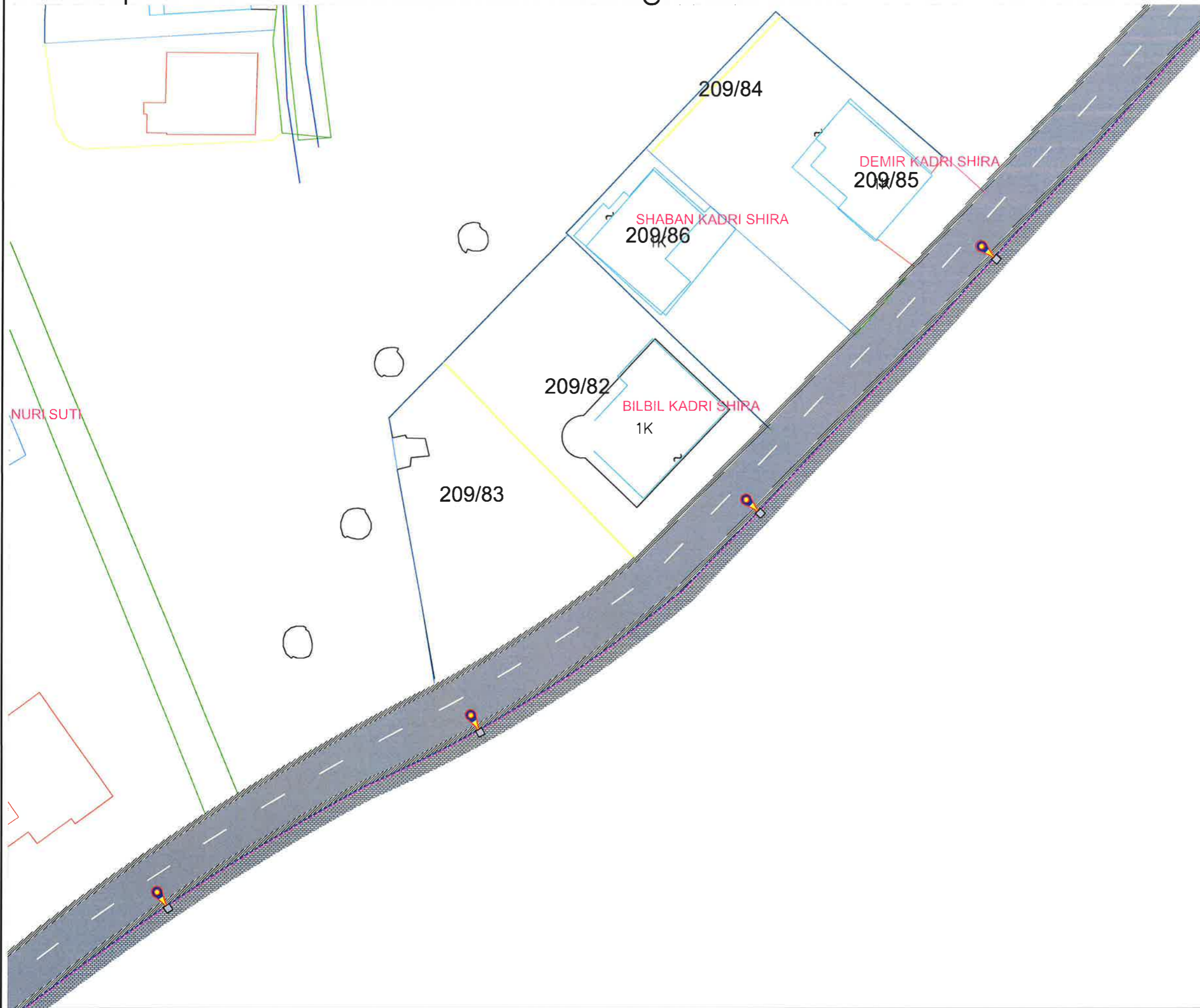

Fleta Nr.

16

OBJEKTI: "Ndertimi i rrjetit te kanalizimeve te ujrave te zeza te lagjeve perreth ujembledhesit te Paskuqanit dhe ndertimi i vazhdimit te rruges "ALI DEMI"

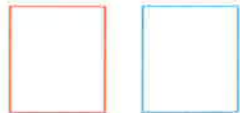

LEGJENDA

-  SIPERFAQE ASFALTI
-  OBJEKTE
-  RRUGE EKZISTUESE
-  KUNETE
-  TROTUAR



BASHKIA KAMEZ

DREJTORIA E SHERBIMEVE PUBLIKE
DREJTORIA E PROJEKTEVE DHE INVESTIMEVE
DEPARTAMENTI I PROJEKTEVE

Dr. e Projekteve e Investimeve FLORA MUÇA
Pergj. Depart. Sektori te Projekteve EMANUELA MEZIU

STAFI TEKNIK
PROJEKTUES Ing. DENIS PRENCI
Ing. ERBLIN LALA
Ing. EGLANTINA DISHA
Ing. RAMADAN HYSA

Titulli i Projektit: Faza e Projektit
OBJEKTI: "Ndertimi i rrjetit te kanalizimeve te ujrave te zeza te lagjeve perreth ujembledhesit te Paskuqanit dhe ndertimi i vazhdimit te rruges "ALI DEMI"
Data e Implementimit:

Emertimi i Fletes: **Shkalla e Vizatimit:**

PLANIMETRI NDRICIMI
Rruga te Liqeni i Paskuqanit

Fleta Nr.
17

OBJEKTI: "Ndertimi i rrjetit te kanalizimeve te ujrave te zeza te lagjeve perreth ujembledhesit te Paskuqanit dhe ndertimi i vazhdimet te rruges "ALI DEMI"



LEGJENDA

 SIPERFAQE ASFALTI

 OBJEKTE

 RRUGE EKZISTUESE

 KUNETE

 TROTUAR

1075/507

DEMIR KADRI SHIRA
209/85



BASHKIA KAMEZ

DREJTORIA E SHERBIMEVE PUBLIKE
DREJTORIA E PROJEKTEVE DHE INVESTIMEVE
DEPARTAMENTI I PROJEKTEVE

Dr. e Projekteve e Investimeve FLORA MUÇA

Pergj. Depart. Sektori te Projekteve EMANUELA MEZIU

STAFI TEKNIK
PROJEKTES

Ing.	DENIS	PRENCI
Ing.	ERBLIN	LALA
Ing.	EGLANTINA	DISHA
Ing.	RAMADAN	HYSA

Faza e Projektit:
OBJEKTI: "Ndertimi i rrjetit te kanalizimeve te ujrave te zeza te lagjeve perreth ujembledhesit te Paskuqanit dhe ndertimi i vazhdimet te rruges "ALI DEMI"

Faza e Projektit:
PROJEKT ZBATIMI

Data e Implementimit:

Shkalla e Vizatimit:

Emertimi i Fletes:

PLANIMETRI NDRICIMI
Rruga te Liqeni i Paskuqanit





Fleta Nr.

18

OBJEKTI: "Ndertimi i rrjetit te kanalizimeve te ujrave te zeza te lagjeve perreth ujembledhesit te Paskuqanit dhe ndertimi i vazhdimit te rruges "ALI DEMI"



LEGJENDA

-  SIPERFAQE ASFALTI
-  OBJEKTE
-  RRUGE EKZISTUESE
-  KUNETE
-  TROTUAR



BASHKIA KAMEZ

DREJTORIA E SHERBIMEVE PUBLIKE
DREJTORIA E PROJEKTEVE DHE INVESTIMEVE
DEPARTAMENTI I PROJEKTEVE

Dr. e Projekteve e Investimeve : FLORA MUÇA
Pergj. Depart. Sektori te Projekteve EMANUELA MEZIU

STAFI TEKNIK
PROJEKTUES
Ing. DENIS PRENCI
Ing. ERBLIN LALA
Ing. EGLANTINA DISHA
Ing. RAMADAN HYSA

Titulli i Projektit:
OBJEKTI: "Ndertimi i rrjetit te kanalizimeve te ujrave te zeza te lagjeve perreth ujembledhesit te Paskuqanit dhe ndertimi i vazhdimit te rruges "ALI DEMI"

Faza e Projektit:
PROJEKT ZBATIMI

Data e Implementimit :

Shkalla e Vizatimit:

Emertimi i Fletes:



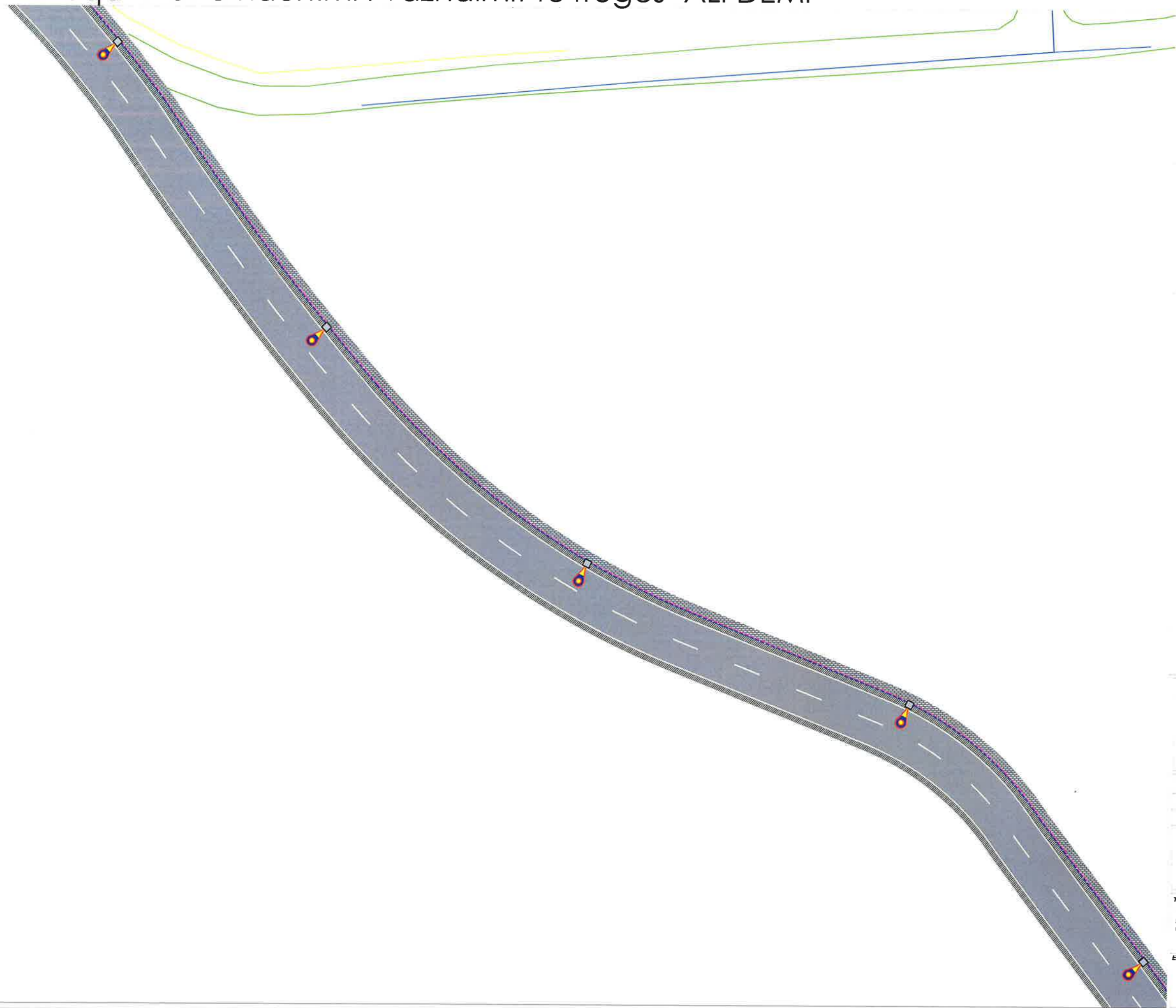

PLANIMETRI NDRICIMI
Rruga te Liqeni i Paskuqanit

Fleta Nr.
19

OBJEKTI: "Ndertimi i rrjetit te kanalizimeve te ujrave te zeza te lagjeve perreth ujembledhesit te Paskuqanit dhe ndertimi i vazhdimit te rruges "ALI DEMI"

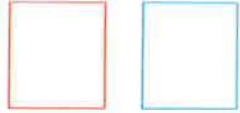

LEGJENDA

-  SIPERFAQE ASFALTI
-  OBJEKTE
-  RRUGE EKZISTUESE
-  KUNETE
-  TROTUAR



BASHKIA KAMEZ

DREJTORIA E SHERBIMEVE PUBLIKE
DREJTORIA E PROJEKTEVE DHE INVESTIMEVE
DEPARTAMENTI I PROJEKTEVE

Dr. e Projekteve e Investimeve FLORA MUÇA
Pergj. Depart. Sektori te Projekteve EMANUELA MEZIU

STAFI TEKNIK PROJEKTES	Ing.	DENIS	PRENCI
	Ing.	ERBLIN	LALA
	Ing.	EGLANTINA	DISHA
	Ing.	RAMADAN	HYSA



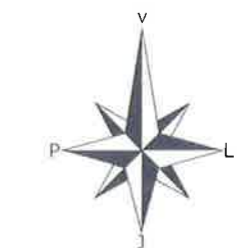

Titulli i Projektit: **Objekti:** "Ndertimi i rrjetit te kanalizimeve te ujrave te zeza te lagjeve perreth ujembledhesit te Paskuqanit dhe ndertimi i vazhdimit te rruges "ALI DEMI"
Faza e Projektit: PROJEKT ZBATIMI
Data e Implementimit:
Shkalla e Vizatimit:

Emertimi i Fletes: PLANIMETRI NDRICIMI
Rruga te Liqeni i Paskuqanit
Fleta Nr.: 20

OBJEKTI: "Ndertimi i rrjetit te kanalizimeve te ujrave te zeza te lagjeve perreth ujembledhesit te Paskuqanit dhe ndertimi i vazhdimit te rruges "ALI DEMI"



LEGJENDA

-  SIPERFAQE ASFALTI
-  OBJEKTE
-  RRUGE EKZISTUESE
-  KUNETE
-  TROTUAR



BASHKIA KAMEZ

DREJTORIA E SHERBIMEVE PUBLIKE
DREJTORIA E PROJEKTEVE DHE INVESTIMEVE
DEPARTAMENTI I PROJEKTEVE

Dr. e Projekteve e Investimeve FLORA MUÇA
Pergj, Depart. Sektori te Projekteve EMANUELA MEZIU

STAFI TEKNIK PROJEKTES	Ing.	DENIS	PRENCI
	Ing.	ERBLIN	LALA
	Ing.	EGLANTINA	DISHA
	Ing.	RAMADAN	HYSA

Titulli i Projektit:
OBJEKTI: "Ndertimi i rrjetit te kanalizimeve te ujrave te zeza te lagjeve perreth ujembledhesit te Paskuqanit dhe ndertimi i vazhdimit te rruges "ALI DEMI"

Faza e Projektit:
PROJEKT ZBATIMI

Data e Implementimit:

Shtella e Vizimit:

Emertimi i Fletes:

PLANIMETRI NDRICIMI
Rruga te Liqeni i Paskuqanit



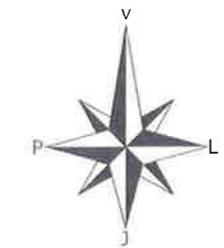
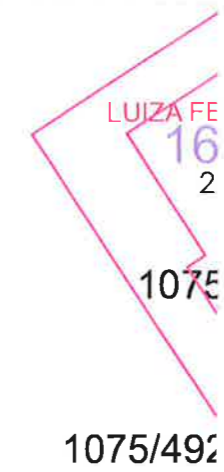
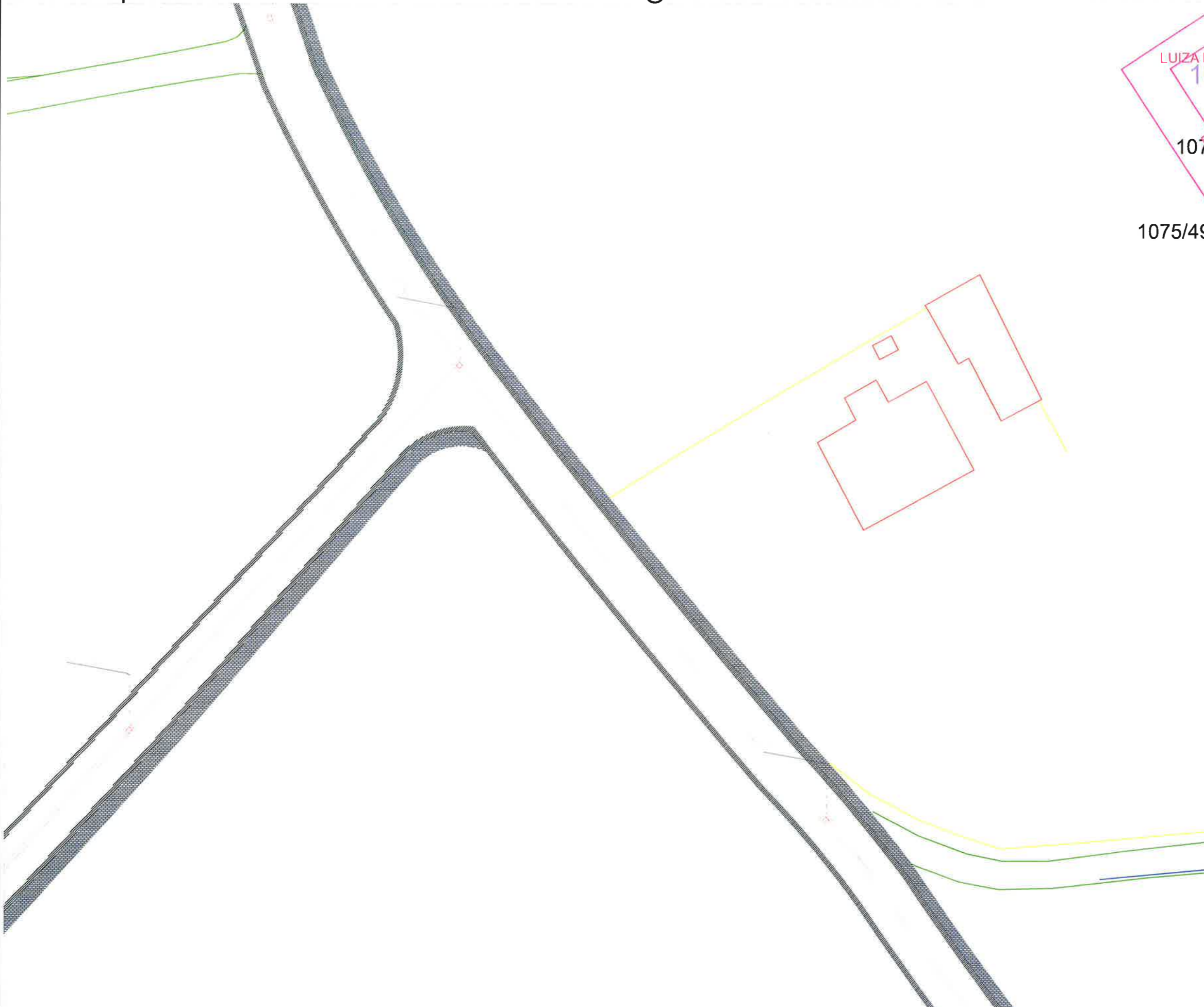

Fleta Nr.
21

BLEKESJES TRAFIEV

OBJEKTI: "Ndertimi i rrjetit te kanalizimeve te ujrave te zeza te lagjeve perreth ujembledhesit te Paskuqanit dhe ndertimi i vazhdimit te rruges "ALI DEMI"



LEGJENDA

-  SIPERFAQE ASFALTI
-  OBJEKTE
-  RRUGE EKZISTUESE
-  KUNETE
-  TROTUAR



BASHKIA KAMEZ

DREJTORIA E SHERBIMEVE PUBLIKE
DREJTORIA E PROJEKTEVE DHE INVESTIMEVE
DEPARTAMENTI I PROJEKTEVE

Dr. e Projekteve e Investimeve FLORA MUÇA
Pergj. Depart. Sektori te Projekteve EMANUELA MEZIU

STAFI TEKNIK PROJEKTES	Ing.	DENIS	PRENCI
	Ing.	ERBLIN	LALA
	Ing.	EGLANTINA	DISHA
	Ing.	RAMADAN	HYSA

Faza e Projektit:
OBJEKTI: "Ndertimi i rrjetit te kanalizimeve te ujrave te zeza te lagjeve perreth ujembledhesit te Paskuqanit dhe ndertimi i vazhdimit te rruges "ALI DEMI"
Data e Implementimit:

to b
to b
Faza e Projektit:
PROJEKT ZBATIMI
Data e Implementimit:

Emeritimi i Fletes:





PLANIMETRI KUN
Rruga te Liqeni i Paskuqanit

Fleta Nr.
23

OBJEKTI: "Ndertimi i rrjetit te kanalizimeve te ujrave te zeza te lagjeve perreth ujembledhesit te Paskuqanit dhe ndertimi i vazhdimit te rruges "ALI DEMI"



LEGJENDA

-  SIPERFAQE ASFALTI
-  OBJEKTE
-  RRUGE EKZISTUESE
-  KUNETE
-  TROTUAR



BASHKIA KAMEZ

DREJTORIA E SHERBIMEVE PUBLIKE
DREJTORIA E PROJEKTEVE DHE INVESTIMEVE
DEPARTAMENTI I PROJEKTEVE

Dr. e Projekteve e Investimeve FLORA MUÇA

Pergj. Depart. Sektori te Projekteve EMANUELA MEZIU

STAFI TEKNIK
PROJEKTUES
Ing. DENIS PRENCI
Ing. ERBLIN LALA
Ing. EGLANTINA DISHA
Ing. RAMADAN HYSA

Titulli i Projektit:
OBJEKTI: "Ndertimi i rrjetit te kanalizimeve te ujrave te zeza te lagjeve perreth ujembledhesit te Paskuqanit dhe ndertimi i vazhdimit te rruges "ALI DEMI"

Faza e Projektit:
PROJEKT ZBATIMI

Data e Implementimit:

Shkalla e Vizimit:

Emertimi i Fletes:

PLANIMETRI KUN
Rruga te Liqeni i Paskuqanit



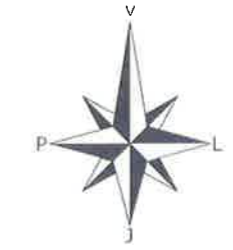

Fleta Nr.

24

OBJEKTI: "Ndertimi i rrjetit te kanalizimeve te ujrave te zeza te lagjeve perreth ujembledhesit te Paskuqanit dhe ndertimi i vazhdimit te rruges "ALI DEMI"



LEGJENDA

-  SIPERFAQE ASFALTI
-  OBJEKTE
-  RRUGE EKZISTUESE
-  KUNETE
-  TROTUAR



BASHKIA KAMEZ

DREJTORIA E SHERBIMEVE PUBLIKE
DREJTORIA E PROJEKTEVE DHE INVESTIMEVE
DEPARTAMENTI I PROJEKTEVE

Dr. e Projekteve e Investimeve FLORA MUÇA
Pergj. Depart. Sektori te Projekteve EMANUELA MEZIU

STAFI TEKNIK
PROJEKTES

Ing.	DENIS	PRENCI
Ing.	ERBLIN	LALA
Ing.	EGLANTINA	DISHA
Ing.	RAMADAN	HYSA

Titulli i Projektit:
OBJEKTI: "Ndertimi i rrjetit te kanalizimeve te ujrave te zeza te lagjeve perreth ujembledhesit te Paskuqanit dhe ndertimi i vazhdimit te rruges "ALI DEMI"

Faza e Projektit:
PROJEKT ZBATIMI

Data e Implementimit:

Emertimi i Fletes:

PLANIMETRI KUN
Rruga te Liqeni i Paskuqanit





Fleta Nr.
25

OBJEKTI: "Ndertimi i rrjetit te kanalizimeve te ujrave te zeza te lagjeve perreth ujembledhesit te Paskuqanit dhe ndertimi i vazhdimit te rruges "ALI DEMI"

ARTAN ZEF VLADI



LEGJENDA

-  SIPERFAQE ASFALTI
-  OBJEKTE
-  RRUGE EKZISTUESE
-  KUNETE
-  TROTUAR



BASHKIA KAMEZ

DREJTORIA E SHERBIMEVE PUBLIKE
DREJTORIA E PROJEKTEVE DHE INVESTIMEVE
DEPARTAMENTI I PROJEKTEVE

Dr. e Projekteve e Investimeve FLORA MUÇA
Pergj. Depart. Sektori te Projekteve EMANUELA MEZIU

STAFI TEKNIK
PROJEKTES
Ing. DENIS PRENCI
Ing. ERBLIN LALA
Ing. EGLANTINA DISHA
Ing. RAMADAN HYSA

Titulli i Projektit:
OBJEKTI: "Ndertimi i rrjetit te kanalizimeve te ujrave te zeza te lagjeve perreth ujembledhesit te Paskuqanit dhe ndertimi i vazhdimit te rruges "ALI DEMI"

Faza e Projektit:
PROJEKT ZBATIMI

Data e Implementimit:

Shkalla e Vizatimit:

Emerjimi i Fletes:

PLANIMETRI KUN
Rruga te Liqeni i Paskuqanit





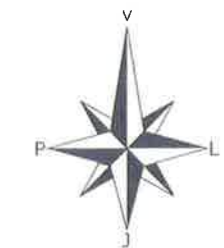

Fleta Nr.
26

ALI HAZIZ TERSHALLI

OBJEKTI: "Ndertimi i rrjetit te kanalizimeve te ujrave te zeza te lagjeve perreth ujembledhesit te Paskuqanit dhe ndertimi i vazhdimit te rruges "ALI DEMI"



LEGJENDA

-  SIPERFAQE ASFALTI
-   OBJEKTE
-  RRUGE EKZISTUESE
-  KUNETE
-  TROTUAR



BASHKIA KAMEZ

DREJTORIA E SHERBIMEVE PUBLIKE
DREJTORIA E PROJEKTEVE DHE INVESTIMEVE
DEPARTAMENTI I PROJEKTEVE

Dr. e Projekteve e Investimeve FLORA MUÇA
Pergj. Depart. Sektori te Projekteve EMANUELA MEZIU

STAFI TEKNIK PROJEKTES	Ing.	DENIS	PRENCI
	Ing.	ERBLIN	LALA
	Ing.	EGLANTINA	DISHA
	Ing.	RAMADAN	HYSA

Titulli i Projektit:
OBJEKTI: "Ndertimi i rrjetit te kanalizimeve te ujrave te zeza te lagjeve perreth ujembledhesit te Paskuqanit dhe ndertimi i vazhdimit te rruges "ALI DEMI"

Faza e Projektit:
PROJEKTI ZBATIMI

Data e Implementimit:

Shkalla e Vizimit:

Emertimi i Fletes:
PLANIMETRI TROTUARI
Rruga te Liqeni i Paskuqanit

Fleta Nr.
27

OBJEKTI: "Ndertimi i rrjetit te kanalizimeve te ujrave te zeza te lagjeve perreth ujembledhesit te Paskuqanit dhe ndertimi i vazhdimit te rruges "ALI DEMI"



LEGJENDA

 SIPERFAQE ASFALTI

 OBJEKTE

 RRUGE EKZISTUESE

 KUNETE

 TROTUAR



BASHKIA KAMEZ

DREJTORIA E SHERBIMEVE PUBLIKE
DREJTORIA E PROJEKTEVE DHE INVESTIMEVE
DEPARTAMENTI I PROJEKTEVE

Dr. e Projekteve e Investimeve FLORA MUÇA

Pergj. Depart. Sektorit te Projekteve EMANUELA MEZIU

STAFI TEKNIK
PROJEKTUES
Ing. DENIS PRENCI
Ing. ERBLIN LALA
Ing. EGLANTINA DISHA
Ing. RAMADAN HYSA

Titulli i Projektit:
OBJEKTI: "Ndertimi i rrjetit te kanalizimeve te ujrave te zeza te lagjeve perreth ujembledhesit te Paskuqanit dhe ndertimi i vazhdimit te rruges "ALI DEMI"

Faza e Projektit:
PROJEKT ZBATIMI

Data e Implementimit:

Shkalla e Vizatimit:

Emertimi i Fletes:





PLANIMETRI TROTUARI
Rruga te Liqeni i Paskuqanit

Fleta Nr.
28

OBJEKTI: "Ndertimi i rrjetit te kanalizimeve te ujrave te zeza te lagjeve perreth ujembledhesit te Paskuqanit dhe ndertimi i vazhdimit te rruges "ALI DEMI"

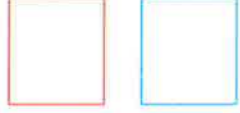

LEGJENDA

-  SIPERFAQE ASFALTI
-  OBJEKTE
-  RRUGE EKZISTUESE
-  KUNETE
-  TROTUAR



BASHKIA KAMEZ

DREJTORIA E SHERBIMEVE PUBLIKE
DREJTORIA E PROJEKTEVE DHE INVESTIMEVE
DEPARTAMENTI I PROJEKTEVE

Dr. e Projekteve e Investimeve FLORA MUÇA
Pergj,Depart. Sektori te Projekteve EMANUELA MEZIU

STAFI TEKNIK PROJEKTES	Ing.	DENIS	PRENCI
	Ing.	ERBLIN	LALA
	Ing.	EGLANTINA	DISHA
	Ing.	RAMADAN	HYSA

Tiulli i Projektit:
OBJEKTI: "Ndertimi i rrjetit te kanalizimeve te ujrave te zeza te lagjeve perreth ujembledhesit te Paskuqanit dhe ndertimi i vazhdimit te rruges "ALI DEMI"
Faza e Projektit: PROJEKT ZBATIMI
Data e Implementimit:



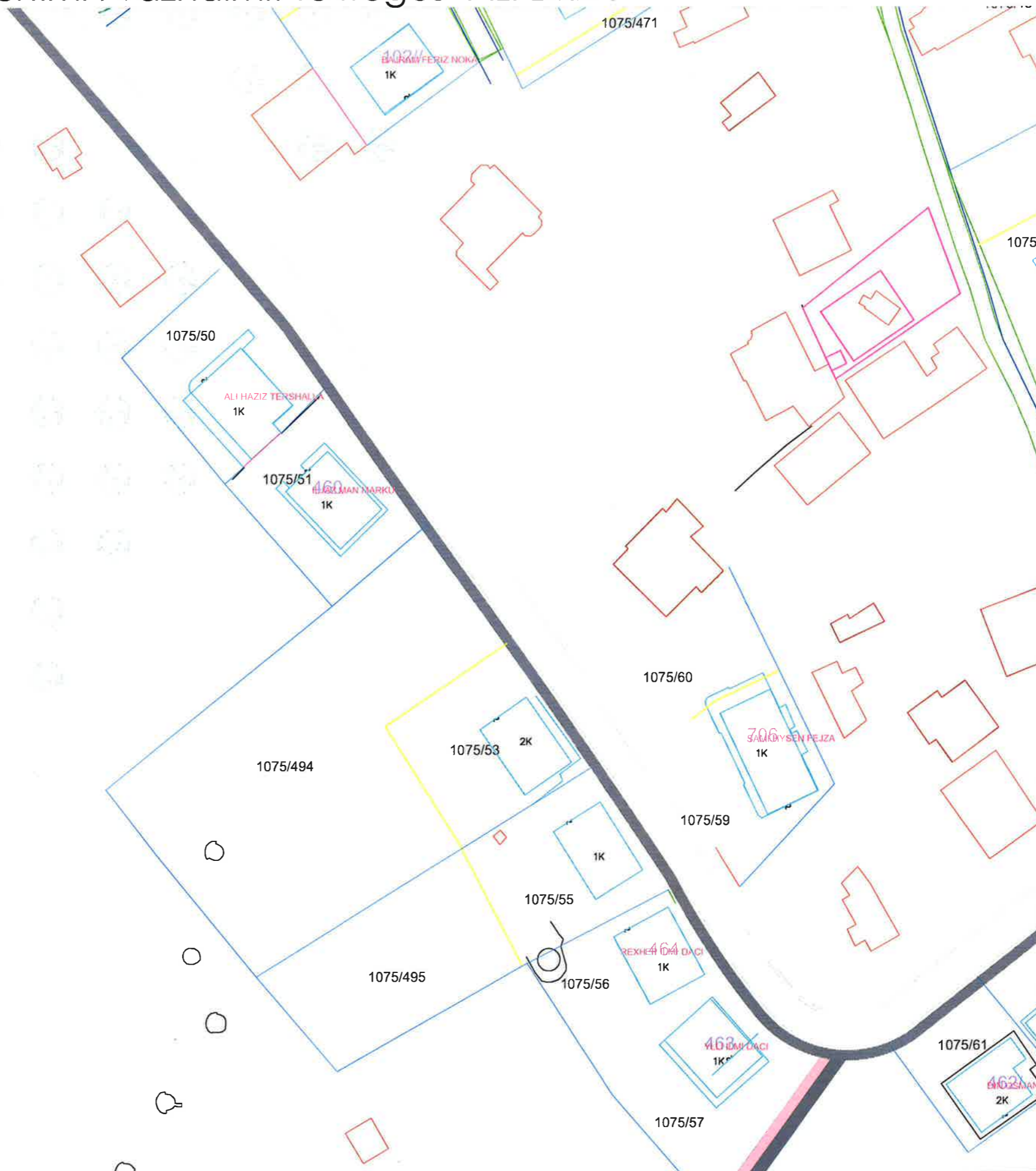

Shtalla e Vizatimit:
Emertimi i Fletes:

PLANIMETRI TROTUARI
Rruga te Liqeni i Paskuqanit
Fleta Nr. 29

OBJEKTI: "Ndertimi i rrjetit te kanalizimeve te ujrave te zeza te lagjeve perreth ujembledhesit te Paskuqanit dhe ndertimi i vazhdimit te rruges "ALI DEMI"



LEGJENDA

-  SIPERFAQE ASFALTI
-  OBJEKTE
-  RRUGE EKZISTUESE
-  KUNETE
-  TROTUAR



BASHKIA KAMEZ

DREJTORIA E SHERBIMEVE PUBLIKE
DREJTORIA E PROJEKTEVE DHE INVESTIMEVE
DEPARTAMENTI I PROJEKTEVE

Dr. e Projekteve e Investimeve FLORA MUÇA
Pergj. Depart. Sektori te Projekteve EMANUELA MEZIU

STAFI TEKNIK PROJEKTES	Ing. DENIS PRENCI
	Ing. ERBLIN LALA
	Ing. EGLANTINA DISHA
	Ing. RAMADAN HYSA

Titulli i Projektit:
OBJEKTI: "Ndertimi i rrjetit te kanalizimeve te ujrave te zeza te lagjeve perreth ujembledhesit te Paskuqanit dhe ndertimi i vazhdimit te rruges "ALI DEMI"

Faza e Projektit:
PROJEKT ZBATIMI

Data e Implementimit:

Shkalla e Vizatimit:

Emertimi i Fletes:
PLANIMETRI TROTUARI
Rruga te Liqeni i Paskuqanit

Fleta Nr.
30

OBJEKTI: "Ndertimi i rrjetit te kanalizimeve te ujrave te zeza te lagjeve perreth ujembledhesit te Paskuqanit dhe ndertimi i vazhdimit te rruges "ALI DEMI"

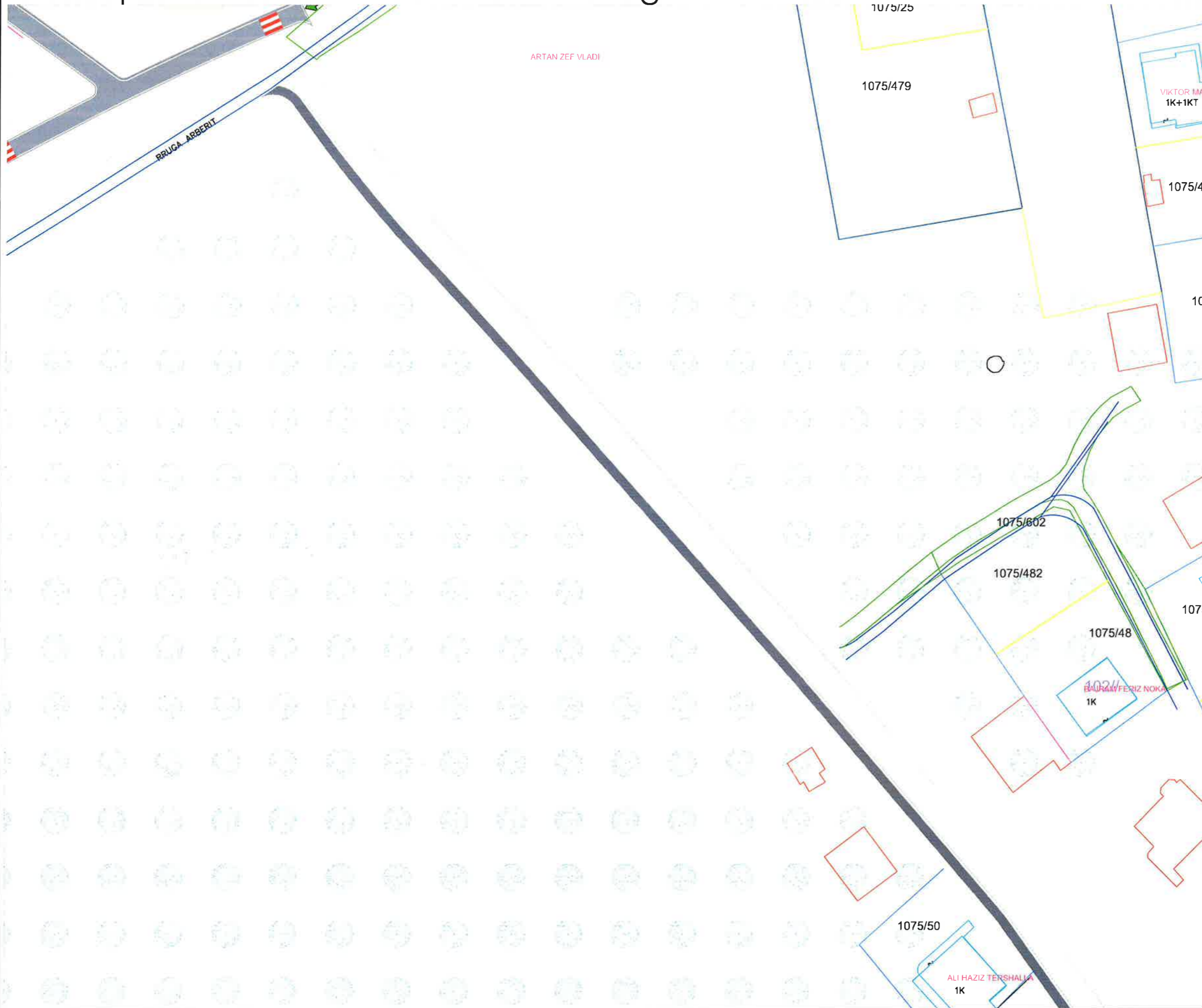

LEGJENDA

- SIPERFAQE ASFALTI
- OBJEKTE
- RRUGE EKZISTUESE
- KUNETE
- TROTUAR

BASHKIA KAMEZ
 DREJTORIA E SHERBIMEVE PUBLIKE
 DREJTORIA E PROJEKTEVE DHE INVESTIMEVE
 DEPARTAMENTI I PROJEKTEVE

Dr. e Projekteve e Investimeve **FLORA MUÇA**
 Pergj. Depart. Sektori te Projekteve **EMANUELA MEZIU**

STAFI TEKNIK PROJEKTES	Ing.	DENIS	PRENCI
	Ing.	ERBLIN	LALA
	Ing.	EGLANTINA	DISHA
	Ing.	RAMADAN	HYSA







Titulli i Projektit:
 OBJEKTI: "Ndertimi i rrjetit te kanalizimeve te ujrave te zeza te lagjeve perreth ujembledhesit te Paskuqanit dhe ndertimi i vazhdimit te rruges "ALI DEMI"
Faza e Projektit:
 PROJEKT ZBATIMI
Data e Implementimit:

Emertimi i Fletes:
PLANIMETRI TROTUARI
 Rruga te Liqeni i Paskuqanit
Fleta Nr.
31

OBJEKTI: "Ndertimi i rrjetit te kanalizimeve te ujrave te zeza te lagjeve perreth ujembledhesit te Paskuqanit dhe ndertimi i vazhdimit te rruges "ALI DEMI"

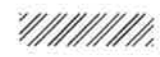

LEGJENDA

-  SIPERFAQE ASFALTI
-   OBJEKTE
-  RRUGE EKZISTUESE
-  KUNETE
-  TROTUAR



BASHKIA KAMEZ

DREJTORIA E SHERBIMEVE PUBLIKE
DREJTORIA E PROJEKTEVE DHE INVESTIMEVE
DEPARTAMENTI I PROJEKTEVE

Dr. e Projekteve e Investimeve FLORA MUÇA

Pergj, Depart, Sektori te Projekteve EMANUELA MEZIU

STAFI TEKNIK PROJEKTES	Ing.	DENIS	PRENCI
	Ing.	ERBLIN	LALA
	Ing.	EGLANTINA	DISHA
	Ing.	RAMADAN	HYSA

Titulli i Projektit:

OBJEKTI: "Ndertimi i rrjetit te kanalizimeve te ujrave te zeza te lagjeve perreth ujembledhesit te Paskuqanit dhe ndertimi i vazhdimit te rruges "ALI DEMI"

Faza e Projektit
PROJEKT ZBATIMI

Data e Implementimit:

Shkalla e Vizatimit:

Emertimi i Fletes:





PLANIMETRI TROTUARI
Rruga te Liqeni i Paskuqanit

Fleta Nr.
32

OBJEKTI: "Ndertimi i rrjetit te kanalizimeve te ujrave te zeza te lagjeve perreth ujembledhesit te Paskuqanit dhe ndertimi i vazhdimit te rruges "ALI DEMI"



LEGJENDA

-  SIPERFAQE ASFALTI
-  OBJEKTE
-  RRUGE EKZISTUESE
-  KUNETE
-  TROTUAR



BASHKIA KAMEZ

DREJTORIA E SHERBIMEVE PUBLIKE
DREJTORIA E PROJEKTEVE DHE INVESTIMEVE
DEPARTAMENTI I PROJEKTEVE

Dr. e Projekteve e Investimeve FLORA MUÇA
Pergj, Depart. Sektori te Projekteve EMANUELA MEZIU

STAFI TEKNIK PROJEKTUES	Ing.	DENIS	PRENCI
	Ing.	ERBLIN	LALA
	Ing.	EGLANTINA	DISHA
	Ing.	RAMADAN	HYSA





Titulli i Projektit:
OBJEKTI: "Ndertimi i rrjetit te kanalizimeve te ujrave te zeza te lagjeve perreth ujembledhesit te Paskuqanit dhe ndertimi i vazhdimit te rruges "ALI DEMI"
Faza e Projektit: PROJEKT ZBATIMI
Data e Implementimit:

Emertimi i Fletes:
Shkalla e Vizatimit:

OBJEKTI: "Ndertimi i rrjetit te kanalizimeve te ujrave te zeza te lagjeve perreth ujembledhesit te Paskuqanit dhe ndertimi i vazhdimit te rruges "ALI DEMI"



LEGJENDA

-  SIPERFAQE ASFALTI
-  OBJEKTE
-  RRUGE EKZISTUESE
-  KUNETE
-  TROTUAR



BASHKIA KAMEZ

DREJTORIA E SHERBIMEVE PUBLIKE
DREJTORIA E PROJEKTEVE DHE INVESTIMEVE
DEPARTAMENTI I PROJEKTEVE

Dr. e Projekteve e Investimeve FLORA MUÇA

Pergj, Depart, Sektori te Projekteve EMANUELA MEZIU

STAFI TEKNIK PROJEKTUES	Ing. DENIS PRENCI
	Ing. ERBLIN LALA
	Ing. EGLANTINA DISHA
	Ing. RAMADAN HYSA

Titulli i Projektit:
OBJEKTI: "Ndertimi i rrjetit te kanalizimeve te ujrave te zeza te lagjeve perreth ujembledhesit te Paskuqanit dhe ndertimi i vazhdimit te rruges "ALI DEMI"

Faza e Projektit
PROJEKTI ZBATIM

Data e kompletimit:

Emertimi i Fletes:

PLANIMETRI KUB
Rruga te Liqeni i Paskuqanit

Fleta Nr.

34

OBJEKTI: "Ndertimi i rrjetit te kanalizimeve te ujrave te zeza te lagjeve perreth ujembledhesit te Paskuqanit dhe ndertimi i vazhdimit te rruges "ALI DEMI"



LEGJENDA

SIPERFAQE ASFALTI

OBJEKTE

RRUGE EKZISTUESE

KUNETE

TROTUAR

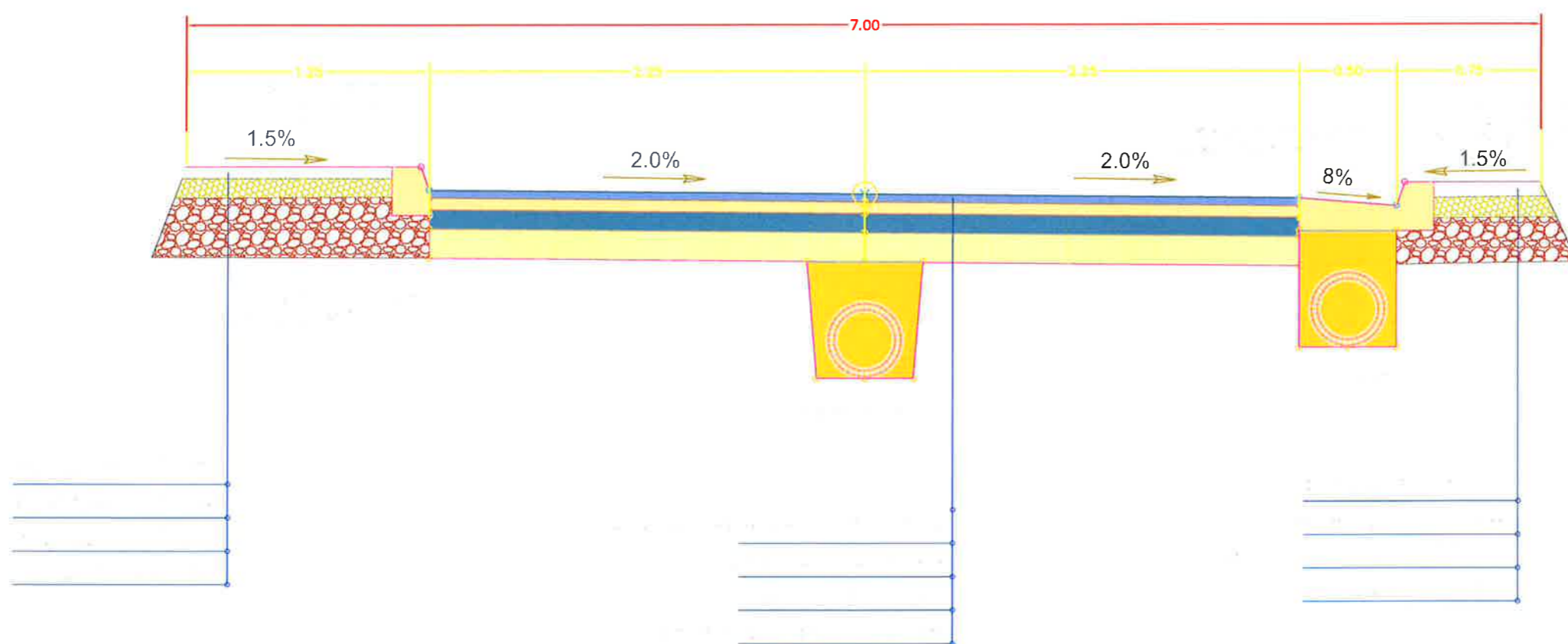

BASHKIA KAMEZ

DREJTORIA E SHERBIMEVE PUBLIKE
DREJTORIA E PROJEKTEVE DHE INVESTIMEVE
DEPARTAMENTI I PROJEKTEVE

Dr. e Projekteve e Investimeve FLORA MUÇA
Pergj. Depart. Sektori te Projekteve EMANUELA MEZIU

STAFI TEKNIK
PROJEKTUES
Ing. DENIS PRENCI
Ing. ERBLIN LALA
Ing. EGLANTINA DISHA
Ing. RAMADAN HYSA

Faza e Projektit: PROJEKT ZBATIMI
Data e Implementimit:
Shkalla e Vizatimit:

Emertimi i Fletes:
PLANIMETRI TIP
Rruga te Liqeni i Paskuqanit

Fleta Nr.
35

Objekti: "Ndertimi i rrjetit te kanalizimeve te ujrave te zeza te lagjeve perreth ujembledhesit te Paskuqanit dhe ndertimi i vazhdimit te Rruges "Ali Demi"



PROFILI GJATESOR
Aksi i rruges Letter Talo
SH_H - 1:1000
SH_V - 1:100

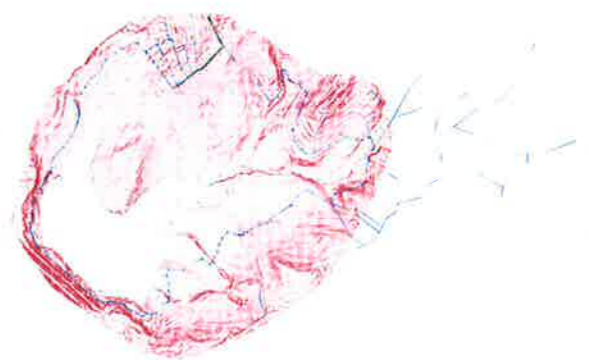
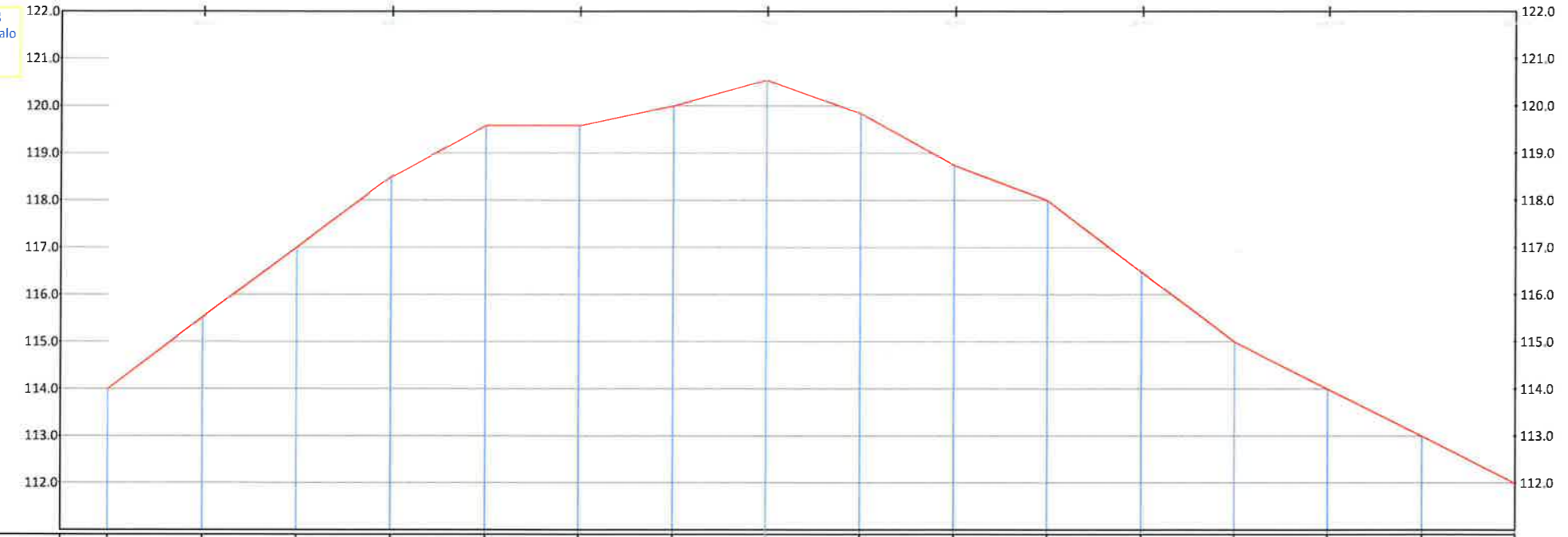

KUOTA TOKES	0+000	0+010	0+020	0+030	0+040	0+050	0+060	0+070	0+080	0+090	0+100	0+110	0+120	0+130	0+140	0+150																																																																																			
DIST PROGRESIVE	124.91	124.81	124.58	124.35	124.14	123.98	123.70	123.34	122.94	122.54	122.24	121.54	120.87	120.27	119.93	119.43																																																																																			
DIST PJESORE	5.00	10.00	10.00	10.00	10.00	10.00	10.00	10.00	10.00	10.00	10.00	10.00	10.00	10.00	10.00	10.00																																																																																			
NR I PRERJES	CS-1	CS-2	CS-4	CS-5	CS-6	CS-7	CS-8	CS-9	CS-10	CS-11	CS-12	CS-13	CS-14	CS-15	CS-16	CS-17	CS-18	CS-19	CS-20	CS-21	CS-22	CS-23	CS-24	CS-25	CS-26	CS-27	CS-28	CS-29	CS-30	CS-31	CS-32	CS-33	CS-34	CS-35	CS-36	CS-37	CS-38	CS-39	CS-40	CS-41	CS-42	CS-43	CS-44	CS-45	CS-46	CS-47	CS-48	CS-49	CS-50	CS-51	CS-52	CS-53	CS-54	CS-55	CS-56	CS-57	CS-58	CS-59	CS-60	CS-61	CS-62	CS-63	CS-64	CS-65	CS-66	CS-67	CS-68	CS-69	CS-70	CS-71	CS-72	CS-73	CS-74	CS-75	CS-76	CS-77	CS-78	CS-79	CS-80	CS-81	CS-82	CS-83	CS-84	CS-85	CS-86	CS-87	CS-88	CS-89	CS-90	CS-91	CS-92	CS-93	CS-94	CS-95	CS-96	CS-97	CS-98	CS-99	CS-100
KILOMETRAZHI	[Scale bar from 0 to 150 meters]																																																																																																		

BASHKIA KAMEZ
DREJTORIA E PROJEKTEVE DHE INVESTIMEVE
DEPARTAMENTI I PROJEKTEVE

Dr. e Projekteve e Investimeve: FLORA MUÇA
Prgj. e Projekteve: EMANUELA MEZIU

STAFI TEKNIK PROJEKTES
Ing. Konstruktor: DENIS PRENÇI
Ing. Gjeoinformatik: ERBLIN LALA
Ing. Preventivues: EGLANTINA DISHA
Topograf: RAMADAN HYSA

Titulli i Projektit:
"Ndertimi i rrjetit te kanalizimeve te ujrave te zeza te lagjeve perreth ujembledhesit te Paskuqanit dhe ndertimi i vazhdimit te Rruges "Ali Demi"

Emertimi i Fletes: PROFIL GJATESOR RRUGA ALI DEMI
Fleta Nr. S-29

Faza e Projektit:
PROJEKT ZBATIMI
Data e Implementimit:
Shkalla e Vizatimit: 1:1000

Objekti: "Ndertimi i rrjetit te kanalizimeve te ujrave te zeza te lagjeve perreth ujembledhesit te Paskuqanit dhe ndertimi i vazhdimit te Rruges "Ali Demi"



PROFILI GJATESOR
Aksi i rruges Letter Talo
SH_H- 1:1000
SH_V- 1:100

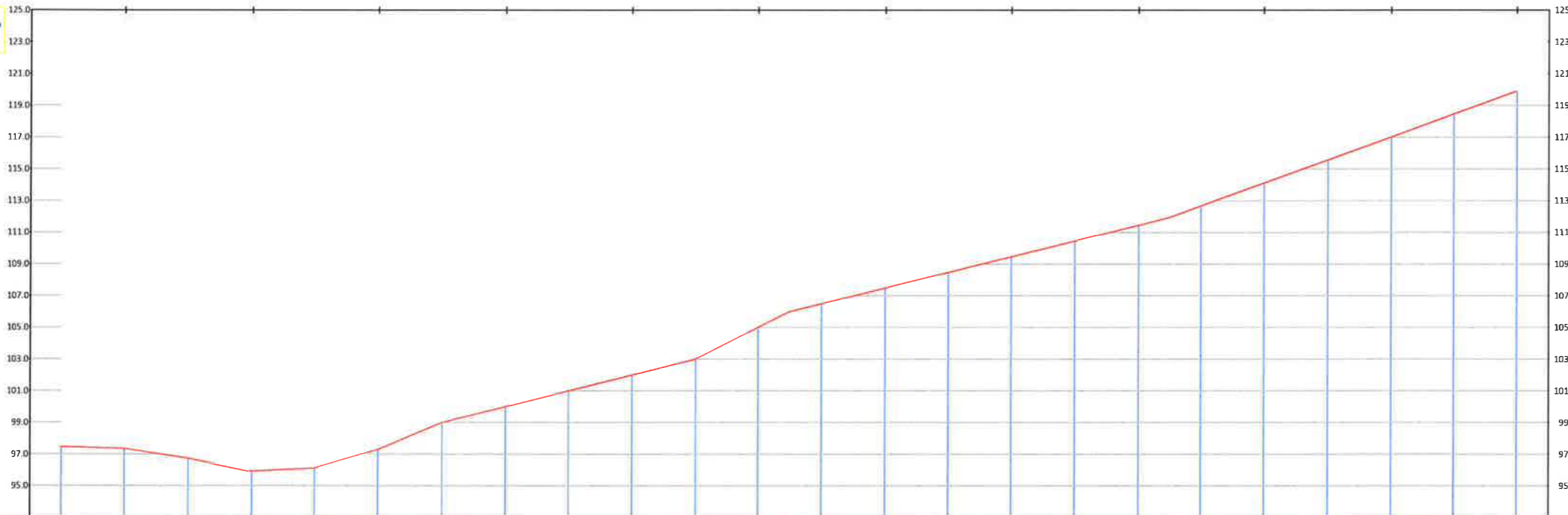

KUOTA TOKES	0+000	0+010	0+020	0+030	0+040	0+050	0+060	0+070	0+080	0+090	0+100	0+110	0+120	0+130	0+140	0+150	0+160	0+170	0+180	0+190	0+200	0+210	0+220	0+230	
DIST PROGRESIVE	0+000	0+010	0+020	0+030	0+040	0+050	0+060	0+070	0+080	0+090	0+100	0+110	0+120	0+130	0+140	0+150	0+160	0+170	0+180	0+190	0+200	0+210	0+220	0+230	
DIST PJESORE	20.00	35.00	35.00	35.00	35.00	35.00	35.00	35.00	35.00	35.00	35.00	35.00	35.00	35.00	35.00	35.00	35.00	35.00	35.00	35.00	35.00	35.00	35.00	20.00	
NR I PRERJES	05.1	05.2	05.3	05.4	05.5	05.6	05.7	05.8	05.9	06.0	06.1	06.2	06.3	06.4	06.5	06.6	06.7	06.8	06.9	07.0	07.1	07.2	07.3	07.4	
KILOMETRAZHI	[Scale bar from 0 to 230 meters]																								



BASHKIA KAMEZ

DREJTORIA E PROJEKTEVE DHE INVESTIMEVE
DEPARTAMENTI I PROJEKTEVE

Dr. e Projekteve e Investimeve
Proj. e Projekteve

FLORA MUÇA
EMANUELA MEZIU

STAFI TEKNIK
PROJEKTUES

Ing. Konstruktor DENIS PRENÇI
Ing. Gjeoinformatik ERLIN LALA
Ing. Preventivues EGLANTINA DISHA
Topograf RAMADAN HYSA

Titulli i Projektit:
"Ndertimi i rrjetit te kanalizimeve te ujrave te zeza te lagjeve perreth ujembledhesit te Paskuqanit dhe ndertimi i vazhdimit te Rruges "Ali Demi"

Faza e Projektit:
PROJEKT ZBATIMI

Data e implementimit:

Emertimi i Fletes:

Shkalla e Vizimit: 1:1000

Fleta Nr.

PROFILI GJATESOR RRUGA ALI DEMI

S-30

Objekti: "Ndertimi i rrjetit te kanalizimeve te ujrave te zeza te lagjeve perreth ujembledhesit te Paskuqanit dhe ndertimi i vazhdimit te Rrugës "Ali Demi"

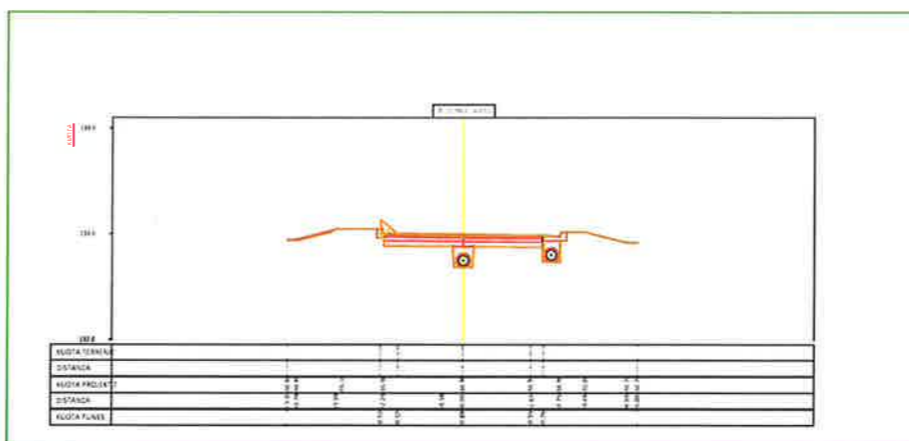
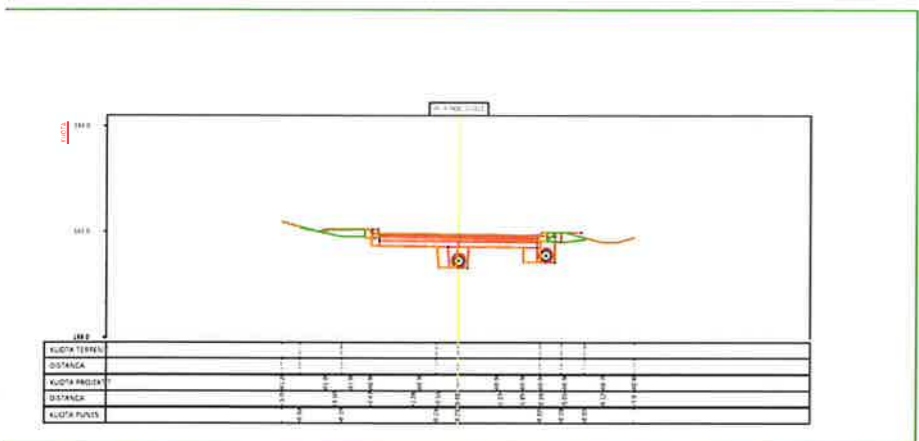
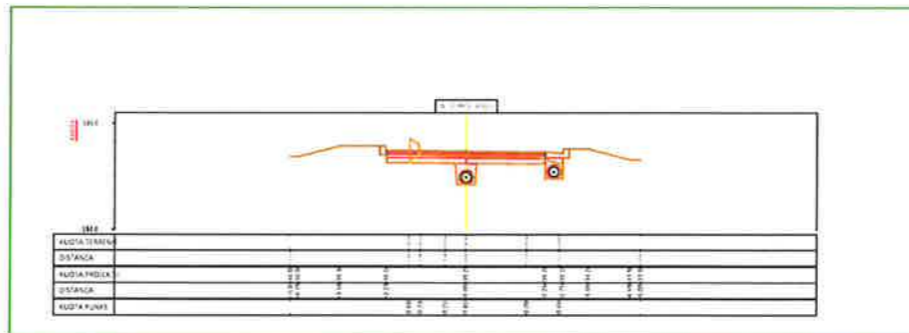
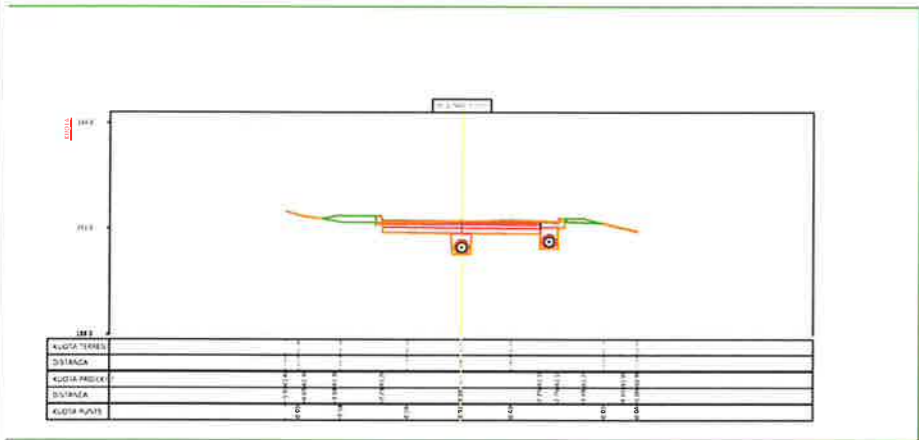
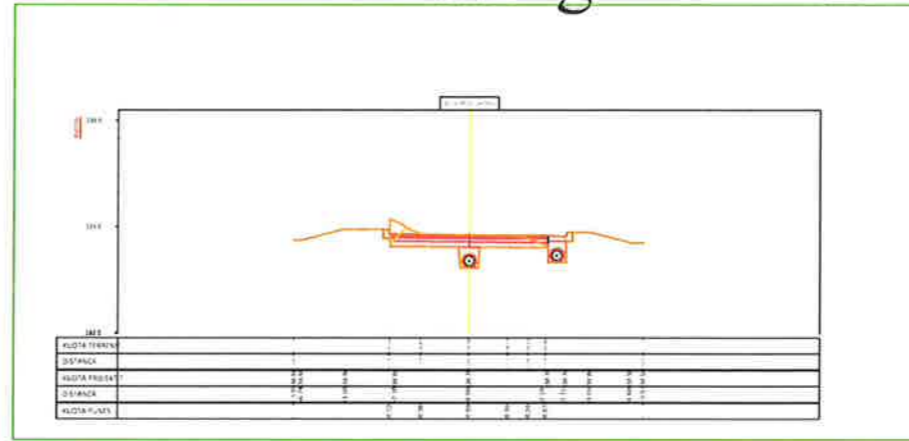
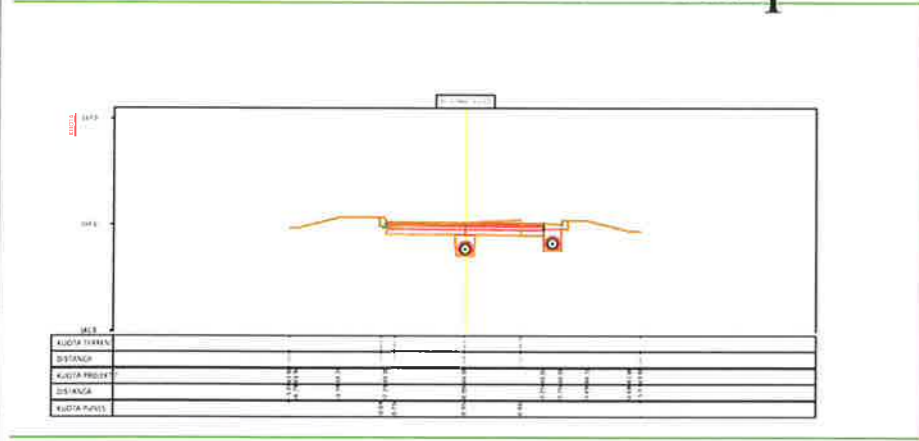

BASHKIA KAMEZ

DREJTORIA E PROJEKTEVE DHE INVESTIMEVE
DEPARTAMENTI I PROJEKTEVE

Dr. e Projekteve e Investimeve FLORA MUÇA
Prqj. e Projekteve EMANUELA MEZIU

STAFI TEKNIK
PROJEKTUES
Ing. Konstruktor DENIS PRENÇI
Ing. Gjeoinformatik ERBLIN LALA
Ing. Preventivues EGLANTINA DISHA
Topograf RAMADAN HYSA

Titulli i Projektit:
"Ndertimi i rrjetit te kanalizimeve te ujrave te zeza te lagjeve perreth ujembledhesit te Paskuqanit dhe ndertimi i vazhdimit te Rrugës "Ali Demi"

Faza e Projektit:
PROJEKT ZBATIMI
Data e Implementimit:

Shkalla e Vizimit: 1:1000

Emertimi i Fletës:

PROFIL TERTHOR RRUGA ALI DEMI

Fleta Nr.

S-34

DETAJ I SHTYLLES H-9.0m+ KRAH 1.5X1.5m ME NDRICUES SMART 250W DHE PUSETE BETONI 40X40X100cm

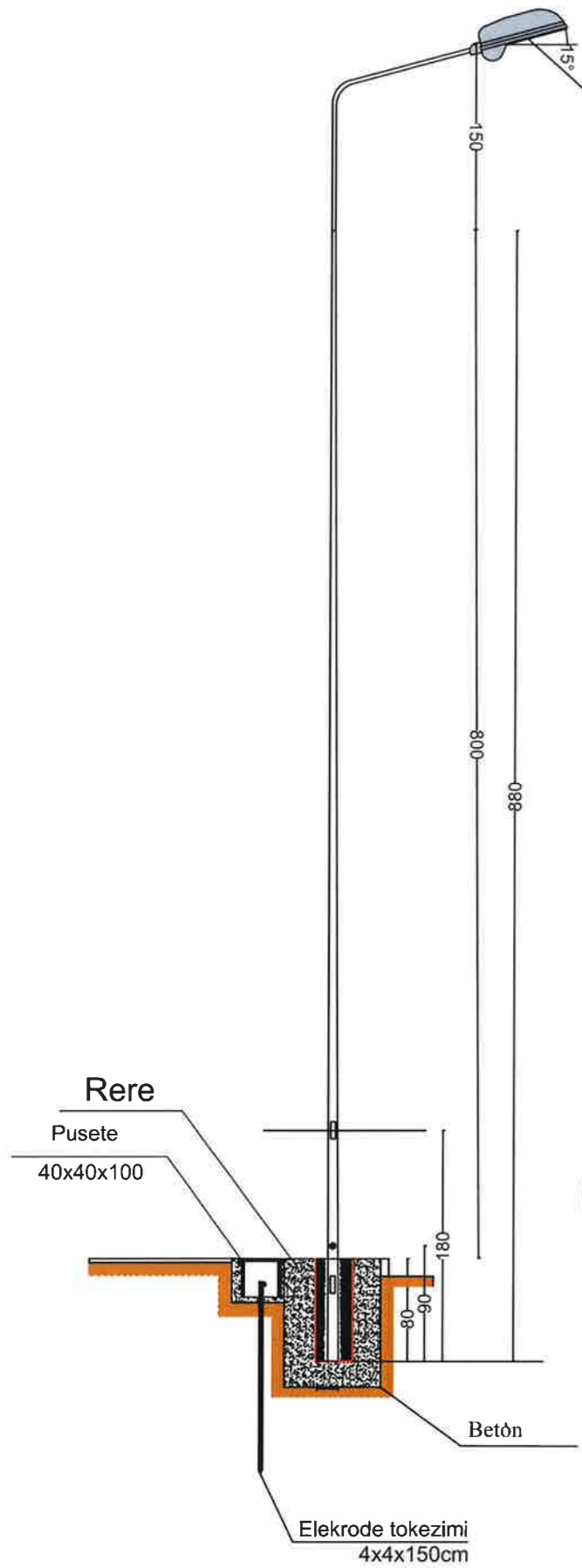

SHTYLLË ELEKTRIKE ME PUSETË NË TOKË ME LIDHJE EKUIPOTENCIALE DHE MORSETERIA E LINJËS SË NDRIÇIMIT

NDRICUES TIP "SMART" SAP-T 150 CNR

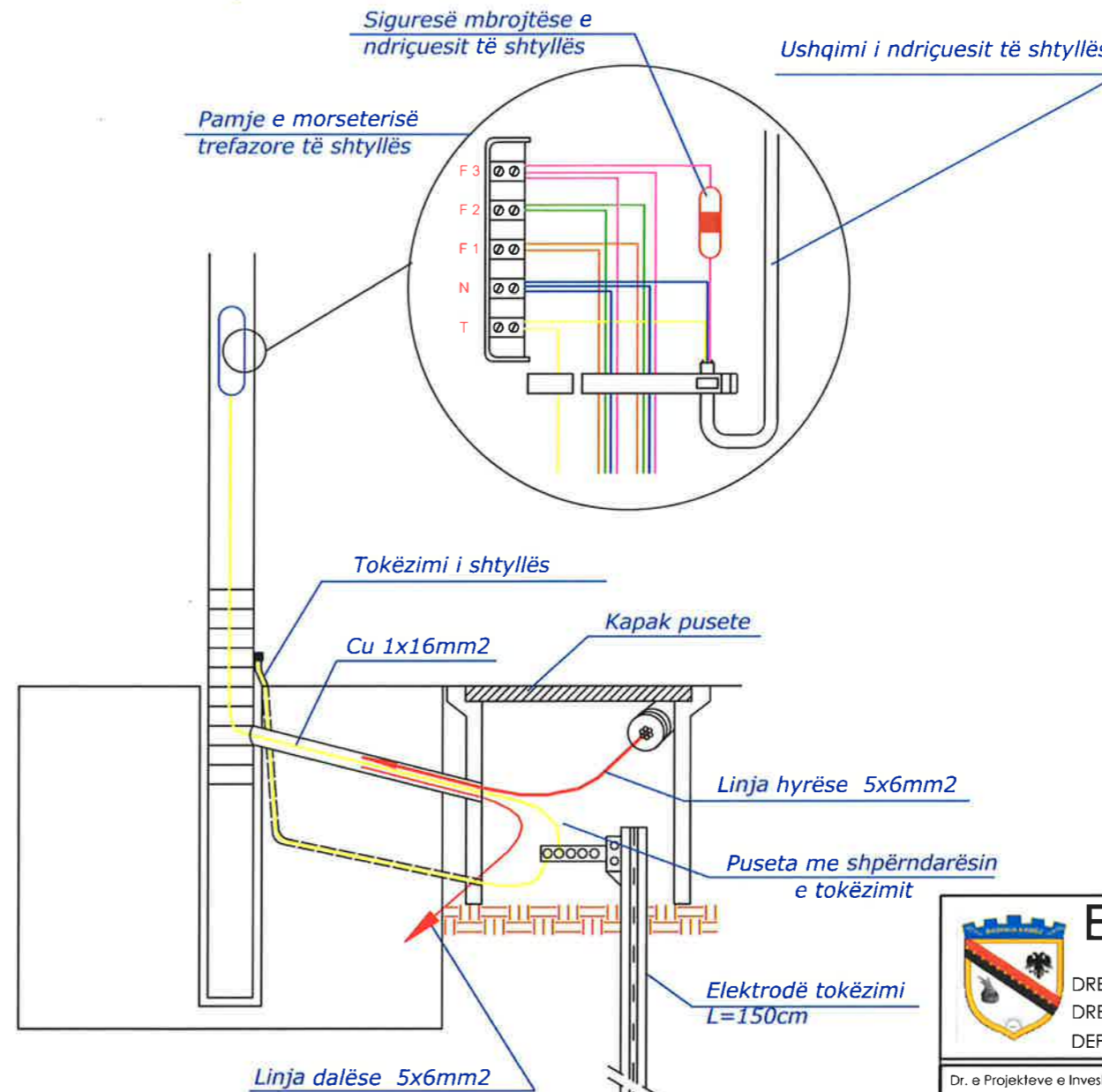
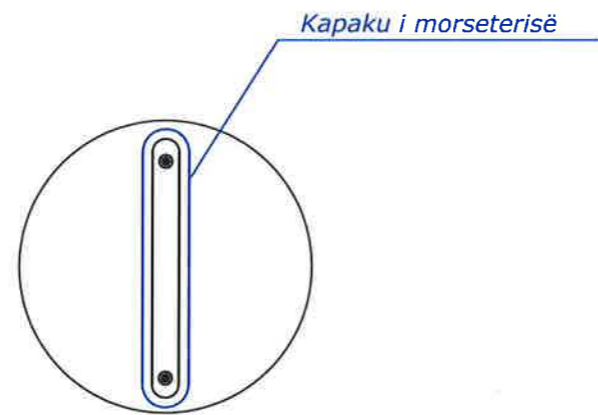

BASHKIA KAMEZ
 DREJTORIA E SHERBIMEVE PUBLIKE
 DREJTORIA E PROJEKTEVE DHE INVESIMEVE
 DEPARTAMENTI E PROJEKTEVE

Dr. e Projekteve e Investimeve	FLORA MUÇA	
Prgj. e Projekteve	EMANUELA MEZIU	
STAFI TEKNIK	Ing. DENIS PRENCI	[Signature]
PROJEKTUES	Ing. ERBLIN LALA	
	Ing. EGLANTINA DISHA	
	Ing. RAMADAN HYSA	
Titulli i Projektit		Faza e Projektit
OBJEKTI: "Nderimi i rrjetit të kanalizimeve të ujrave të zeza të lagjeve përreth ujmbledhësit të Paskuqanit dhe nderimi i vazhimit të rruges "ALI DEMI"		PROJEKT ZBATIMI
Emertimi i Fletes		Data e Implementimit:
DETAJ I NDRICIMIT RRUGOR		Shkalla e Vizatimit:
		Fleta Nr.:

Detaj i inkastrimit të kolonës së ndriçuesit me lartësi H=9m

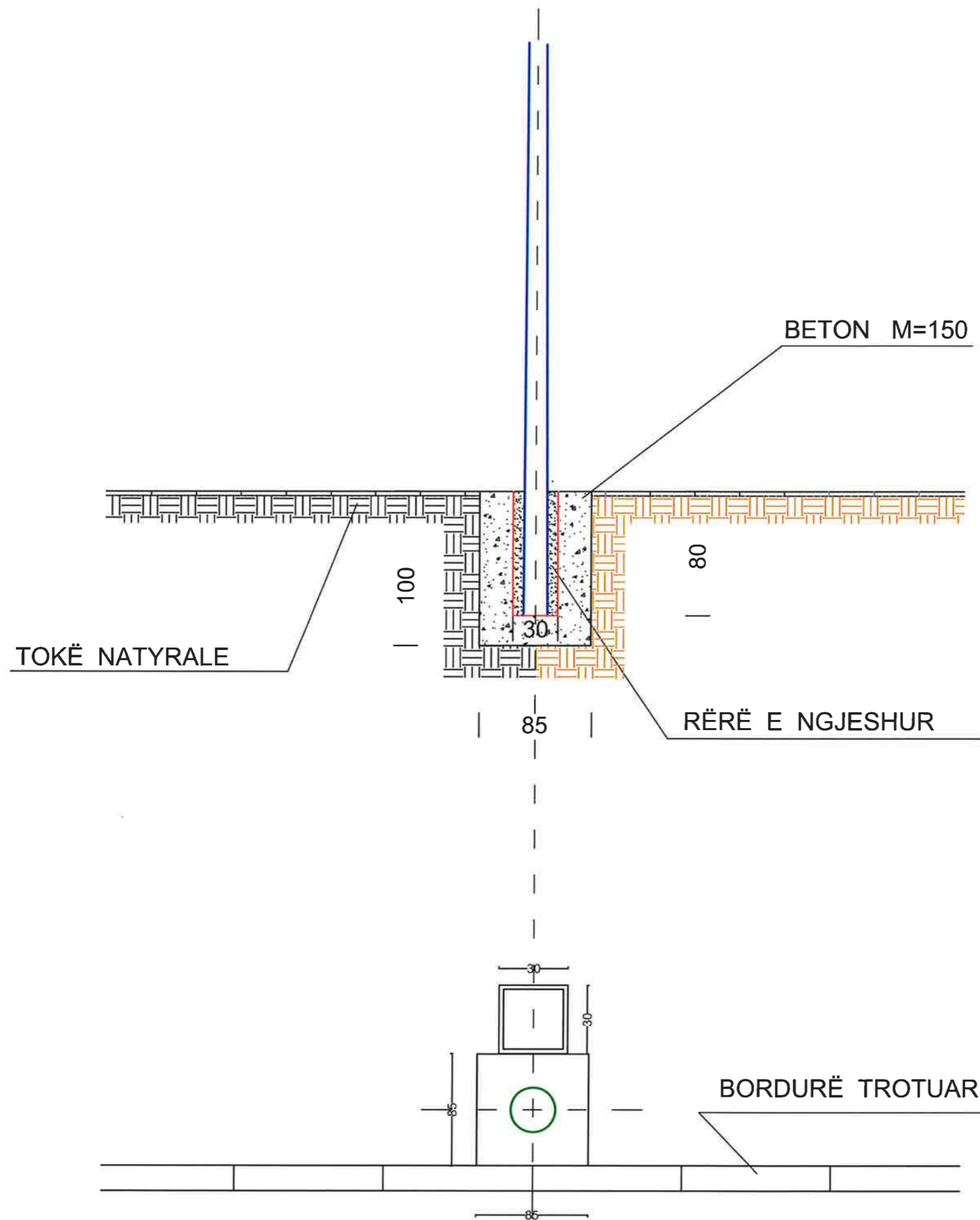

		BASHKIA KAMEZ	
DREJTORIA E SHERBIMEVE PUBLIKE DREJTORIA E PROJEKTEVE DHE INVESIMEVE DEPARTAMENTI E PROJEKTEVE			
Dr. e Projekteve e Investimeve		FLORA MUCA	
Prgj. e Projekteve		EMANUELA MEZIU	
STARTI TEKNIK PROJEKTES	Ing.	DENIS	PRENCI
	Ing.	ERBLIN	LALA
	Ing.	EGLANTINA	DISHA
	Ing.	RAMADAN	HYSA
Titulli i Projektit			Faza e Projektit PROJEKT ZBATIMI
OBJEKTI: "Ndertimi i rrjetit te kanalizimeve te ujrave te zeza te lagjeve perreth ujembledhesit te Paskuqanit dhe ndertimi i vazhdimit te rruges "ALI DEMI"			Data e Implementimit:
Emertimi i Fletes			Shkalla e Vizatimit
DETAJ I NDRICIMIT RRUGOR			Fiota Nr.

Detaj i tokëzimit të shtyllës së ndriçimit

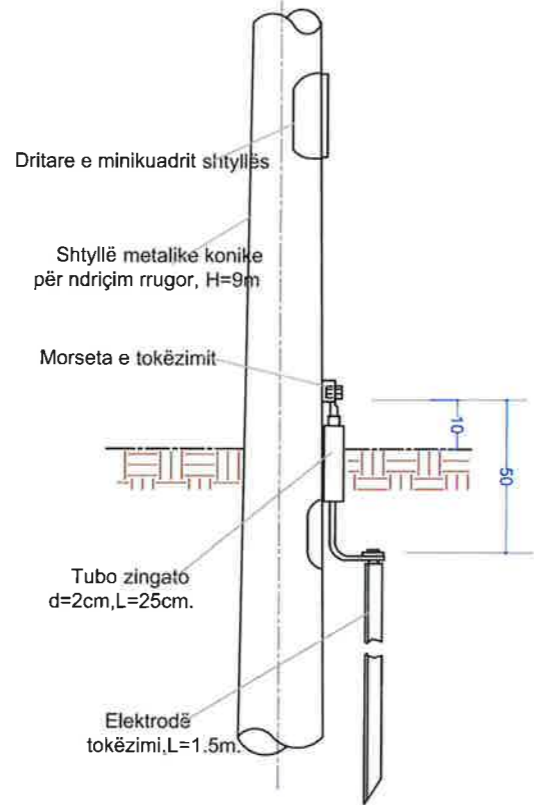

Konstruksioni morseterisë

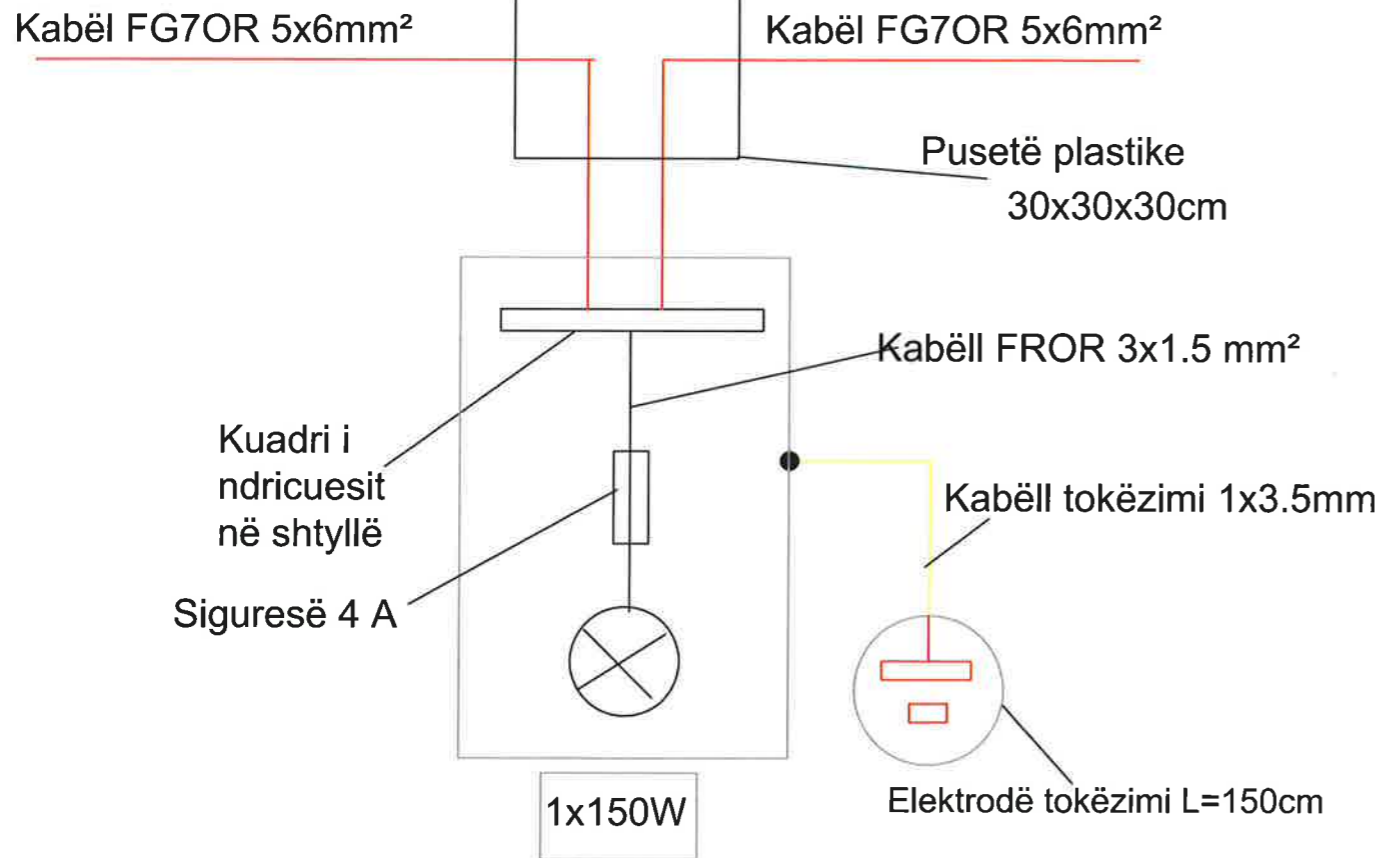
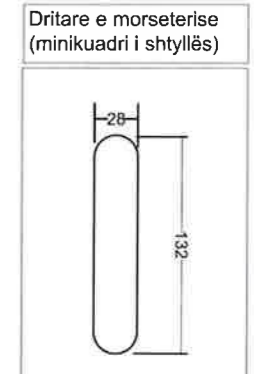
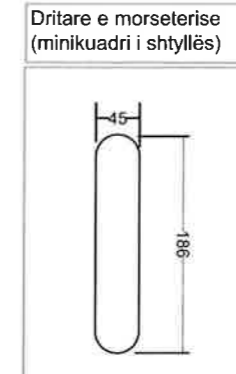
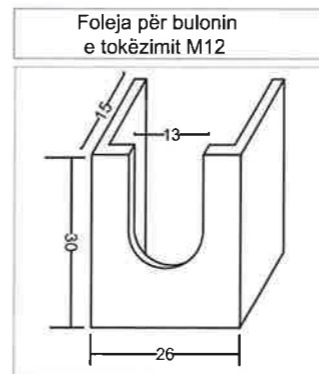
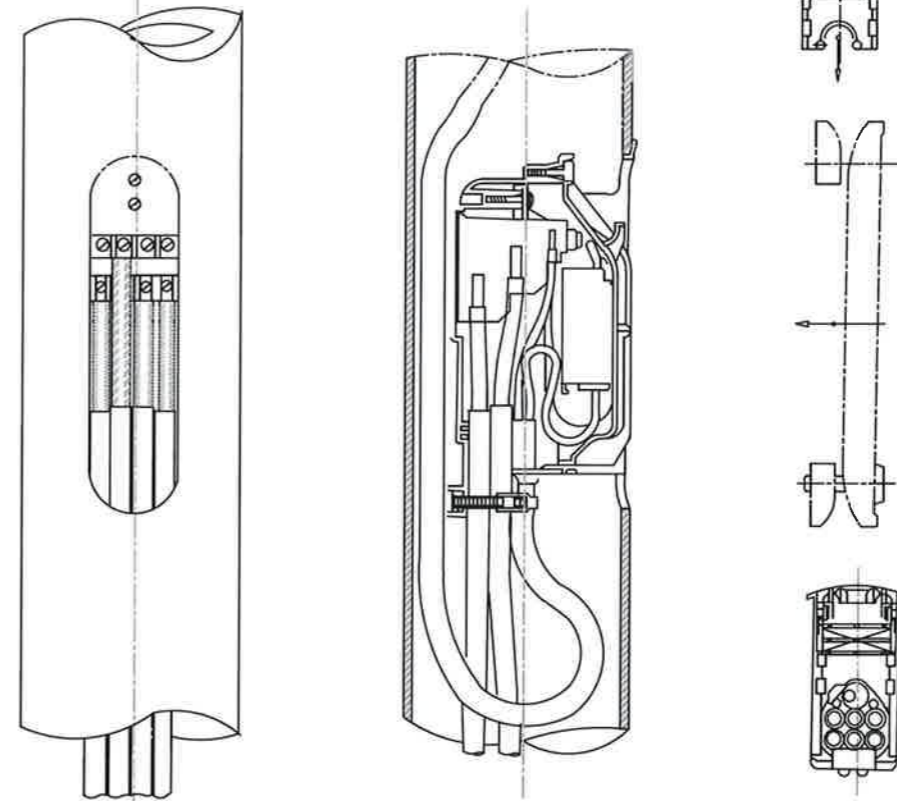

 BASHKIA KAMEZ DREJTORIA E SHERBIMEVE PUBLIKE DREJTORIA E PROJEKTEVE DHE INVESIMEVE DEPARTAMENTI E PROJEKTEVE		Dr. e Projekteve e Investimeve		FLORA MUÇA	
		Prgj. e Projekteve		EMANUELA MEZIU	
STARTI TEKNIK PROJEKTES	Ing.	DENIS	PRENCI		
	Ing.	ERBLIN	LALA		
	Ing.	EGLANTINA	DISHA		
	Ing.	RAMADAN	HYSA		
Titulli i Projektit		Faza e Projektit			
OBJEKTI: "Ndërtimi i rrjetit të kanalizimeve të ujërave të zeza të lagjeve përreth ujmbledhësit të Paskuqanit dhe ndërtimi i vazhimit të rrugës "ALI DEMI"		PROJEKT ZBATIMI			
Emërtimi i Flotes		Data e Implementimit:			
DETAJ I NDRICIMIT RRUGOR		Shkalla e Vizatimit			
		Fleta Nr.			

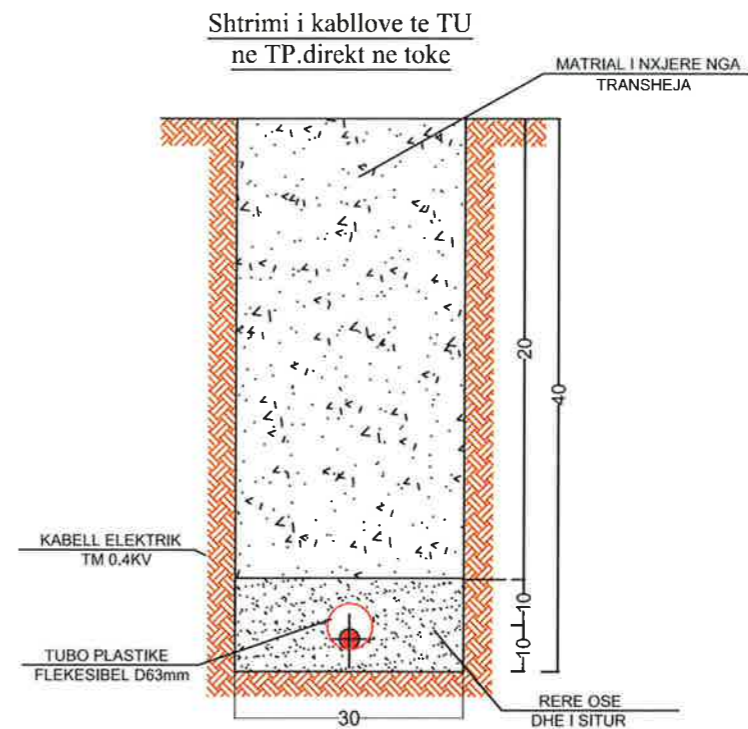
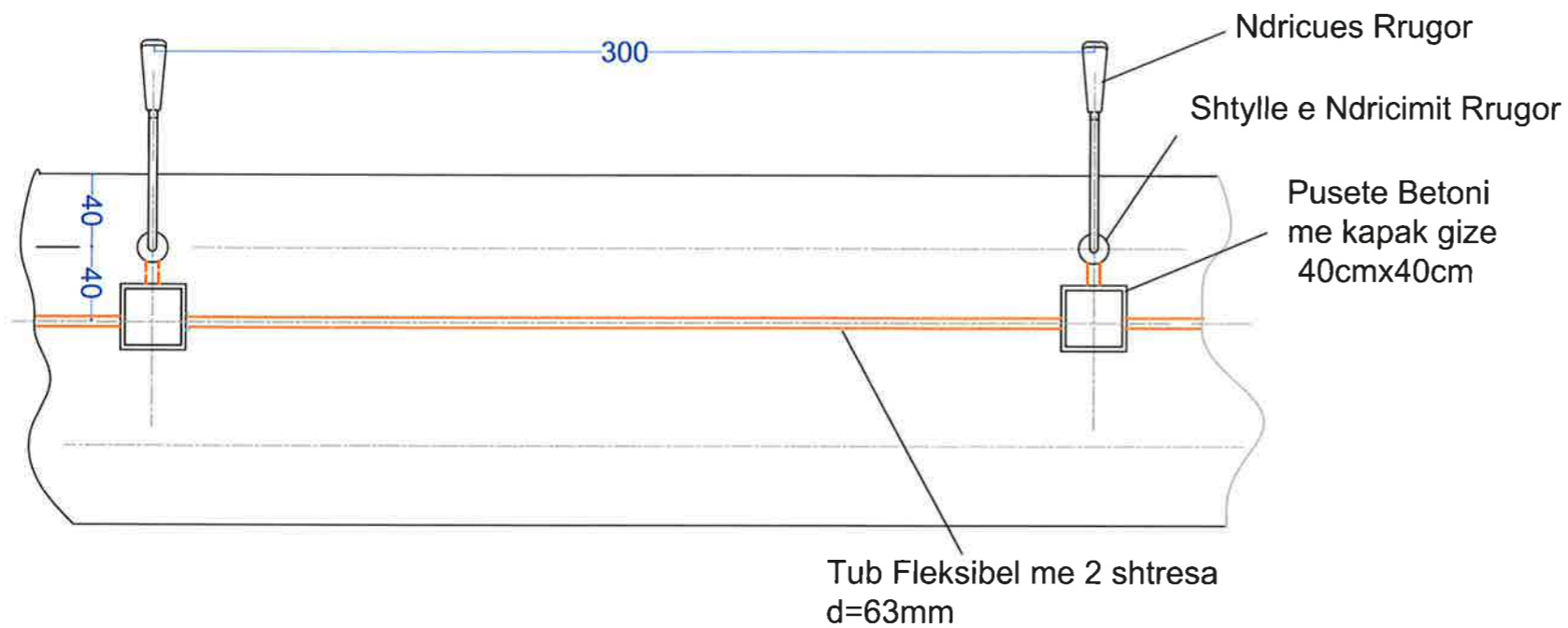

Detaj i montimit te pusetes dhe tokezimit te shtylles

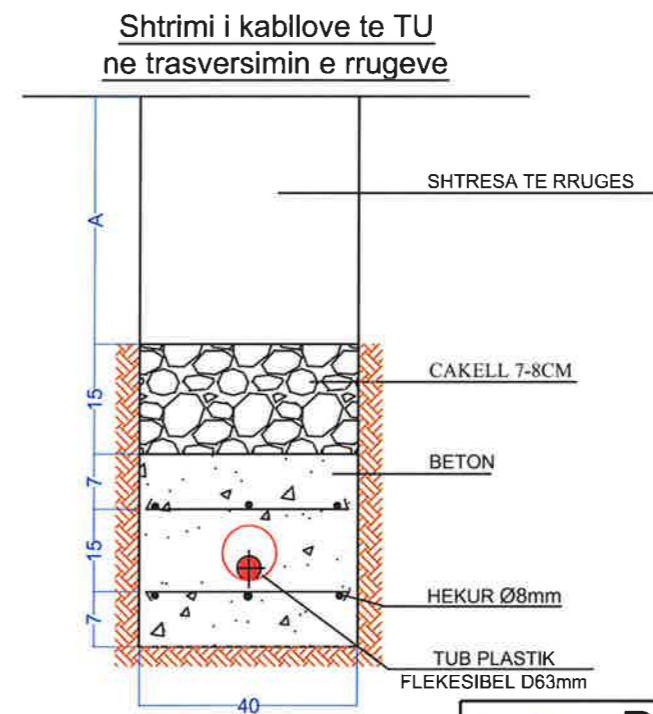
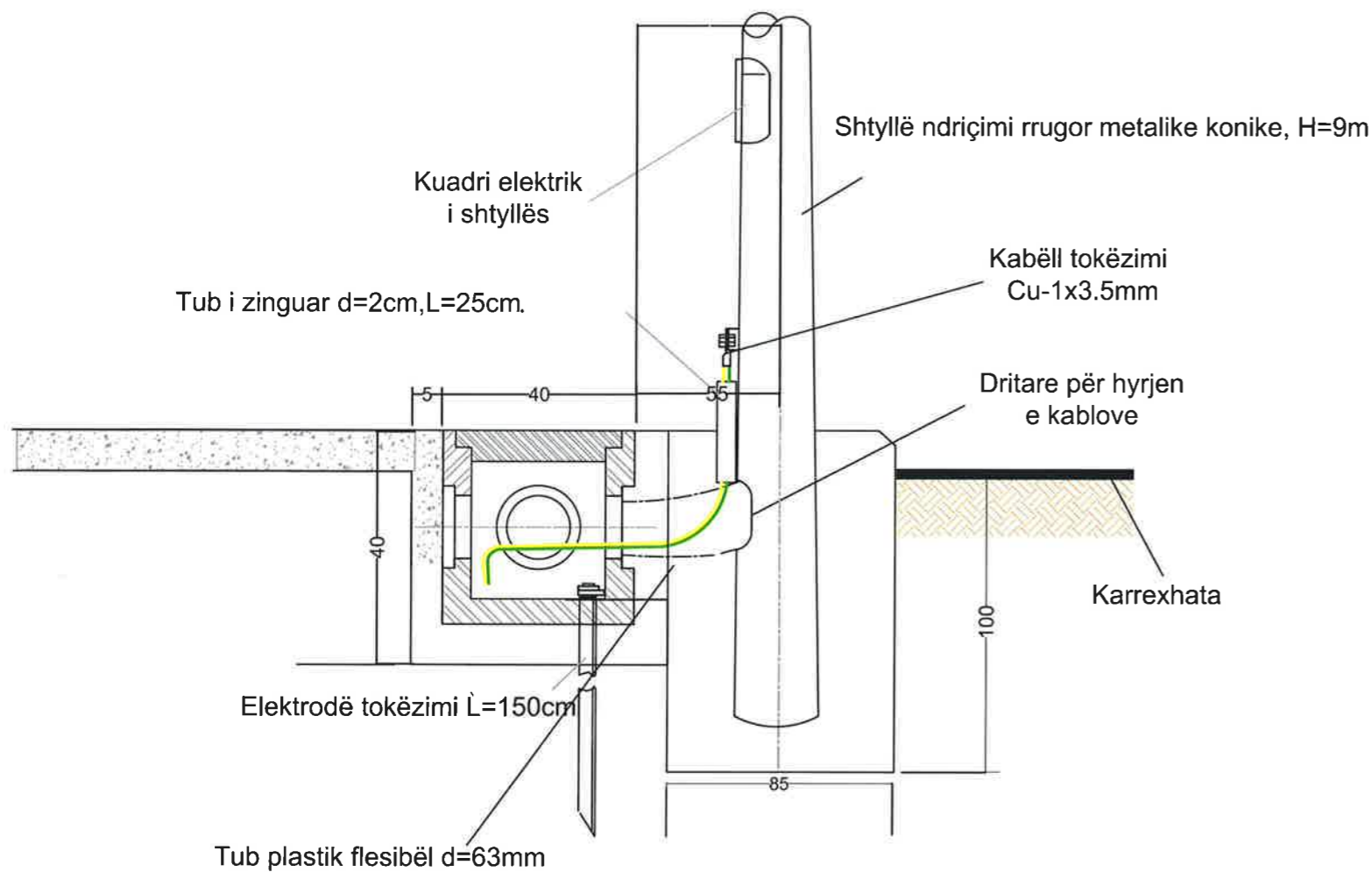

BASHKIA KAMEZ
 DREJTORIA E SHERBIMEVE PUBLIKE
 DREJTORIA E PROJEKTEVE DHE INYESIMEVE
 DEPARTAMENTI E PROJEKTEVE

Dr. e Projekteve e Investimeve	FLORA MUÇA	<i>[Signature]</i>
Prgj. e Projekteve	EMANUELA MEZIU	<i>[Signature]</i>

STAFI TEKNIK PROJEKTES	Ing.	DENIS PRENCI	<i>[Signature]</i>
	Ing.	ERBLIN LALA	
	Ing.	EGLANTINA DISHA	
	Ing.	RAMADAN HYSA	

Titulli i Projektit
 DETAJ I NDRICIMIT RRUGOR

OBJEKTI: "Ndertimi i rrjetit te kanalizimeve te ujrave te zeza te lagjeve perreth ujmbledhesit te Paskuqanit dhe ndertimi i vazhdimet te rruges "ALI DEMI"

Faza e Projektit: PROJEKT ZBATIMI
Data e Implementimit:
Shkalla e Vizatimit:
Flota Nr.:

Detaj i vendosjes së pusetës

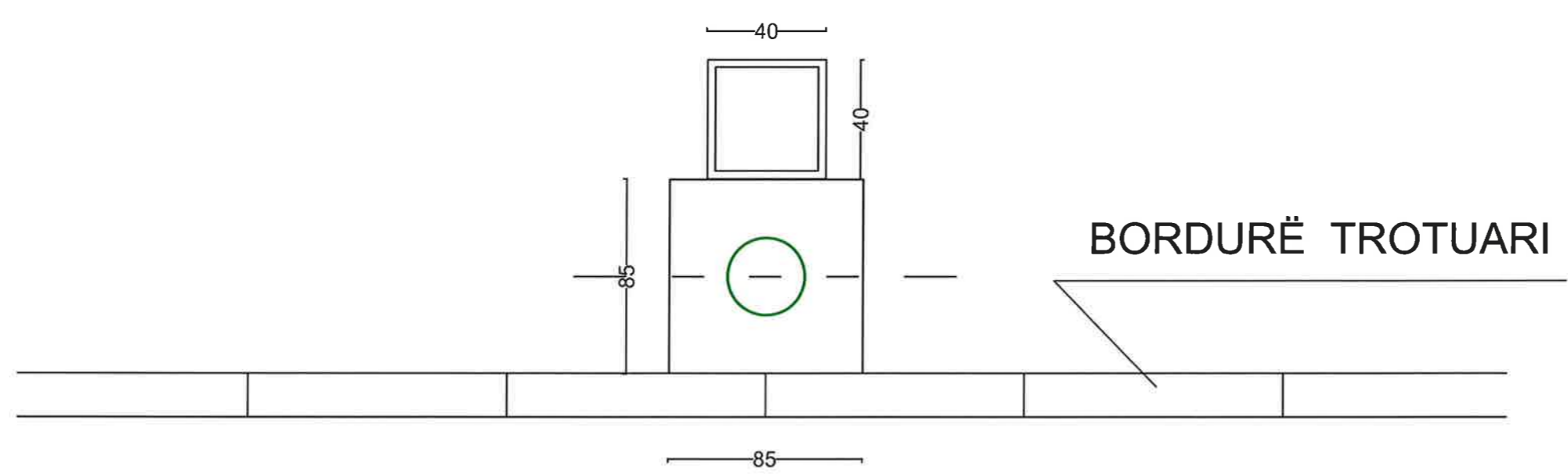
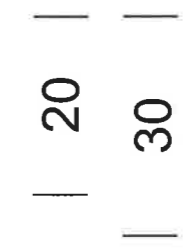
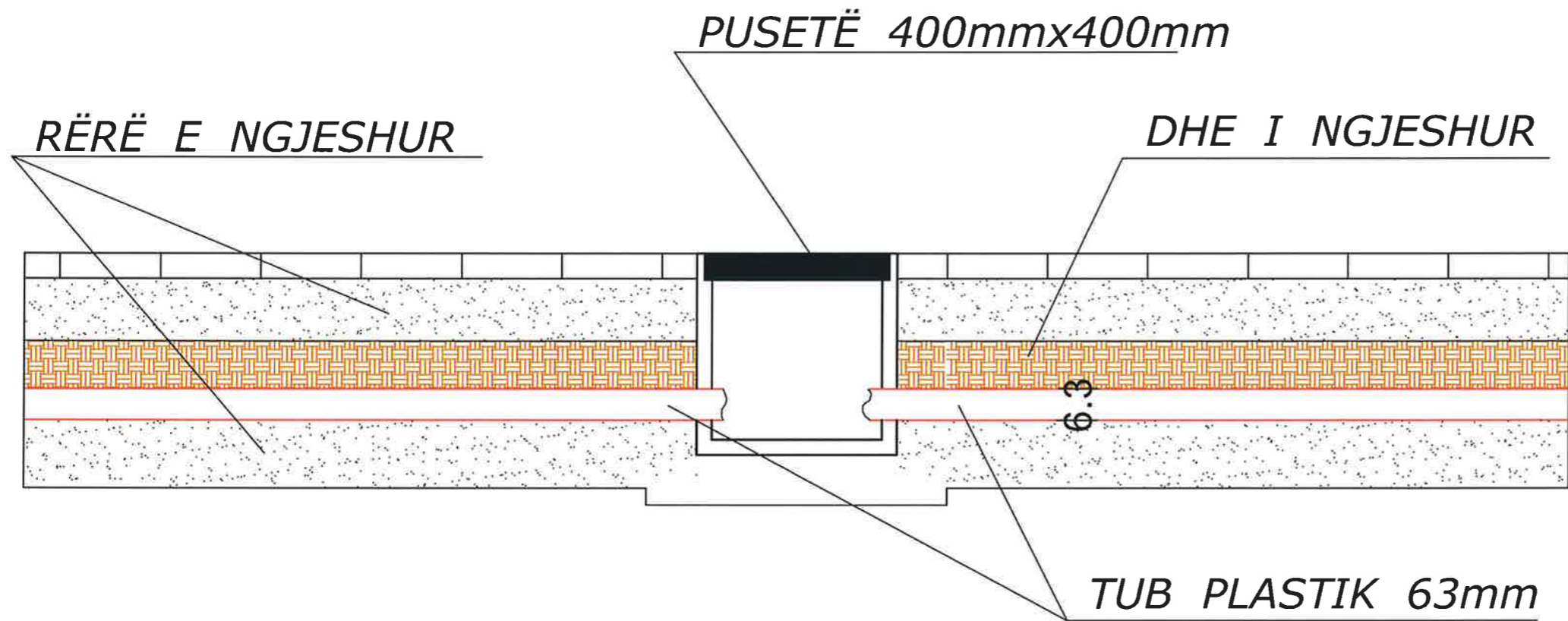

BASHKIA KAMEZ
 DREJTORIA E SHERBIMEVE PUBLIKE
 DREJTORIA E PROJEKTEVE DHE INVESIMEVE
 DEPARTAMENTI E PROJEKTEVE

Dr. e Projekteve e Investimeve	FLORA MUCA	
Prgj. e Projekteve	EMANUELA MEZIU	

STAFI TEKNIK PROJEKTES	Ing.	DENIS PRENCI	<i>[Signature]</i>
	Ing.	ERBLIN LALA	
	Ing.	EGLANTINA DISHA	
	Ing.	RAMADAN HYSA	

Titulli i Projektit
 OBJEKTI: "Ndertimi i rrjetit te kanalizimeve te ujrave te zeza te lagjeve perreth ujmbledhesit te Paskuqanit dhe ndertimi i vazhdimit te rruges "ALI DEMI"
 Emertimi i Fletes
 DETAJ I NDRICIMIT RRUGOR

Faza e Projektit
 PROJEKT ZBATIMI
 Data e Implementimit :
 Shkalla e Vizatimit
 Fleta Nr.

PUSETE KONTROLLI PER UJRAT E SHIUT SH 1:25

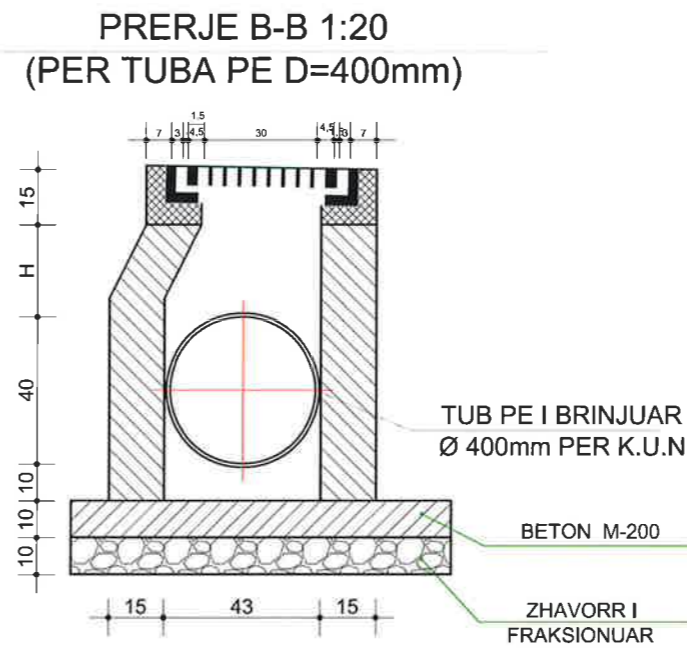
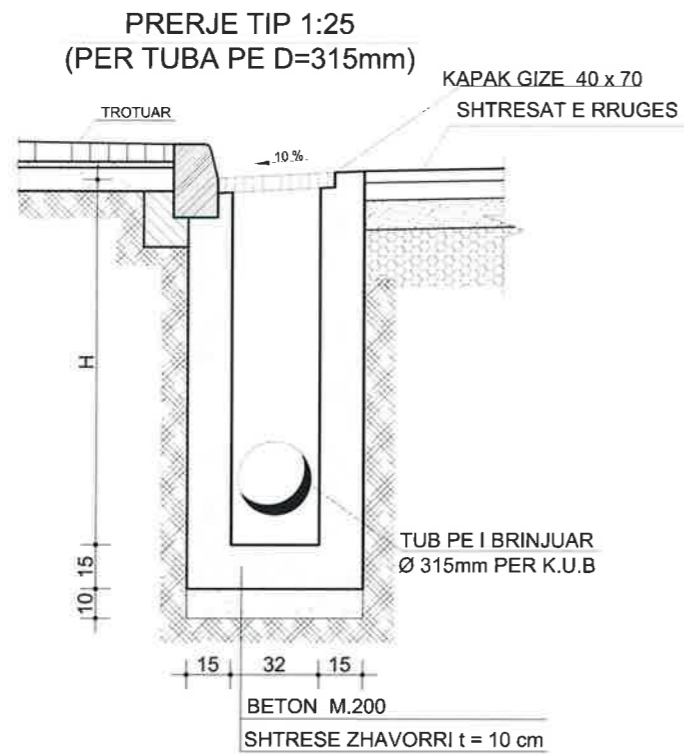
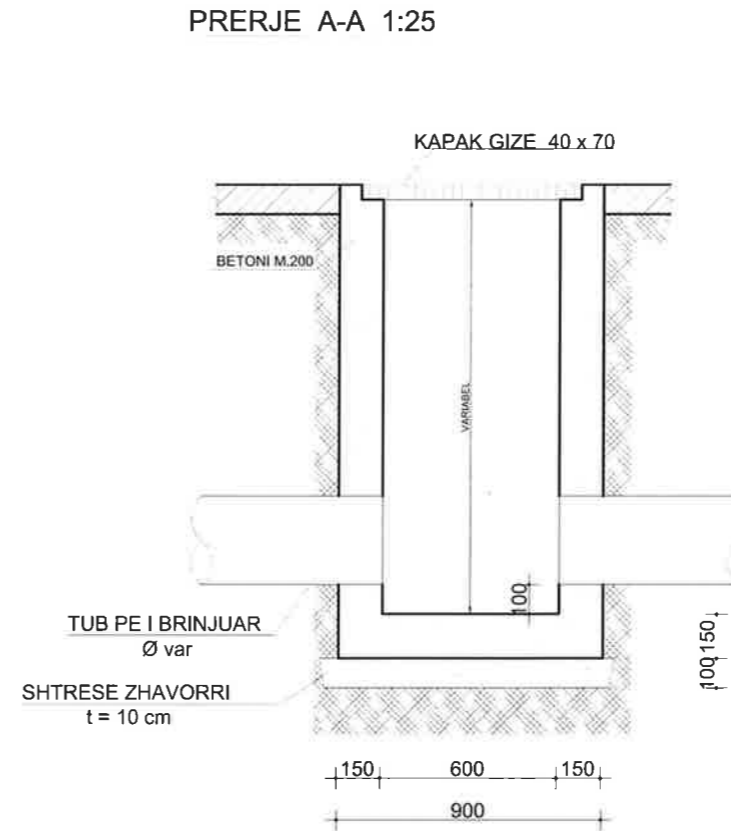
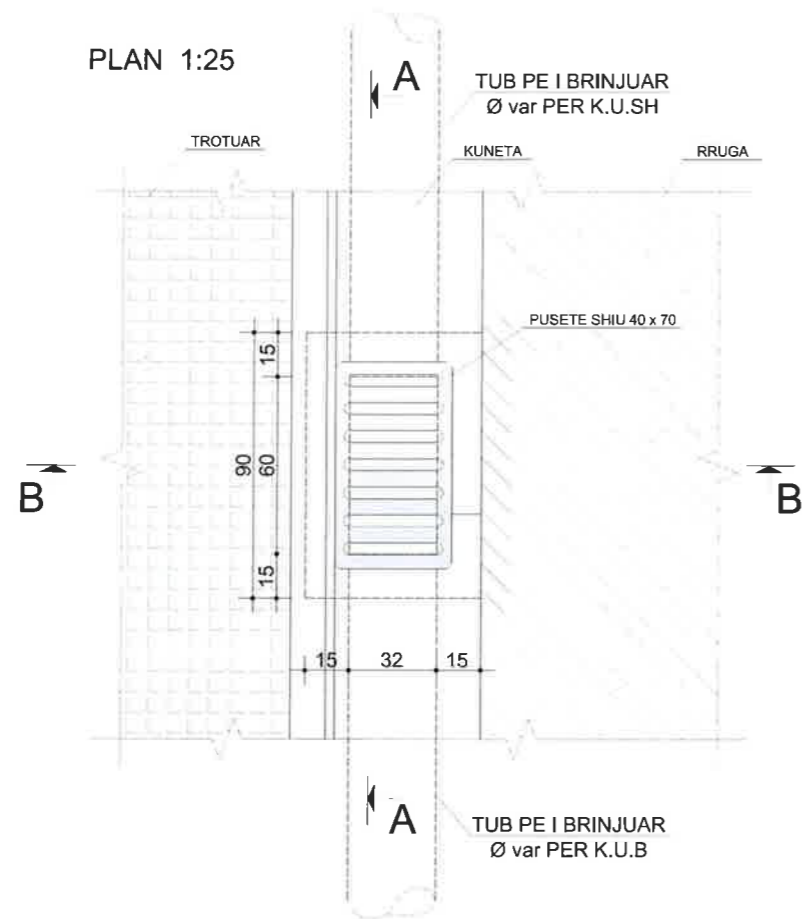

 BASHKIA KAMEZ DREJTORIA E SHERBIMEVE PUBLIKE DREJTORIA E PROJEKTEVE DHE INVESIMEVE DEPARTAMENTI E PROJEKTEVE		Dr. e Projekteve e Investimeve		FLORA MUCA	
		Prgj. e Projekteve		EMANUELA MEZIU	
STAFI TEKNIK PROJEKTES	Ing.	DENIS PRENCI			
	Ing.	ERBLIN LALA			
	Ing.	EGLANTINA DISHA			
	Ing.	RAMADAN HYSA			
Titulli i Projektit		Faza e Projektit			
OBJEKTI: "Ndertimi i rjetit te kanalizimeve te ujrave te zeza te lagjeve perreth ujembledhesit te Paskuqanit dhe ndertimi i vazhdimit te ruges "ALI DEMI"		PROJEKT ZBATIMI			
Emertimi i Fletes		Data e Implementimit:			
DETAJE KUB		Shkalla e Vizatimit			
		Fleta Nr.			

PUSETE KONTROLLI PER K.U.N

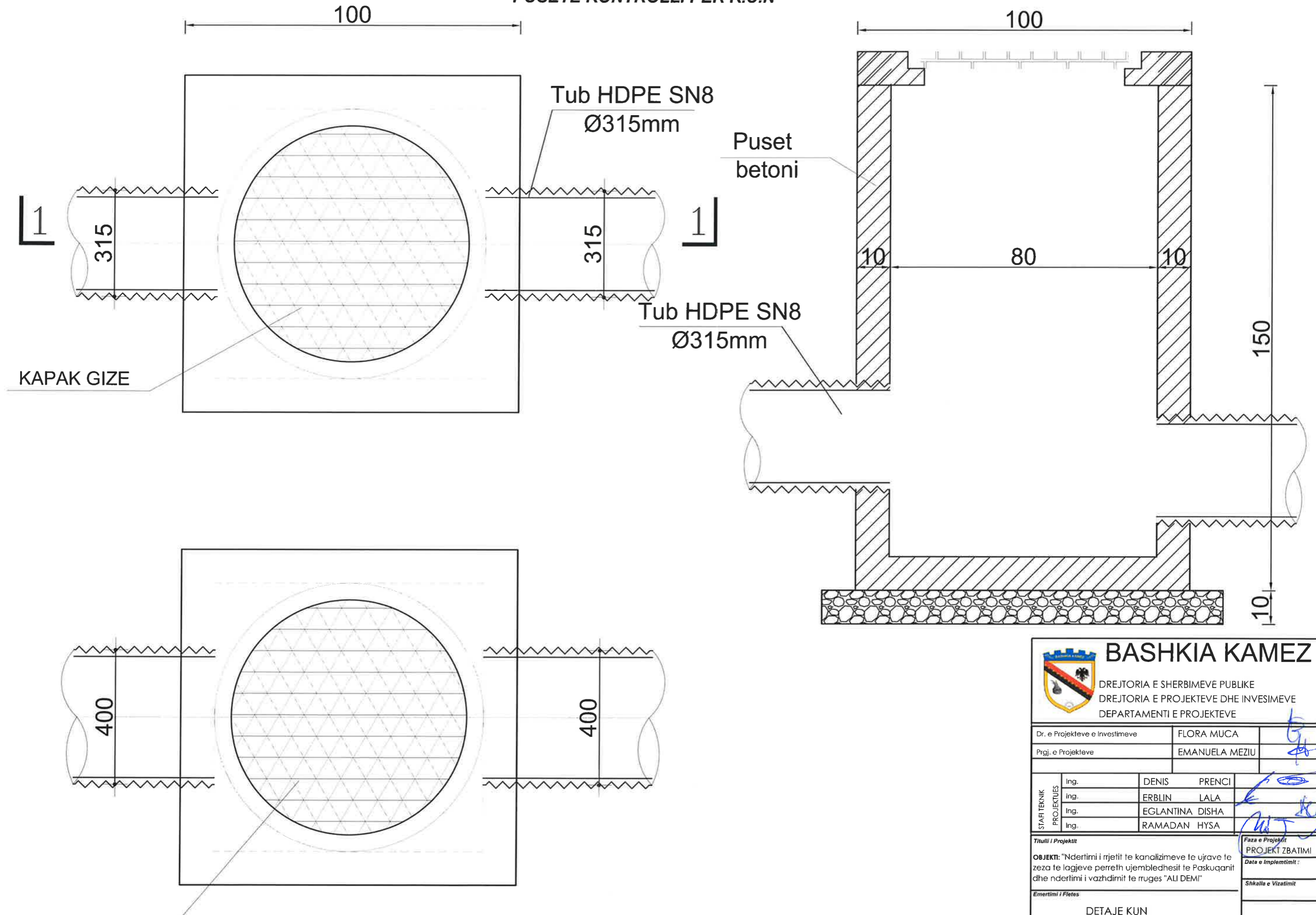

BASHKIA KAMEZ
 DREJTORIA E SHERBIMEVE PUBLIKE
 DREJTORIA E PROJEKTEVE DHE INVESIMEVE
 DEPARTAMENTI E PROJEKTEVE

Dr. e Projekteve e Investimeve	FLORA MUCA	
Prgj. e Projekteve	EMANUELA MEZIU	

STARI TEKNIK PROJEKTUES	Ing.	DENIS PRENCI	<i>[Signature]</i>
	Ing.	ERBLIN LALA	
	Ing.	EGLANTINA DISHA	
	Ing.	RAMADAN HYSA	

Titulli i Projektit
OBJEKTI: "Ndertimi i rrjetit te kanalizimeve te ujrave te zeza te lagjeve perreth ujembledhesit te Paskuqanit dhe ndertimi i vazhdimit te ruges "ALI DEMI"
Emertimi i Fletes
 DETAJE KUN

Faza e Projektit
 PROJEKT ZBATIMI
Data e Implementimit:
Shkalla e Vizatimit