



BASHKIA VLORË

PROJEKTI HIDRAULIK KUB I RIKONSTRUKSIONIT TE HAPSIRAVE REKREATIVE NE LAGJEN "KUSHTRIMI"



DREJTORIA E
URBANISTIKËS

Punoi:
Drejtor
Klaudio Mehmetaj
Ing.Stela Rrapaj
Ing. Estela Hoxhaj

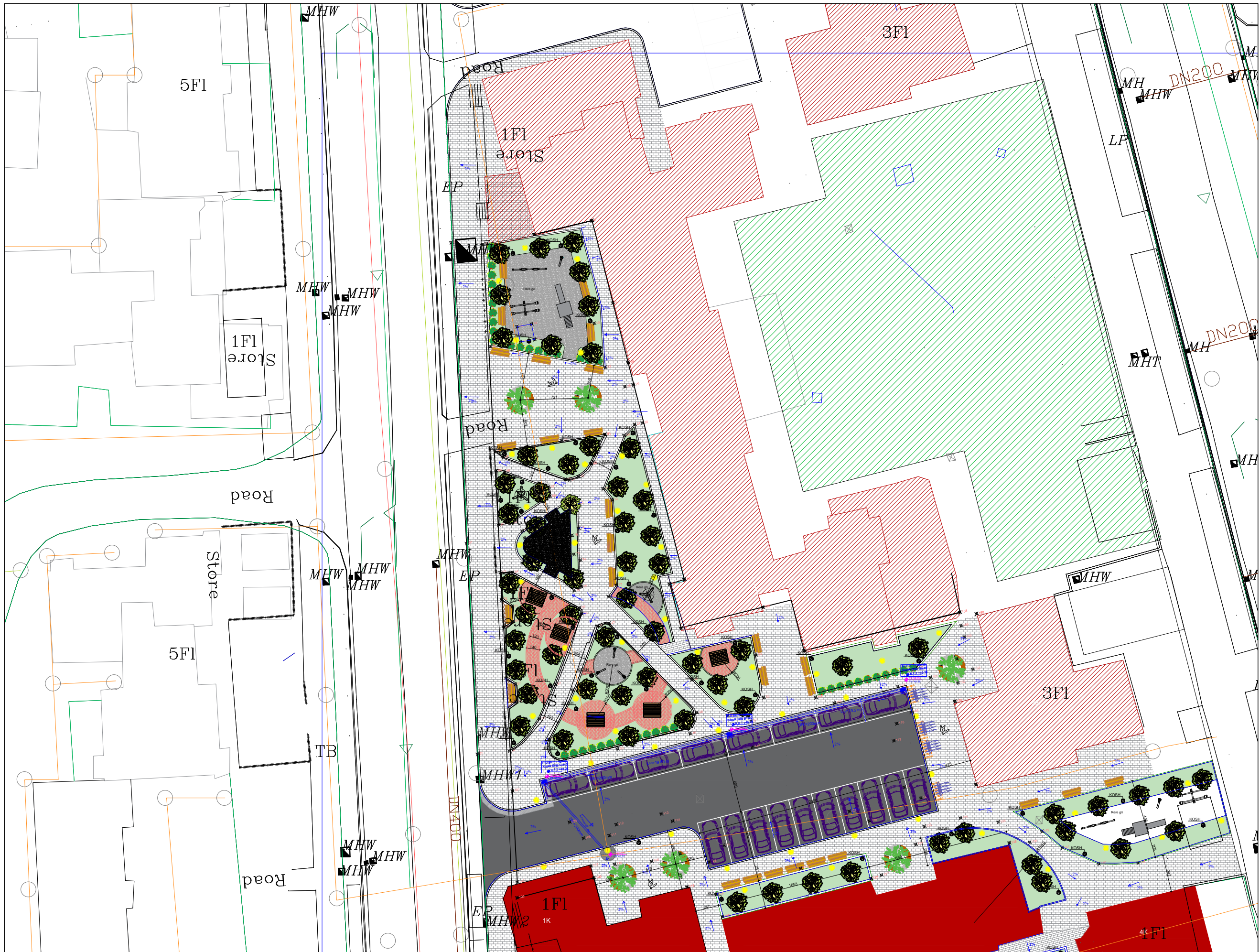

PLANEVENDOSJA

Linjat ekzistuese KUZ Ø200mm
Tubo HDPE te Brinjezuar Ø200mm

Pusete ekzistuese KUB
Puset shiu 40x40, me zgare metalike

VLORE 2024

H-01



DREJTORIA E
URBANISTIKËS

Punoi:

Drejtor
Klaudio Mehmetaj

Ing. Stela Rrapaj

Ing. Estela Hoxhaj

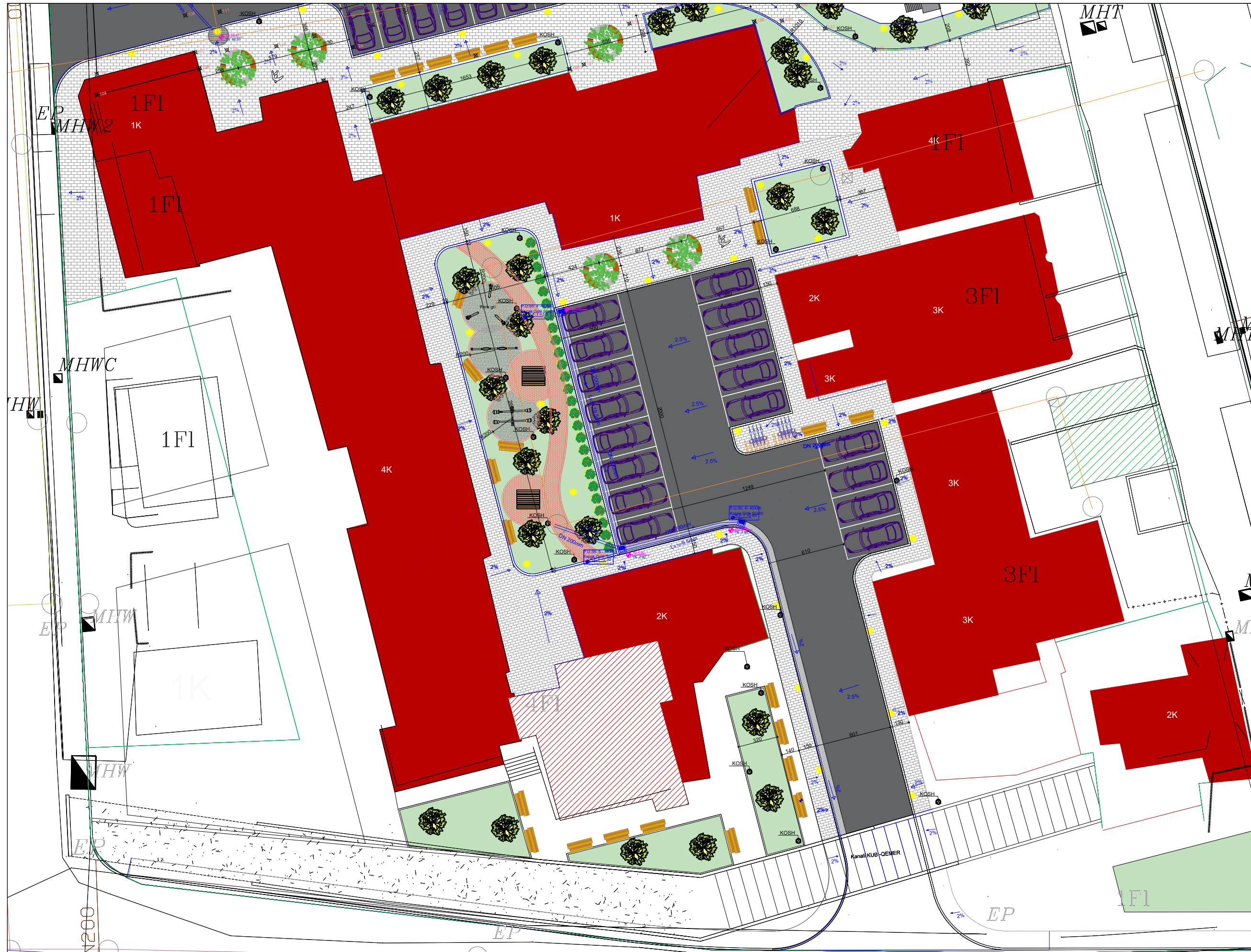

PLANEVENDOSJA

Linjat ekzistuese KUZ Ø200mm
Tubo HDPE te Brinjezuar Ø200mm

Pusete ekzistuese KUB
Pusete shiu 40x40, me zgare metalike

VLORE 2024

H-02



DREJTORIA E
URBANISTIKËS

Punoi:

Drejtor
Klaudio Mehmetaj

Ing. Stela Rrapaj

Ing. Estela Hoxhaj

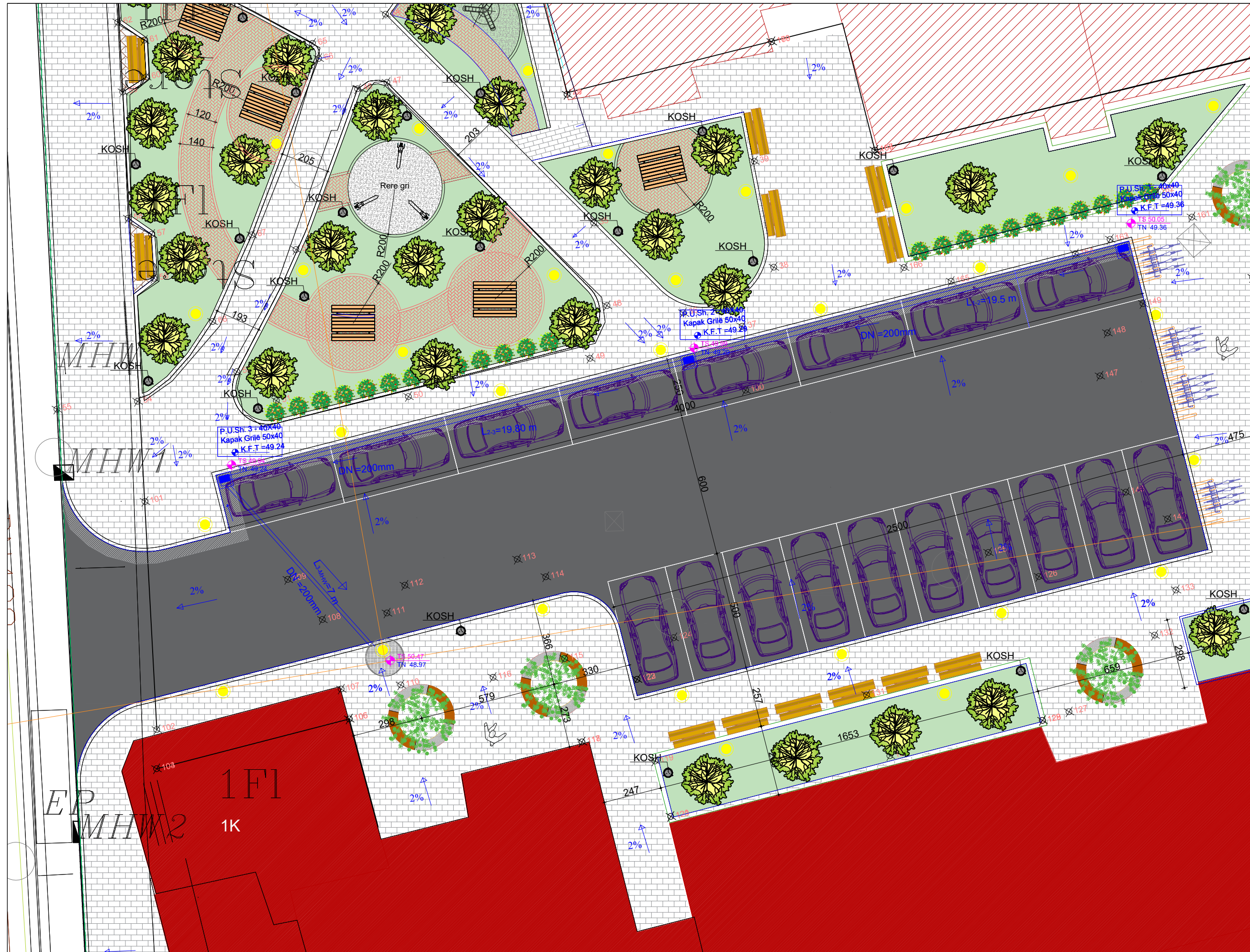

PLANEVENDOSJA



● Puset ekzistuese KUZ Ø200mm

■ Puset shiu 40x40, me zgare metalike

VLORE 2024

H-03



DREJTORIA E
URBANISTIKËS

Punoi:

Drejtor
Klaudio Mehmetaj

Ing. Stela Rrapaj

Ing. Estela Hoxhaj

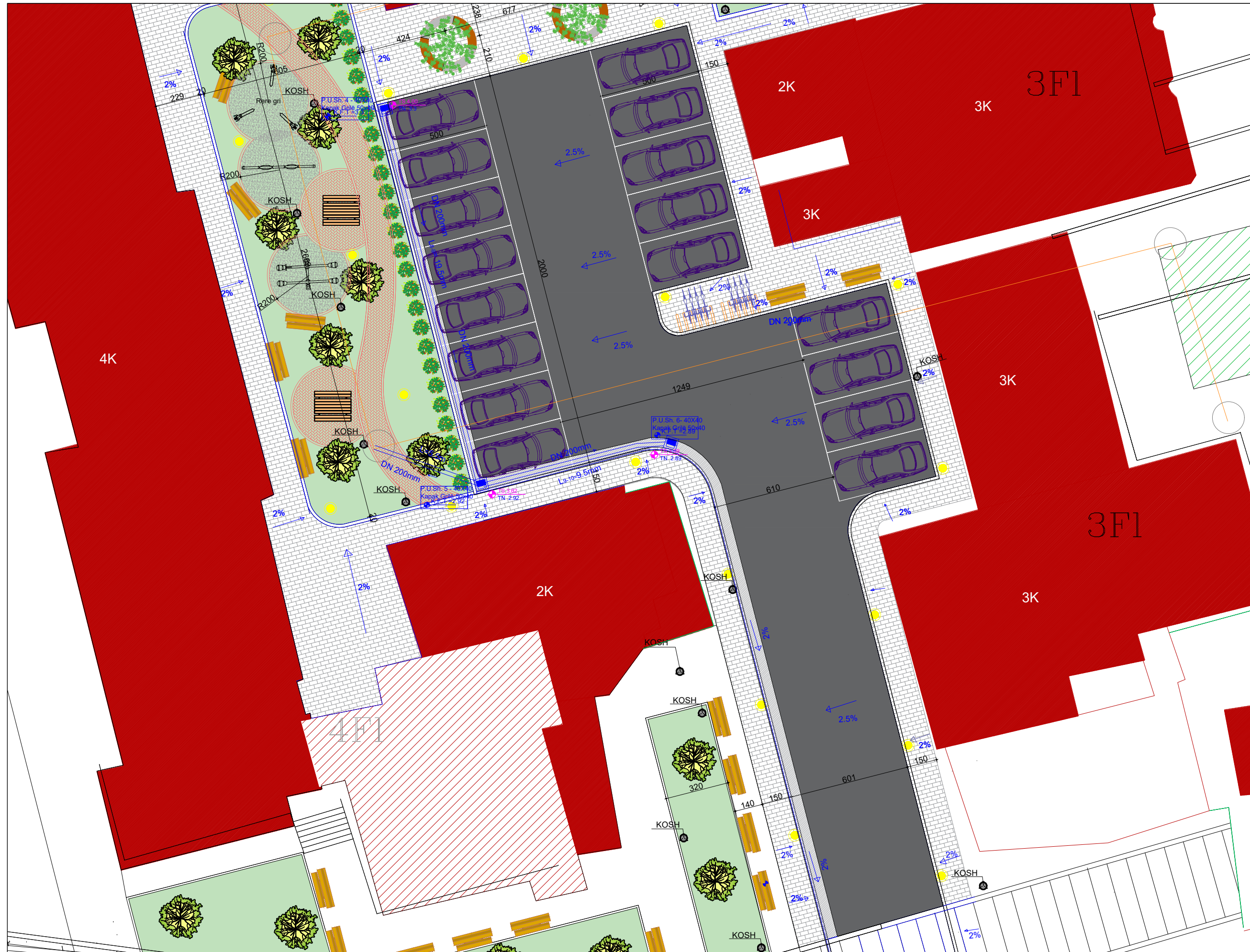

PLANEVENDOSJA



● Puset e ekzistueshme KUZ Ø200mm

■ Puset shiu 40x40, me zgare metalike

VLORE 2024

H-04

Profili Gjatësor, Puseta 1-2-3-MHW1 (Pusete kryesore ne rruge), Sh.V.1:100

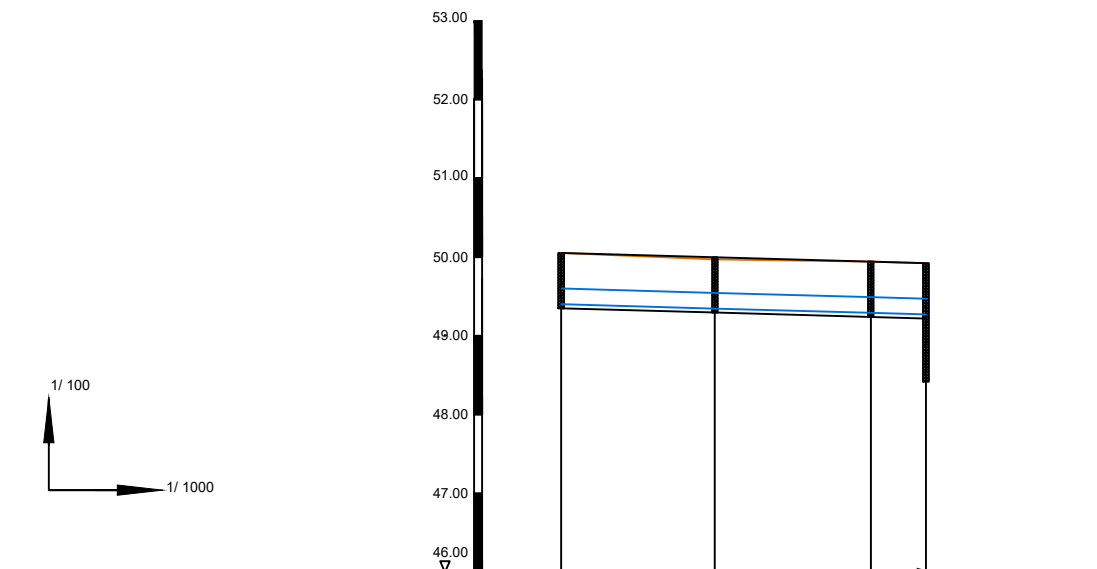

EMERTIMI I PUSETES	P.1	P.2	P.3	MHW1
KUOTA E TOKES (m.a.s.l)	50.00	49.97	49.94	49.91
KUOTA E SIPËRME TUBIT (m)	49.97	49.94	49.91	49.88
KUOTA E POSHTËME E TUBIT (m)	49.94	49.91	49.88	49.85
KUOTA E PROJEKTIT (m.a.s.l)	49.94	49.91	49.88	49.85
KUOTA E TABANIT TE PUSETES (m)	49.35	49.32	49.29	49.26
THELLESIA E GERMIMIT (m)	0.7	0.7	0.7	0.7
DISTANCA E PUSETAVE (m)	19.5	19.8	7	
DISTANCA PROGRESIVE (m)	0.00	19.5	38.3	38.3
PJERRESIA (m/m)		i=0.00308	i=0.00253	i=0.01714
ELEMENT HIDRAULIK TIPI I TUBACIONIT DHE DIAMETRI (Ø)	Tub D=200 mm, HDPE i Brijëzuar, SN8 i=0.0058			

Profili Gjatësor, Puseta 4-5-P_{KUB} (Pusete kryesore KUB), Sh.V.1:100

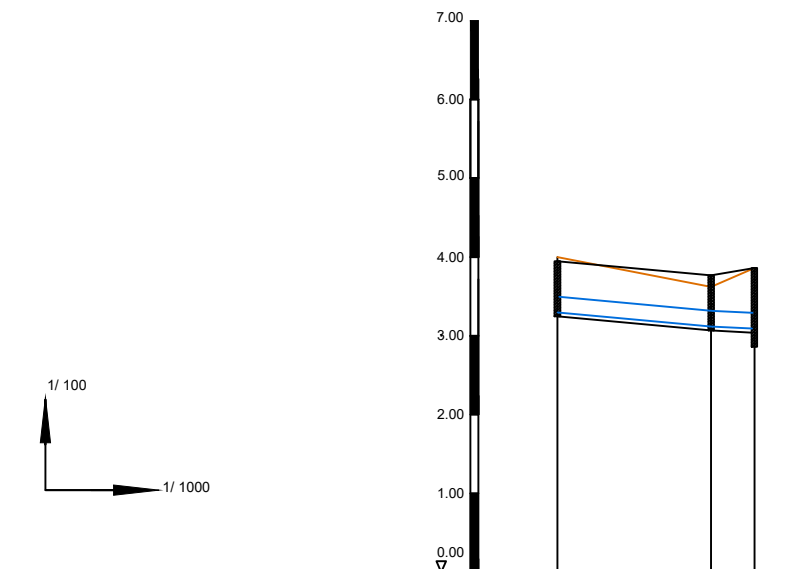

EMERTIMI I PUSETES	P.4	P.5	P.6
KUOTA E TOKES (m.a.s.l)	4.00	3.97	3.94
KUOTA E SIPËRME TUBIT (m)	3.97	3.94	3.91
KUOTA E POSHTËME E TUBIT (m)	3.94	3.91	3.88
KUOTA E PROJEKTIT (m.a.s.l)	3.94	3.91	3.88
KUOTA E TABANIT TE PUSETES (m)	3.25	3.22	3.19
THELLESIA E GERMIMIT (m)	0.7	0.7	0.7
DISTANCA E PUSETAVE (m)	19.5	5.5	
DISTANCA PROGRESIVE (m)	0.00	19.5	25
PJERRESIA (m/m)		i=0.00923	i=0.0109
ELEMENT HIDRAULIK TIPI I TUBACIONIT DHE DIAMETRI (Ø)	Tub D=200 mm, HDPE i Brijëzuar, SN8 i=0.0096		

Profili Gjatësor, Puseta 6-5-P_{KUB} (Pusete kryesore KUB), Sh.V.1:100

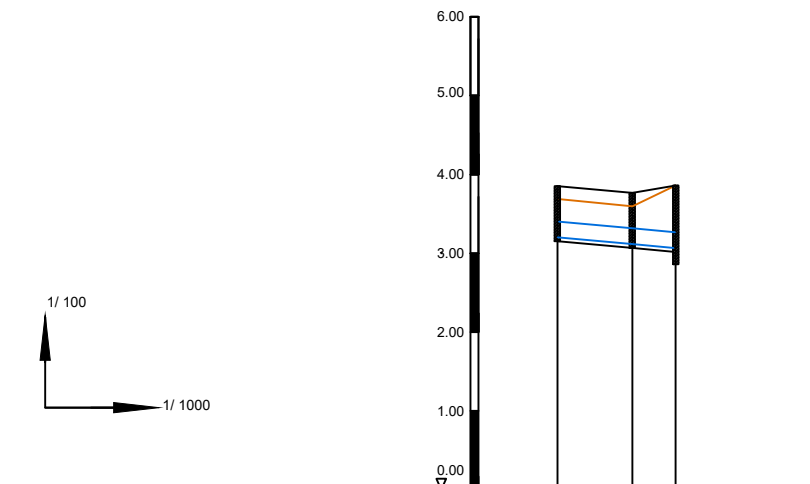

EMERTIMI I PUSETES	P.6	P.5
KUOTA E TOKES (m.a.s.l)	4.00	3.97
KUOTA E SIPËRME TUBIT (m)	3.97	3.94
KUOTA E POSHTËME E TUBIT (m)	3.94	3.91
KUOTA E PROJEKTIT (m.a.s.l)	3.94	3.91
KUOTA E TABANIT TE PUSETES (m)	3.15	3.12
THELLESIA E GERMIMIT (m)	0.7	0.7
DISTANCA E PUSETAVE (m)	9.5	5.5
DISTANCA PROGRESIVE (m)	0.00	9.5
PJERRESIA (m/m)		i=0.00842
ELEMENT HIDRAULIK TIPI I TUBACIONIT DHE DIAMETRI (Ø)	Tub D=200 mm, HDPE i Brijëzuar, SN8 i=0.0093	



DREJTORIA E
URBANISTIKËS

Punoi:
Drejtor
Klaudio Mehmetaj
Ing.Stela Rrapaj
Ing. Estela Hoxhaj

Detaj pusete per ujerat e shiut
pusetë betoni 40X40 kapak me mbushje sipas shtreses ose gize



DREJTORIA E
URBANISTIKËS

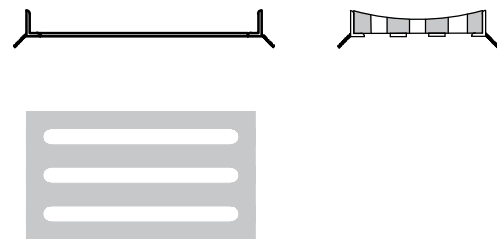
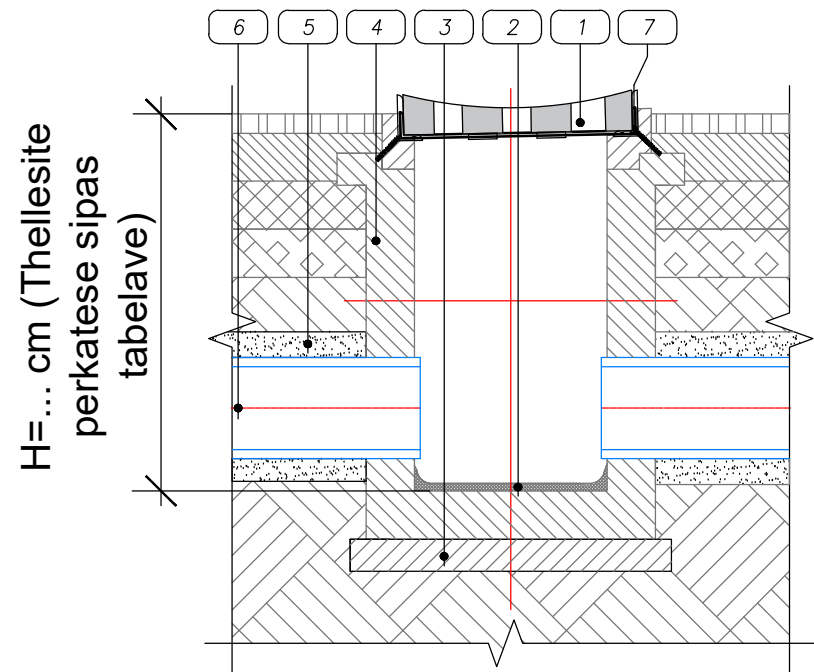

LEGJENDA	
1	Kapak pusete grile me mbushje sipas shtreses se rruges - C 250
2	Korite
3	Jastek
4	Pusete betoni/arme
5	Shtrese rere
6	Tub shkarkimi per ujrat e zeza
7	Strukture metalike C 250

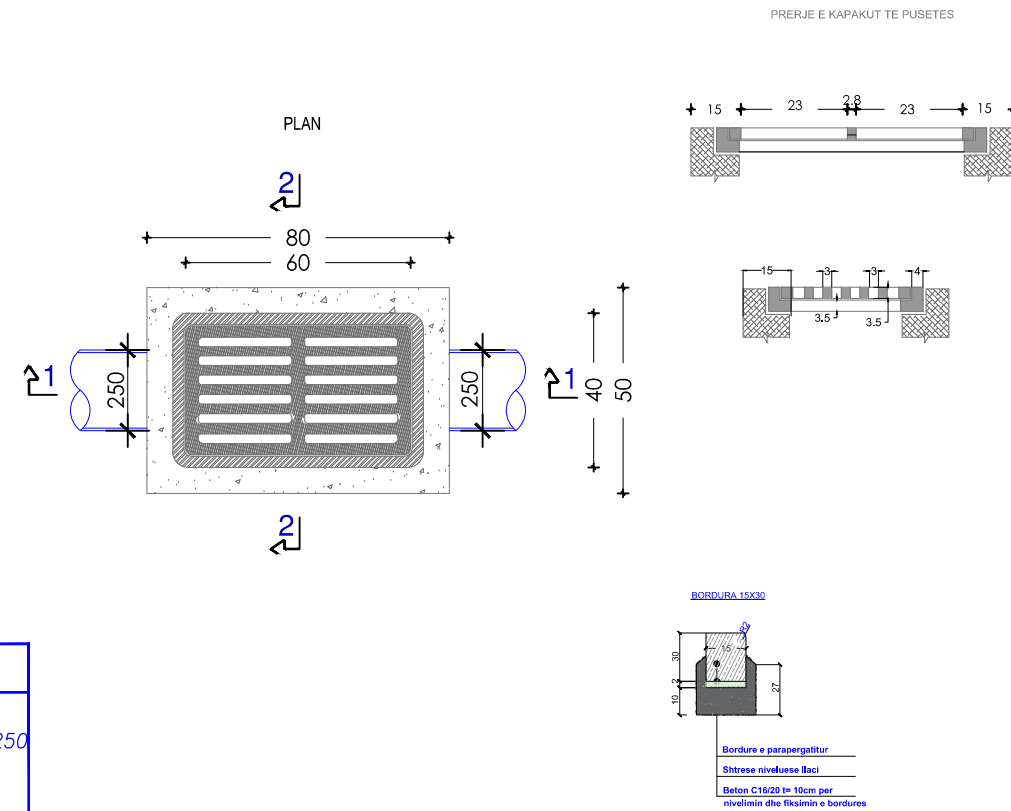

Detaj i kanalit te linjes KUB

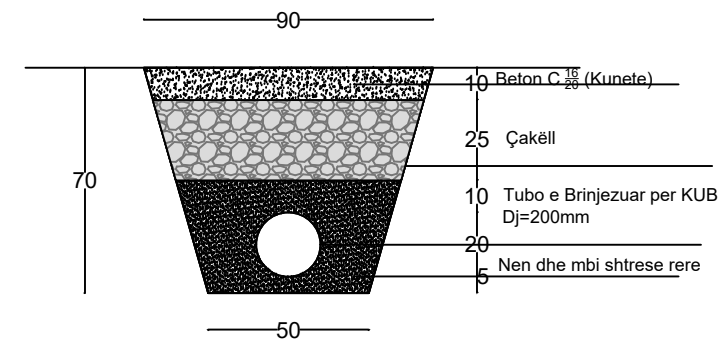

Punoi:
Drejtor
Klaudio Mehmetaj
Ing.Stela Rrapaj
Ing. Estela Hoxhaj