

MIRATOHET  
BASHKIA KRUJË  
KRYETARI

---

Z. ARTUR BUSHI

**PROJEKT**

**Z B A T I M I** (PROFILAT TERTHORE)

**OBJEKTI**

**RIJETËZIMI I KALLDRËMIT MESJETAR KRUJË-SARISALLTIK**

**AUTORITETI  
KONTRAKTOR**

**BASHKIA KRUJË**

**KONSULENTI**

**“ERALD-G” Shpk**

**VITI 2017**

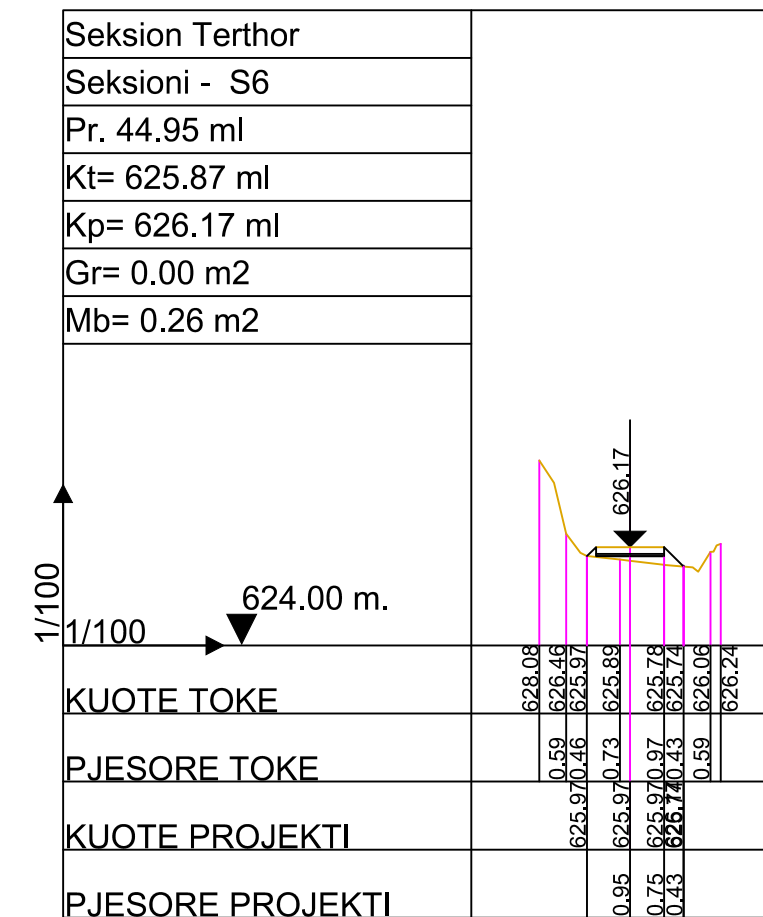
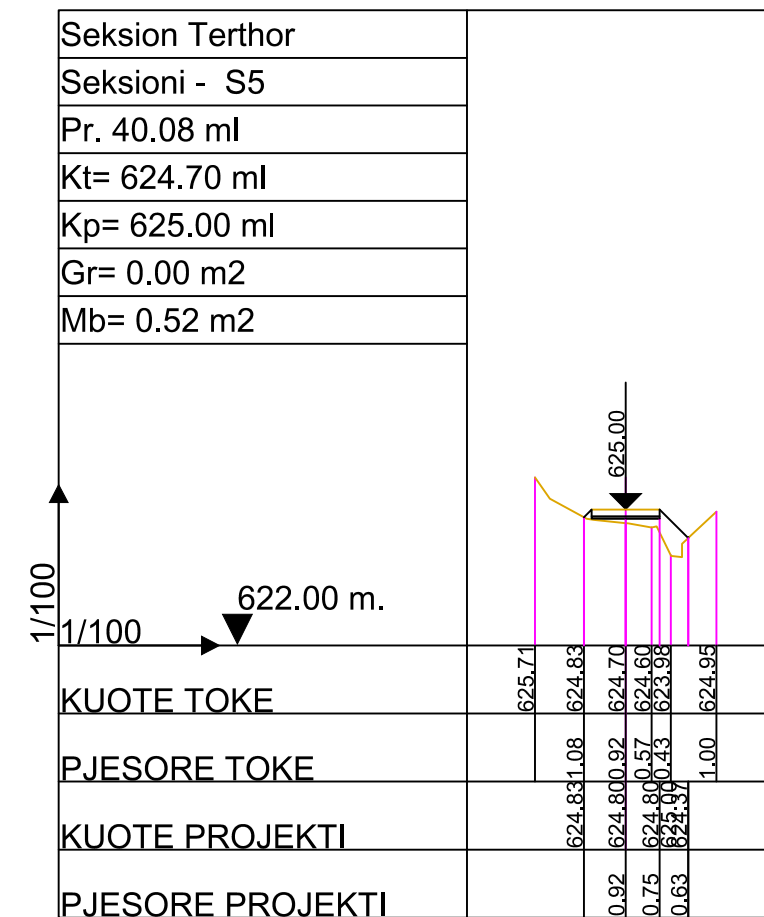
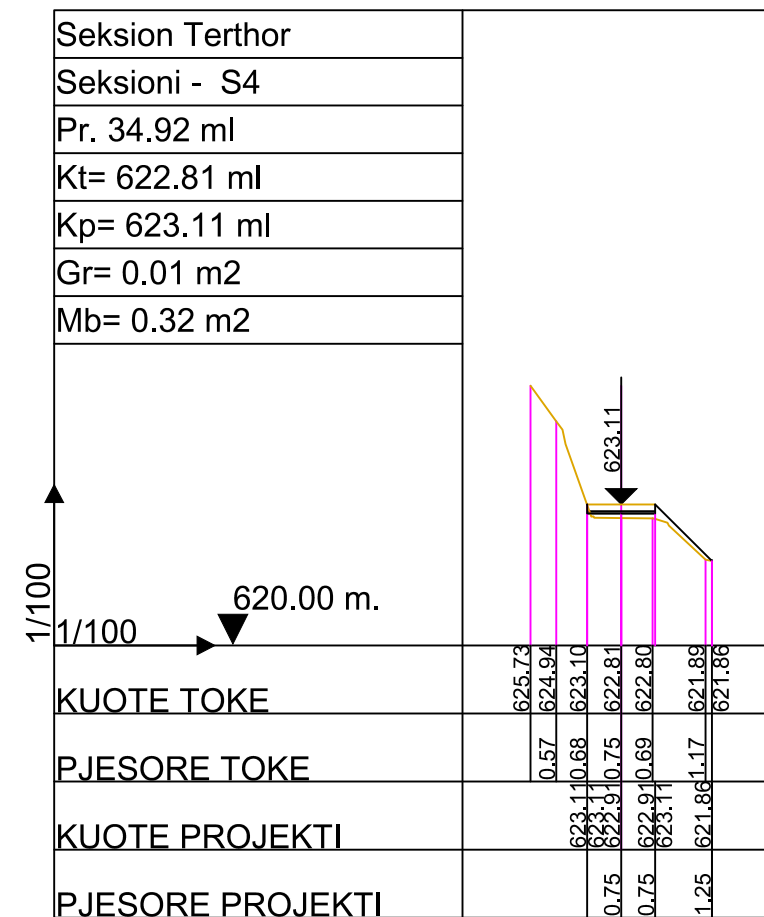
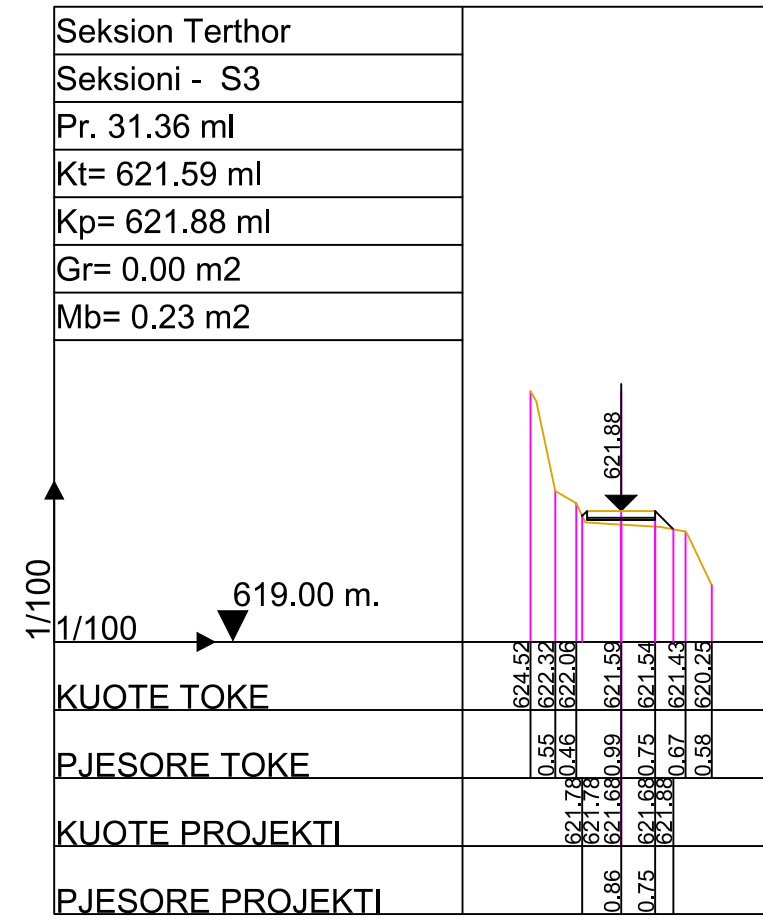
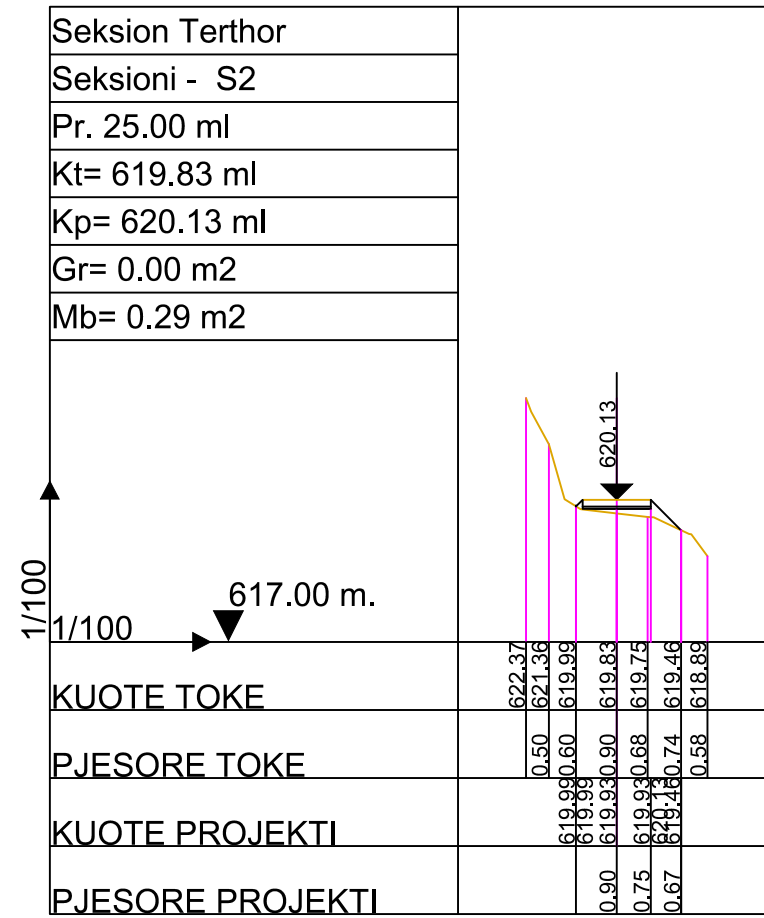
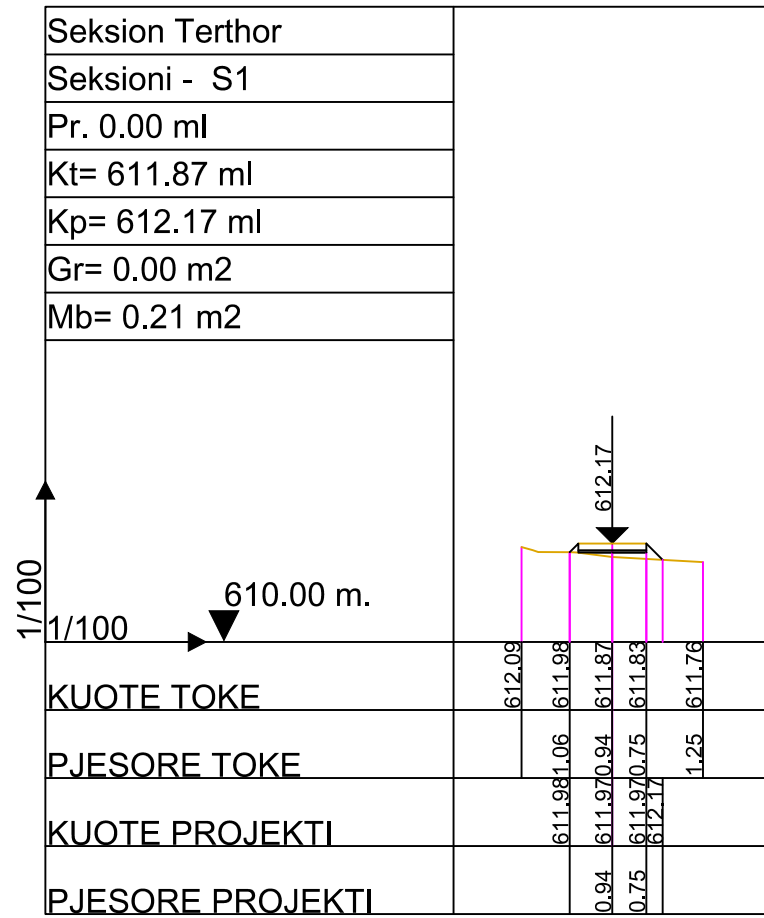

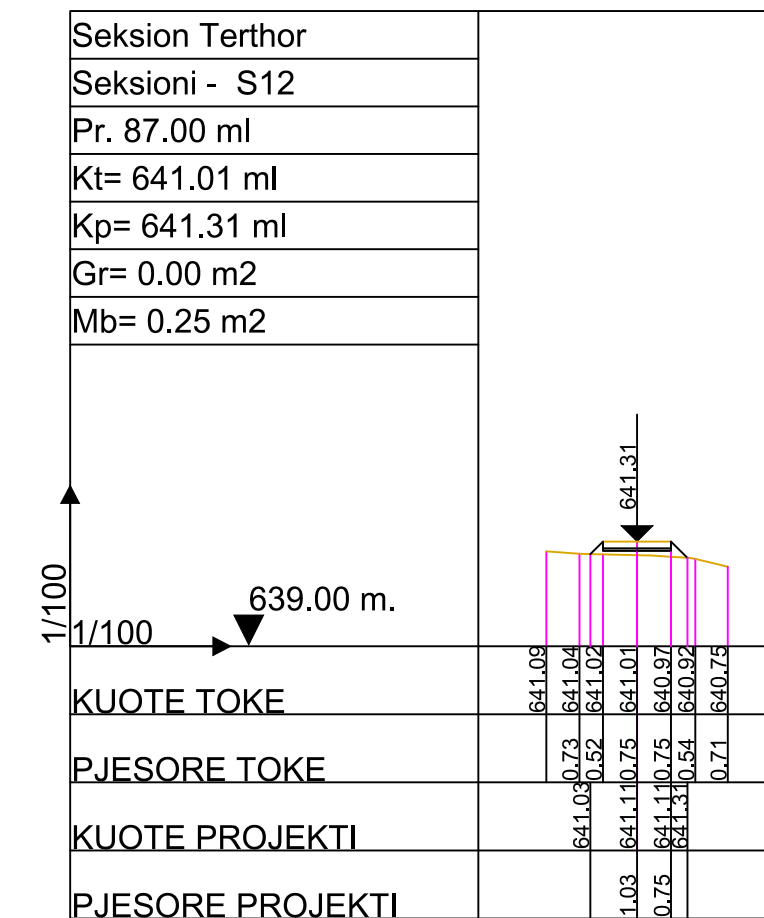
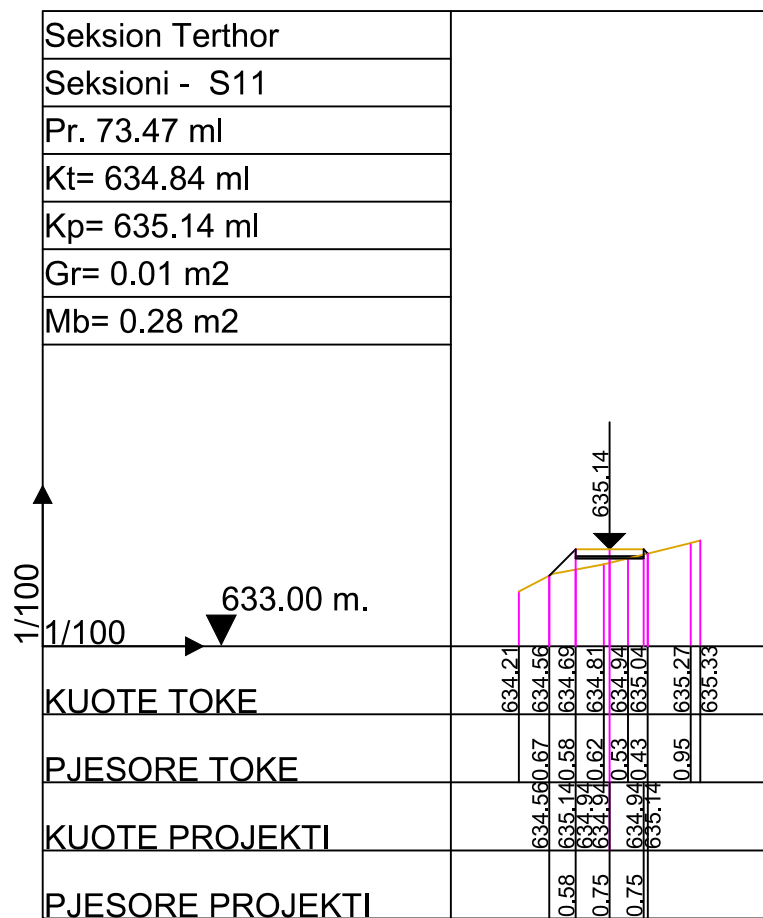
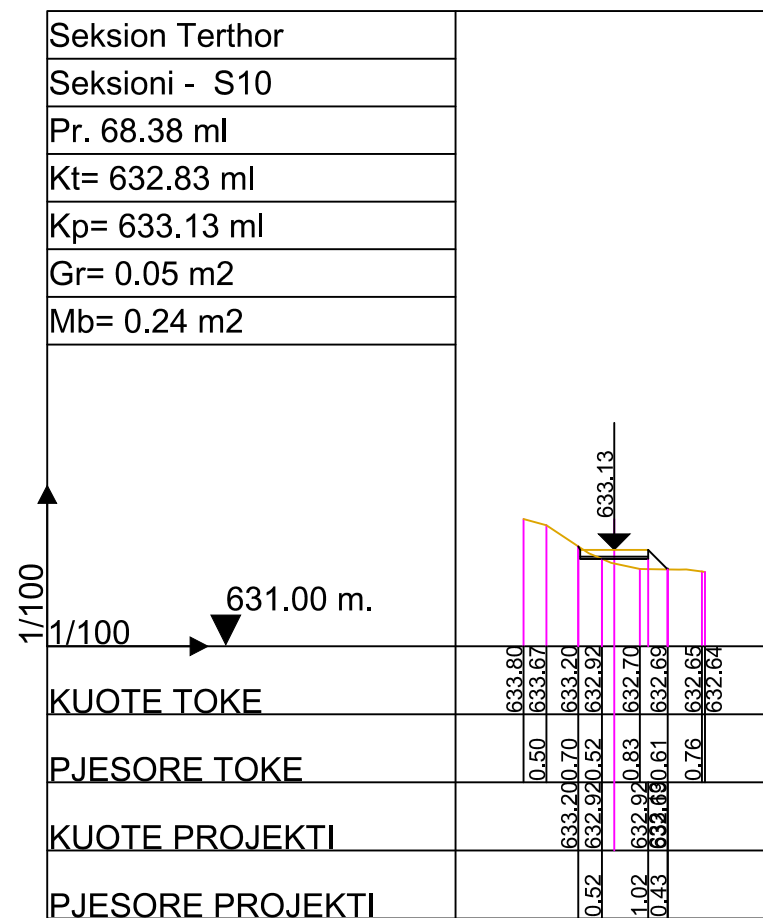
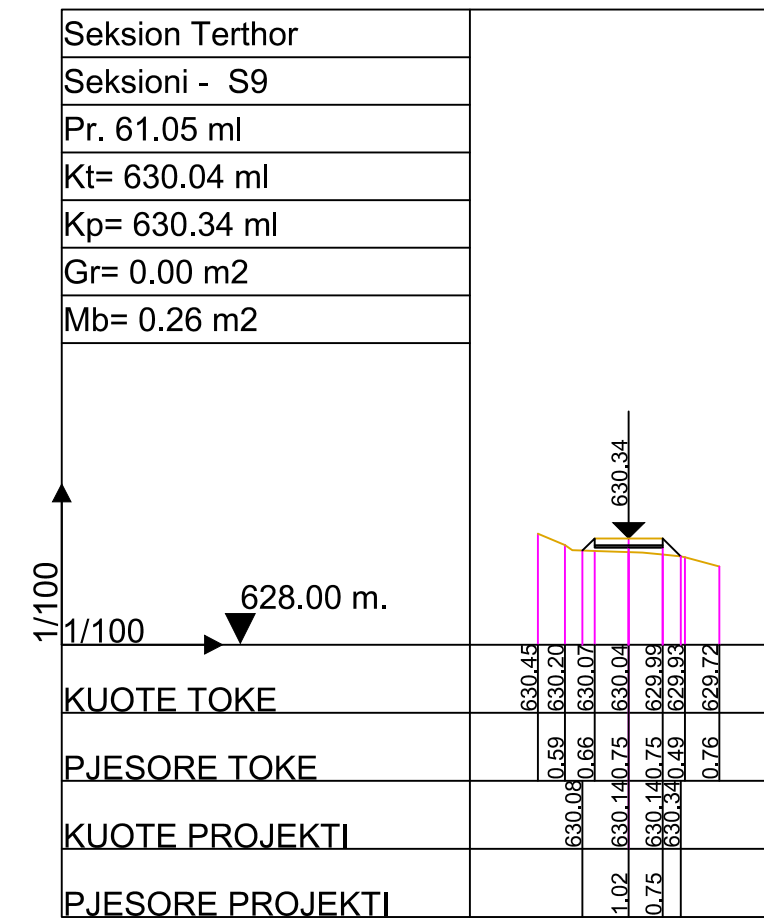
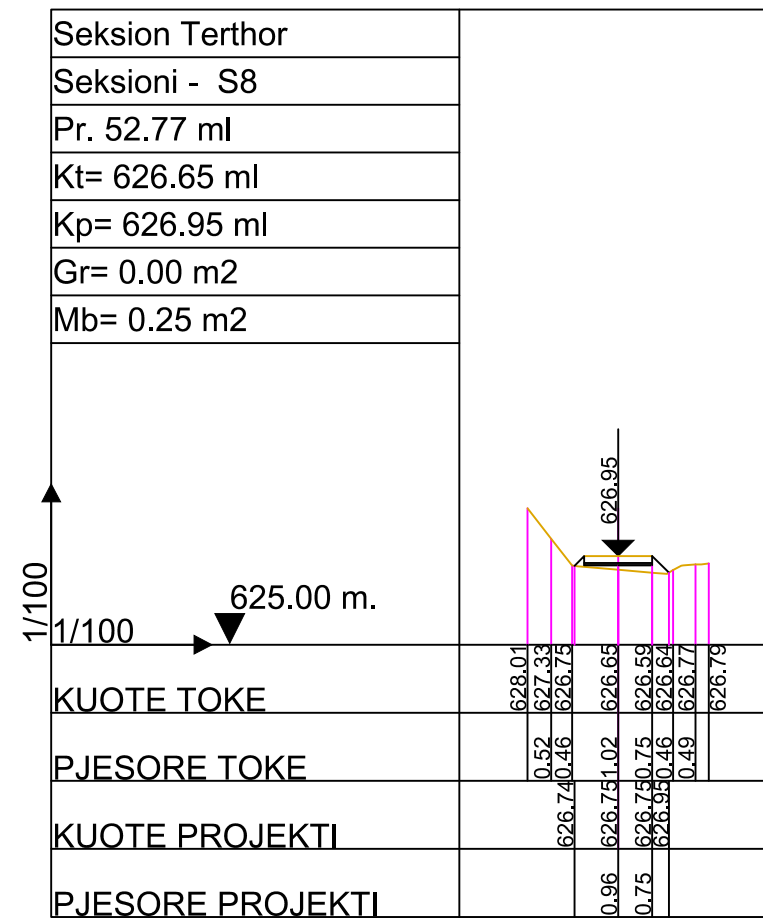
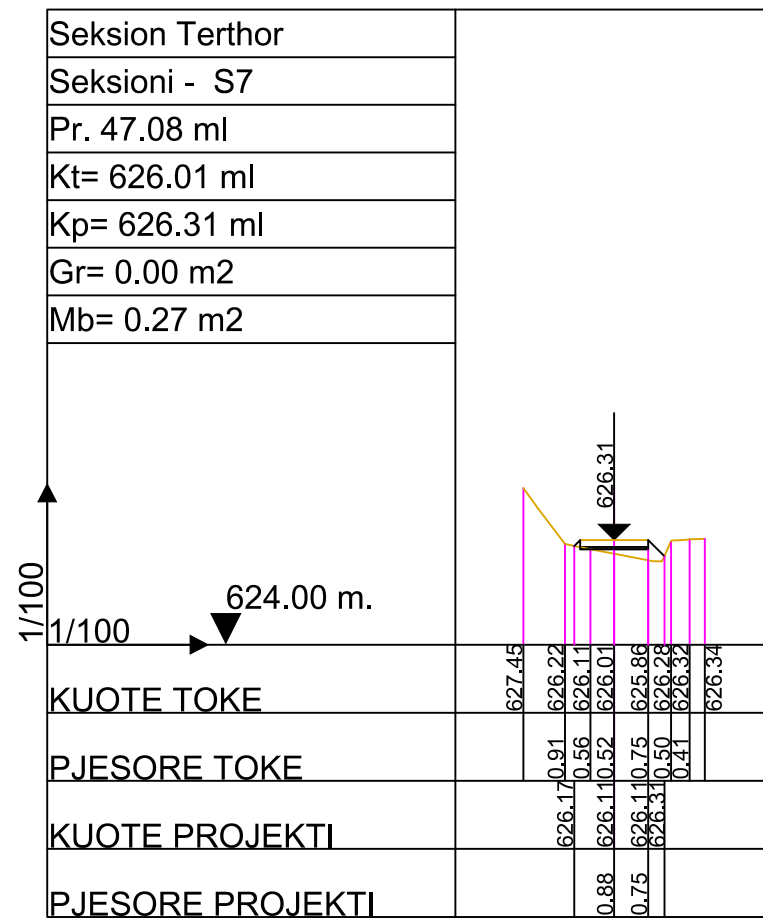

Autoriteit Kontraktor : BASHKIA KRUJE

Objekti: Rikonstrukcion Rruga Kembesore "Kruje - Sarisalltik"

Emertimi: SEKSIONET TERTHORE



"ERALD-G" Sh.p.k  
Adresa: Rruga "Koli Bano", Tirane

Drejtes i projektit

Inxh. Gezim ISLAMI

Projektues

Inxh. Aldo MERKAJ  
Ark. Elton Çarçani  
Hidr. Ersida VERÇANI

Elek. Hajdar KURTI  
Mek. Arben MUHA

SHKALLA

SHK 1:100

Tiranë 2017

FLETA

3 -02

Format A3

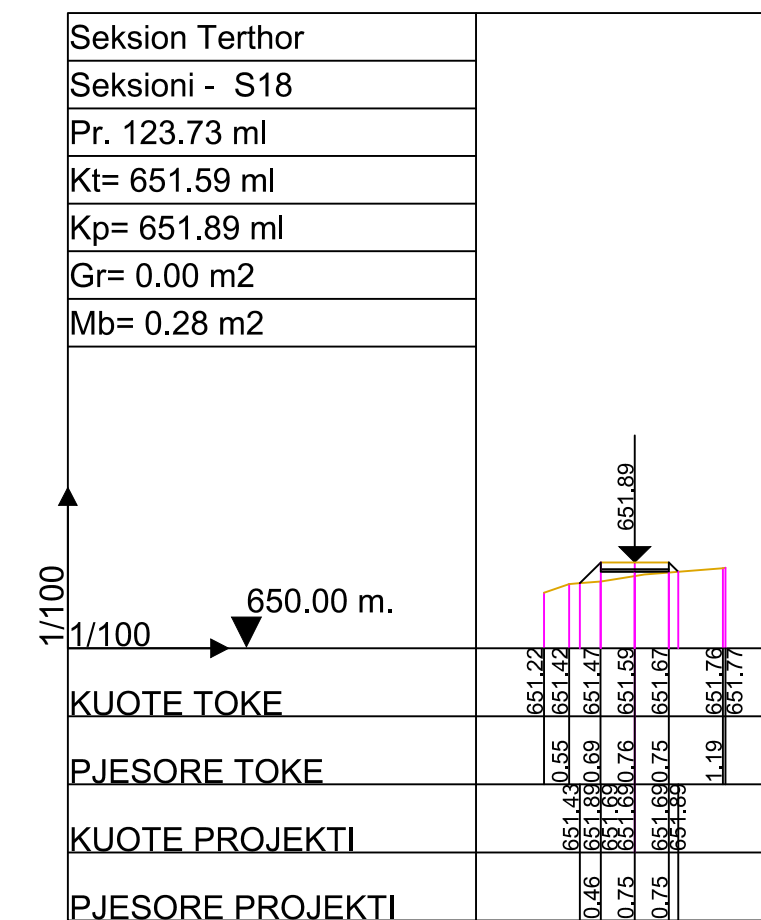
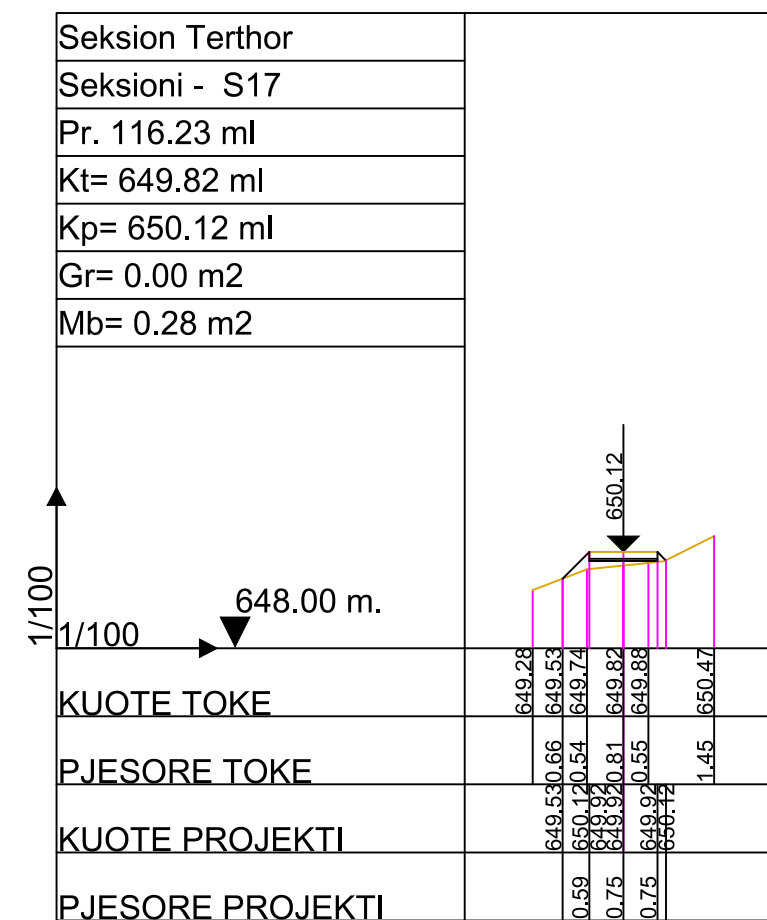
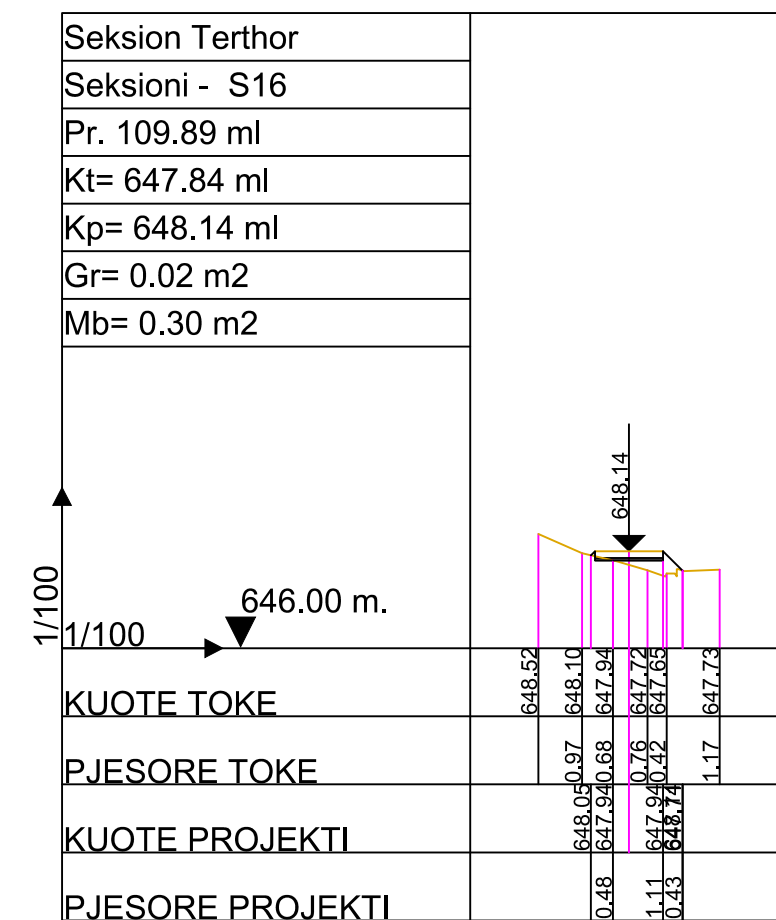
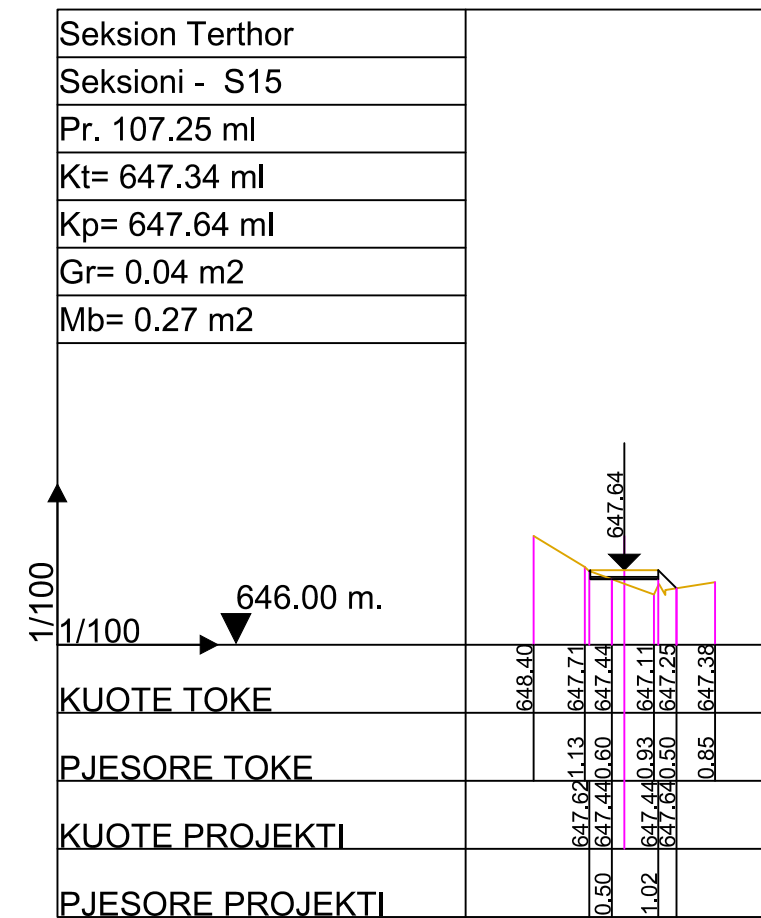
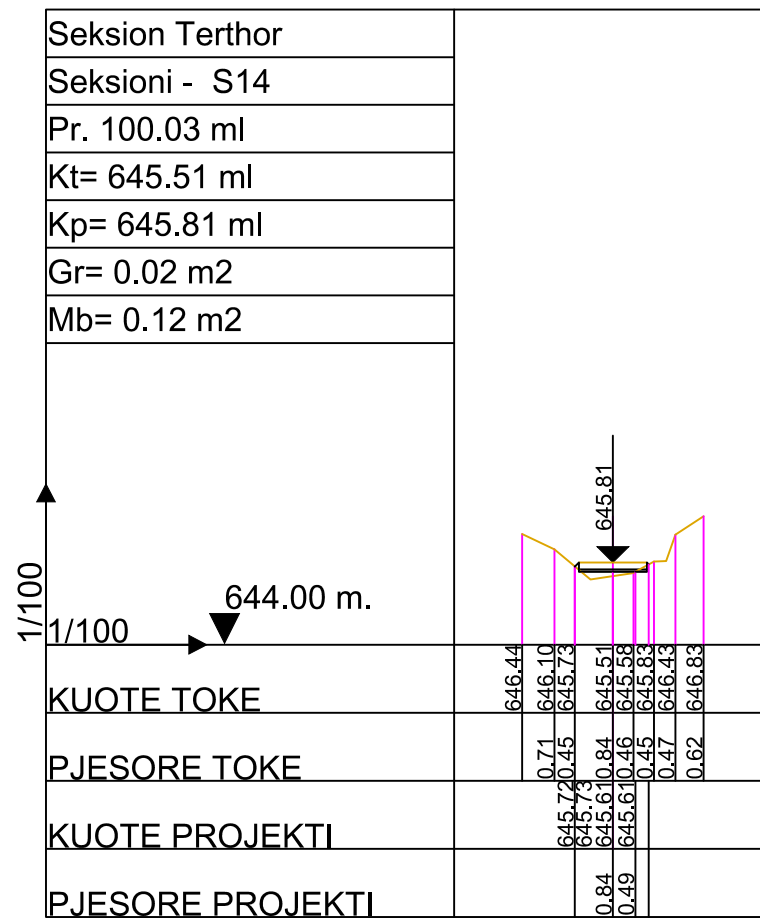
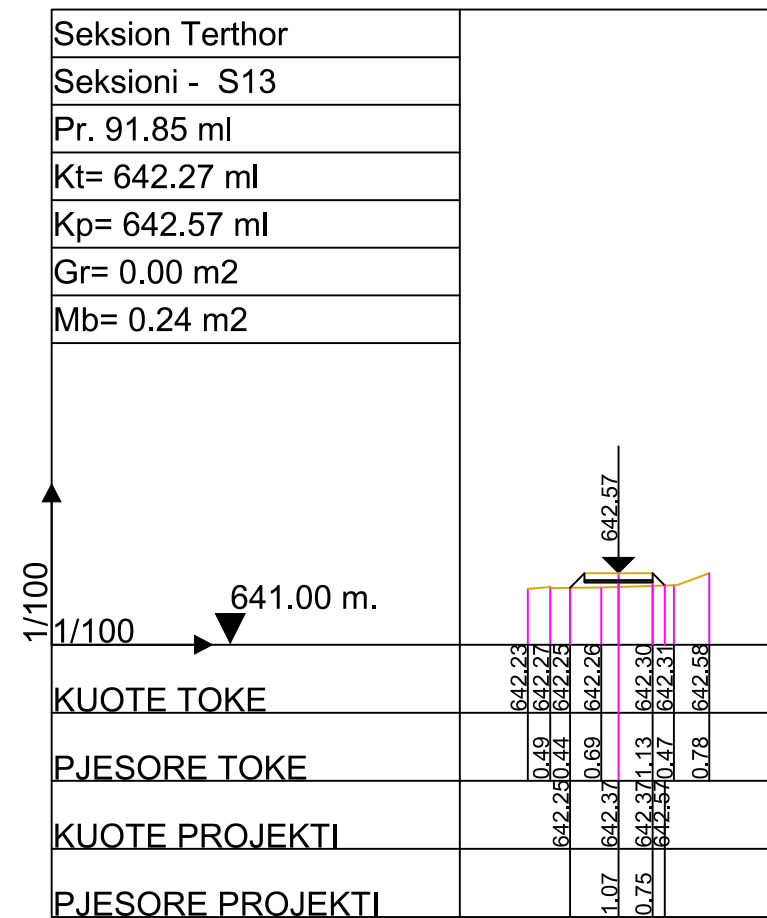

Autoriteit Kontraktor : BASHKIA KRUJE

Objekti: Rikonstruksion Rruga Kembesore "Kruje - Sarisalltik"

Emertimi: SEKSIONET TERTHORE



"ERALD-G" Sh.p.k  
Adresa: Rruga "Koli Bano", Tirane

Drejtes i projektit

Inxh. Gezim ISLAMI

Projektues

Inxh. Aldo MERKAJ  
Ark. Elton Çarçani  
Hidr. Ersida VERÇANI

Elek. Hajdar KURTI  
Mek. Arben MUHA

SHKALLA

SHK 1:100

Tiranë 2017

FLETA

3 -03

Format A3

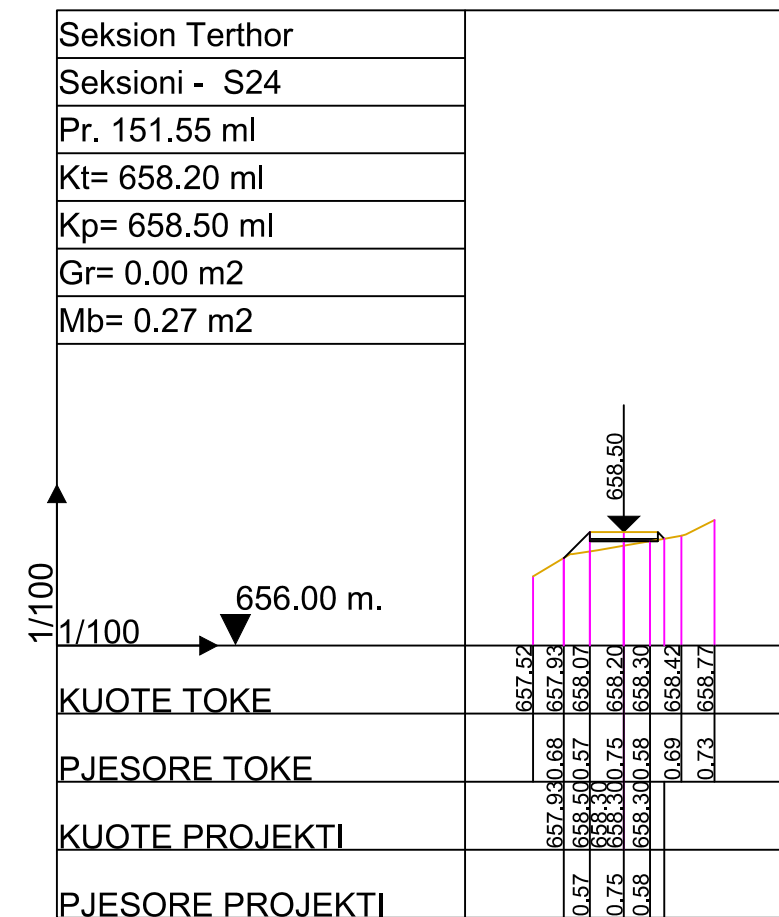
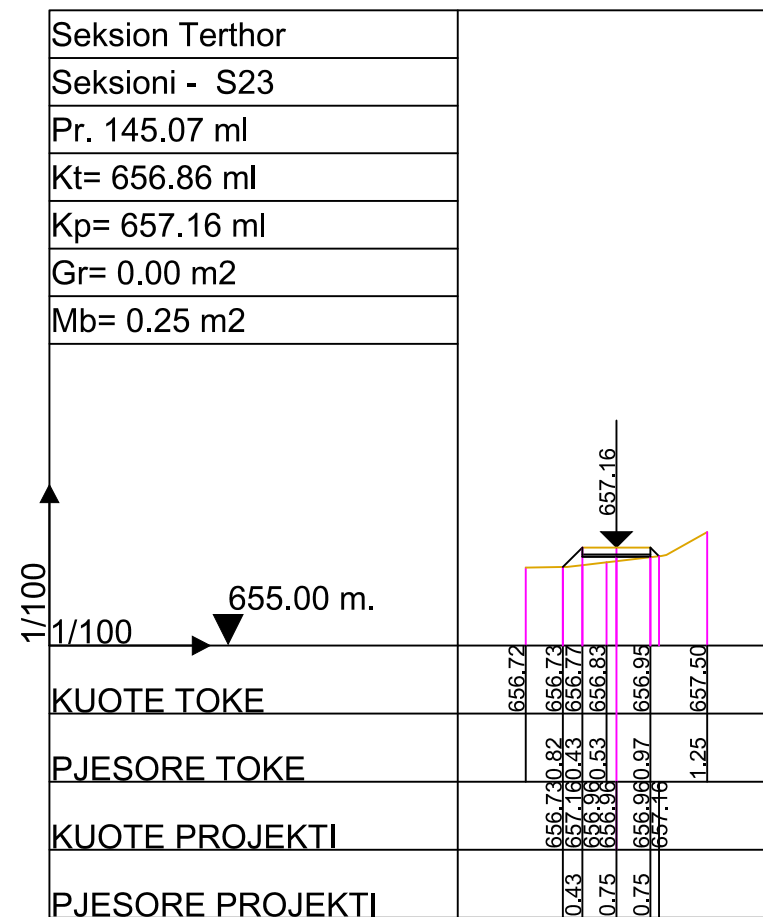
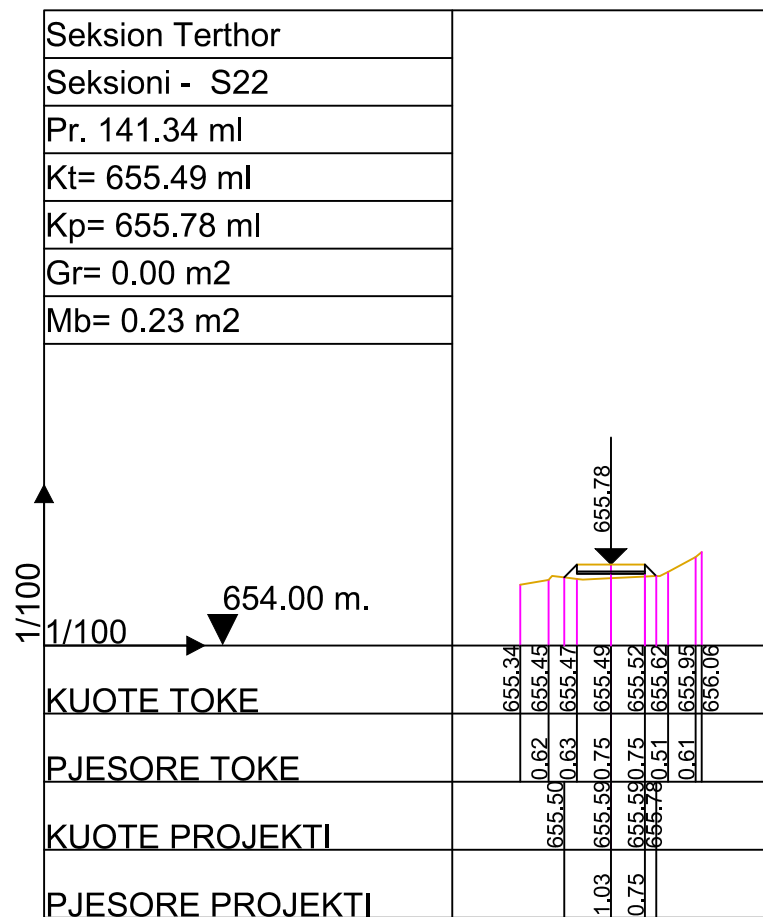
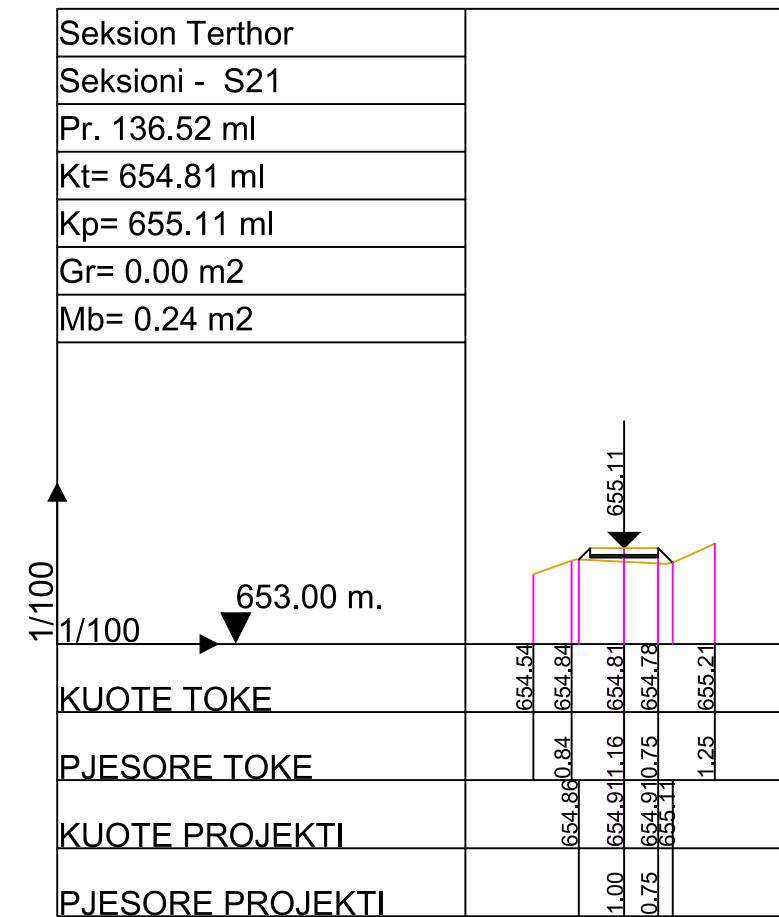
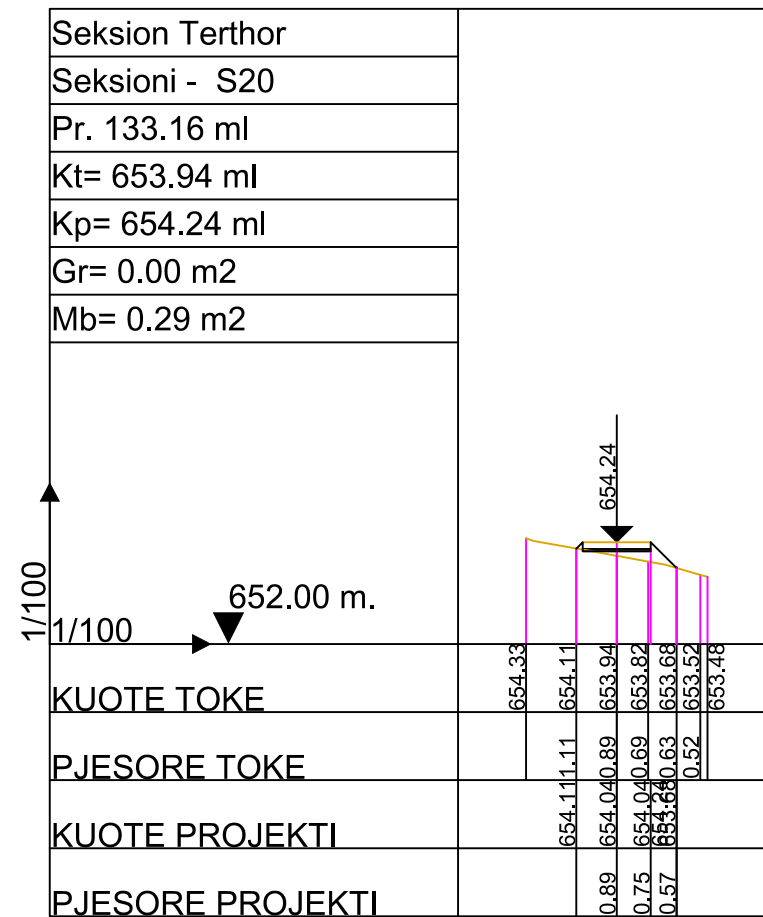
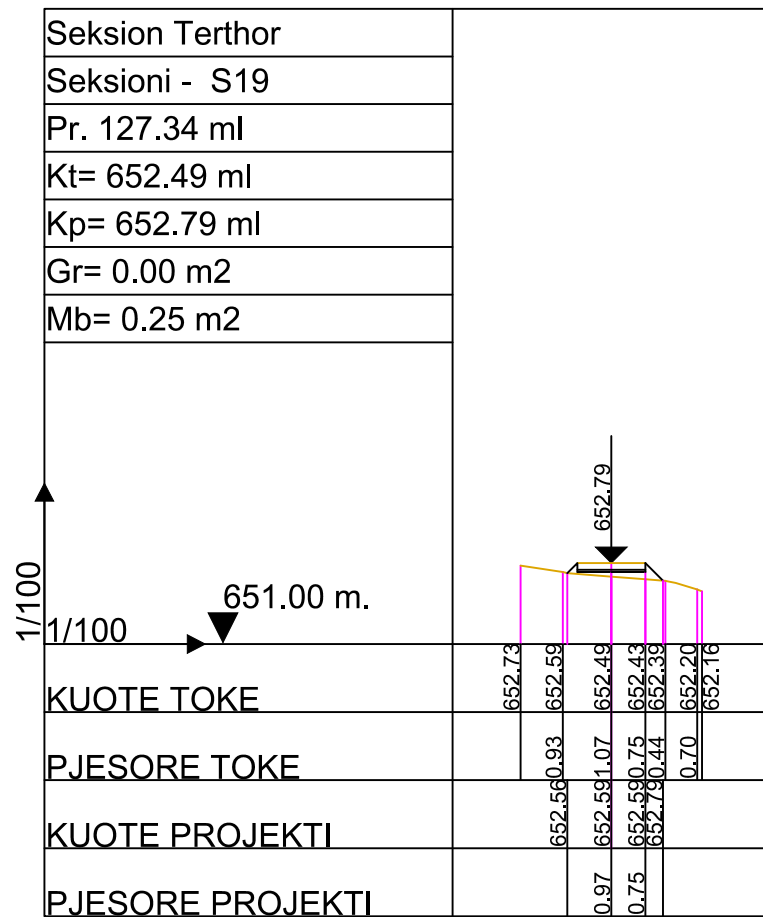

Autoriteit Kontraktor : BASHKIA KRUJE

Objekti: Rikonstruksion Rruga Kembesore "Kruje - Sarisalltik"

Emertimi: SEKSIONET TERTHORE



"ERALD-G" Sh.p.k  
Adresa: Rruga "Koli Bano", Tirane

Drejtes i projektit

Inxh. Gezim ISLAMI

Projektues

Inxh. Aldo MERKAJ  
Ark. Elton Çarçani  
Hidr. Ersida VERÇANI

Elek. Hajdar KURTI  
Mek. Arben MUHA

SHKALLA

SHK 1:100

Tiranë 2017

FLETA

3 -04

Format A3

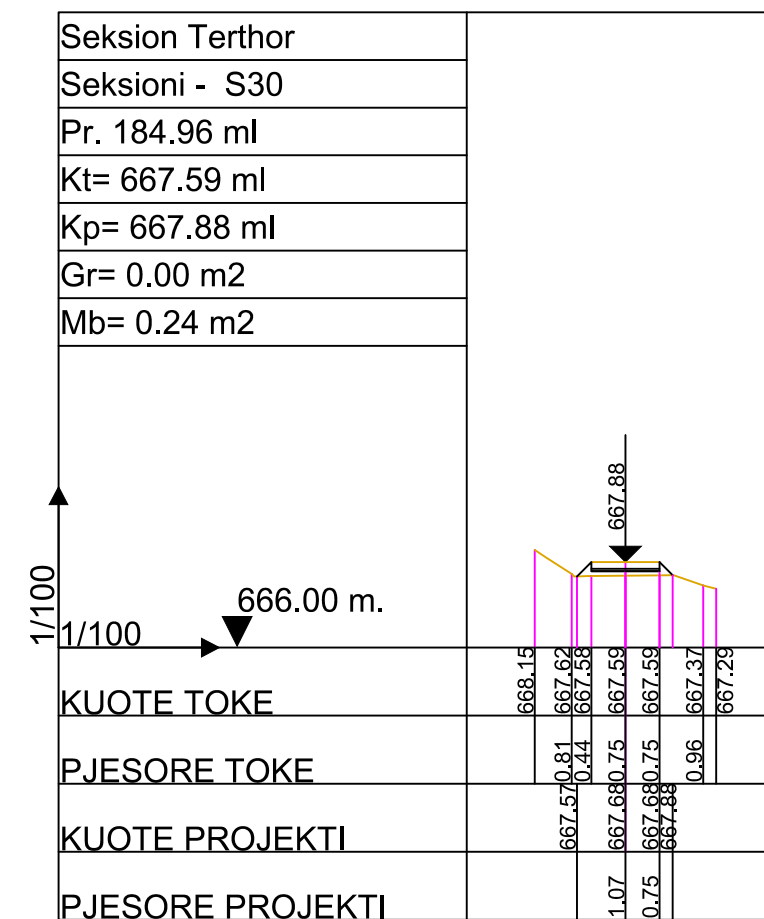
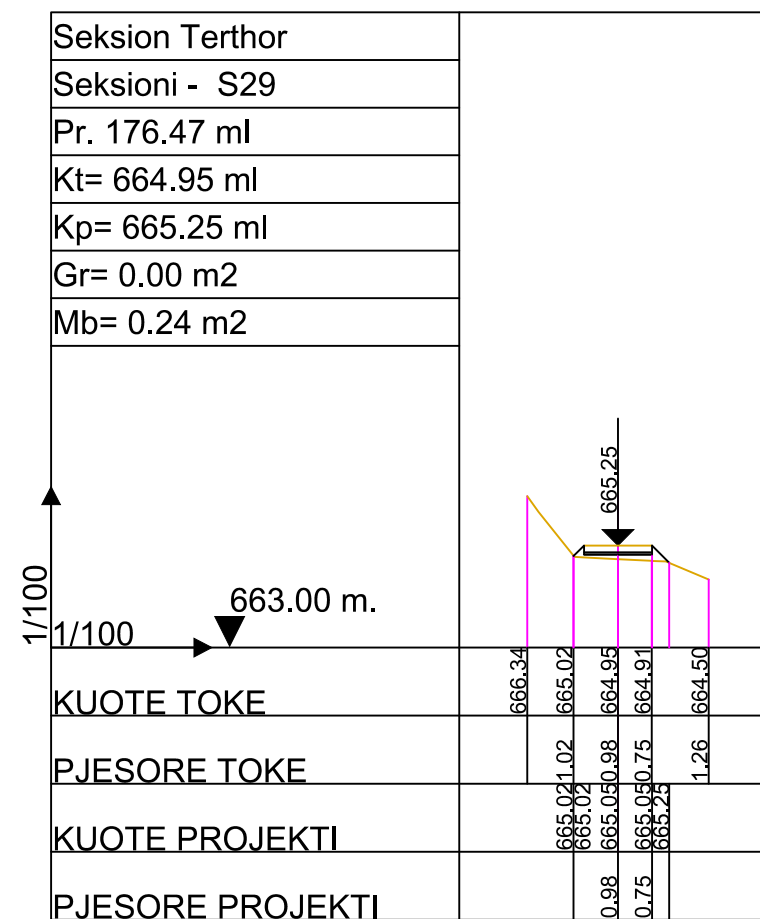
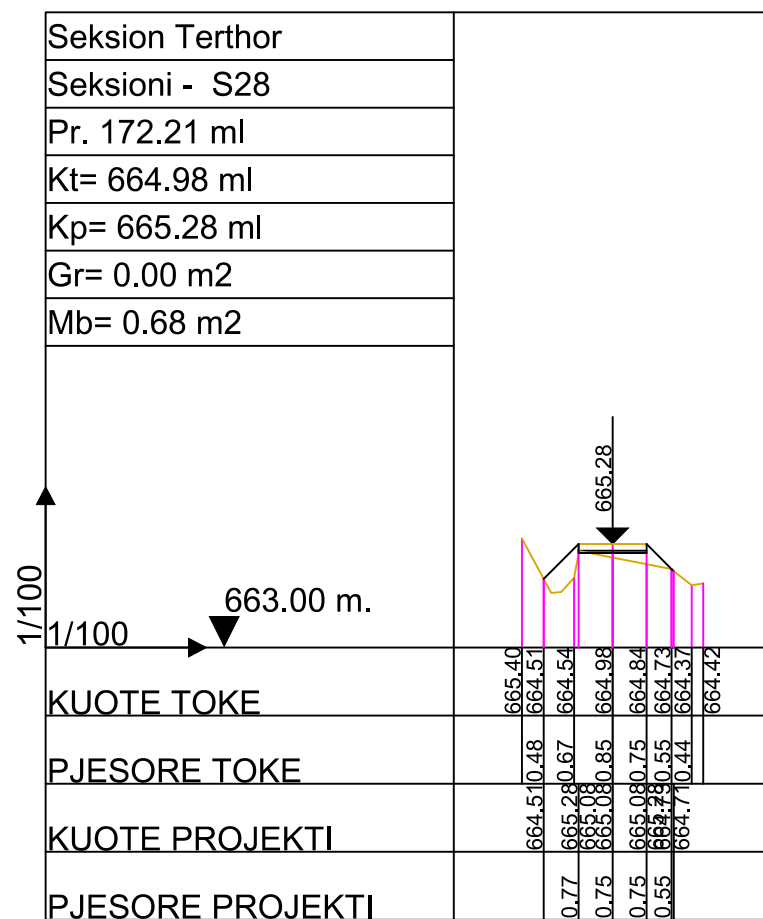
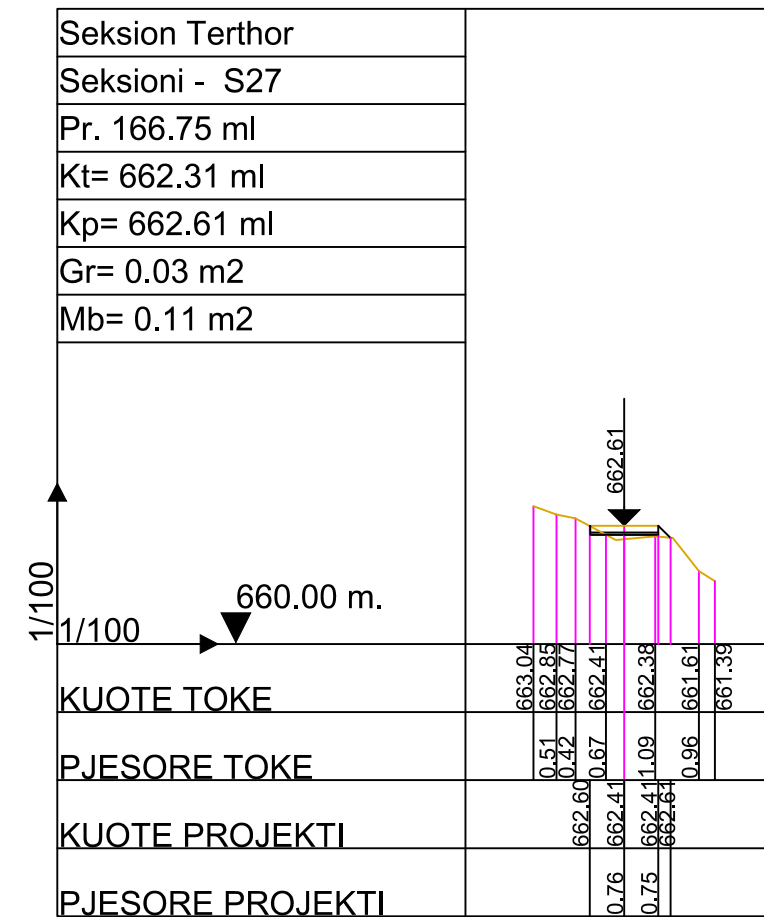
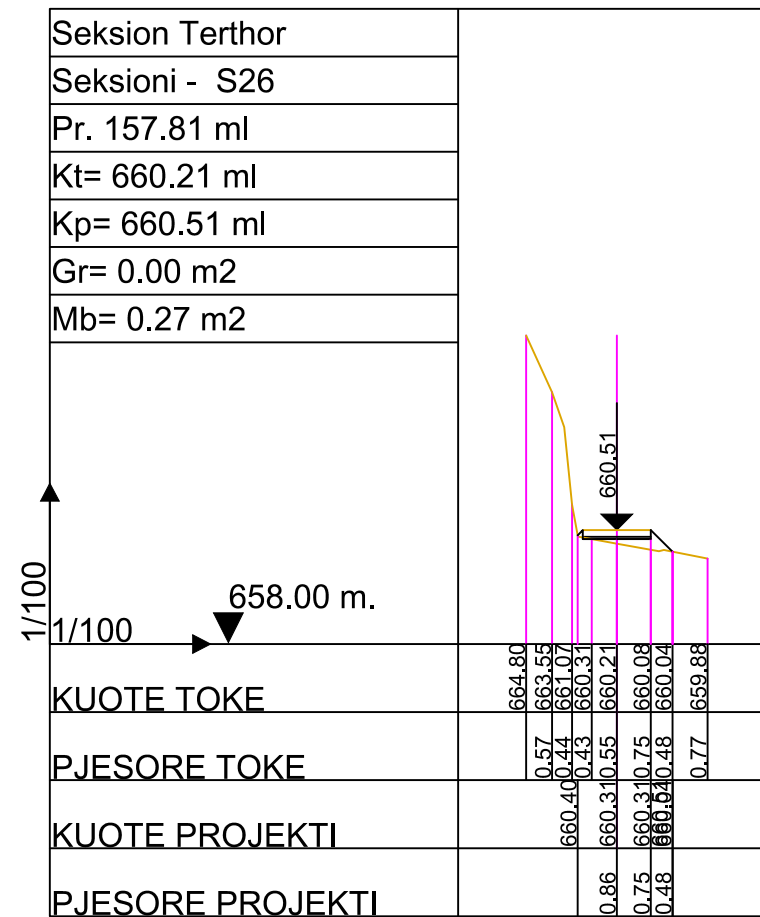
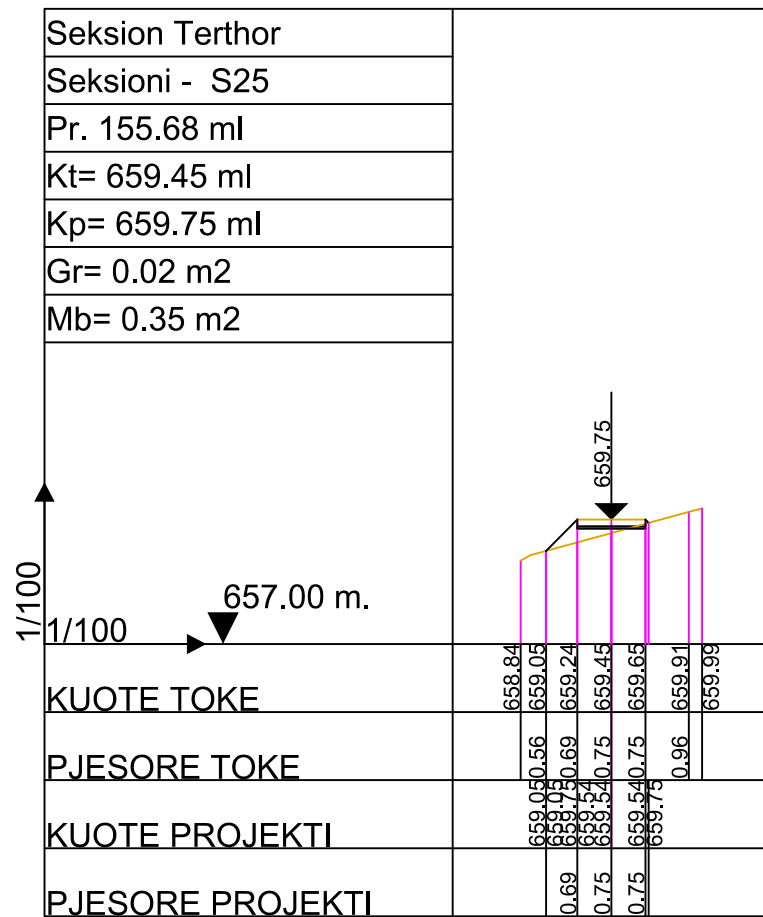

Autoriteit Kontraktor : BASHKIA KRUJE

Objekti: Rikonstruksion Rruga Kembesore "Kruje - Sarisalltik"

Emertimi: SEKSIONET TERTHORE



"ERALD-G" Sh.p.k  
Adresa: Rruga "Koli Bano", Tirane

Drejtes i projektit

Inxh. Gezim ISLAMI

Projektues

Inxh. Aldo MERKAJ  
Ark. Elton Çarçani  
Hidr. Ersida VERÇANI

Elek. Hajdar KURTI  
Mek. Arben MUHA

SHKALLA

SHK 1:100

Tiranë 2017

FLETA

3 -05

Format A3

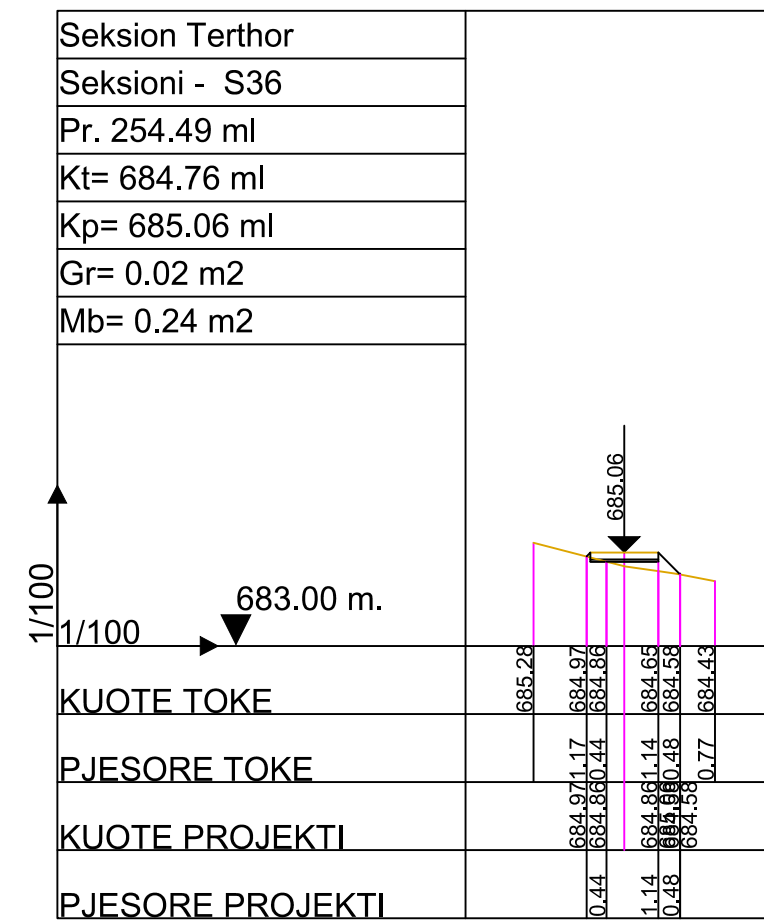
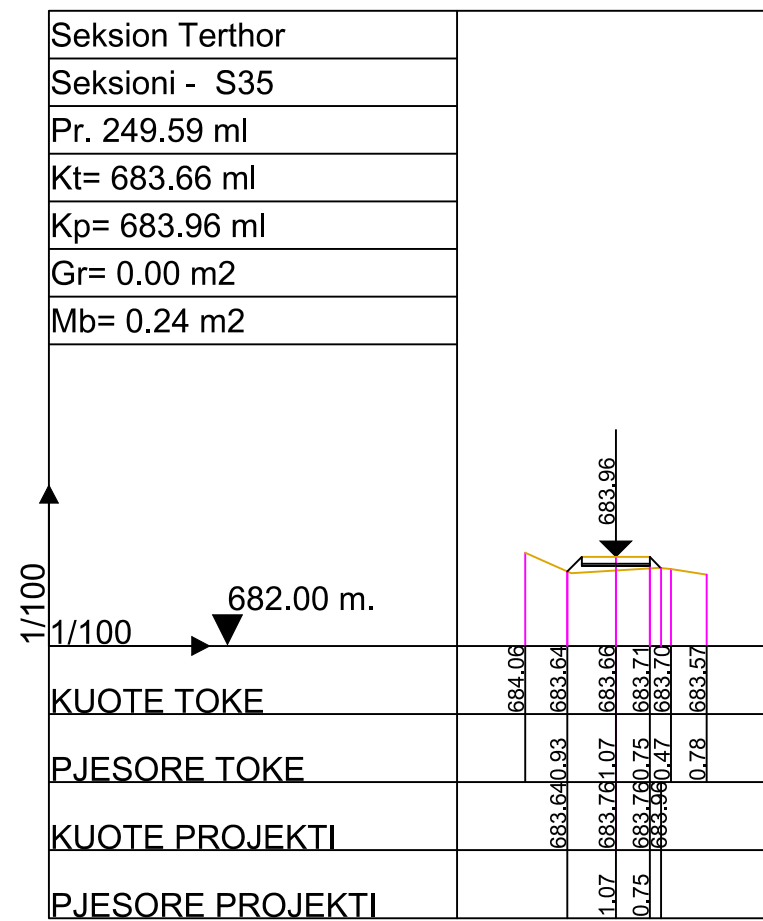
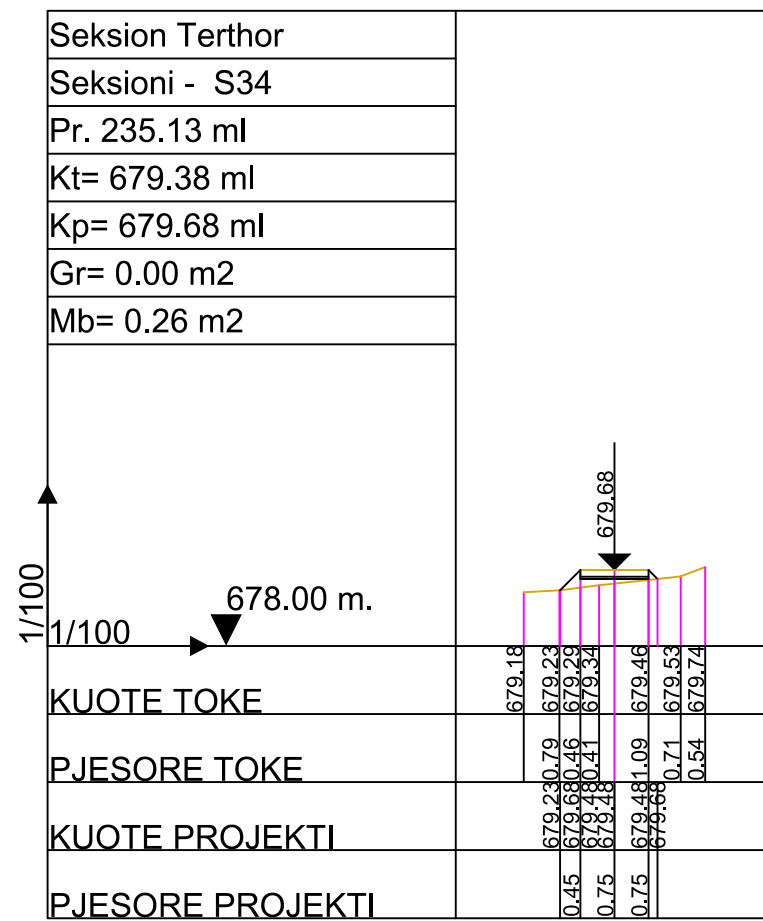
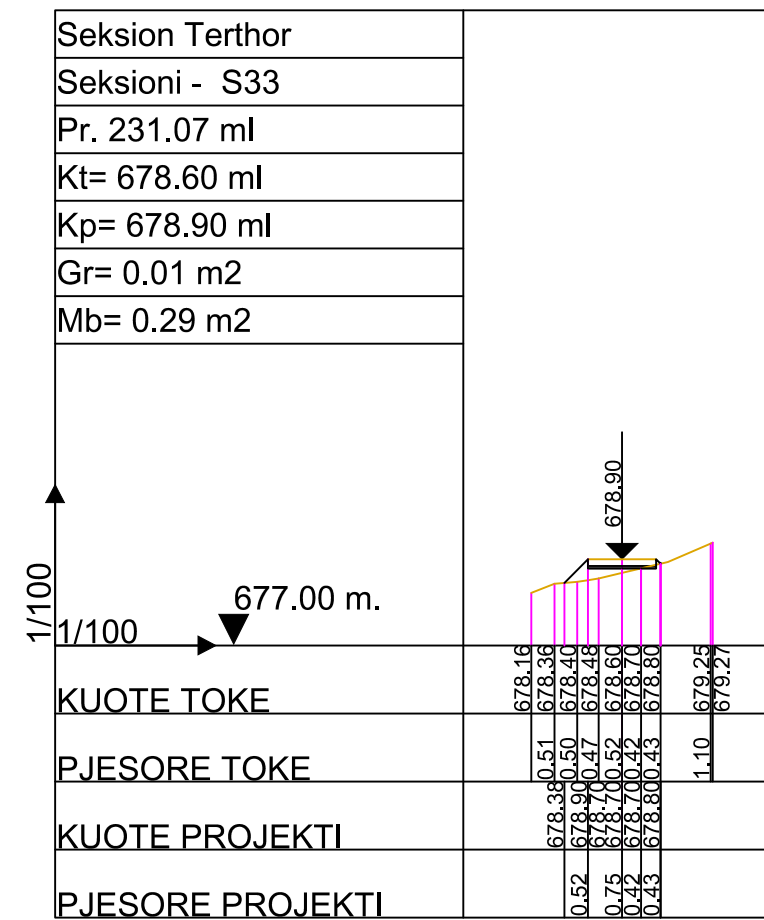
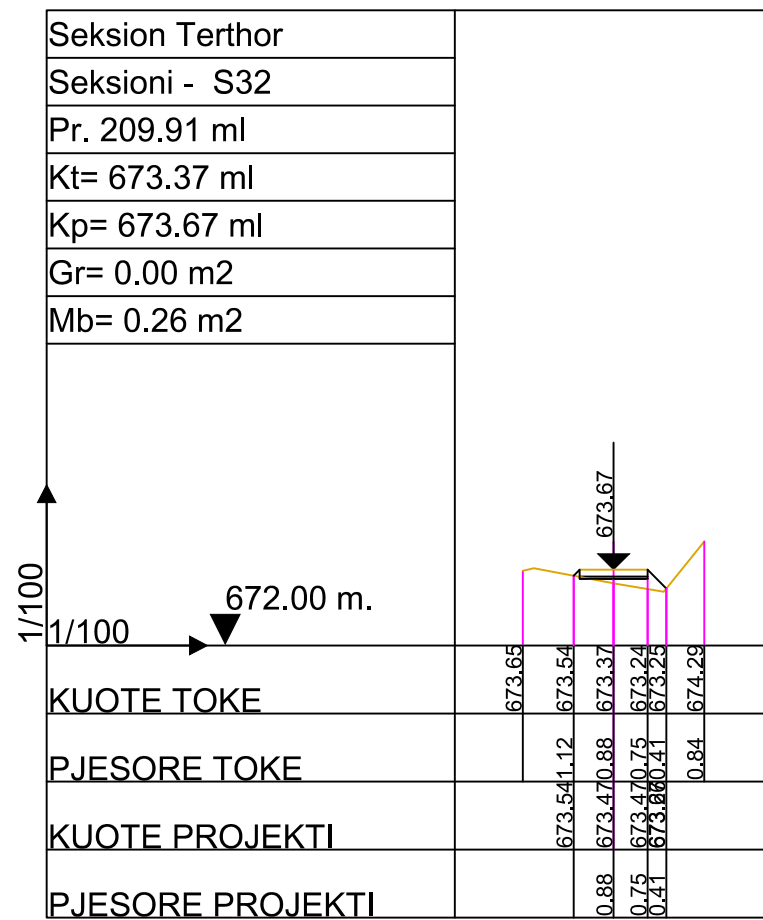
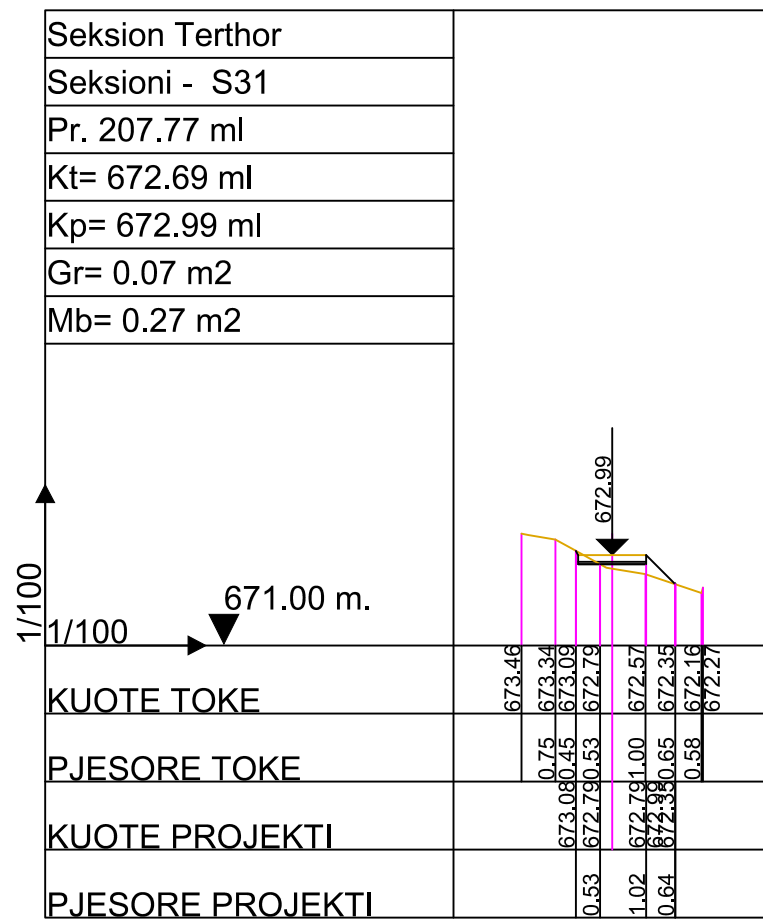

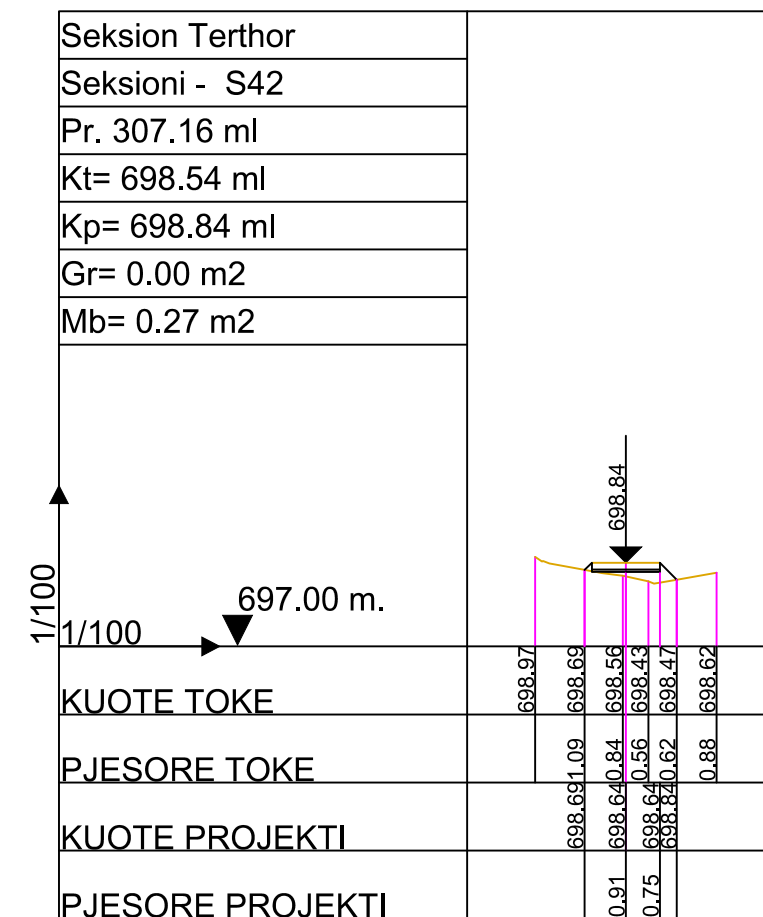
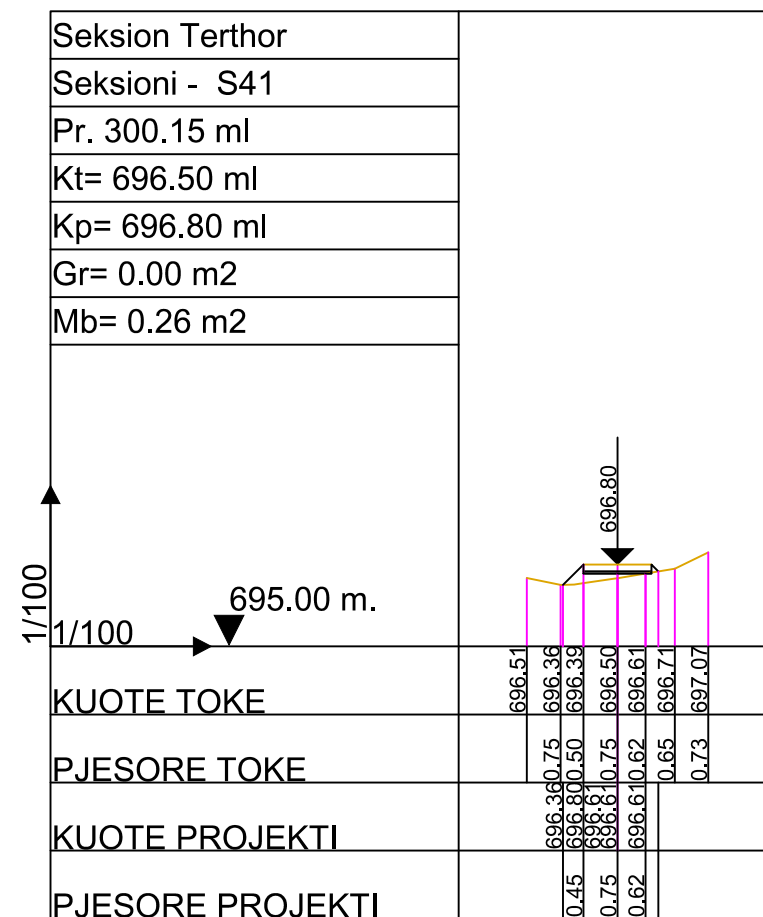
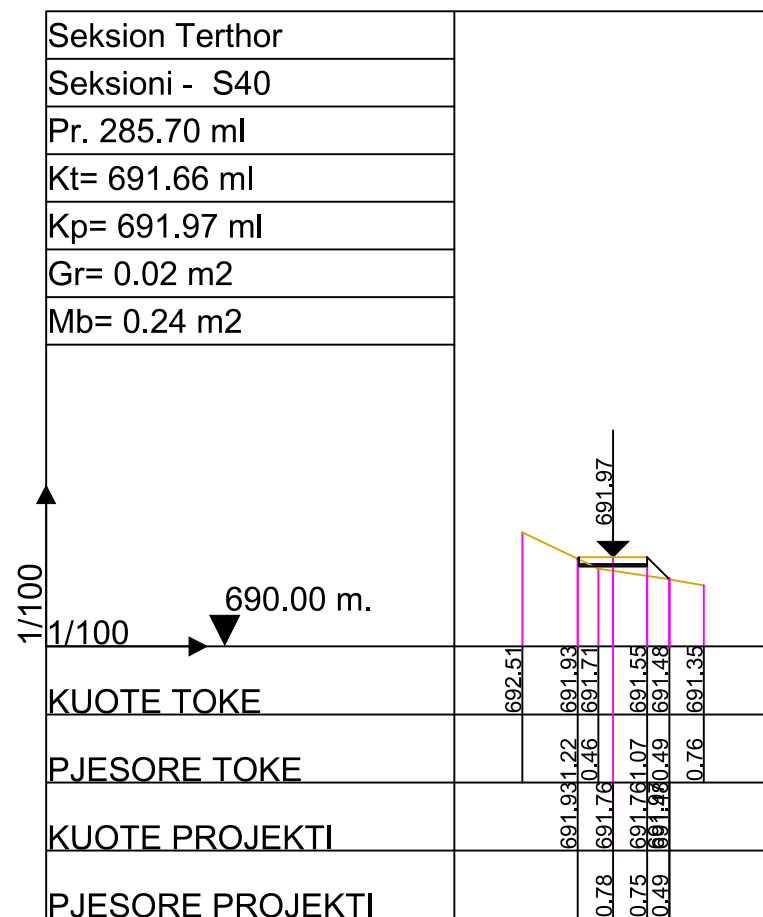
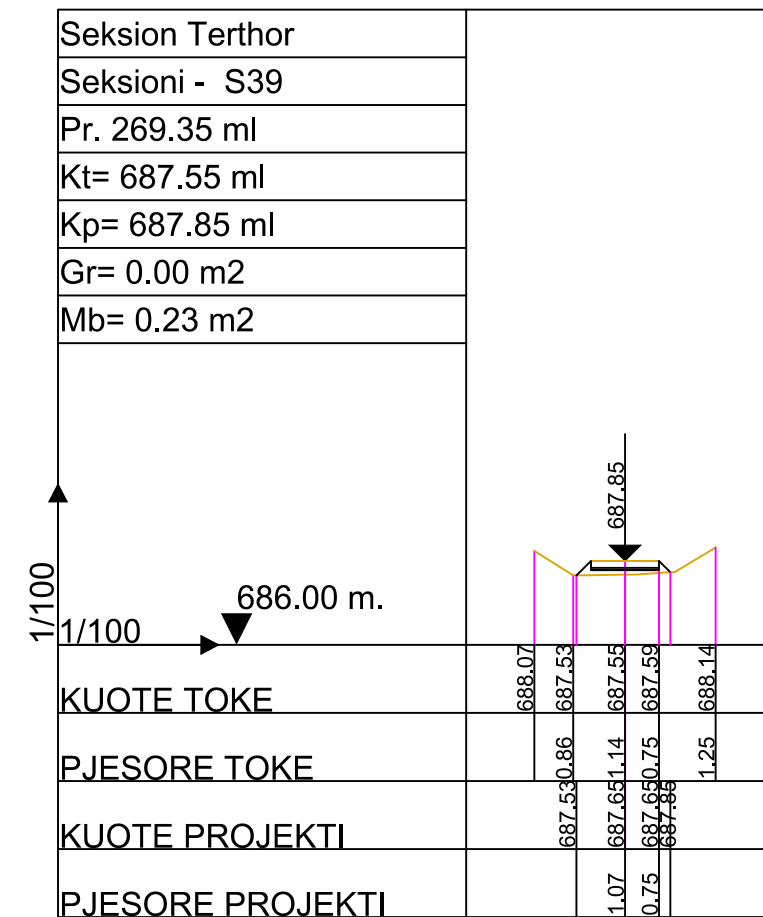
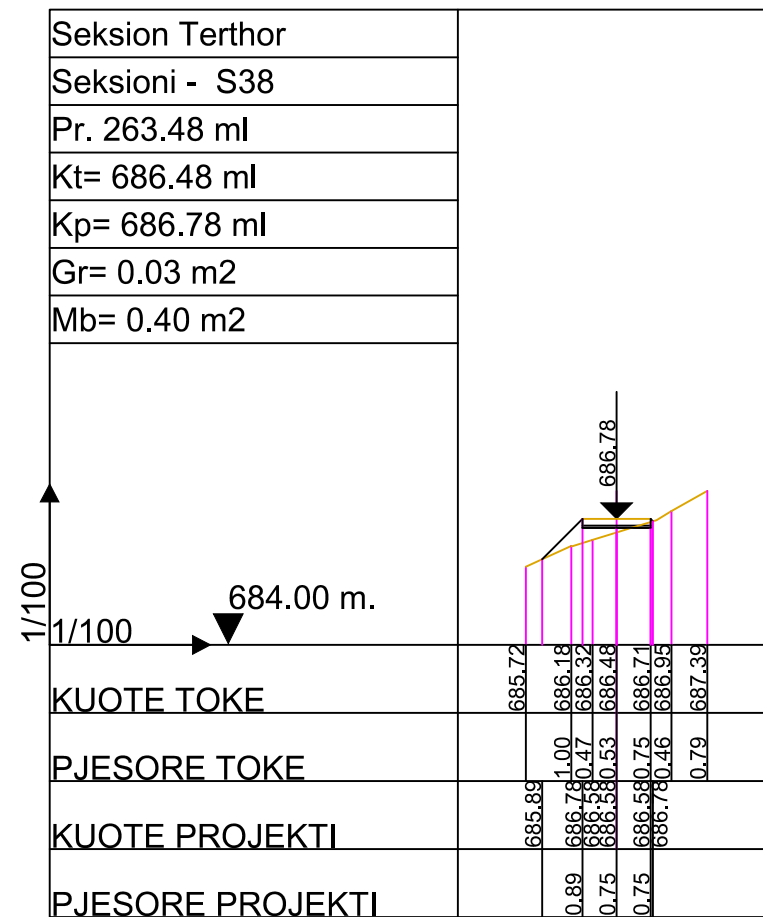
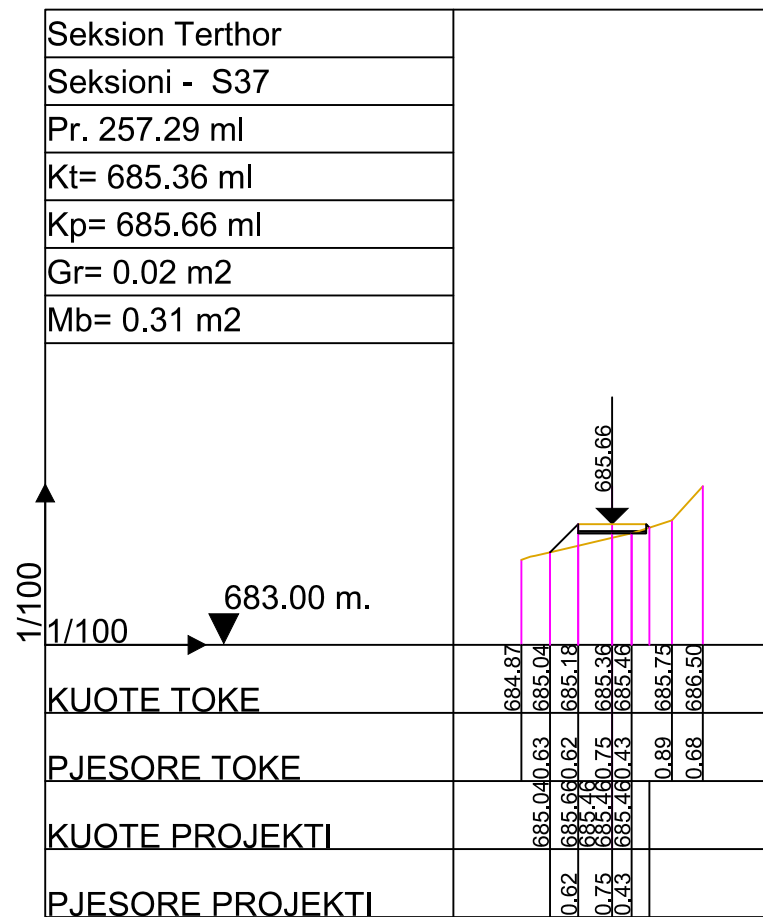

Autoriteit Kontraktor : BASHKIA KRUJE

Objekti: Rikonstruksion Rruga Kembesore "Kruje - Sarisalltik"

Emertimi: SEKSIONET TERTHORE



"ERALD-G" Sh.p.k

Adresa: Rruga "Koli Bano", Tirane

Drejtes i projektit

Inxh. Gezim ISLAMI

Projektues

Inxh. Aldo MERKAJ

Ark.Elton Çarçani

Elek. Hajdar KURTI

Mek. Arben MUHA

SHKALLA

SHK 1:100

Tiranë 2017

FLETA

3 -07

Format A3



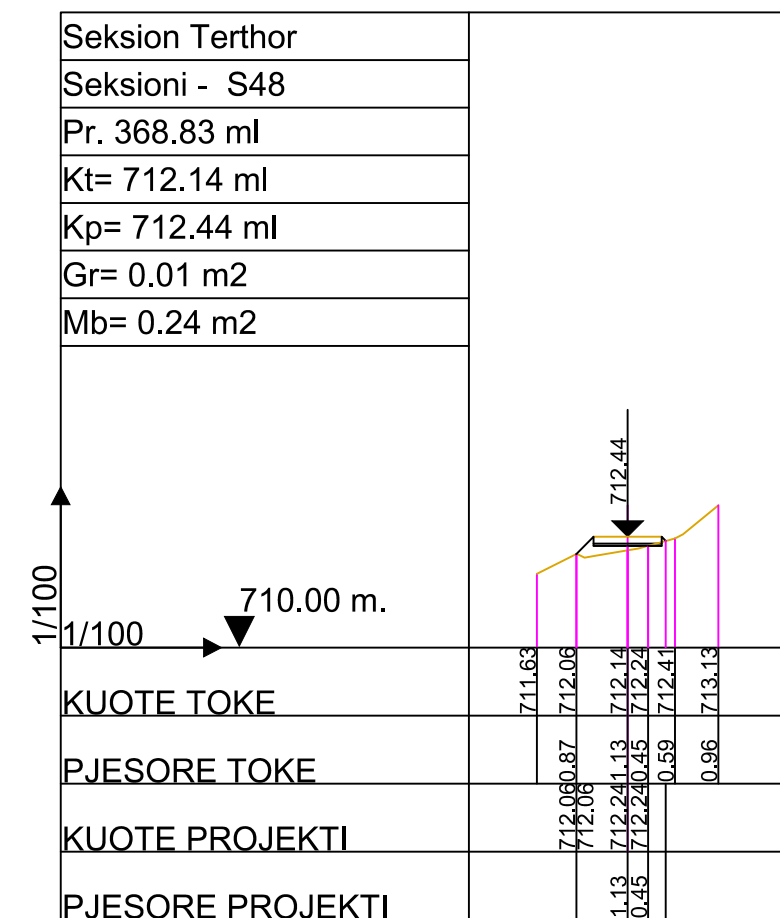
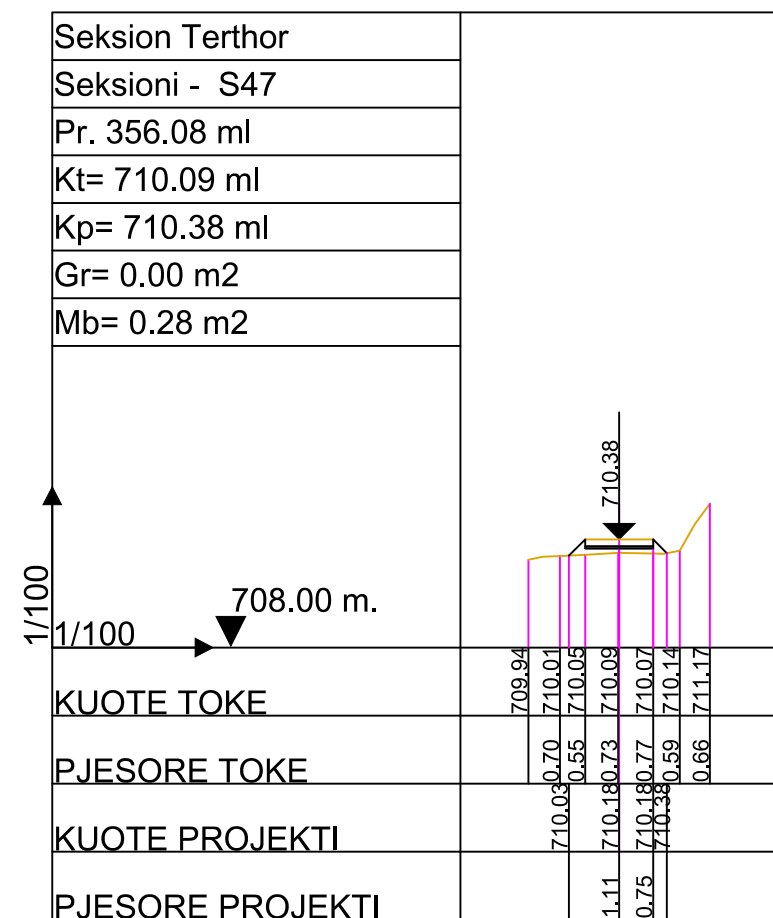
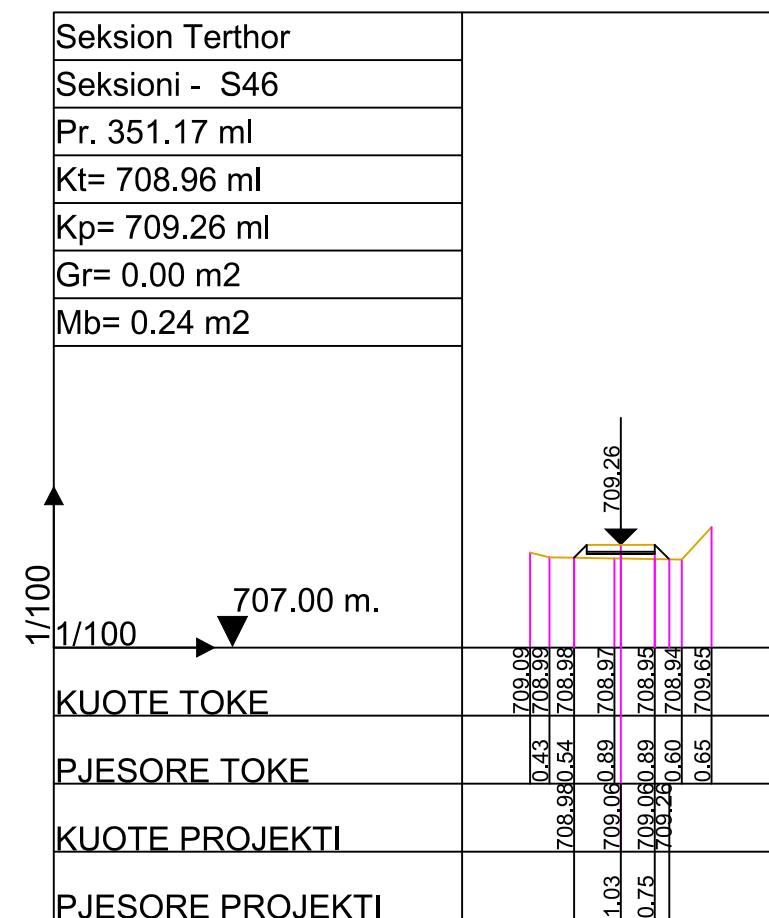
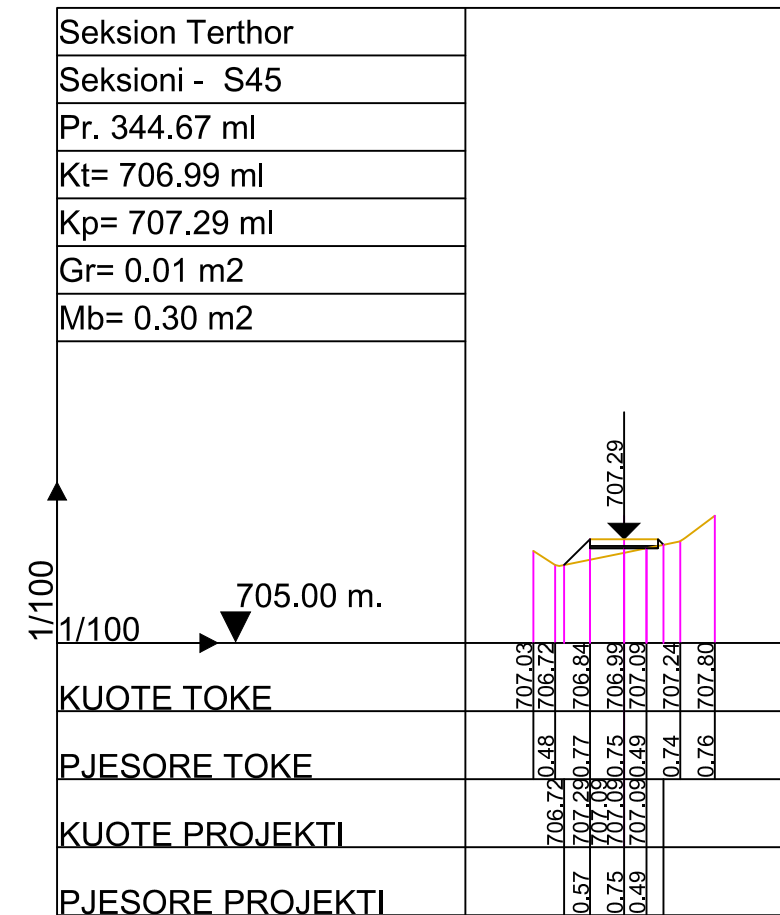
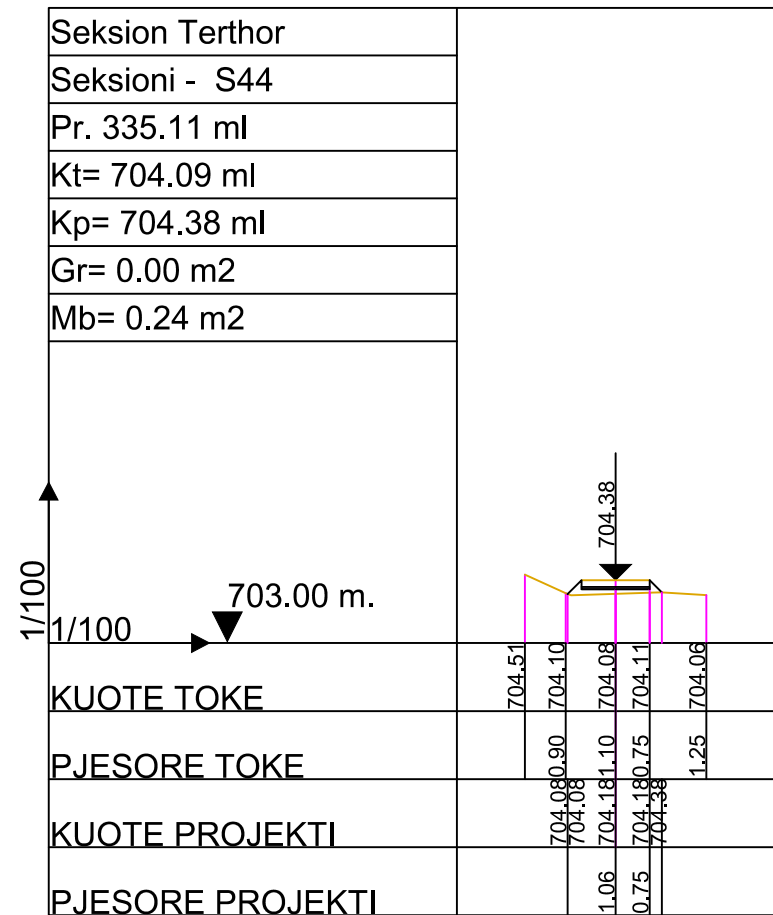
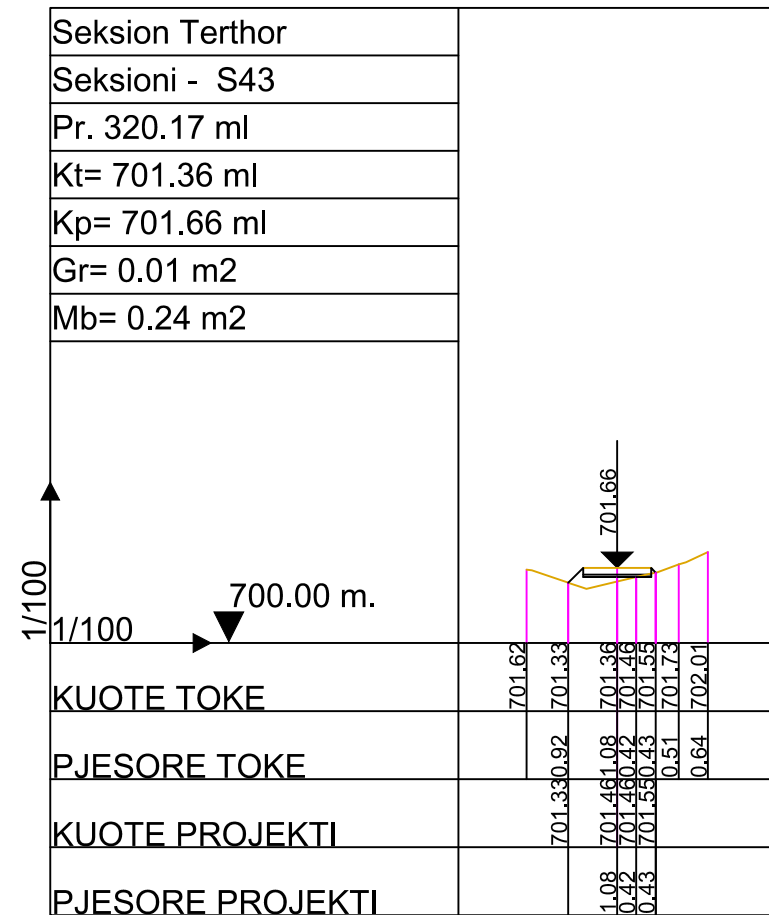

Autoriteit Kontraktor : BASHKIA KRUJE

Objekti: Rikonstruksion Rruga Kembesore "Kruje - Sarisalltik"

Emertimi: SEKSIONET TERTHORE



"ERALD-G" Sh.p.k  
Adresa: Rruga "Koli Bano",Tirane

Drejtes i projektit

Inxh. Gezim ISLAMI

Projektues

Inxh. Aldo MERKAJ  
Ark.Elton Çarçani  
Hidr. Ersida VERÇANI

Elek. Hajdar KURTI  
Mek. Arben MUHA

SHKALLA

SHK 1:100

Tiranë 2017

FLETA

3 -08

Format A3

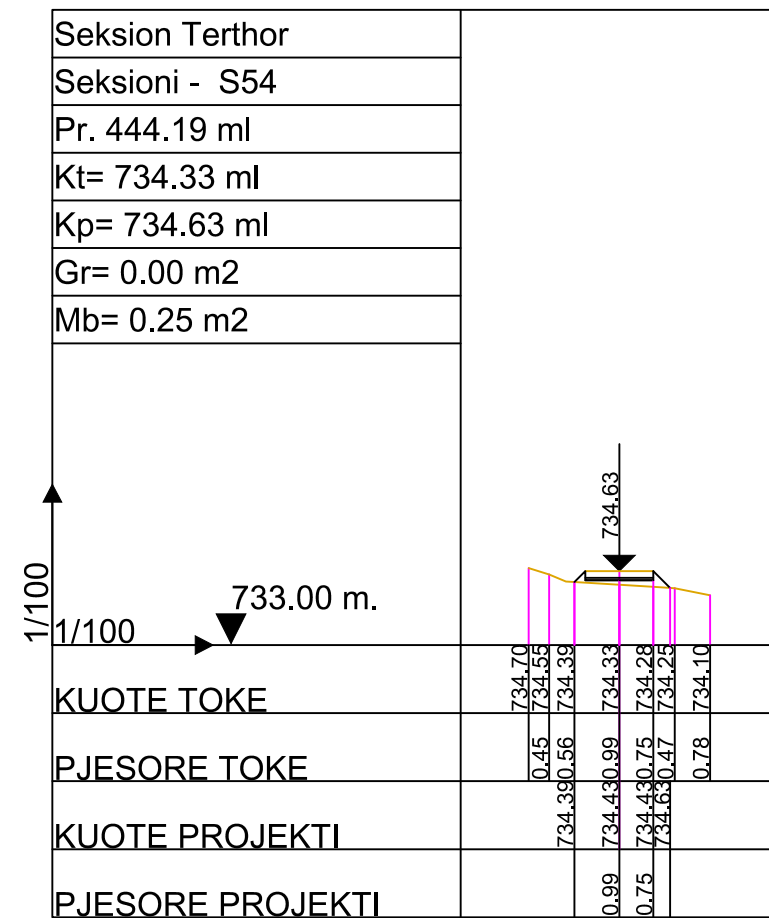
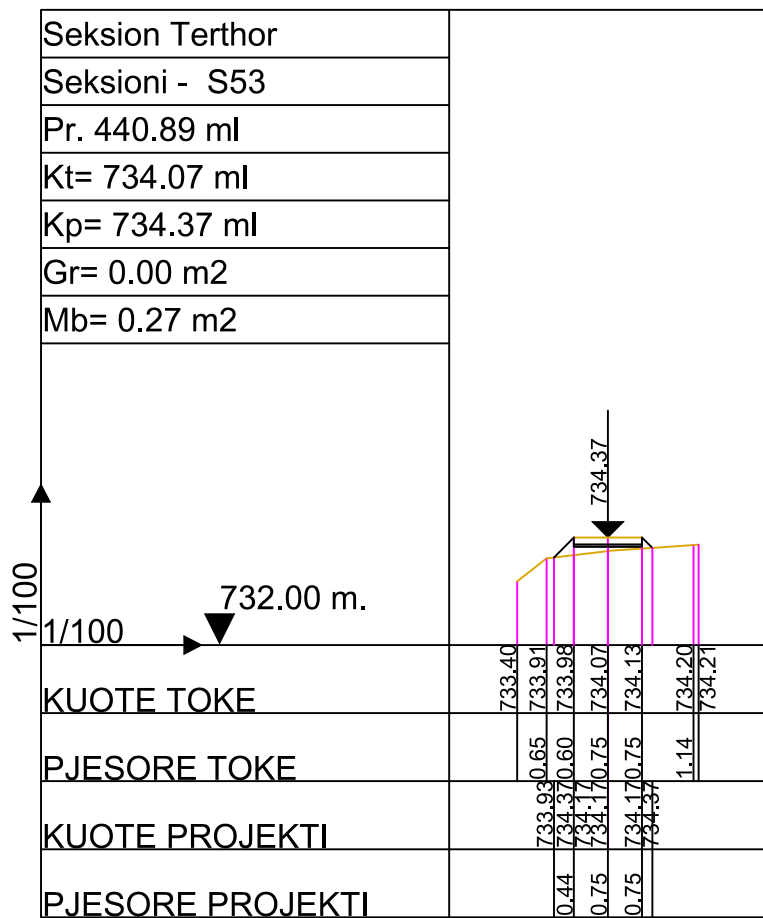
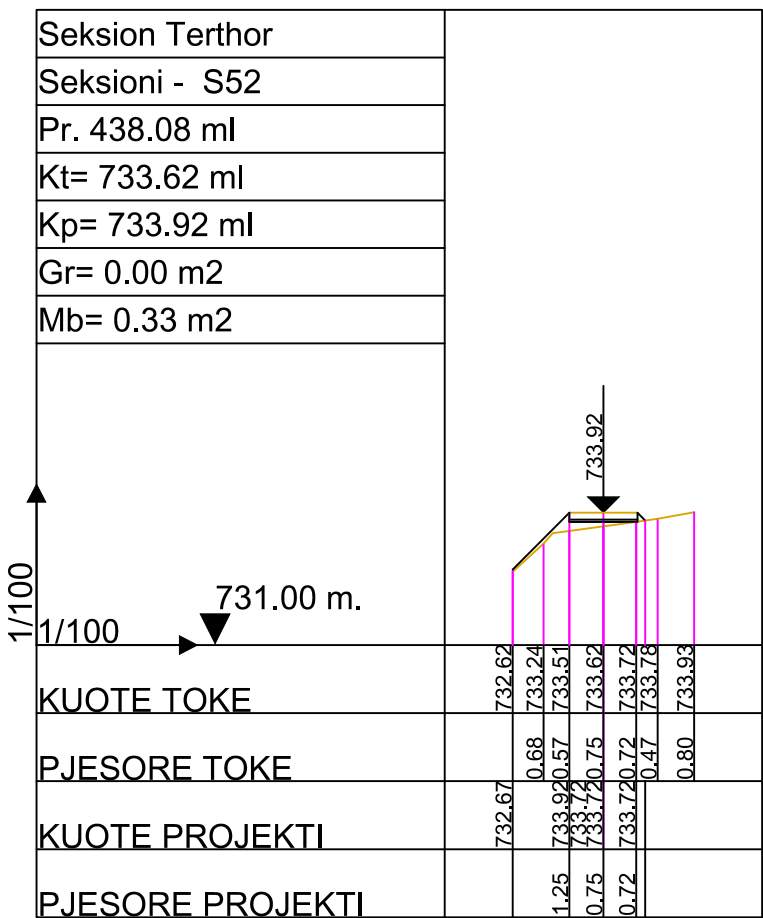
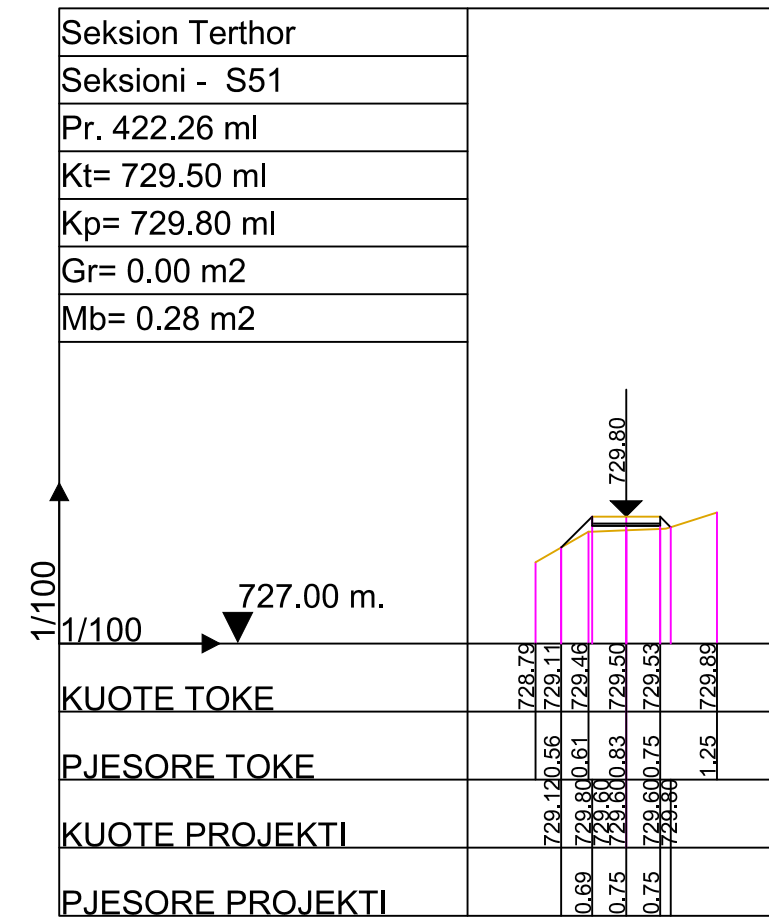
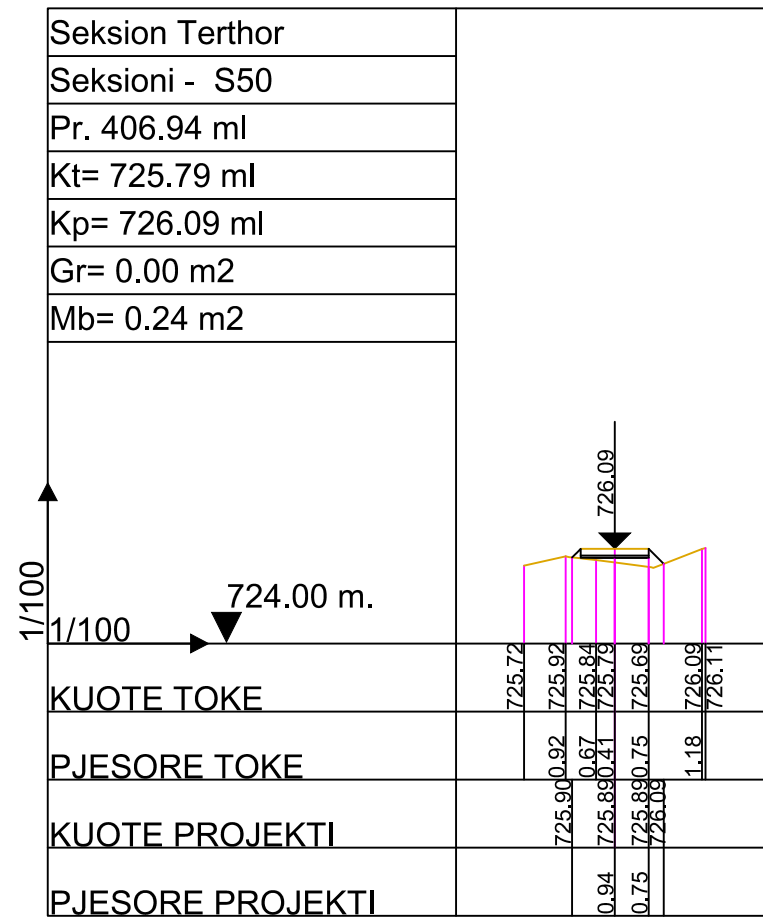
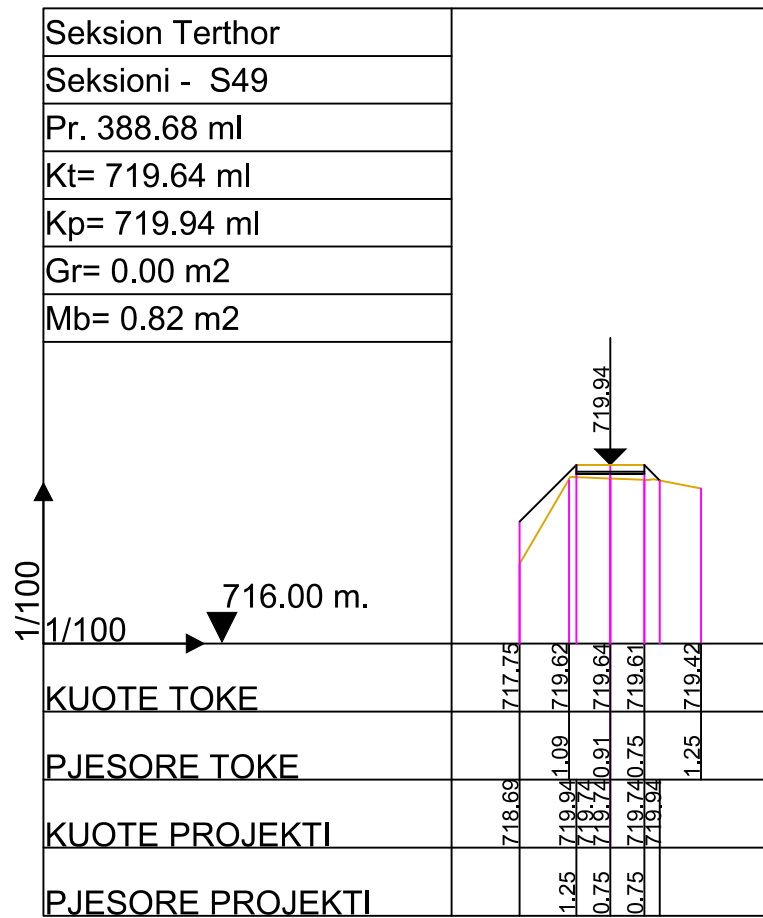

Autoriteit Kontraktor : BASHKIA KRUJE

Objekti: Rikonstruksion Rruga Kembesore "Kruje - Sarisalltik"

Emertimi: SEKSIONET TERTHORE



"ERALD-G" Sh.p.k  
Adresa: Rruga "Koli Bano", Tirane

Drejtes i projektit

Inxh. Gezim ISLAMI

Projektues

Inxh. Aldo MERKAJ  
Ark. Elton Çarçani  
Hidr. Ersida VERÇANI

Elek. Hajdar KURTI  
Mek. Arben MUHA

SHKALLA

SHK 1:100

Tiranë 2017

FLETA

3 -09

Format A3

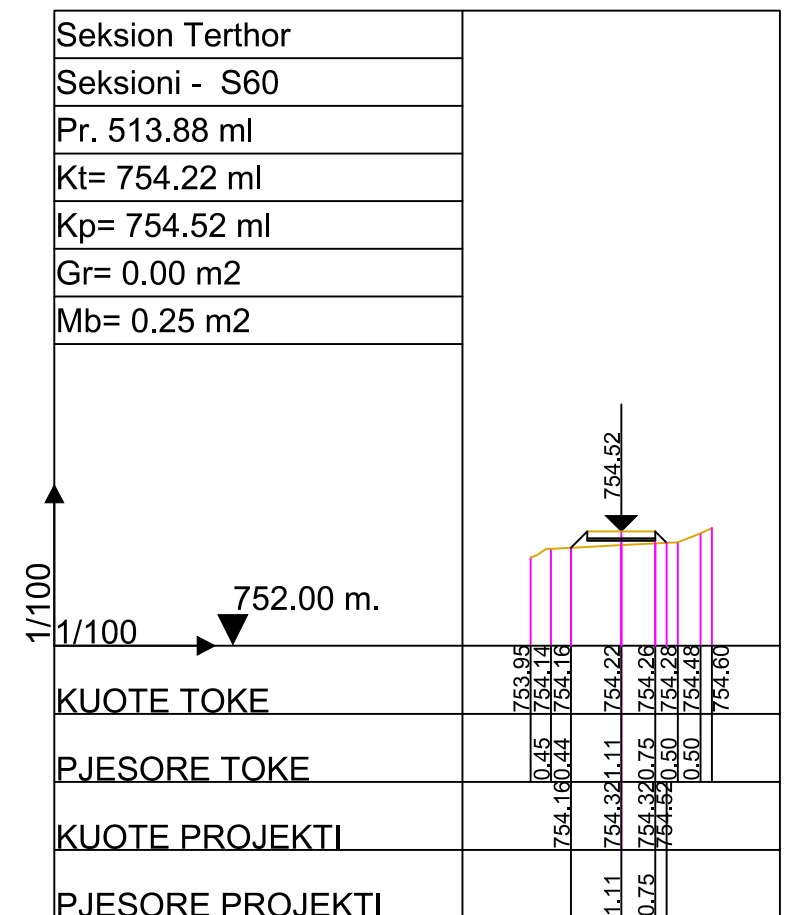
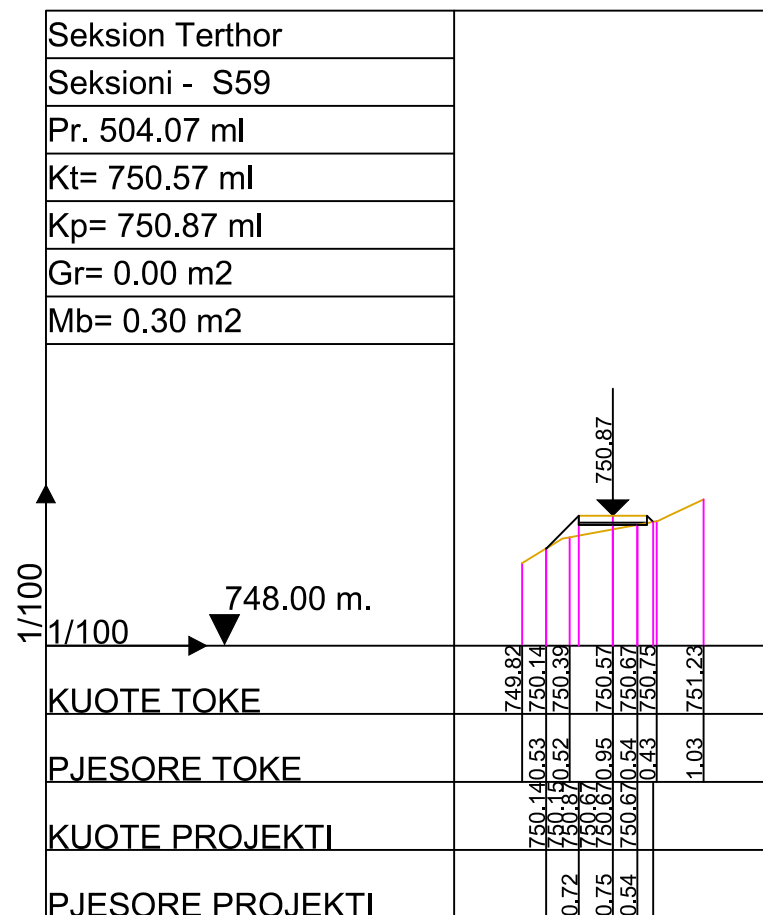
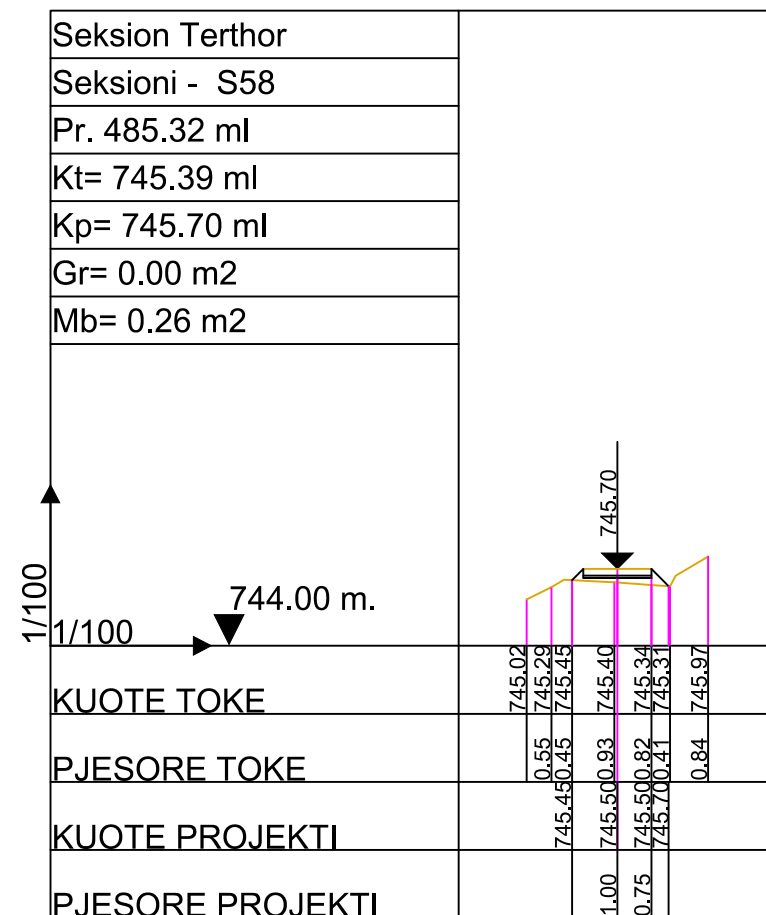
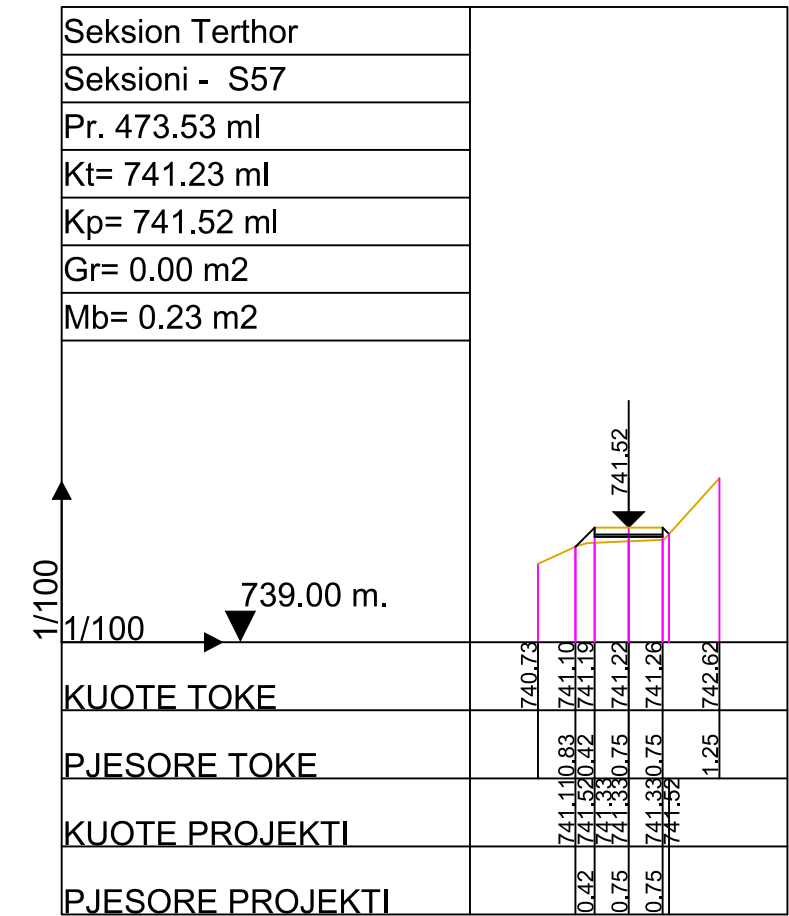
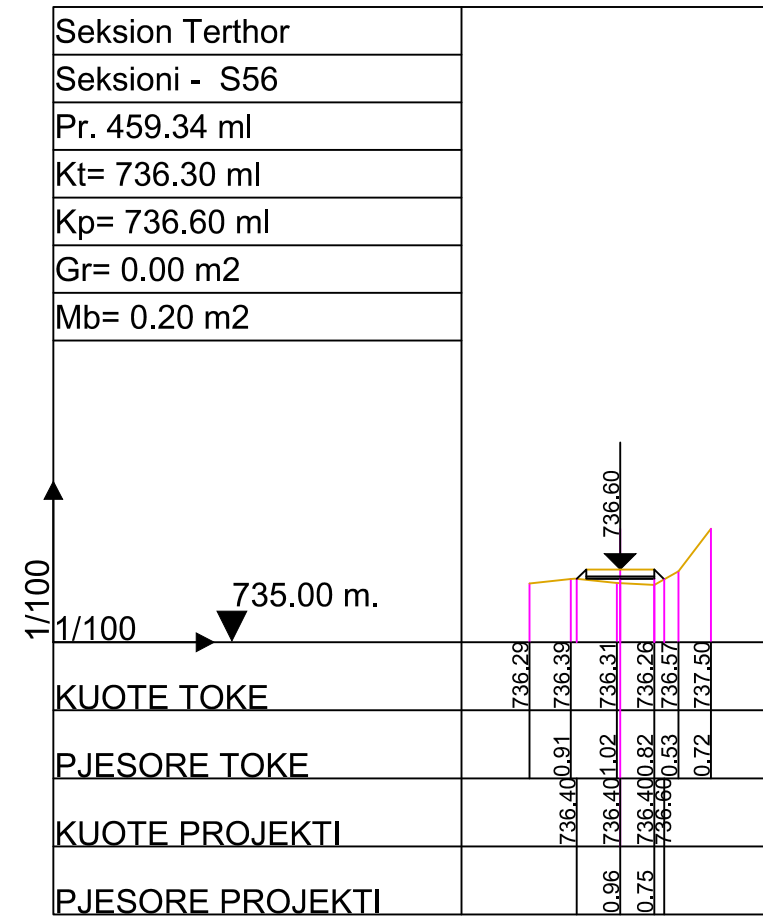
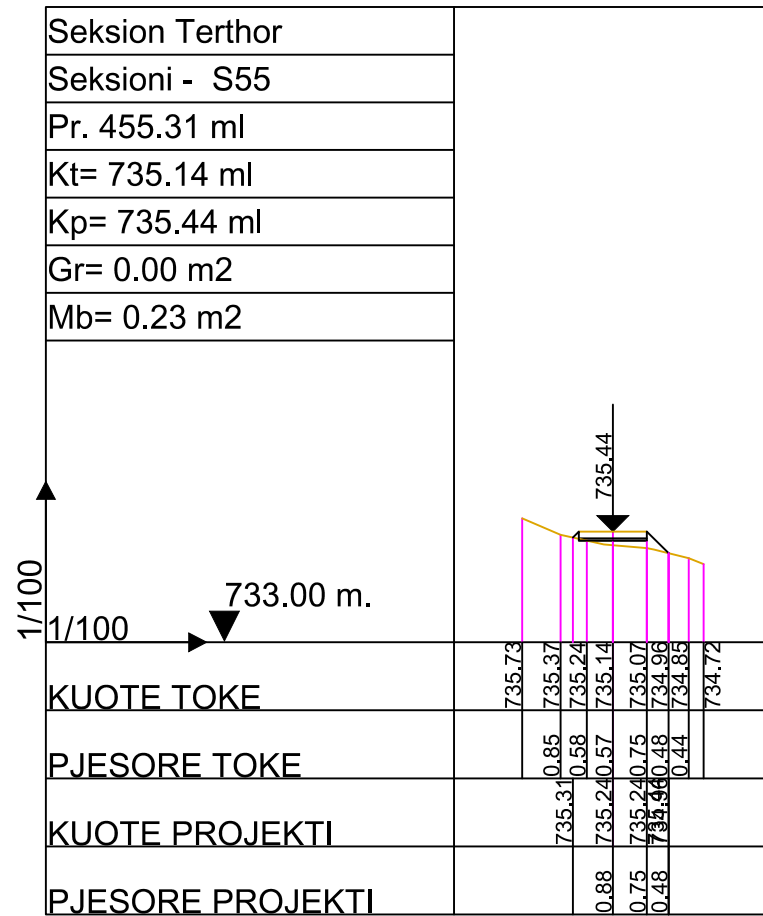

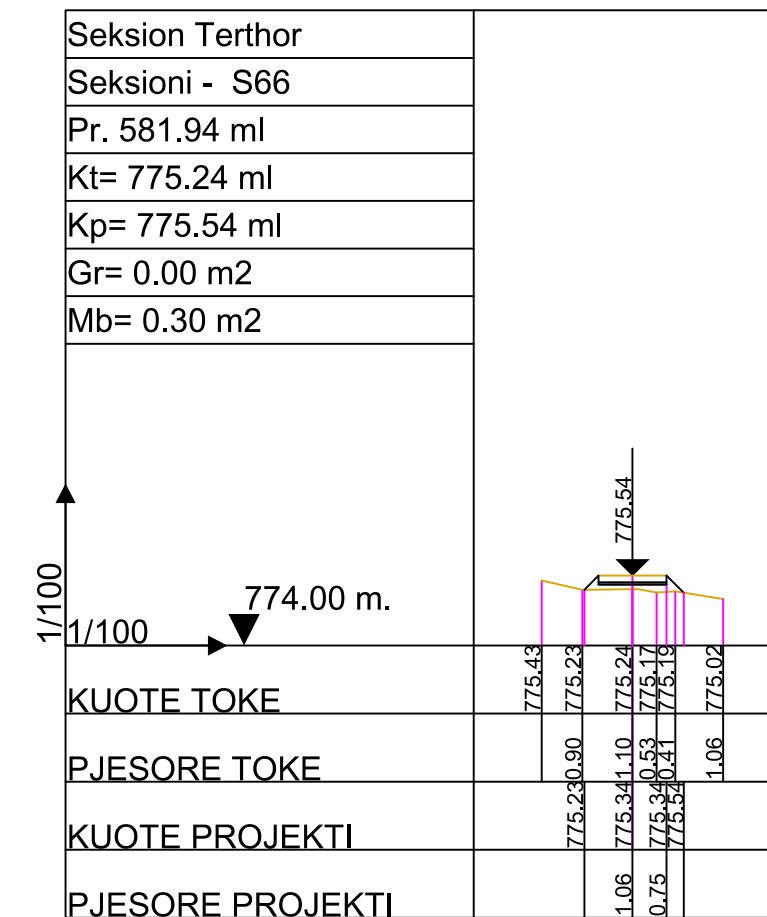
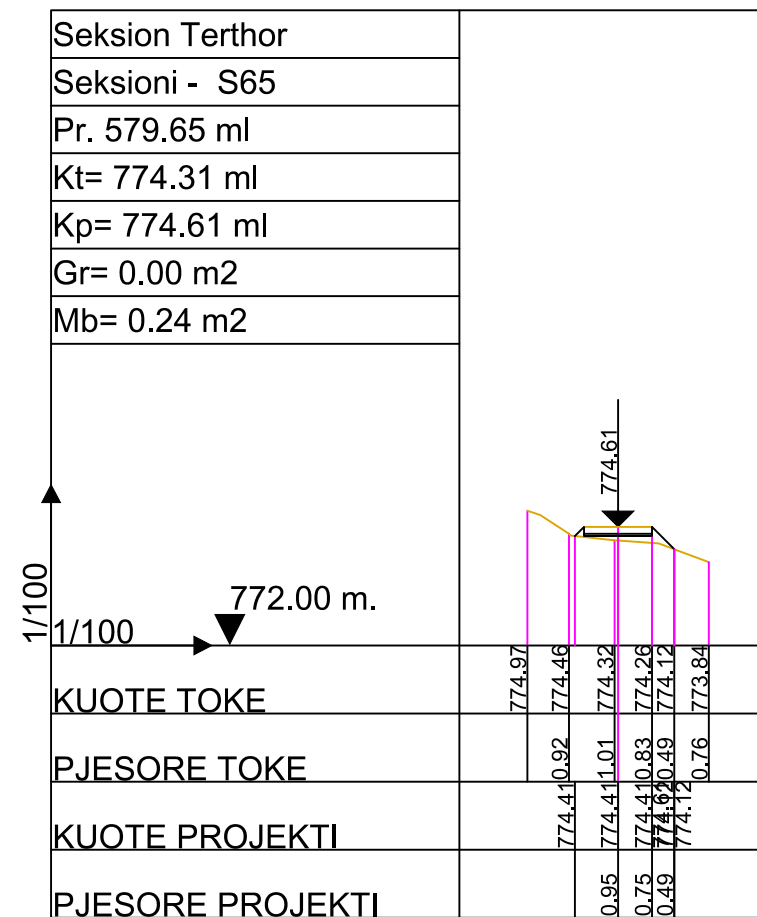
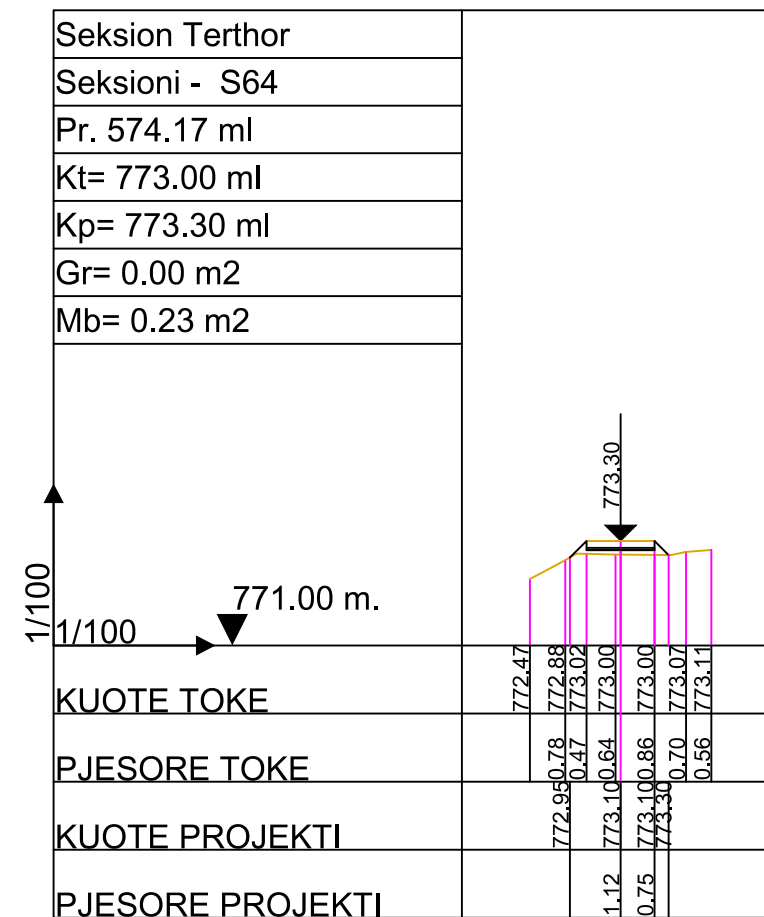
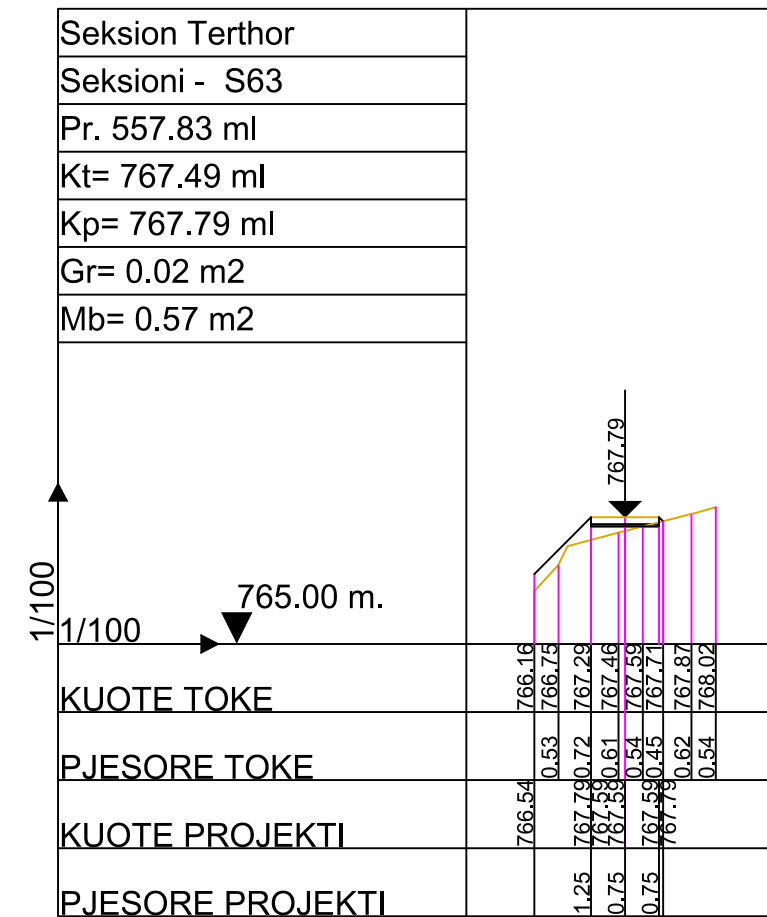
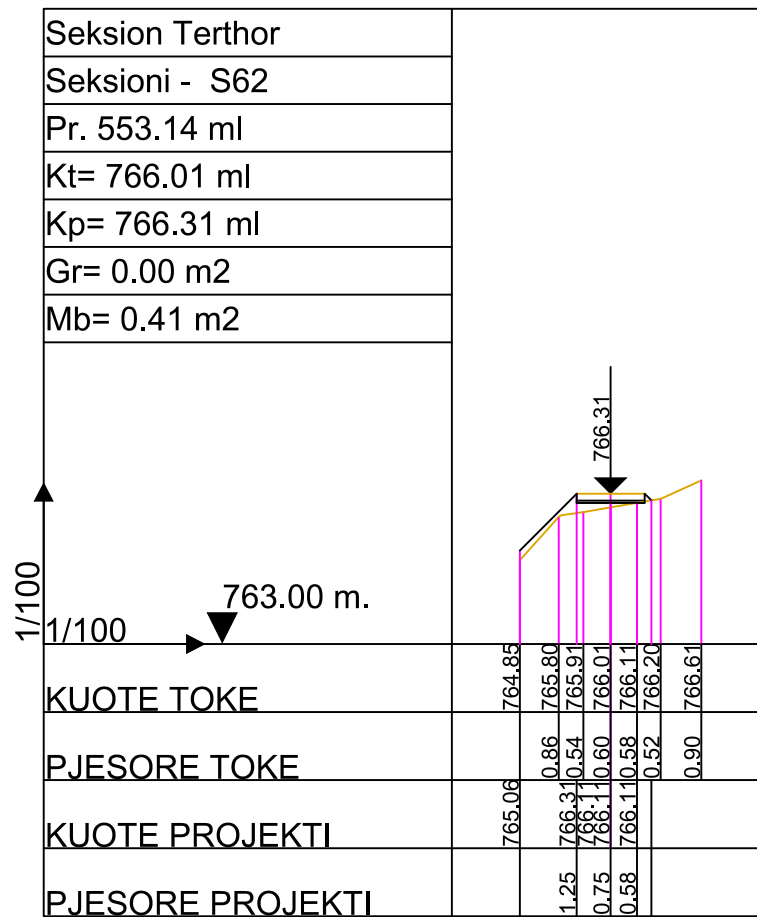
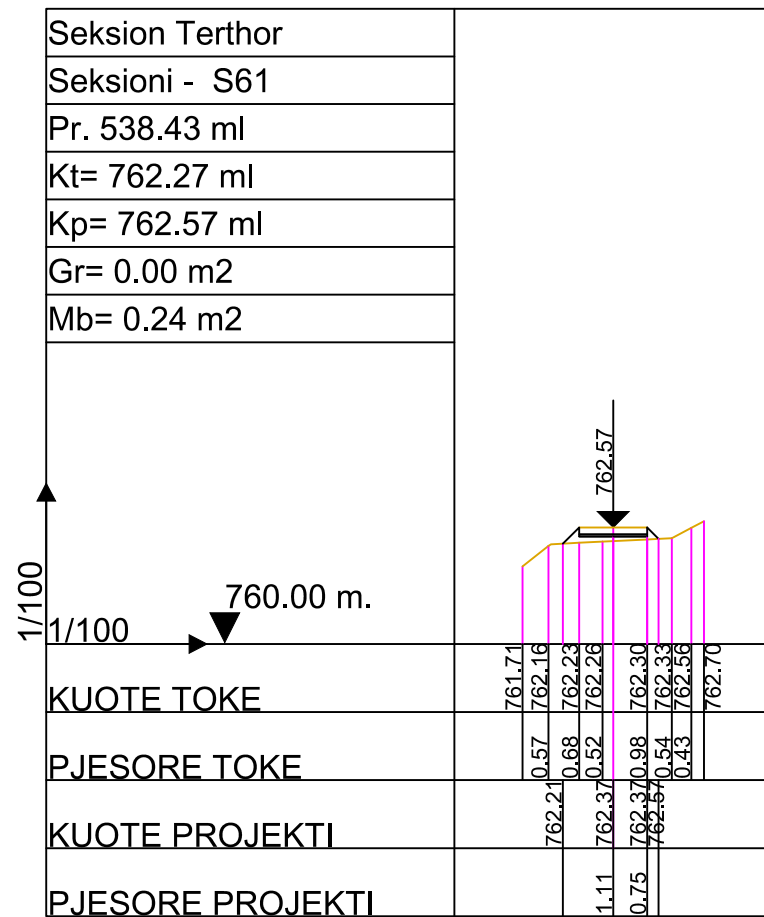

Autoriteit Kontraktor : BASHKIA KRUJE

Objekti: Rikonstruksion Rruga Kembesore "Kruje - Sarisalltik"

Emertimi: SEKSIONET TERTHORE



"ERALD-G" Sh.p.k  
Adresa: Rruga "Koli Bano", Tirane

Drejtes i projektit

Inxh. Gezim ISLAMI

Projektues

Inxh. Aldo MERKAJ  
Ark. Elton Çarçani  
Hidr. Ersida VERÇANI

Elek. Hajdar KURTI  
Mek. Arben MUHA

SHKALLA

SHK 1:100

Tiranë 2017

FLETA

3 -11

Format A3

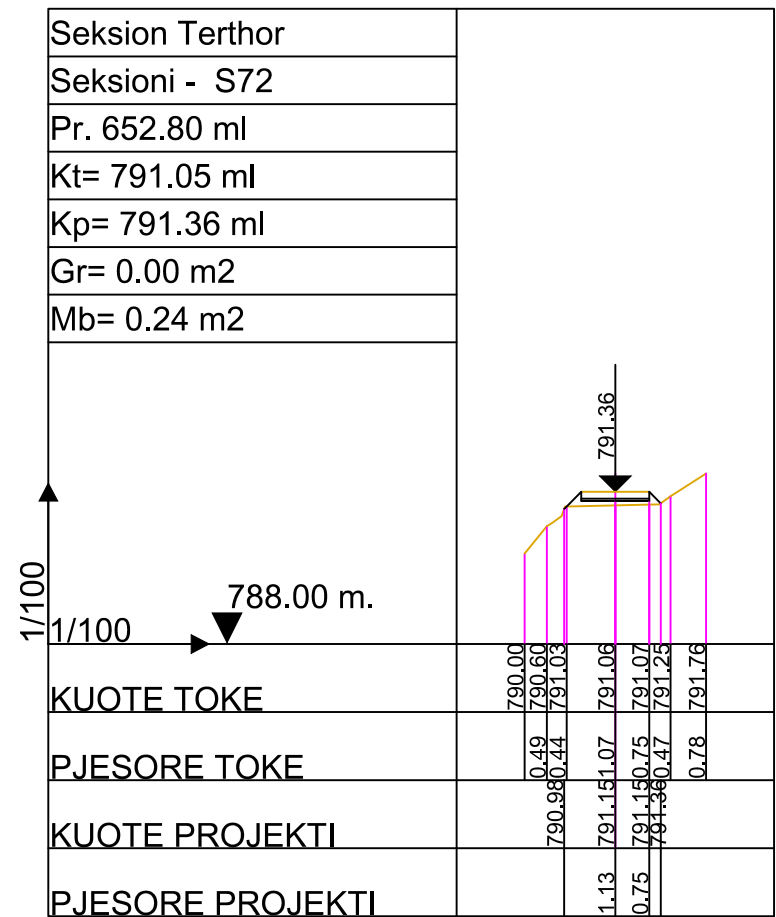
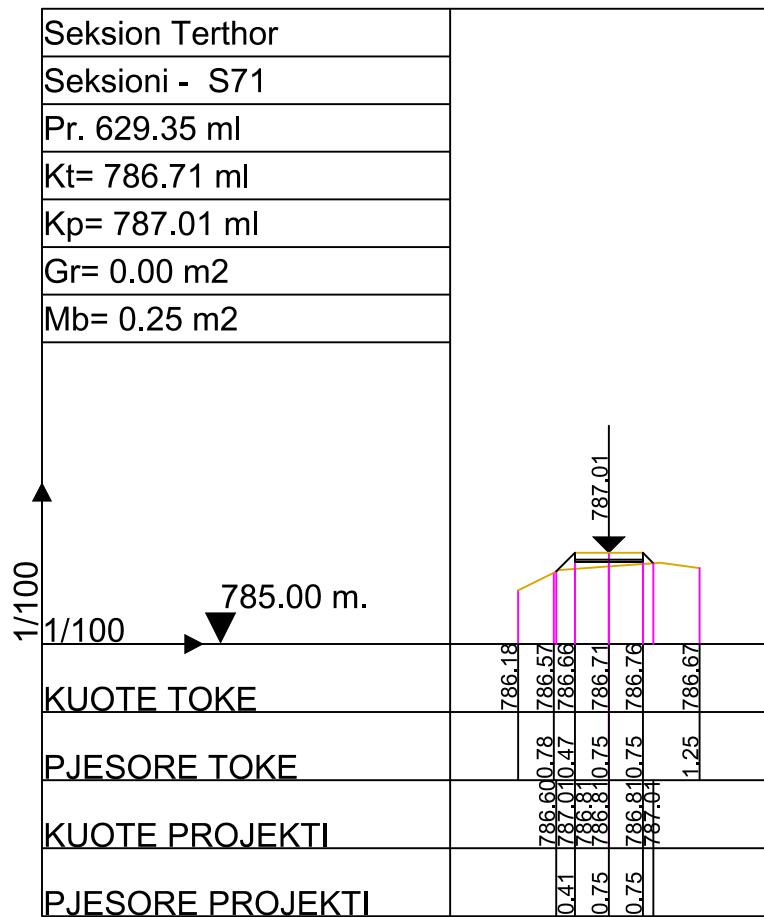
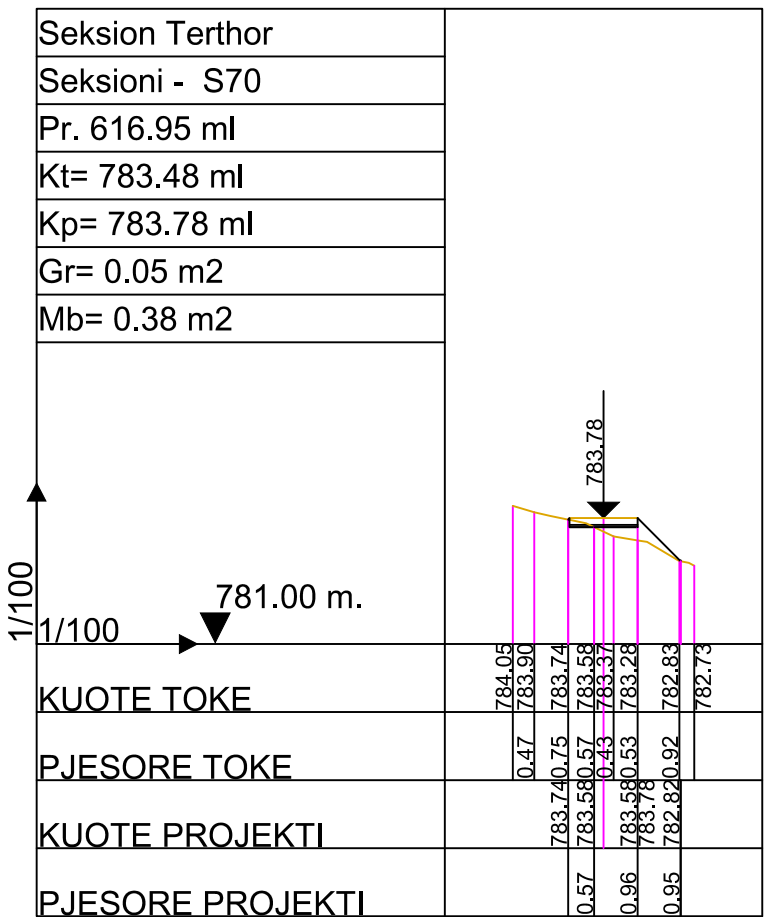
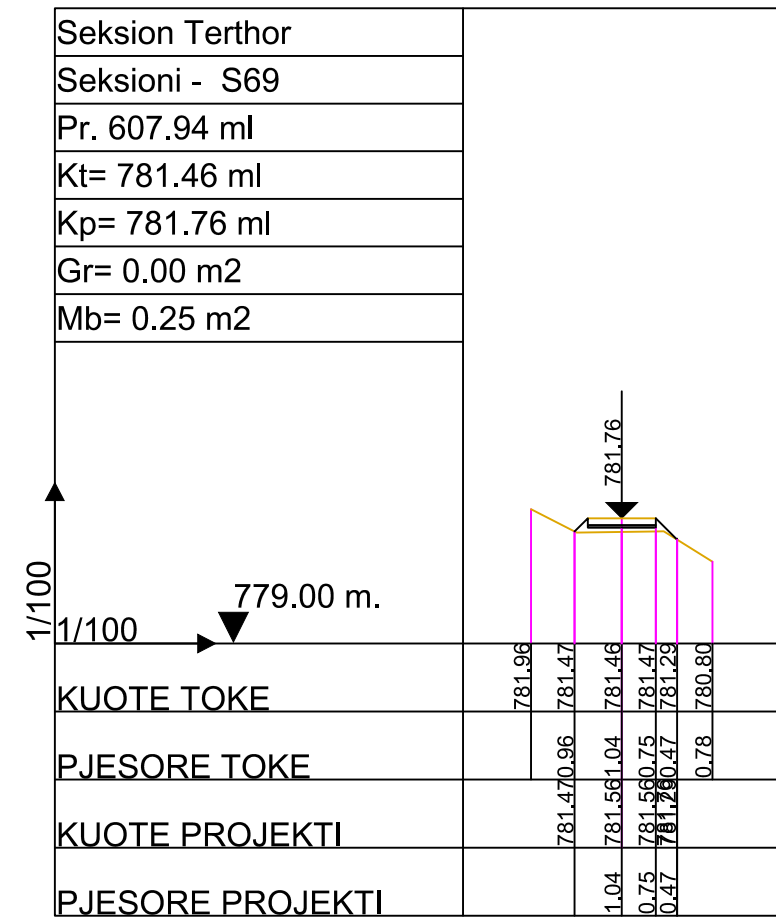
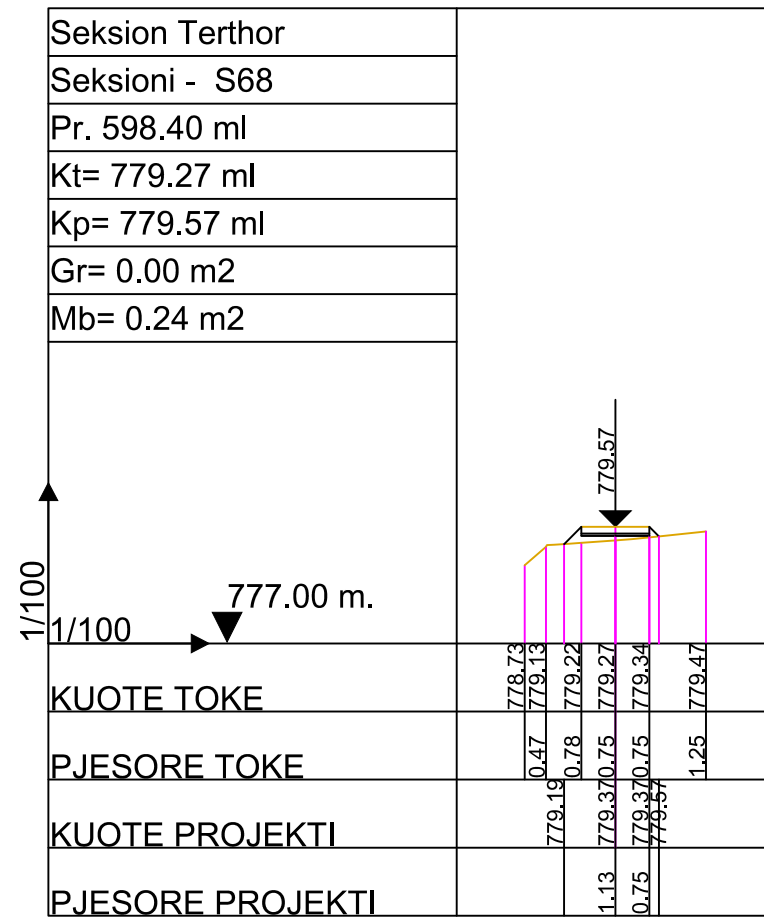
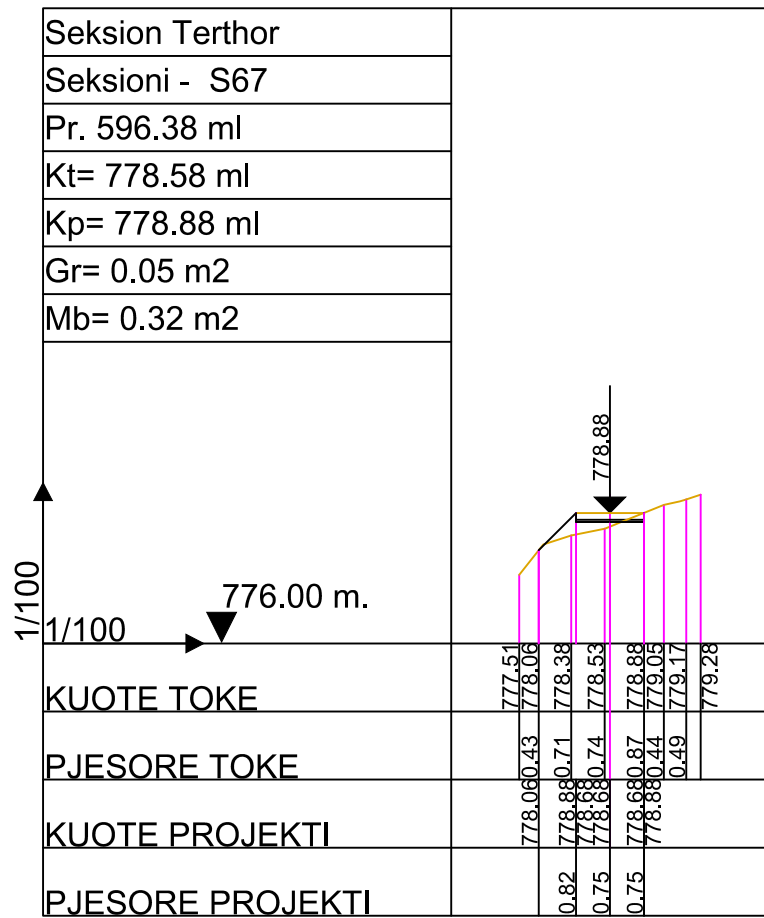

Autoriteit Kontraktor : BASHKIA KRUJE

Objekti: Rikonstruksion Rruga Kembesore "Kruje - Sarisalltik"

Emertimi: SEKSIONET TERTHORE



"ERALD-G" Sh.p.k  
Adresa: Rruga "Koli Bano", Tirane

Drejtes i projektit

Inxh. Gezim ISLAMI

Projektues

Inxh. Aldo MERKAJ  
Ark. Elton Çarçani  
Hidr. Ersida VERÇANI

Elek. Hajdar KURTI  
Mek. Arben MUHA

SHKALLA

SHK 1:100

Tiranë 2017

FLETA

3 -12

Format A3

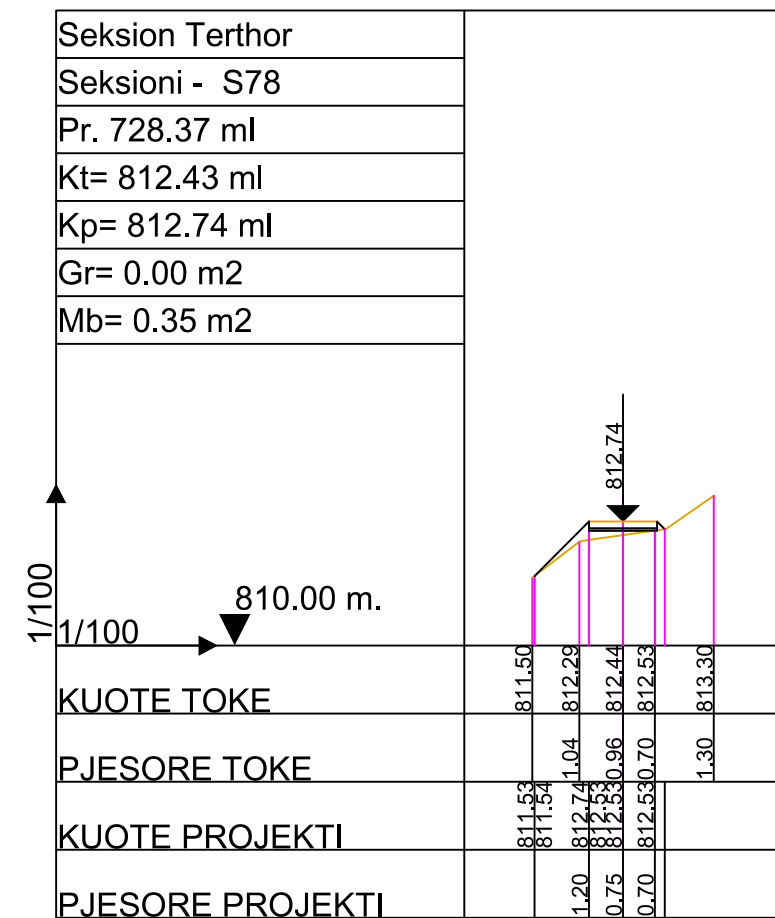
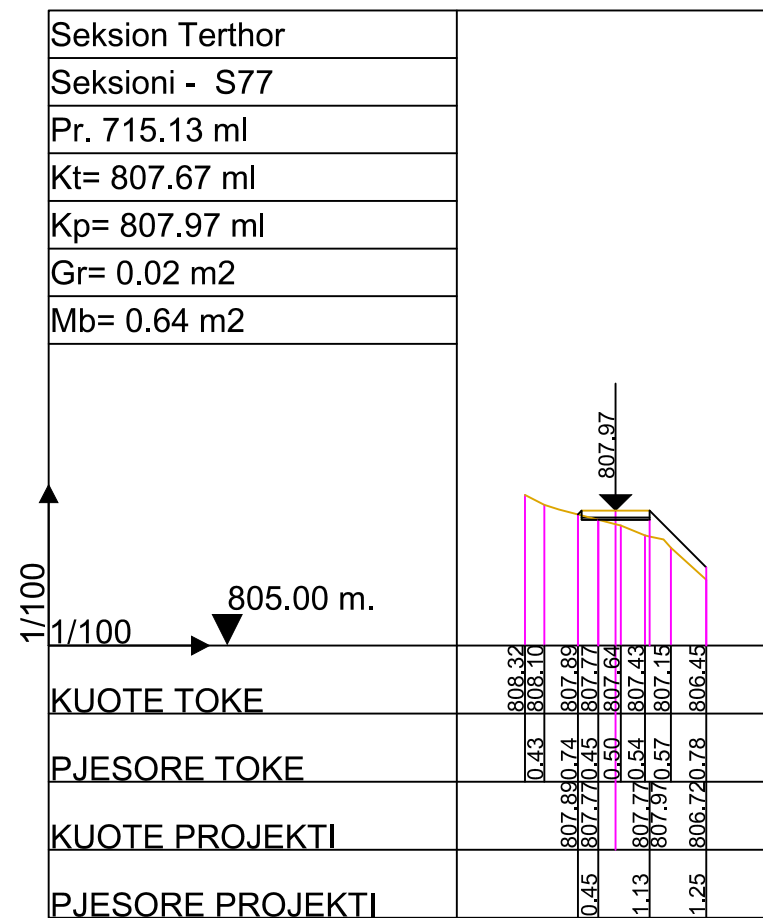
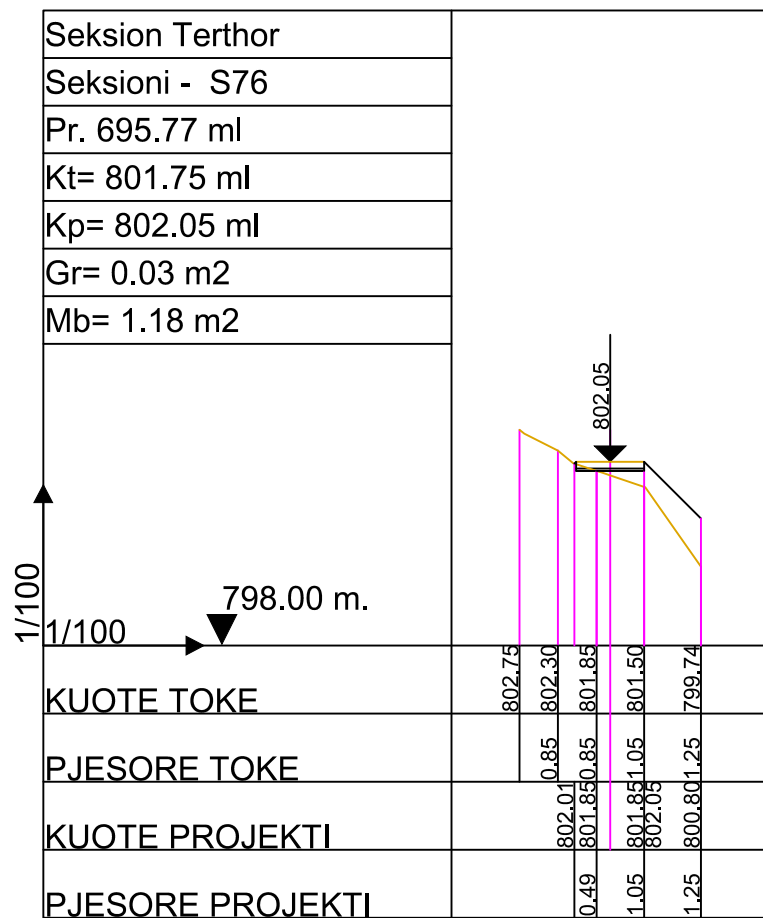
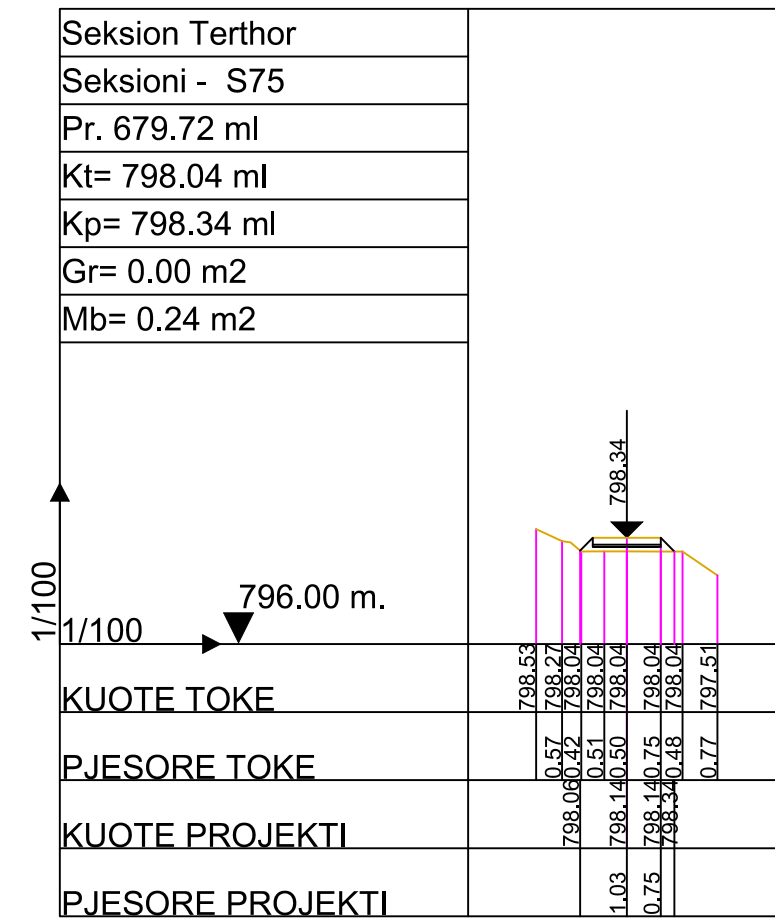
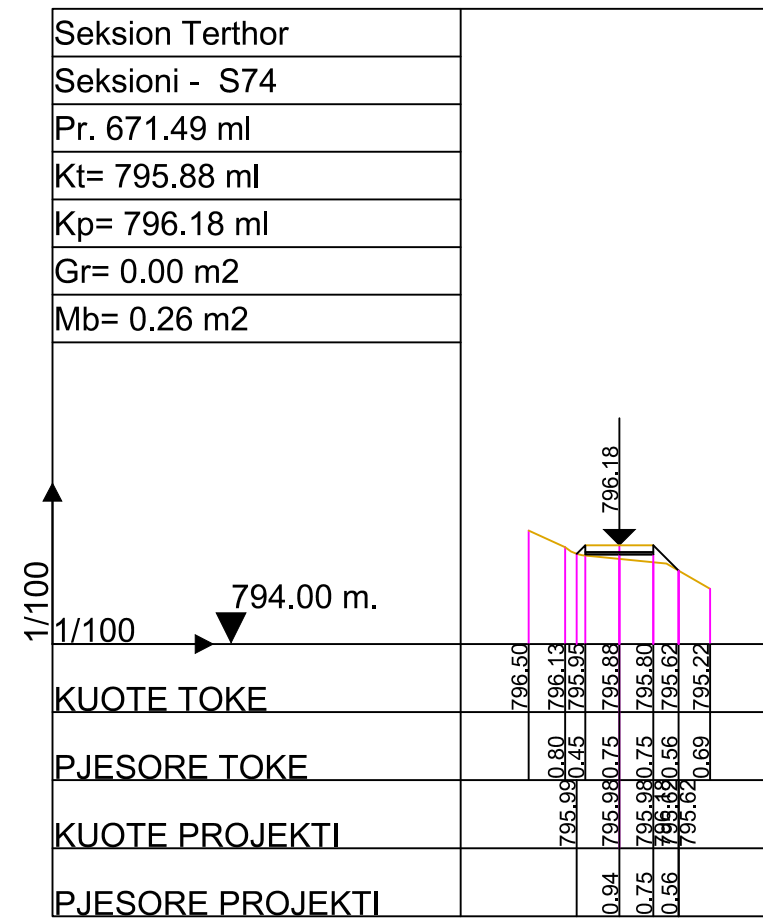
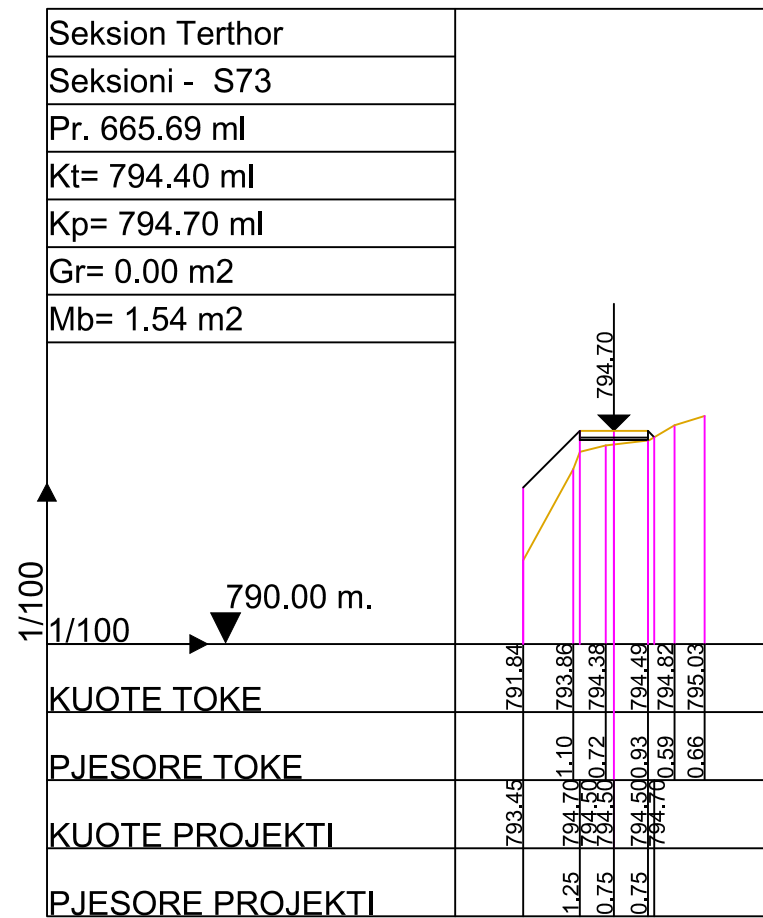

Autoriteit Kontraktor : BASHKIA KRUJE

Objekti: Rikonstruksion Rruga Kembesore "Kruje - Sarisalltik"

Emertimi: SEKSIONET TERTHORE



"ERALD-G" Sh.p.k  
Adresa: Rruga "Koli Bano", Tirane

Drejtes i projektit

Inxh. Gezim ISLAMI

Projektues

Inxh. Aldo MERKAJ  
Ark. Elton Çarçani  
Hidr. Ersida VERÇANI

Elek. Hajdar KURTI  
Mek. Arben MUHA

SHKALLA

SHK 1:100

Tiranë 2017

FLETA

3 -13

Format A3

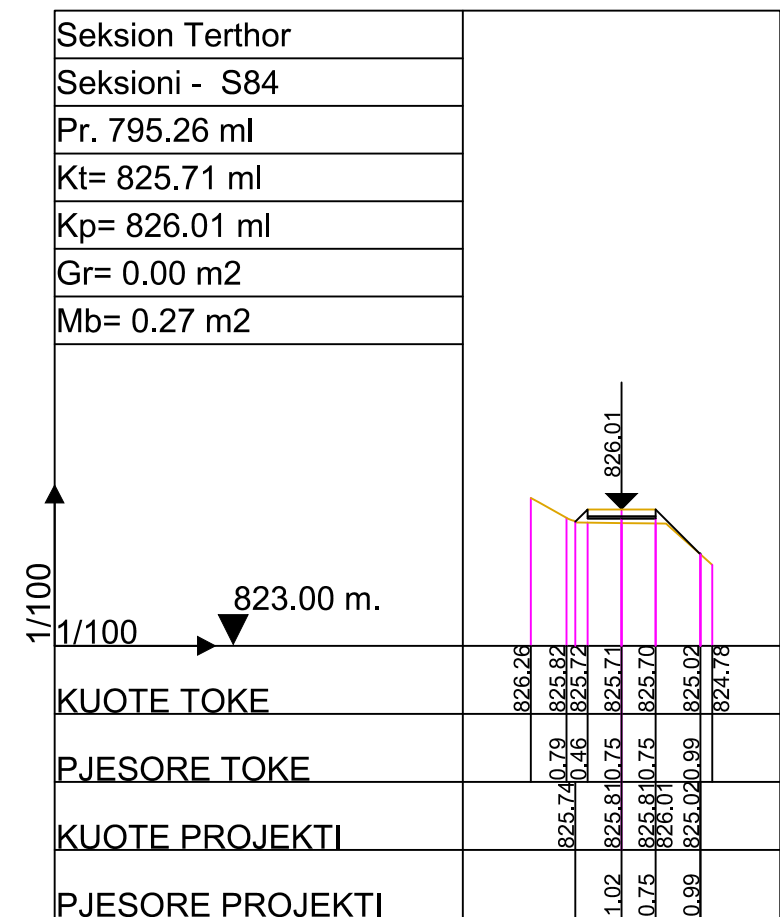
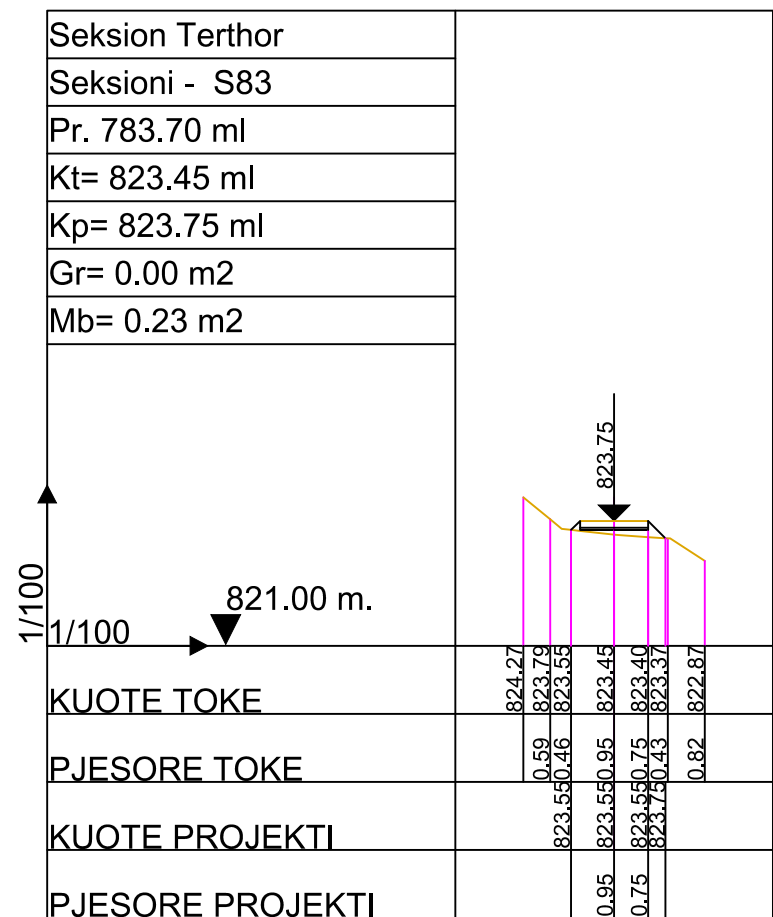
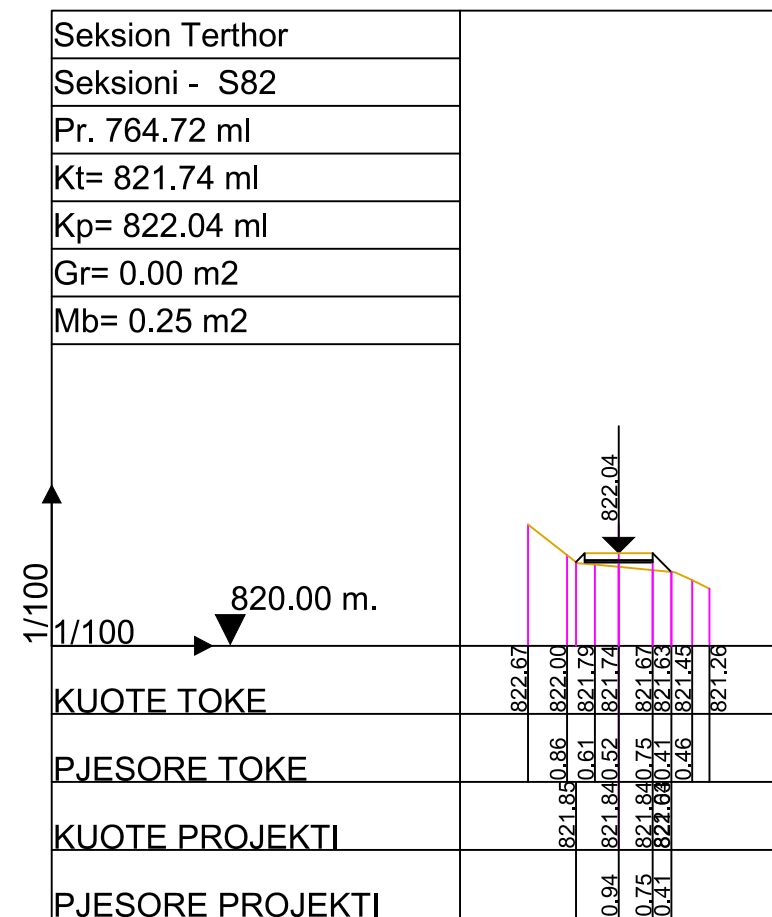
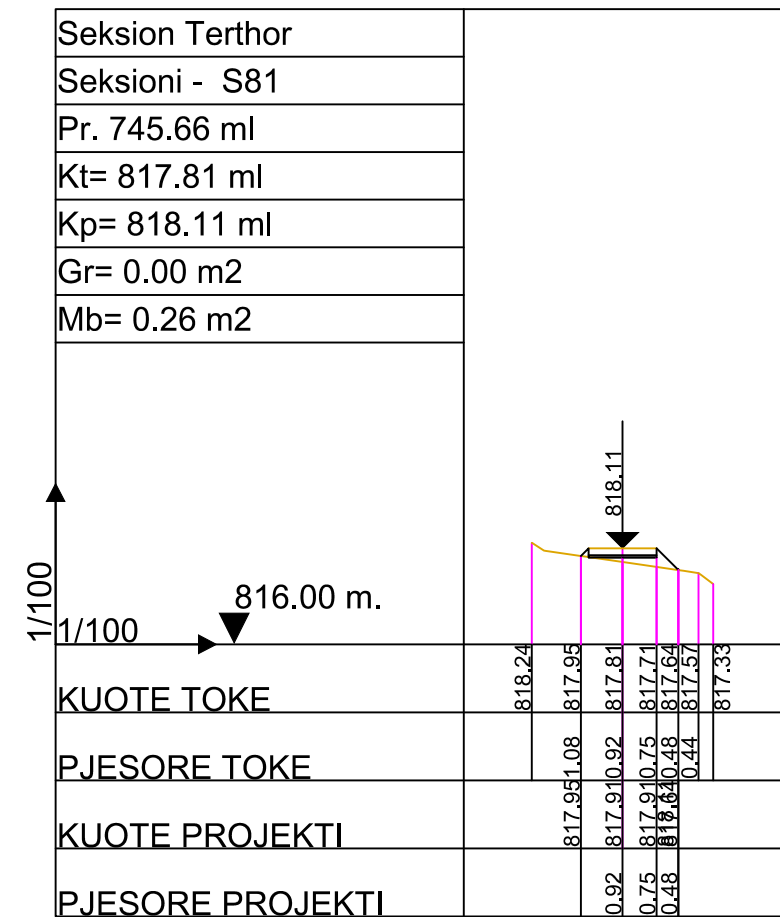
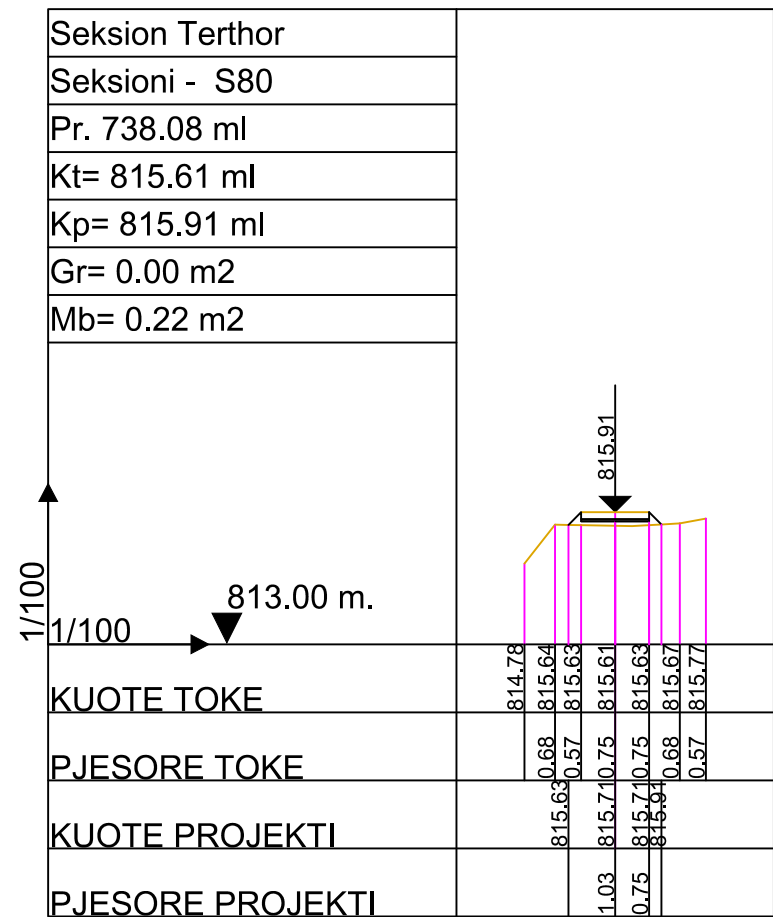
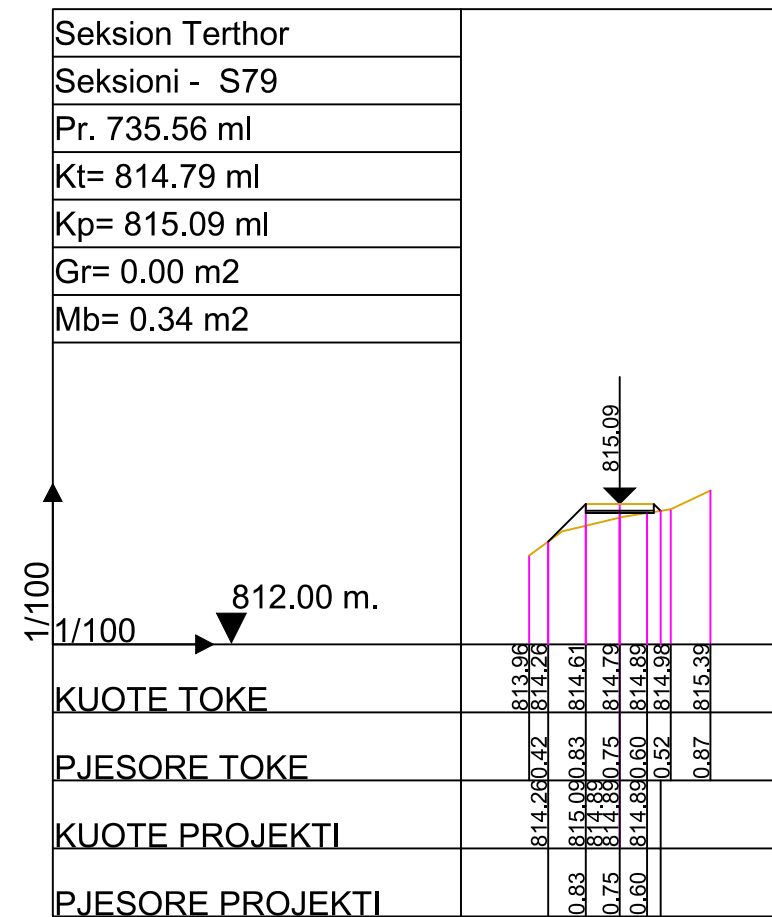

Autoriteit Kontraktor : BASHKIA KRUJE

Objekti: Rikonstruksion Rruga Kembesore "Kruje - Sarisalltik"

Emertimi: SEKSIONET TERTHORE



"ERALD-G" Sh.p.k  
Adresa: Rruga "Koli Bano", Tirane

Drejtes i projektit

Inxh. Gezim ISLAMI

Projektues

Inxh. Aldo MERKAJ  
Ark. Elton Çarçani  
Hidr. Ersida VERÇANI

Elek. Hajdar KURTI  
Mek. Arben MUHA

SHKALLA

SHK 1:100

Tiranë 2017

FLETA

3 -14

Format A3

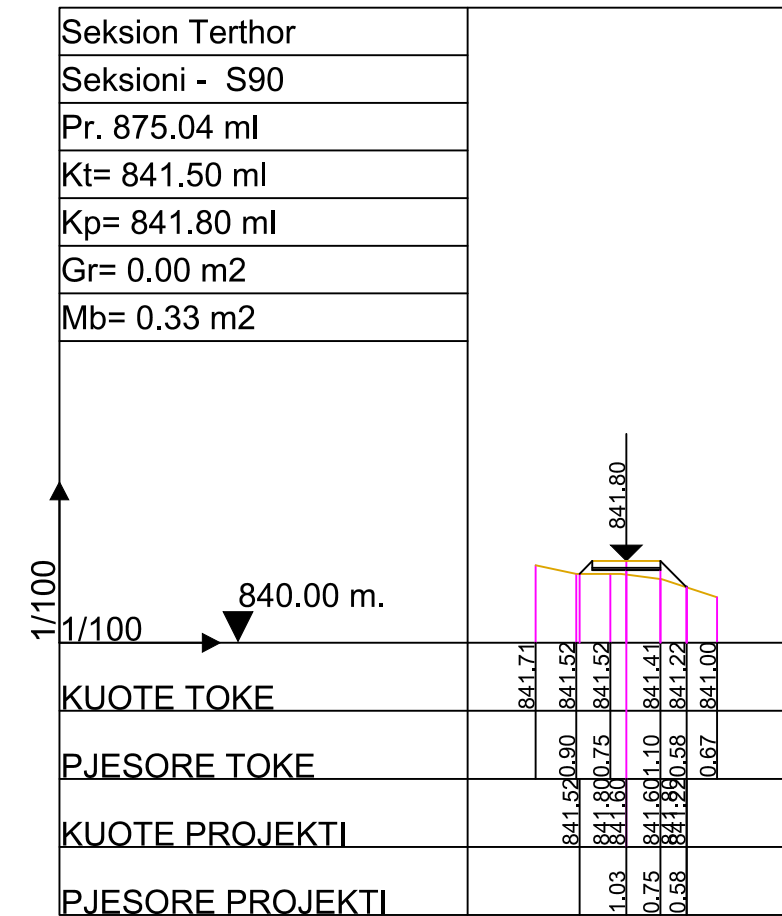
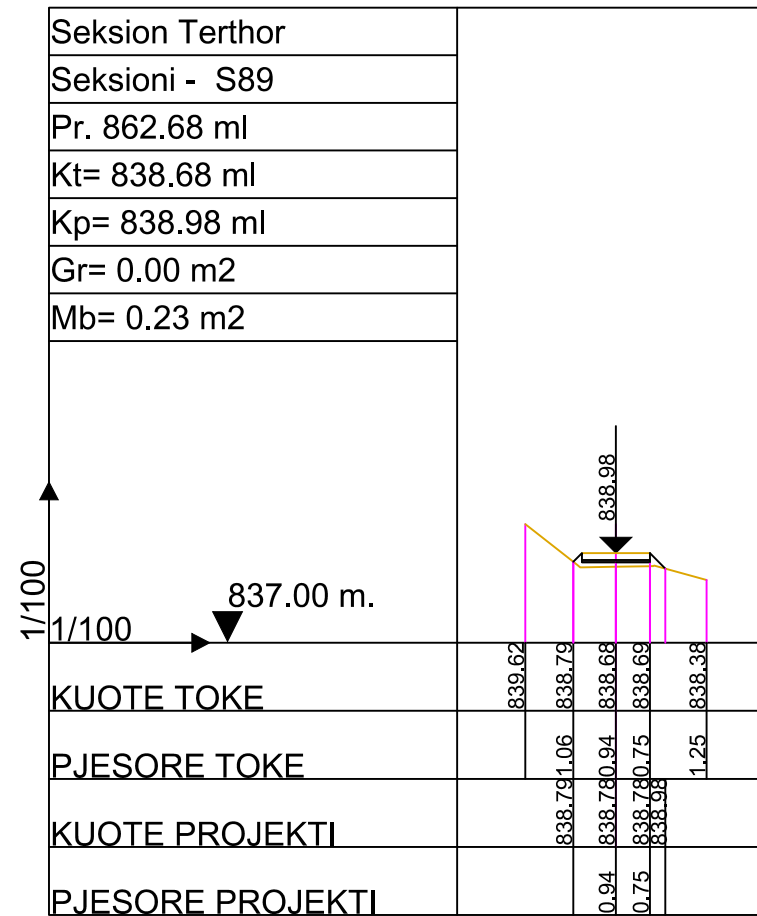
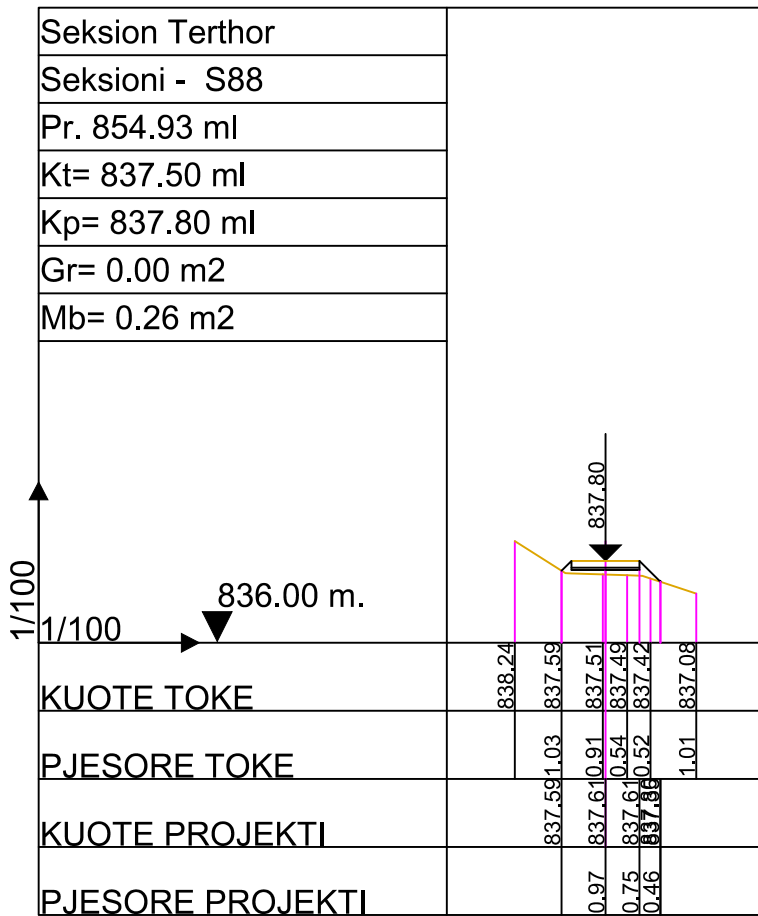
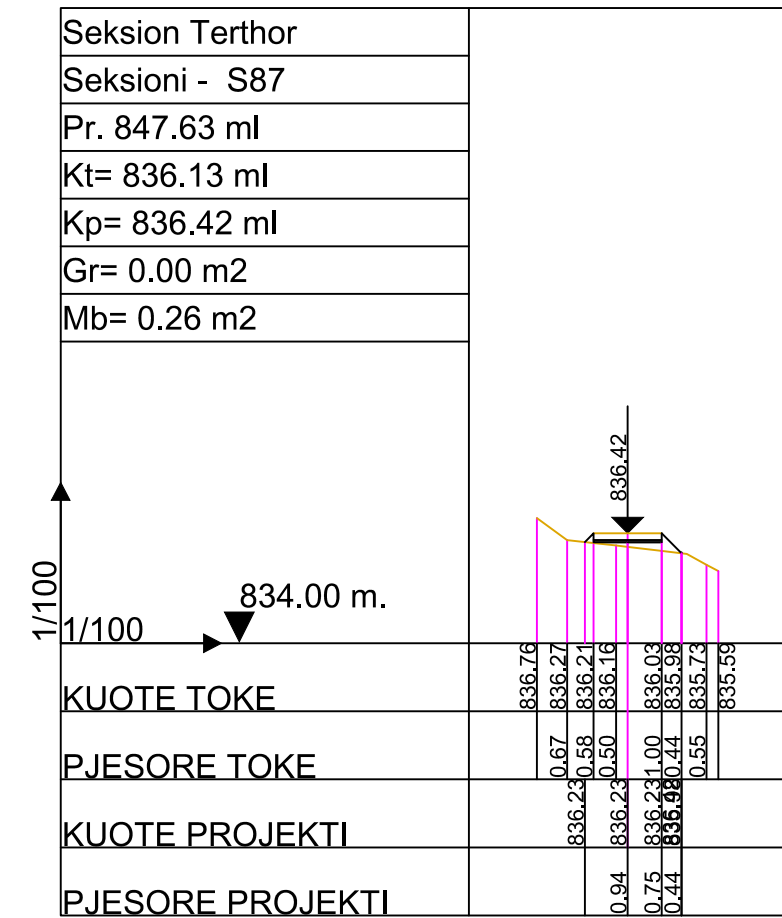
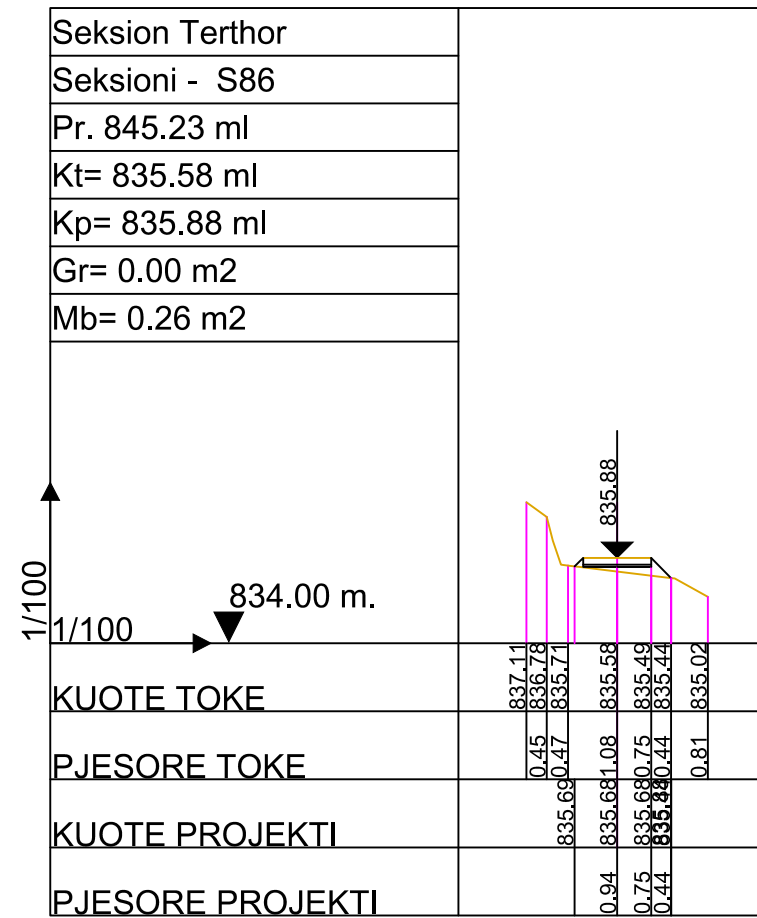
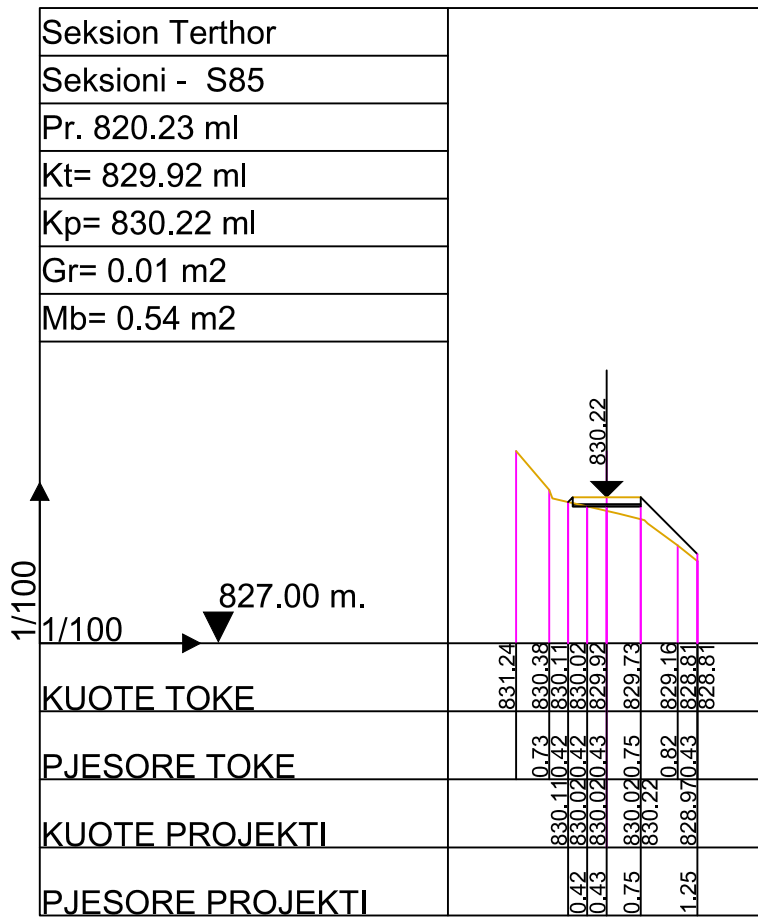



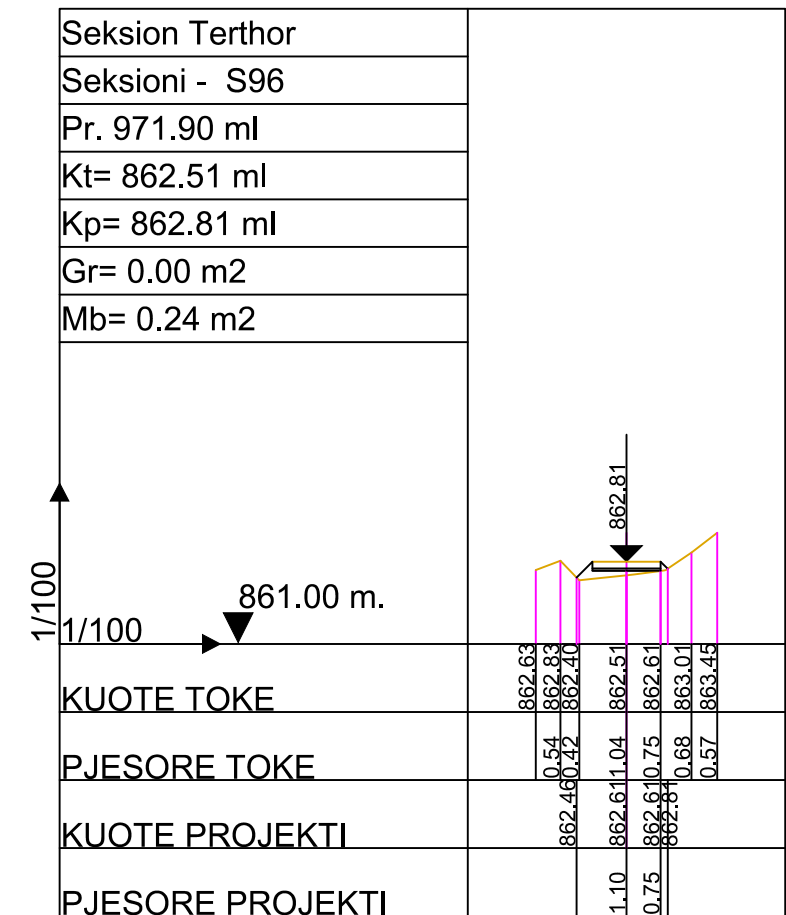
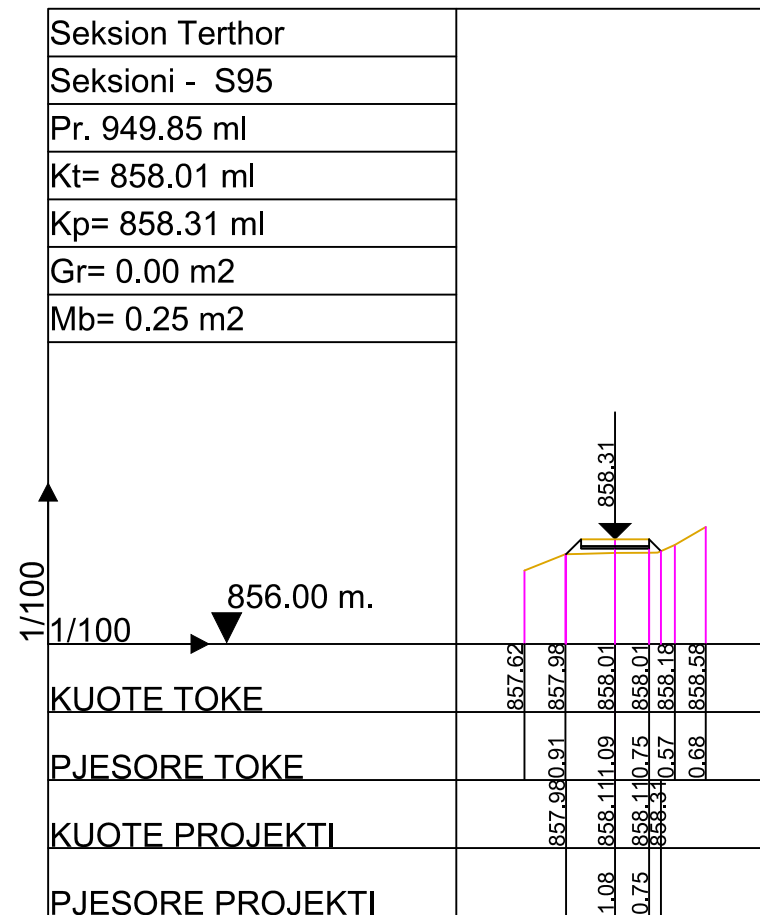
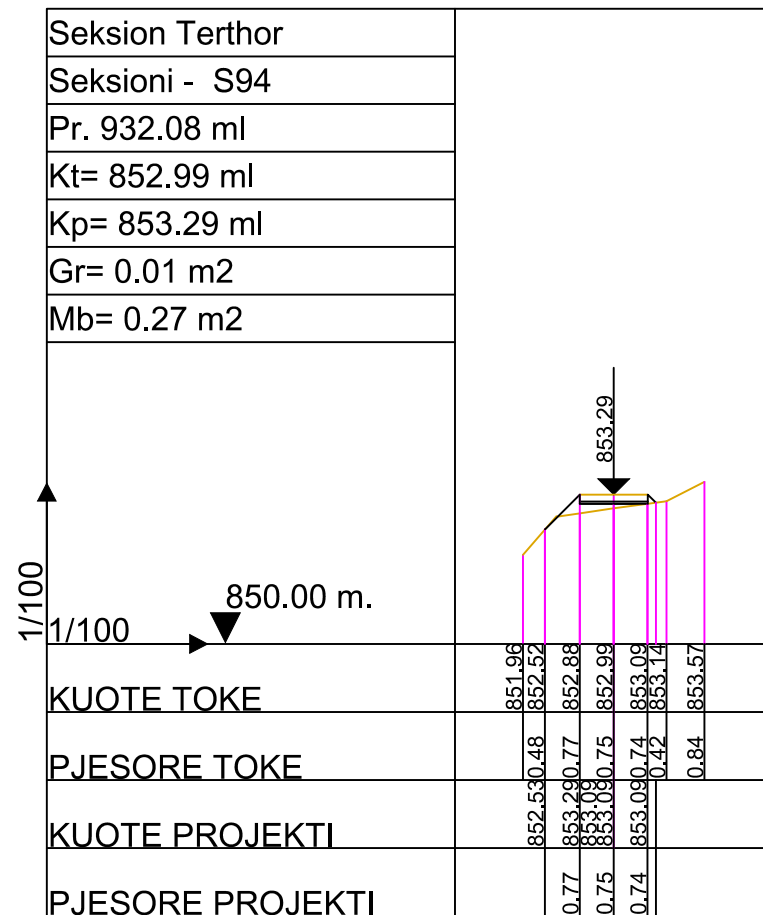
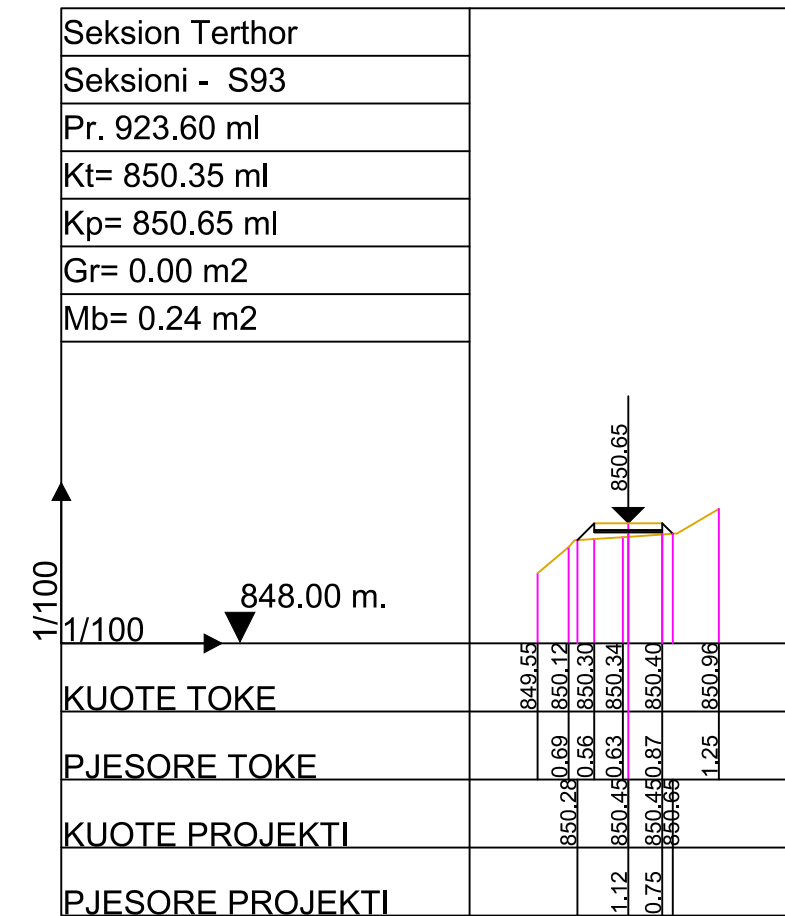
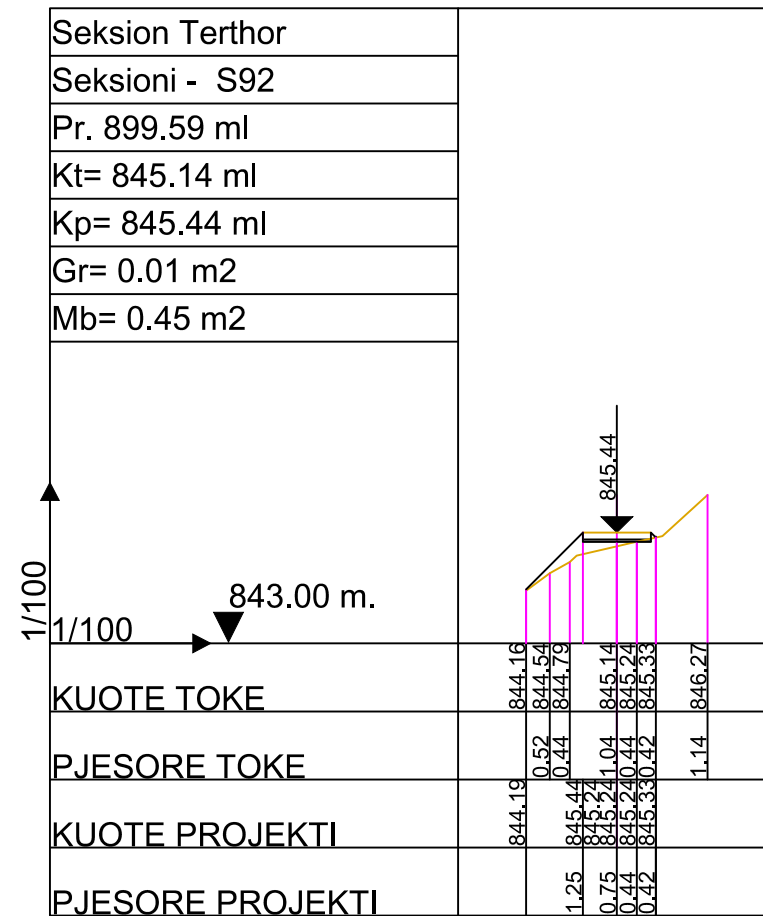
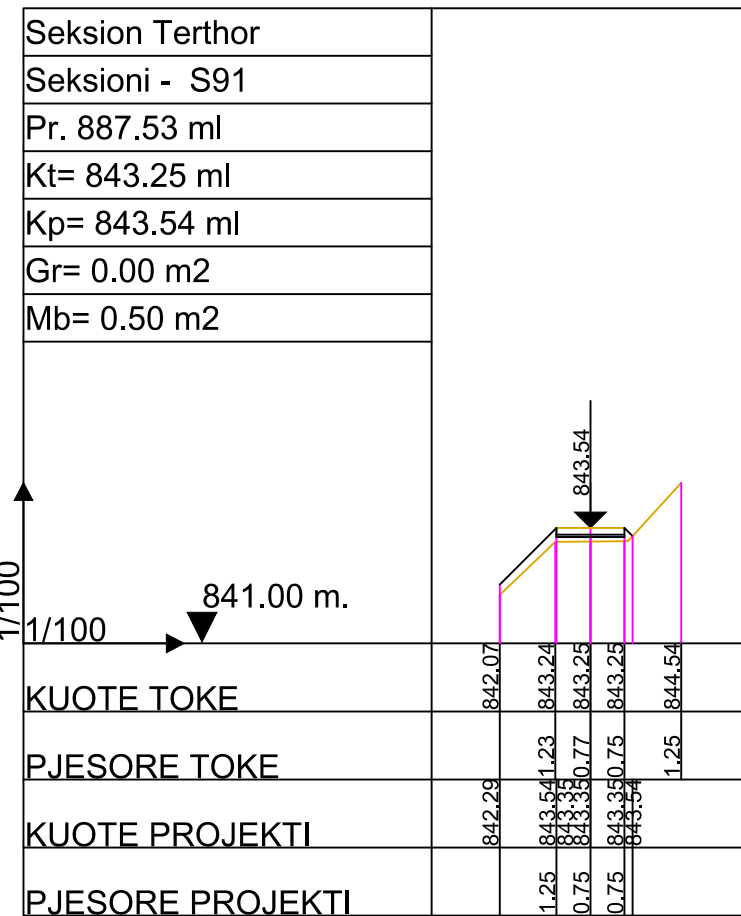

Autoriteit Kontraktor : BASHKIA KRUJE

Objekti: Rikonstruksion Rruga Kembesore "Kruje - Sarisalltik"

Emertimi: SEKSIONET TERTHORE



"ERALD-G" Sh.p.k  
Adresa: Rruga "Koli Bano", Tirane

Drejtes i projektit

Inxh. Gezim ISLAMI

Projektues

Inxh. Aldo MERKAJ  
Ark. Elton Çarçani  
Hidr. Ersida VERÇANI

Elek. Hajdar KURTI  
Mek. Arben MUHA

SHKALLA

SHK 1:100

Tiranë 2017

FLETA

3 -16

Format A3

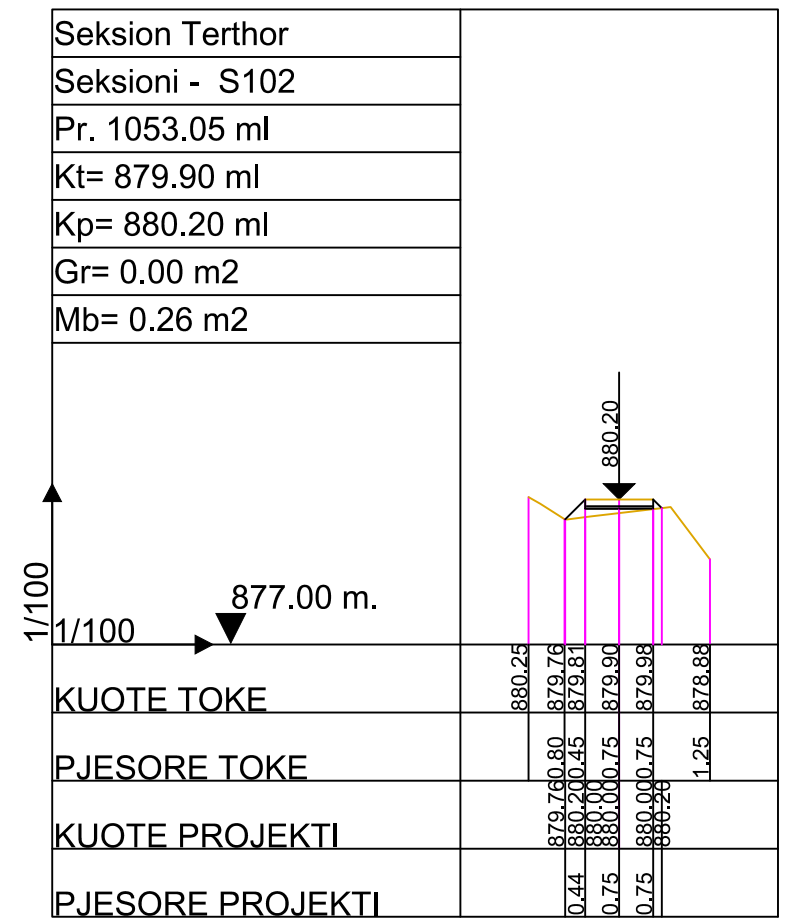
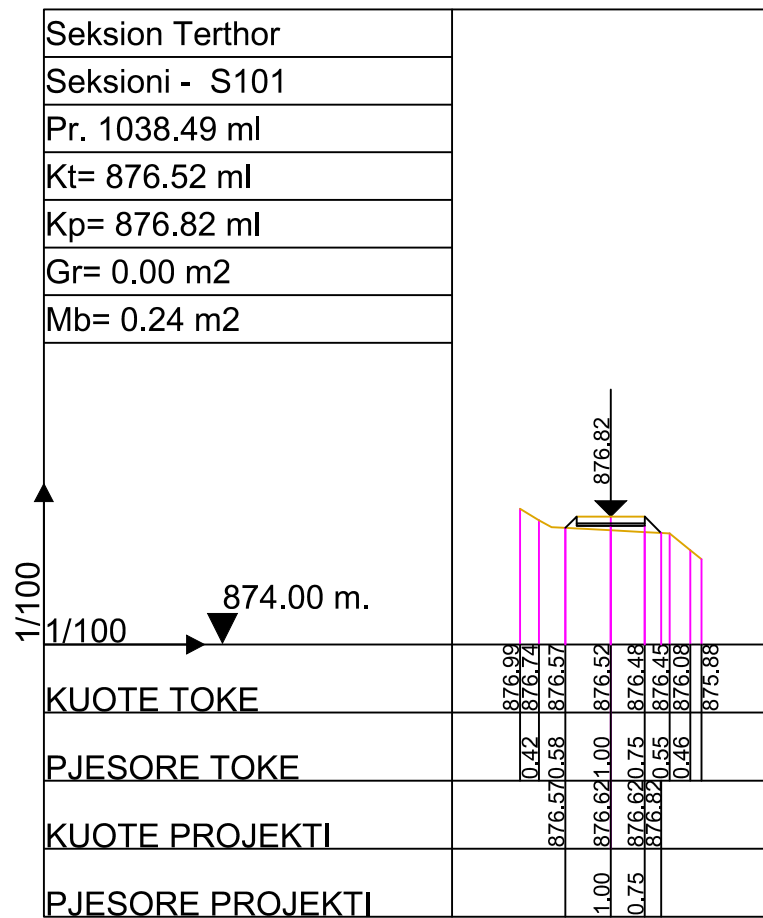
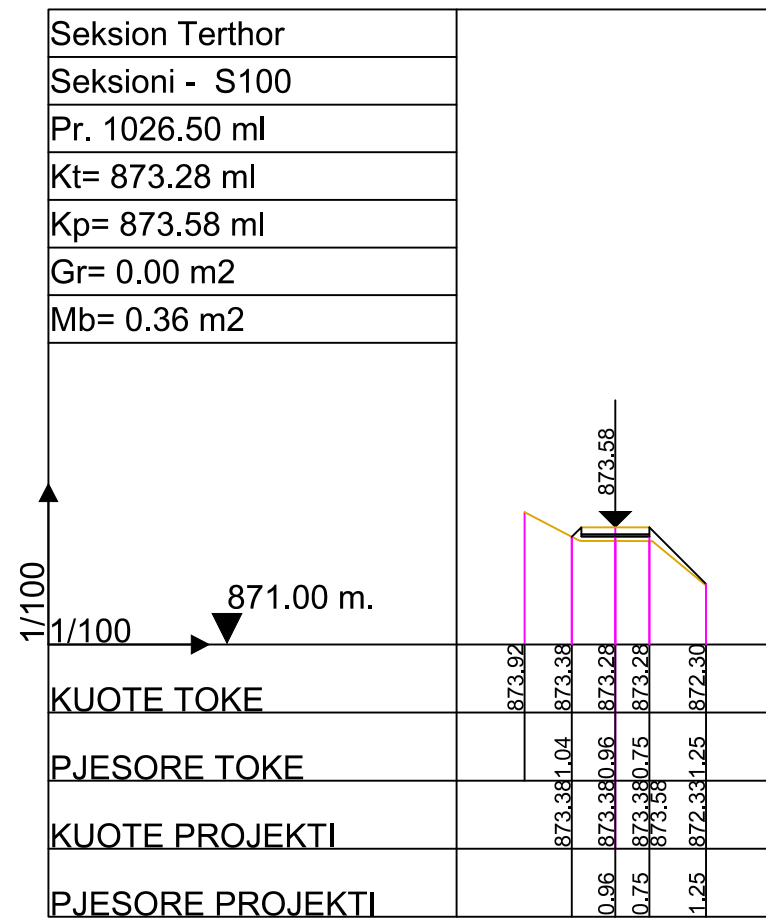
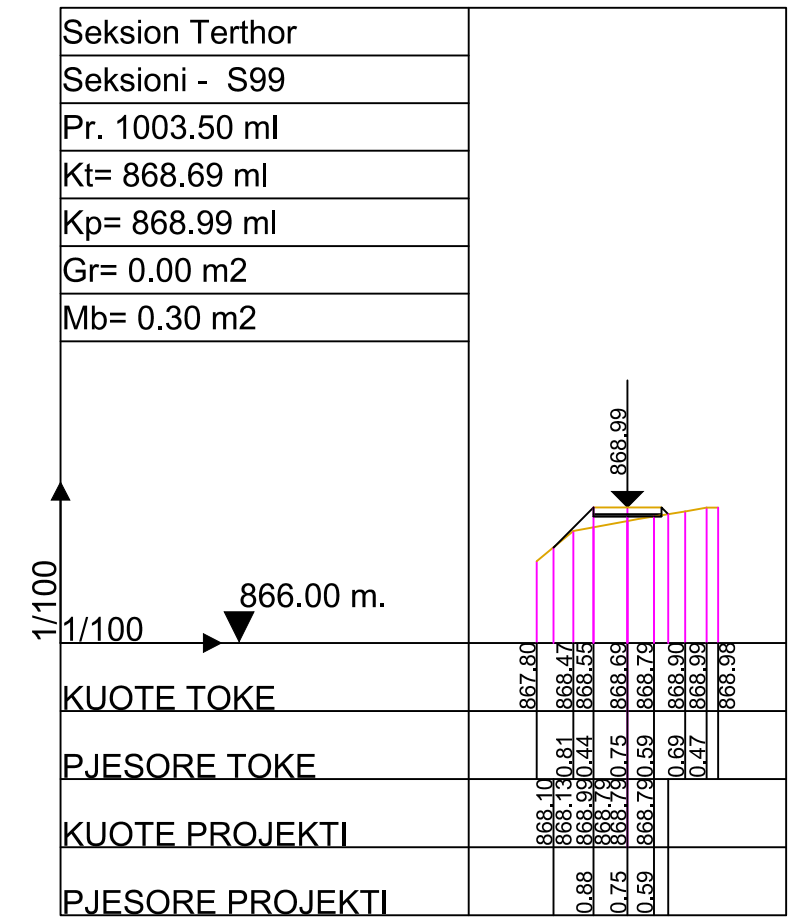
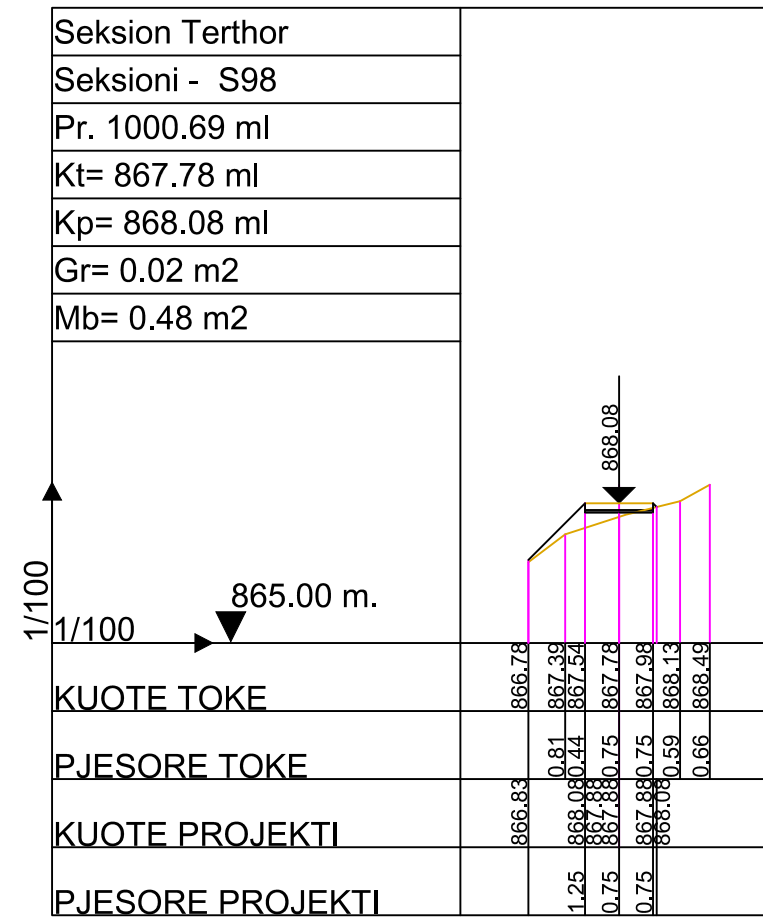
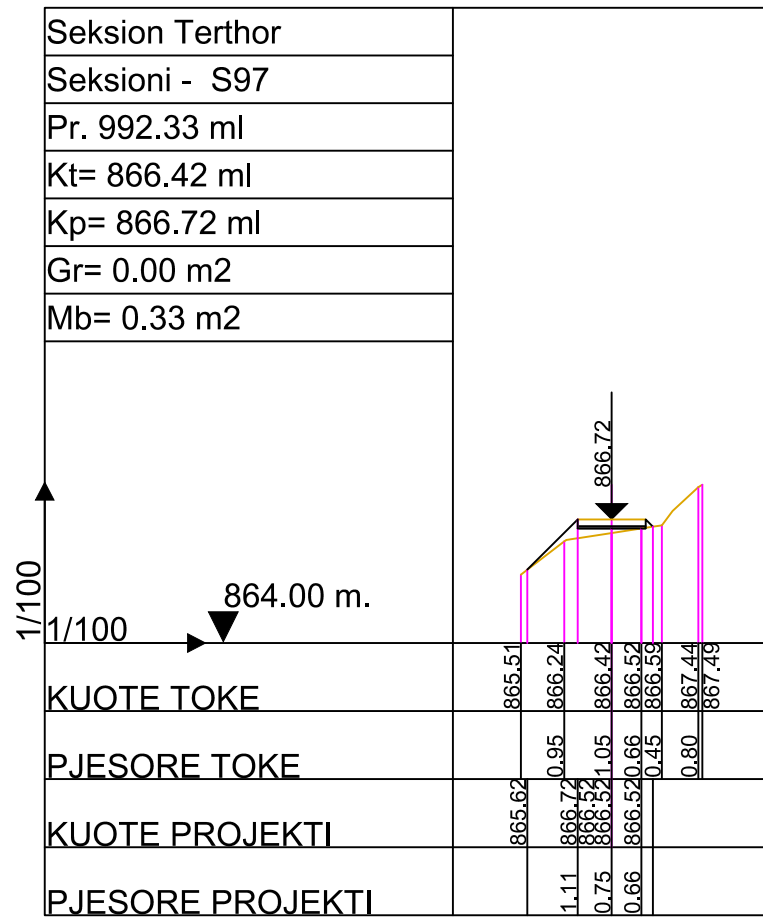

Autoriteit Kontraktor : BASHKIA KRUJE

Objekti: Rikonstruksion Rruga Kembesore "Kruje - Sarisalltik"

Emertimi: SEKSIONET TERTHORE



"ERALD-G" Sh.p.k  
Adresa: Rruga "Koli Bano", Tirane

Drejtes i projektit

Inxh. Gezim ISLAMI

Projektues

Inxh. Aldo MERKAJ  
Ark. Elton Çarçani  
Hidr. Ersida VERÇANI

Elek. Hajdar KURTI  
Mek. Arben MUHA

SHKALLA

SHK 1:100

Tiranë 2017

FLETA

3 -17

Format A3

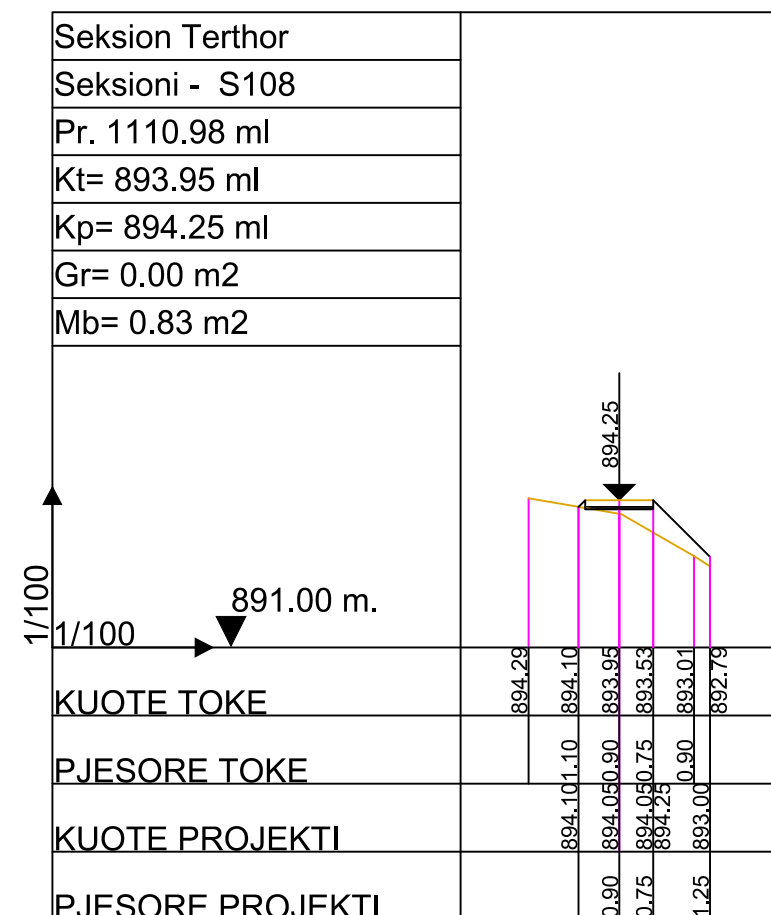
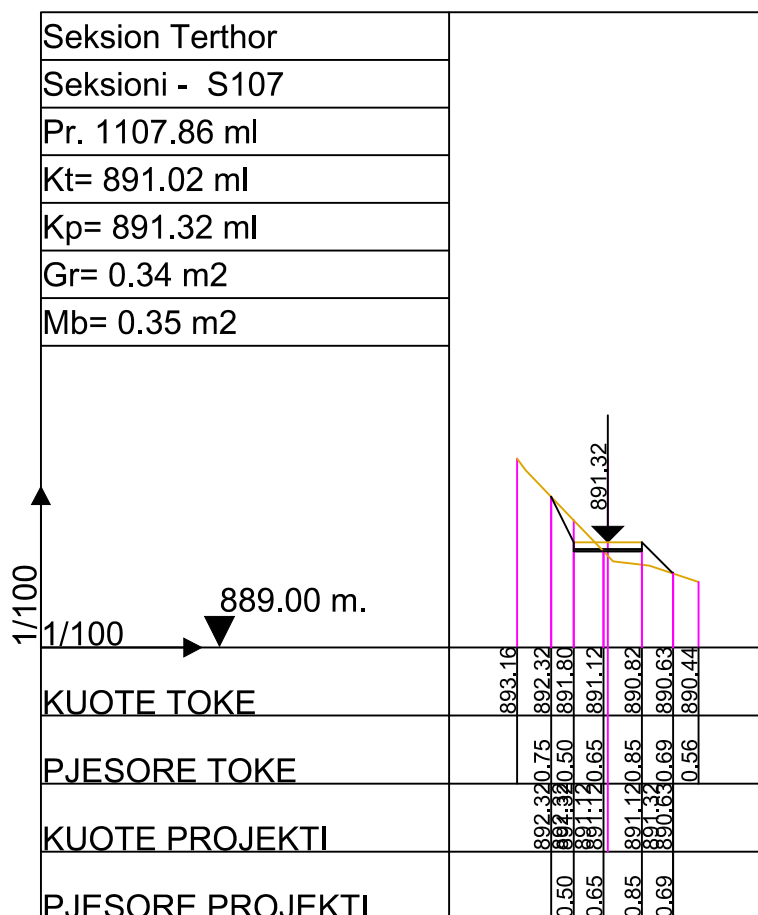
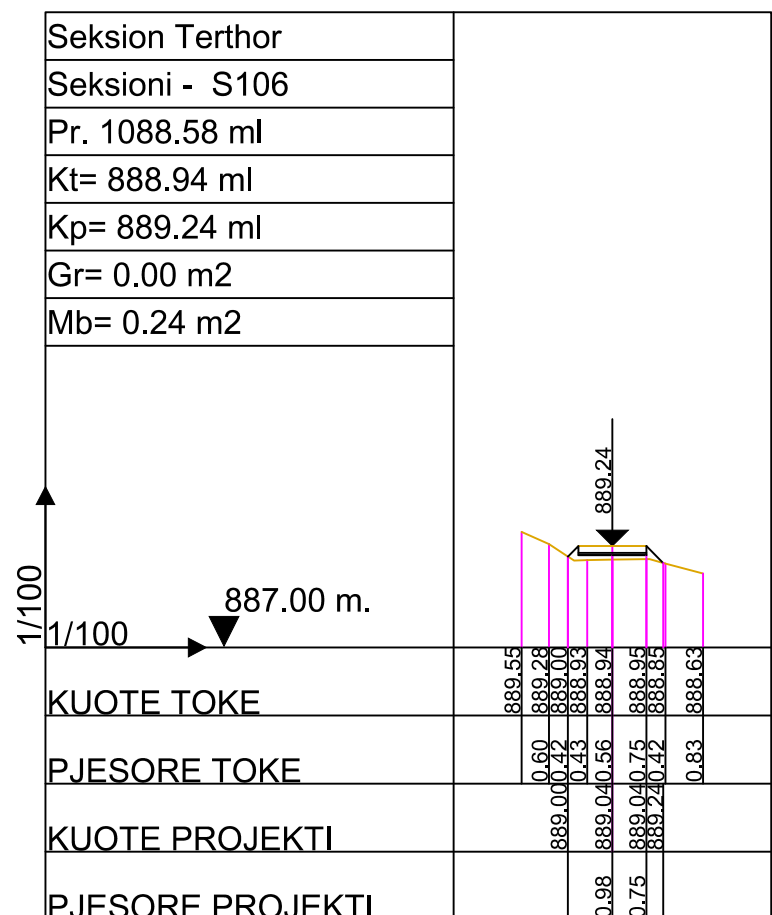
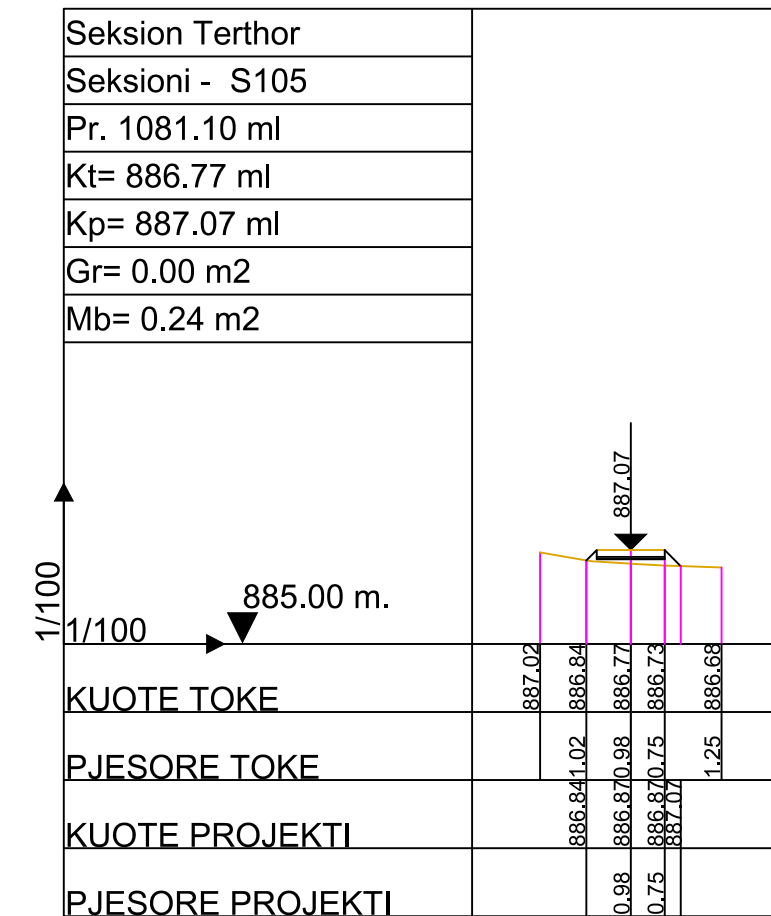
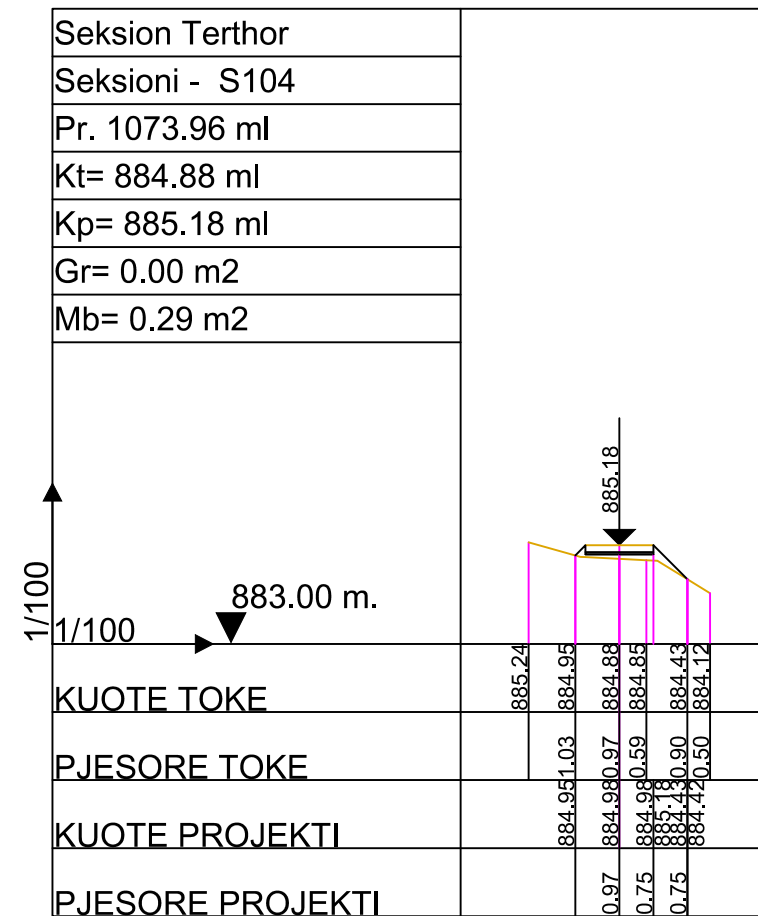
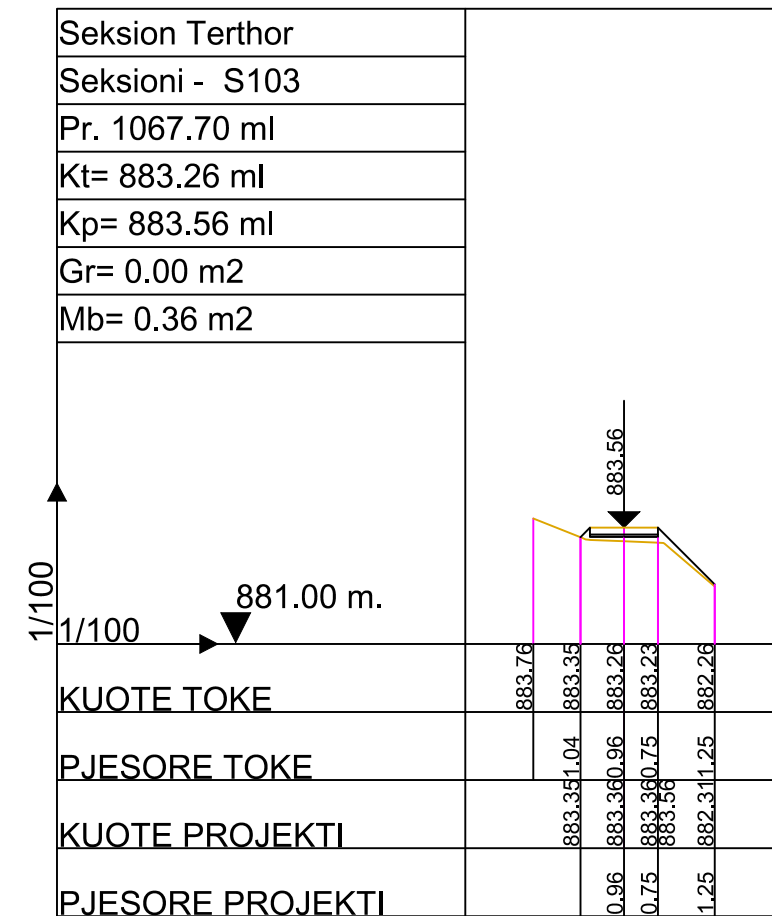

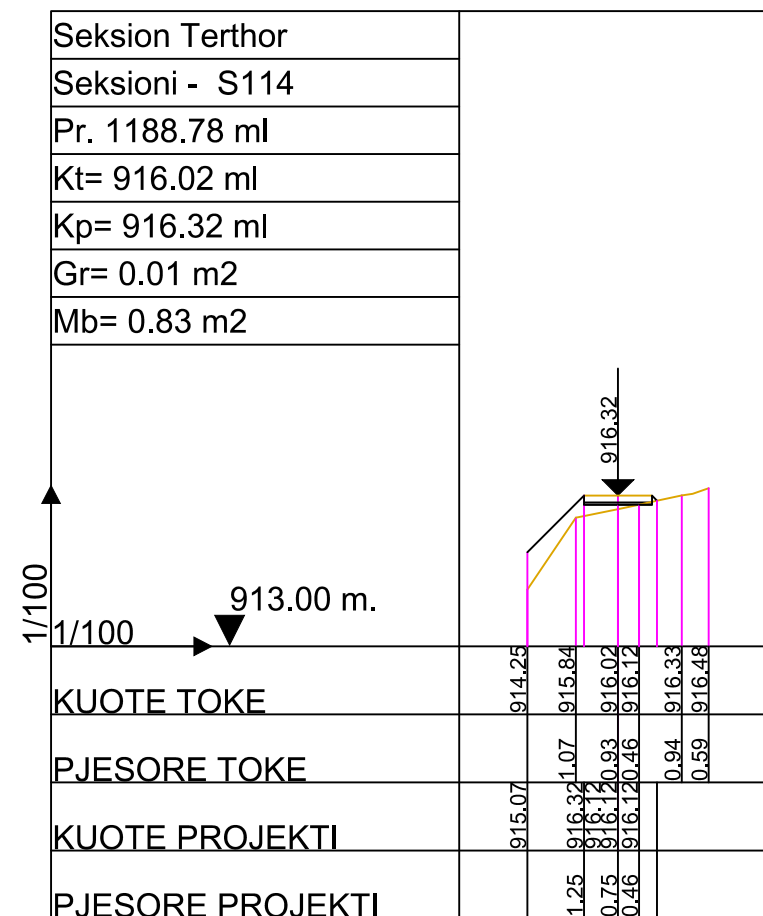
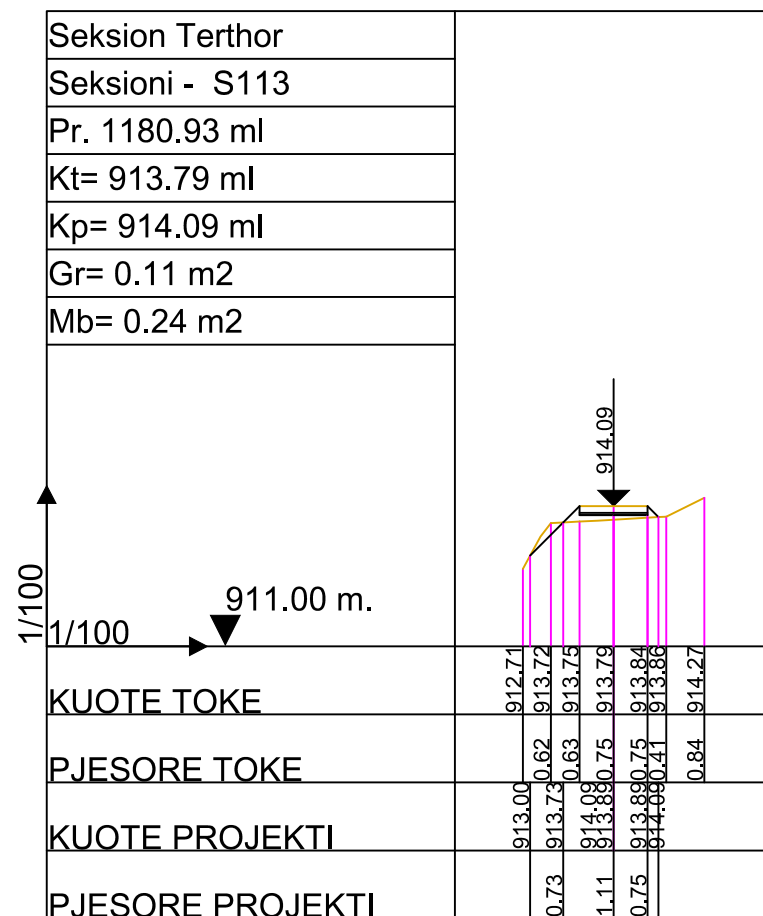
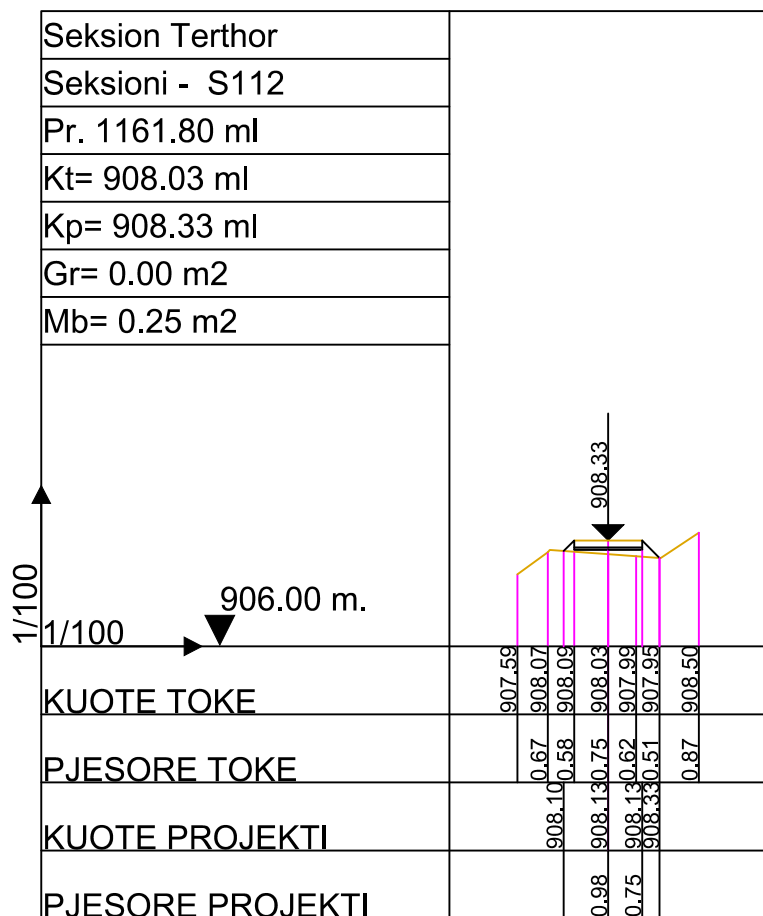
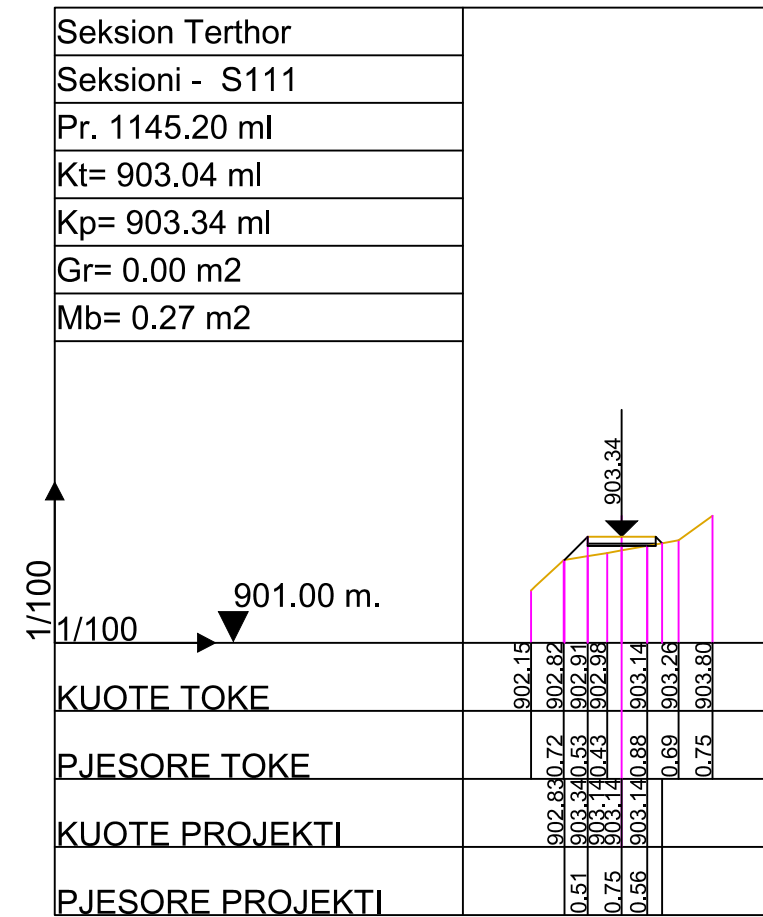
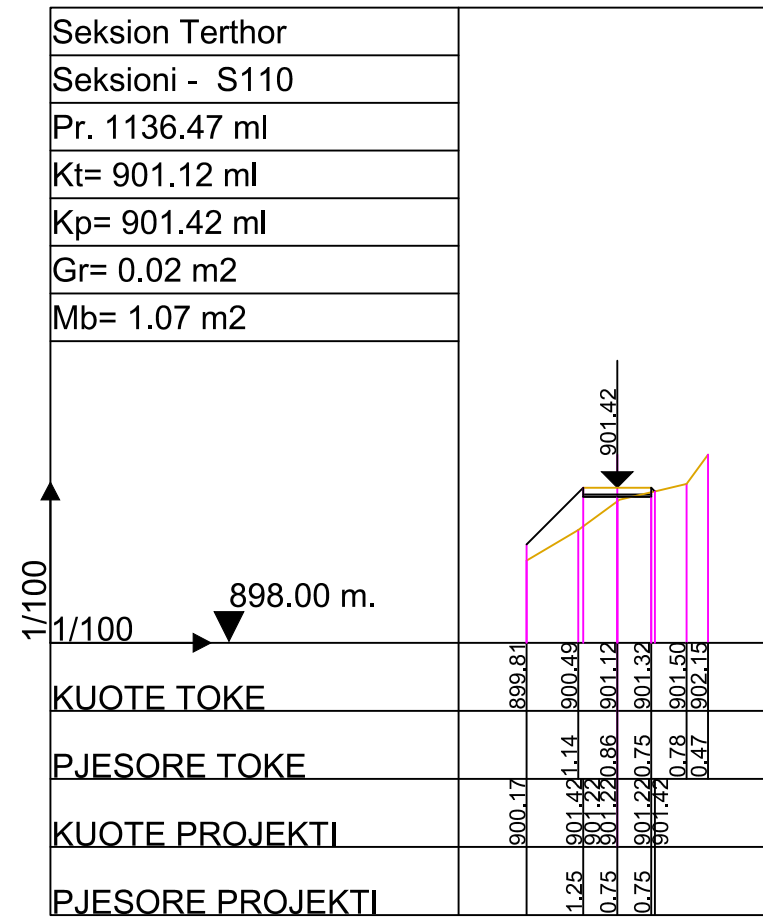
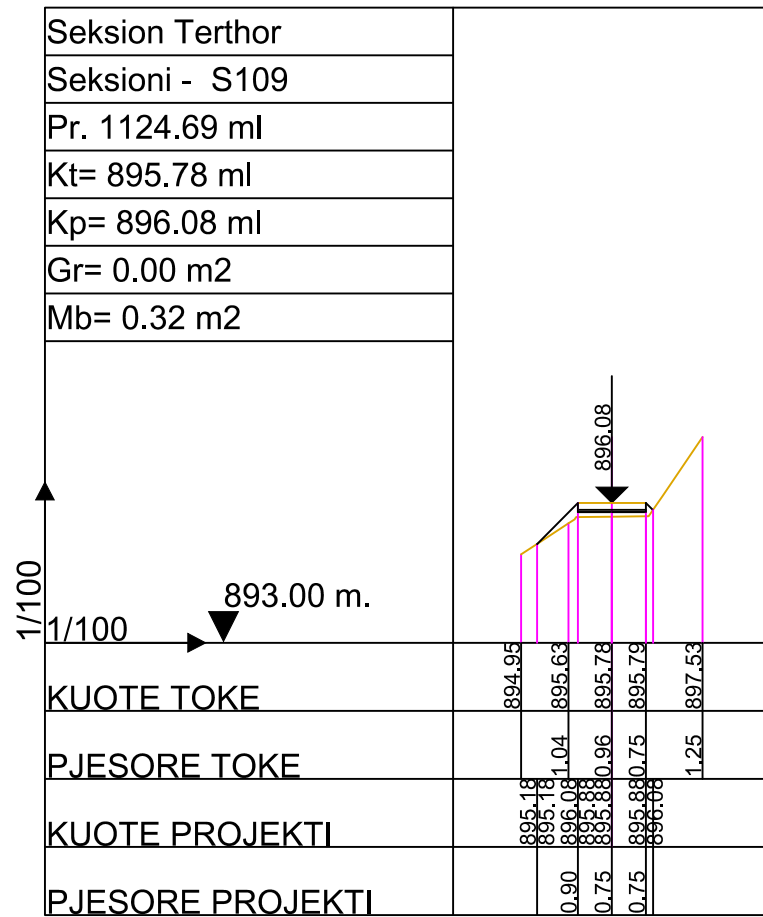

Autoriteit Kontraktor : BASHKIA KRUJE

Objekti: Rikonstruksion Rruga Kembesore "Kruje - Sarisalltik"

Emertimi: SEKSIONET TERTHORE



"ERALD-G" Sh.p.k  
Adresa: Rruga "Koli Bano", Tirane

Drejtes i projektit

Inxh. Gezim ISLAMI

Projektues

Inxh. Aldo MERKAJ  
Ark. Elton Çarçani  
Hidr. Ersida VERÇANI

Elek. Hajdar KURTI  
Mek. Arben MUHA

SHKALLA

SHK 1:100

Tiranë 2017

FLETA

3 -19

Format A3

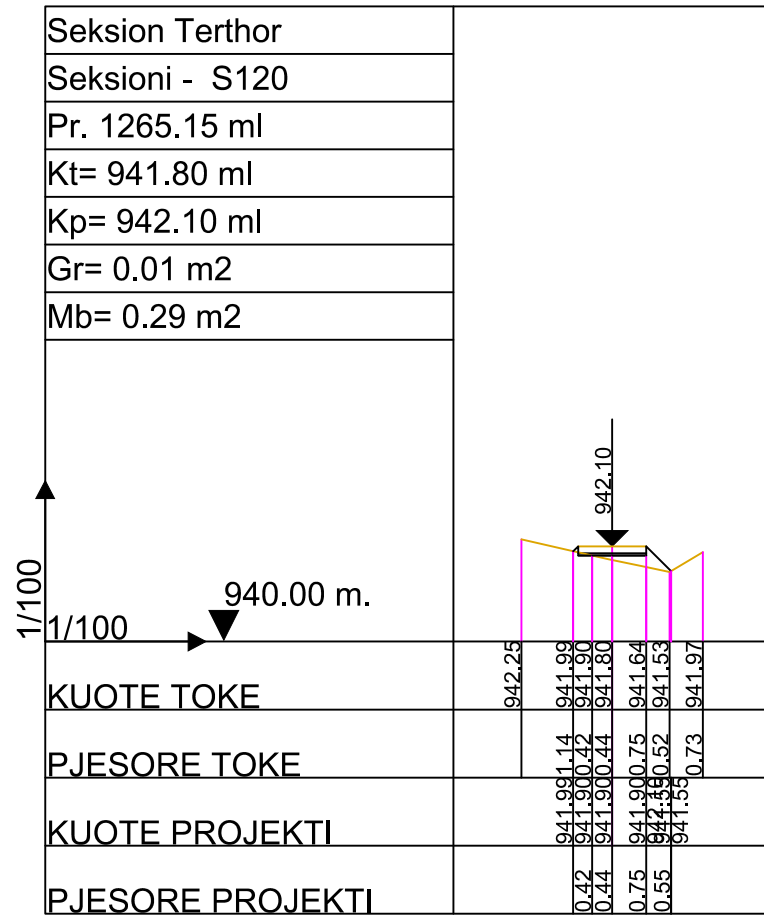
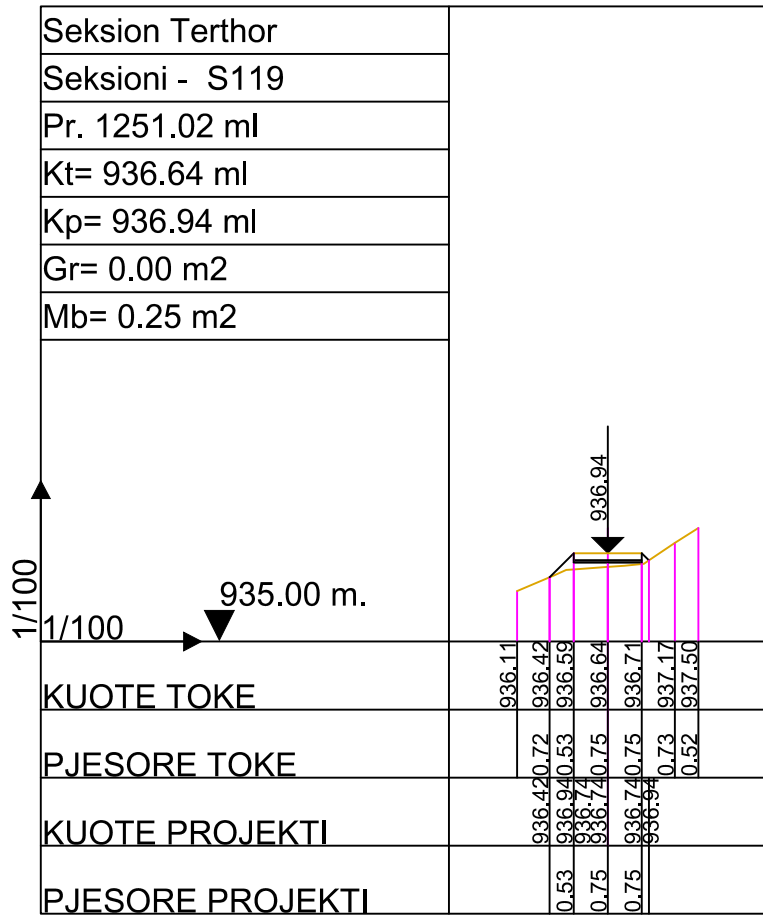
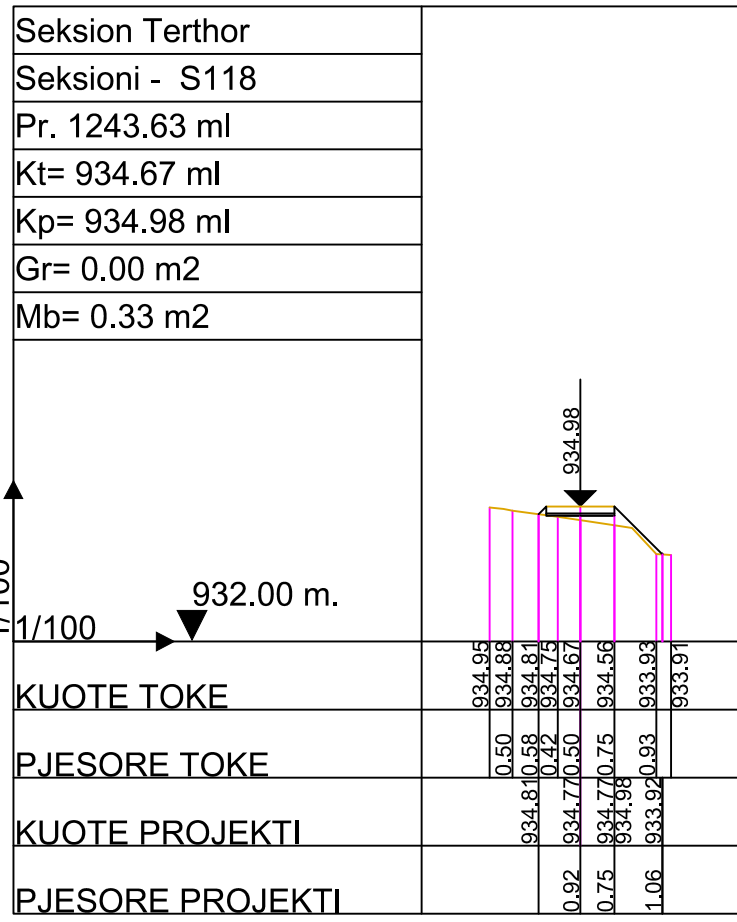
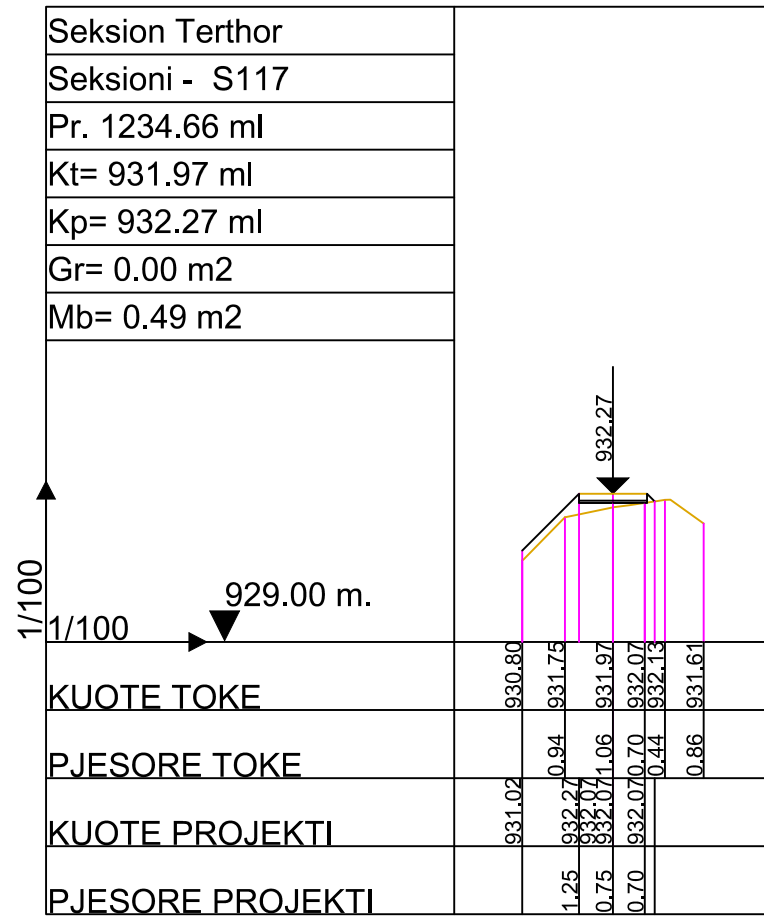
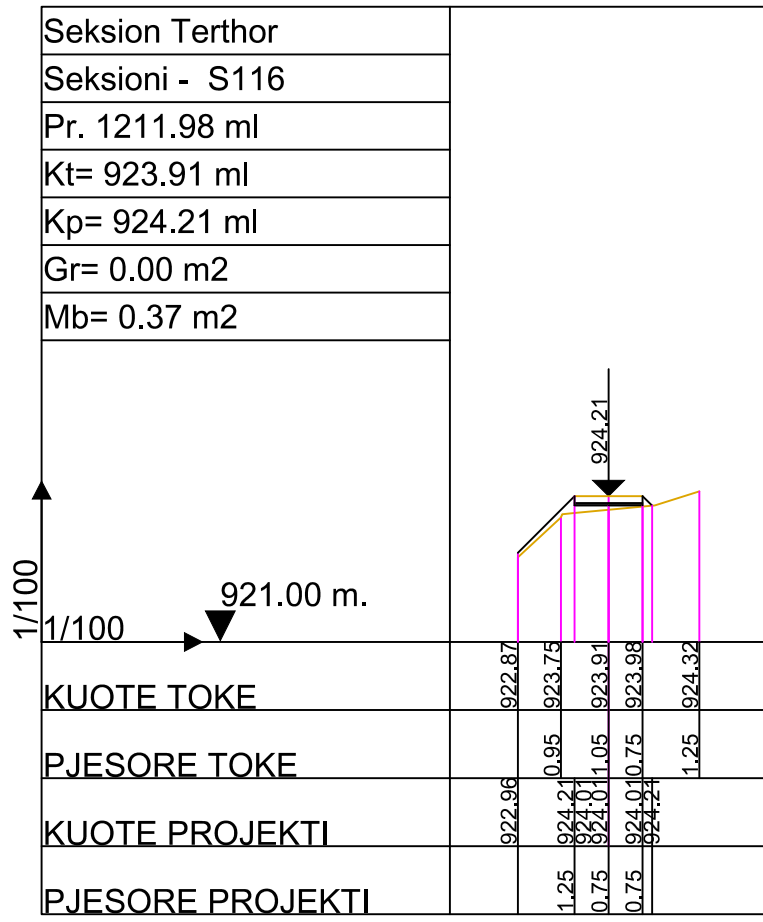
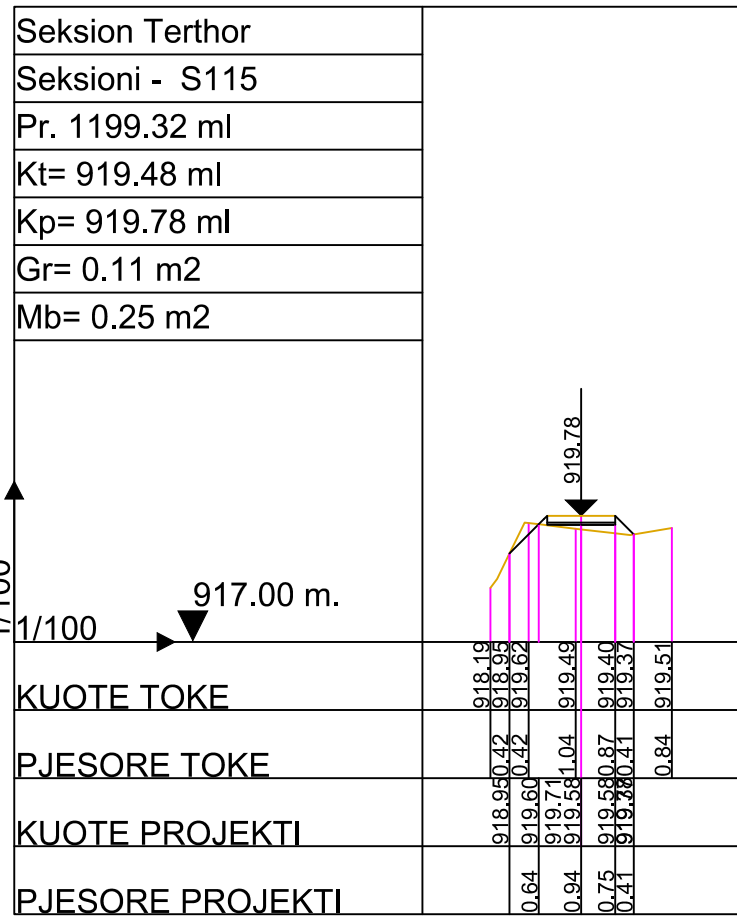

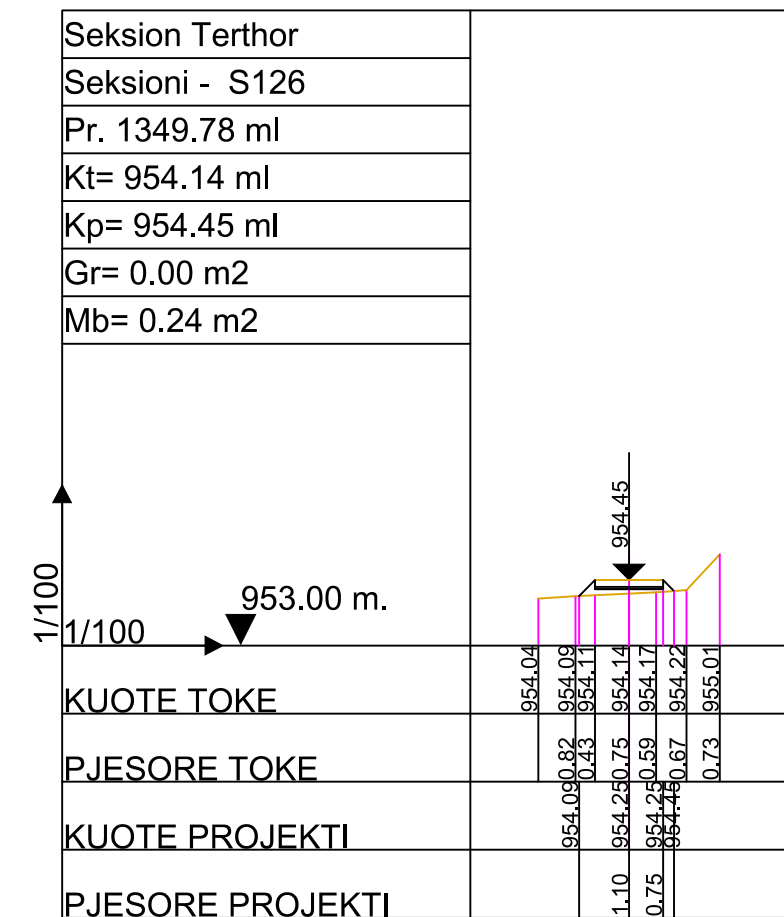
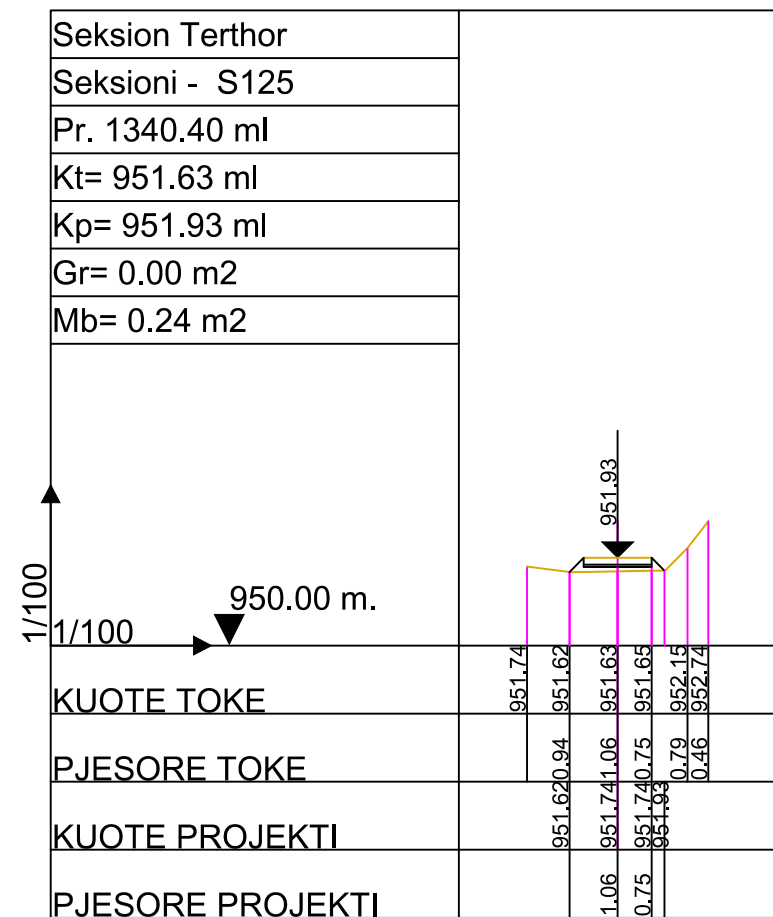
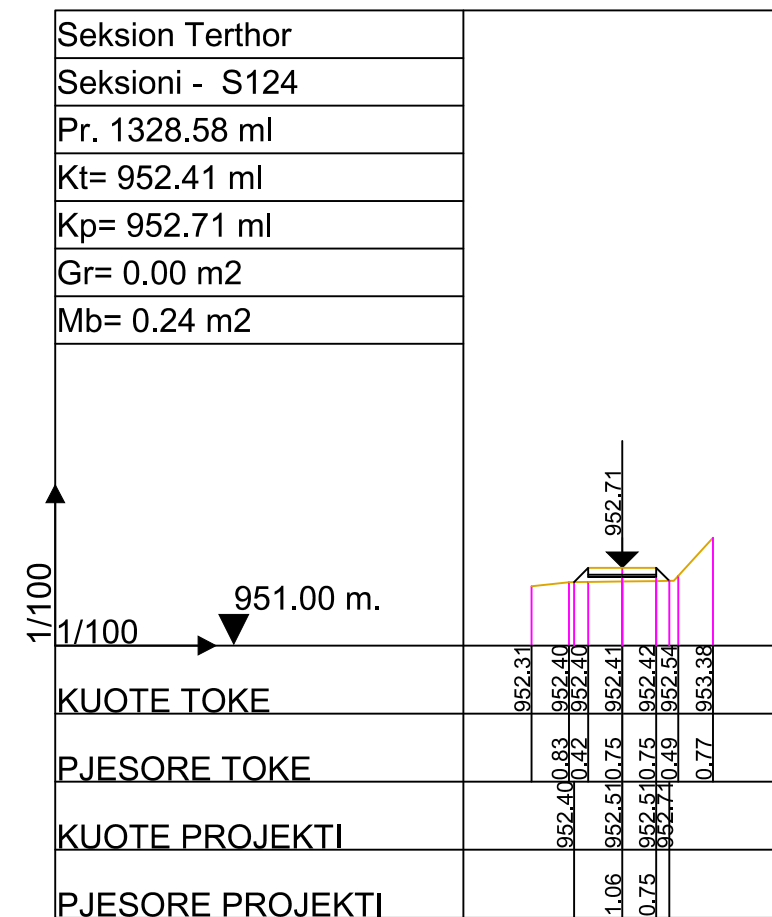
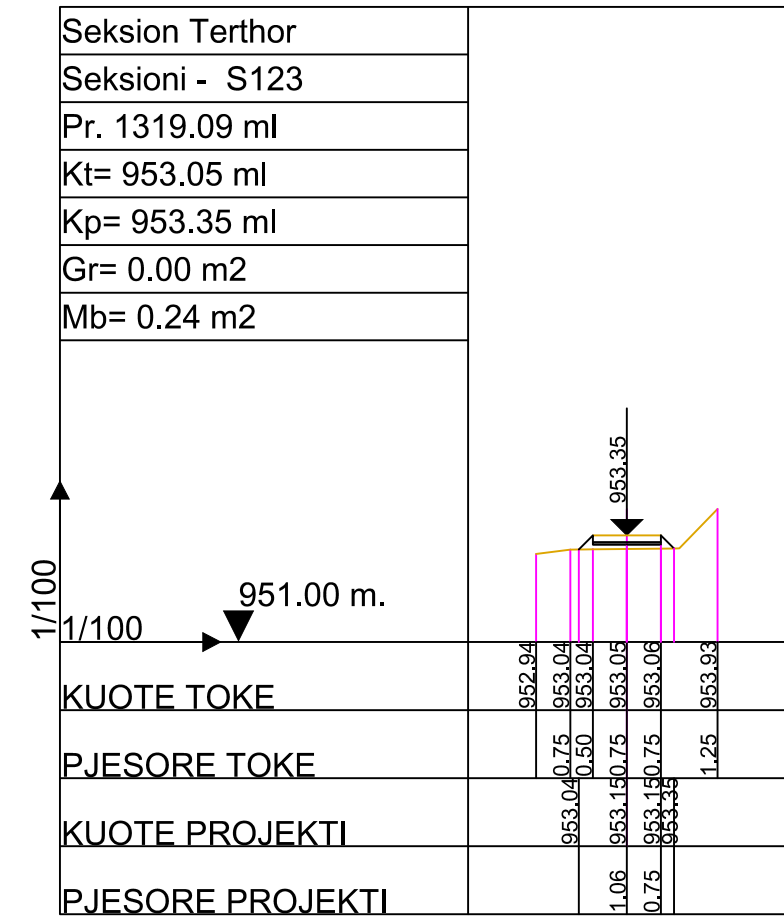
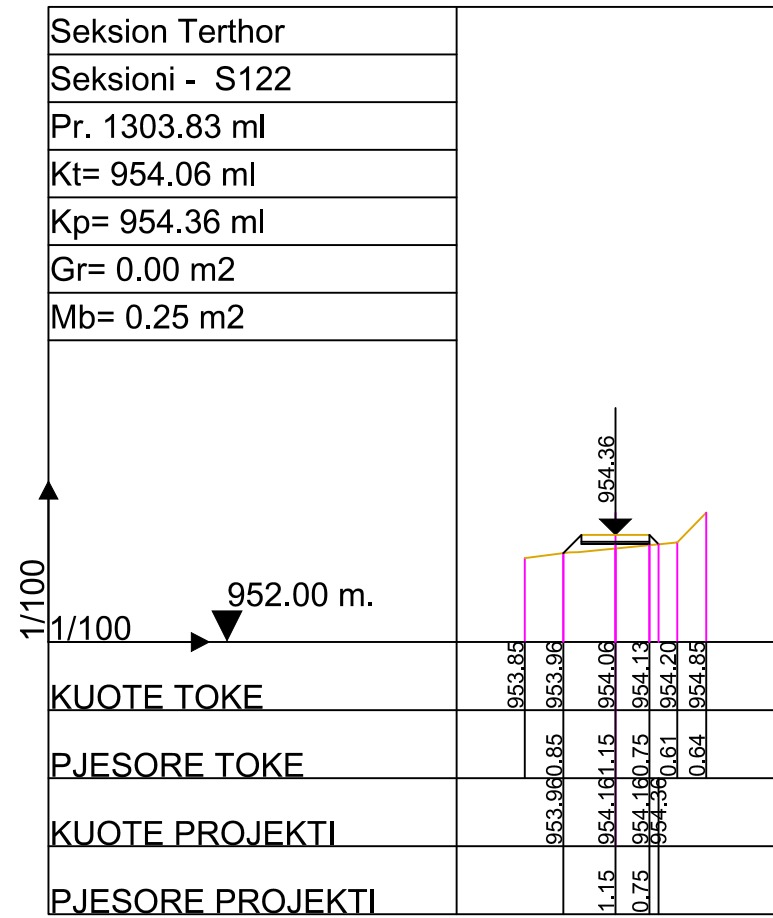
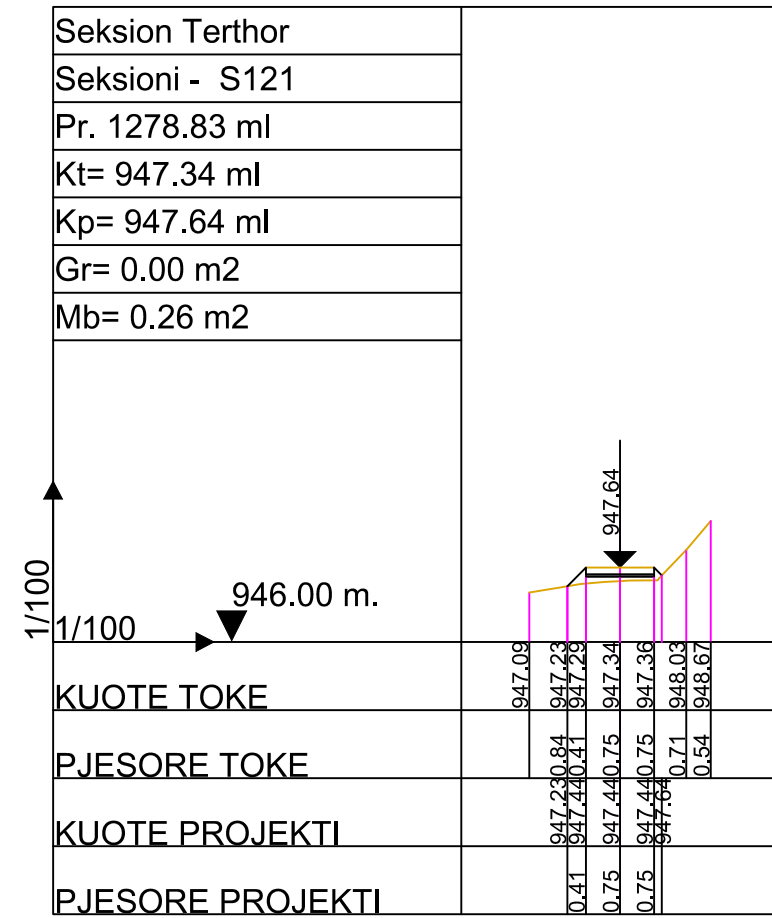



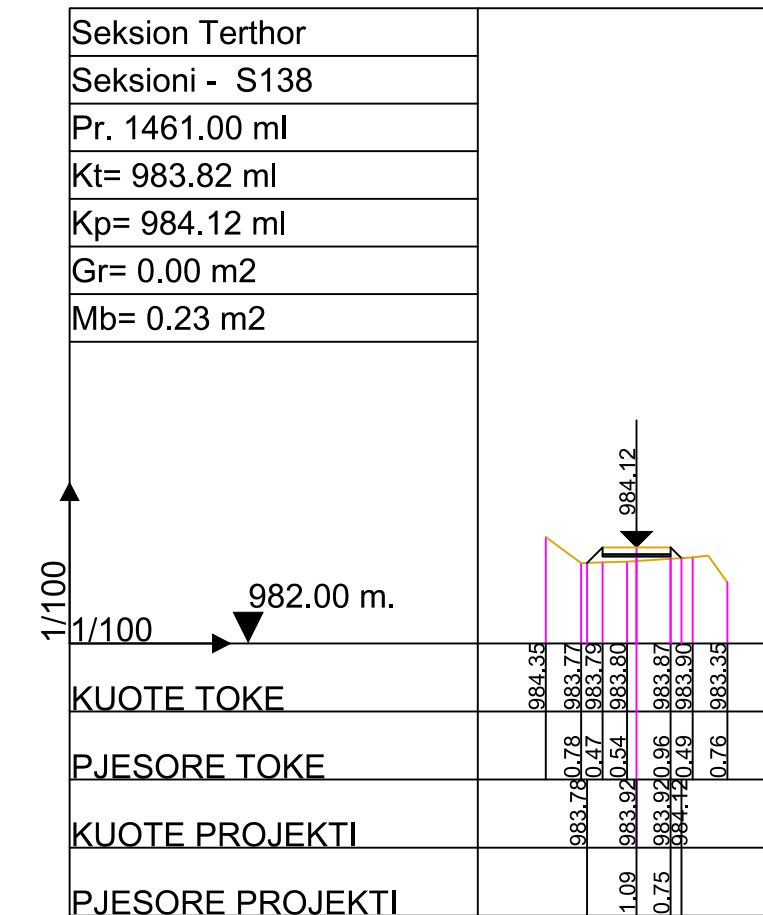
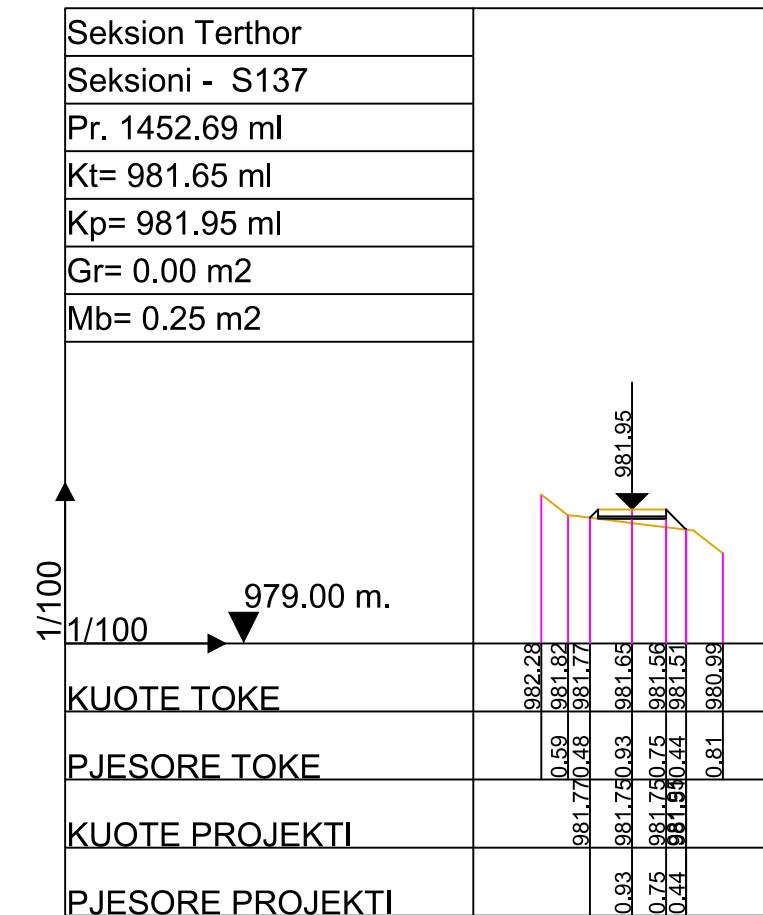
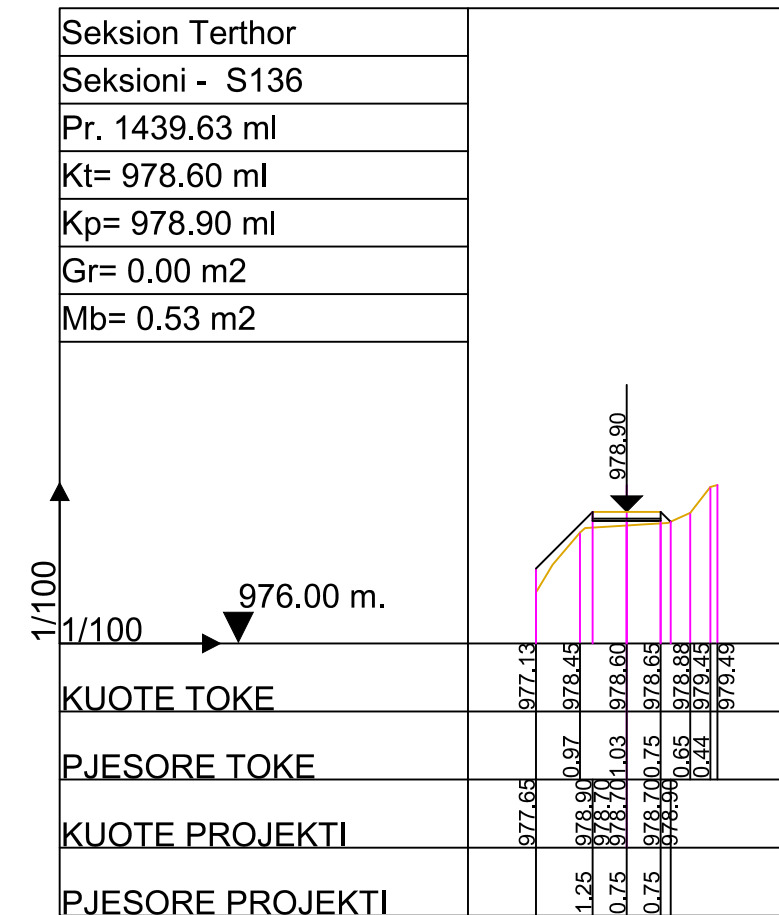
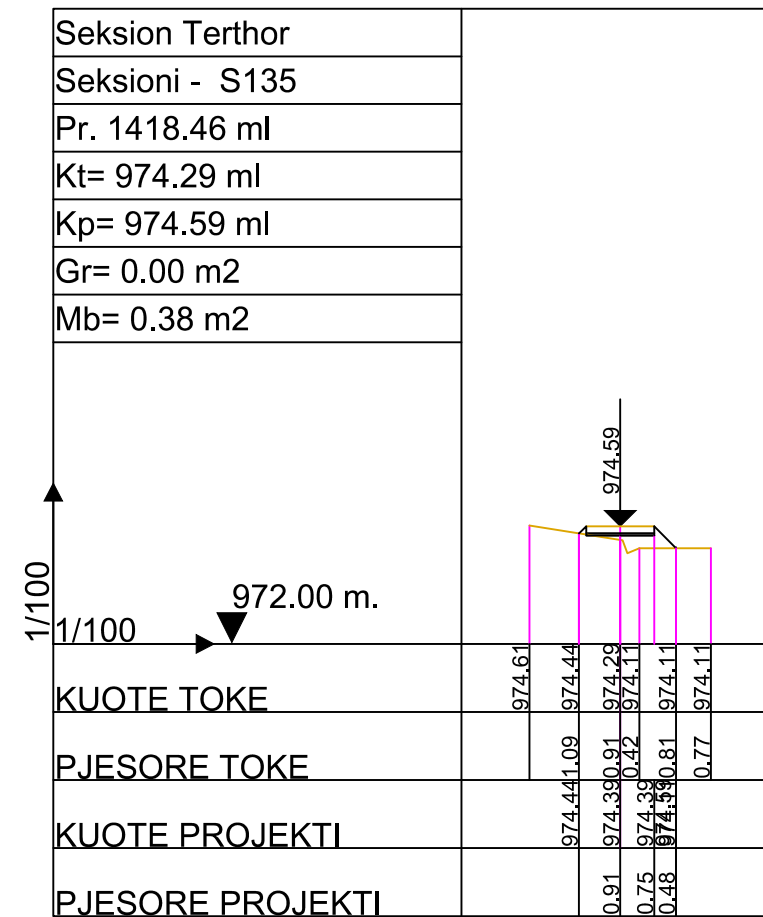
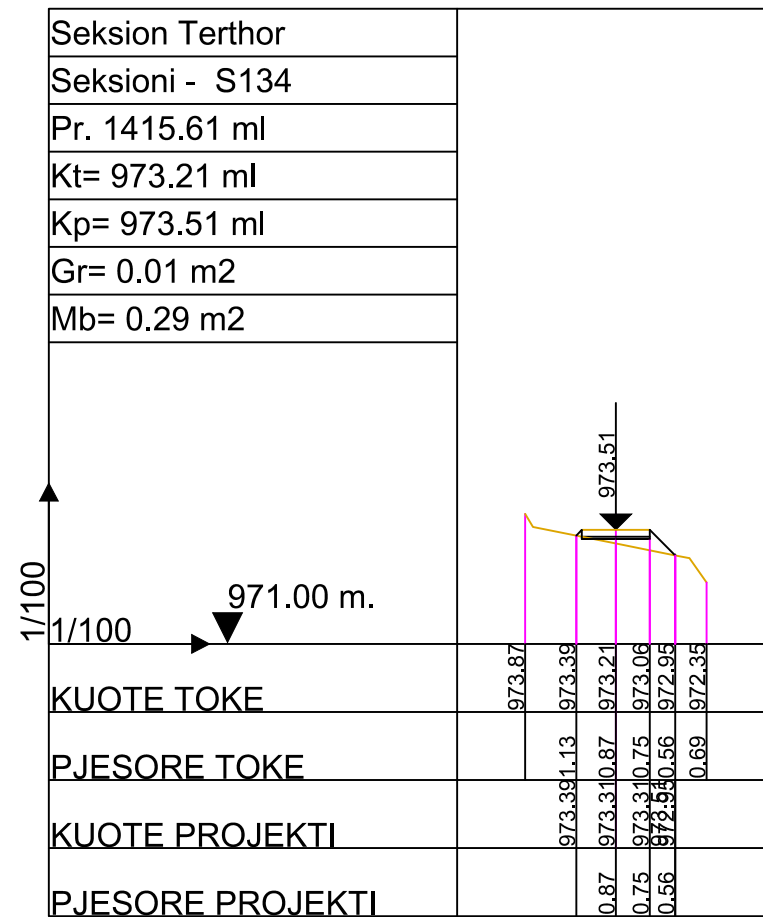
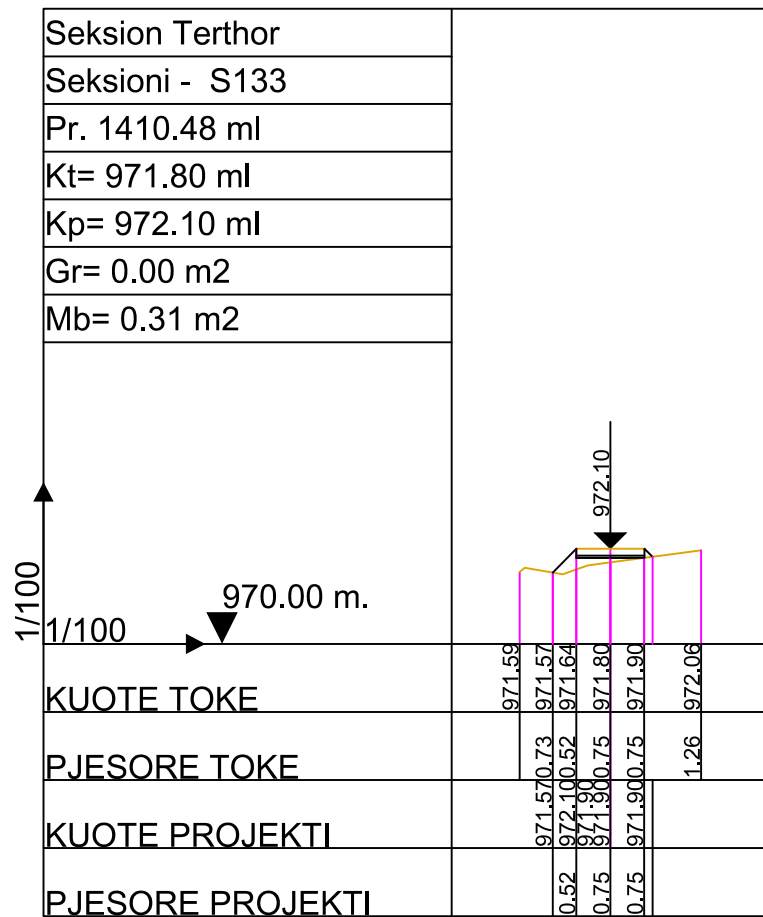



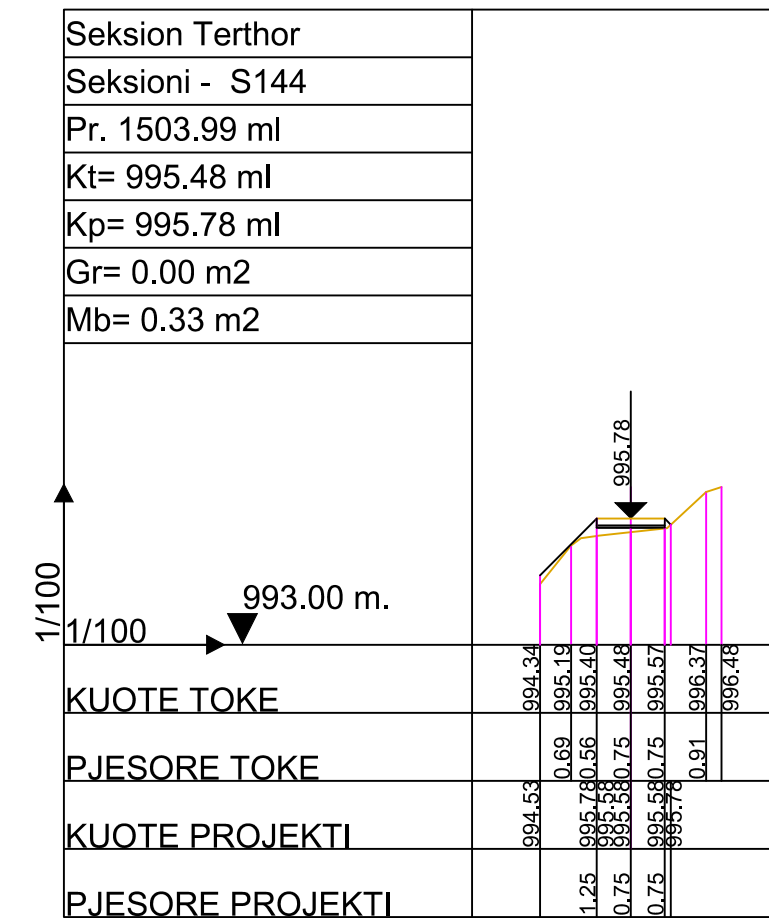
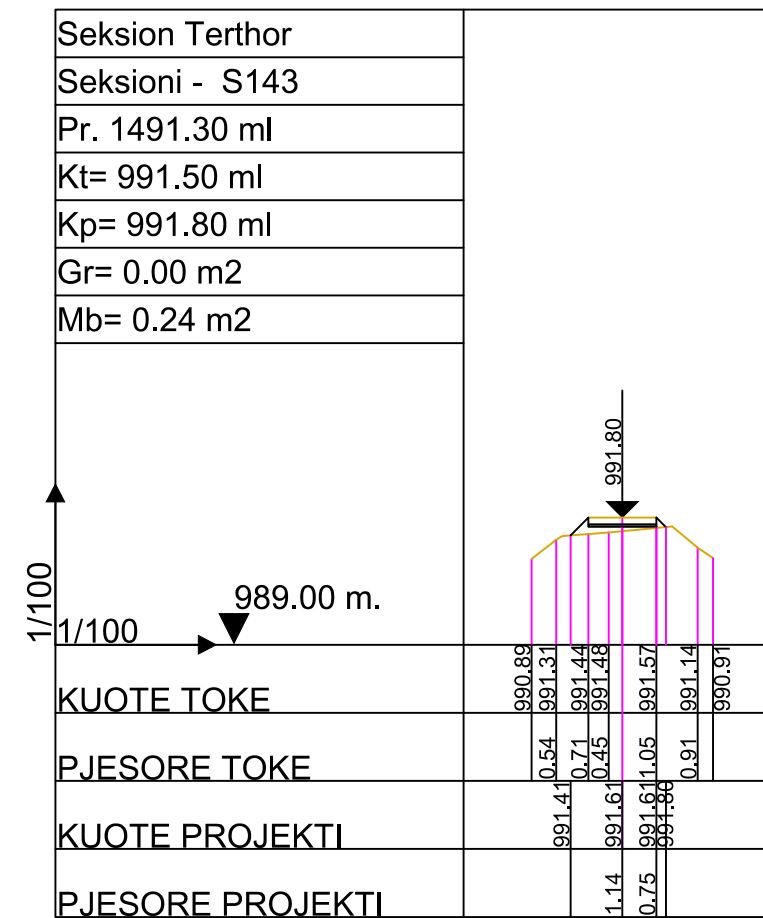
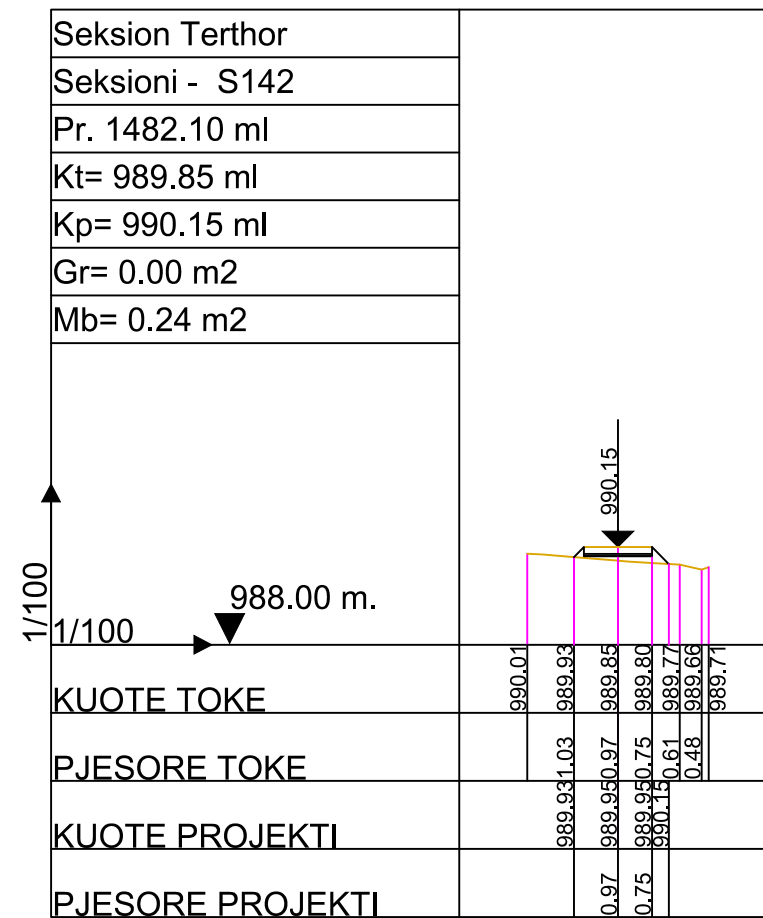
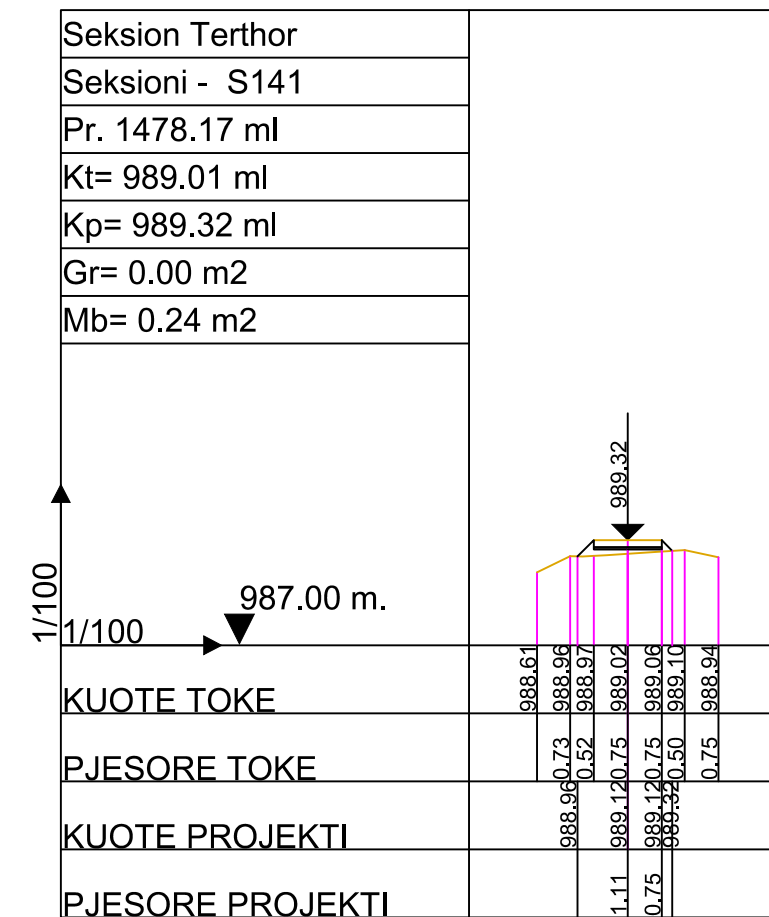
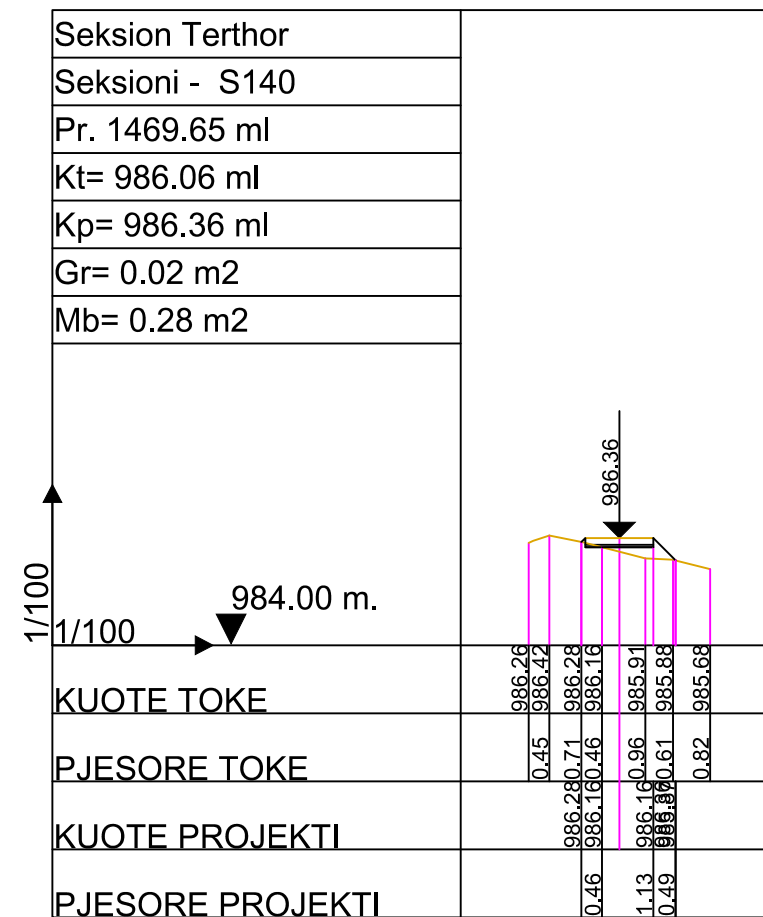
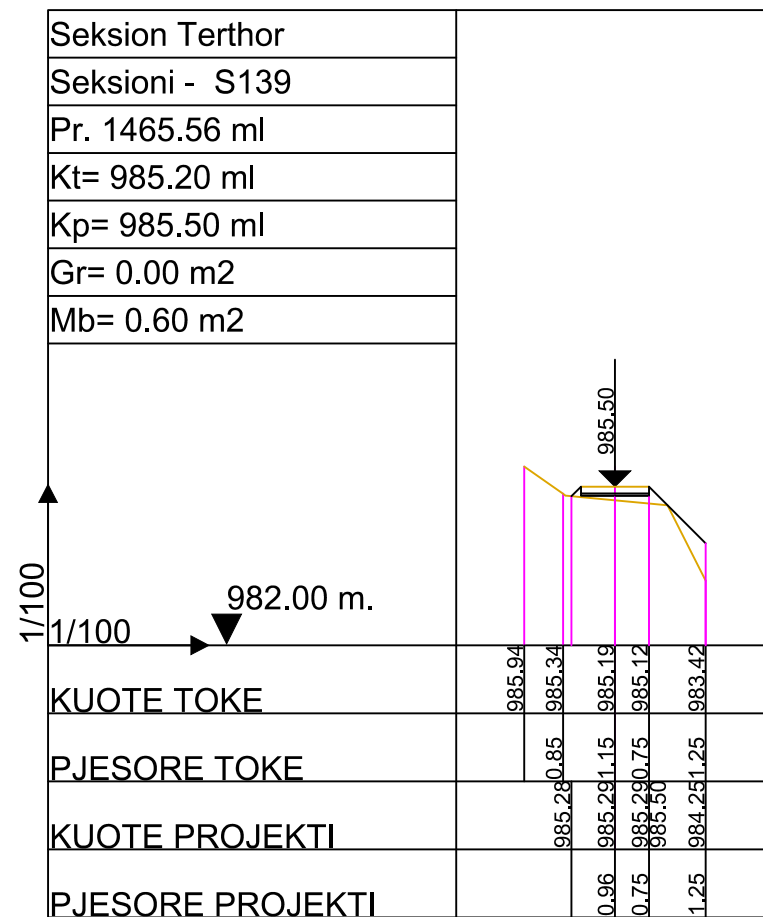

Autoriteit Kontraktor : BASHKIA KRUJE

Objekti: Rikonstruksion Rruga Kembesore "Kruje - Sarisalltik"

Emertimi: SEKSIONET TERTHORE



"ERALD-G" Sh.p.k  
Adresa: Rruga "Koli Bano", Tirane

Drejtes i projektit

Inxh. Gezim ISLAMI

Projektues

Inxh. Aldo MERKAJ  
Ark. Elton Çarçani  
Hidr. Ersida VERÇANI

Elek. Hajdar KURTI  
Mek. Arben MUHA

SHKALLA

SHK 1:100

Tiranë 2017

FLETA

3 -24

Format A3

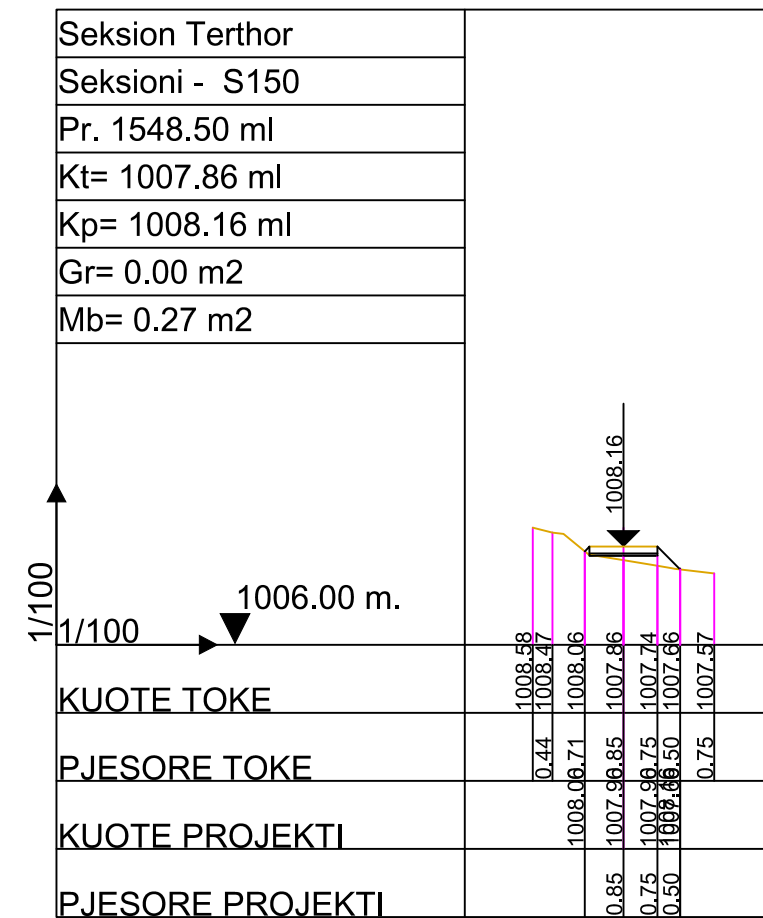
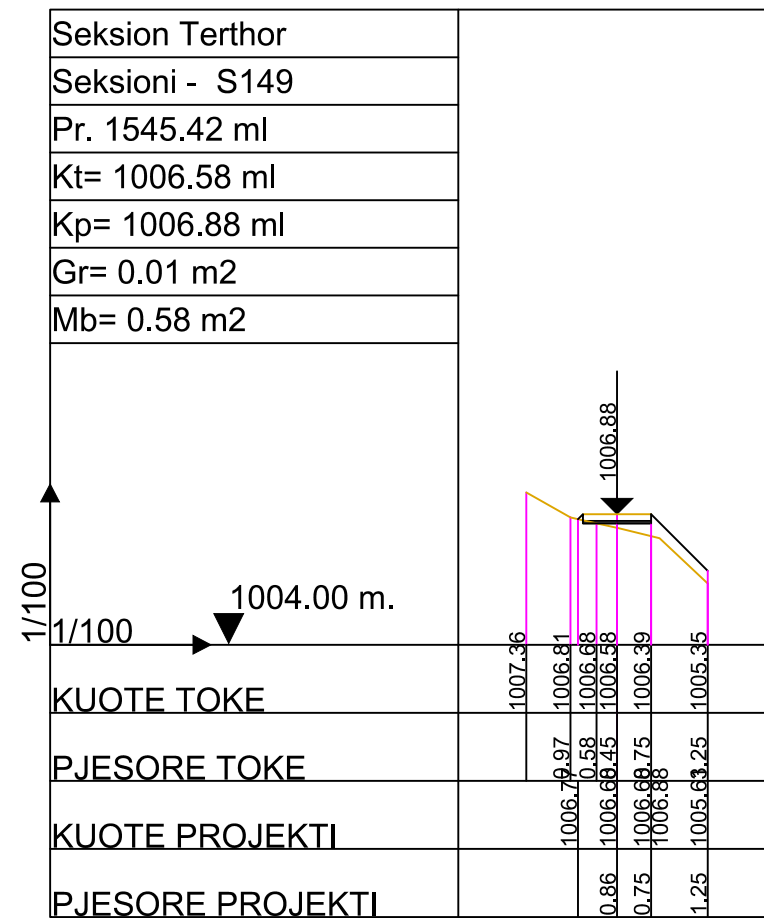
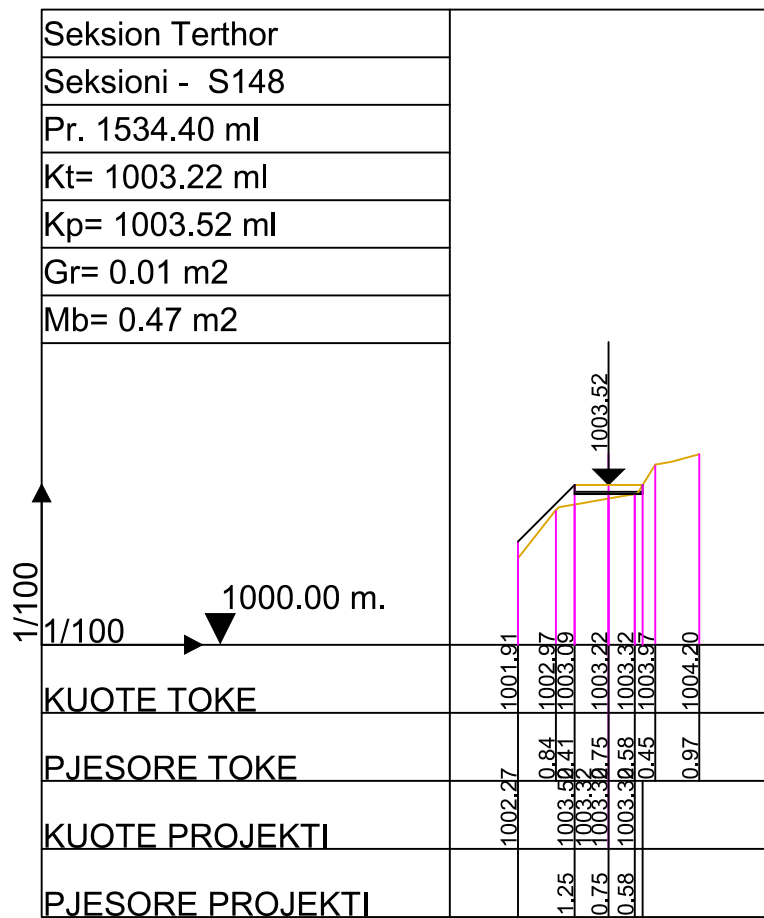
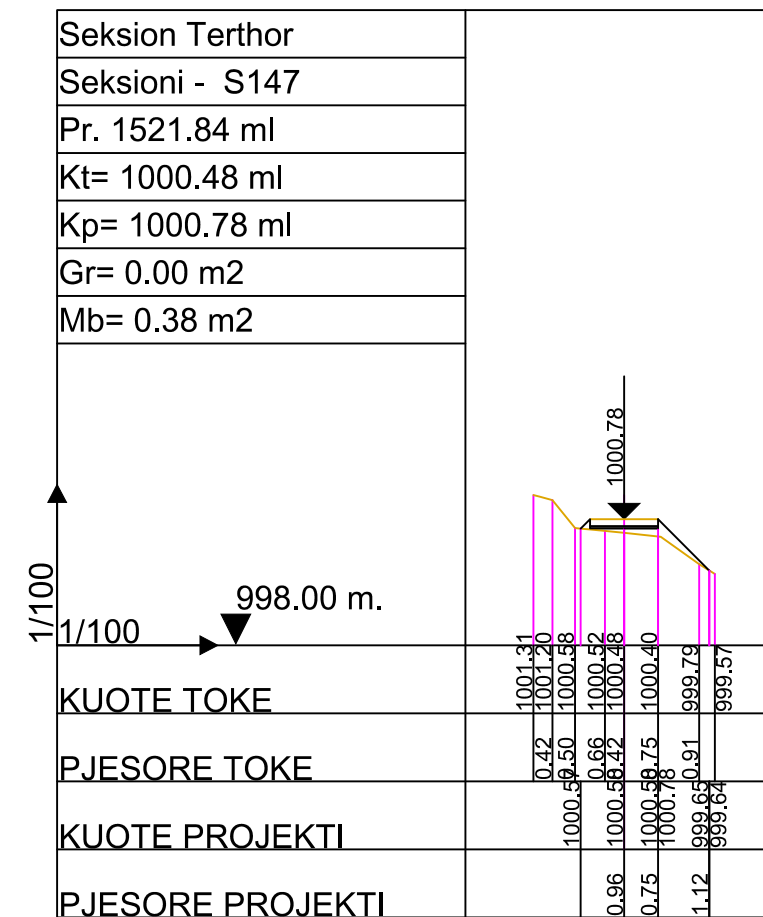
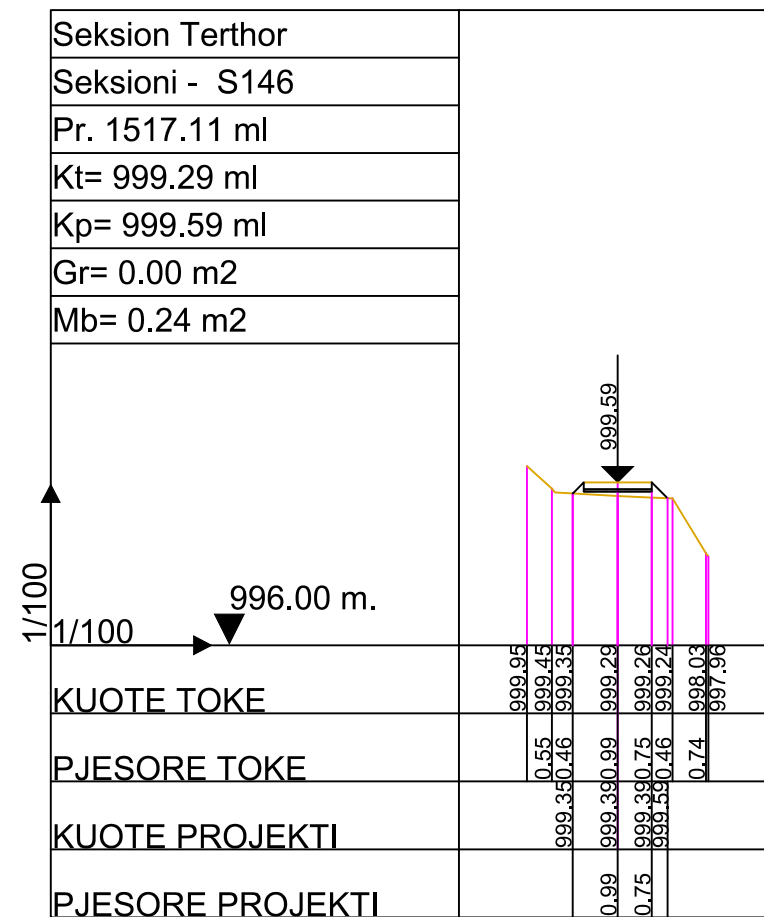
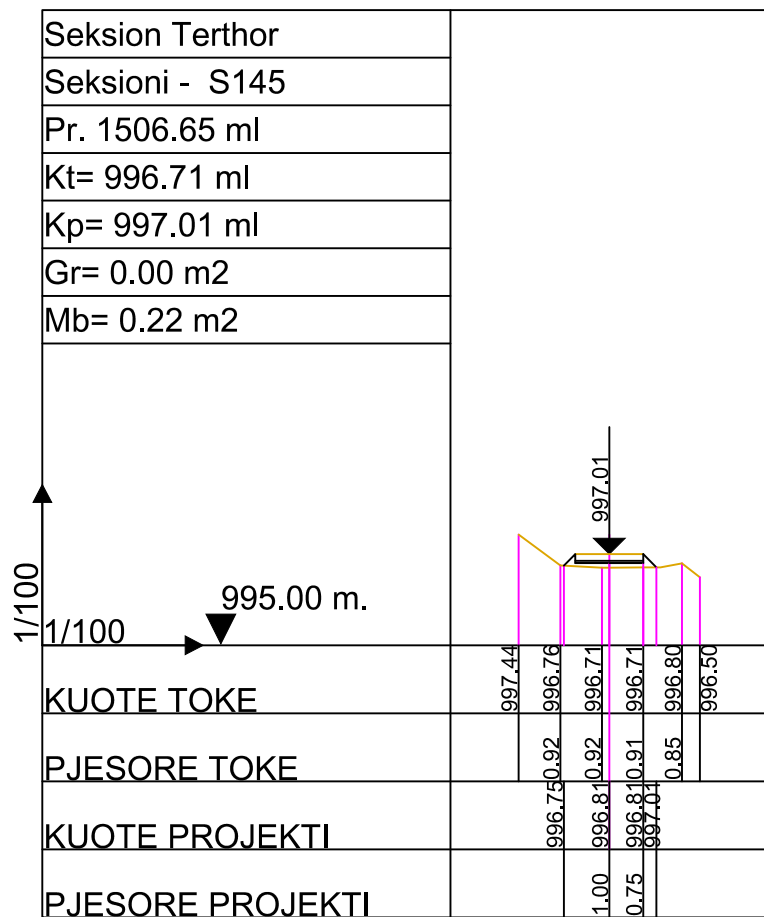

Autoriteit Kontraktor : BASHKIA KRUJE

Objekti: Rikonstruksion Rruga Kembesore "Kruje - Sarisalltik"

Emertimi: SEKSIONET TERTHORE



"ERALD-G" Sh.p.k  
Adresa: Rruga "Koli Bano", Tirane

Drejtes i projektit

Inxh. Gezim ISLAMI

Projektues

Inxh. Aldo MERKAJ  
Ark. Elton Çarçani  
Hidr. Ersida VERÇANI

Elek. Hajdar KURTI  
Mek. Arben MUHA

SHKALLA

SHK 1:100

Tiranë 2017

FLETA

3 -25

Format A3

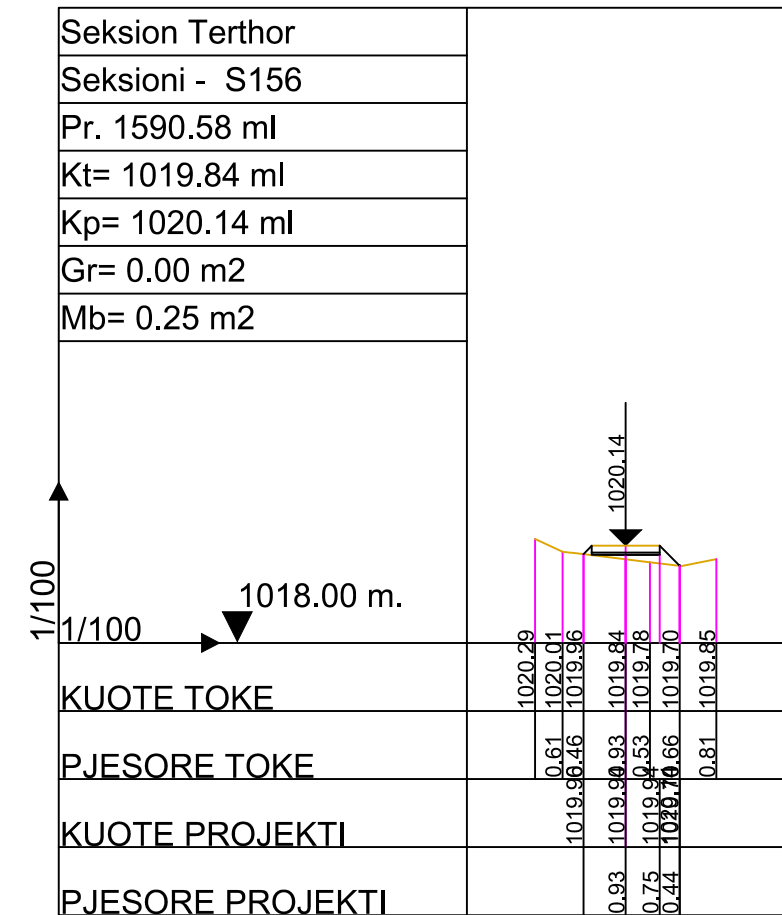
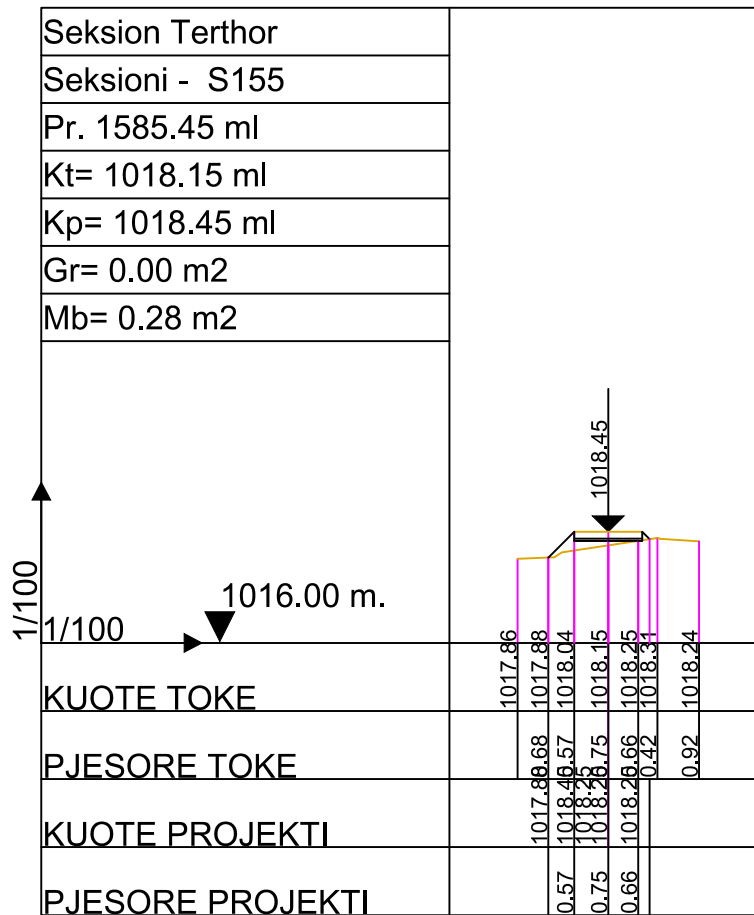
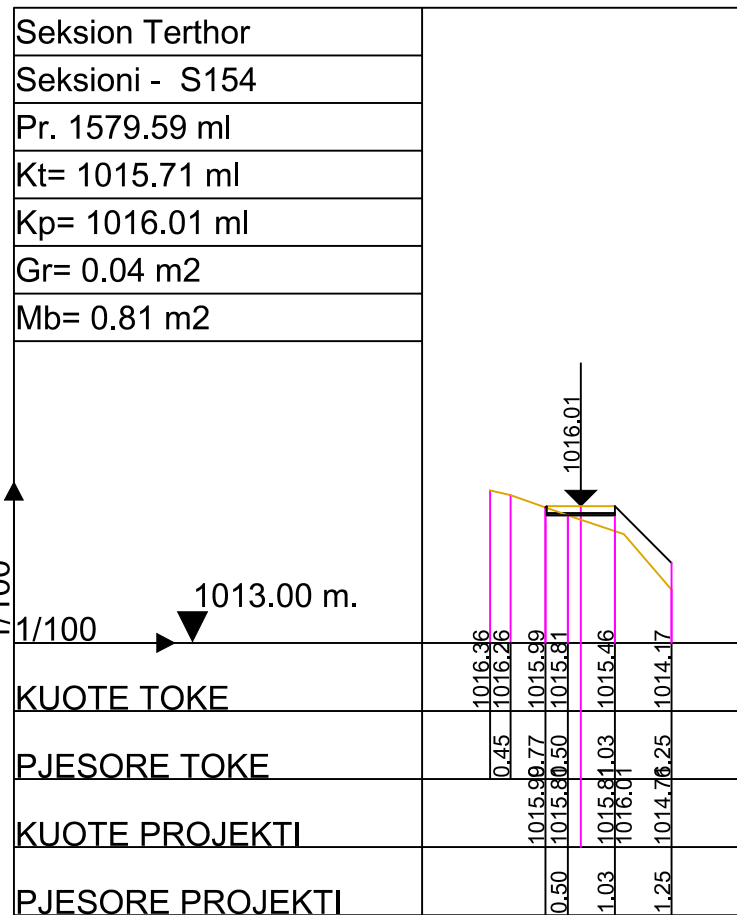
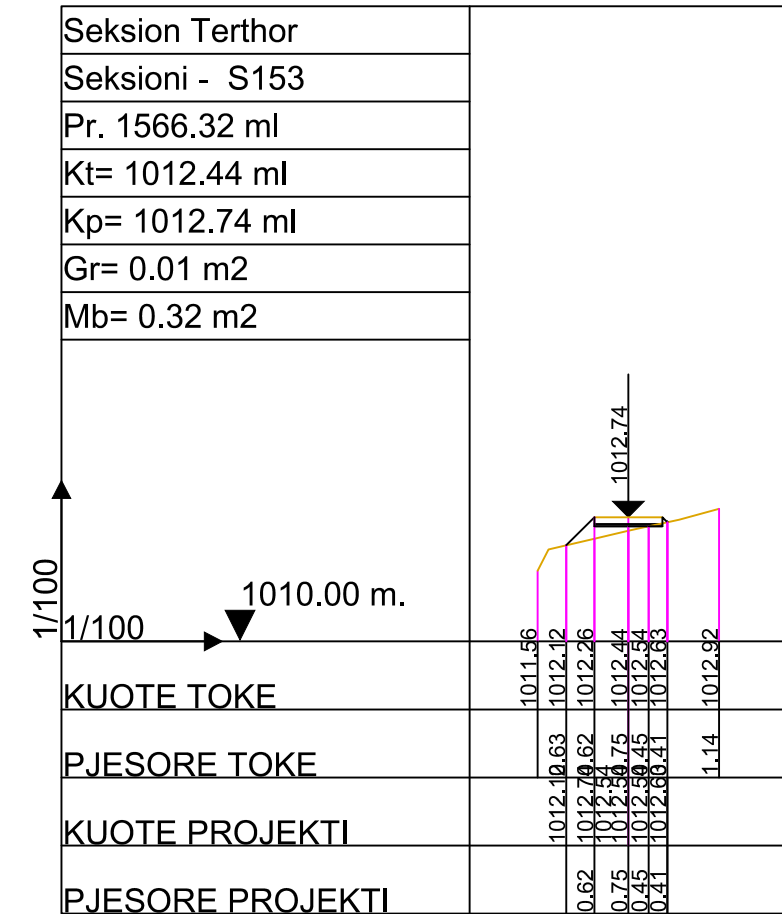
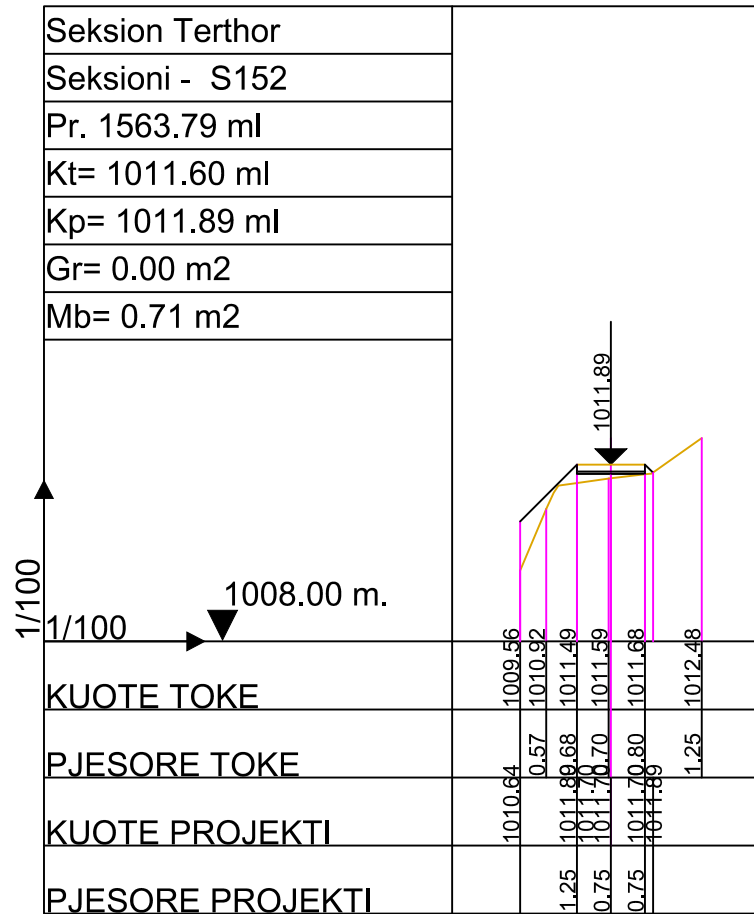
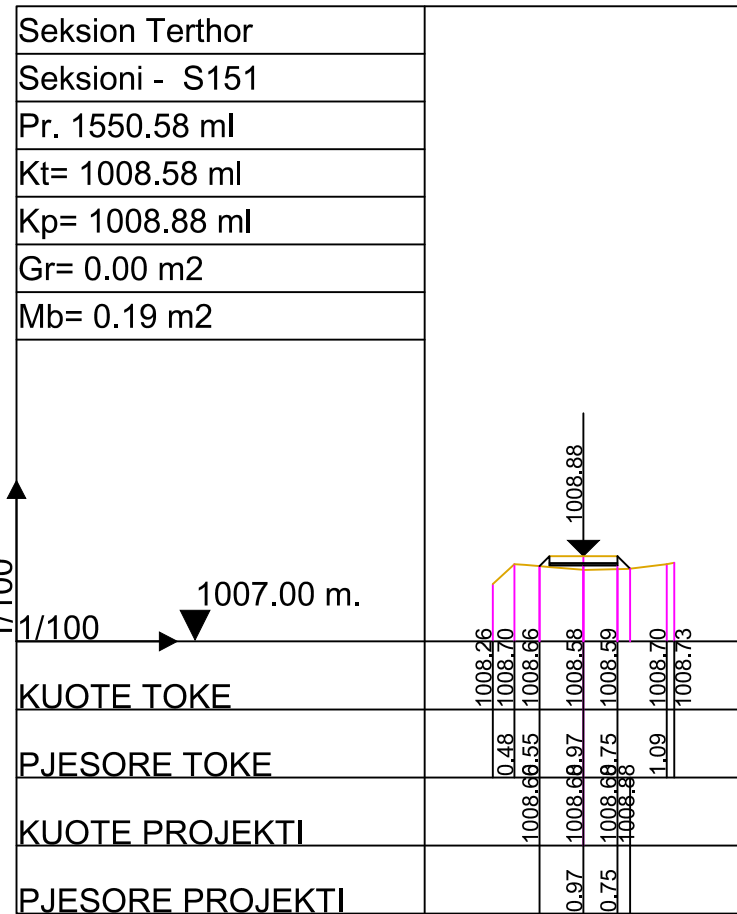

Autoriteit Kontraktor : BASHKIA KRUIJE

Objekti: Rikonstruksion Rruga Kembesore "Kruje - Sarisalltik"

Emertimi: SEKSIONET TERTHORE



"ERALD-G" Sh.p.k  
Adresa: Rruga "Koli Bano", Tirane

Drejgues i projektit

Inxh. Gezim ISLAMI

Projektues

Inxh. Aldo MERKAJ  
Ark. Elton Çarçani  
Hidr. Ersida VERÇANI

Elek. Hajdar KURTI  
Mek. Arben MUHA

SHKALLA

SHK 1:100

Tiranë 2017

FLETA

3 -26

Format A3

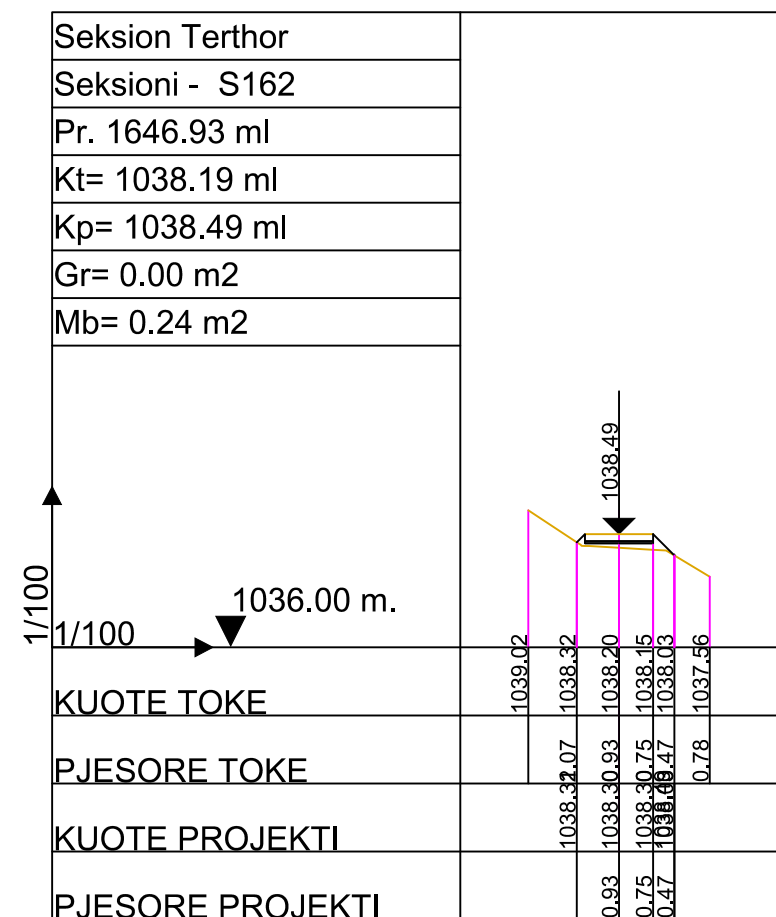
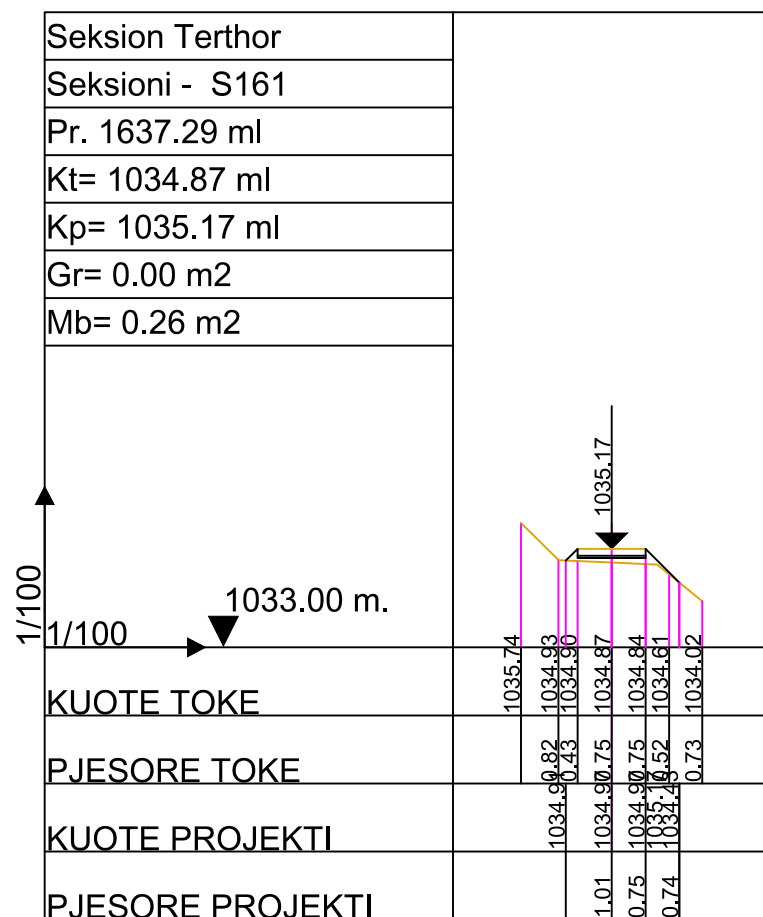
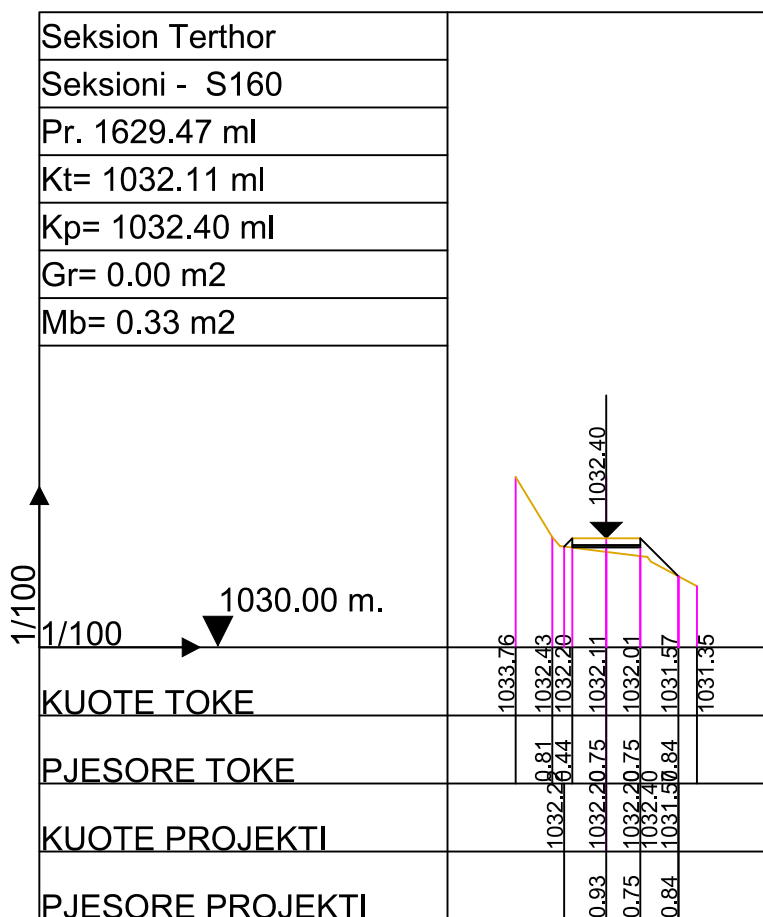
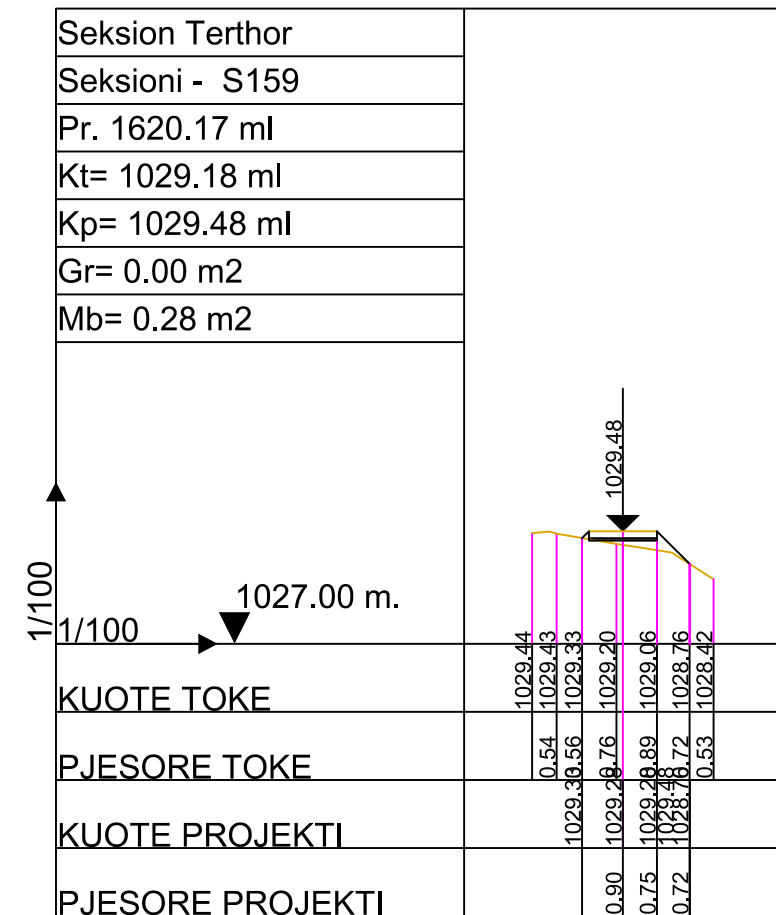
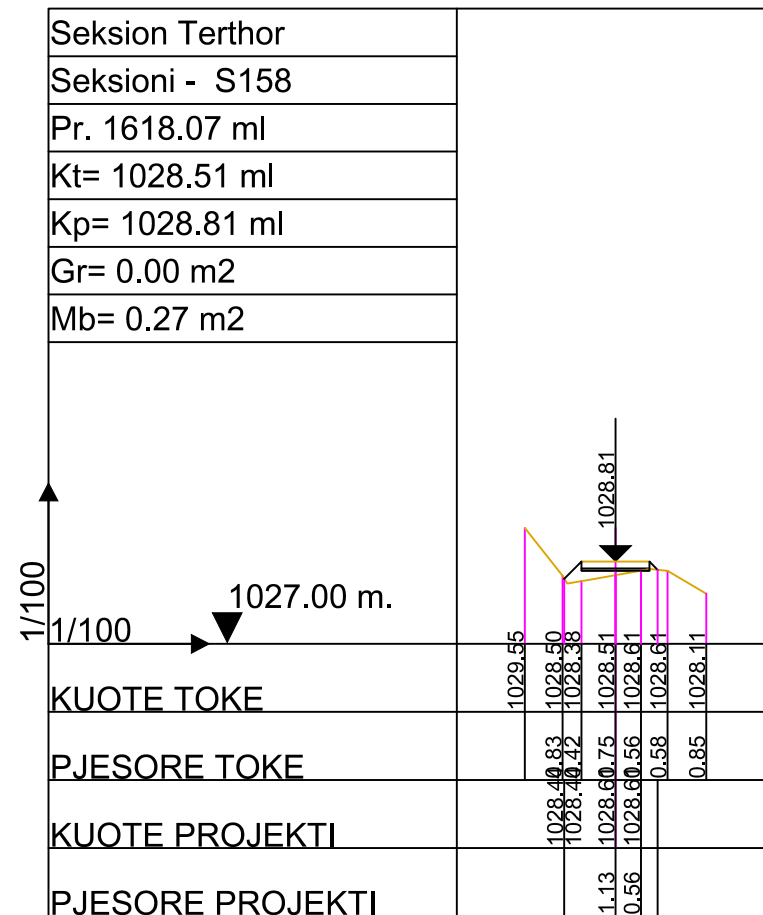
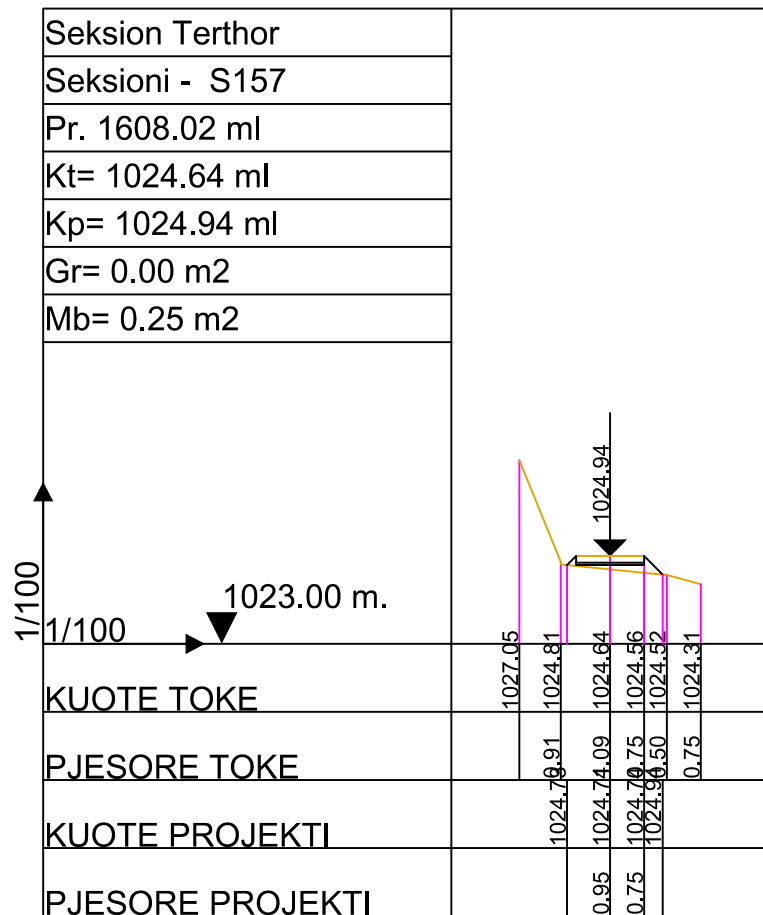

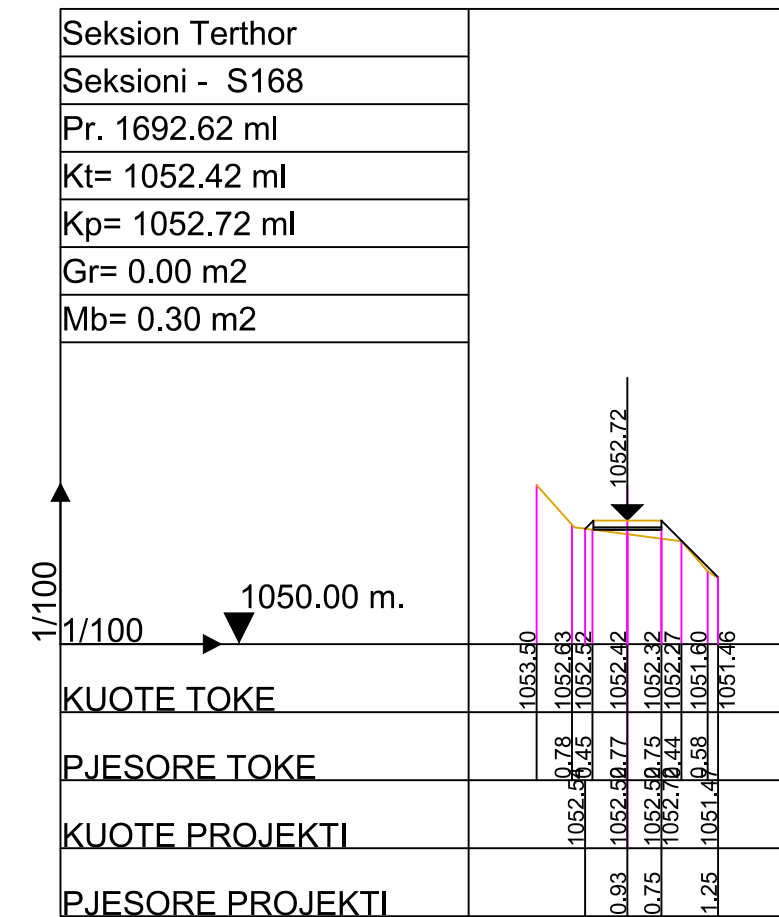
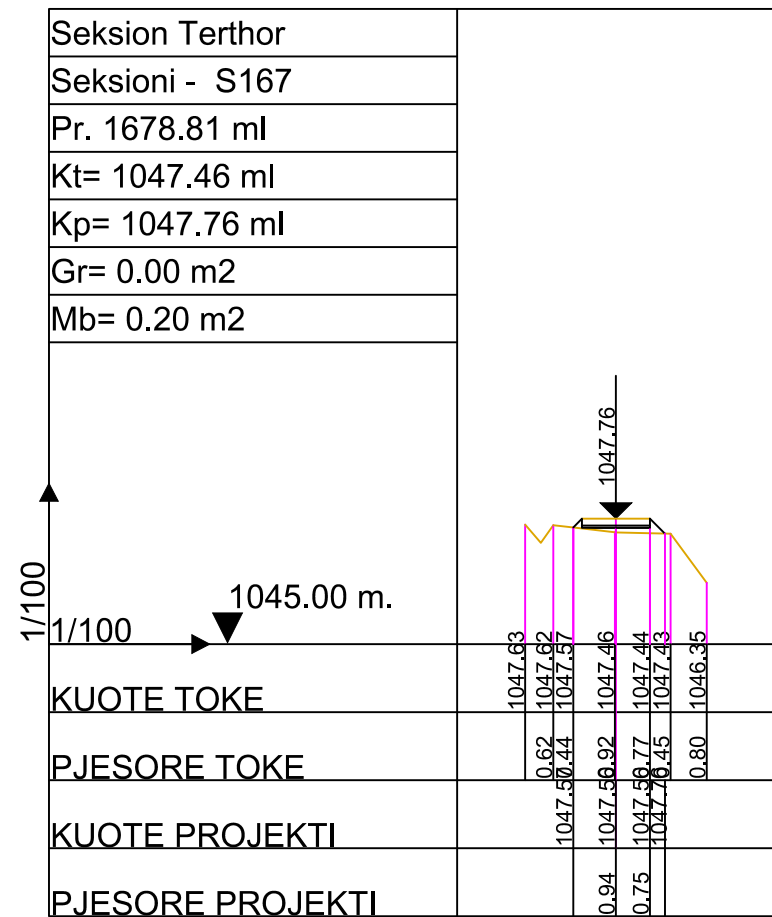
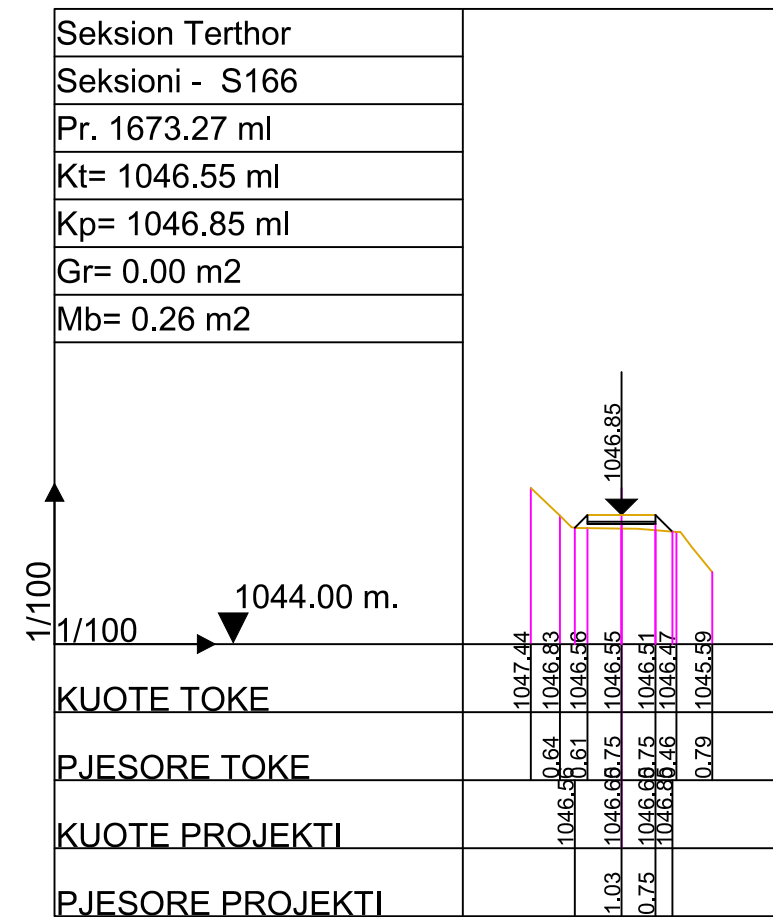
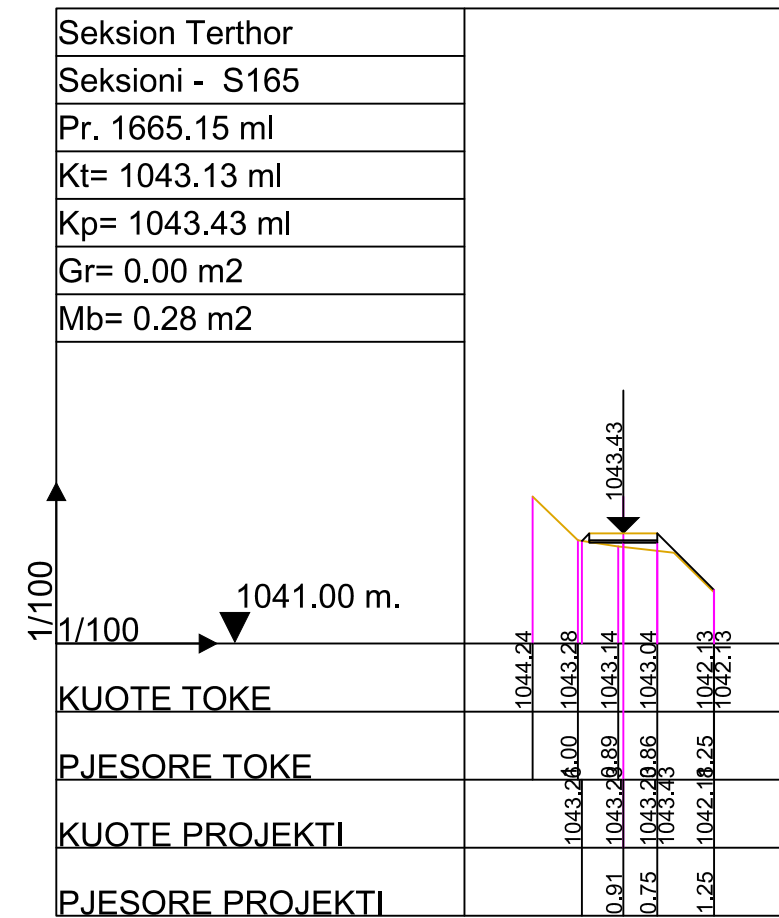
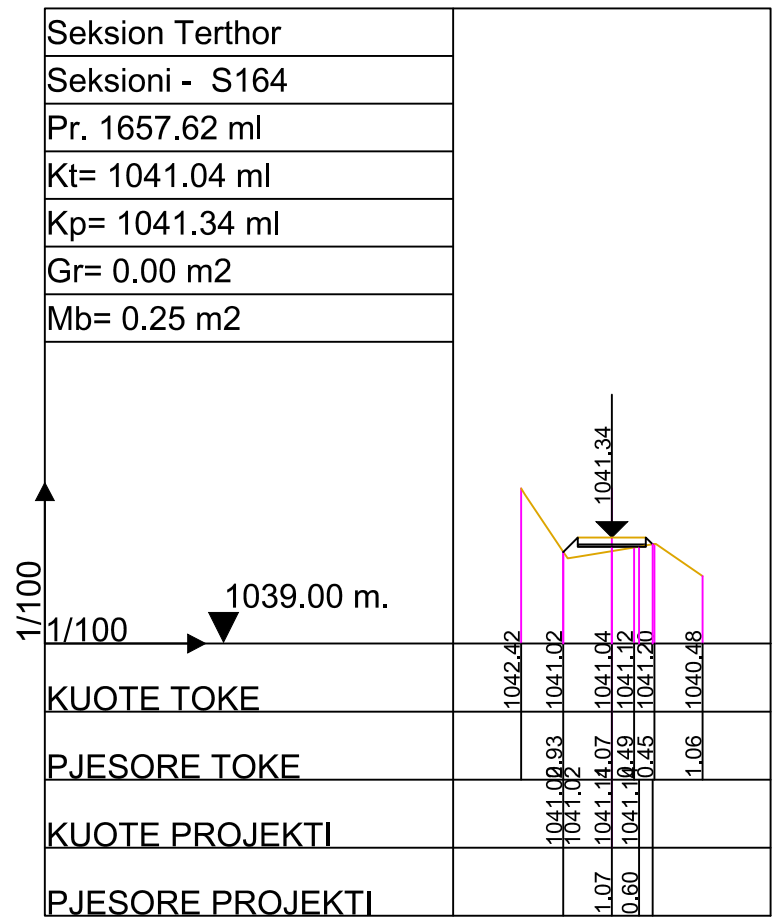
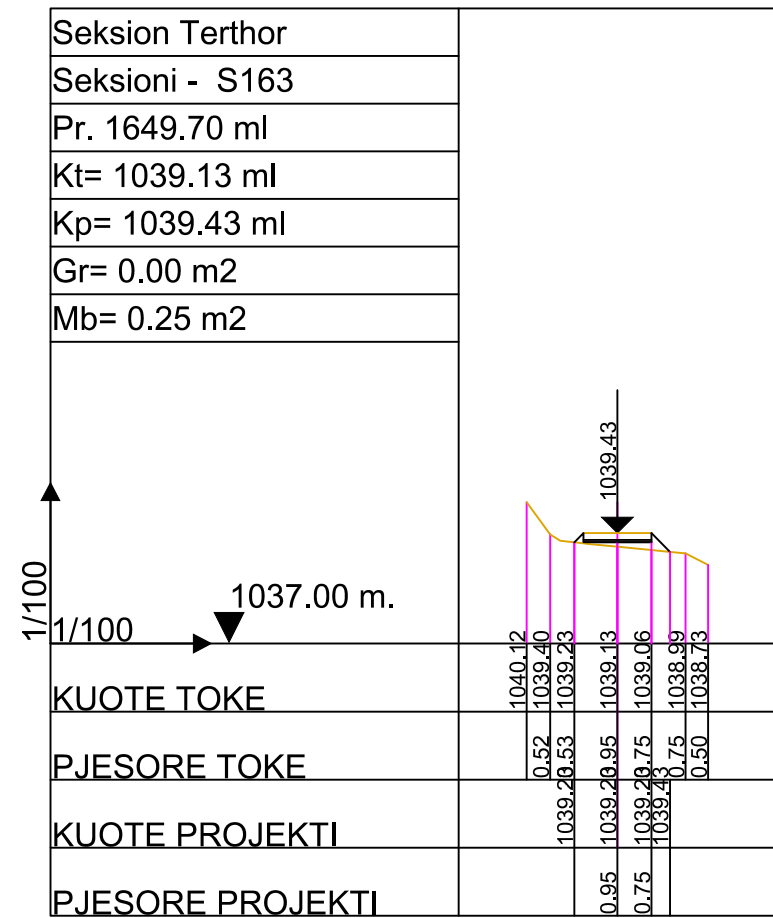

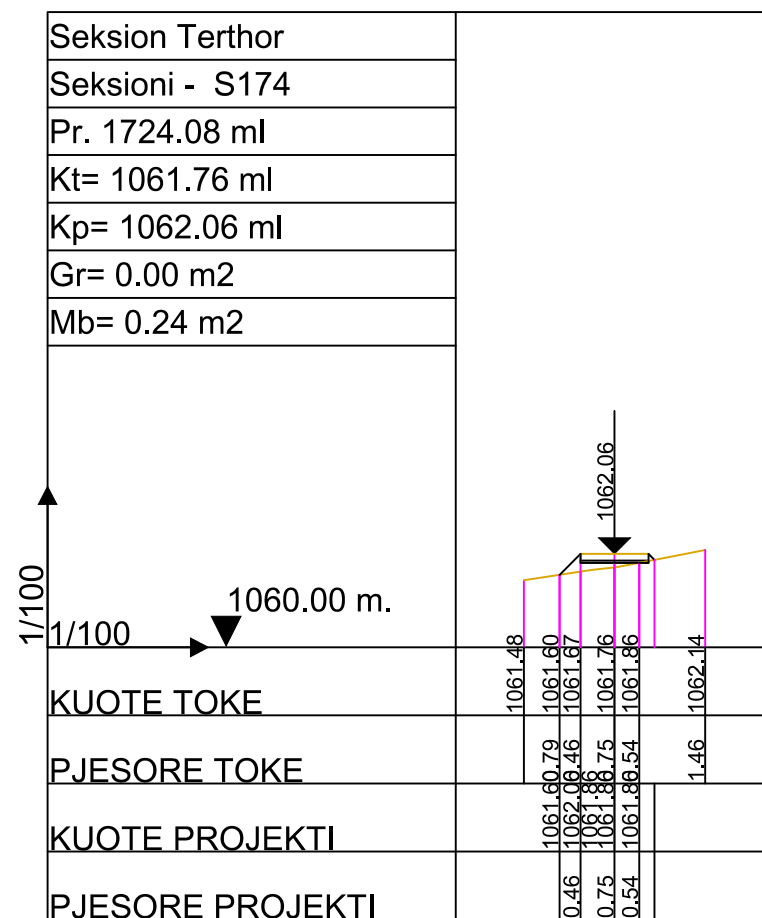
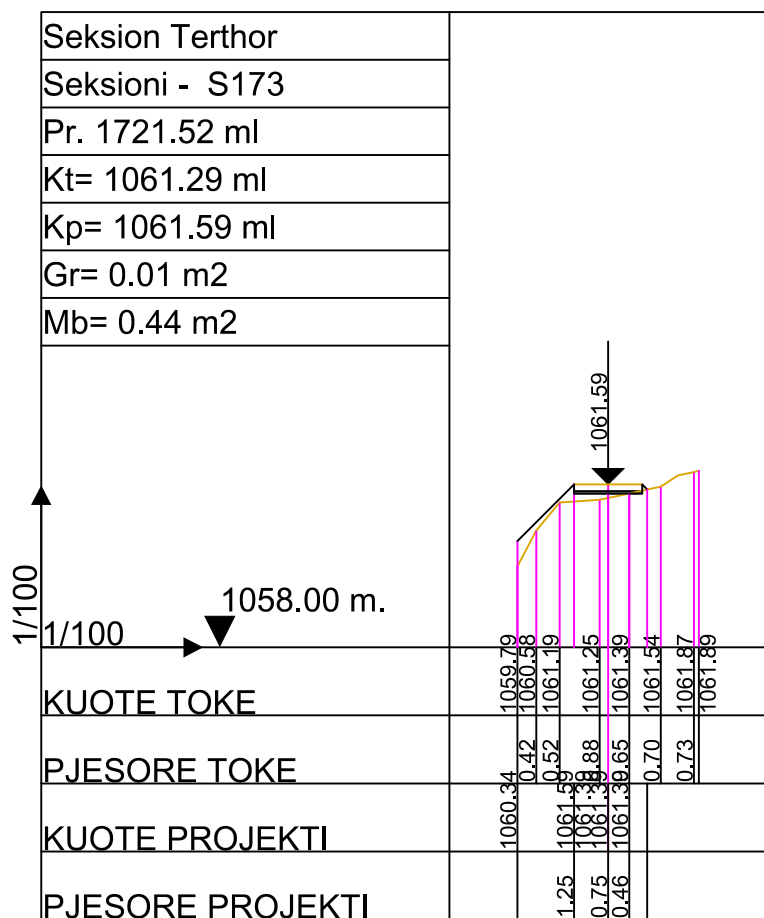
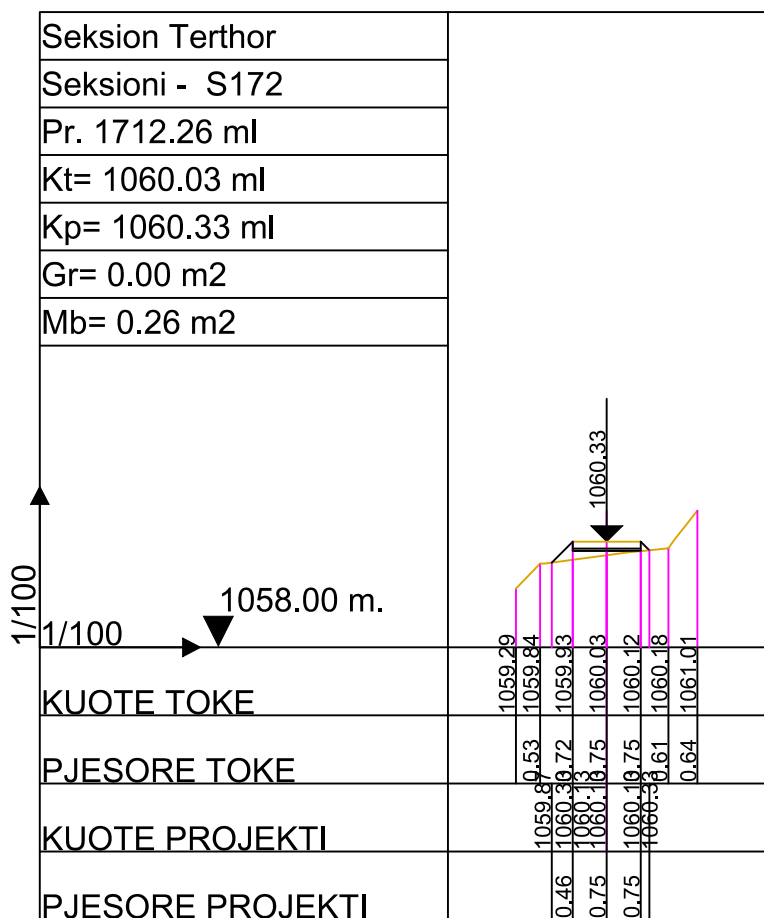
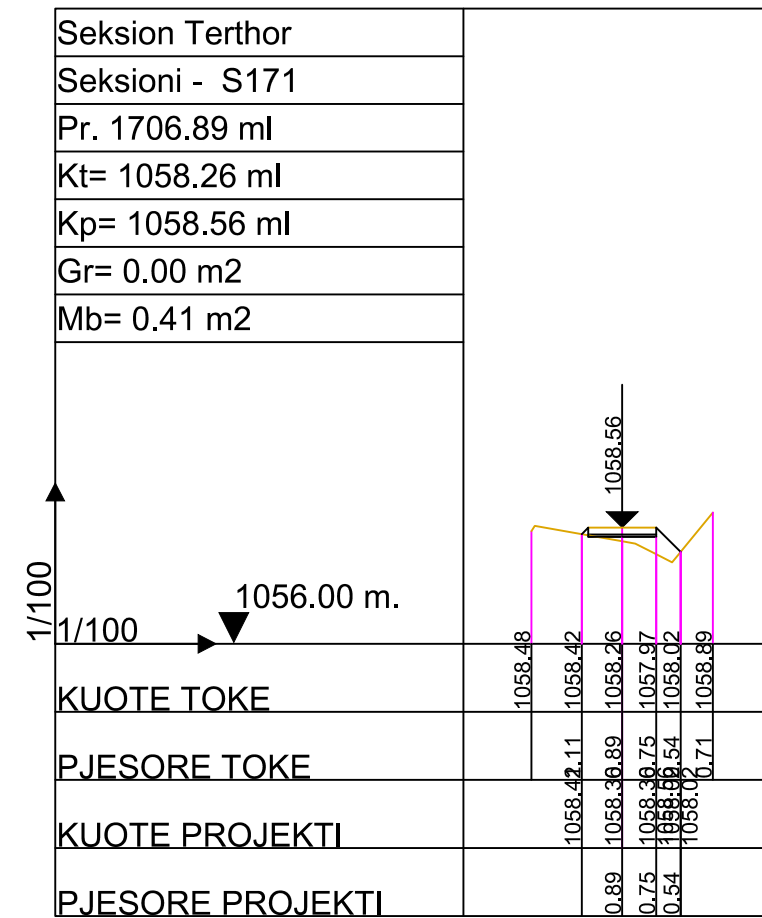
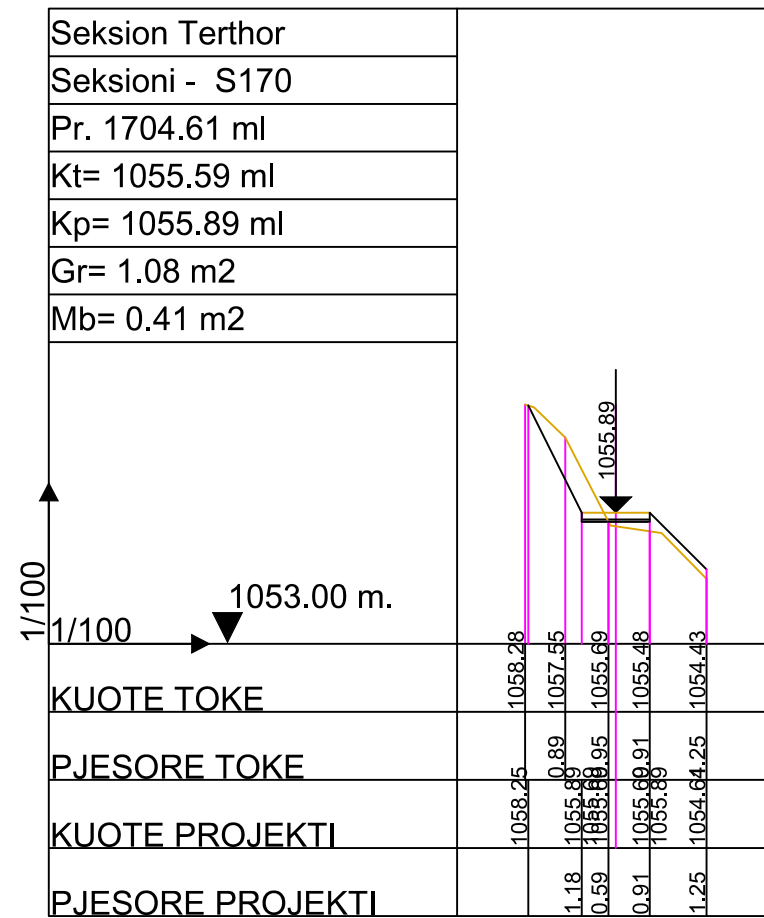
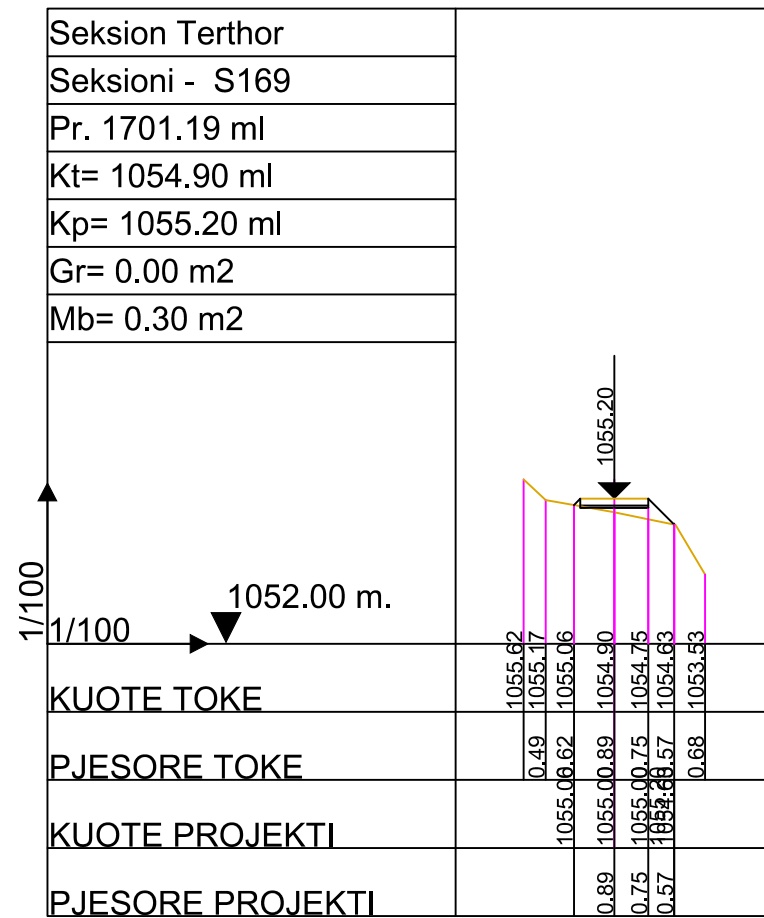

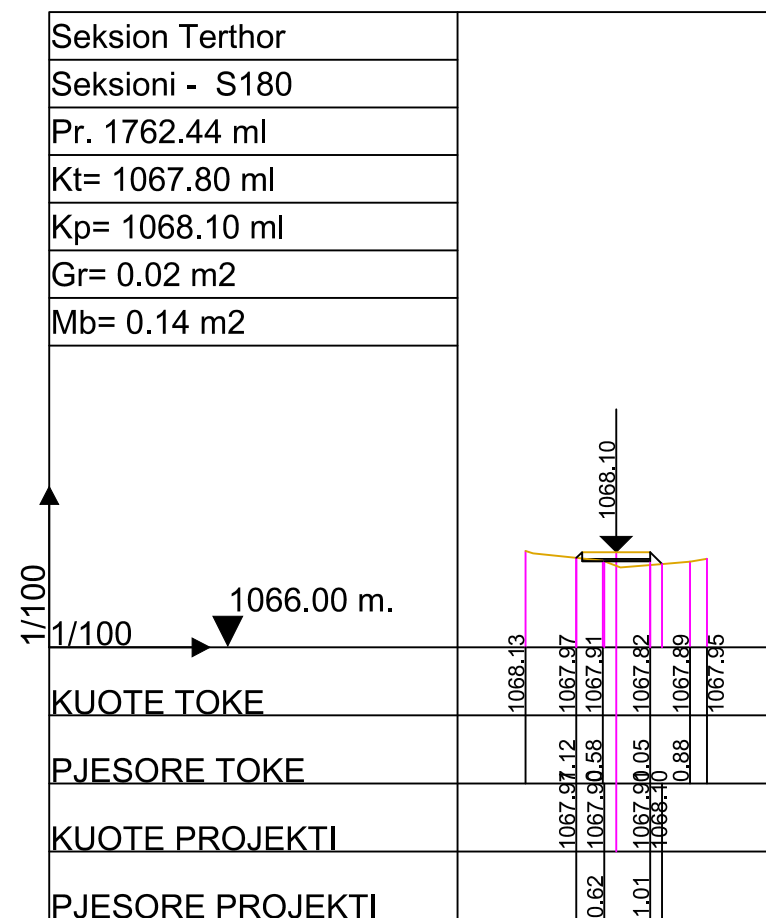
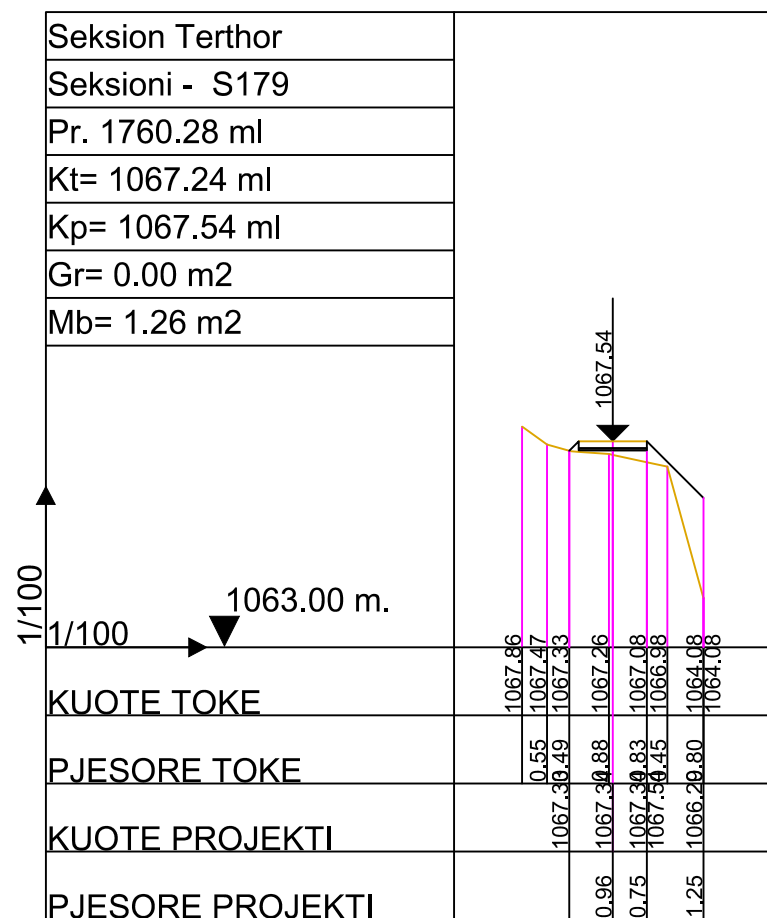
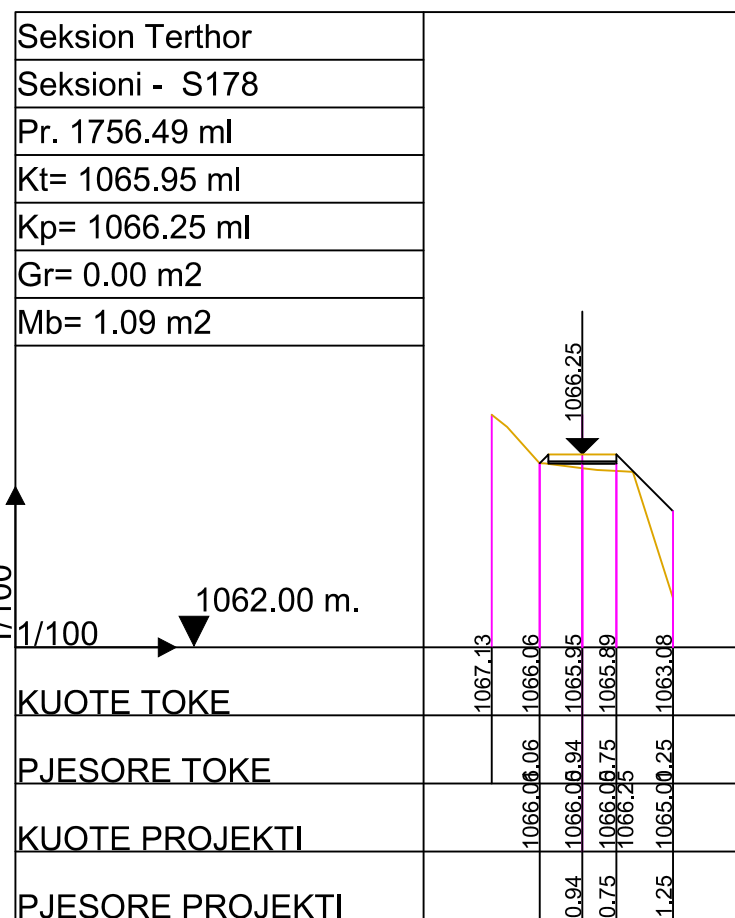
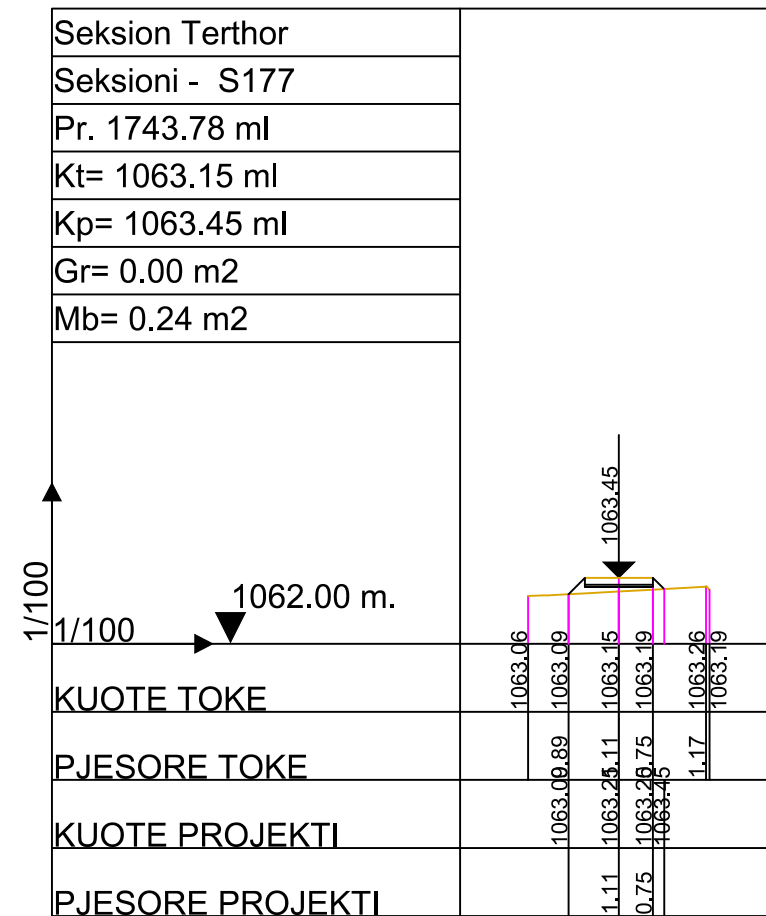
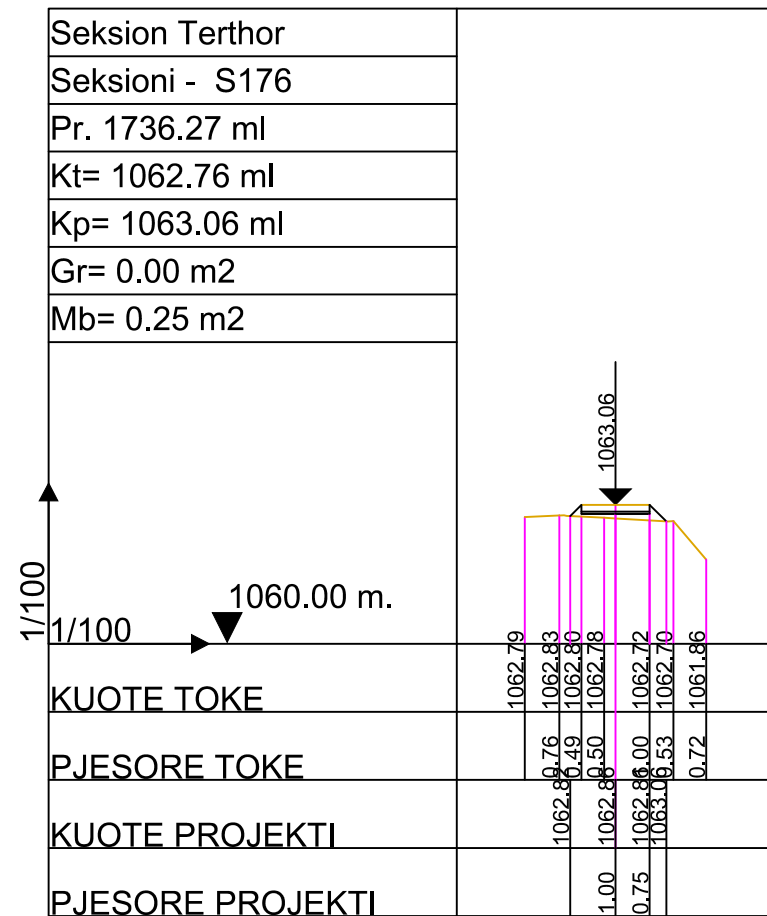
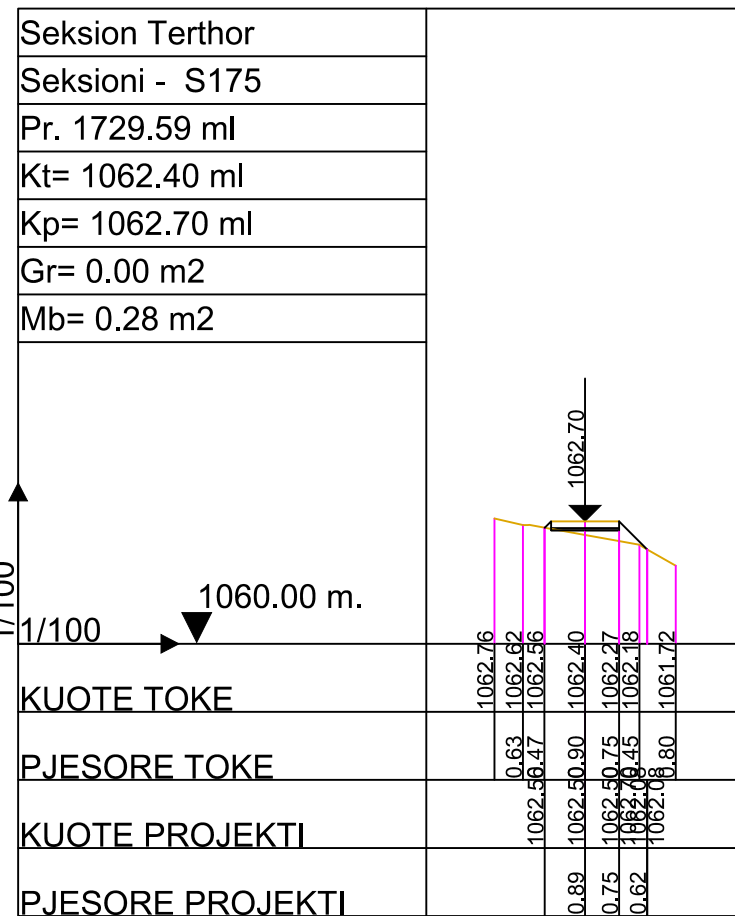

Autoriteit Kontraktor : BASHKIA KRUJE

Objekti: Rikonstruksion Rruga Kembesore "Kruje - Sarisalltik"

Emertimi: SEKSIONET TERTHORE



"ERALD-G" Sh.p.k

Adresa: Rruga "Koli Bano", Tirane

Drejtes i projektit

Inxh. Gezim ISLAMI

Projektues

Inxh. Aldo MERKAJ

Ark. Elton Çarçani

Hidr. Ersida VERÇANI

Elek. Hajdar KURTI

Mek. Arben MUHA

SHKALLA

SHK 1:100

Tiranë 2017

FLETA

3 -30

Format A3

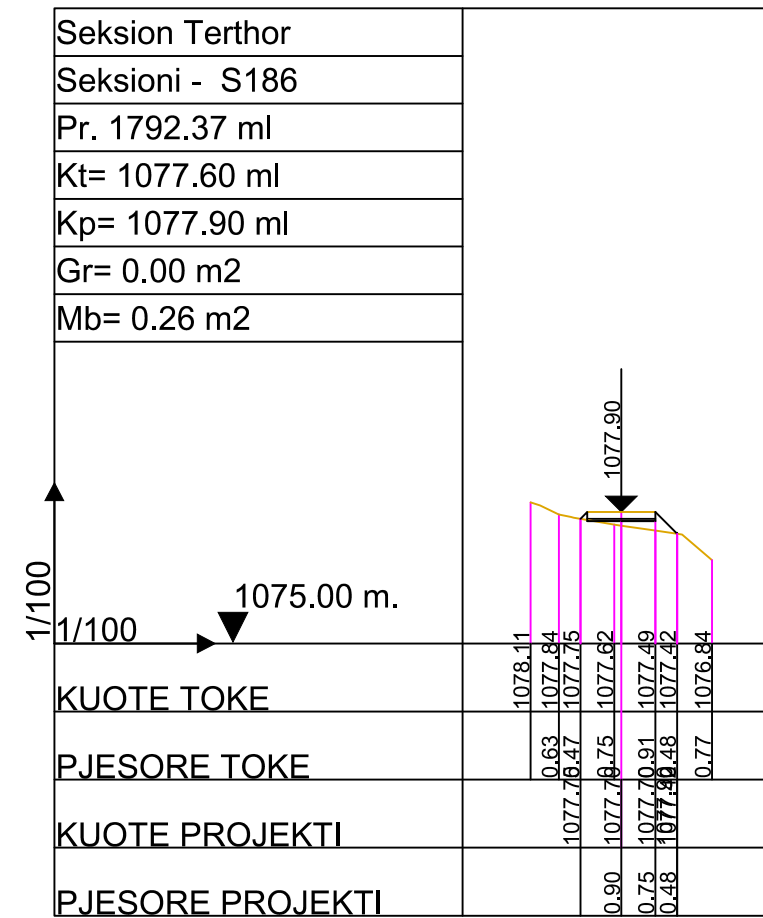
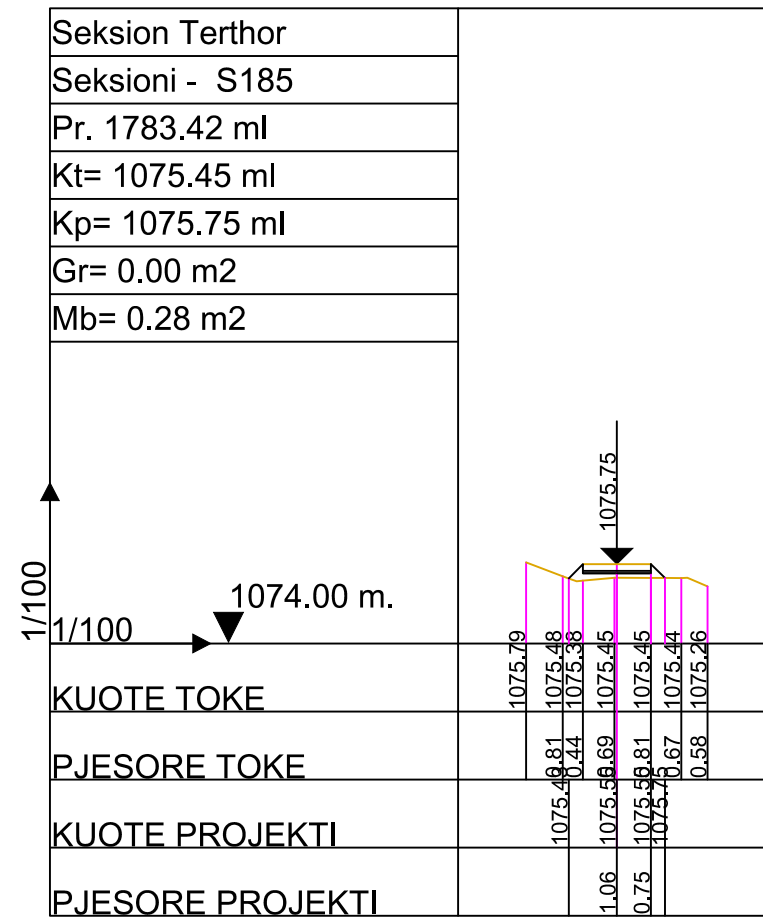
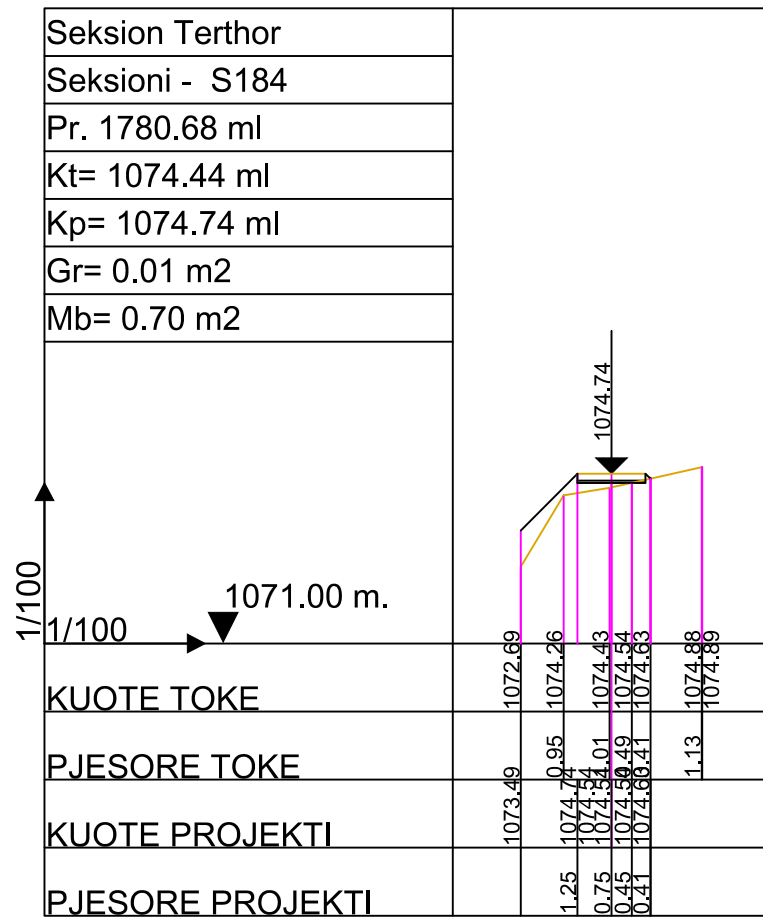
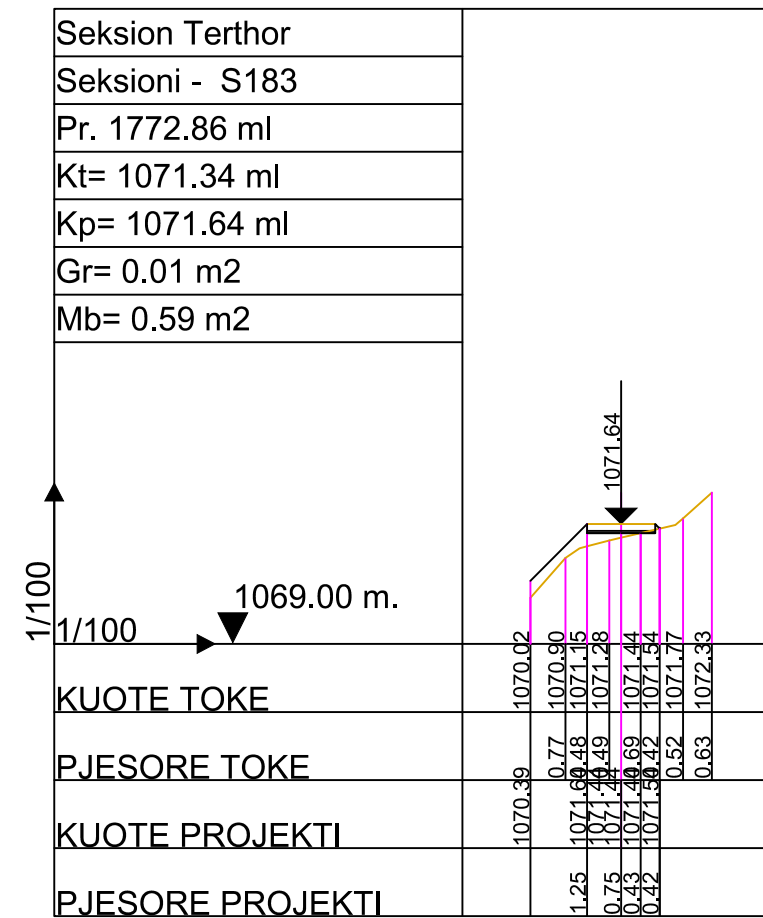
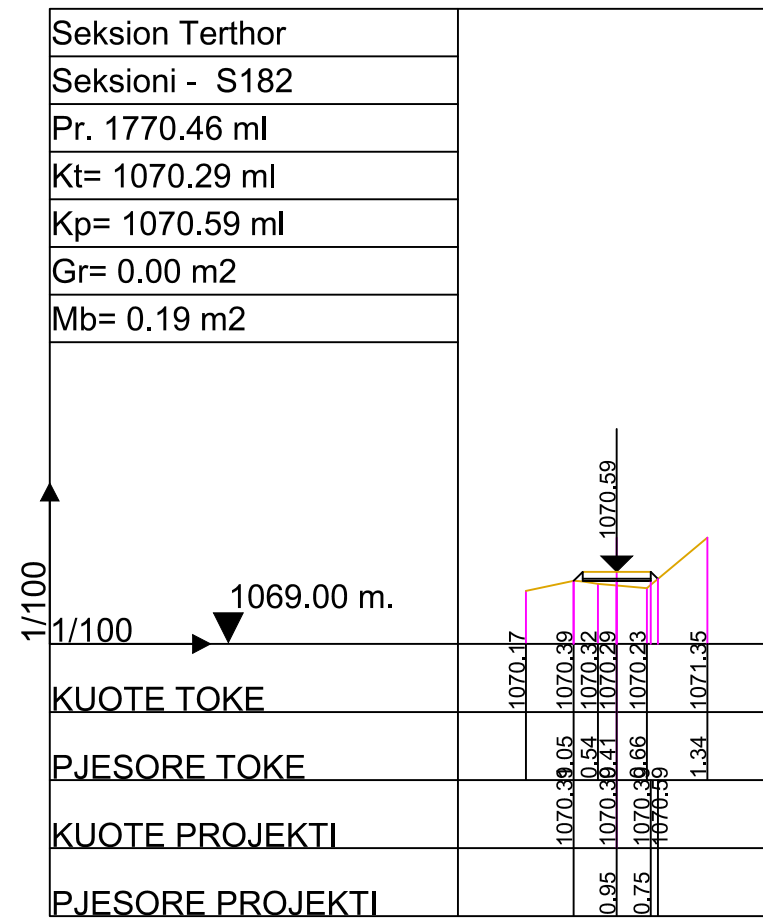
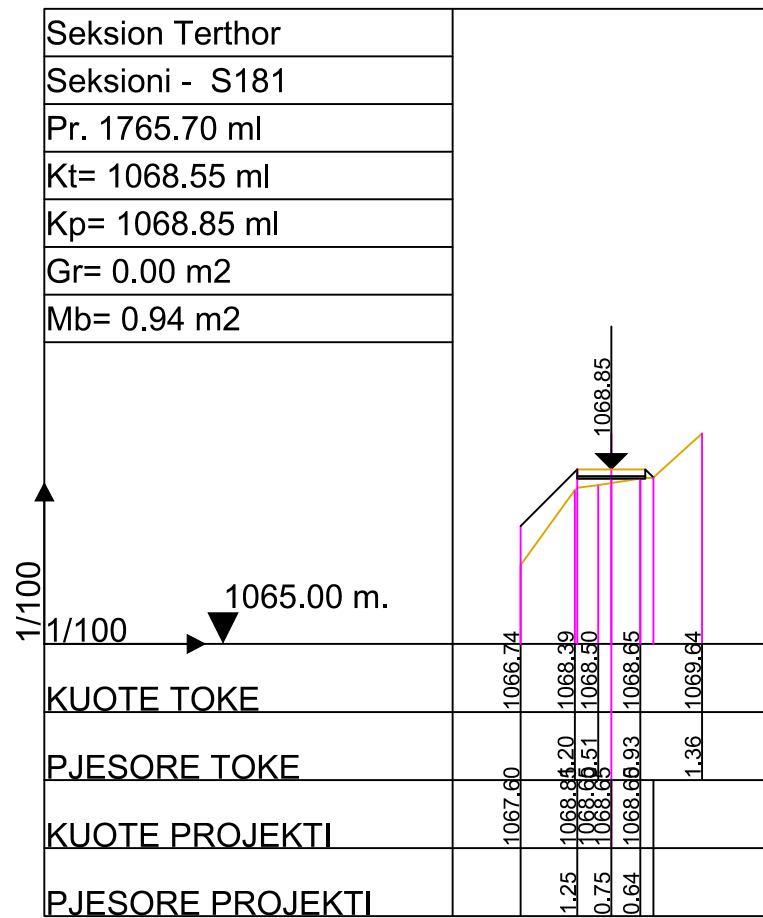

Autoriteit Kontraktor : BASHKIA KRUJE

Objekti: Rikonstruksion Rruga Kembesore "Kruje - Sarisalltik"

Emertimi: SEKSIONET TERTHORE



"ERALD-G" Sh.p.k  
Adresa: Rruga "Koli Bano", Tirane

Drejtes i projektit

Inxh. Gezim ISLAMI

Projektues

Inxh. Aldo MERKAJ  
Ark.Elton Çarçani  
Hidr. Ersida VERÇANI

Elek. Hajdar KURTI  
Mek. Arben MUHA

SHKALLA

SHK 1:100

Tiranë 2017

FLETA

3 -31

Format A3



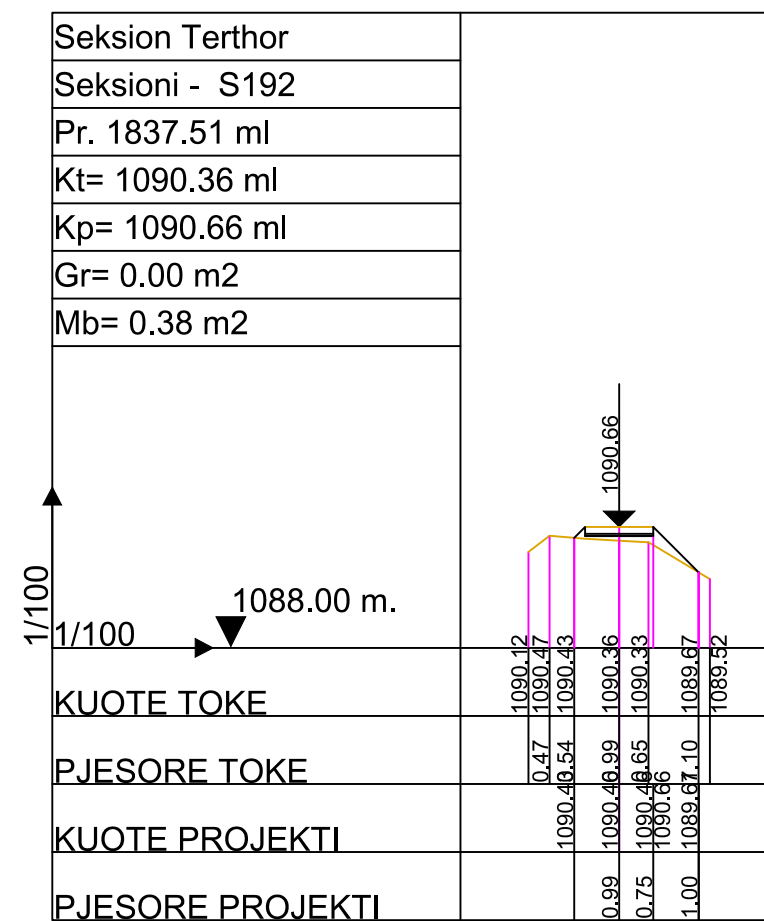
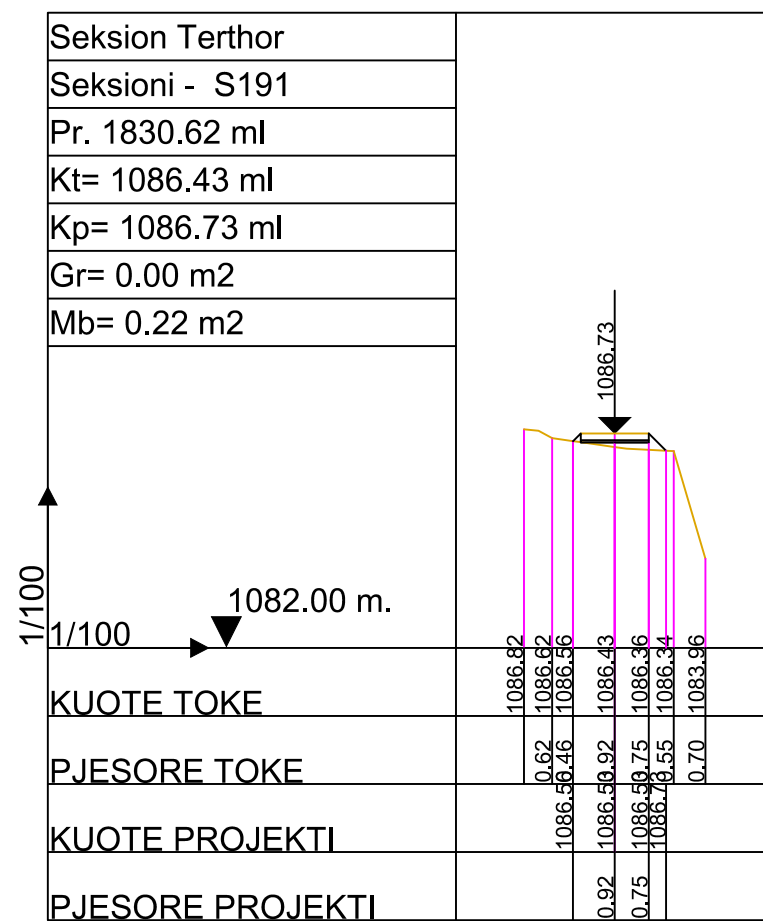
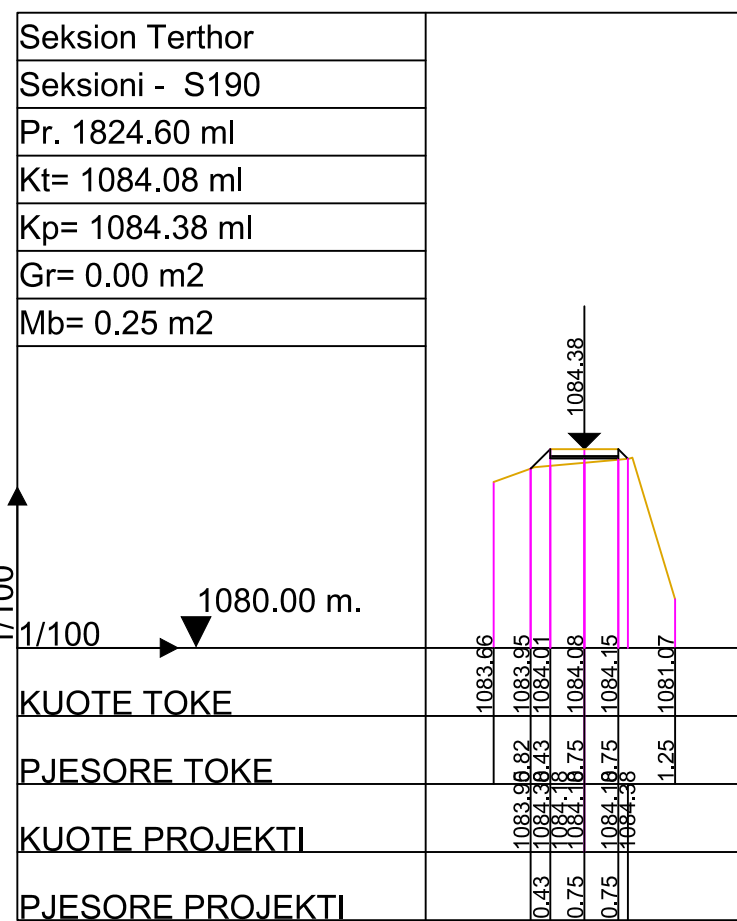
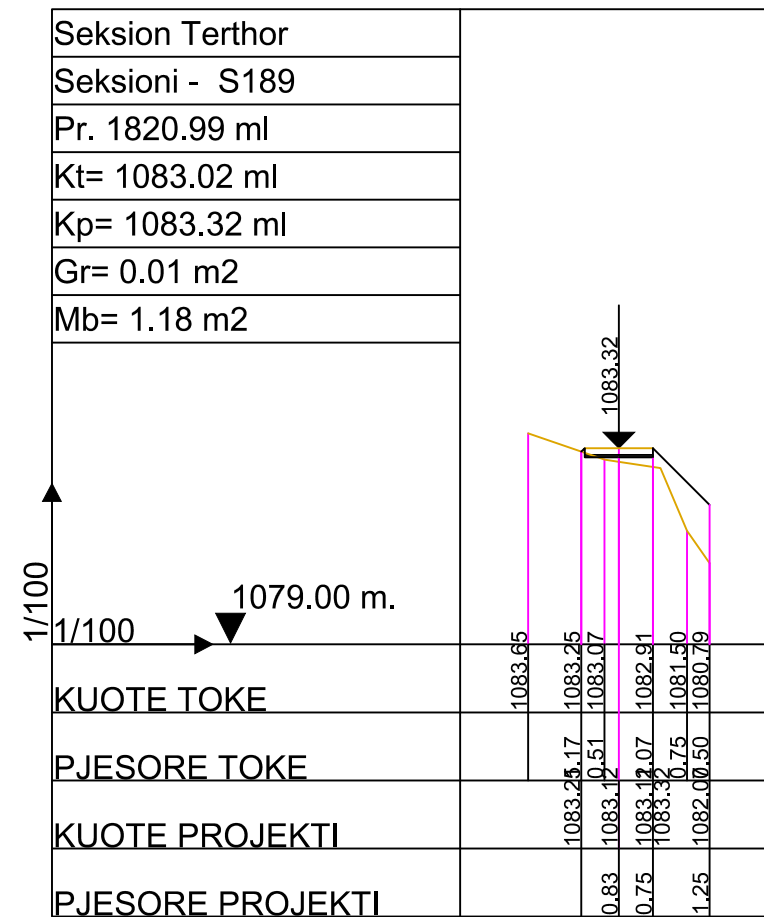
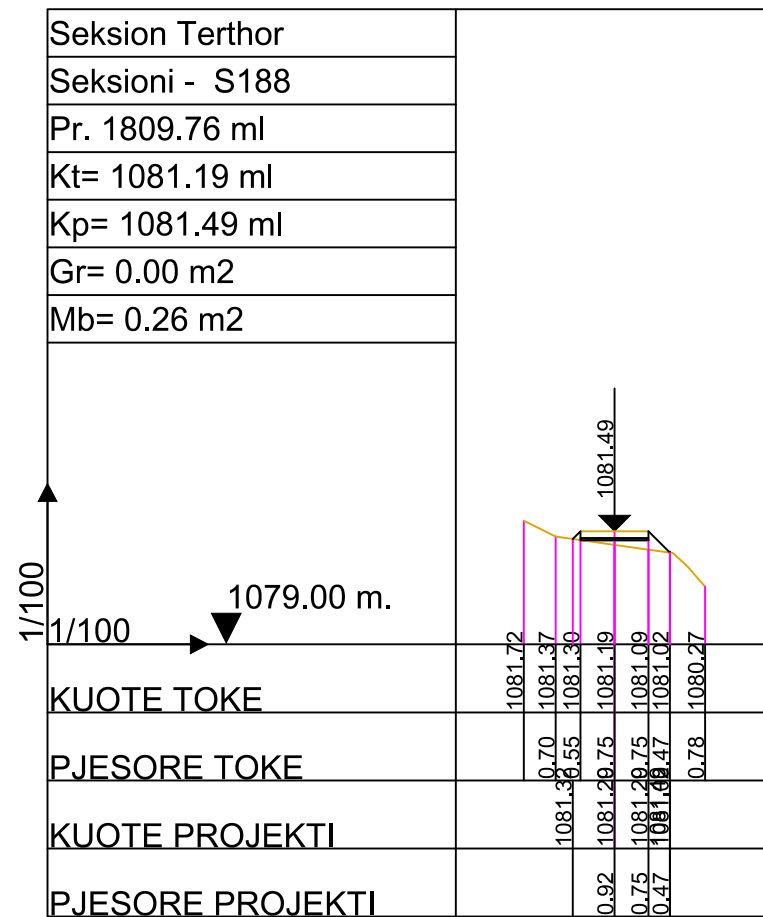
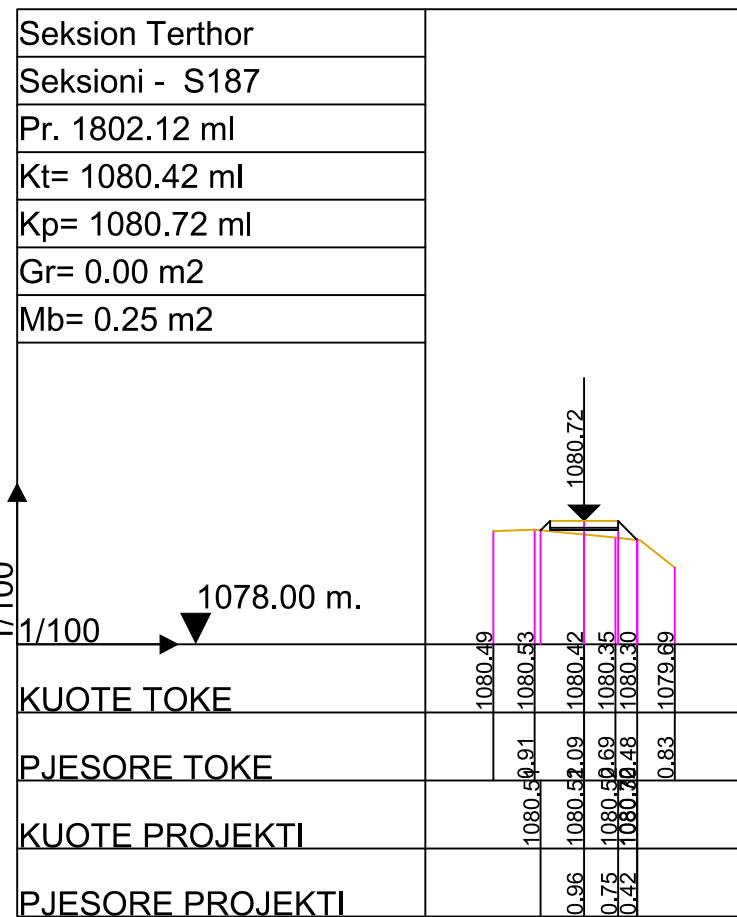

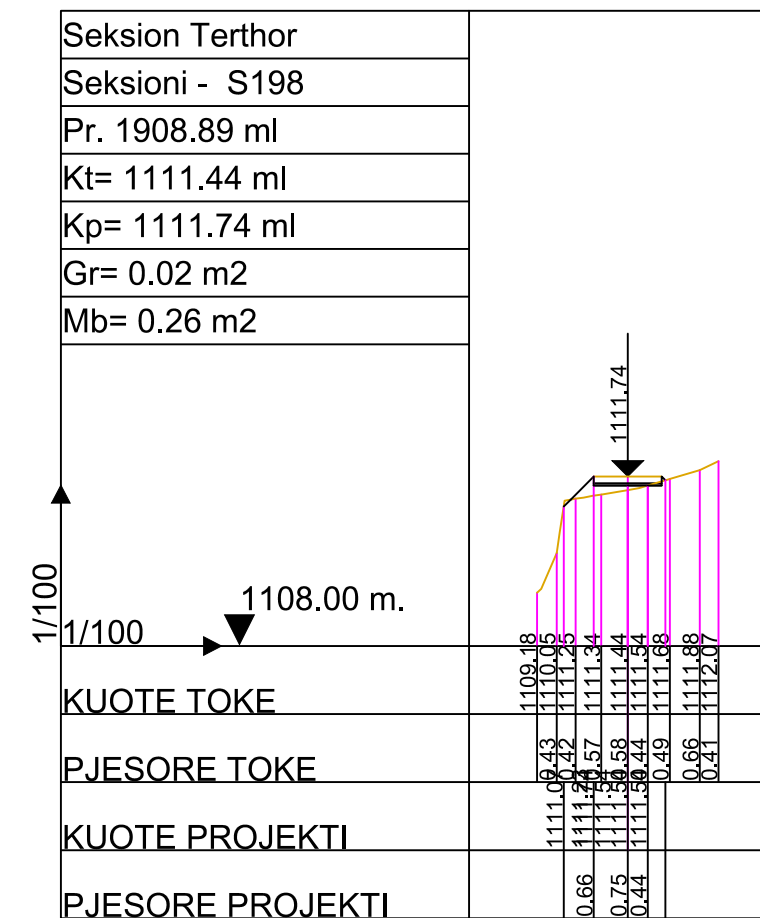
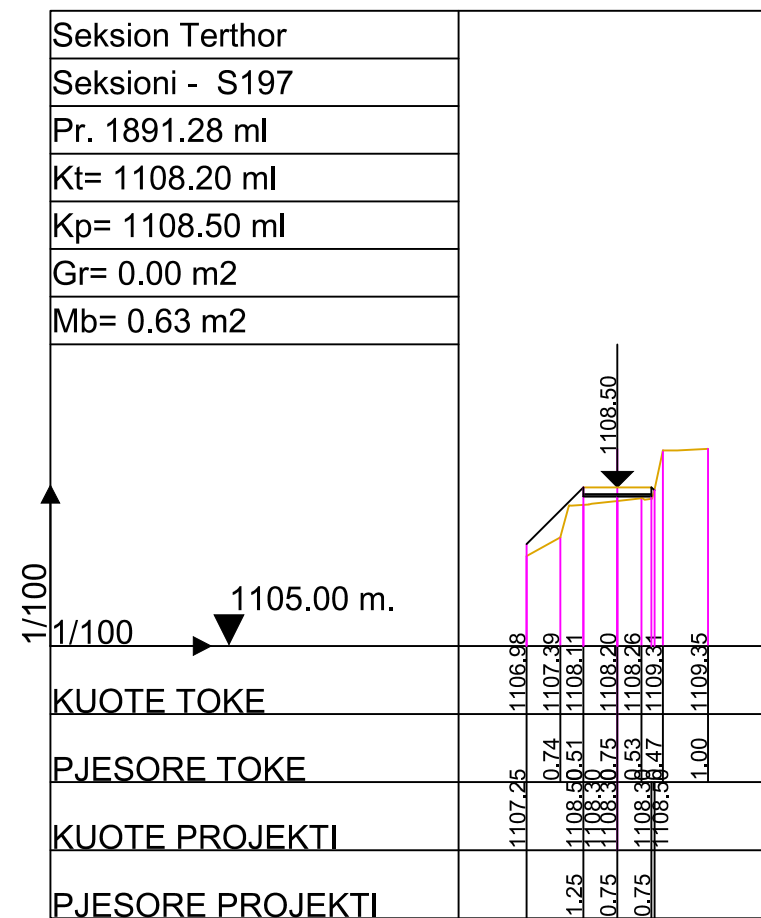
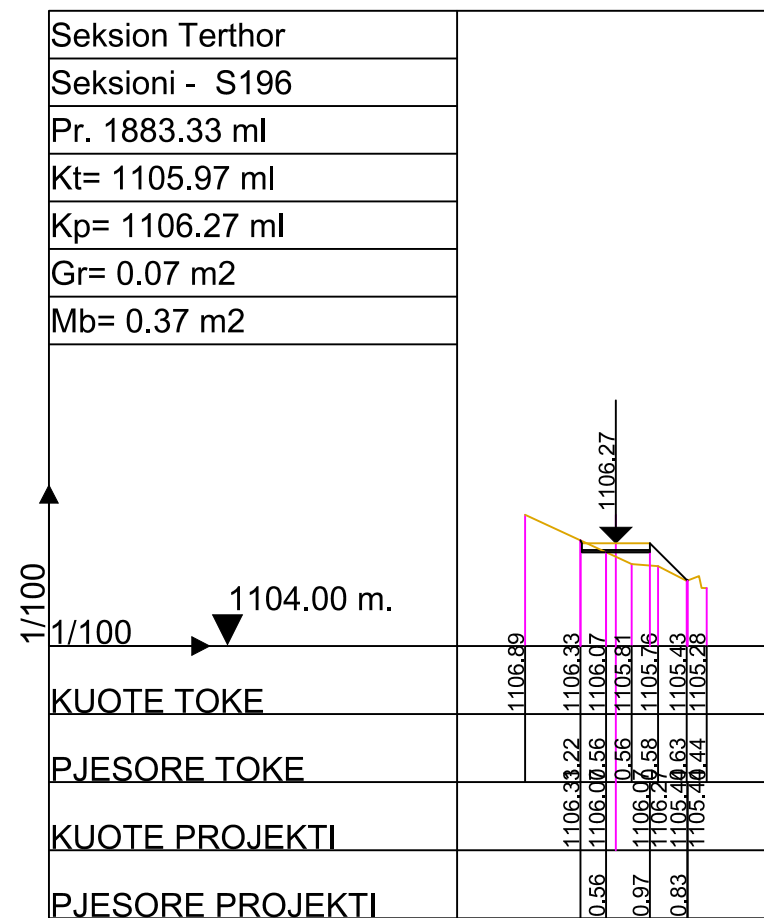
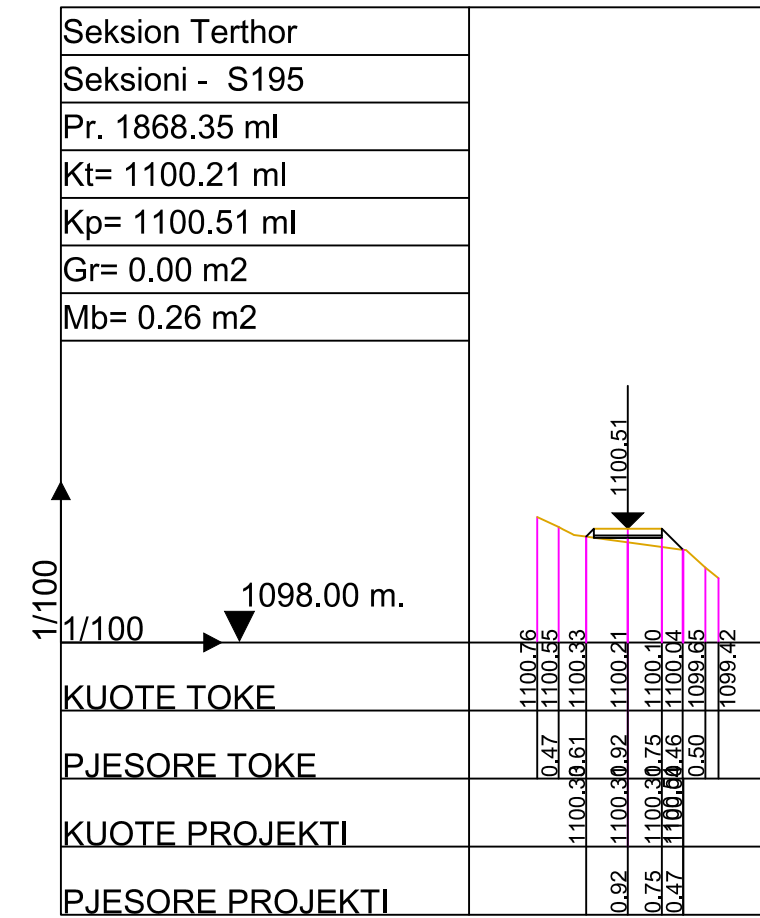
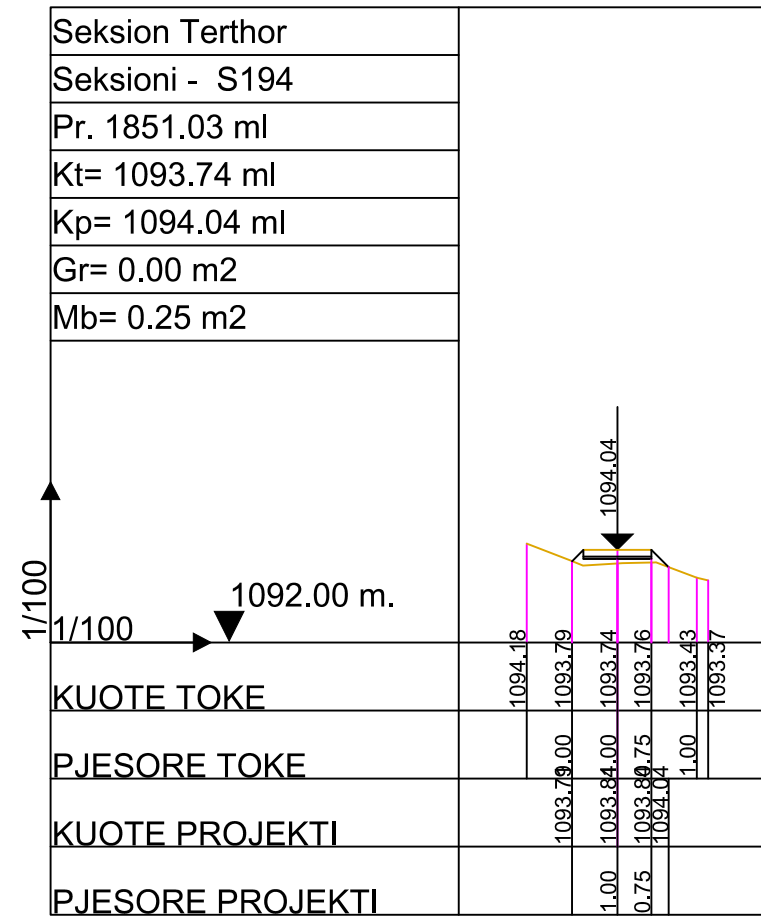
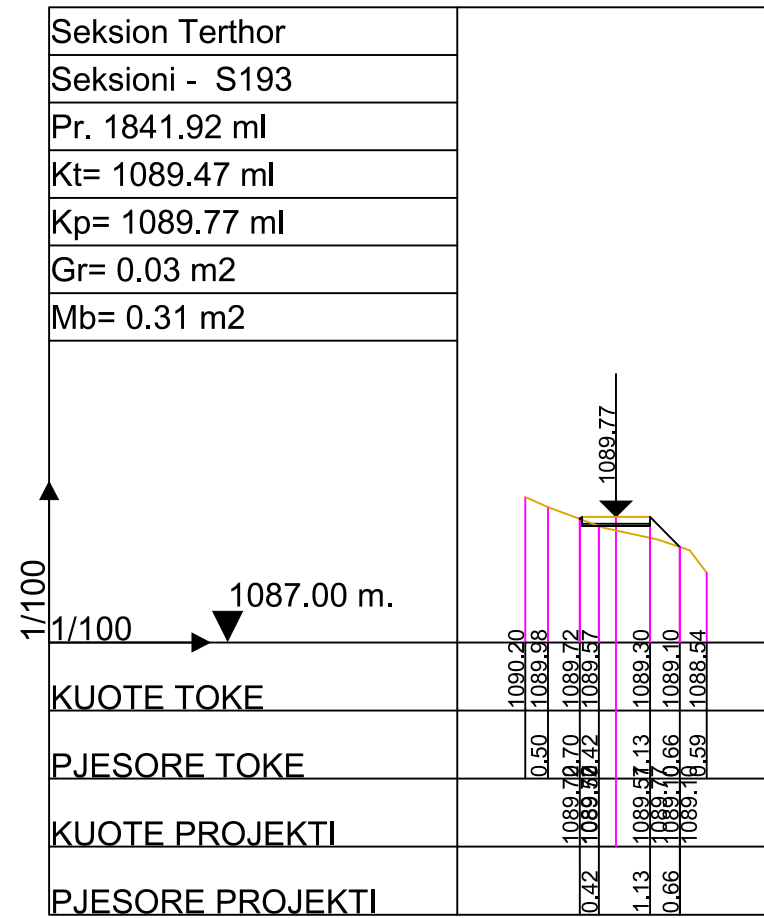

Autoriteit Kontraktor : BASHKIA KRUJE

Objekti: Rikonstruksion Rruga Kembesore "Kruje - Sarisalltik"

Emertimi: SEKSIONET TERTHORE



"ERALD-G" Sh.p.k  
Adresa: Rruga "Koli Bano", Tirane

Drejtes i projektit

Inxh. Gezim ISLAMI

Projektues

Inxh. Aldo MERKAJ  
Ark. Elton Çarçani  
Hidr. Ersida VERÇANI

Elek. Hajdar KURTI  
Mek. Arben MUHA

SHKALLA

SHK 1:100

Tiranë 2017

FLETA

3 -33

Format A3