

# SHESHI PRANE BASHKISE

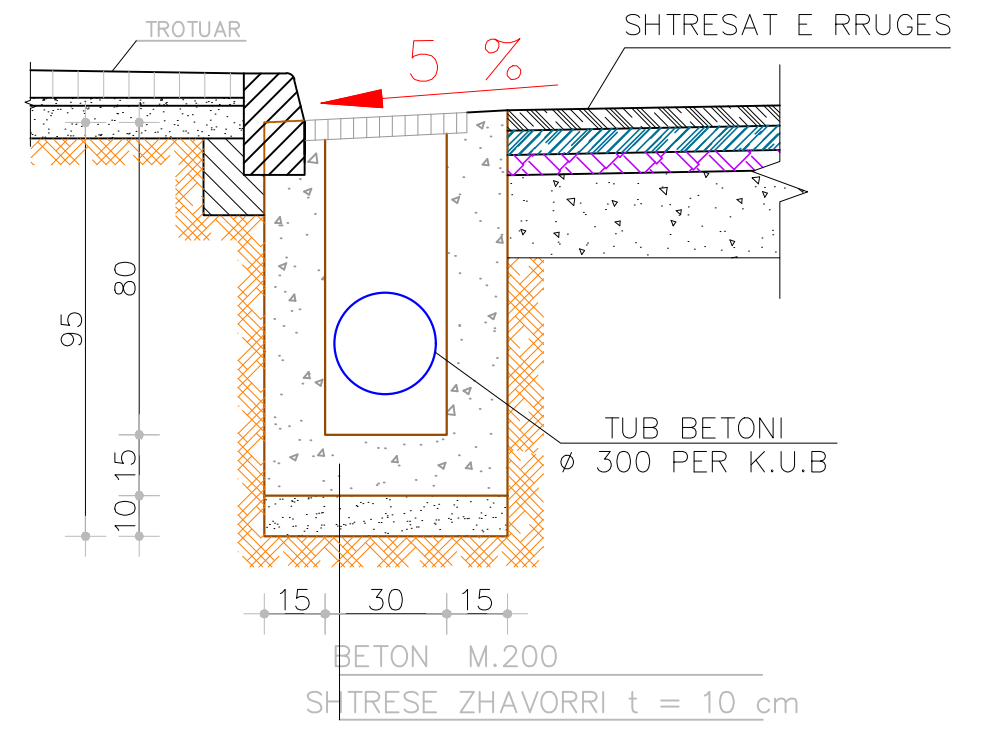

 REPUBLIKA E SHQIPERISE BASHKIA KRUJE	PROJEKT ZBATIMI "RIKUALIFIKIM URBAN I SHESHEVE TE PALLATEVE TE SHEMBURA NE TERRITORIN E NJESISE ADMINISTRATIVE FUSHE KRUJE"	DETAJE	PROJEKTUES:	"ERALD G" shpk	FLETA 04
			SHKALLA	1: __	2022

# SHESHI PRANE BASHKISE

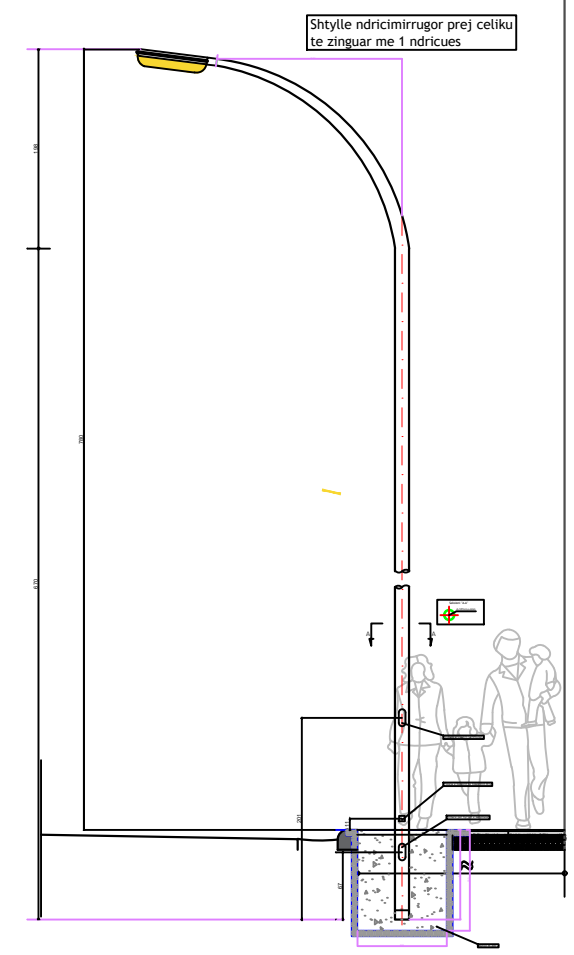
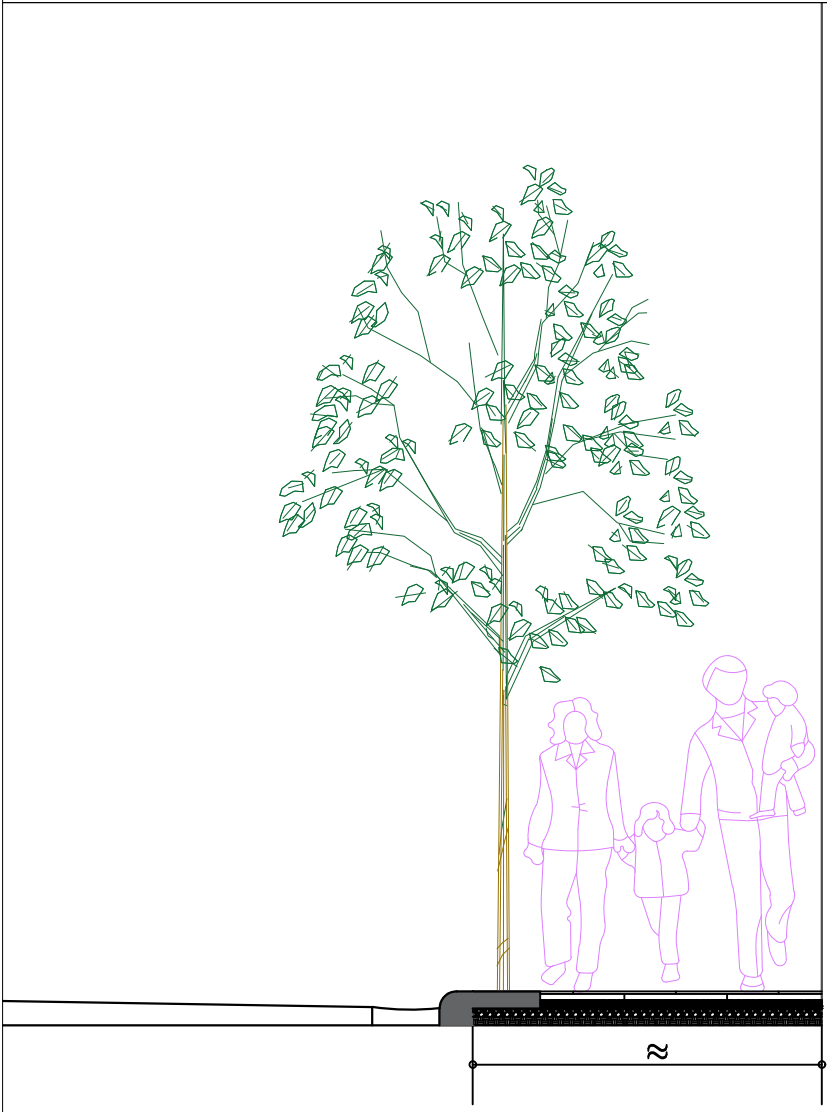
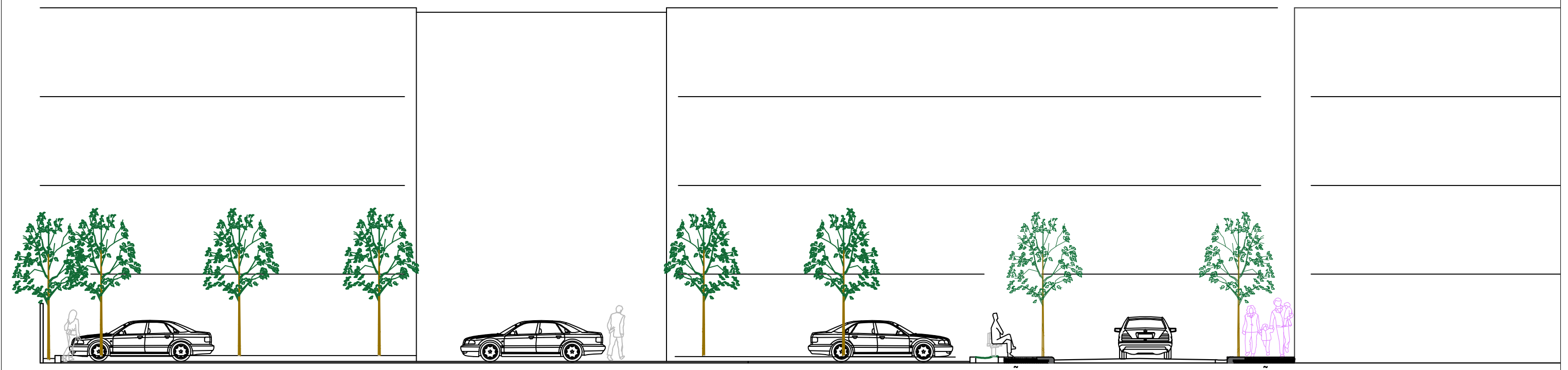
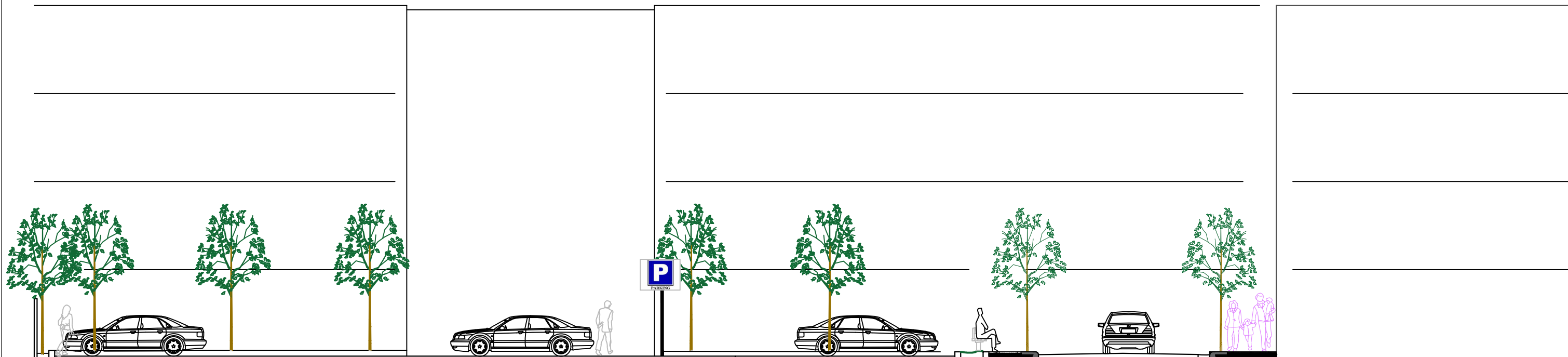
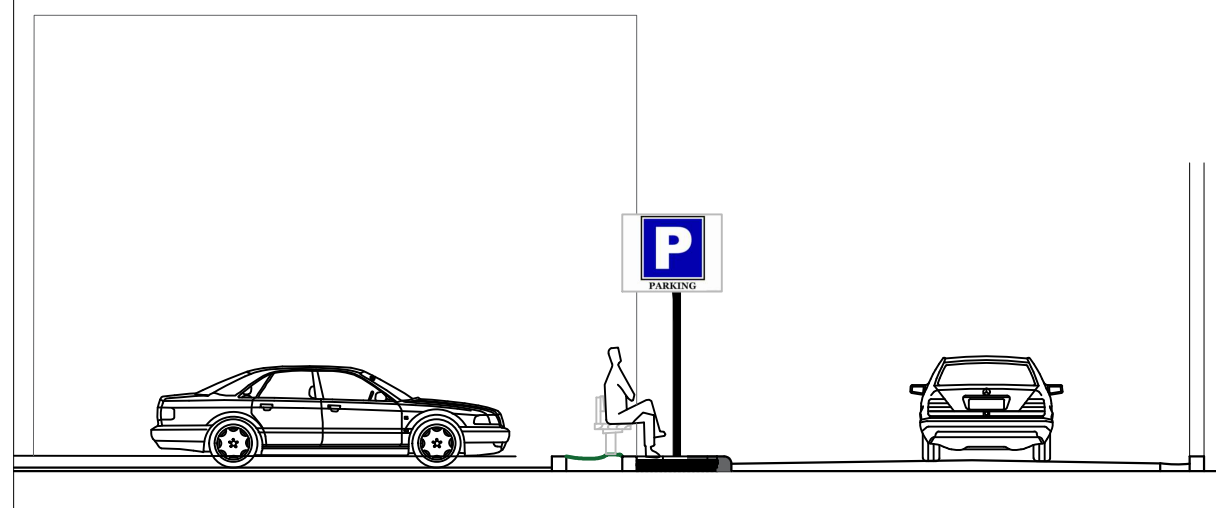
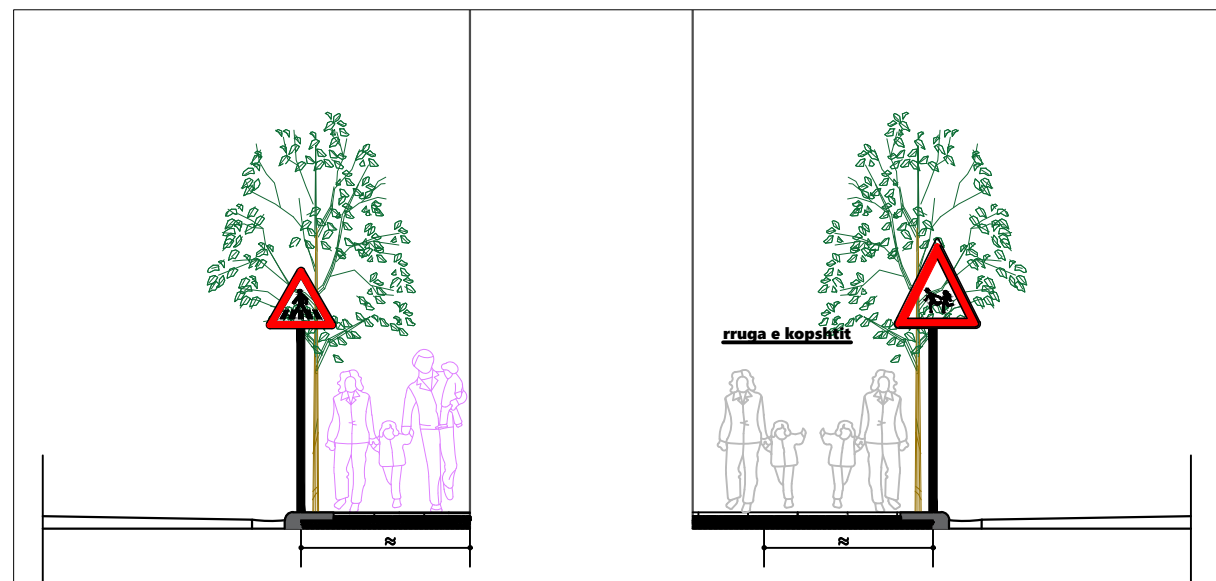
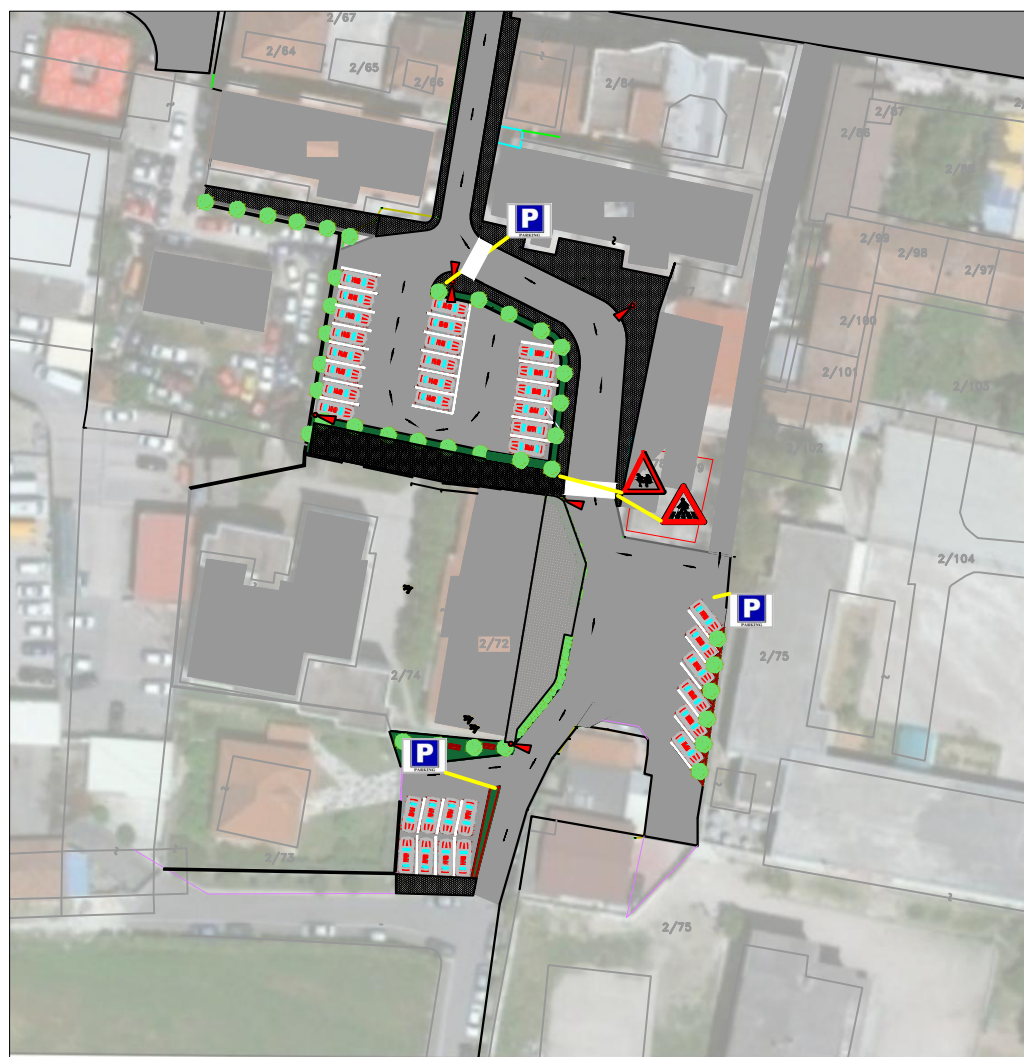

# SHESHI ISH PALLATI OFICERAVE

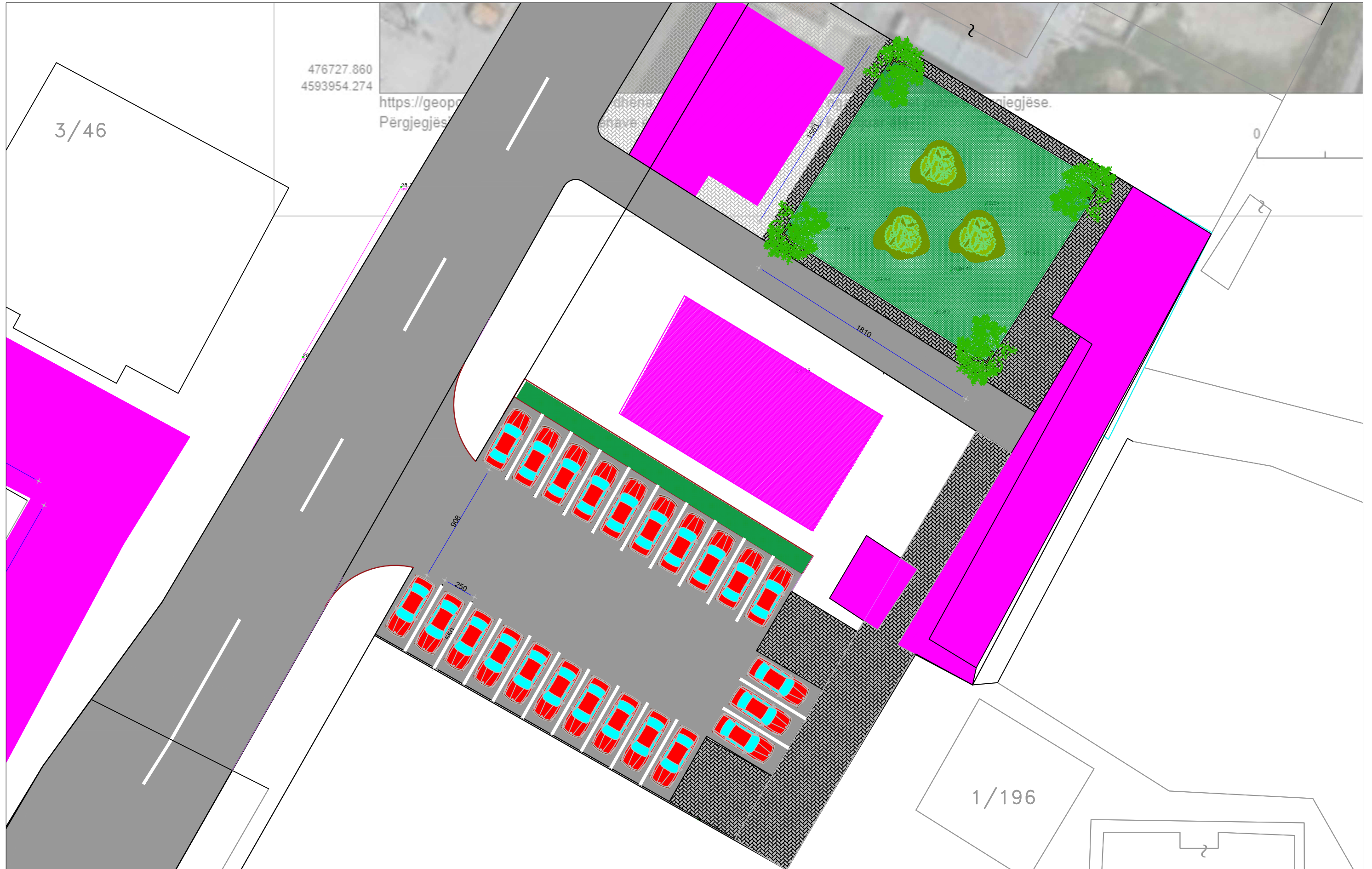

 REPUBLIKA E SHQIPERISE BASHKIA KRUJE	PROJEKT ZBATIMI "RIKUALIFIKIM URBAN I SHESHEVE TE PALLATEVE TE SHEMBURA NE TERRITORIN E NJESISE ADMINISTRATIVE FUSHE KRUJE"	PLANVENDOSJA	PROJEKTUES:	"ERALD G" shpk	FLETA 04
			SHKALLA	1 : __	2022

# SHESHI ISH PALLATI OFICERAVE



REPUBLIKA E SHQIPERISE  
BASHKIA KRUJE

"ERALD G" shpk

PROJEKT ZBATIMI  
"RIKUALIFIKIM URBAN I SHESHEVE TE PALLATEVE TE  
SHEMBURA NE TERRITORIN E NJESISE ADMINISTRATIVE  
FUSHE KRUJE"

DIMENSIONIMI

PROJEKTUES: "ERALD G" shpk

SHKALLA 1: \_\_

FLETA 04

2022

# SHESHI ISH PALLATI OFICERAVE



REPUBLIKA E SHQIPERISE  
BASHKIA KRUJE

"ERALD G" shpk

PROJEKT ZBATIMI  
"RIKUALIFIKIM URBAN I SHESHEVE TE PALLATEVE TE  
SHEMBURA NE TERRITORIN E NJESISE ADMINISTRATIVE  
FUSHE KRUJE"

RRJETI I KANALIZIMEVE KUB

PROJEKTUES:	"ERALD G" shpk	FLETA 04
SHKALLA	1 : __	2022

# SHESHI ISH PALLATI OFICERAVE



476727.860  
4593954.274

<https://geop...>  
Përgjegjës

autoritetet publike përgjegjëse.  
rijuar ato.

1/196

 REPUBLIKA E SHQIPERISE BASHKIA KRUJE	PROJEKT ZBATIMI "RIKUALIFIKIM URBAN I SHESHEVE TE PALLATEVE TE SHEMBURA NE TERRITORIN E NJESISE ADMINISTRATIVE FUSHE KRUJE"	RRJETI I NDRICIMIT	PROJEKTUES:	"ERALD G" shpk	FLETA 04
			SHKALLA	1 : __	

# SHESHI ISH PALLATI OFICERAVE

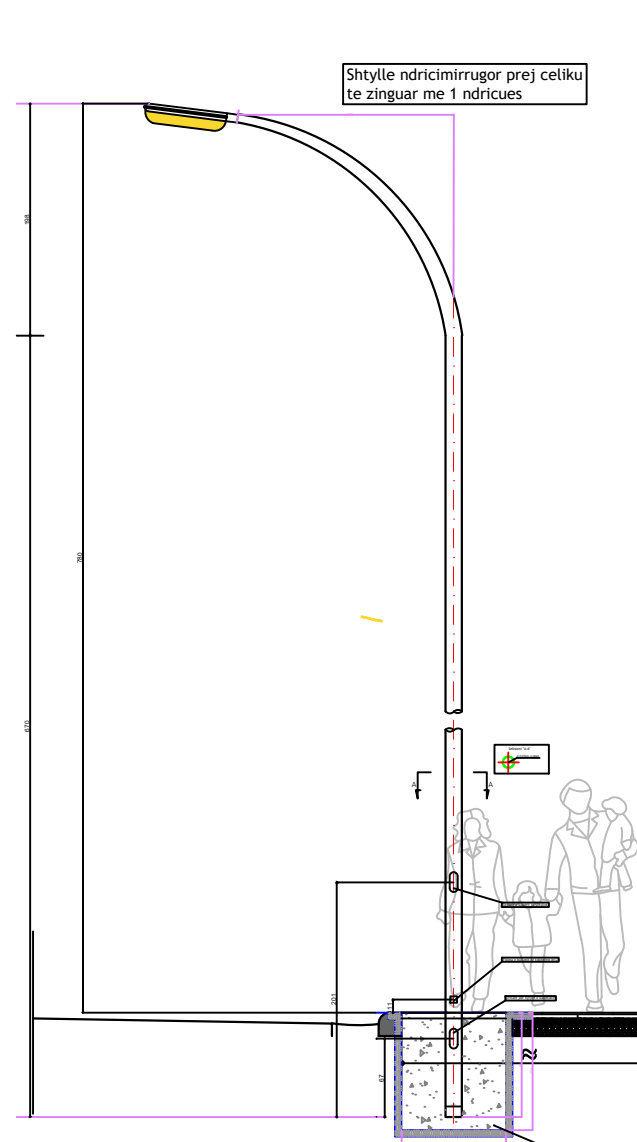

	REPUBLIKA E SHQIPERISE BASHKIA KRUJE	PROJEKT ZBATIMI "RIKUALIFIKIM URBAN I SHESHEVE TE PALLATEVE TE SHEMBURA NE TERRITORIN E NJESISE ADMINISTRATIVE FUSHE KRUJE"	DETAJE	PROJEKTUES: "ERALD G" shpk	FLETA 04
	"ERALD G" shpk			SHKALLA 1: __	

# SHESHI ISH PALLATI OFICERAVE

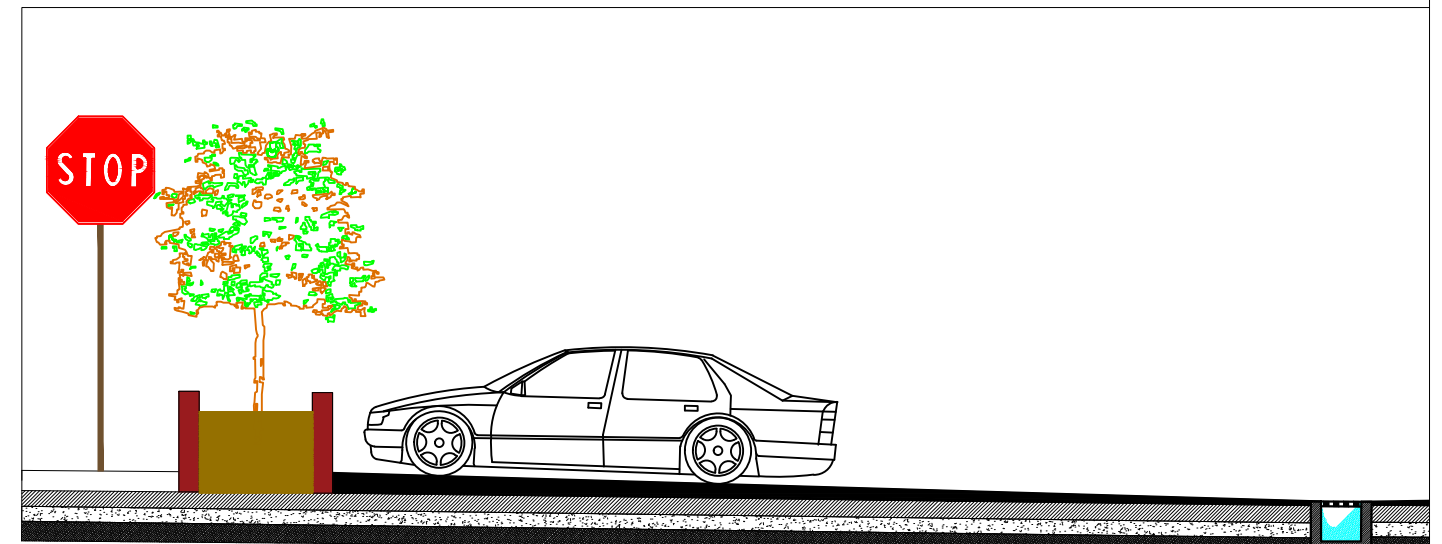
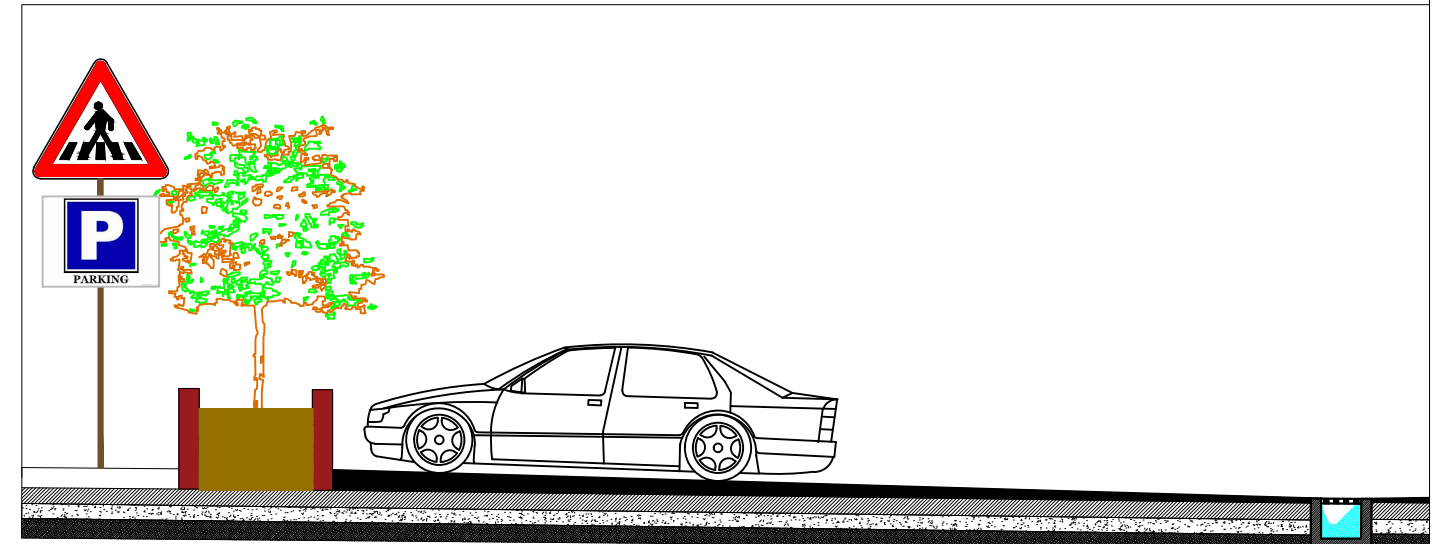
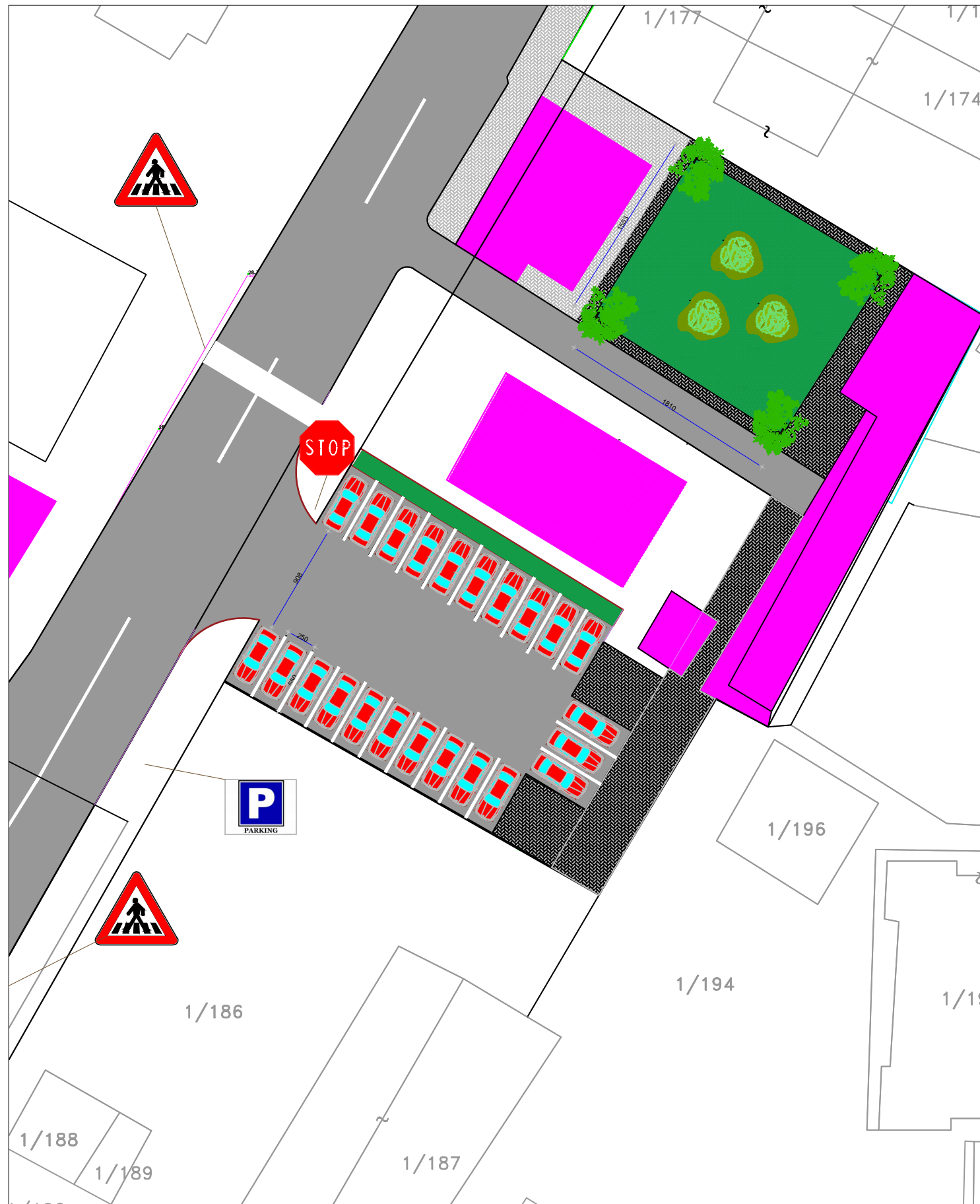

REPUBLIKA E SHQIPERISE  
BASHKIA KRUJE

"ERALD G" shpk

PROJEKT ZBATIMI  
"RIKUALIFIKIM URBAN I SHESHEVE TE PALLATEVE TE  
SHEMBURA NE TERRITORIN E NJESISE ADMINISTRATIVE  
FUSHE KRUJE"

SINJALISTIKA

PROJEKTUES:

"ERALD G" shpk

SHKALLA

1: \_\_

FLETA 04

2022



# SHESHI TEK BLOKU NR 6

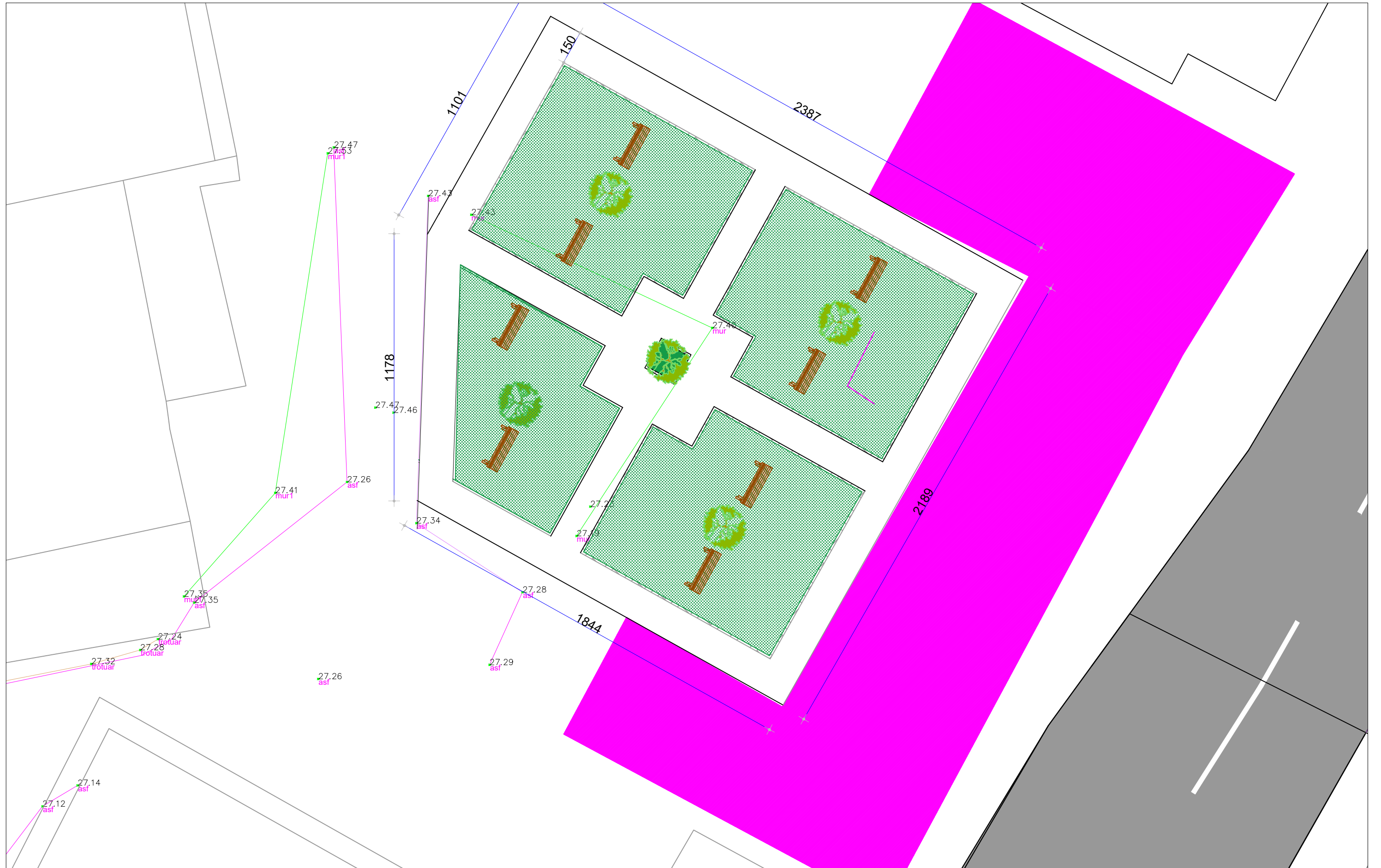

REPUBLIKA E SHQIPERISE  
BASHKIA KRUJE

"ERALD G" shpk

## PROJEKT ZBATIMI

"RIKUALIFIKIM URBAN I SHESHEVE TE PALLATEVE TE  
SHEMBURA NE TERRITORIN E NJESISE ADMINISTRATIVE  
FUSHE KRUJE"

PLANVENDOSJA

PROJEKTUES:

"ERALD G" shpk

SHKALLA

1 : \_\_

FLETA 04

2022

# SHESHI TEK BLOKU NR 6

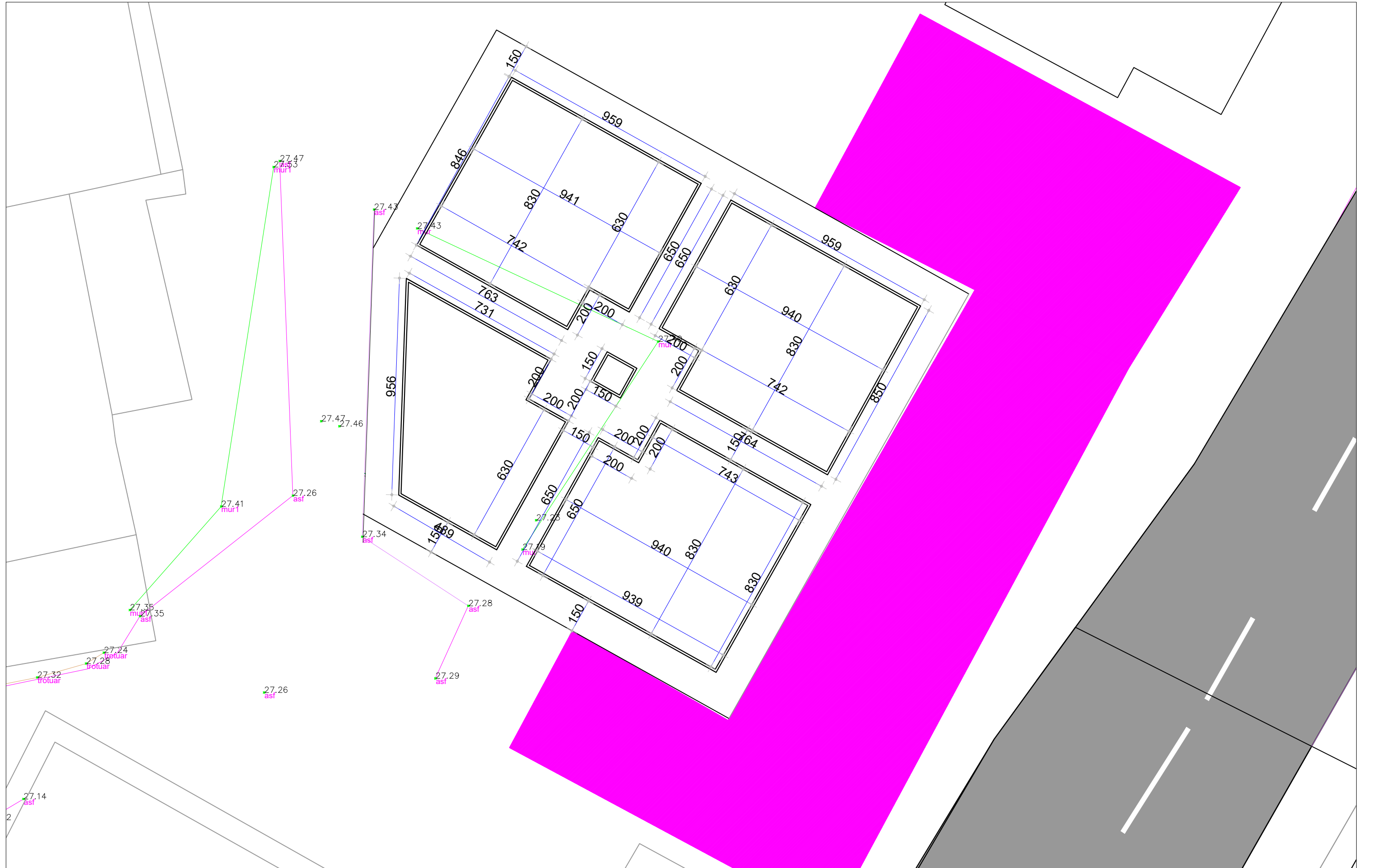

REPUBLIKA E SHQIPERISE  
BASHKIA KRUJE

"ERALD G" shpk

## PROJEKT ZBATIMI

"RIKUALIFIKIM URBAN I SHESHEVE TE PALLATEVE TE  
SHEMBURA NE TERRITORIN E NJESISE ADMINISTRATIVE  
FUSHE KRUJE"

DIMENSIONIMI

PROJEKTUES:

"ERALD G" shpk

FLETA 04

SHKALLA

1: \_\_

2022

# SHESHI TEK BLOKU NR 6

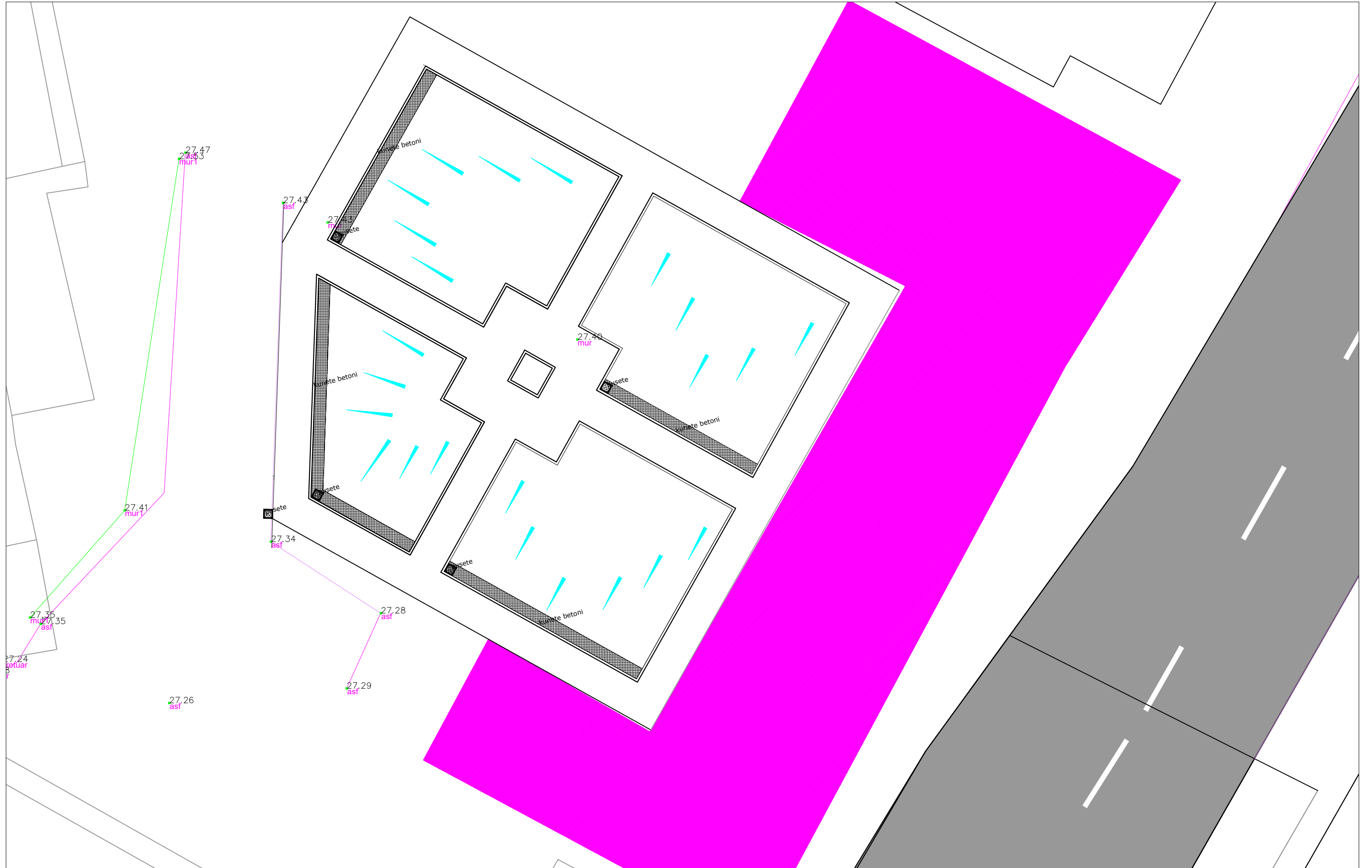

REPUBLIKA E SHQIPERISE  
BASHKIA KRUJE

"ERALD G" shpk

PROJEKT ZBATIMI  
"RIKUALIFIKIM URBAN I SHESHEVE TE PALLATEVE TE  
SHEMBURA NE TERRITORIN E NJESISE ADMINISTRATIVE  
FUSHE KRUJE"

RRJETI I KANALIZIMEVE KUB

PROJEKTUES:

"ERALD G" shpk

SHKALLA

1 : \_\_

FLETA 04

2022

# SHESHI TEK BLOKU NR 6

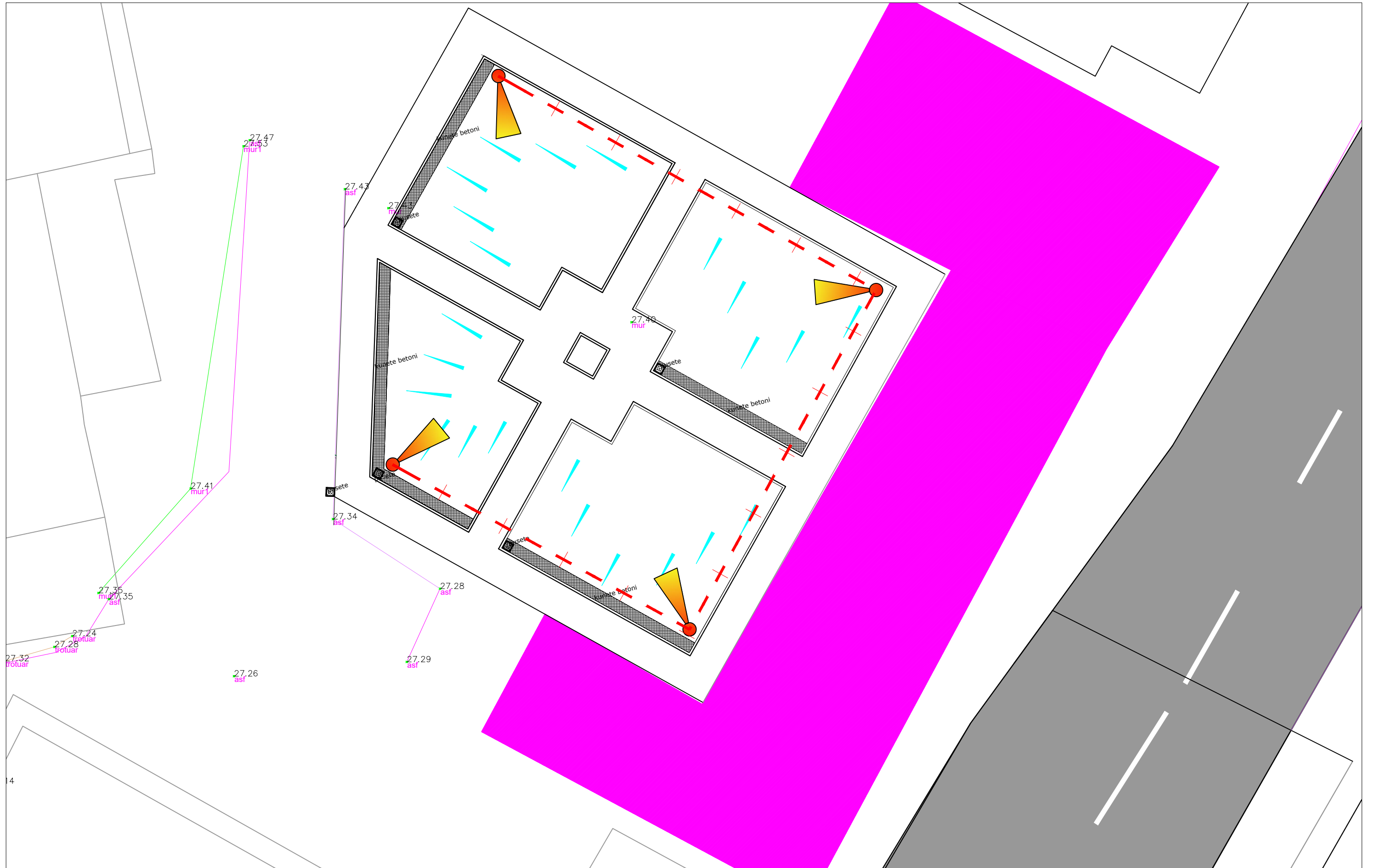

REPUBLIKA E SHQIPERISE  
BASHKIA KRUJE

"ERALD G" shpk

PROJEKT ZBATIMI  
"RIKUALIFIKIM URBAN I SHESHEVE TE PALLATEVE TE  
SHEMBURA NE TERRITORIN E NJESISE ADMINISTRATIVE  
FUSHE KRUJE"

RRJETI I NDRICIMIT

PROJEKTUES:

"ERALD G" shpk

SHKALLA

1: \_\_

FLETA 04

2022

# SHESHI TEK BLOKU NR 6

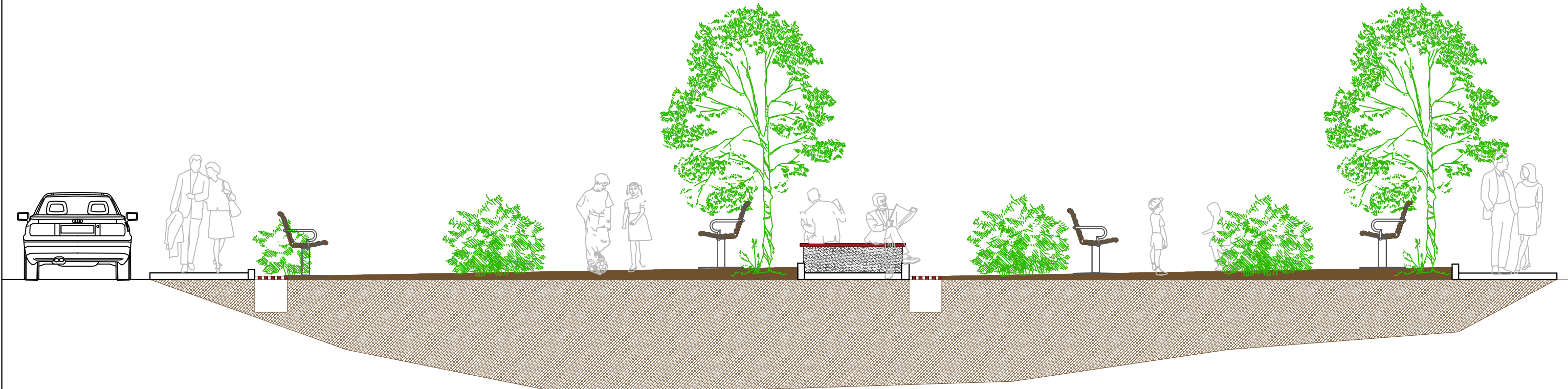

Shtylle ndricimrrugor prej celiku te zinguar me 1 ndricues

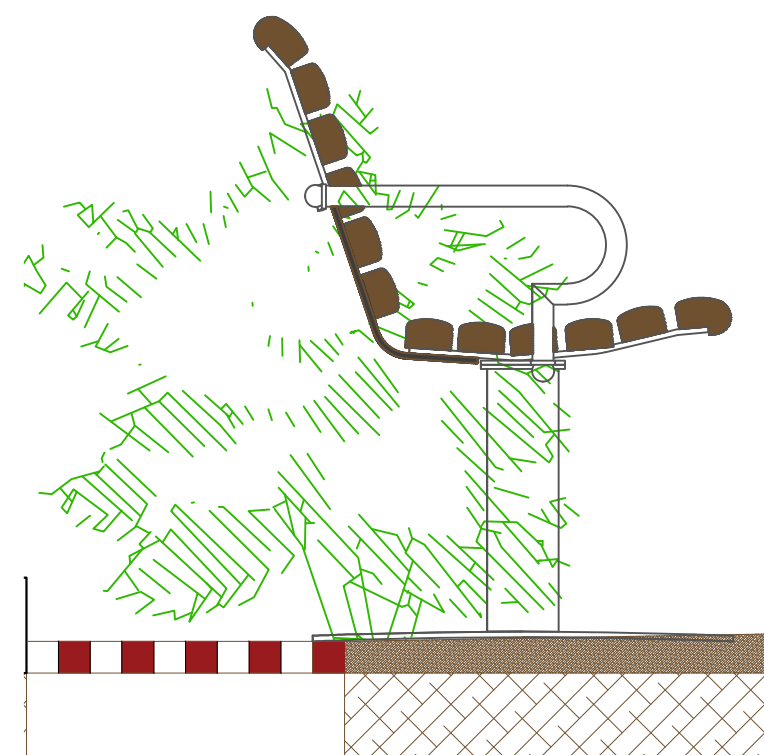
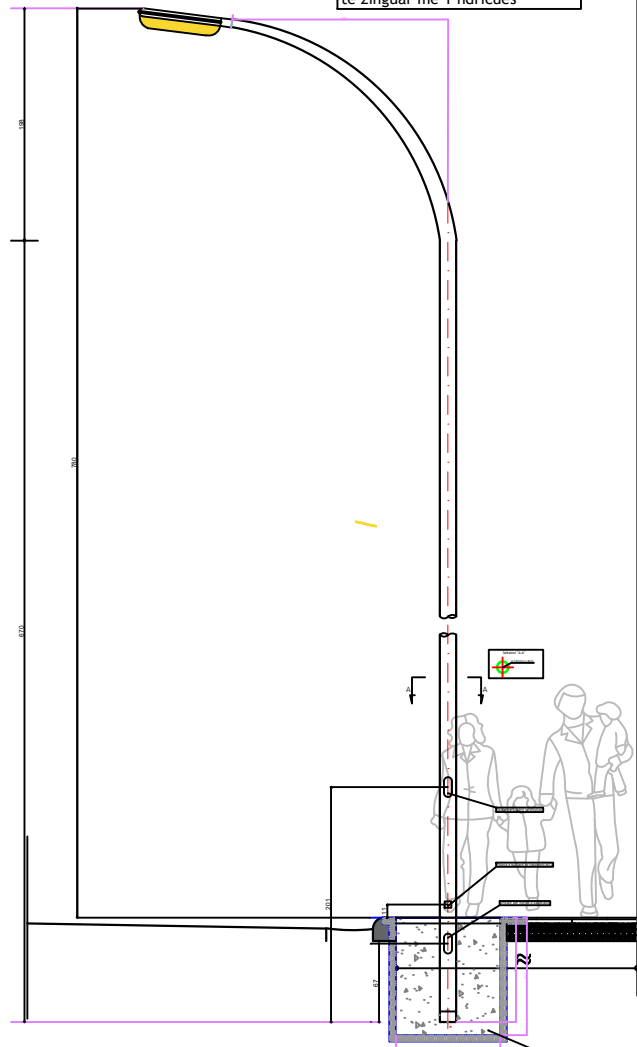

REPUBLIKA E SHQIPERISE  
BASHKIA KRUJE

"ERALD G" shpk

PROJEKT ZBATIMI  
"RIKUALIFIKIM URBAN I SHESHEVE TE PALLATEVE TE  
SHEMBURA NE TERRITORIN E NJESISE ADMINISTRATIVE  
FUSHE KRUJE"

DETAJE

PROJEKTUES:

"ERALD G" shpk

FLETA 04

SHKALLA

1: \_\_

2022

# SHESHI TEK BLOKU NR 6

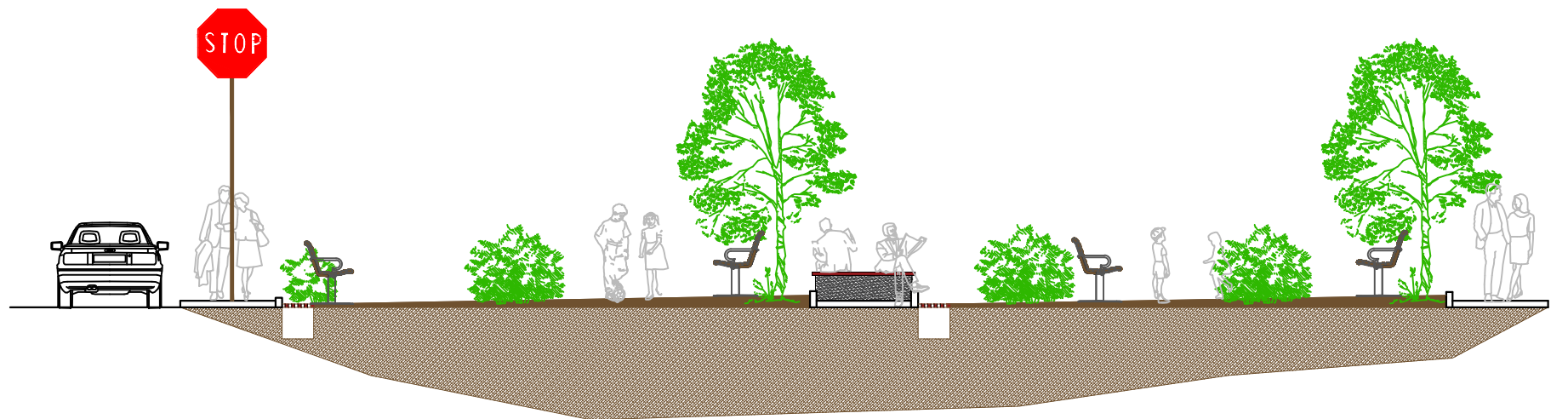
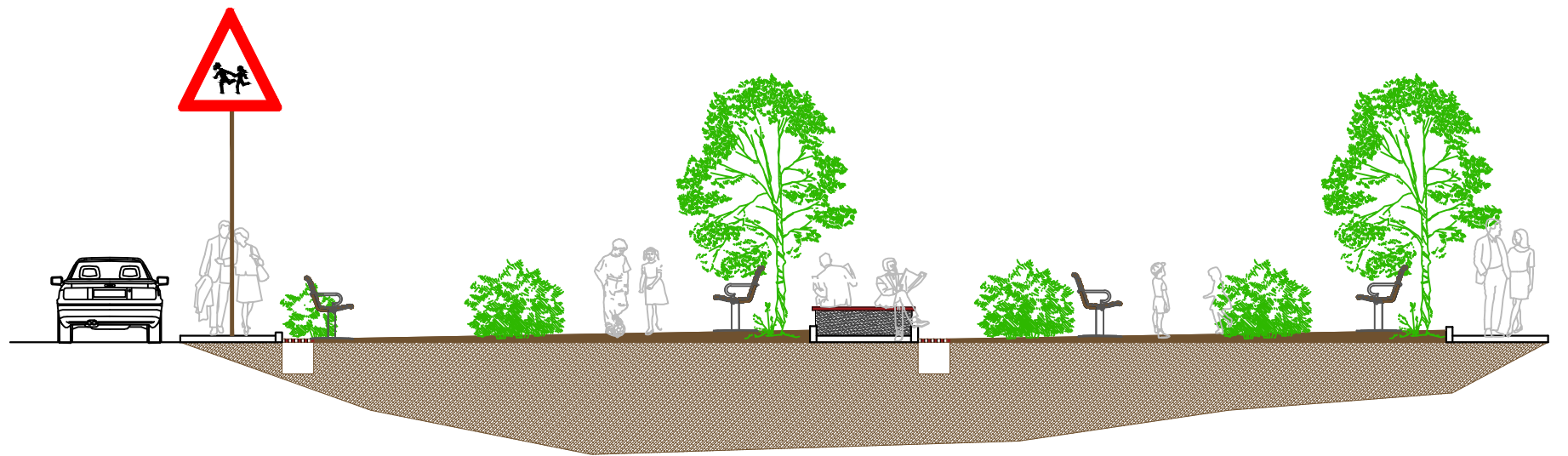
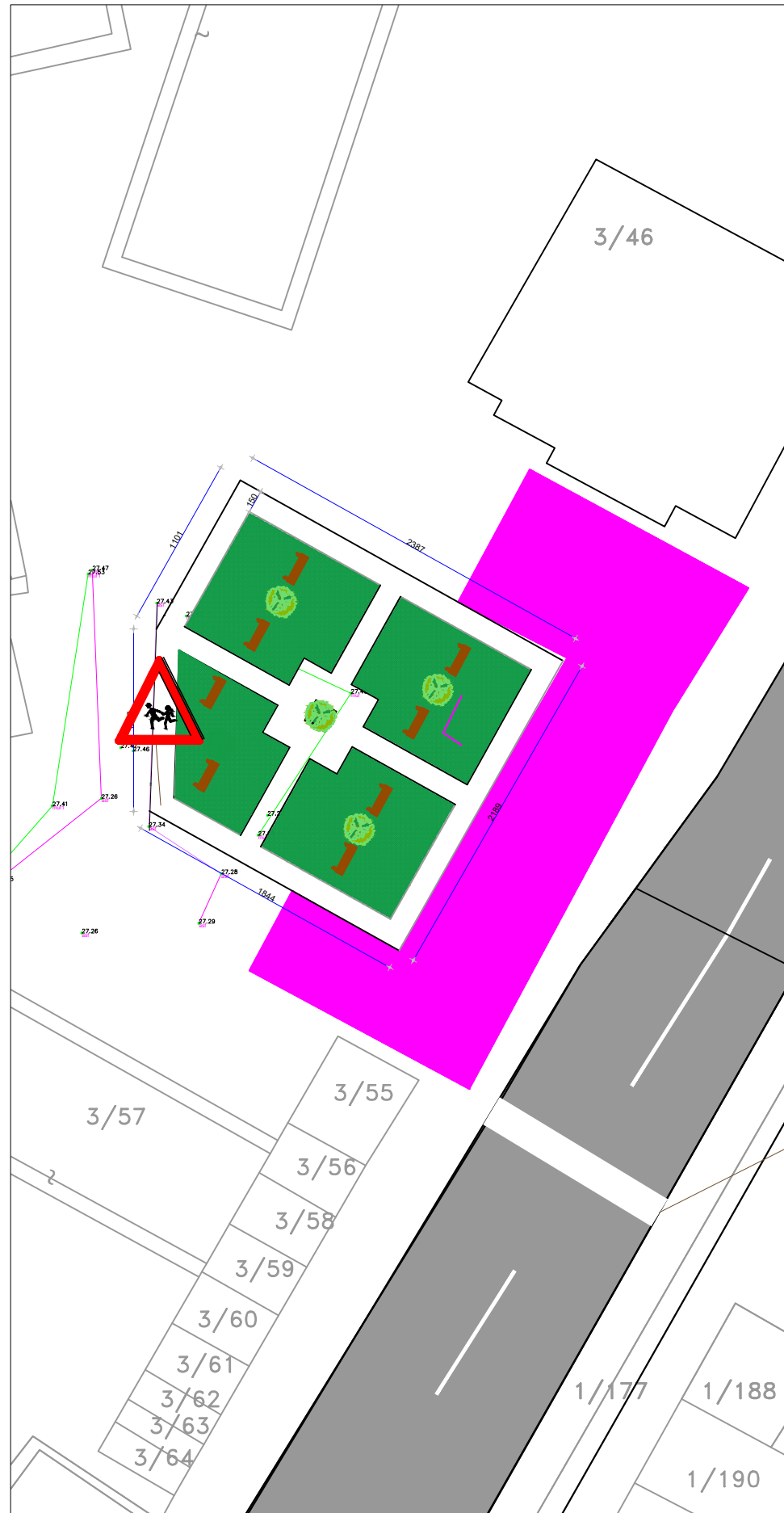

REPUBLIKA E SHQIPERISE  
BASHKIA KRUJE

"ERALD G" shpk

PROJEKT ZBATIMI  
"RIKUALIFIKIM URBAN I SHESHEVE TE PALLATEVE TE  
SHEMBURA NE TERRITORIN E NJESISE ADMINISTRATIVE  
FUSHE KRUJE"

SINJALISTIKA

PROJEKTUES:

"ERALD G" shpk

SHKALLA

1: \_\_

FLETA 04

2022