

OBJEKTI: NDËRTIM RRUGËT "Mustafa Kruja + Musa Fratari + Myslim Peza + Mustafa Kaçaçi + Mustafa Atatunku + Mujo Ulqinaku + Rr. pingul me Azem Hajdarin", Babrru Kodër e Kuqe

SHËNIM: PLANI ELEKTRIK
PËRFSHIN VETËM SHTRIRJEN E
TUBAVE KORROGATO (NDRIÇIMI
DO BËHET NJË FAZË TJETËR)

Planimetria e instalimit të rrjetit kabllor të ndriçimit,

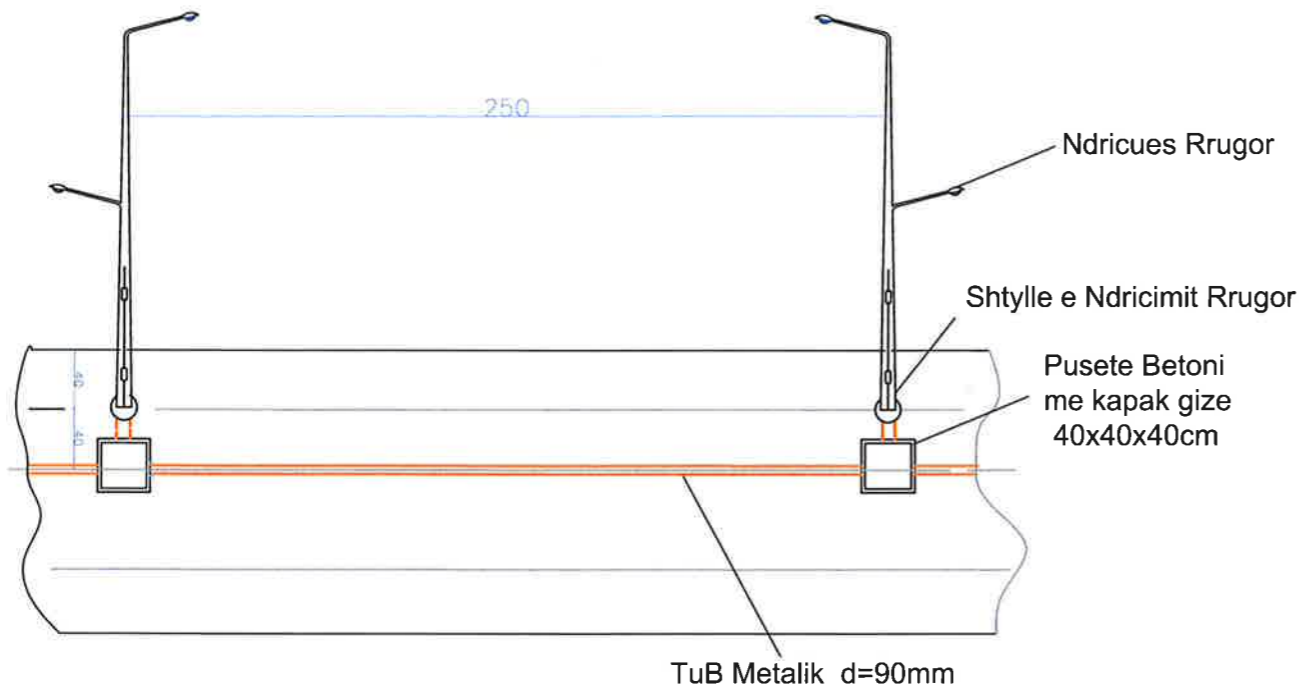

Shtrimi i kabllorëve të TU
ne TP.direkt ne toke

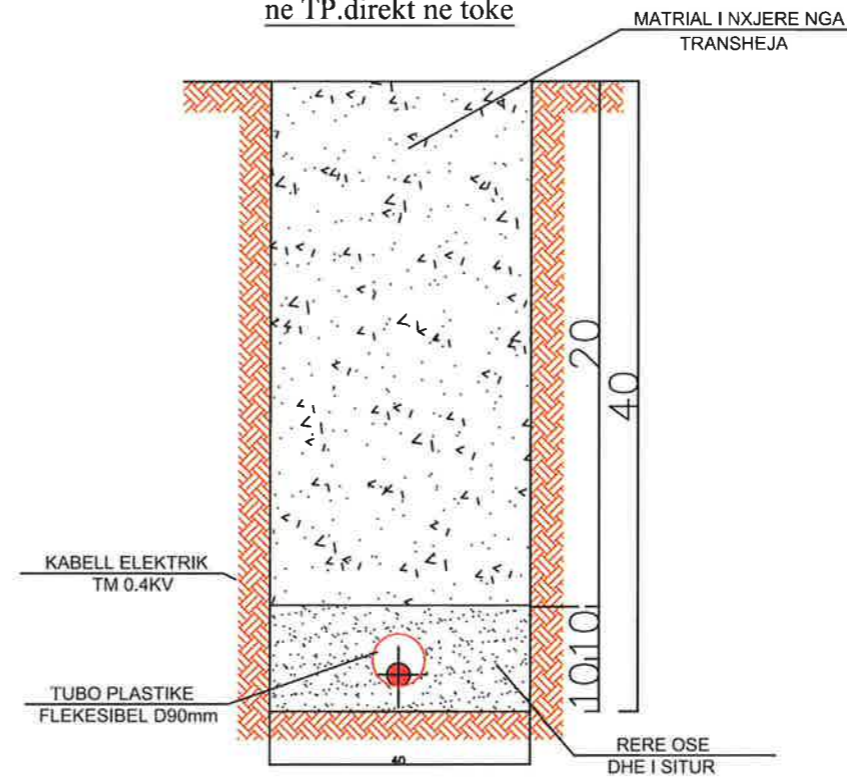

Detaj i montimit të pusetes dhe tokezimit të shtylles

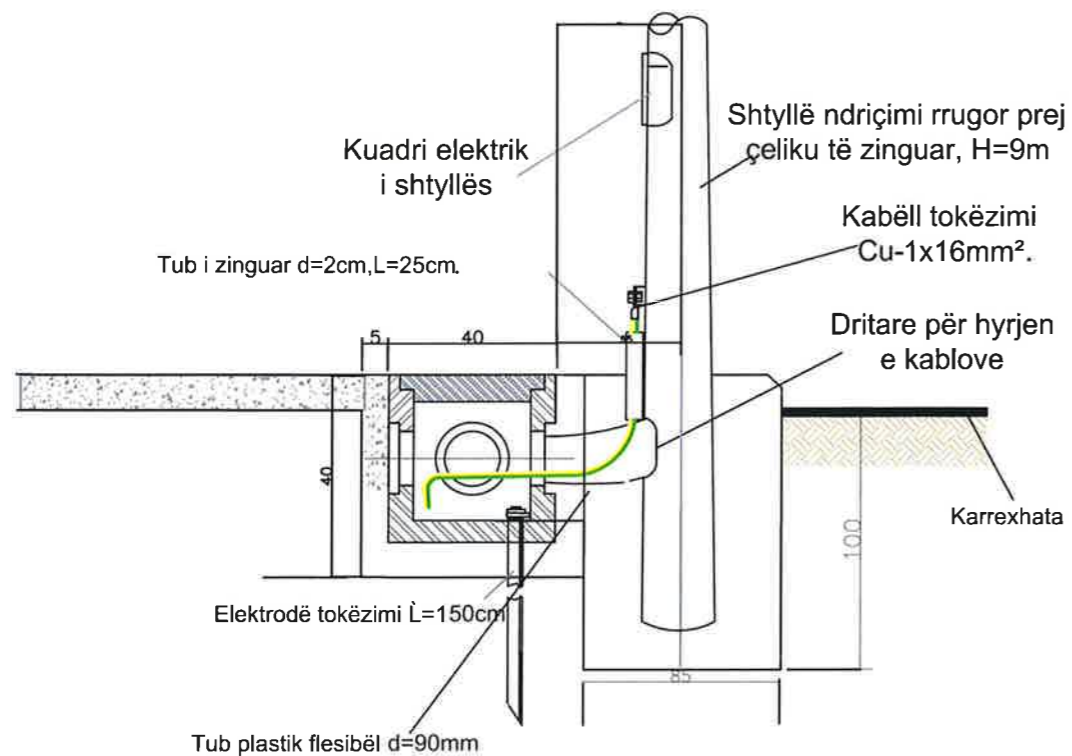

LEGJENDA

	TUB KORROGATO PËR TELEFONINË
	TUB KORROGATO NDRIÇIMI DHE ELEKTRIKU
	GIJRMË ASFALTI
	OBJEKTE
	PUSETË ELEKTRIKE KONTROLLI PVC 40x40x40

BASHKIA KAMËZ

DREJTORIA E SHËRBIMEVE PUBLIKE
DREJTORIA E PROJEKTEVE DHE INVESTIMEVE
DEPARTAMENTI I PROJEKTEVE

Dr. e Projekteve e Investimeve FLORA MUÇA
Pergj. Depart. Sektori Projektimi EMANUELA MËZIU

STAFI TEKNIK
PROJEKTES
Ing. Konstruktor DENIS PRENÇI
Ing. Hidroteknik HAJREDIN MURGU
Ing. Gjeoinformatik ERBLIN LALA
Topograf RAMADAN HYSA

Titulli i Projektit:
NDËRTIM RRUGËT "Mustafa Kruja + Musa Fratari + Myslim Peza + Mustafa Kaçaçi + Mustafa Atatunku + Mujo Ulqinaku", Babrru Kodër e Kuqe

Faza e Projektit:
PROJEKT ZBATIMI
Data e Implementimit:

Emertimi i Fletes:

DETAJE ELEKTRIKE

Shkalla e Vizatimit:

Fleta Nr.

T-84

OBJEKTI: NDËRTIM RRUGËT "Mustafa Kruja + Musa Fratari + Myslim Peza + Mustafa Kaçaçi + Mustafa Ataturku + Mujo Ulqinaku + Rr. pingul me Azem Hajdarin", Babrru Kodër e Kuqe

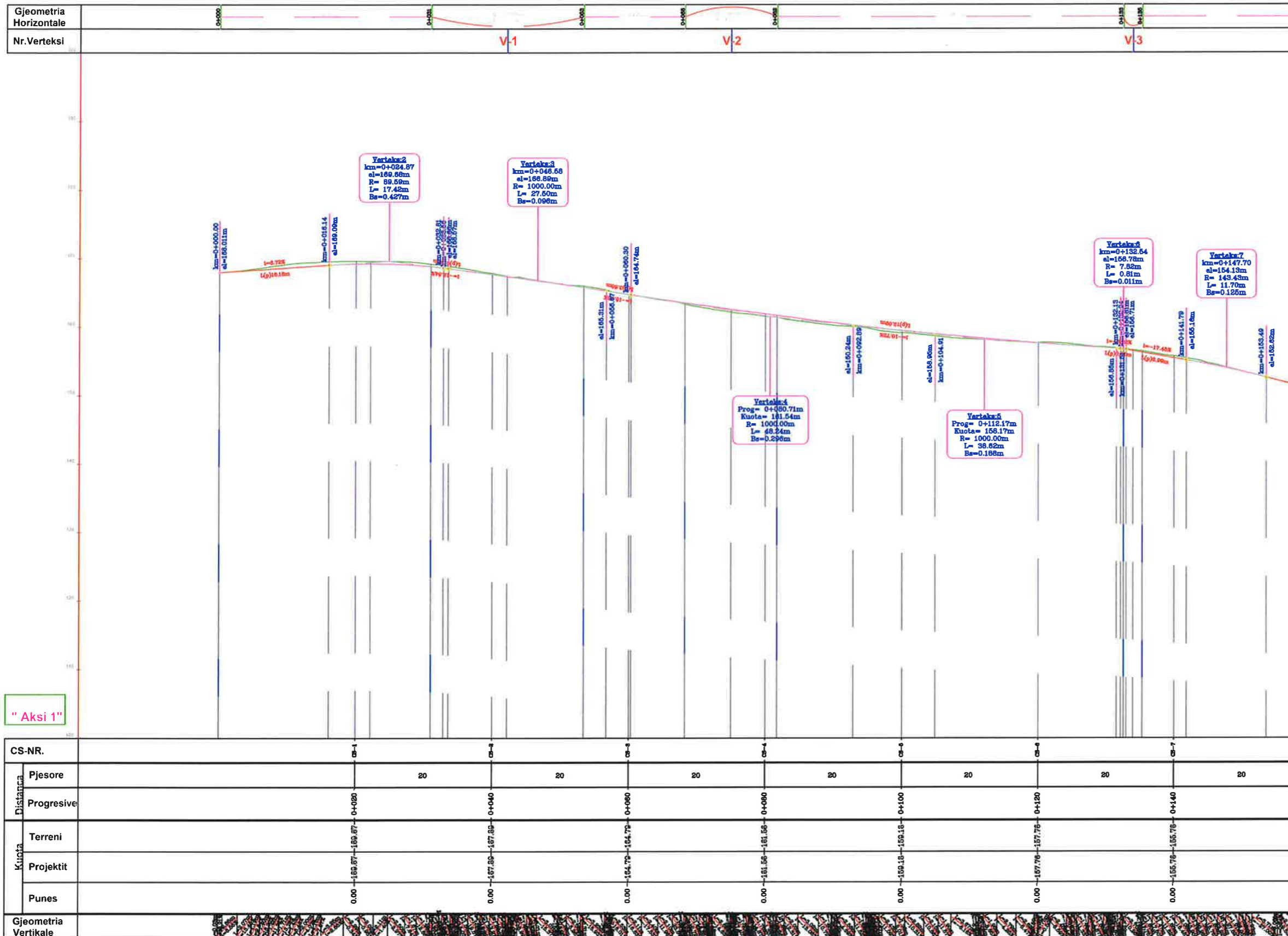

"Aksi 1"



BASHKIA KAMEZ

DREJTORIA E SHERBIMEVE PUBLIKE
DREJTORIA E PROJEKTEVE DHE INVESTIMEVE
DEPARTAMENTI I PROJEKTEVE

Dr. e Projekteve e Investimeve FLORA MUÇA

STAFI TEKNIK
PROJEKTES
Ing. Konstruktor DENIS PRENCI
Ing. Hidroteknik HAJREDIN MURGU
Ing. Gjeoinformatik ERBLIN LALA
Topograf RAMADAN HYSA

Titulli i Projektit:
NDËRTIM RRUGËT "Mustafa Kruja + Musa Fratari + Myslim Peza + Mustafa Kaçaçi + Mustafa Ataturku + Mujo Ulqinaku + Rr. pingul me Azem Hajdarin", Babrru Kodër e Kuqe

Emertimi i Fletes:

PROFIL GJATESOR

Faza e Projektit:
PROJEKT ZBATIMI

Data e Implementimit:

Shkalla e Vizimit:

Fleta Nr.

T-1

OBJEKTI: NDËRTIM RRUGËT "Mustafa Kruja + Musa Fratari + Myslim Peza + Mustafa Kaçaçi + Mustafa Atatunku + Mujo Ulqinaku + Rr. pingul me Azem Hajdarin", Babrru Kodër e Kuqe

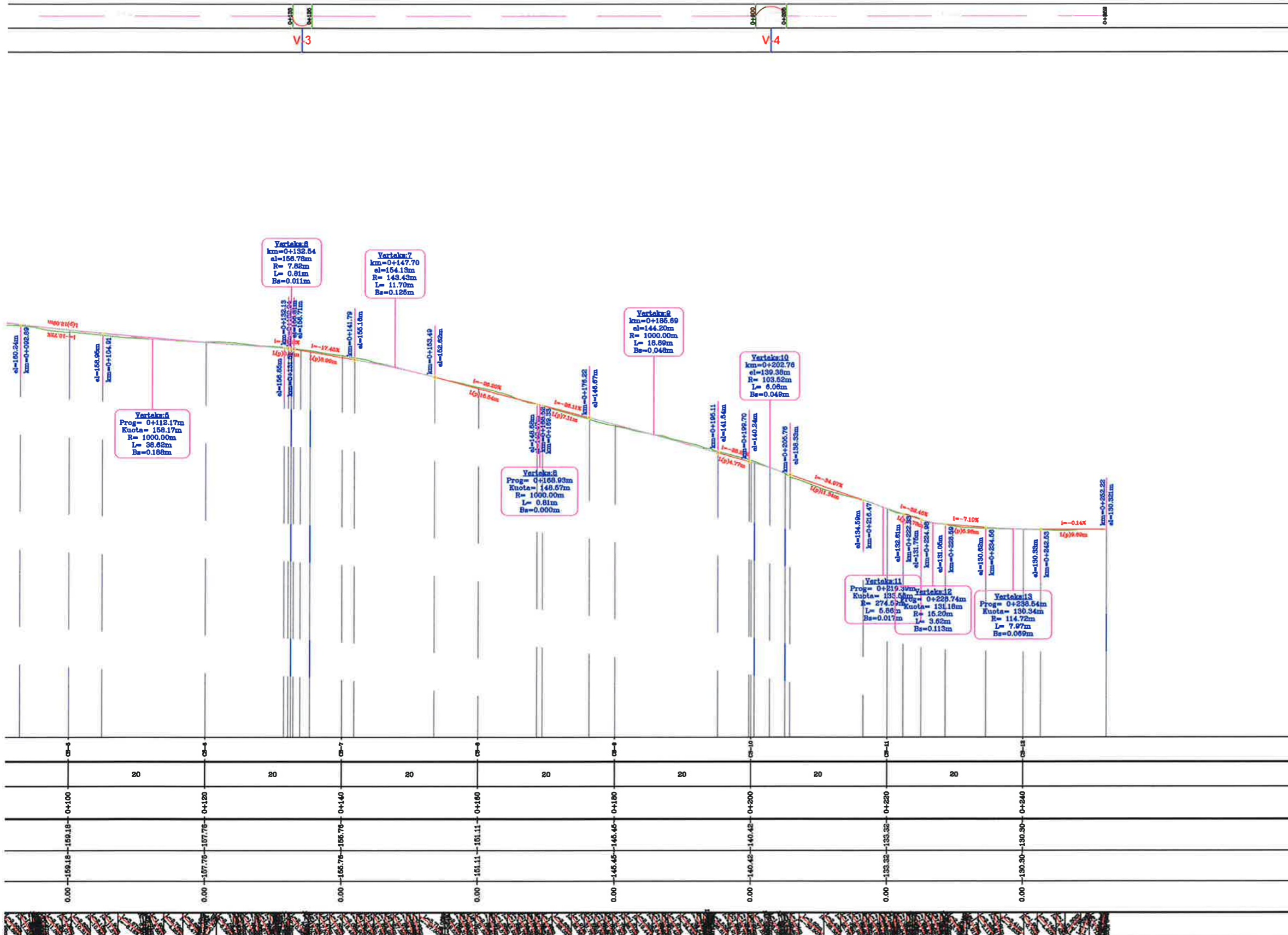

BASHKIA KAMEZ

DREJTORIA E SHERBIMEVE PUBLIKE
DREJTORIA E PROJEKTEVE DHE INVESTIMEVE
DEPARTAMENTI I PROJEKTEVE

Dr. e Projekteve e Investimeve FLORA MUÇA

STAFI TEKNIKUS PROJEKTUES	Ing. Konstruktor	DENIS PRENCI
	Ing. Hidroteknik	HAJREDIN MURGU
	Ing. Gjeoinformatik	ERBLIN LALA
	Topograf	RAMADAN HYSA

Titulli i Projektit:
NDERTIM RRUGËT "Mustafa Kruja + Musa Fratari + Myslim Peza + Mustafa Kaçaçi + Mustafa Atatunku + Mujo Ulqinaku + Rr. pingul me Azem Hajdarin", Babrru Kodër e Kuqe

Faza e Projektit:
PROJEKT ZBATIMI
Data e Implementimit:
Shkalla e Vizatimit:

Emertimi i Fletes:

PROFIL GJATESOR

Fleta Nr.

T-2

OBJEKTI: NDËRTIM RRUGËT "Mustafa Kruja + Musa Fratari + Myslim Peza + Mustafa Kaçaçi + Mustafa Atatunku + Mujo Ulqinaku + Rr. pingul me Azem Hajdarin", Babrru Kodër e Kuqe

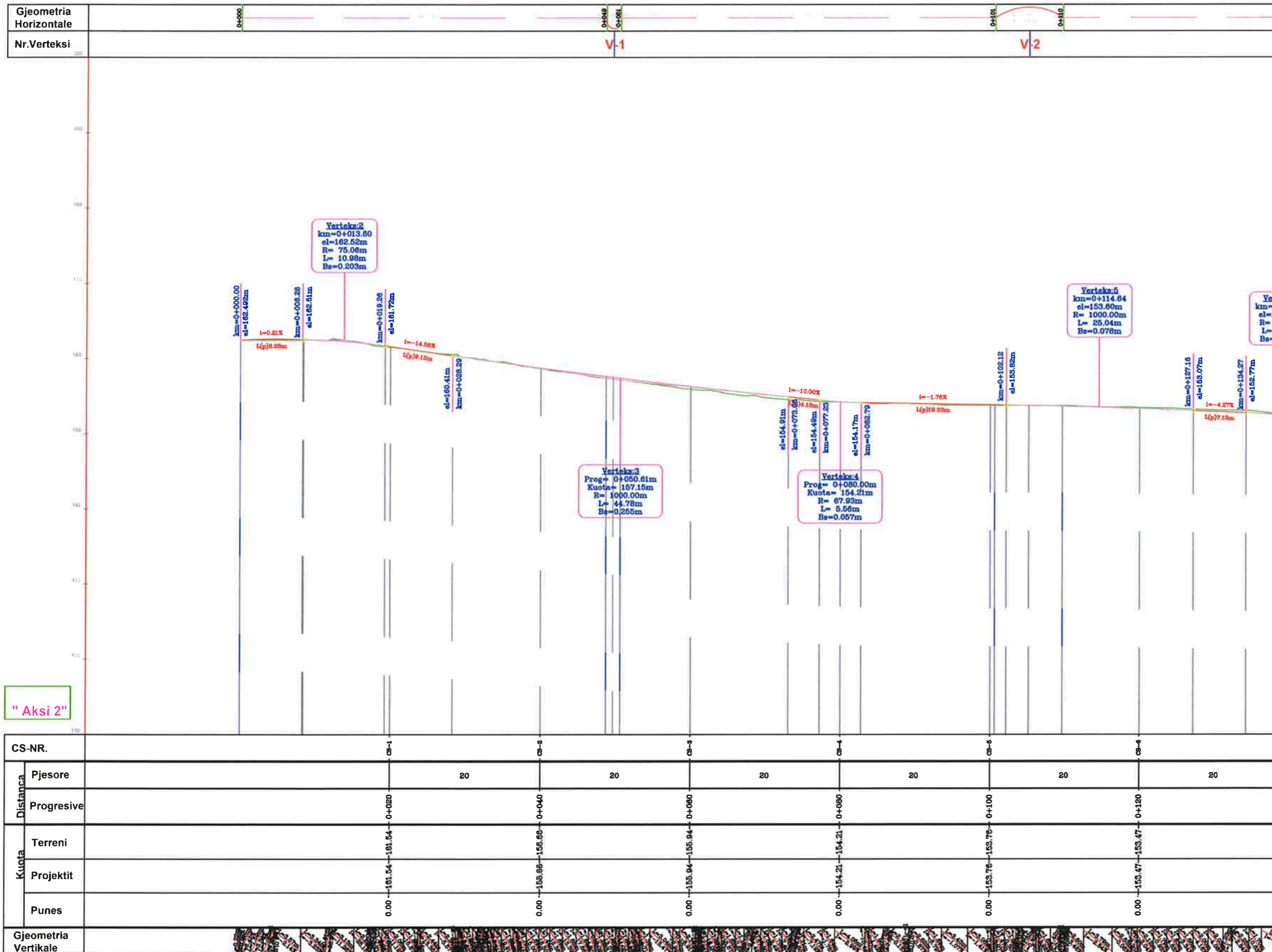

"Aksi 2"

CS-NR.		CS-1	CS-2	CS-3	CS-4	CS-5	CS-6	CS-7
Distanca	Pjesore	20	20	20	20	20	20	20
	Progresive	0+020	0+040	0+060	0+080	0+100	0+120	
Kuota	Terreni	161.54	161.54	158.88	158.88	155.94	155.94	154.21
	Projektit	161.54	161.54	158.88	158.88	155.94	155.94	154.21
	Punes	0.00	0.00	0.00	0.00	0.00	0.00	0.00
Gjeometria Vertikale								



BASHKIA KAMEZ

DREJTORIA E SHERBIMEVE PUBLIKE
DREJTORIA E PROJEKTEVE DHE INVESTIMEVE
DEPARTAMENTI I PROJEKTEVE

Dr. e Projekteve e Investimeve **FLORA MUÇA**

STAFI TEKNIK
PROJEKTUES
Ing. Konstruktor DENIS PRENCI
Ing. Hidroteknik HAJREDIN MURGU
Ing. Gjeoinformatik ERBLIN LALA
Topograf RAMADAN HYSA

Titulli i Projektit:
NDËRTIM RRUGËT "Mustafa Kruja + Musa Fratari + Myslim Peza + Mustafa Kaçaçi + Mustafa Atatunku + Mujo Ulqinaku + Rr. pingul me Azem Hajdarin", Babrru Kodër e Kuqe

Emertimi i Fletes:

PROFIL GJATESOR

Fleta Nr.

T-3

OBJEKTI: NDËRTIM RRUGËT "Mustafa Kruja + Musa Fratari + Myslim Peza + Mustafa Kaçaçi + Mustafa Atatunku + Mujo Ulqinaku + Rr. pingul me Azem Hajdarin", Babrru Kodër e Kuqe

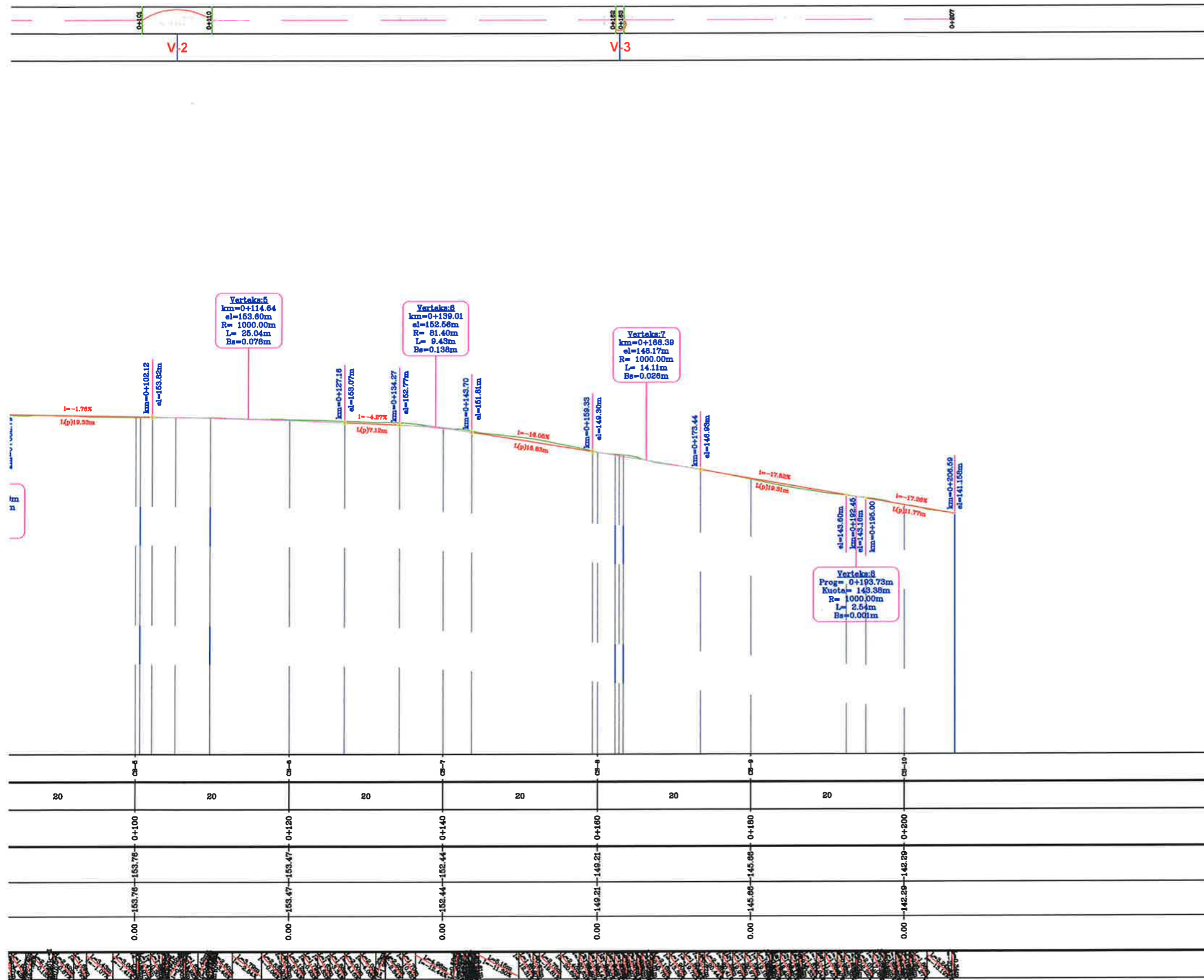

BASHKIA KAMEZ

DREJTORIA E SHERBIMEVE PUBLIKE
DREJTORIA E PROJEKTEVE DHE INVESTIMEVE
DEPARTAMENTI I PROJEKTEVE

Dr. e Projekteve e Investimeve FLORA MUÇA

STAFI TEKNIK
PROJEKTUES
Ing. Konstruktor DENIS PRENCI
Ing. Hidroteknik HAJREDIN MURGU
Ing. Gjeoinformatik ERBLIN LALA
Topograf RAMADAN HYSA

Titulli i Projektit:
NDËRTIM RRUGËT "Mustafa Kruja + Musa Fratari
+ Myslim Peza + Mustafa Kaçaçi + Mustafa
Ataturku + Mujo Ulqinaku + Rr. pingul me Azem
Hajdarin", Babrru Kodër e Kuqe

Faza e Projektit:
PROJEKT ZBATIMI

Data e Implementimit:

Shkalla e Vizatimit:

Emertimi i Fletes:

Fleta Nr.

PROFIL GJATESOR

T-4

OBJEKTI: NDËRTIM RRUGËT "Mustafa Kruja + Musa Fratari + Myslim Peza + Mustafa Kaçaçi + Mustafa Ataturku + Mujo Ulqinaku + Rr. pingul me Azem Hajdarin", Babrru Kodër e Kuqe

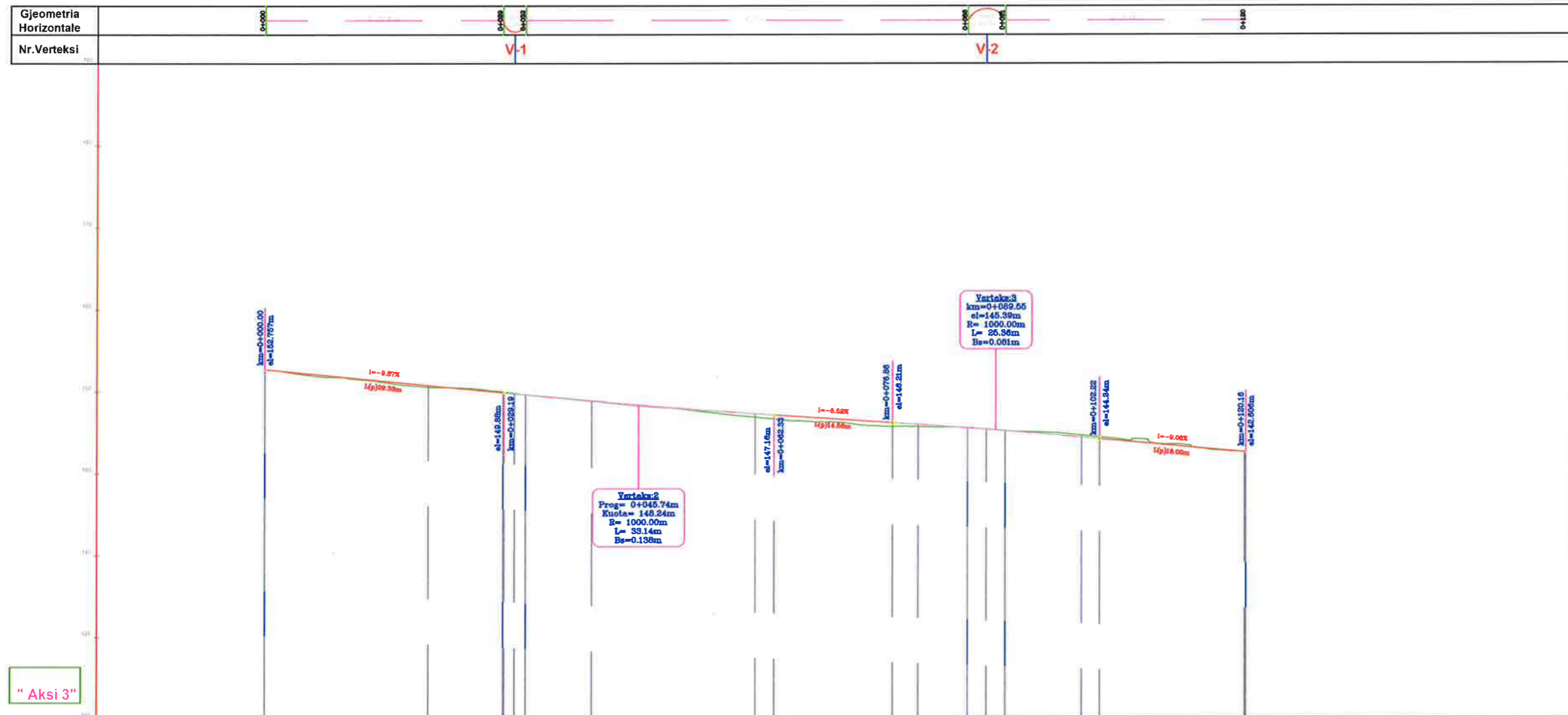

CS-NR.		CS-1	CS-2	CS-3	CS-4	CS-5	CS-6	CS-7
Distanca	Pjesore	20	20	20	20	20	20	20
	Progresive	0+020	0+040	0+060	0+080	0+100	0+120	
Kuota	Terreni	150.55	148.92	146.89	145.73	144.87	142.82	
	Projektit	150.55	148.92	146.89	145.73	144.87	142.82	
	Punes	0.00	0.00	0.00	0.00	0.00	0.00	
Gjeometria Vertikale								



BASHKIA KAMEZ

DREJTORIA E SHERBIMEVE PUBLIKE
DREJTORIA E PROJEKTEVE DHE INVESTIMEVE
DEPARTAMENTI I PROJEKTEVE

Dr. e Projekteve e Investimeve **FLORA MUÇA**

STAFI TEKNIK
PROJEKTES

Ing. Konstruktor	DENIS PRENCI
Ing. Hidroteknik	HAJREDIN MURGU
Ing. Gjeoinformatik	ERBLIN LALA
Topograf	RAMADAN HYSA

Titulli i Projektit:
NDËRTIM RRUGËT "Mustafa Kruja + Musa Fratari + Myslim Peza + Mustafa Kaçaçi + Mustafa Ataturku + Mujo Ulqinaku + Rr. pingul me Azem Hajdarin", Babrru Kodër e Kuqe

Faza e Projektit:
PROJEKT ZBATIMI

Data e Implementimit:

Shkalla e Vizatimit:

Emertimi i Fletes:

Fleta Nr.

PROFIL GJATESOR

T-5

OBJEKTI: NDËRTIM RRUGËT "Mustafa Kruja + Musa Fratari + Myslim Peza + Mustafa Kaçaçi + Mustafa Ataturku + Mujo Ulqinaku + Rr. pingul me Azem Hajdarin", Babrru Kodër e Kuqe

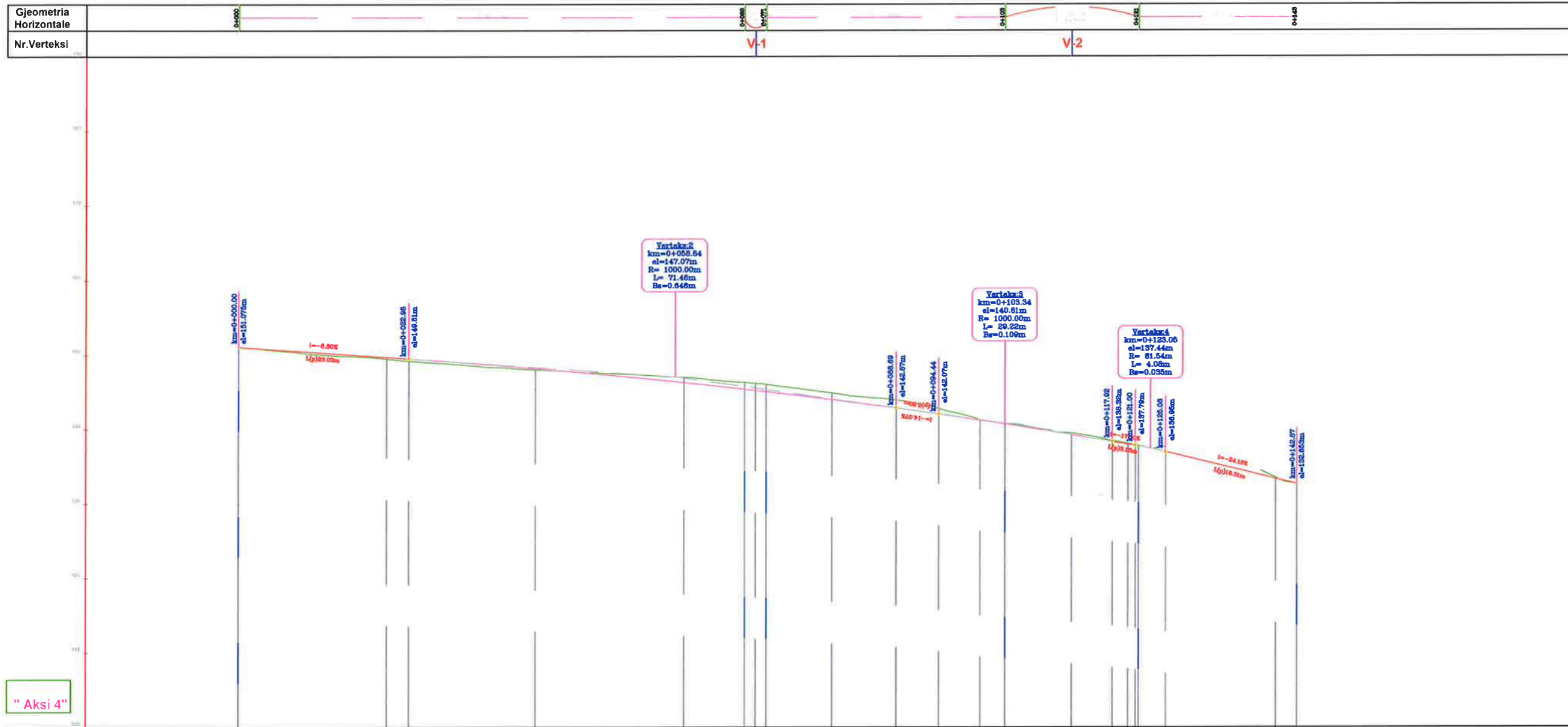

CS-NR.		CS-1	CS-2	CS-3	CS-4	CS-5	CS-6	CS-7
Distanca	Pjesore	20	20	20	20	20	20	20
	Progresive	0+020	0+040	0+080	0+080	0+100	0+120	0+140
Kucija	Terreni	-149.50	-143.05	-147.02	-144.92	-141.30	-138.05	-132.45
	Projektit	-149.50	-143.05	-147.02	-144.92	-141.30	-138.05	-132.45
	Punes	0.00	0.00	0.00	0.00	0.00	0.00	0.00
Gjeometria Vertikale		[Cross-section diagram showing road profile and ground level]						

" Aksi 4"



BASHKIA KAMEZ

DREJTORIA E SHERBIMEVE PUBLIKE
DREJTORIA E PROJEKTEVE DHE INVESTIMEVE
DEPARTAMENTI I PROJEKTEVE

Dr. e Projekteve e Investimeve FLORA MUÇA

STAFI TEKNIK
PROJEKTUES
Ing. Konstruktor DENIS PRENCI
Ing. Hidroteknik HAJREDIN MURGU
Ing. Gjeoinformatik ERBLIN LALA
Topograf RAMADAN HYSA

Titulli i Projektit:
NDËRTIM RRUGËT "Mustafa Kruja + Musa Fratari + Myslim Peza + Mustafa Kaçaçi + Mustafa Ataturku + Mujo Ulqinaku + Rr. pingul me Azem Hajdarin", Babrru Kodër e Kuqe

Faza e Projektit:
PROJEKT ZBATIMI
Data e Implementimit:
Shkalla e Vizatimit:

Emeritimi i Fletes:
PROFIL GJATESOR

Fleta Nr.
T-6

OBJEKTI: NDËRTIM RRUGËT "Mustafa Kruja + Musa Fratari + Myslim Peza + Mustafa Kaçaçi + Mustafa Atatunku + Mujo Ulqinaku + Rr. pingul me Azem Hajdarin", Babrru Kodër e Kuqe

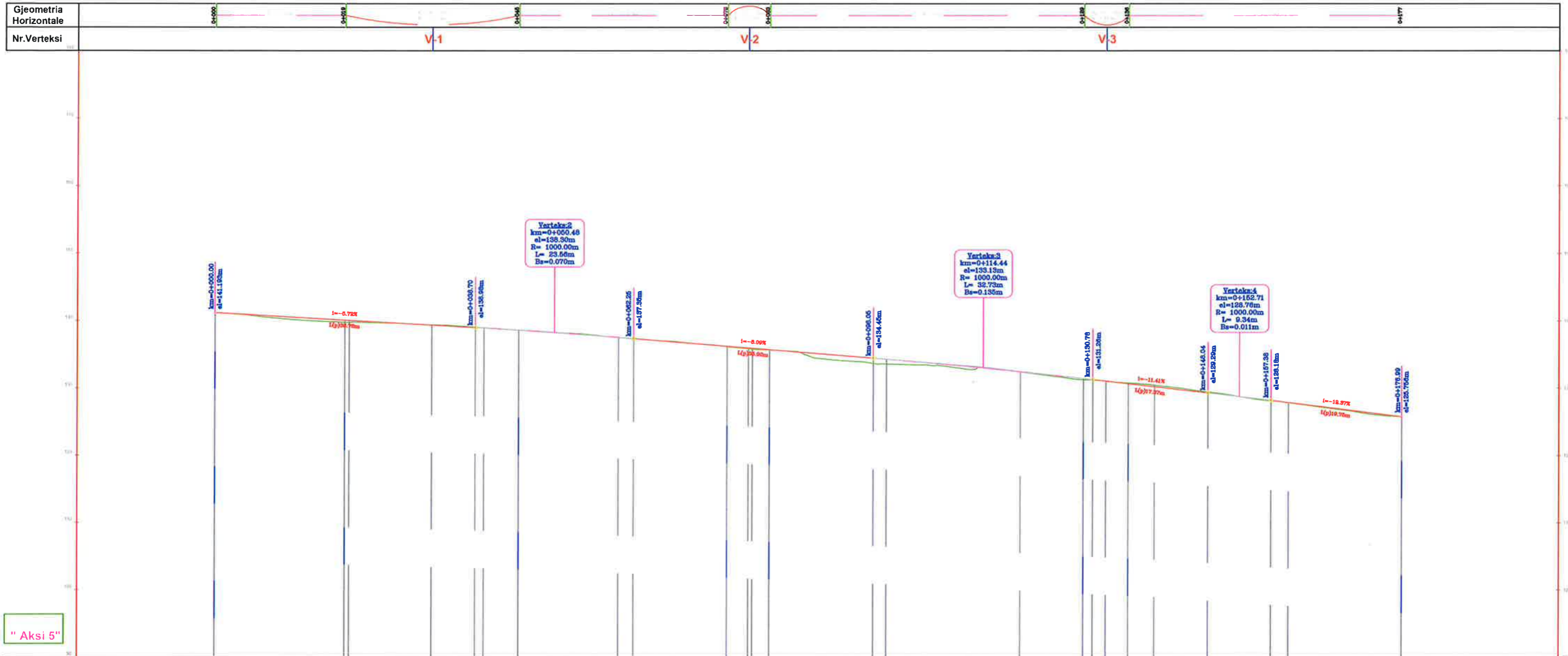

CS-NR.		CS-1	CS-2	CS-3	CS-4	CS-5	CS-6	CS-7	CS-8
Distanca	Pjesore		20	20	20	20	20	20	20
	Progresive	0+020	0+040	0+060	0+080	0+100	0+120	0+140	0+160
Kunta	Terreni	138.75	138.96	137.51	135.50	133.50	132.39	130.43	127.81
	Projektit	138.75	138.96	137.51	135.50	133.50	132.39	130.43	127.81
	Punes	0.00	0.00	0.00	0.00	0.00	0.00	0.00	0.00



BASHKIA KAMEZ

DREJTORIA E SHERBIMEVE PUBLIKE
 DREJTORIA E PROJEKTEVE DHE INVESTIMEVE
 DEPARTAMENTI I PROJEKTEVE

Dr. e Projekteve e Investimeve **FLORA MUÇA**

STAFI TEKNIK	Ing., Konstruktor	DENIS PRENCI
PROJEKTES	Ing., Hidroteknik	HAJREDIN MURGU
	Ing., Gjeoinformatik	ERBLIN LALA
	Topograf	RAMADAN HYSA

Titulli i Projektit:
 NDËRTIM RRUGËT "Mustafa Kruja + Musa Fratari + Myslim Peza + Mustafa Kaçaçi + Mustafa Atatunku + Mujo Ulqinaku + Rr. pingul me Azem Hajdarin", Babrru Kodër e Kuqe

Data e Implementimit:
 Shkalla e Vizatimit:
 Emertimi i Flotes:
 Fieta Nr.

OBJEKTI: NDËRTIM RRUGËT "Mustafa Kruja + Musa Fratari + Myslim Peza + Mustafa Kaçaçi + Mustafa Atatunku + Mujo Ulqinaku + Rr. pingul me Azem Hajdarin", Babrru Kodër e Kuqe

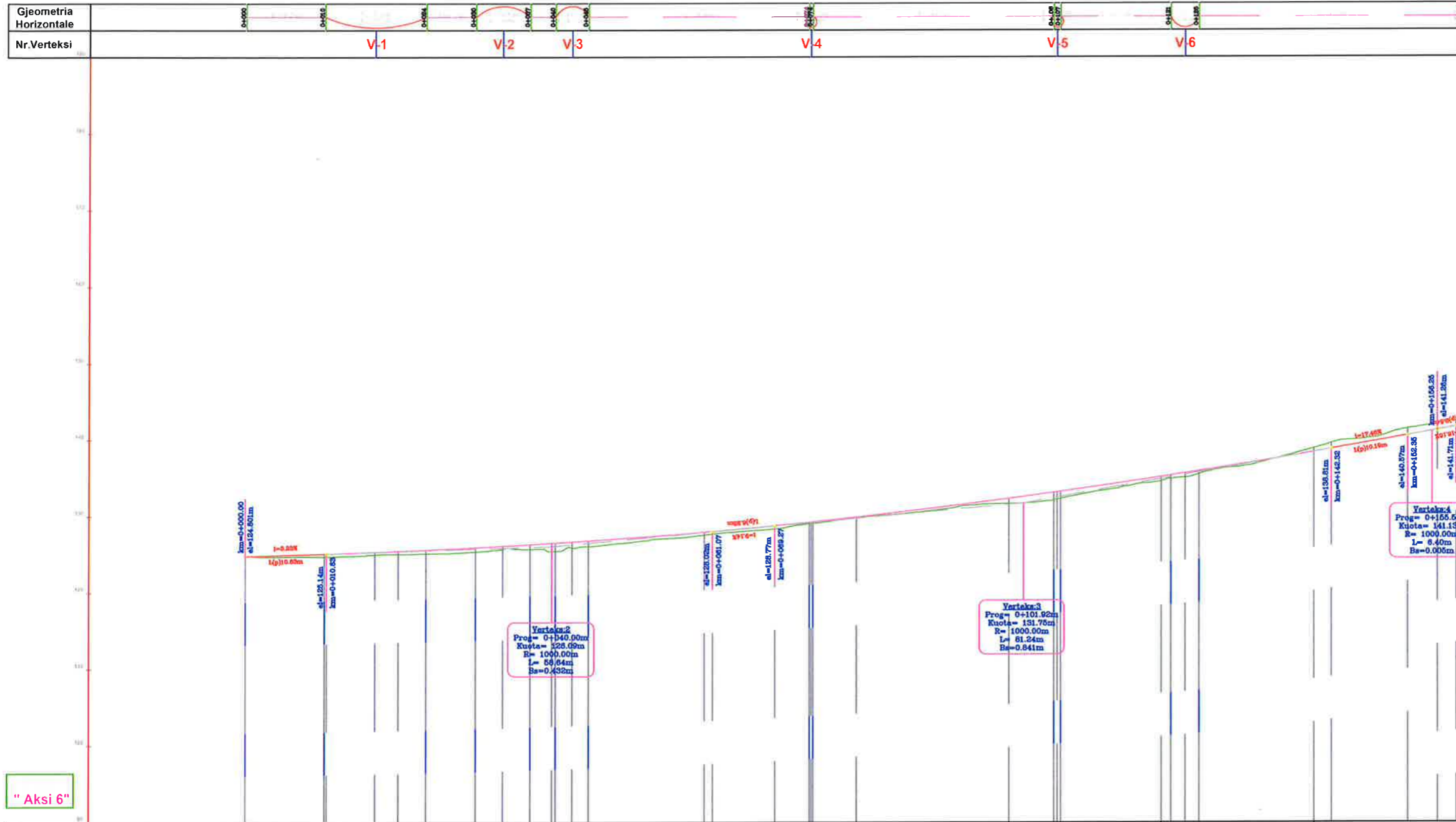

CS-NR.		0+000	0+020	0+040	0+060	0+080	0+100	0+120	0+140
Distanca	Pjesore		20	20	20	20	20	20	20
	Progresive	0+000	0+020	0+040	0+060	0+080	0+100	0+120	0+140
Kuota	Terreni	125.00	125.00	125.47	127.60	129.90	131.67	134.65	138.90
	Projektit	125.00	125.00	125.47	127.60	129.90	131.67	134.65	138.90
	Punes	0.00	0.00	0.00	0.00	0.00	0.00	0.00	0.00



"Aksi 6"

BASHKIA KAMEZ
 DREJTORIA E SHERBIMEVE PUBLIKE
 DREJTORIA E PROJEKTEVE DHE INVESTIMEVE
 DEPARTAMENTI I PROJEKTEVE

Dr. e Projekteve e Investimeve: FLORA MUÇA

STAFI TEKNIK PROJEKTES

Ing. Konstruktor	DENIS PRENCI
Ing. Hidroteknik	HAJREDIN MURGU
Ing. Gjeoinformatik	ERBLIN LALA
Topograf	RAMADAN HYSA

Faza e Projektit: PROJEKT ZBATIMI
 Data e Implementimit:
 Shkalla e Vizatimit:
 Emeritimi i Fletes:
 Flota Nr.: T-8

OBJEKTI: NDËRTIM RRUGËT "Mustafa Kruja + Musa Fratari + Myslim Peza + Mustafa Kaçaçi + Mustafa Atatunku + Mujo Ulqinaku + Rr. pingul me Azem Hajdarin", Babrru Kodër e Kuqe

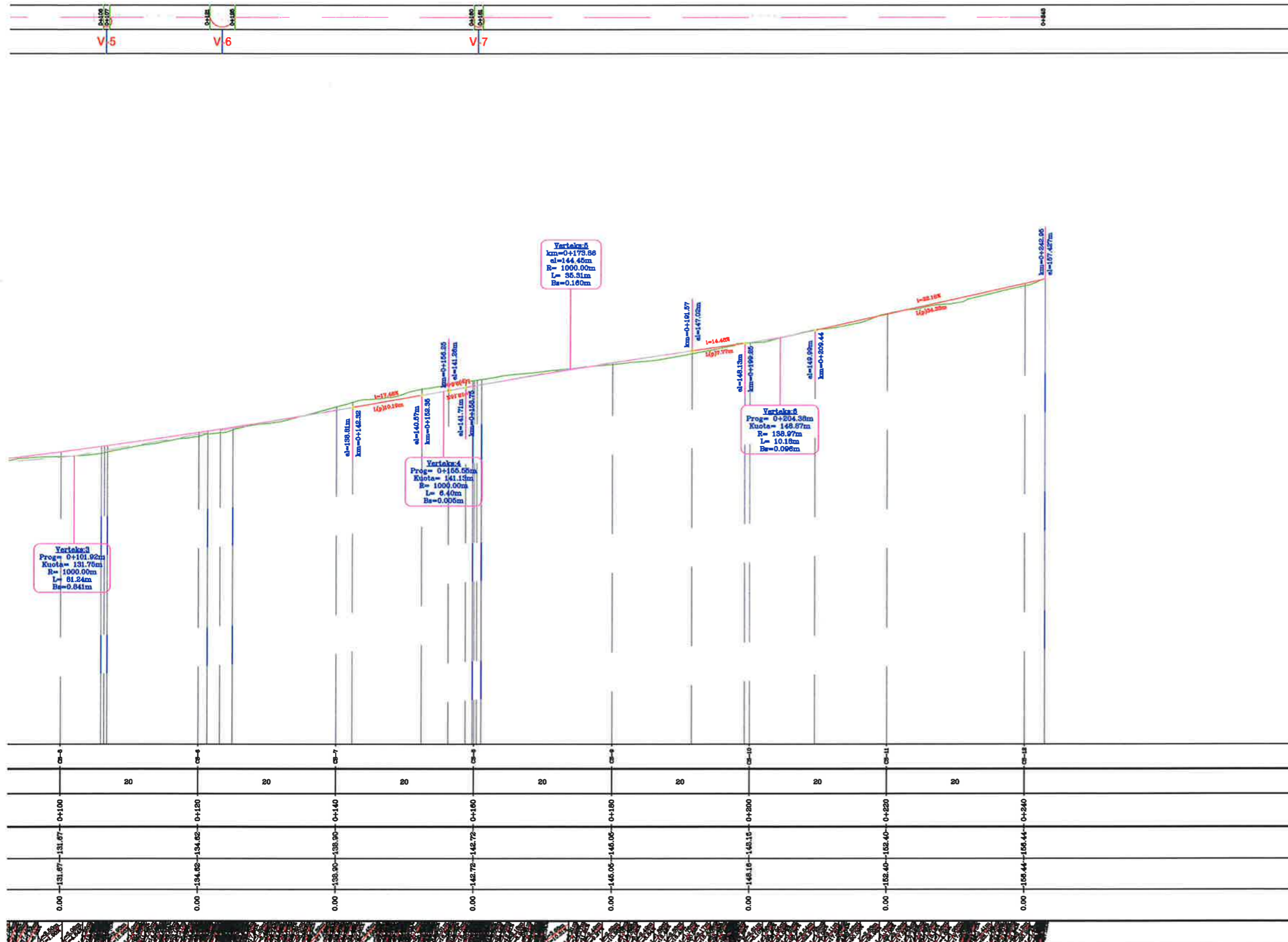

BASHKIA KAMEZ

DREJTORIA E SHERBIMEVE PUBLIKE
DREJTORIA E PROJEKTEVE DHE INVESTIMEVE
DEPARTAMENTI I PROJEKTEVE

Dr. e Projekteve e Investimeve **FLORA MUÇA**

STAFI TEKNIK
PROJEKTUES
Ing. Konstruktor DENIS PRENCI
Ing. Hidroteknik HAJREDIN MURGU
Ing. Gjeoinformatik ERBLIN LALA
Topograf RAMADAN HYSA

Titulli i Projektit:
NDËRTIM RRUGËT "Mustafa Kruja + Musa Fratari + Myslim Peza + Mustafa Kaçaçi + Mustafa Atatunku + Mujo Ulqinaku + Rr. pingul me Azem Hajdarin", Babrru Kodër e Kuqe

Faza e Projektit:
PROJEKT ZBATIMI

Data e Implementimit:

Shkalla e Vizatimit:

Emertimi i Flotes:

Fleta Nr.

PROFIL GJATESOR

T-9

OBJEKTI: NDËRTIM RRUGËT "Mustafa Kruja + Musa Fratari + Myslim Peza + Mustafa Kaçaçi + Mustafa Atatunku + Mujo Ulqinaku + Rr. pingul me Azem Hajdarin", Babrru Kodër e Kuqe

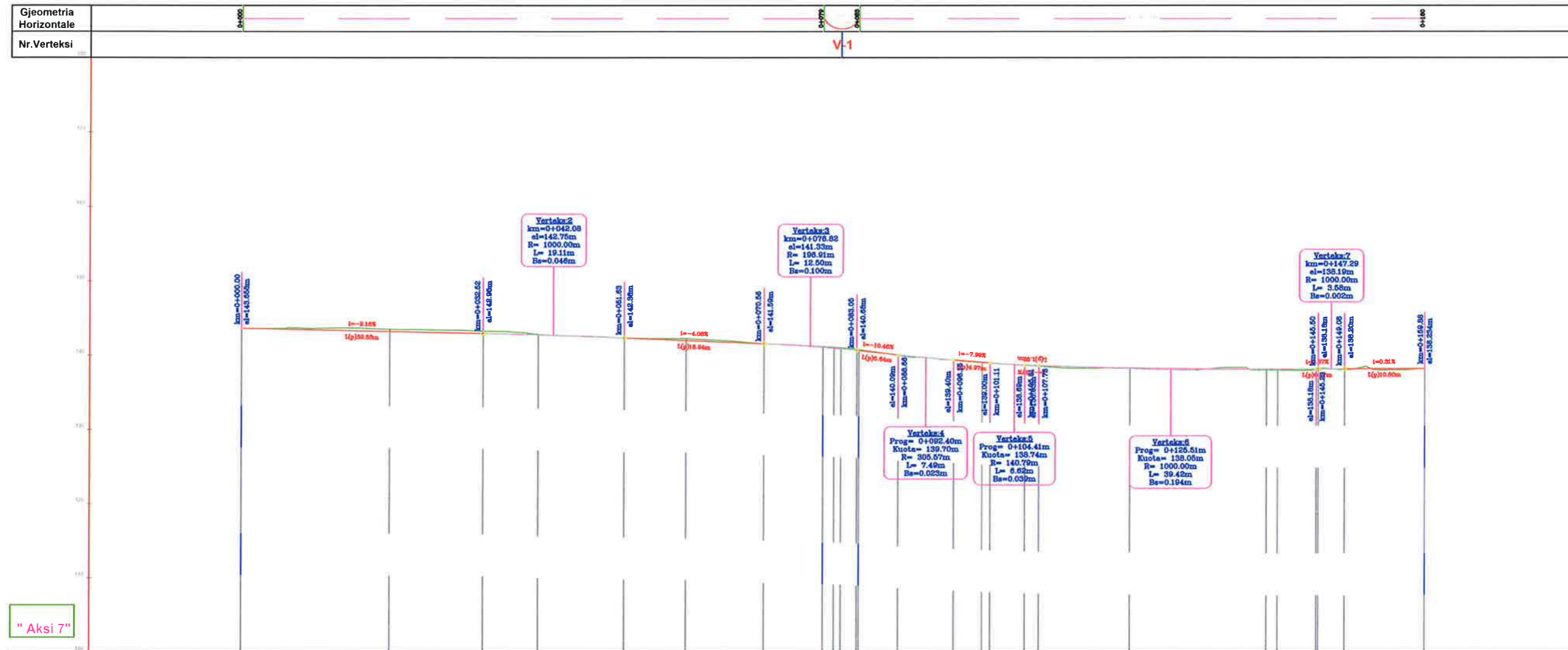

CS-NR.	
Distanca	Pjesore
	Progresive
Kuota	Tereni
	Projektit
	Punes
Gjeometria Vertikale	

"Aksi 7"



BASHKIA KAMEZ

DREJTORIA E SHERBIMEVE PUBLIKE
DREJTORIA E PROJEKTEVE DHE INVESTIMEVE
DEPARTAMENTI I PROJEKTEVE

Dr. e Projekteve e Investimeve FLORA MUÇA

STAFI TEKNIK PROJEKTES	Ing. Konstruktor	DENIS PRENCI
	Ing. Hidroteknik	HAJREDIN MURGU
	Ing. Gjeoinformatik	ERBLIN LALA
	Topograf	RAMADAN HYSA

Tiulli i Projektit:
NDERTIM RRUGËT "Mustafa Kruja + Musa Fratari + Myslim Peza + Mustafa Kaçaçi + Mustafa Atatunku + Mujo Ulqinaku + Rr. pingul me Azem Hajdarin", Babrru Kodër e Kuqe

Faza e Projektit:
PROJEKT ZBATIMI

Data e Implementimit:

Shkalla e Vizatimit:

Emertimi i Fletes:

Fleta Nr.
T-10

PROFIL GJATESOR

OBJEKTI: NDËRTIM RRUGËT "Mustafa Kruja + Musa Fratari + Myslim Peza + Mustafa Kaçaçi + Mustafa Atatunku + Mujo Ulqinaku + Rr. pingul me Azem Hajdarin", Babrru Kodër e Kuqe

PROFILI 1

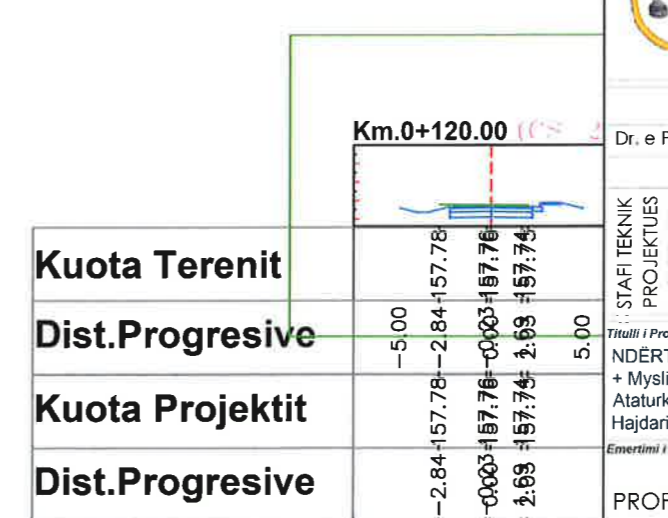
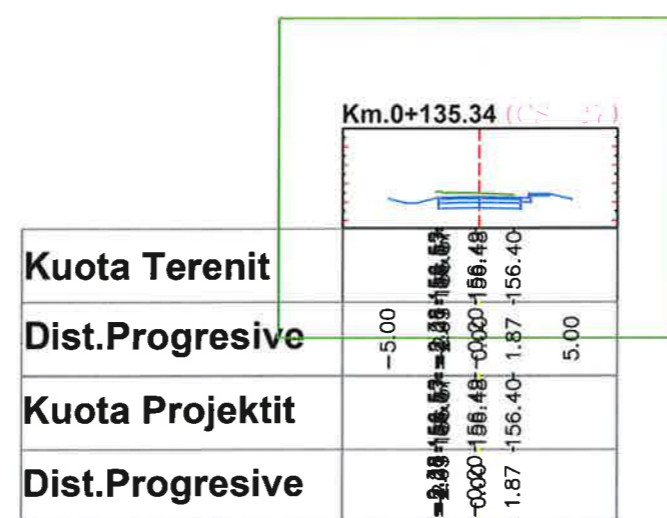
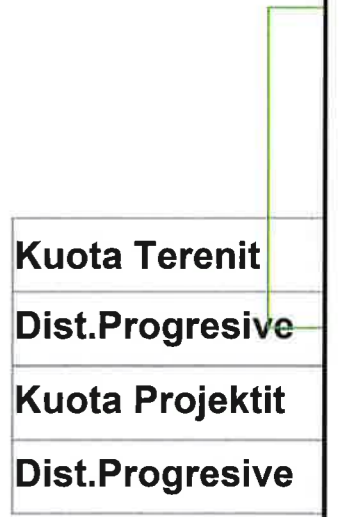
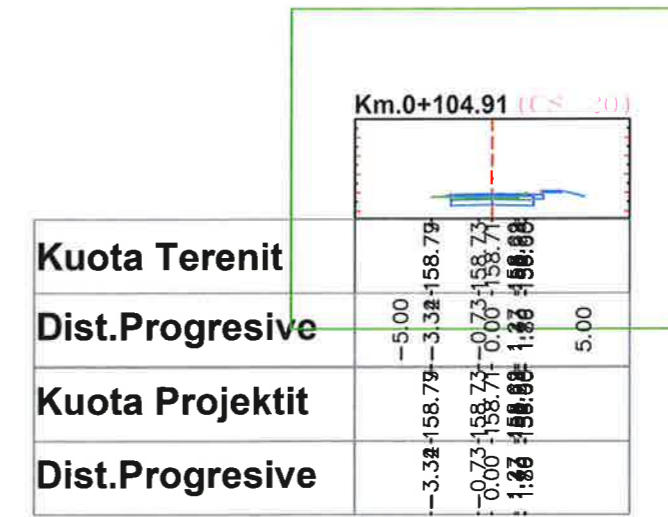
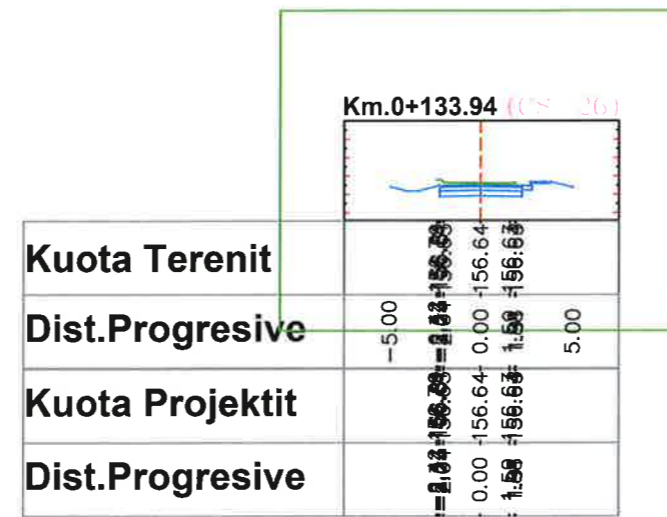
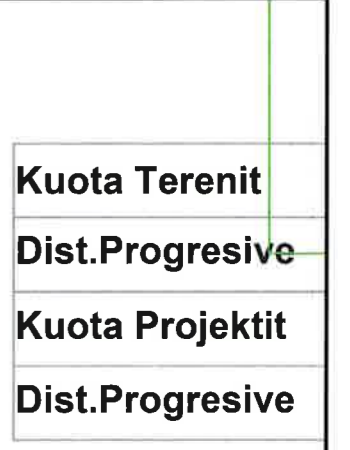
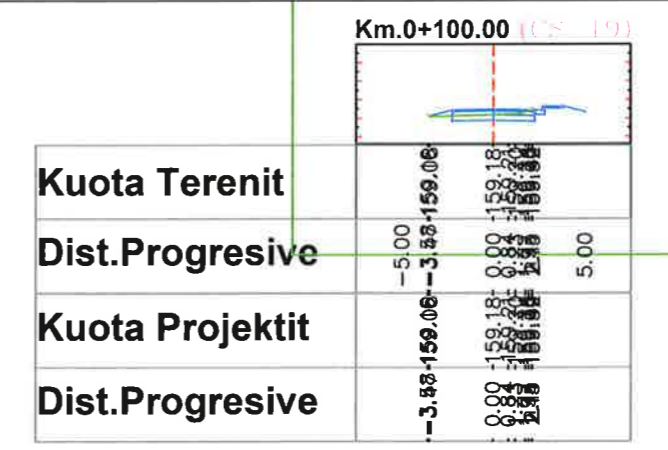
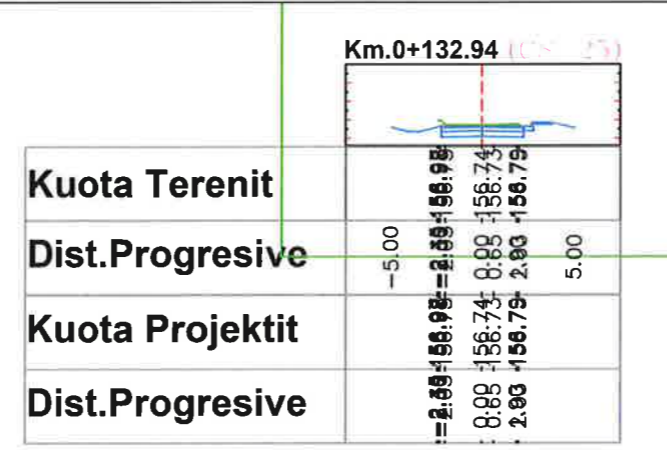
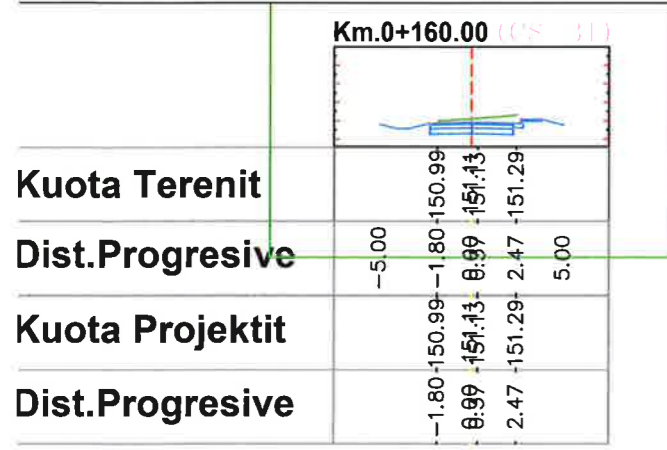

BASHKIA KAMEZ
 DREJTORIA E SHERBIMEVE PUBLIKE
 DREJTORIA E PROJEKTEVE DHE INVESTIMEVE
 DEPARTAMENTI I PROJEKTEVE

Dr. e Projekteve e Investimeve **FLORA MUÇA**

STAFI TEKNIK
 Ing. Konstruktor DENIS PRENCI
 Ing. Hidroteknik HAJREDIN MURGU
 Ing. Gjeoinformatik ERBLIN LALA
 Topograf RAMADAN HYSA

Titulli i Projektit:
 NDËRTIM RRUGËT "Mustafa Kruja + Musa Fratari + Myslim Peza + Mustafa Kaçaçi + Mustafa Atatunku + Mujo Ulqinaku + Rr. pingul me Azem Hajdarin", Babrru Kodër e Kuqe

Faza e Projektit:
 PROJEKT ZBATIMI

Data e Implementimit:
 Shkalla e Vizatimit:
 Emeritimi i Fletes:
 PROFILAT TERTHOR

Fleta Nr.
T-11

OBJEKTI: NDËRTIM RRUGËT "Mustafa Kruja + Musa Fratari + Myslim Peza + Mustafa Kaçaçi + Mustafa Ataturku + Mujo Ulqinaku + Rr. pingul me Azem Hajdarin", Babrru Kodër e Kuqe

PROFILI 1

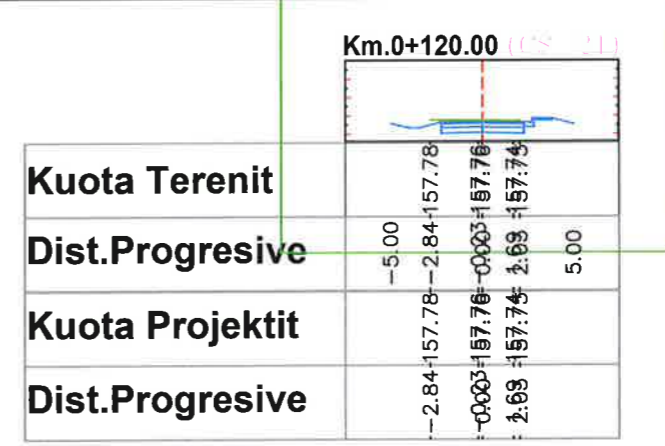
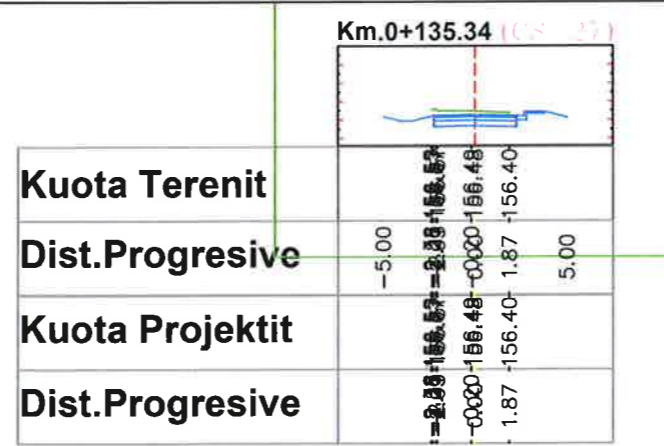
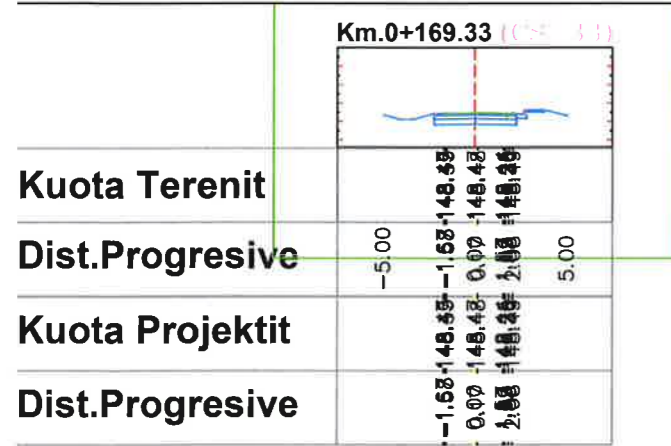

Kuota Terenit
Dist.Progressive
Kuota Projektit
Dist.Progressive

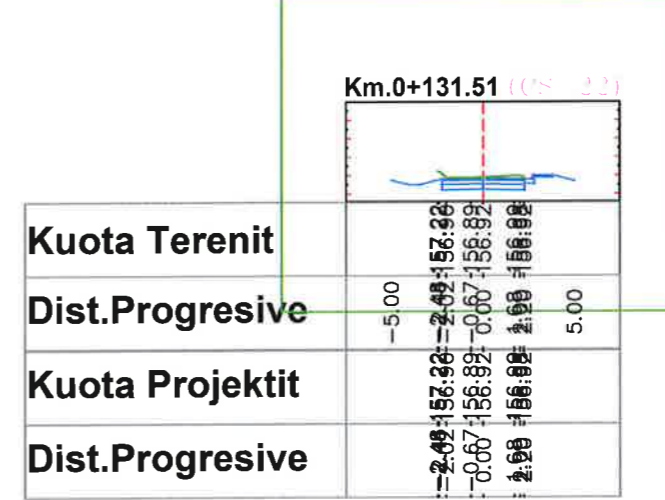
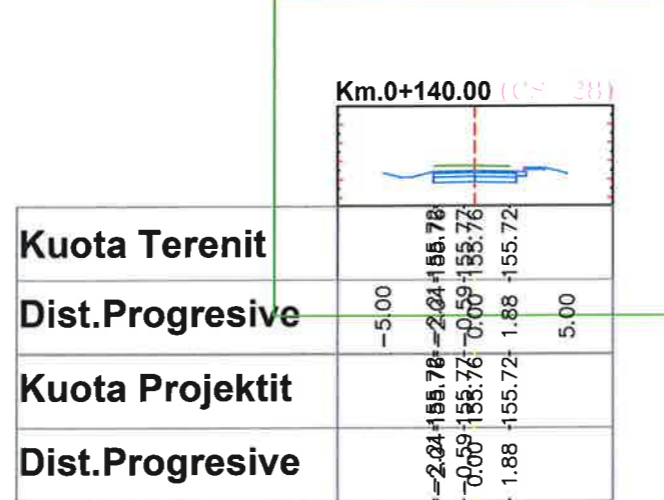
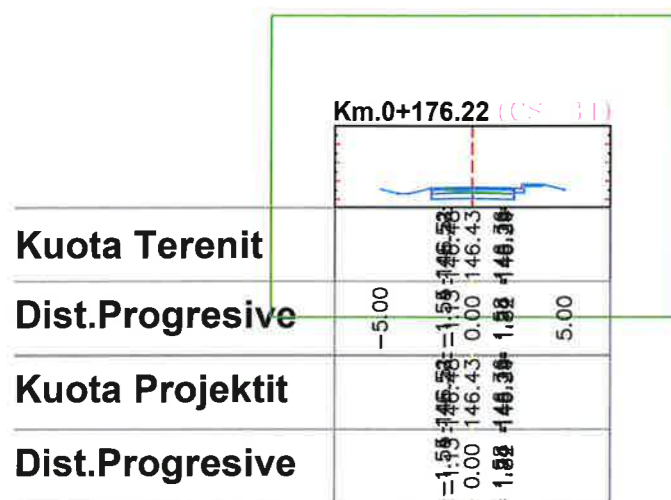

Kuota Terenit
Dist.Progressive
Kuota Projektit
Dist.Progressive

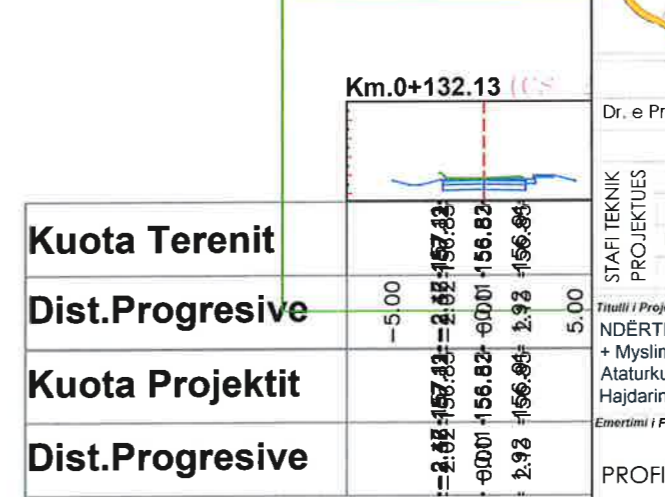
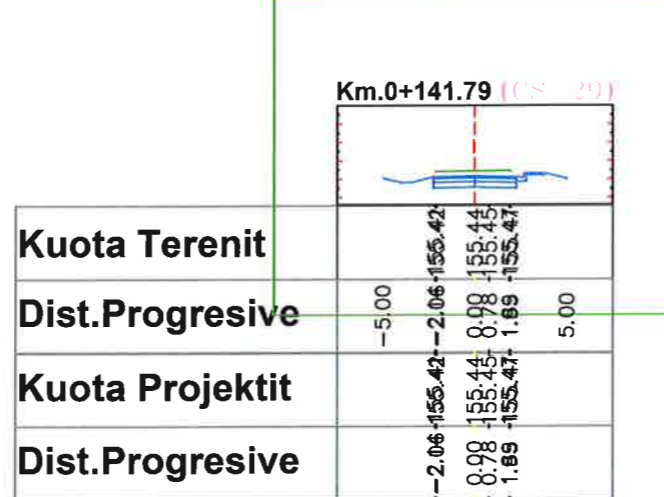
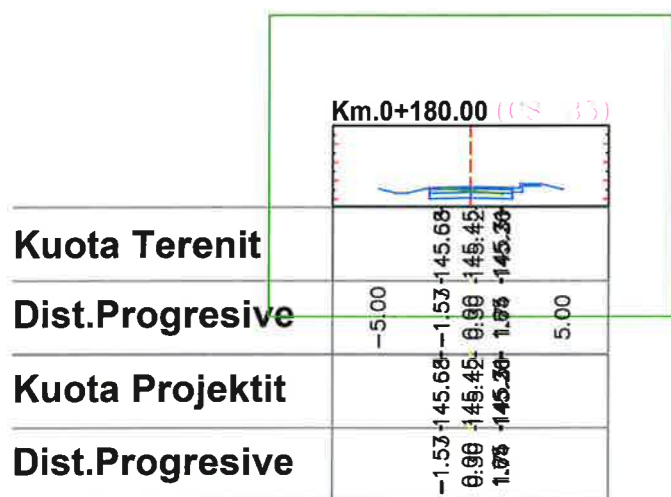

Kuota Terenit
Dist.Progressive
Kuota Projektit
Dist.Progressive

BASHKIA KAMEZ
 DREJTORIA E SHERBIMEVE PUBLIKE
 DREJTORIA E PROJEKTEVE DHE INVESTIMEVE
 DEPARTAMENTI I PROJEKTEVE

Dr. e Projekteve e Investimeve **FLORA MUÇA**

STAFI TEKNIK	Ing. Konstruktor	DENIS PRENCI
PROJEKTES	Ing. Hidroteknik	HAJREDIN MURGU
	Ing. Gjeoinformatik	ERBLIN LALA
PROJEKTES	Topograf	RAMADAN HYSA

Titulli i Projektit:
 NDËRTIM RRUGËT "Mustafa Kruja + Musa Fratari + Myslim Peza + Mustafa Kaçaçi + Mustafa Ataturku + Mujo Ulqinaku + Rr. pingul me Azem Hajdarin", Babrru Kodër e Kuqe

Faza e Projektit:
 PROJEKT ZBATIMI

Data e Implementimit:

Shkalla e Vizatimit:

Emertimi i Fletes:

PROFILAT TERTHOR

Fleta Nr.
T-12

OBJEKTI: NDËRTIM RRUGËT "Mustafa Kruja + Musa Fratari + Myslim Peza + Mustafa Kaçaçi + Mustafa Atatunku + Mujo Ulqinaku + Rr. pingul me Azem Hajdarin", Babrru Kodër e Kuqe

PROFILI 2

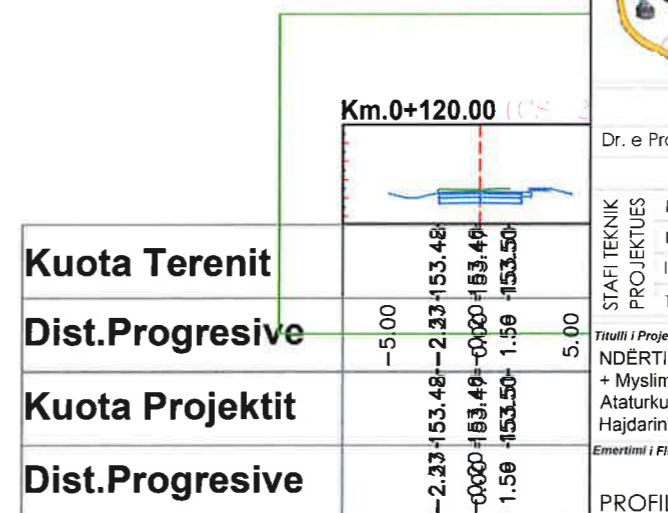
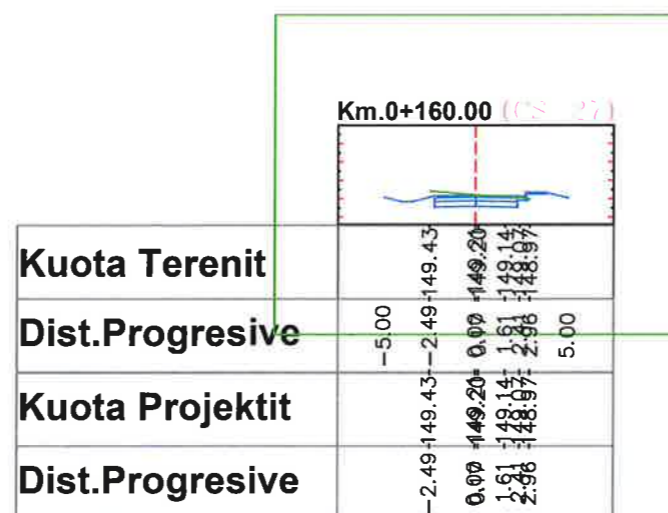
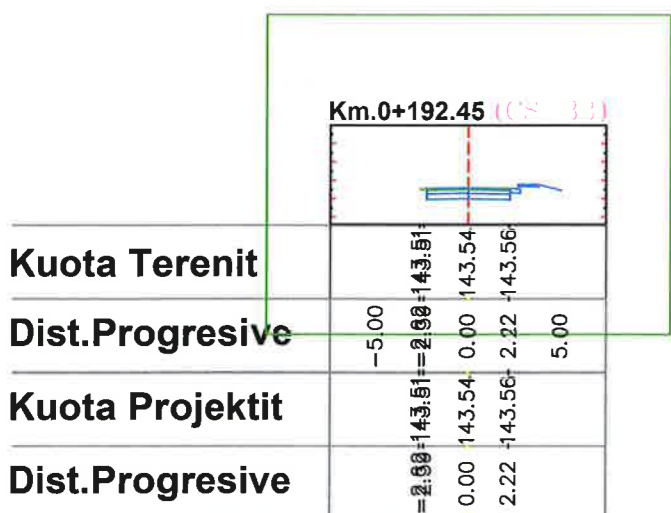
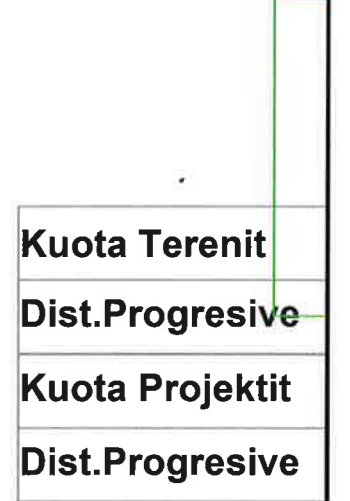
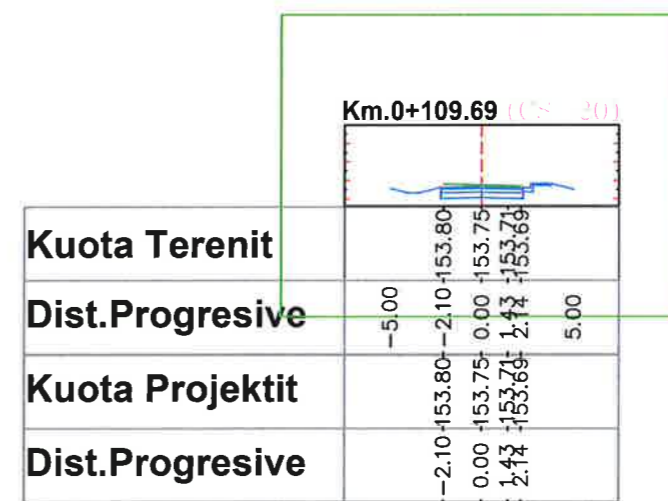
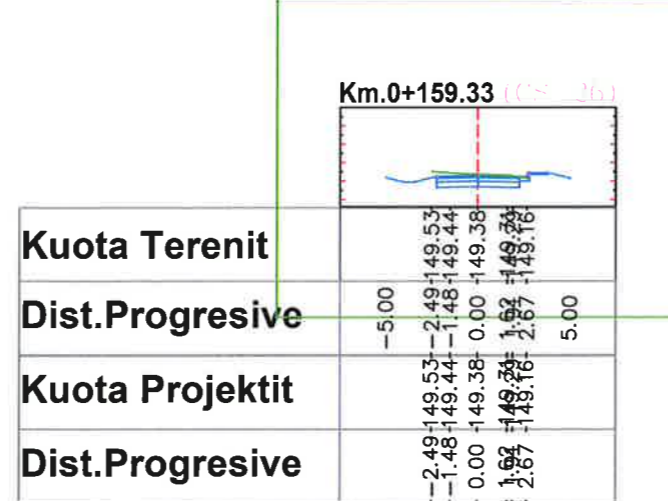
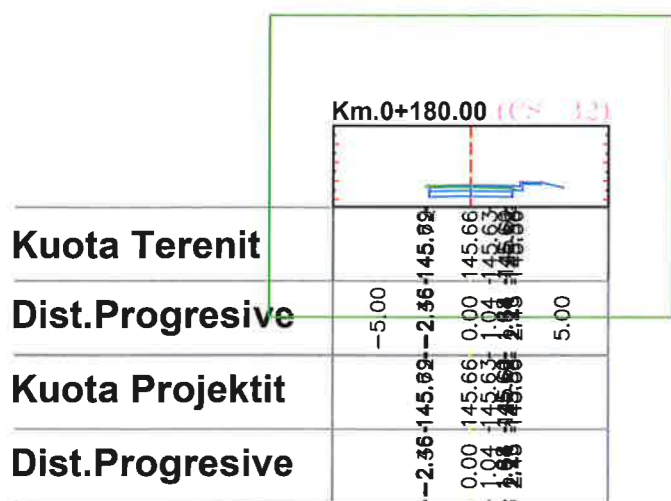
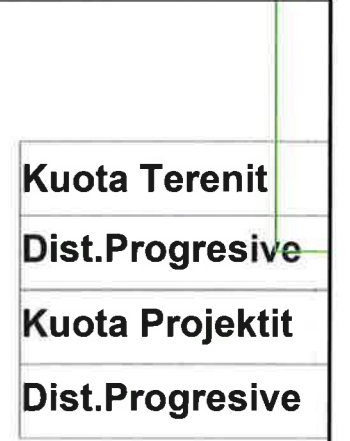
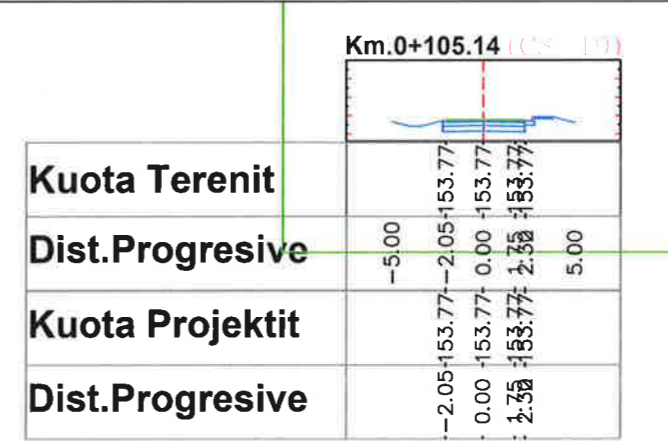
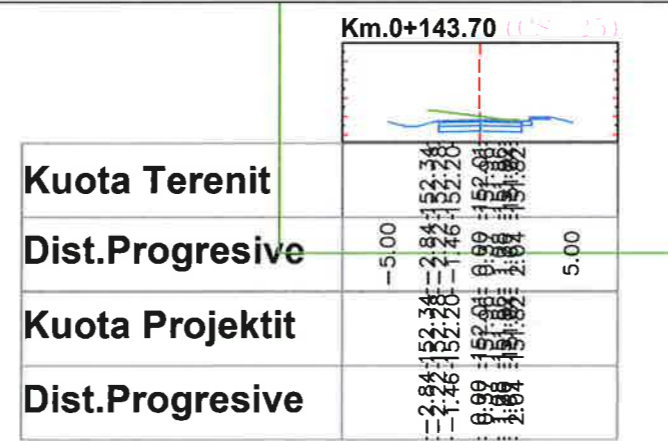
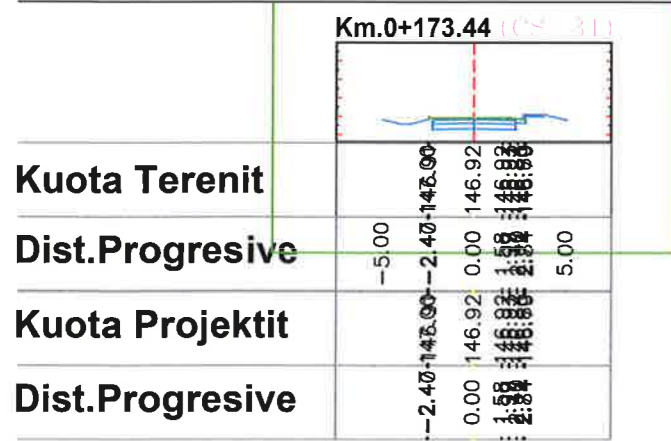

BASHKIA KAMEZ
 DREJTORIA E SHERBIMEVE PUBLIKE
 DREJTORIA E PROJEKTEVE DHE INVESTIMEVE
 DEPARTAMENTI I PROJEKTEVE

Dr. e Projekteve e Investimeve **FLORA MUÇA**

STAFI TEKNIK
 Ing. Konstruktor DENIS PRENCI
 Ing. Hidroteknik HAJREDIN MURGU
 Ing. Gjeoinformatik ERBLIN LALA
 Topograf RAMADAN HYSA

Titulli i Projektit:
 NDËRTIM RRUGËT "Mustafa Kruja + Musa Fratari + Myslim Peza + Mustafa Kaçaçi + Mustafa Atatunku + Mujo Ulqinaku + Rr. pingul me Azem Hajdarin", Babrru Kodër e Kuqe

Faza e Projektit:
 PROJEKTZBATIMI

Data e Implementimit:

Shkalla e Vizatimit:

Emertimi i Fletes:
 PROFILAT TERTHOR

Fleta Nr.
T-13

OBJEKTI: NDËRTIM RRUGËT "Mustafa Kruja + Musa Fratari + Myslim Peza + Mustafa Kaçaçi + Mustafa Ataturku + Mujo Ulqinaku + Rr. pingul me Azem Hajdarin", Babrru Kodër e Kuqe

PROFILI 2

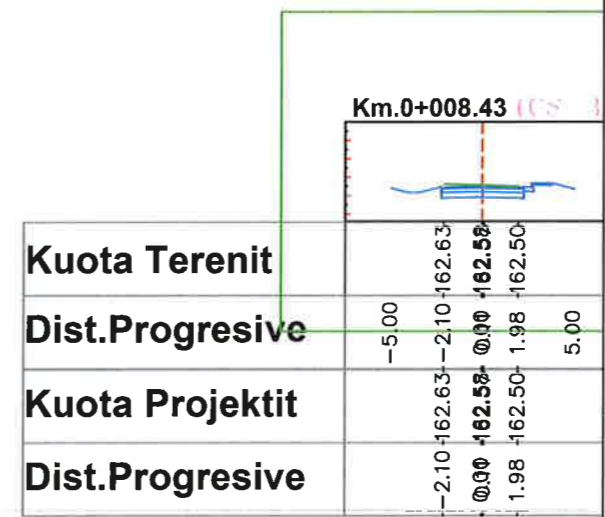
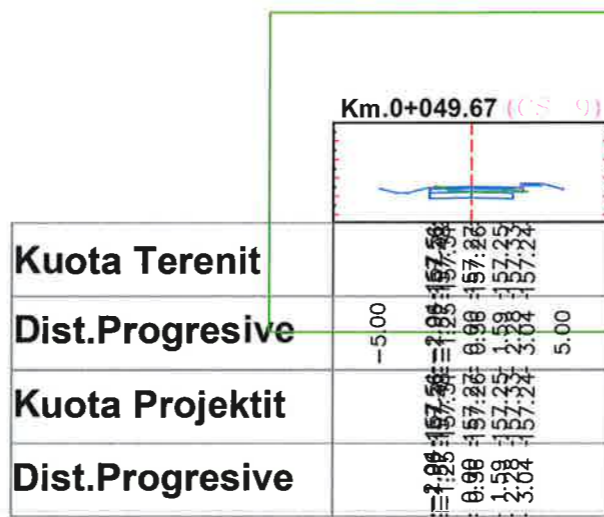
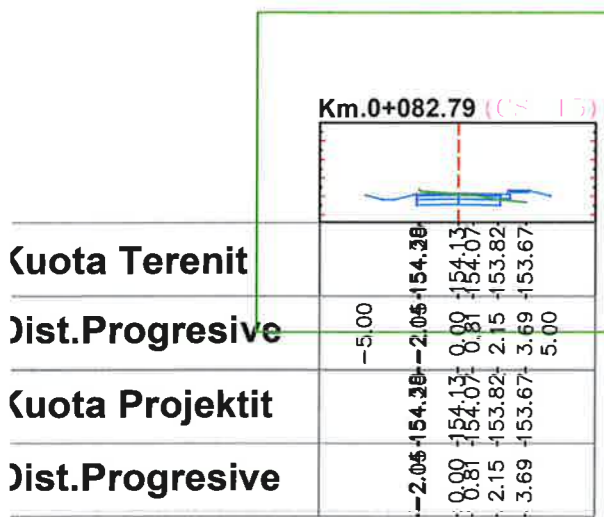
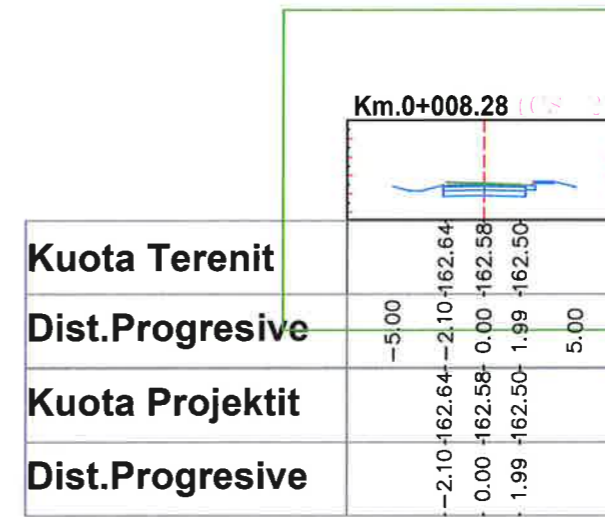
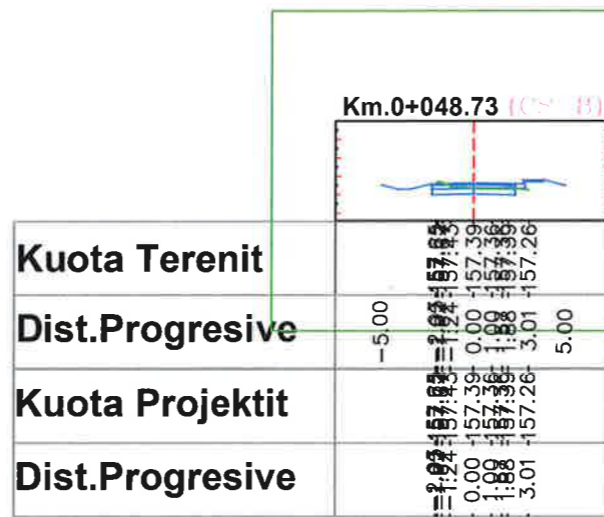
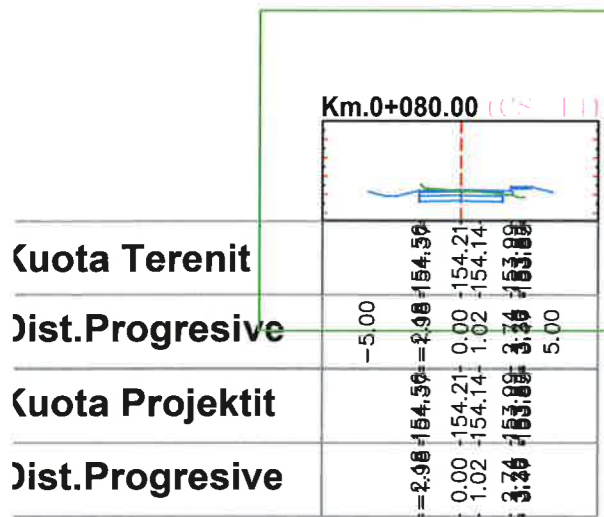
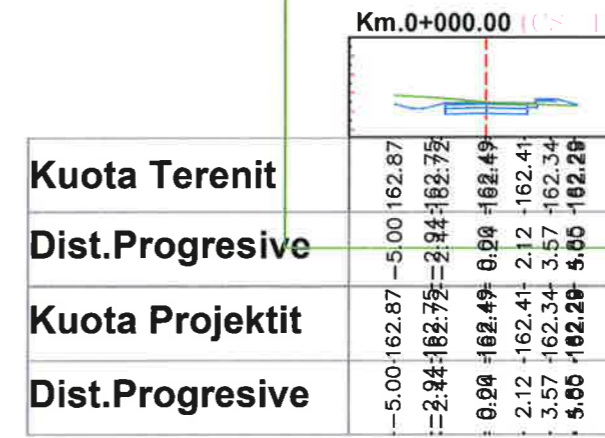
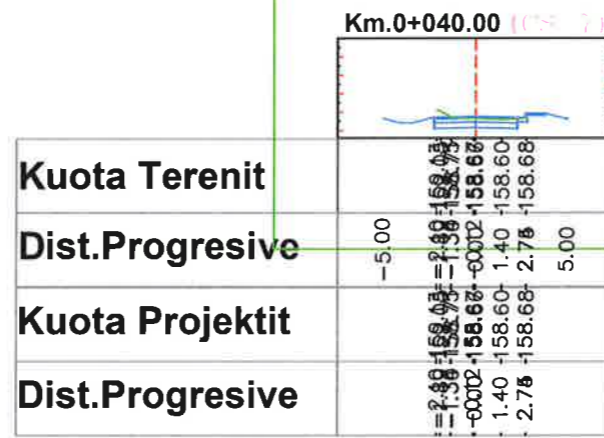
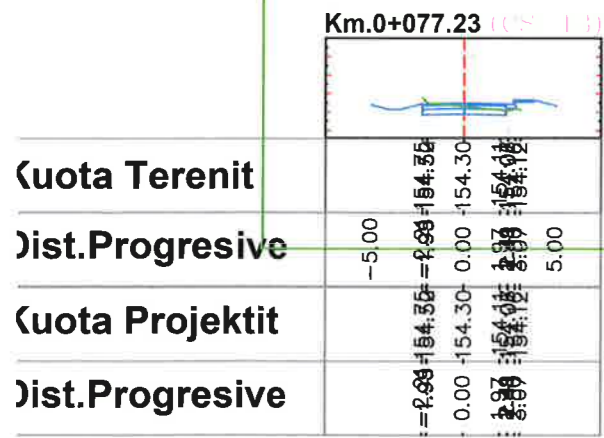



BASHKIA KAMEZ

DREJTORIA E SHERBIMEVE PUBLIKE
DREJTORIA E PROJEKTEVE DHE INVESTIMEVE
DEPARTAMENTI I PROJEKTEVE

Dr. e Projekteve e Investimeve **FLORA MUÇA**

STAFI TEKNIK PROJEKTES	Ing. Konstruktor	DENIS PRENCI
	Ing. Hidroteknik	HAJREDIN MURGU
	Ing. Gjeoinformatik	ERBLIN LALA
	Topograf	RAMADAN HYSA

Titulli i Projektit:
NDËRTIM RRUGËT "Mustafa Kruja + Musa Fratari + Myslim Peza + Mustafa Kaçaçi + Mustafa Ataturku + Mujo Ulqinaku + Rr. pingul me Azem Hajdarin", Babrru Kodër e Kuqe

Faza e Projektit:
PROJEKT ZBATIMI

Data e Implementimit:

Shkalla e Vizatimit:

Emeritimi i Fletes:

PROFILAT TERTHOR

Fleta Nr.
T-14

OBJEKTI: NDËRTIM RRUGËT "Mustafa Kruja + Musa Fratari + Myslim Peza + Mustafa Kaçaçi + Mustafa Ataturku + Mujo Ulqinaku + Rr. pingul me Azem Hajdarin", Babrru Kodër e Kuqe

PROFILI 2

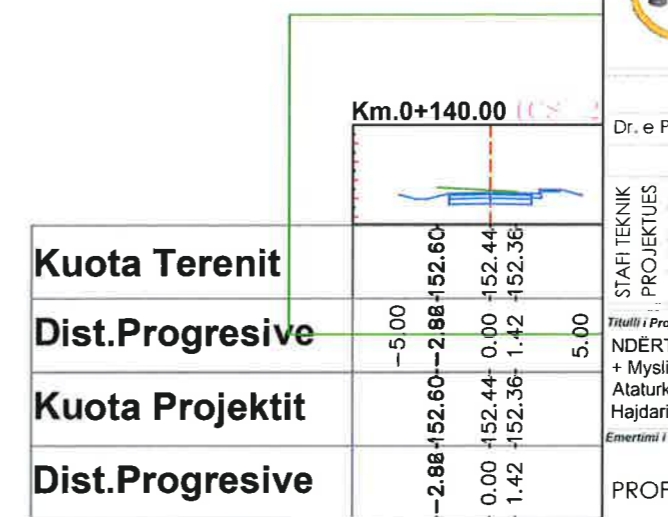
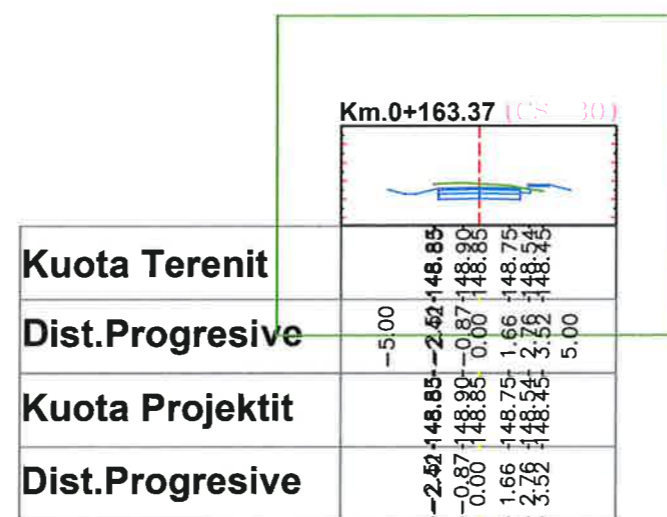
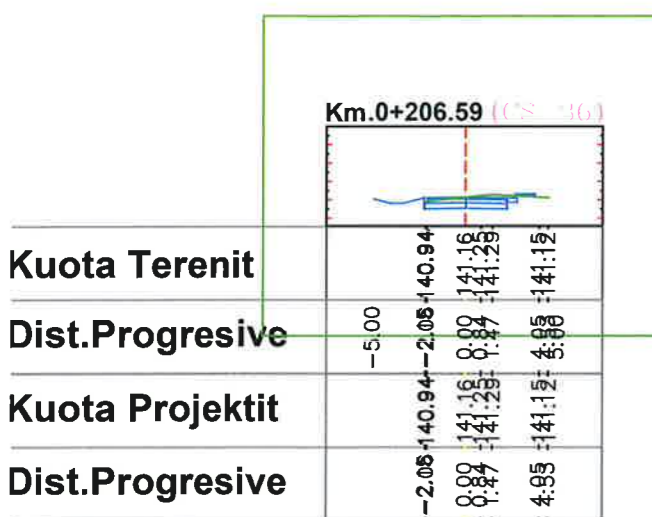
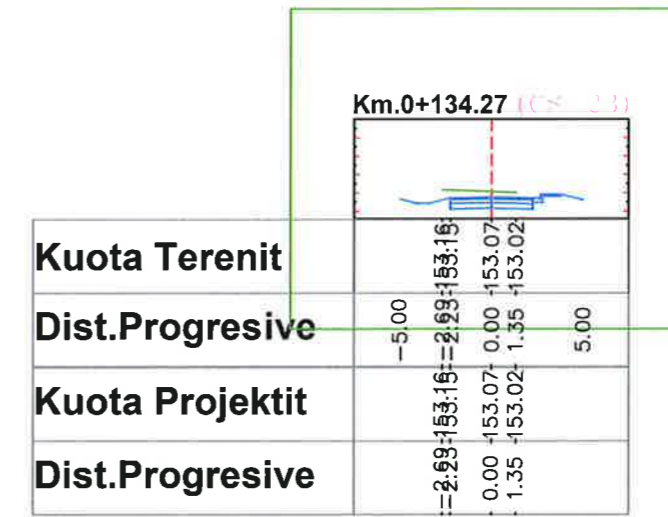
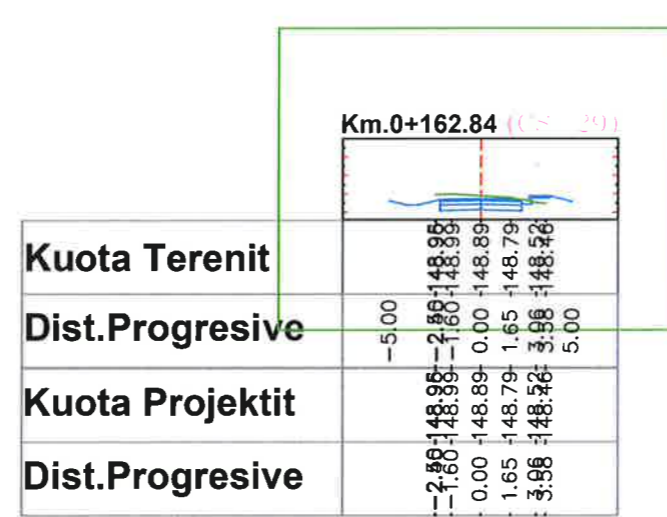
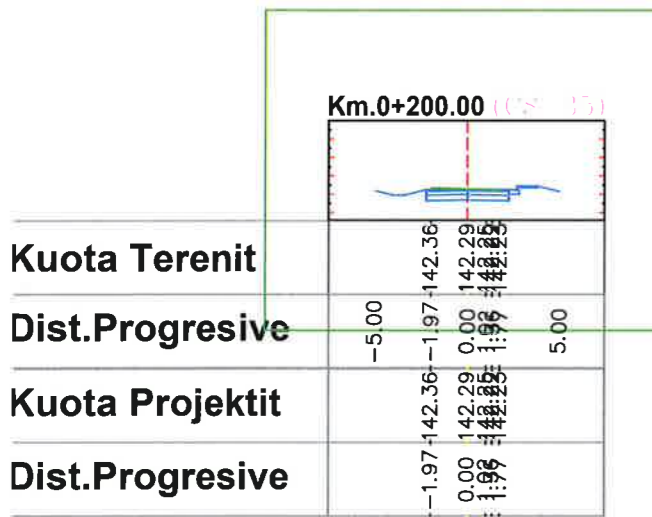
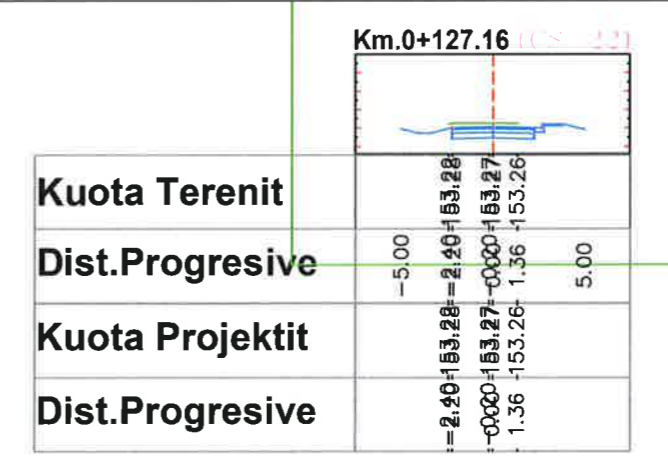
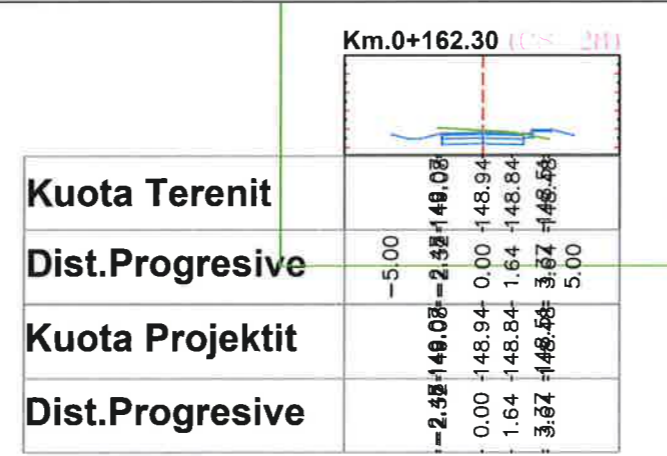
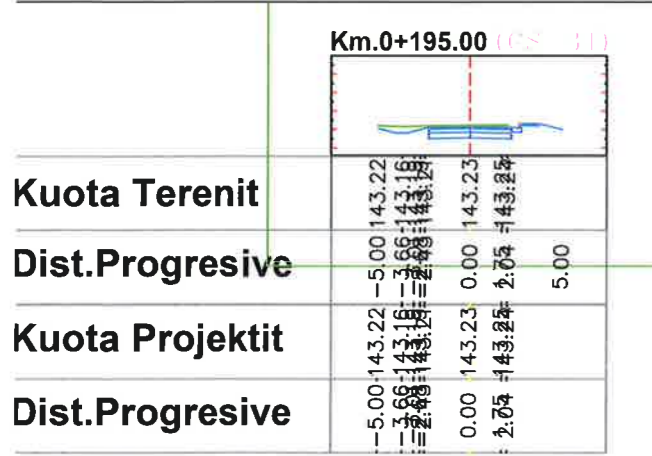

BASHKIA KAMEZ
 DREJTORIA E SHERBIMEVE PUBLIKE
 DREJTORIA E PROJEKTEVE DHE INVESTIMEVE
 DEPARTAMENTI I PROJEKTEVE

Dr. e Projekteve e Investimeve **FLORA MUÇA**

STAFI TEKNIK
 Ing. Konstruktor DENIS PRENCI
 Ing. Hidroteknik HAJREDIN MURGU
 Ing. Gjeoinformatik ERBLIN LALA
 Topograt RAMADAN HYSA

Titulli i Projektit:
 NDËRTIM RRUGËT "Mustafa Kruja + Musa Fratari + Myslim Peza + Mustafa Kaçaçi + Mustafa Ataturku + Mujo Ulqinaku + Rr. pingul me Azem Hajdarin", Babrru Kodër e Kuqe

Faza e Projektit:
 PROJEKT ZBATIMI

Data e Implementimit:

Shkalla e Vizatimit:

Emeritimi i Flotes:

PROFILAT TERTHOR

Fieta Nr.
T-15

OBJEKTI: NDËRTIM RRUGËT "Mustafa Kruja + Musa Fratari + Myslim Peza + Mustafa Kaçaçi + Mustafa Ataturku + Mujo Ulqinaku + Rr. pingul me Azem Hajdarin", Babrru Kodër e Kuqe

PROFILI 3

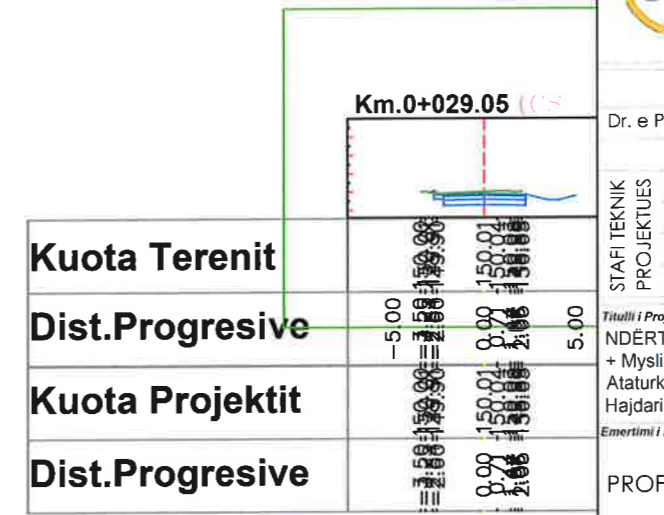
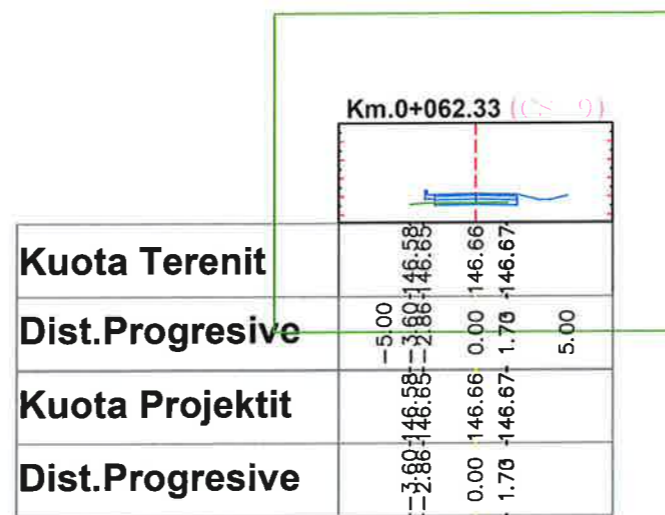
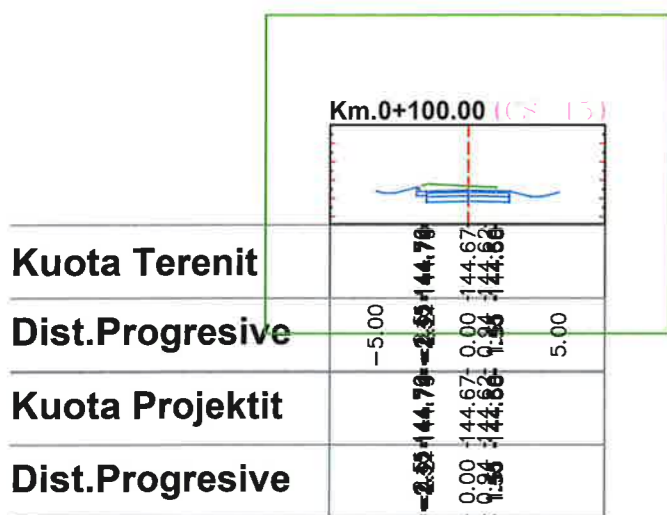
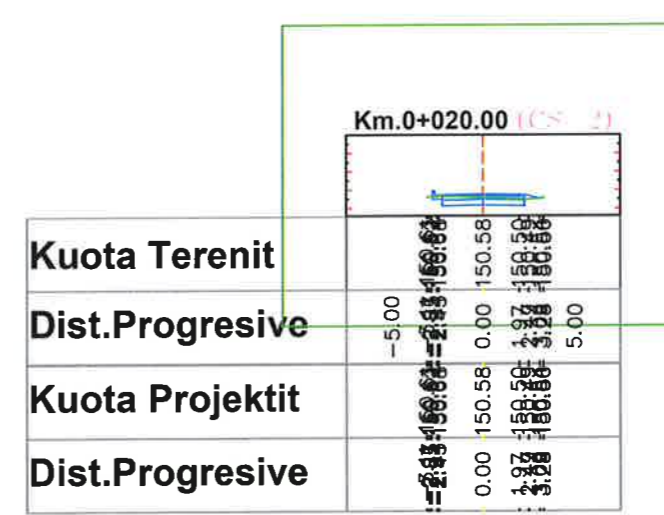
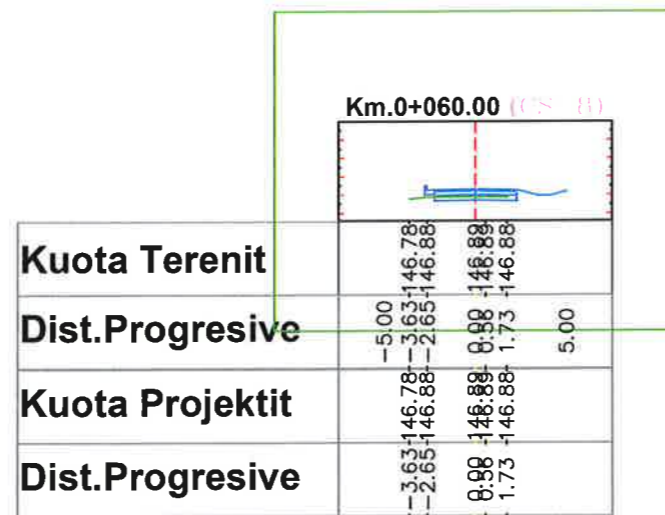
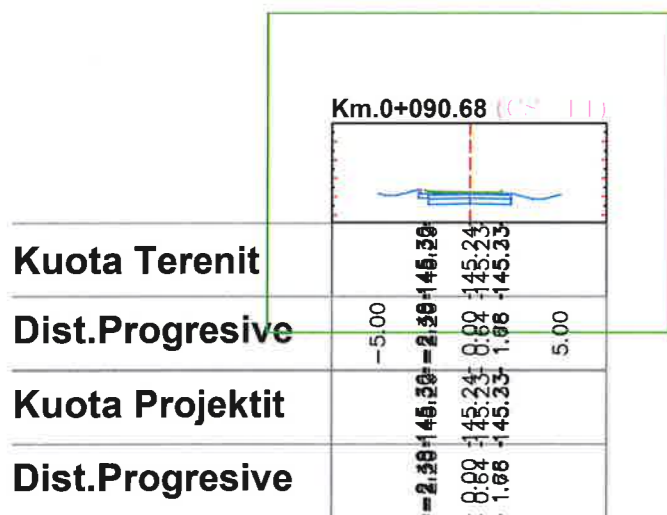
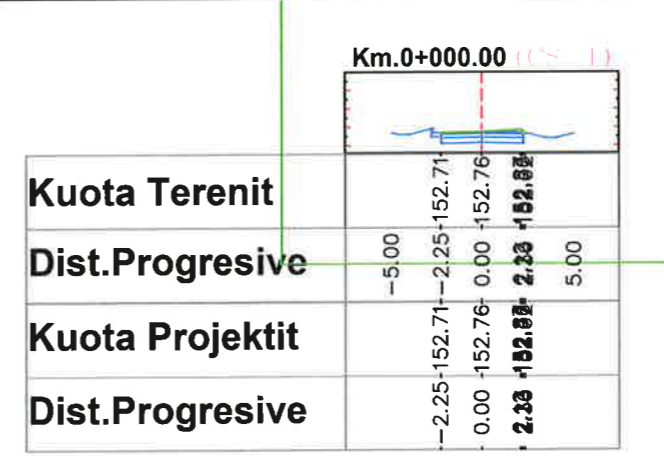
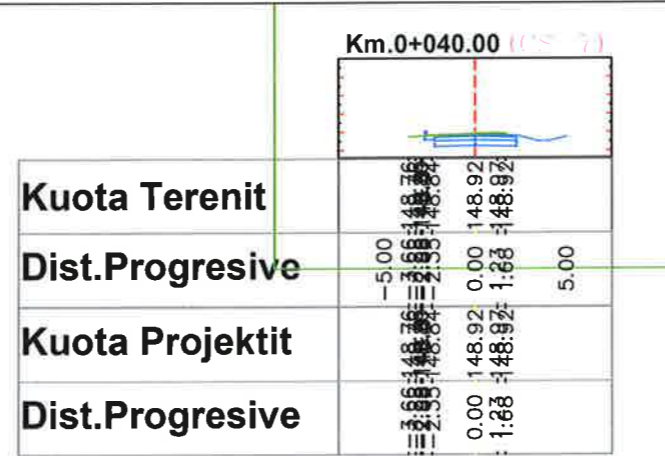
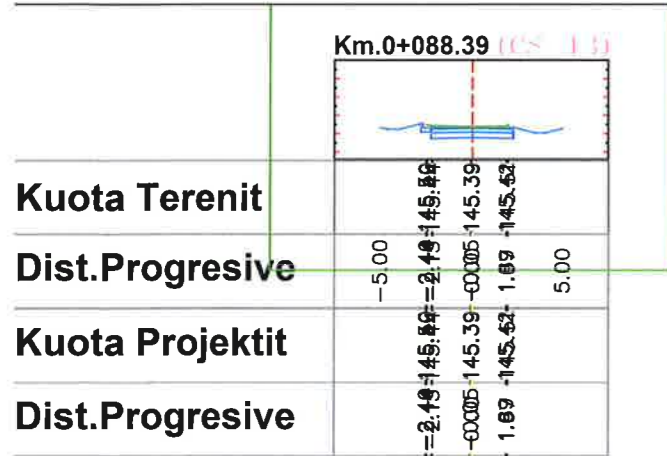



BASHKIA KAMEZ

DREJTORIA E SHERBIMEVE PUBLIKE
DREJTORIA E PROJEKTEVE DHE INVESTIMEVE
DEPARTAMENTI I PROJEKTEVE

Dr. e Projekteve e Investimeve		FLORA MUÇA
STAFI TEKNIK PROJEKTES PROJEKTIT	Ing. Konstruktor	DENIS PRENCI
	Ing. Hidroteknik	HAJREDIN MURGU
	Ing. Gjeoinformatik	ERBLIN LALA
	Topograf	RAMADAN HYSA
Titulli i Projektit: NDËRTIM RRUGËT "Mustafa Kruja + Musa Fratari + Myslim Peza + Mustafa Kaçaçi + Mustafa Ataturku + Mujo Ulqinaku + Rr. pingul me Azem Hajdarin", Babrru Kodër e Kuqe		
Emertimi i Fletes:		
PROFILAT TERTHOR		

Faza e Projektit:
PROJEKT ZBATIMI

Data e Implementimit:

Shkalla e Vizatimit:

Fleta Nr.

T-16

OBJEKTI: NDËRTIM RRUGËT "Mustafa Kruja + Musa Fratari + Myslim Peza + Mustafa Kaçaçi + Mustafa Atatürk + Mujo Ulqinaku + Rr. pingul me Azem Hajdarin", Babrru Kodër e Kuqe

PROFILI 3

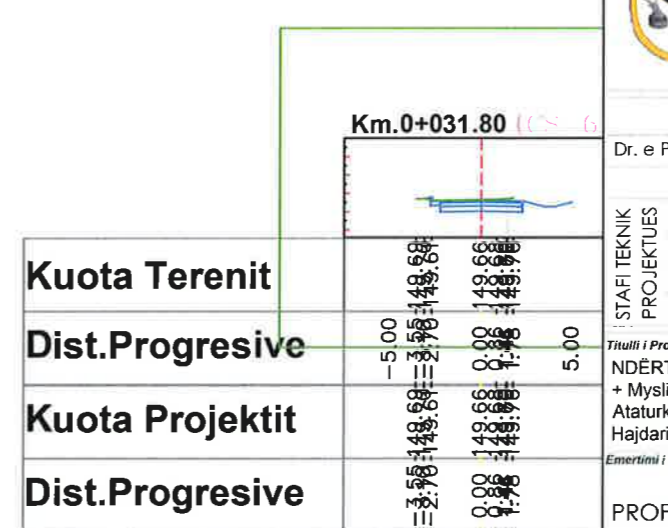
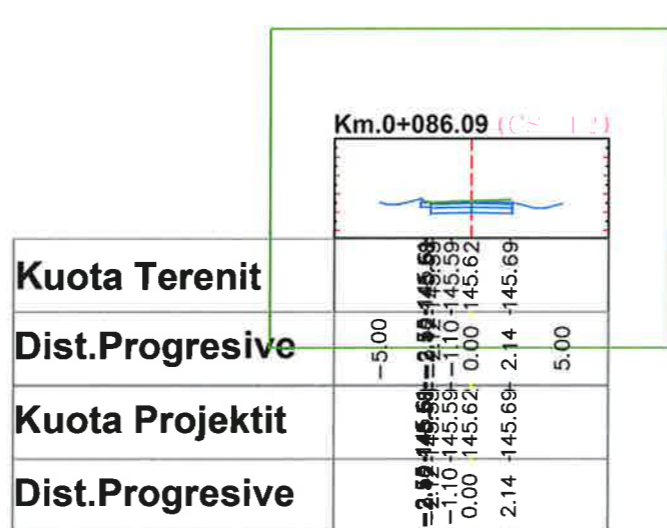
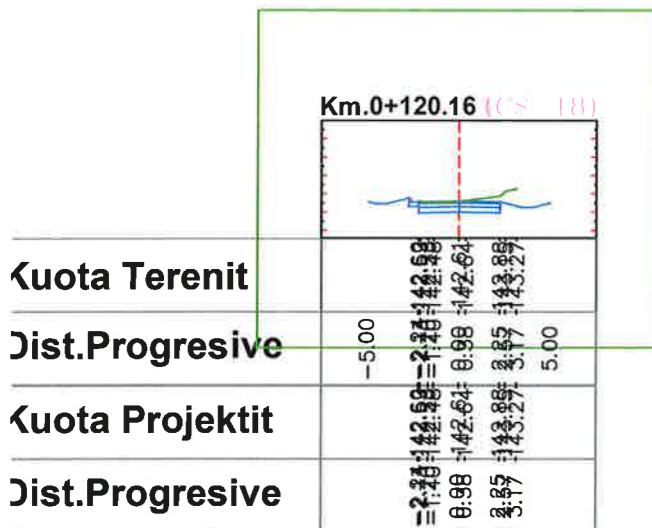
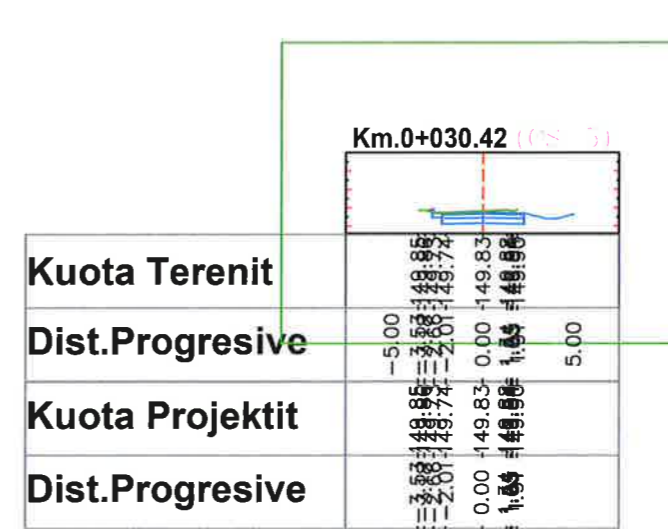
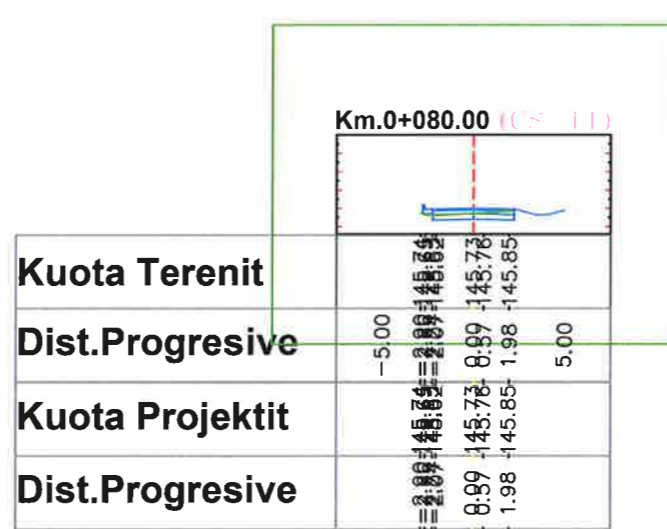
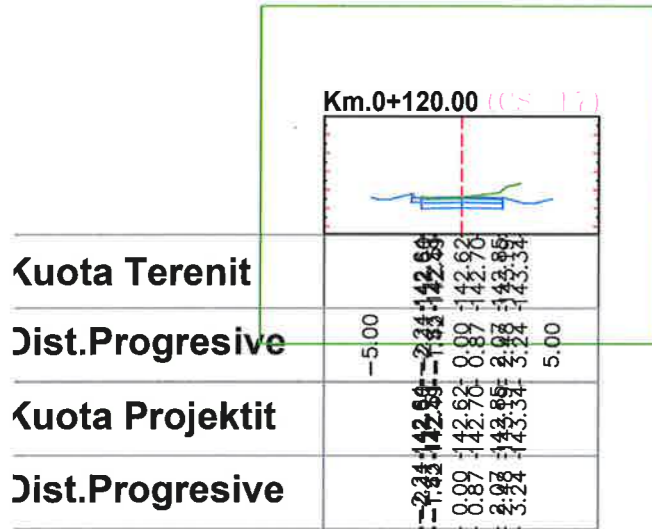
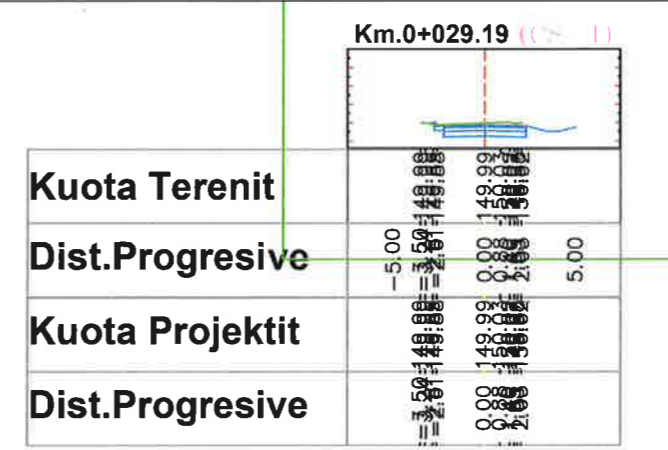
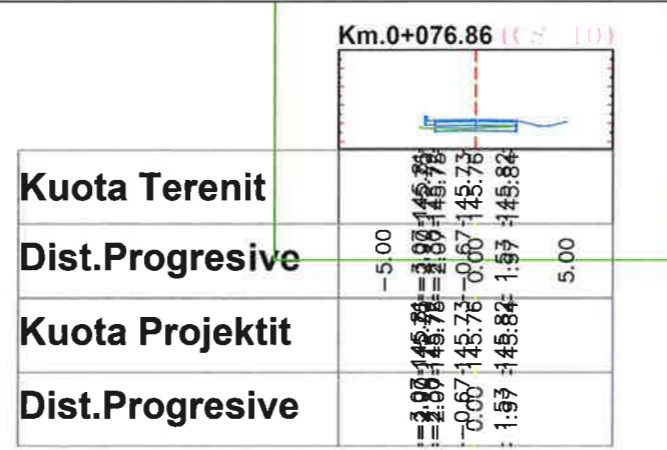
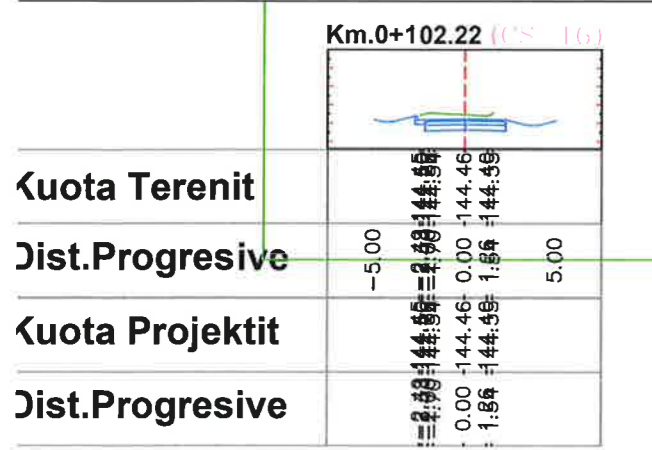



BASHKIA KAMEZ
 DREJTORIA E SHERBIMEVE PUBLIKE
 DREJTORIA E PROJEKTEVE DHE INVESTIMEVE
 DEPARTAMENTI I PROJEKTEVE

Dr. e Projekteve e Investimeve **FLORA MUÇA**

STAFI TEKNIK PROJEKTES	Ing. Konstruktor	DENIS PRENCI
	Ing. Hidroteknik	HAJREDIN MURGU
	Ing. Gjeoinformatik	ERBLIN LALA
	Topograf	RAMADAN HYSA

Faza e Projektit: PROJEKT ZBATIMI
Data e Implementimit:
Shkalla e Vizatimit:
Fleta Nr. T-17

Emertimi i Fletes:
 PROFILAT TERTHOR

OBJEKTI: NDËRTIM RRUGËT "Mustafa Kruja + Musa Fratari + Myslim Peza + Mustafa Kaçaçi + Mustafa Ataturku + Mujo Ulqinaku + Rr. pingul me Azem Hajdarin", Babrru Kodër e Kuqe

PROFILI 4

Km.0+125.08 (CS 19)

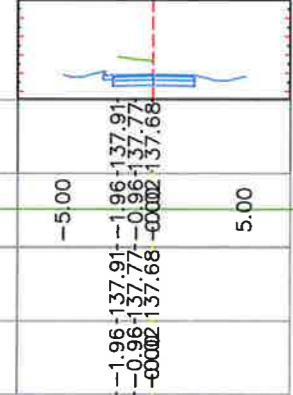

Kuota Terenit	
Dist.Progressive	-5.00 5.00
Kuota Projektit	
Dist.Progressive	

-1.96 -137.91
-0.96 -137.77
-0.00 -137.68

Km.0+103.34 (CS 13)

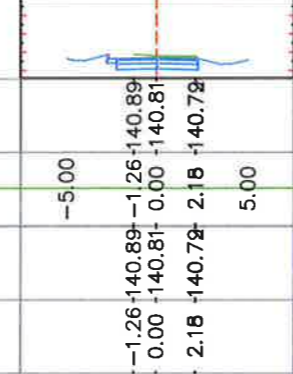

Kuota Terenit	
Dist.Progressive	-5.00 5.00
Kuota Projektit	
Dist.Progressive	

-1.26 -140.89
0.00 -140.81
2.18 -140.72

Km.0+069.69 (CS 7)

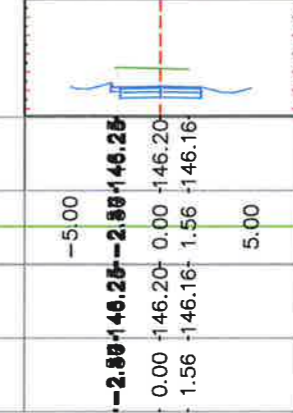

Kuota Terenit	
Dist.Progressive	-5.00 5.00
Kuota Projektit	
Dist.Progressive	

-2.88 -148.25
0.00 -146.20
1.56 -146.16

Kuota Terenit	
Dist.Progressive	
Kuota Projektit	
Dist.Progressive	

Km.0+140.00 (CS 20)

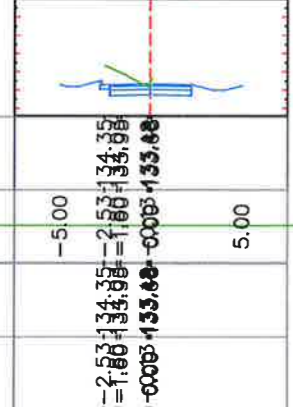

Kuota Terenit	
Dist.Progressive	-5.00 5.00
Kuota Projektit	
Dist.Progressive	

-2.53 -134.35
-1.80 -133.88
-0.00 -133.88

Km.0+112.38 (CS 11)

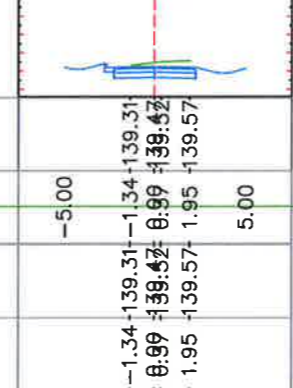

Kuota Terenit	
Dist.Progressive	-5.00 5.00
Kuota Projektit	
Dist.Progressive	

-1.34 -139.31
0.99 -139.52
1.95 -139.57

Km.0+071.14 (CS 8)

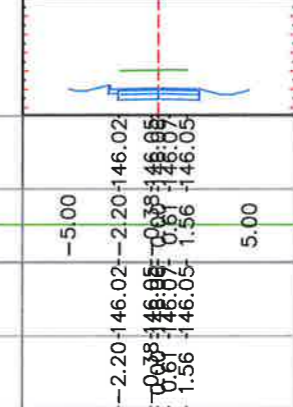

Kuota Terenit	
Dist.Progressive	-5.00 5.00
Kuota Projektit	
Dist.Progressive	

-2.20 -146.02
-0.38 -146.05
1.56 -146.05

Kuota Terenit	
Dist.Progressive	
Kuota Projektit	
Dist.Progressive	

Km.0+142.87 (CS 21)

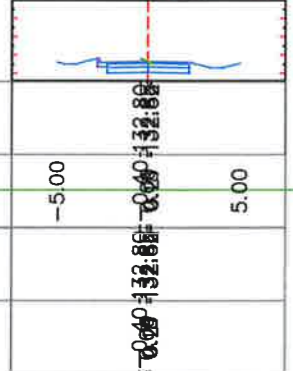

Kuota Terenit	
Dist.Progressive	-5.00 5.00
Kuota Projektit	
Dist.Progressive	

-0.37 -138.43
0.00 -138.45
1.16 -138.48

Km.0+117.92 (CS 15)

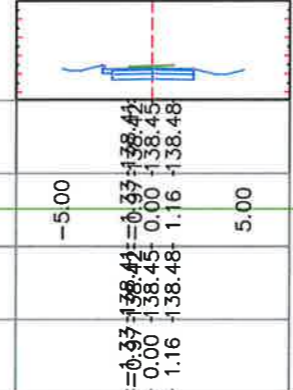

Kuota Terenit	
Dist.Progressive	-5.00 5.00
Kuota Projektit	
Dist.Progressive	

-0.37 -138.43
0.00 -138.45
1.16 -138.48

Km.0+080.00 (CS 9)

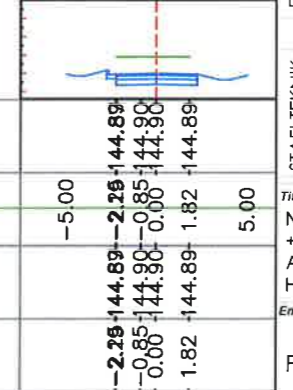

Kuota Terenit	
Dist.Progressive	-5.00 5.00
Kuota Projektit	
Dist.Progressive	

-2.25 -144.89
-0.85 -144.90
1.82 -144.89



BASHKIA KAMEZ
DREJTORIA E SHERBIMEVE PUBLIKE
DREJTORIA E PROJEKTEVE DHE INVESTIMEVE
DEPARTAMENTI I PROJEKTEVE

Dr. e Projekteve e Investimeve **FLORA MUÇA**

STAFI TEKNIK PROJEKTES	Ing. Konstruktor	DENIS PRENCI
	Ing. Hidroteknik	HAJREDIN MURGU
	Ing. Gjeoinformatik	ERBLIN LALA
	Topograf	RAMADAN HYSA

Titulli i Projektit:
NDËRTIM RRUGËT "Mustafa Kruja + Musa Fratari + Myslim Peza + Mustafa Kaçaçi + Mustafa Ataturku + Mujo Ulqinaku + Rr. pingul me Azem Hajdarin", Babrru Kodër e Kuqe

Faza e Projektit:
PROJEKT ZBATIMI

Data e Implementimit:

Shkalla e Vizatimit:

Emertimi i Fletes:

PROFILAT TERTHOR

Fleta Nr. **T-18**

OBJEKTI: NDËRTIM RRUGËT "Mustafa Kruja + Musa Fratari + Myslim Peza + Mustafa Kaçaçi + Mustafa Ataturku + Mujo Ulqinaku + Rr. pingul me Azem Hajdarin", Babrru Kodër e Kuqe

PROFILI 5

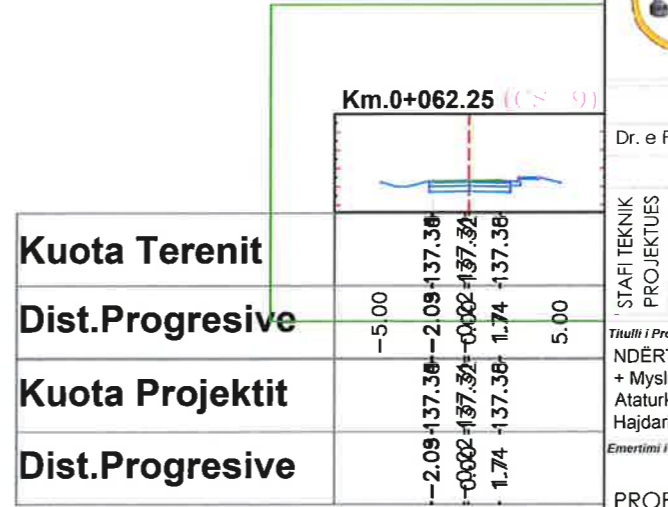
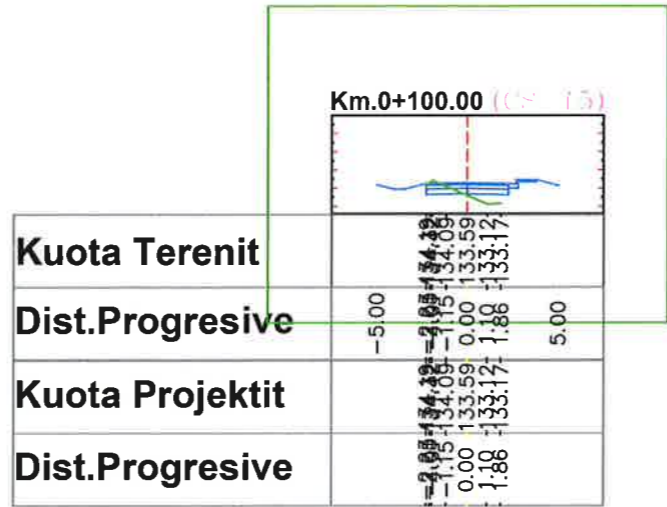
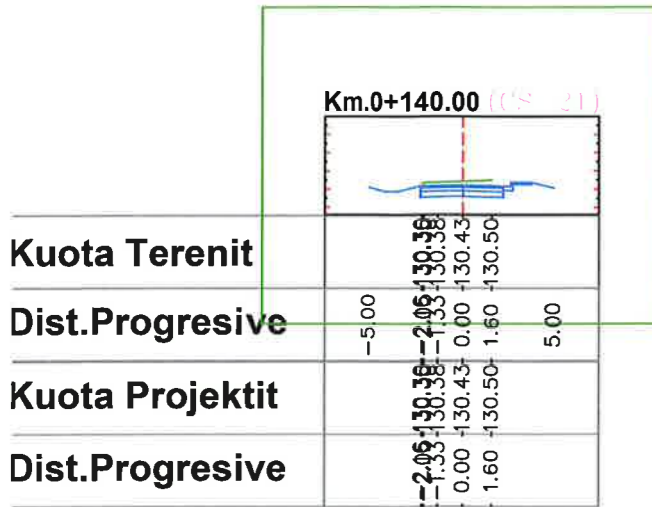
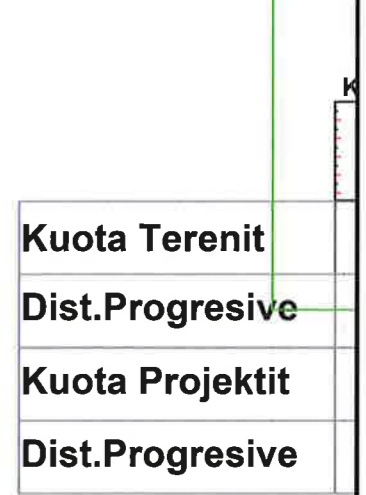
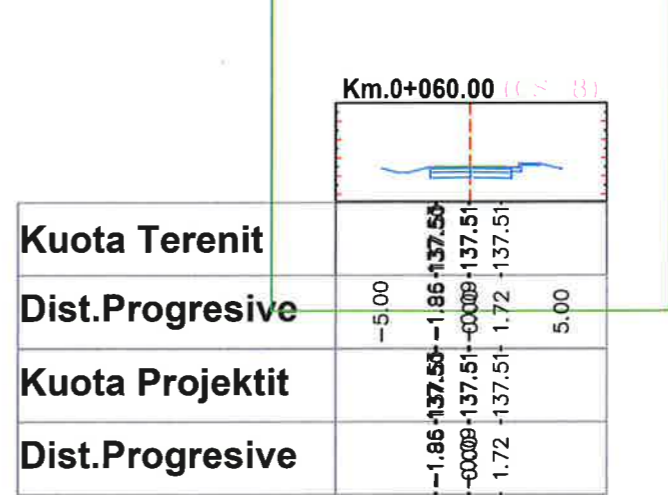
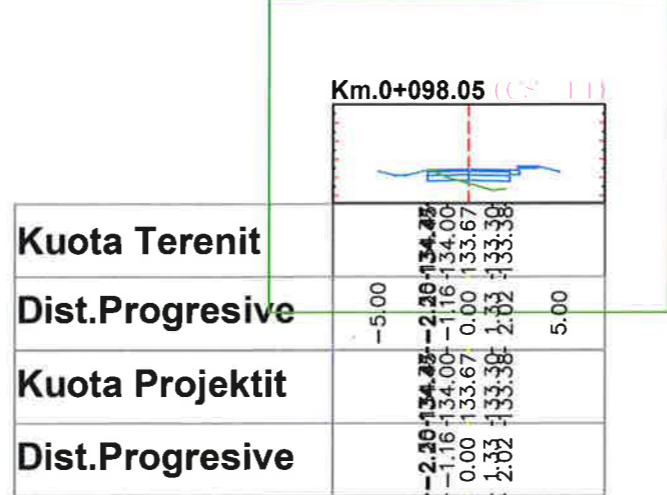
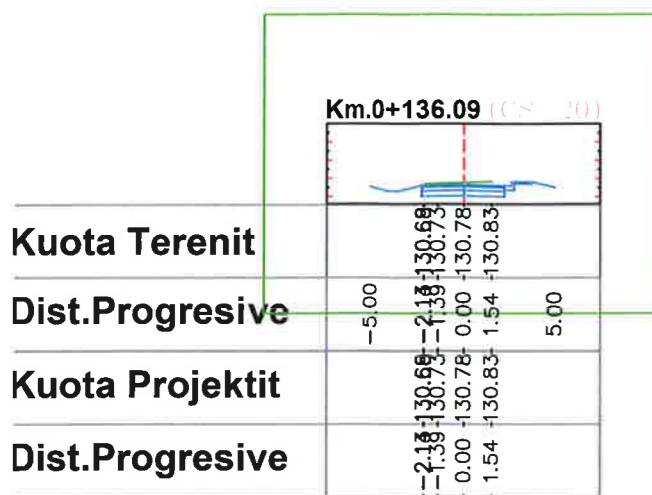
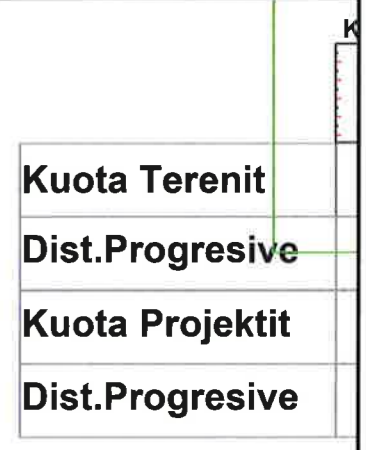
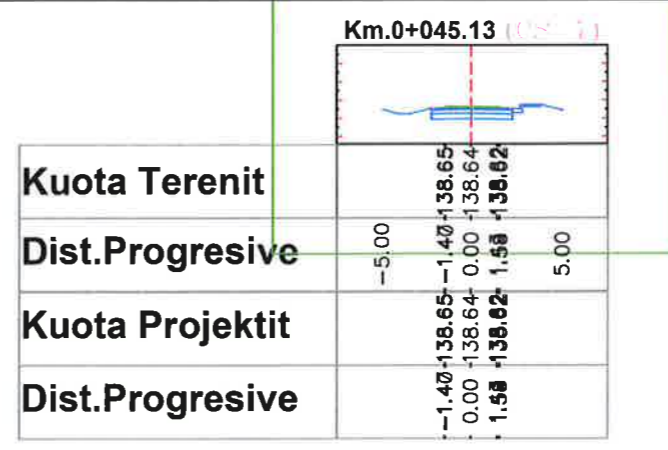
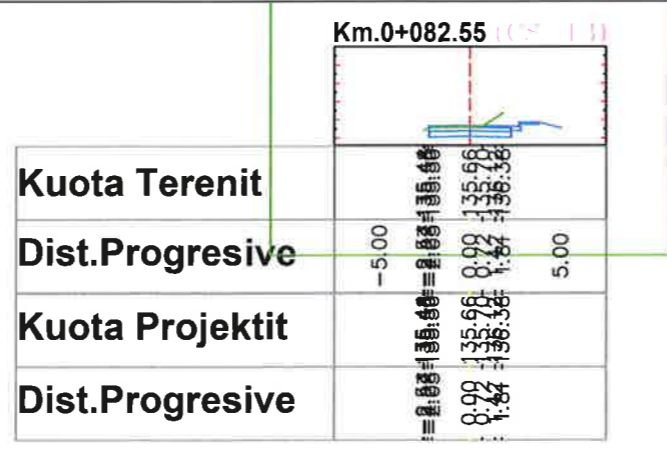
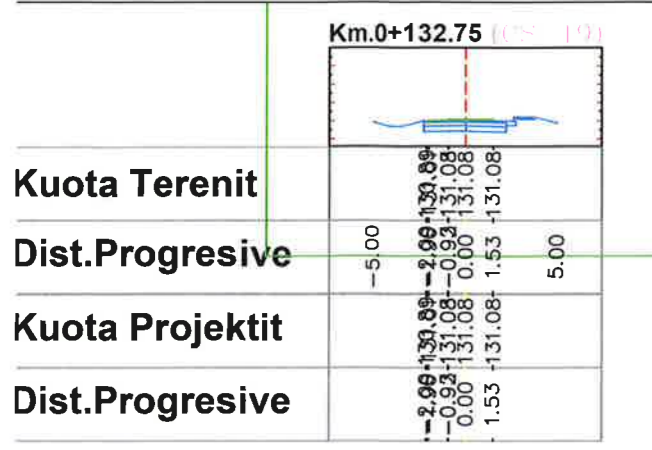



BASHKIA KAMEZ

DREJTORIA E SHERBIMEVE PUBLIKE
DREJTORIA E PROJEKTEVE DHE INVESTIMEVE
DEPARTAMENTI I PROJEKTEVE

Dr. e Projekteve e Investimeve **FLORA MUÇA**

STAFI TEKNIK	Ing. Konstruktor	DENIS PRENCI
PROJEKTES	Ing. Hidroteknik	HAJREDIN MURGU
	Ing. Gjeoinformatik	ERBLIN LALA
	Topograf	RAMADAN HYSA

Titulli i Projektit:
NDËRTIM RRUGËT "Mustafa Kruja + Musa Fratari + Myslim Peza + Mustafa Kaçaçi + Mustafa Ataturku + Mujo Ulqinaku + Rr. pingul me Azem Hajdarin", Babrru Kodër e Kuqe

Faza e Projektit:
PROJEKT ZBATIMI

Data e Implementimit:

Shkalla e Vizatimit:

Emertimi i Fletes:

Fieta Nr.
T-19

PROFILAT TERTHOR

OBJEKTI: NDËRTIM RRUGËT "Mustafa Kruja + Musa Fratari + Myslim Peza + Mustafa Kaçaçi + Mustafa Ataturku + Mujo Ulqinaku + Rr. pingul me Azem Hajdarin", Babrru Kodër e Kuqe

PROFILI 5

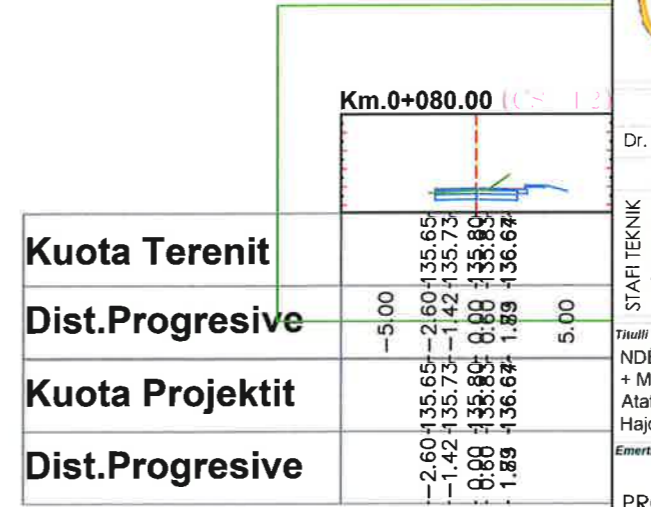
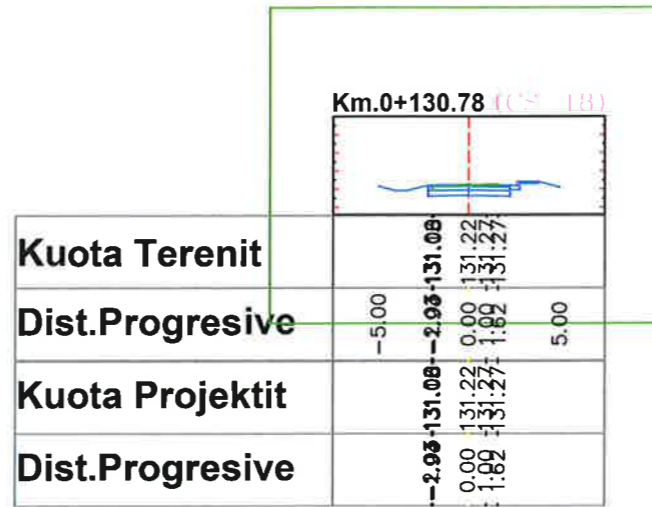
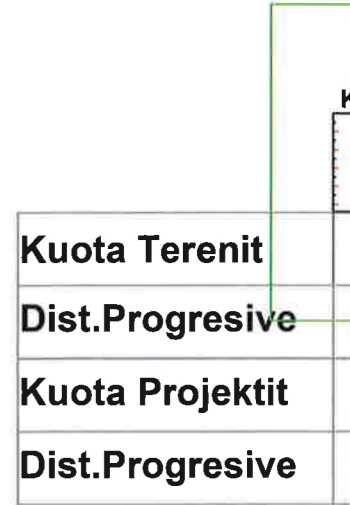
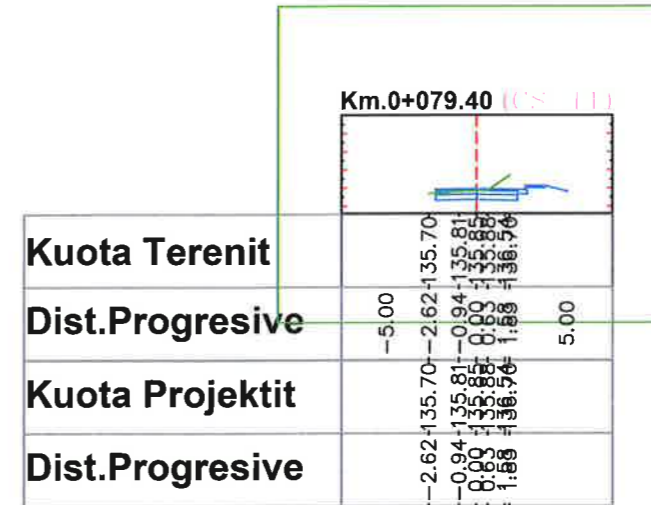
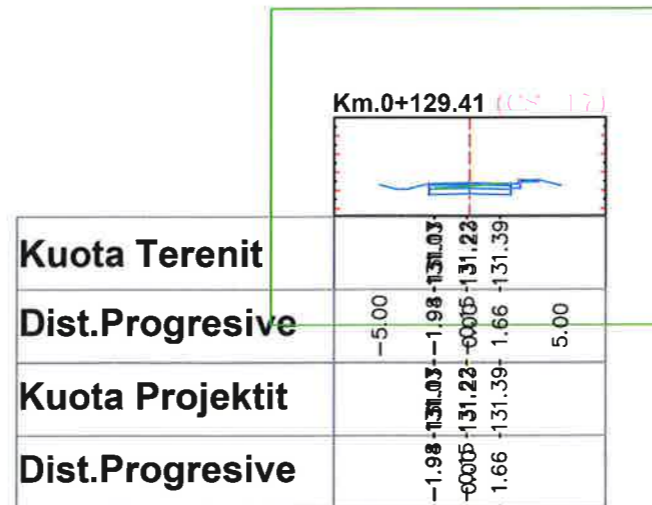
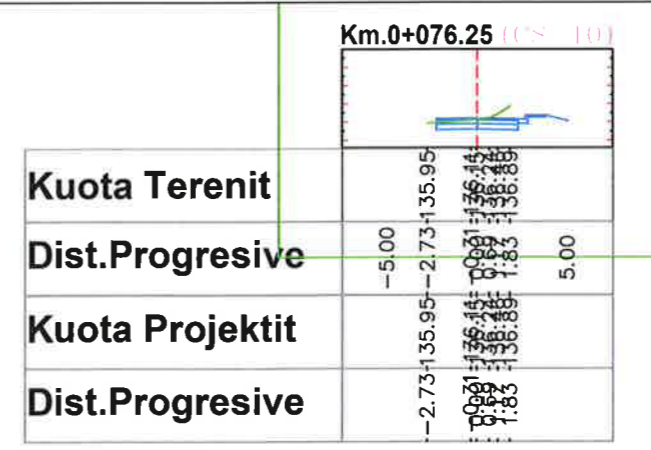
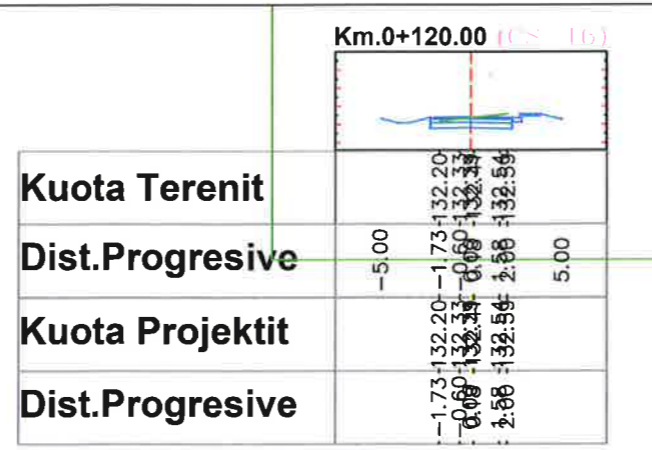
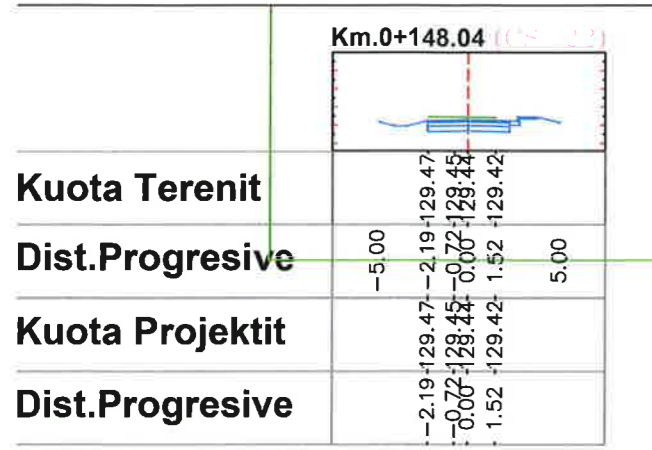

BASHKIA KAMEZ
 DREJTORIA E SHERBIMEVE PUBLIKE
 DREJTORIA E PROJEKTEVE DHE INVESTIMEVE
 DEPARTAMENTI I PROJEKTEVE

Dr. e Projekteve e Investimeve **FLORA MUÇA**

STAFI TEKNIK
 Ing. Konstruktor DENIS PRENCI
 Ing. Hidroteknik HAJREDIN MURGU
 Ing. Gjeoinformatik ERBLIN LALA
 Topograf RAMADAN HYSA

Titulli i Projektit:
 NDËRTIM RRUGËT "Mustafa Kruja + Musa Fratari + Myslim Peza + Mustafa Kaçaçi + Mustafa Ataturku + Mujo Ulqinaku + Rr. pingul me Azem Hajdarin", Babrru Kodër e Kuqe

Faza e Projektit:
 PROJEKT ZBATIMI

Data e Implementimit:

Skalla e Vizatimit:

Emertimi i Fletes:
 PROFILAT TERTHOR

Fieta Nr.:
 T-20

OBJEKTI: NDËRTIM RRUGËT "Mustafa Kruja + Musa Fratari + Myslim Peza + Mustafa Kaçaçi + Mustafa Atatürku + Mujo Ulqinaku + Rr. pingul me Azem Hajdarin", Babrru Kodër e Kuqe

PROFILI 6

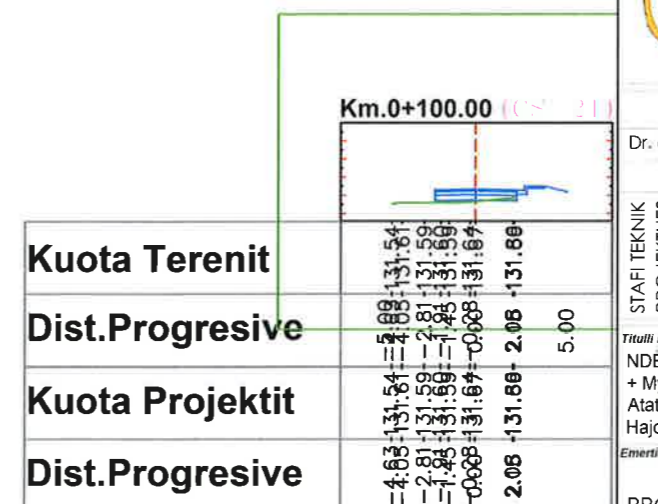
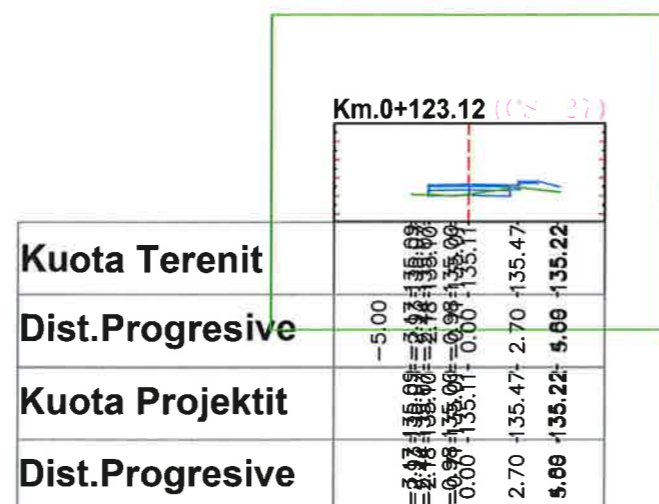
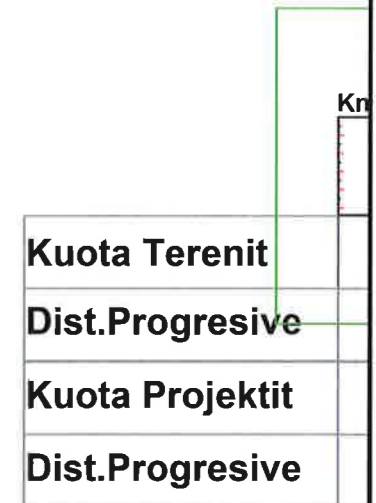
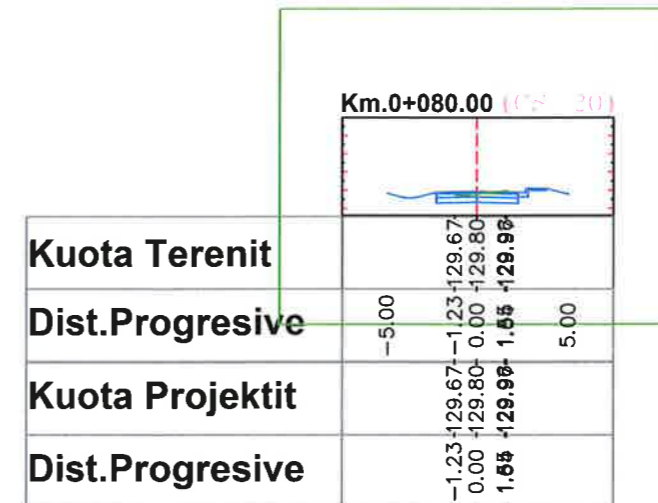
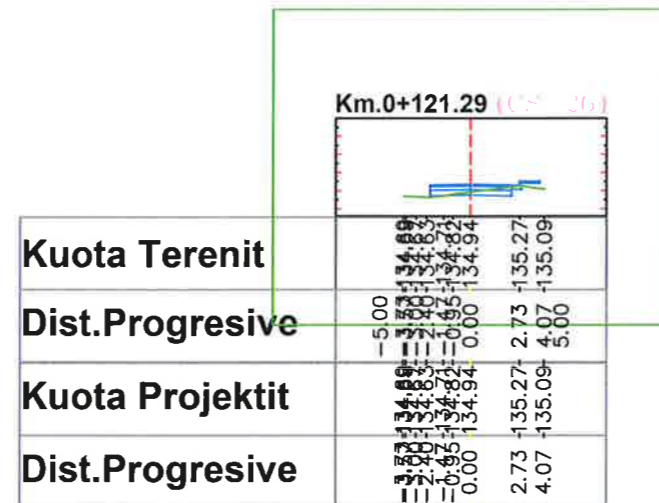
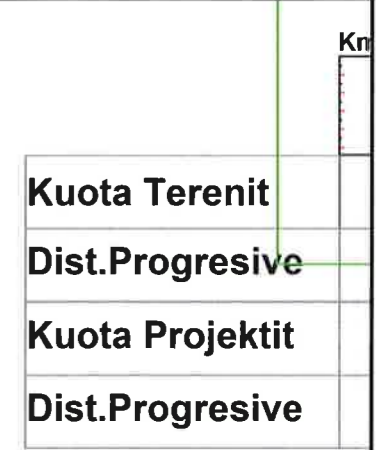
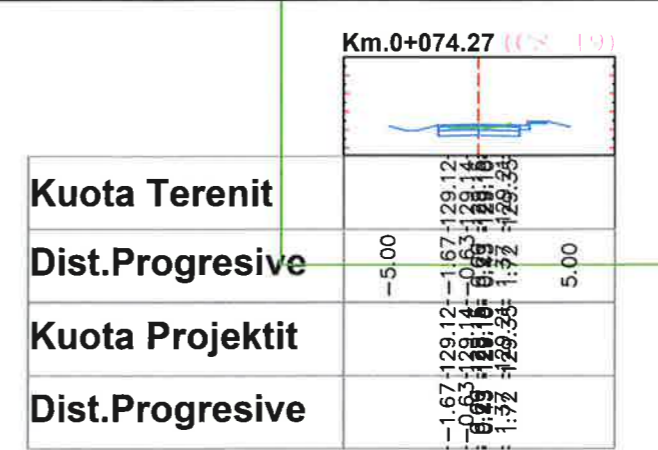
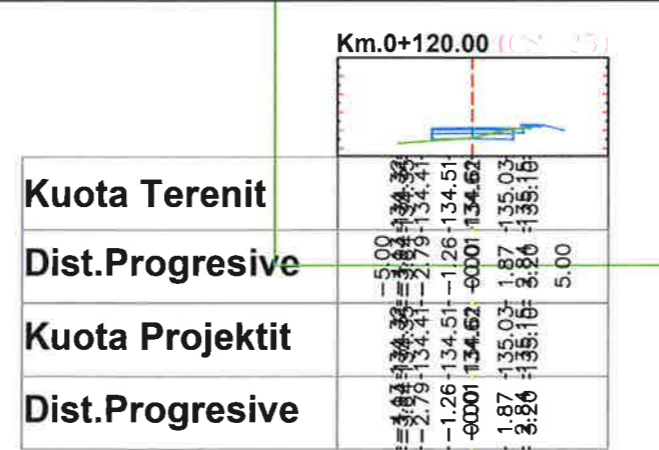
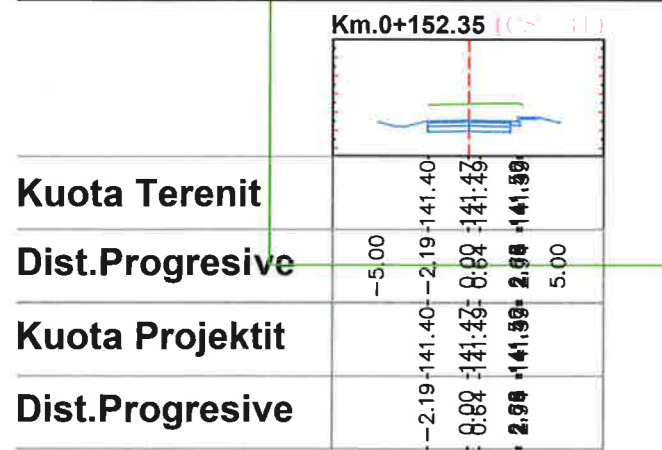



BASHKIA KAMEZ
DREJTORIA E SHERBIMEVE PUBLIKE
DREJTORIA E PROJEKTEVE DHE INVESTIMEVE
DEPARTAMENTI I PROJEKTEVE

Dr. e Projekteve e Investimeve **FLORA MUÇA**

STAFI TEKNIK	Ing. Konstruktor	DENIS PRENCI
PROJEKTES	Ing. Hidroteknik	HAJREDIN MURGU
	Ing. Gjeoinformatik	ERBLIN LALA
	Topograf	RAMADAN HYSA

Faza e Projektit: PROJEKT ZBATIMI
Data e Implementimit:
Shkalla e Vizatimit:
Fleta Nr.: T-21

PROFILAT TERTHOR

OBJEKTI: NDËRTIM RRUGËT "Mustafa Kruja + Musa Fratari + Myslim Peza + Mustafa Kaçaçi + Mustafa Atatunku + Mujo Ulqinaku + Rr. pingul me Azem Hajdarin", Babrru Kodër e Kuqe

PROFILI 6

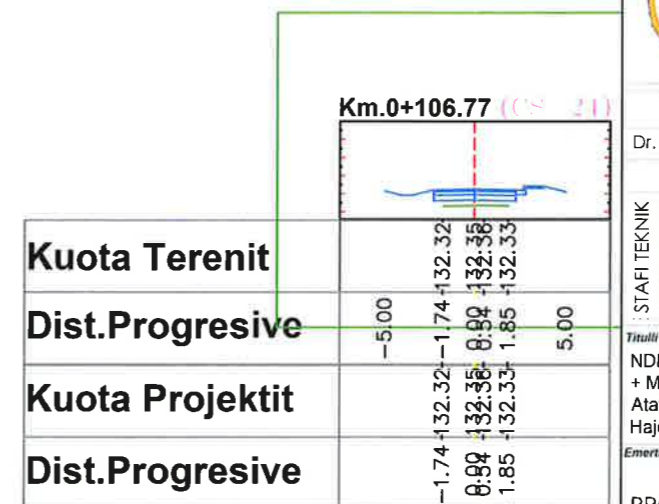
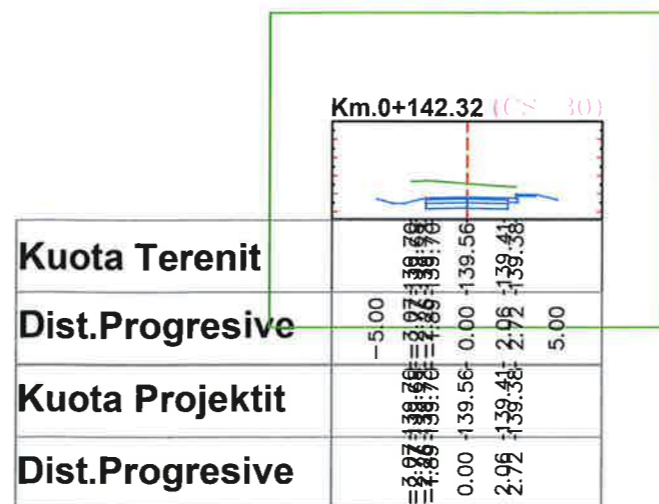
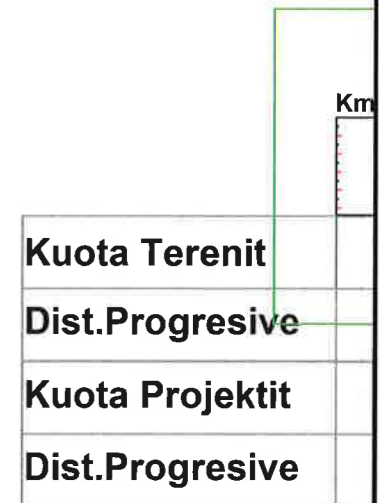
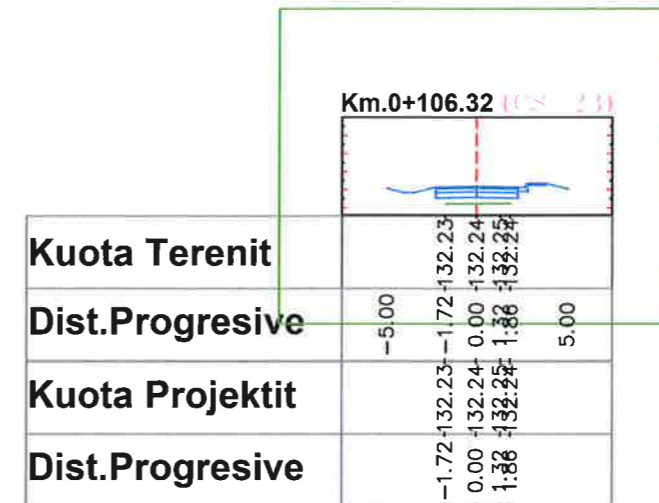
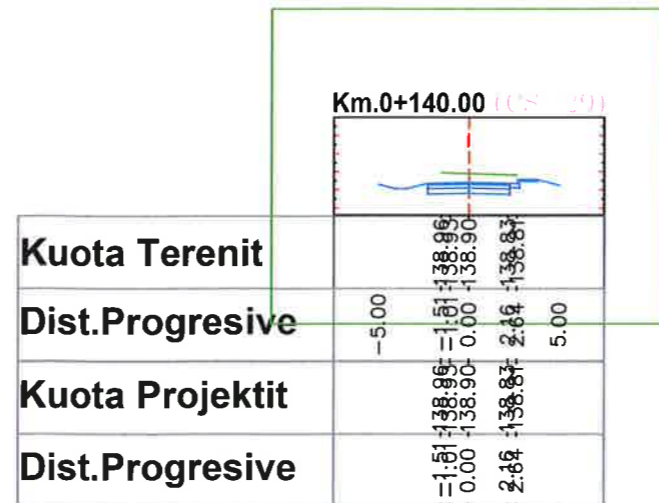
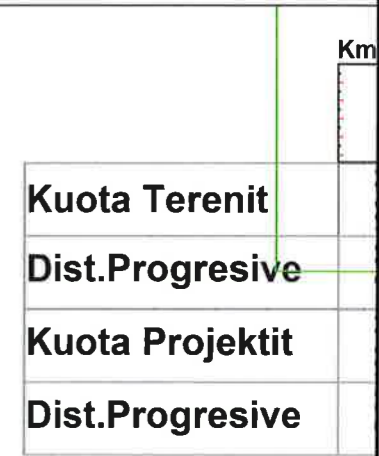
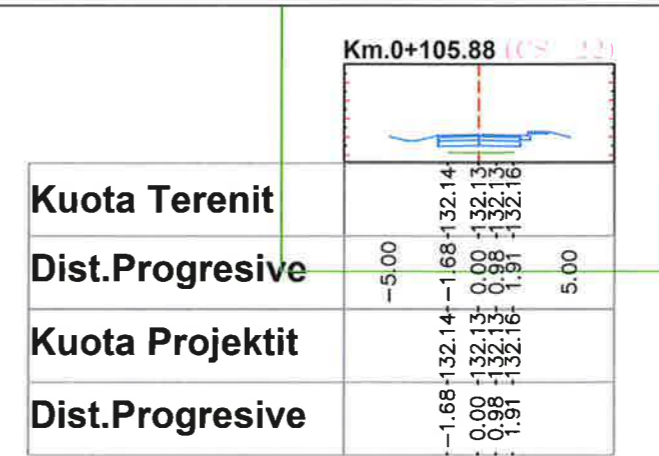
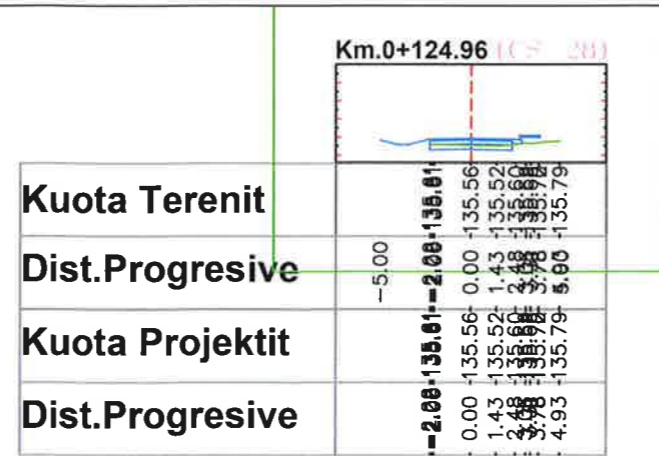
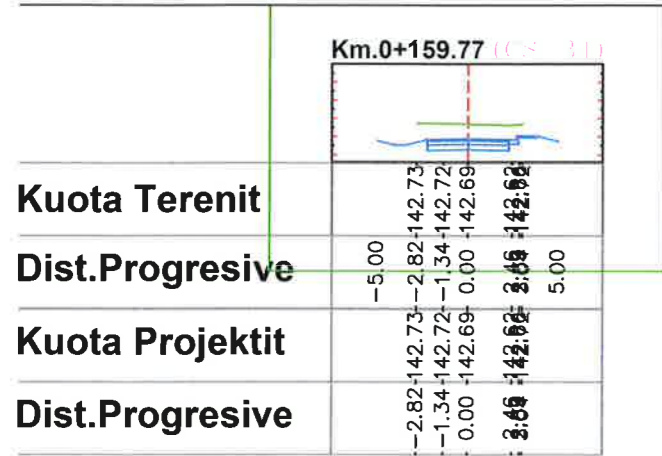



BASHKIA KAMEZ

DREJTORIA E SHERBIMEVE PUBLIKE
DREJTORIA E PROJEKTEVE DHE INVESTIMEVE
DEPARTAMENTI I PROJEKTEVE

Dr. e Projekteve e Investimeve **FLORA MUÇA**

STAFI TEKNIK	Ing. Konstruktor	DENIS PRENCI
PROJEKTUES	Ing. Hidroteknik	HAJREDIN MURGU
	Ing. Gjeoinformatik	ERBLIN LALA
	Topograf	RAMADAN HYSA

Faza e Projektit: PROJEKT ZBATIMI
Data e Implementimit:
Shkalla e Vizatimit:
Emertimi i Flotes:

PROFILAT TERTHOR Fieta Nr. T-22

OBJEKTI: NDËRTIM RRUGËT "Mustafa Kruja + Musa Fratari + Myslim Peza + Mustafa Kaçaçi + Mustafa Atatürku + Mujo Ulqinaku + Rr. pingul me Azem Hajdarin", Babrru Kodër e Kuqe

PROFILI 7

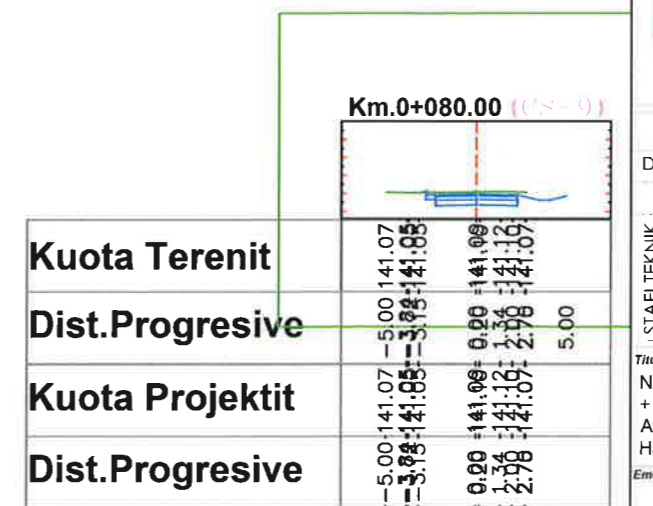
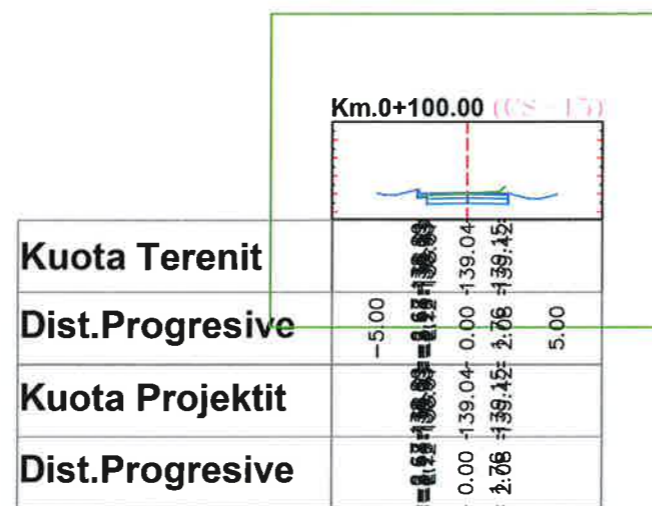
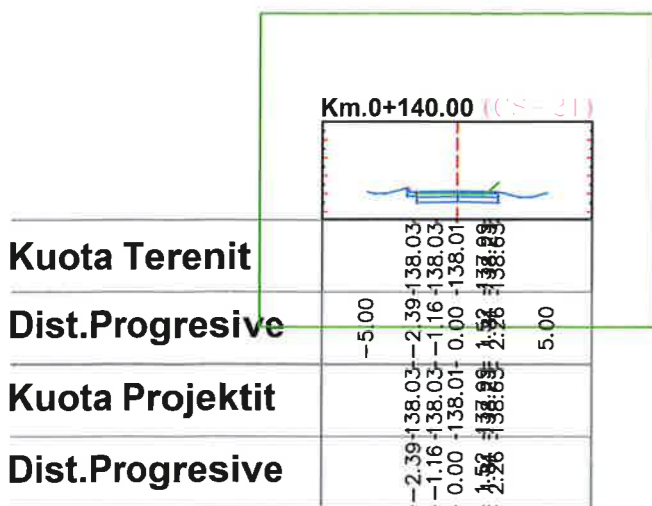
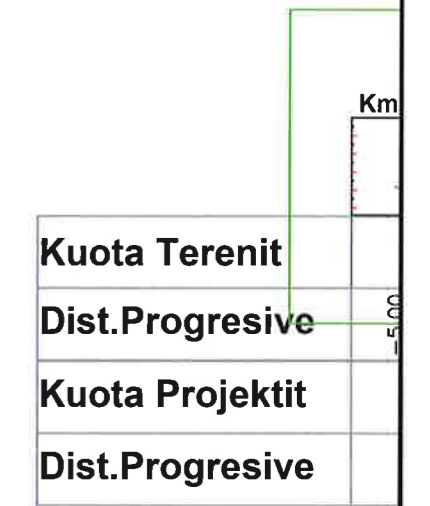
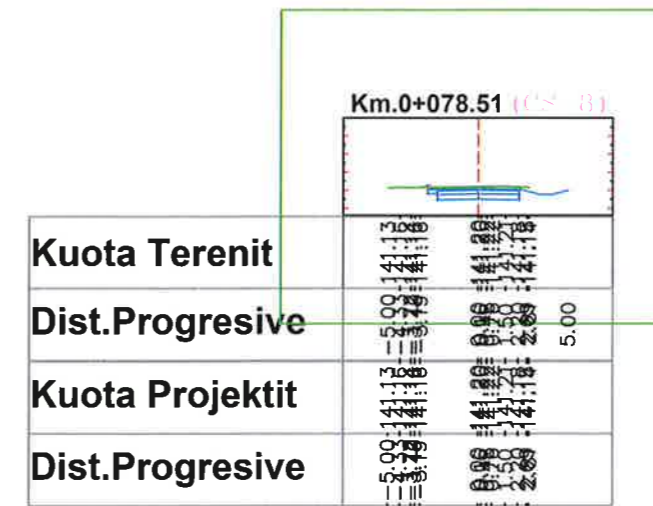
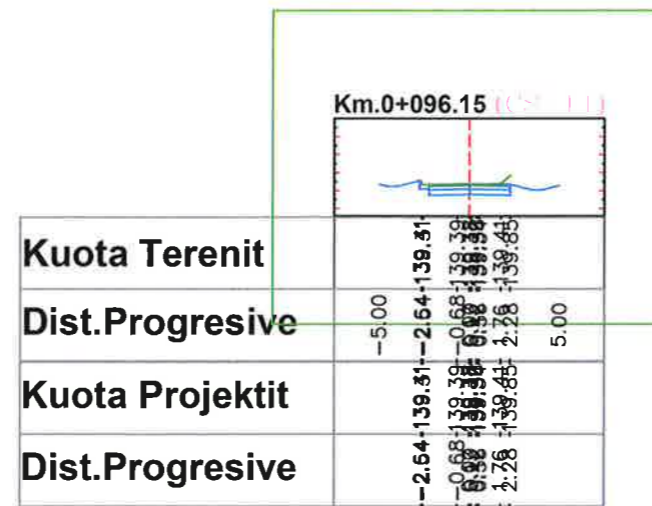
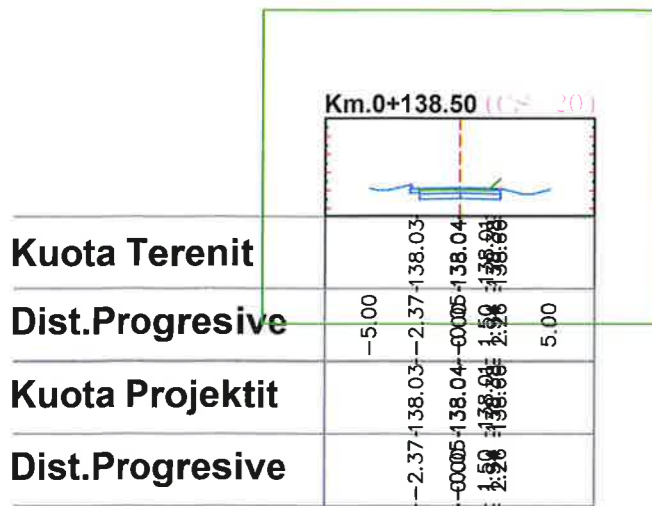
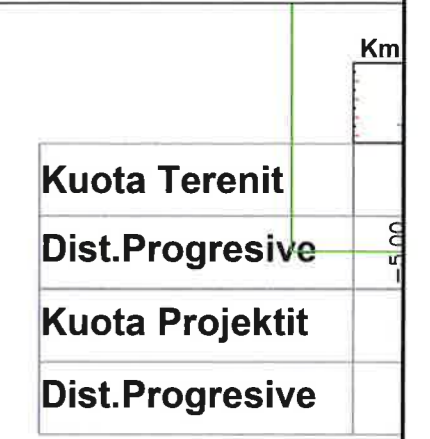
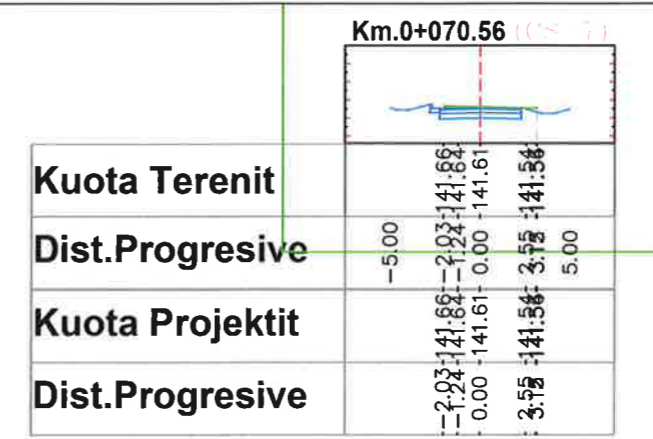
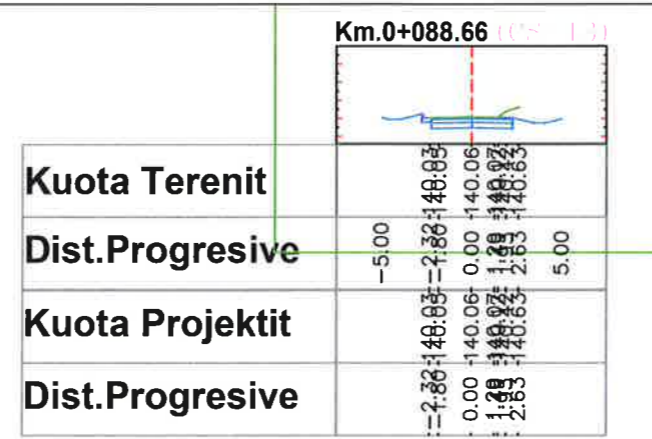
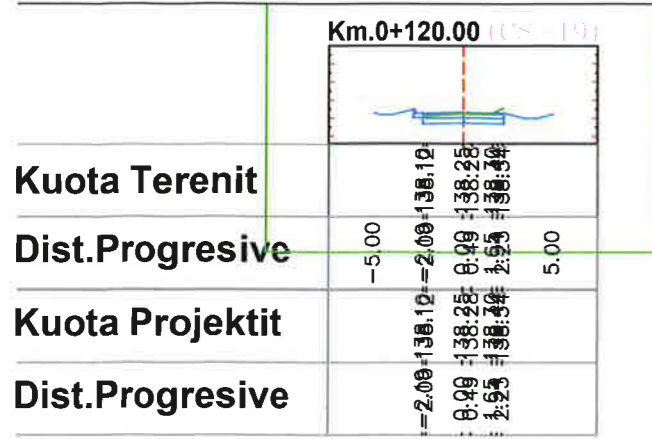



BASHKIA KAMEZ

DREJTORIA E SHERBIMEVE PUBLIKE
DREJTORIA E PROJEKTEVE DHE INVESTIMEVE
DEPARTAMENTI I PROJEKTEVE

Dr. e Projekteve e Investimeve **FLORA MUÇA**

STAFI TEKNIK PROJEKTES	Ing. Konstruktor	DENIS PRENCI
	Ing. Hidroteknik	HAJREDIN MURGU
	Ing. Gjeoinformatik	ERBLIN LALA
	Topograf	RAMADAN HYSA

Faza e Projektit: PROJEKT ZBATIMI
Data e Implementimit:
Shkalla e Vizatimit:
Emertimi i Fletes:

PROFILAT TERTHOR Fleta Nr. **T-23**

OBJEKTI: NDËRTIM RRUGËT "Mustafa Kruja + Musa Fratari + Myslim Peza + Mustafa Kaçaçi + Mustafa Atatunku + Mujo Ulqinaku + Rr. pingul me Azem Hajdarin", Babrru Kodër e Kuqe

PROFILI 7

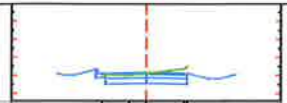

Kuota Terenit	
Dist.Progressive	-5.00
Kuota Projektit	-2.42+138.06 -2.42+138.06 -0.92+138.02 -0.92+138.02 0.00+138.13 0.00+138.13 2.28+138.52 2.28+138.52
Dist.Progressive	5.00

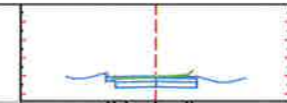

Kuota Terenit	
Dist.Progressive	-5.00
Kuota Projektit	-2.68+138.87 -2.68+138.87 -0.00+138.96 -0.00+138.96 2.70+139.02 2.70+139.02
Dist.Progressive	5.00

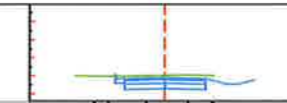

Kuota Terenit	
Dist.Progressive	-5.00
Kuota Projektit	-5.00+141.01 -5.00+141.01 -3.93+140.98 -3.93+140.98 -1.01+141.01 -1.01+141.01 0.00+141.03 0.00+141.03 -1.29+141.06 -1.29+141.06 2.70+141.02 2.70+141.02
Dist.Progressive	5.00

Kuota Terenit	
Dist.Progressive	-5.00
Kuota Projektit	
Dist.Progressive	

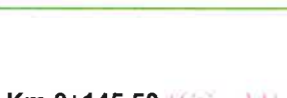

Kuota Terenit	
Dist.Progressive	-5.00
Kuota Projektit	-2.43+138.06 -2.43+138.06 -1.21+138.03 -1.21+138.03 0.00+138.18 0.00+138.18 2.28+138.52 2.28+138.52
Dist.Progressive	5.00



Kuota Terenit	
Dist.Progressive	-5.00
Kuota Projektit	-2.37+138.55 -2.37+138.55 0.00+138.66 0.00+138.66 1.68+138.72 1.68+138.72
Dist.Progressive	5.00



Kuota Terenit	
Dist.Progressive	-5.00
Kuota Projektit	-2.88+140.75 -2.88+140.75 -1.48+140.77 -1.48+140.77 0.00+140.79 0.00+140.79 1.24+140.84 1.24+140.84 2.68+140.90 2.68+140.90
Dist.Progressive	5.00

Kuota Terenit	
Dist.Progressive	-5.00
Kuota Projektit	
Dist.Progressive	



Kuota Terenit	
Dist.Progressive	-5.00
Kuota Projektit	-2.44+138.10 -2.44+138.10 0.00+138.10 0.00+138.10 1.33+138.19 1.33+138.19 2.28+138.71 2.28+138.71
Dist.Progressive	5.00



Kuota Terenit	
Dist.Progressive	-5.00
Kuota Projektit	-2.34+138.47 -2.34+138.47 0.00+138.58 0.00+138.58 1.77+138.59 1.77+138.59
Dist.Progressive	5.00



Kuota Terenit	
Dist.Progressive	-5.00
Kuota Projektit	-2.88+140.75 -2.88+140.75 -1.48+140.77 -1.48+140.77 0.00+140.79 0.00+140.79 1.24+140.84 1.24+140.84 2.68+140.90 2.68+140.90
Dist.Progressive	5.00



BASHKIA KAMEZ
DREJTORIA E SHERBIMEVE PUBLIKE
DREJTORIA E PROJEKTEVE DHE INVESTIMEVE
DEPARTAMENTI I PROJEKTEVE

Dr. e Projekteve e Investimeve **FLORA MUÇA**

STAFI TEKNIK	Ing. Konstruktor	DENIS PRENCI
PROJEKTUES	Ing. Hidroteknik	HAJREDIN MURGU
	Ing. Gjeoinformatik	ERBLIN LALA
	Topograf	RAMADAN HYSA

Tiulli i Projektit:
NDERTIM RRUGËT "Mustafa Kruja + Musa Fratari + Myslim Peza + Mustafa Kaçaçi + Mustafa Atatunku + Mujo Ulqinaku + Rr. pingul me Azem Hajdarin", Babrru Kodër e Kuqe

Faza e Projektit:
PROJEKT ZBATIMI

Data e Implementimit:

Shkalla e Vizimit:

Emertimi i Fletes:

Profilat TERTHOR

Fleta Nr.
T-24