

REPUBLIKA E SHQIPËRISË
BASHKIA HIMARË
DREKTORIA E PLANIFIKIMIT DHE ZHVILLIMIT TË TERRITORIT

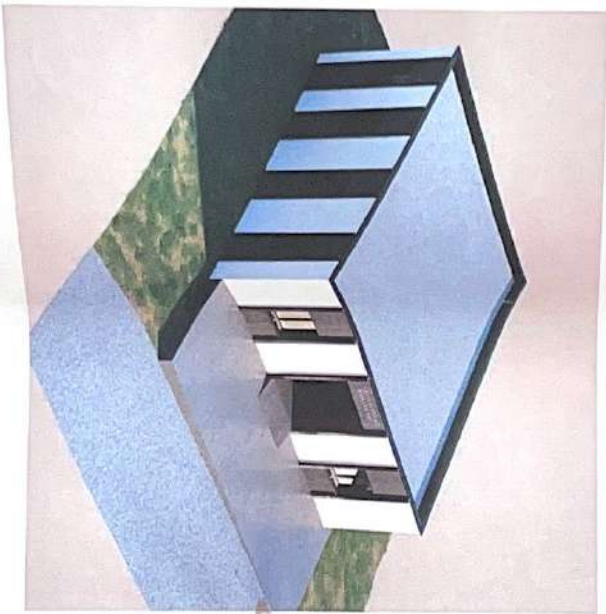



Emertimi Projektit :

"Projekt Zbatimi i Rikonstruksionit të Njësisë Bashkiake
Horë-Vranisht"



Grupi i PROJEKTIMIT :

ark. rest. Genian Stranobërda
ing. Artistik Gori

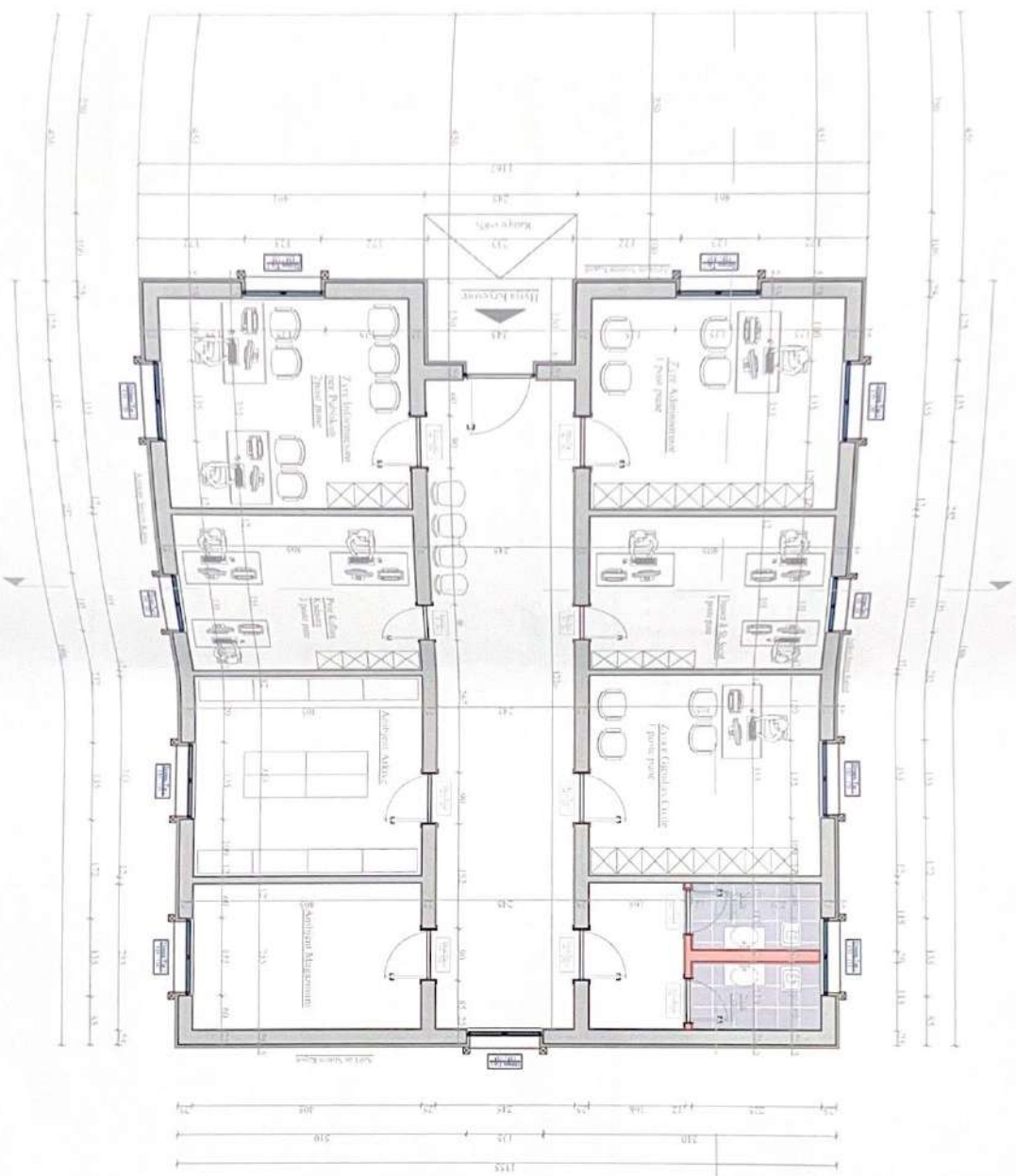

Nama Proyek : "Pondok Prasasti" di Kawasan Industri
 Kawasan Industri dan Kawasan Industri
PT. BUKITIAH KAWAN INDUSTRI
 Kawasan Industri dan Kawasan Industri
 Kawasan Industri dan Kawasan Industri

Nama Perancang :
 Nama Perancang :
 Nama Perancang :

No. / Volume :
 No. / Volume :
 No. / Volume :

Tanggal :
 Tanggal :
 Tanggal :

Lokasi :
 Lokasi :
 Lokasi :

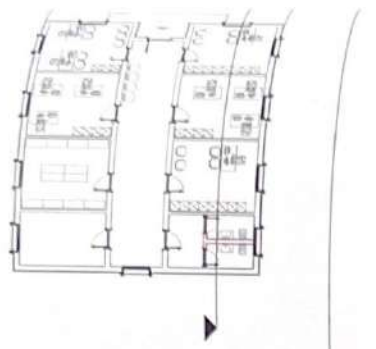

Institut "Petrovi" - Tipovi Dizajni i Kalkulacioni iz Strukturalne i Inzenjerske Struke	
REPUBLIKA E SHQIPRISE RREZIMI I INZHINIERI Organizim i Punetimit dhe Zgjedhja e Titullit	
Sigel e Inzenjerkut Akti i Titullit dhe Punetimit dhe Akti i Titullit dhe Punetimit	
[Signature]	
Data e Aktit: 2022	Nr. i Titullit: 2/22
Nr. i Aktit: 2022	[Stamp]
Shprehja e përgjigjeve të autoriteteve të kompetencave të përcaktuara në ligj.	

Planimetria e Terraces - Plani i Kullimit Sh 1:75

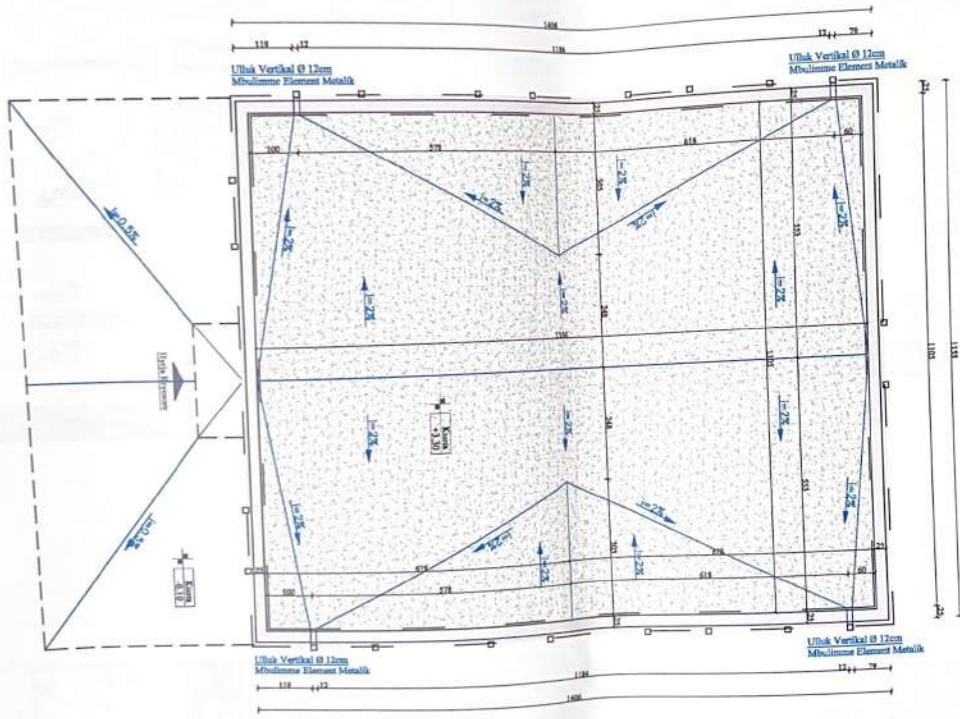

Emri i Projektit: "Projekti Zhvritje e Shpërndarësitë të Nivellit të 1-të të Kullimit"
 REPUBLIKA E SHQIPËRIE
 BASHKËA KOMARE
 Durrës e Përfundim dhe Zhvritje të Terracës
 Dregatë e Përfundimit
 Inzh. Ardit Hysi
 Dregatë e Përfundimit
 No. 1/2024 A. 01
 Dregatë e Përfundimit
 No. 1/2024 A. 01
 Dregatë e Përfundimit
 No. 1/2024 A. 01
 Dregatë e Përfundimit
 No. 1/2024 A. 01

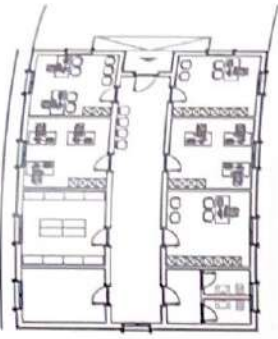
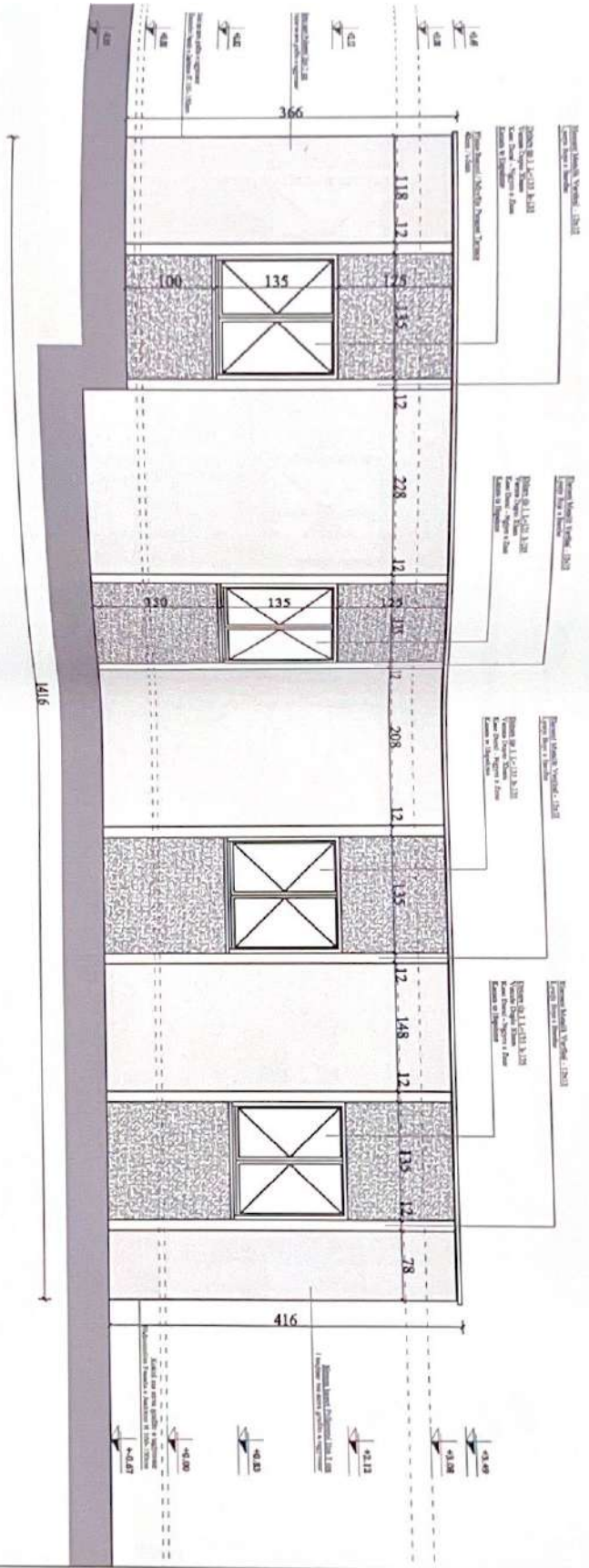

<p>Imenik projekta: "Projekt Zgradbe I. Znamenskih in Spinalnih inštitucij 'Ivan Vojkovič'"</p>	
<p>AVTORI PROJEKTA: ARHITEKTURA INŠTITUT ZA ARHITEKTURNO INŽENIRING INŠTITUT ZA INŽENIRING INŠTITUT ZA INŽENIRING INŠTITUT ZA</p>	
<p>IZOŠTETKI: [Signature]</p>	
<p>ŠT. PROJEKTA: 100</p>	<p>ŠT. LISTA: 1/1</p>
<p>ŠT. LISTA: 1/1</p>	<p>ŠT. LISTA: 1/1</p>
<p>ŠT. LISTA: 1/1</p>	

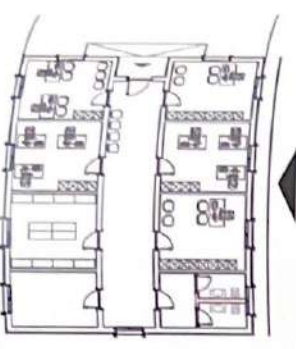
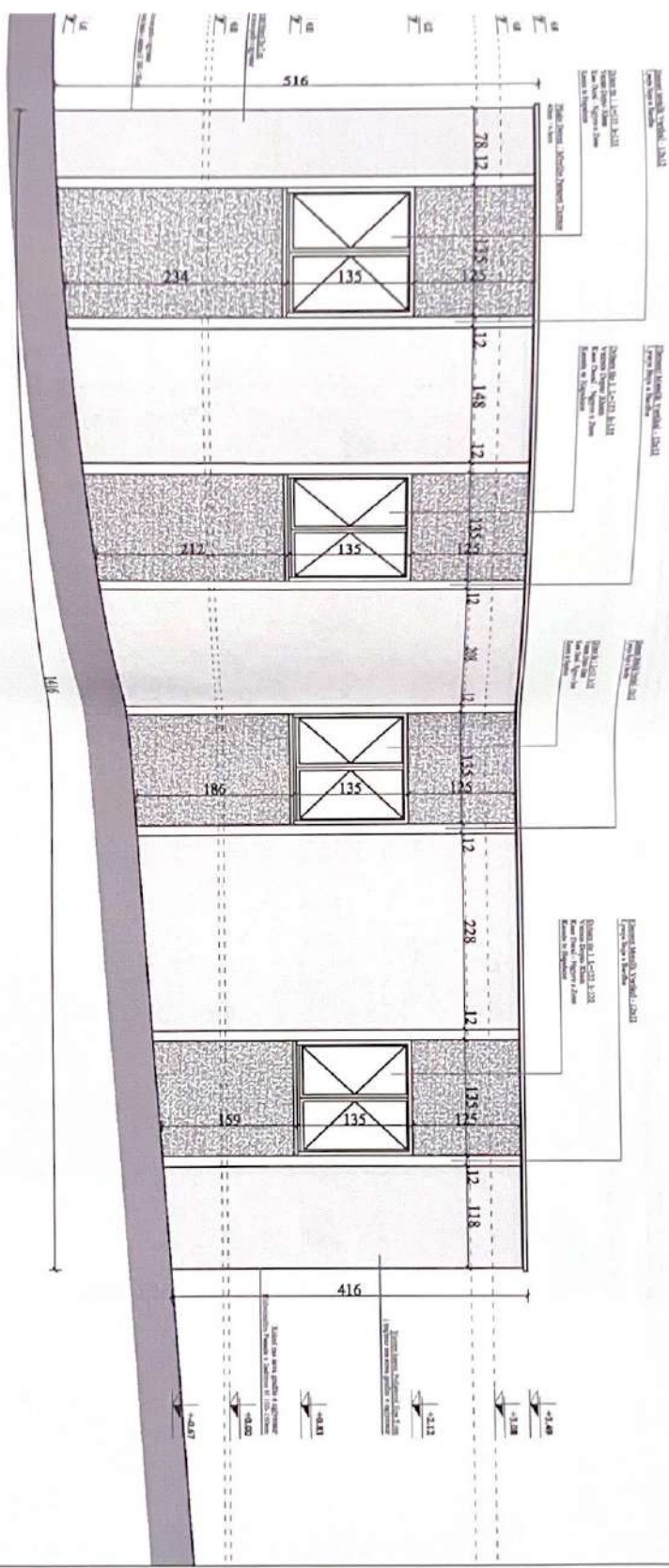

Nomor Proyek: "Tingkat Desain I" (Konsultasikan ke Timbuli KAWAN 11047 11047)	
KERTURUKA & SOROPETUS SASRUKA RUMAH Desain & Perencanaan dan Konstruksi di Terbang	
Sifat / Inspeksi:	
dan akan. Gambar Konstruksi dan Asas dan (Signature)	
Tanggal:	No. 11047
No. 11047	A.11
Dibuat oleh:	
No. 11047	
No. 11047	
No. 11047	

Planina Nizozna 1:1000
 Projekt: 1000/1000/1000
 Datum: 10.10.2010
 Projektant: 1000/1000/1000
 Izvod: 1000/1000/1000

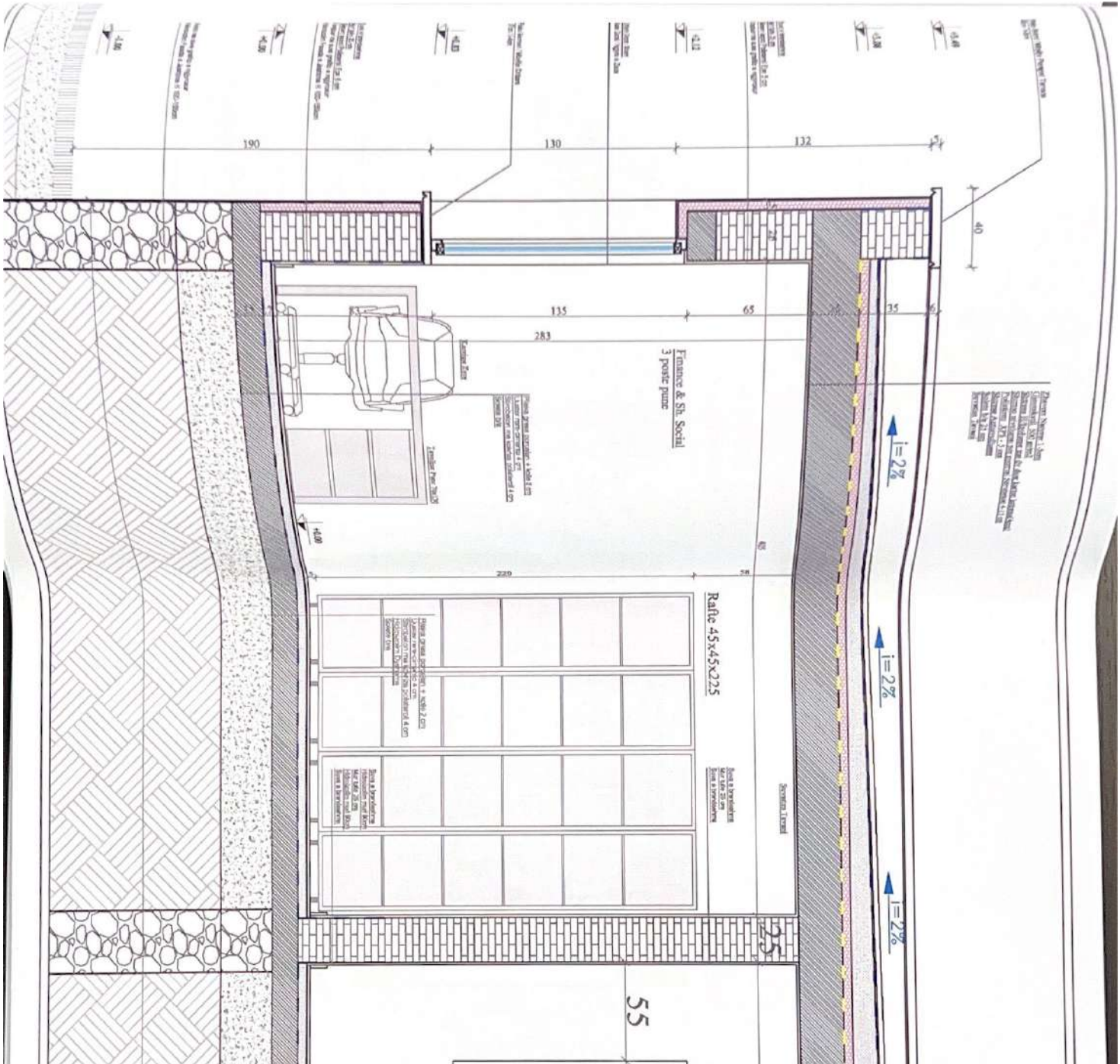

Broj: 1000/1000/1000
 Datum: 10.10.2010
 Projektant: 1000/1000/1000
 Izvod: 1000/1000/1000

Republika i Srpska
 Ministarstvo Građevinarstva i Prostorne
 Planiranja i Infrastrukture
 Republike Srpske

Projekat: 1000/1000/1000
 Datum: 10.10.2010
 Projektant: 1000/1000/1000
 Izvod: 1000/1000/1000

Broj: 1000/1000/1000
 Datum: 10.10.2010
 Projektant: 1000/1000/1000
 Izvod: 1000/1000/1000

Plan Tip 1	Totall : Cope 10
1415 b-135	
Van Dapio Xham	
Ynre e Zeze	
Las Dural - Ngjyre e Zeze	
Las e Hapshime	

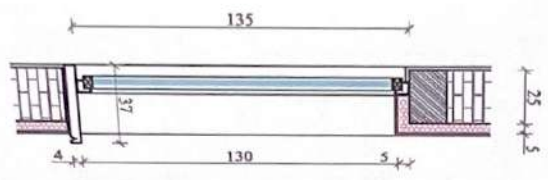
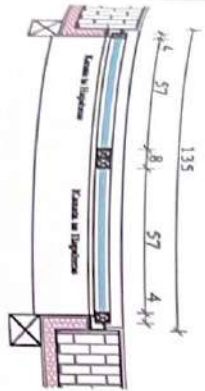
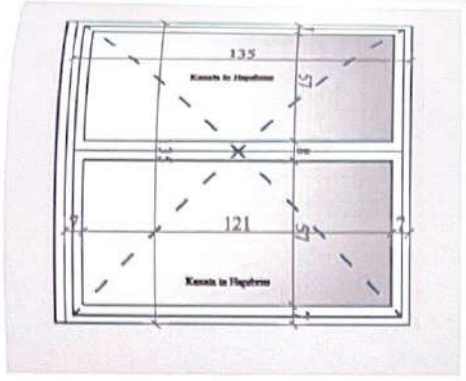

Plan Tip 2	Totall : Cope 1
1415 b-135	
Van Dapio Xham	
Ynre e Zeze	
Las Dural - Ngjyre e Zeze	
Kamsh e Hapshime	

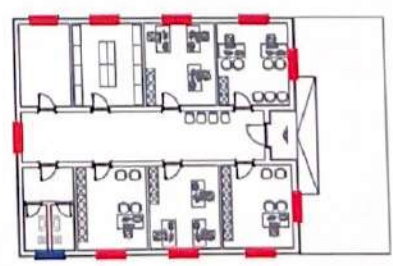
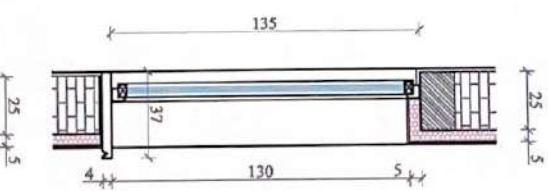
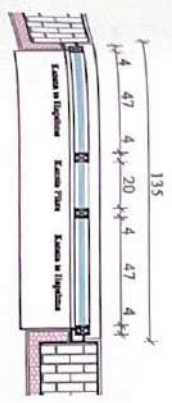
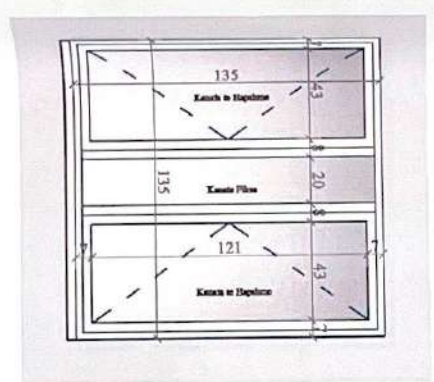

— Dheran Tip 1
— Dheran Tip 2

Numeri Projekt : "Projekt Dural" | Shumari-konkret i
 Niveli : Dural | "Projekt"

REPERENCIA E SIKURITETE
 DOKUMENTACIONE
 Dispozita e Projektit dhe Zonave te Torentit

DURAL (PROJEKTORE)
 Agjencia e Inzhinerise
 dhe Arkitekture

No. i Niveli : A.10
 No. i Projektit : 100
 No. i Dokumentit : 100

"Projektimi me qellim per shprehjen e projektimit" para se te aplikohet.
 Shprehja

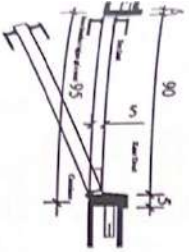
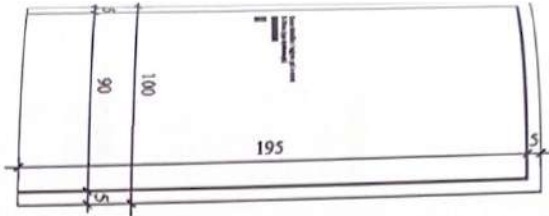

Dere tip 1	totali : cope 8
L=90 b=200	
me harti cillesi e perze	
Dere Gri e Hapur RAL 7047	
Doreze metalike ngjyre gri e hapur	

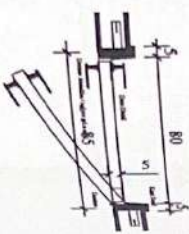
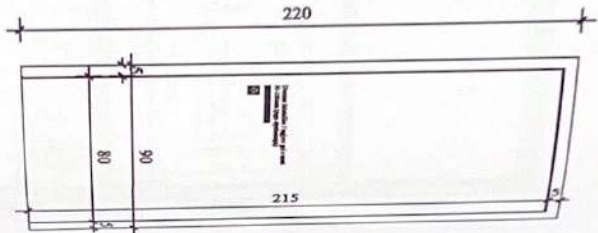

Dere tip 2	totali : cope 2
L=80 b=220	
Dere dural	
Ngjyre Gri e Hapur RAL 7047	
Doreze metalike ngjyre gri e hapur	

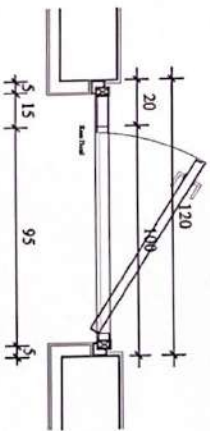
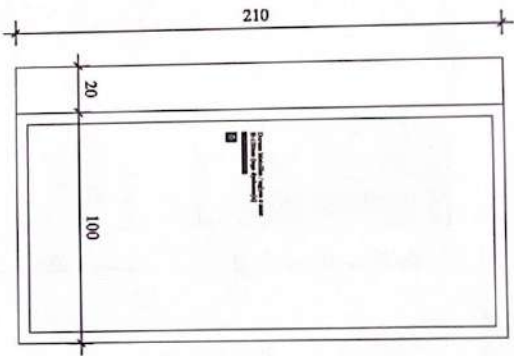

Dere tip 3	totali : cope 1
L=120 b=210	
Dere e Jashme e Blinduar Metalike	
Ngjyre e Zeze	
Doreze metalike ngjyre e zeze	

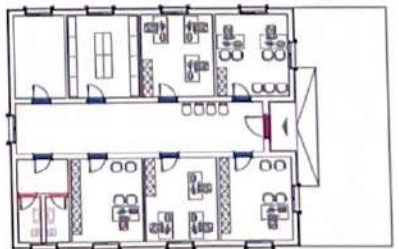

- Dere Tip 1
- Dere Tip 2
- Dere Tip 3

Shënim: Projekti "Projekt Zonësi i Shkollësimit III
Njësitë Shkollore Të Reja Vushtrri"

REPUBLIKA E SHQIPËSË
AKADHIA SHQIPËSE E INZHINIERISË
Drejtoria e Përgjithshme e Drejtimit të Turmave

Drejtues i Turmave:
Inzh. Enxhet Haxhiu
Inzh. Shkëlqim Haxhiu

Shënim: Projekti i përgatitur në bashkëpunim me projektuesin dhe projektuesin e shprehur.

Numri i Turmave: A.T.1

Titulli i Turmave: DORREZAZONET

Skema e Turmave: A.T.1

Skema e Turmave: A.T.1

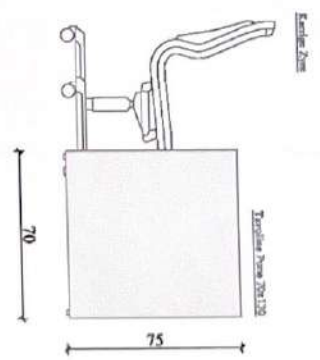
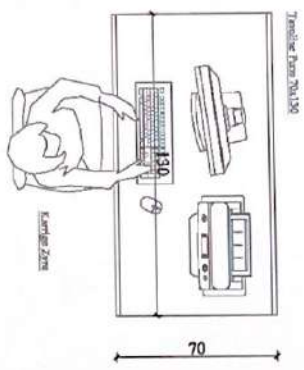
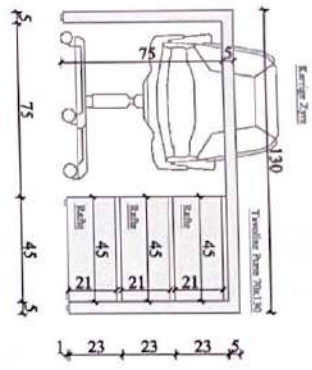
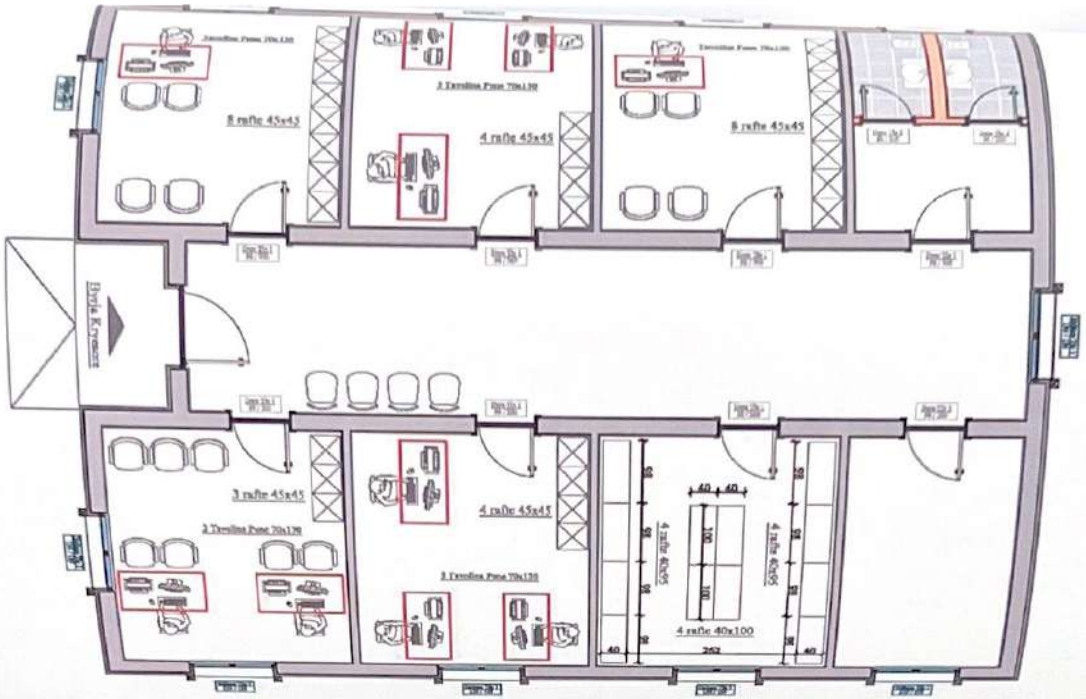

Tavoline Pune	
130 x 70 x 75	
Material Druri	
Ngjyre Gri e Hapur RAL 7047	
Doreze metalike ngjyre gri e hapur	



Shënimet e Pajës: "Projekt Zmadhoi" i Komunikimit të Niveliut "Shkollor" të "Vendës"

KAPITULLI 3: SHËNIMET
BAJRIKUA EDUKIMI
 Pajësia e Pajësimit dhe Dështimi të Tërhequr

DREJTITRUESORIT:
 Më 02.04.2024
 Më 02.04.2024
 Më 02.04.2024

Numri i Dokumentit: 10/2024
Data e Emisionit: 02.04.2024
Numri i Dokumentit të Tërhequr: 10/2024

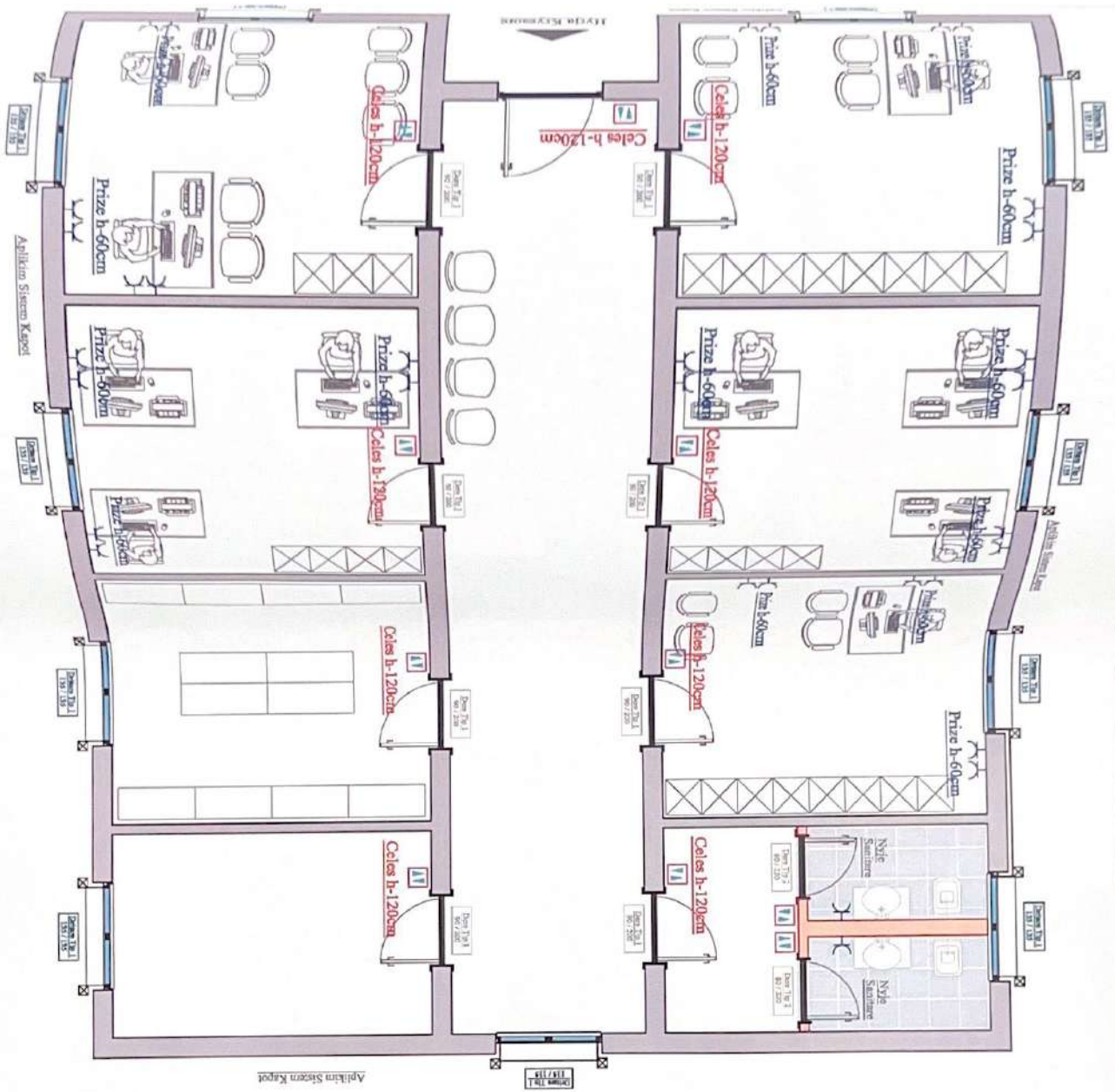

Apilkan Sistem Kageol

Nama Projek: "Tingkat Kedua" / Dokumentasi di
 bidang: Struktur / Tipe: Rumah
 KATEGORI: RUMAH SINGGAH
 MANJILAH: MANJILAH
 Disusun & Perancang oleh: Zhevilina & Theresia

DATA PENSIKAPAN:
 no. 1. 2022
 no. 2. 2022
 no. 3. 2022
 no. 4. 2022
 no. 5. 2022

Zhevilina & Theresia
 No. 1. 2022
 No. 2. 2022
 No. 3. 2022
 No. 4. 2022
 No. 5. 2022

Disusun & Perancang oleh: Zhevilina & Theresia

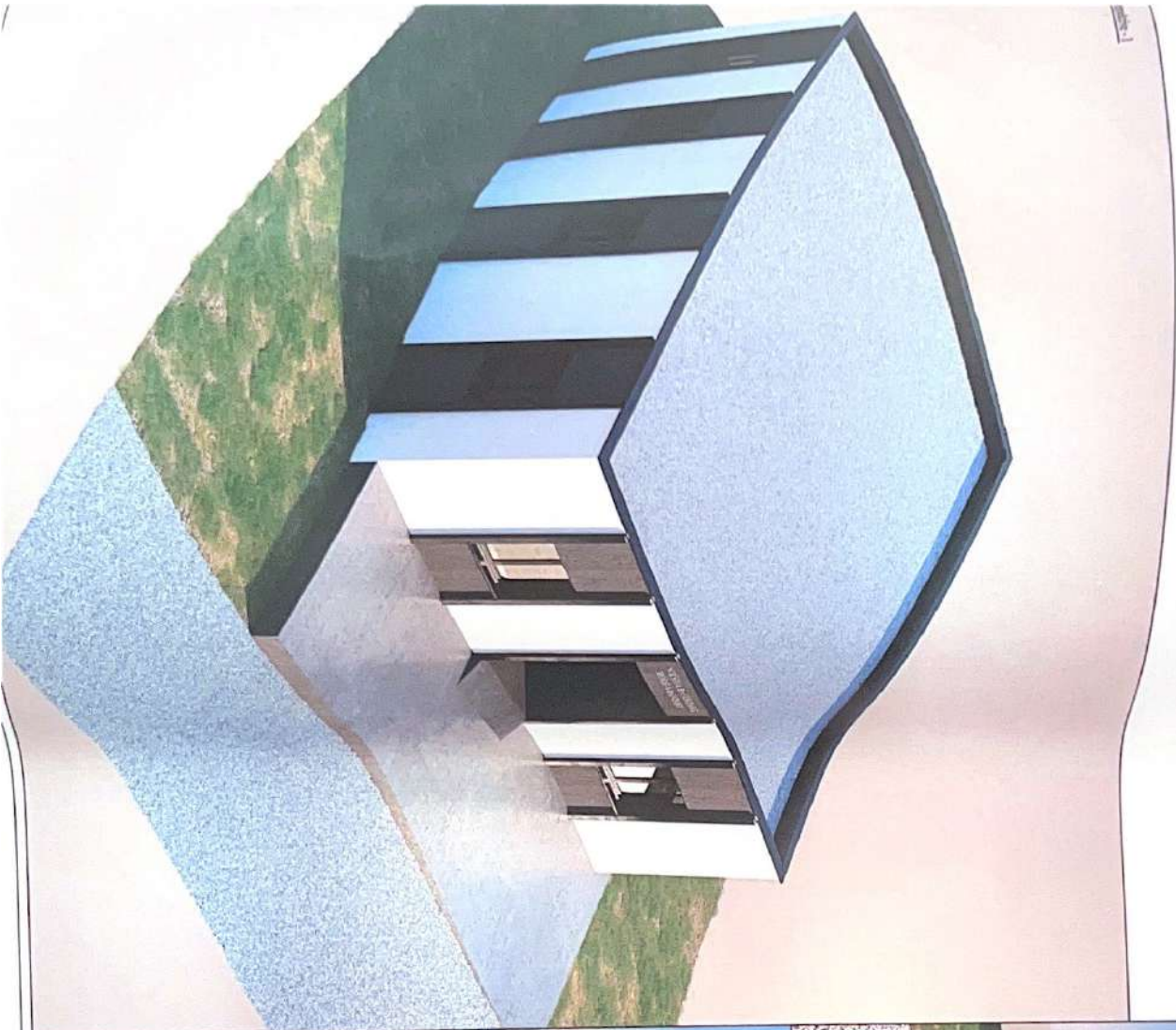

Panoramic - 1



Panoramic - 2

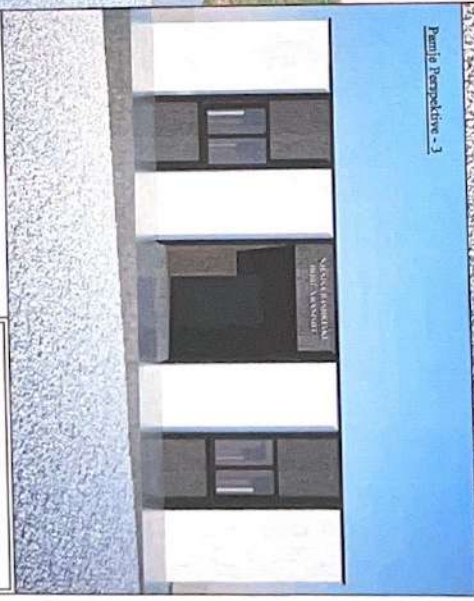

Panoramic - 3

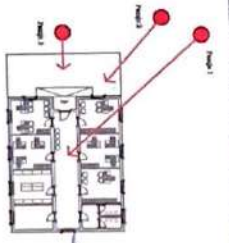

General Information:
 Project Name: "Project Name" (to be completed by the client)
 Project Location: "Project Location" (to be completed by the client)
 Project Start Date: "Project Start Date" (to be completed by the client)
 Project End Date: "Project End Date" (to be completed by the client)
 Project Status: "Project Status" (to be completed by the client)
 Project Manager: "Project Manager" (to be completed by the client)
 Project Contact: "Project Contact" (to be completed by the client)
 Project Address: "Project Address" (to be completed by the client)

Date: "Date" (to be completed by the client)
 Time: "Time" (to be completed by the client)
 Page: "Page" (to be completed by the client)
 Total Pages: "Total Pages" (to be completed by the client)