



BASHKIA
TIRANË

DREJTORIA E PËRGJITHSHME E PLANIFIKIMIT TË INVESTIMEVE
DHE MONITORIMIT TË PUNËVE PUBLIKE

MIRATOHET
KRYETAR
ERION VELIAJ

Në mungesë dhe me urdhër
NENKRYETARE
ANUELA RISTANI

V.K.T. Nr....., DATË...../...../.....

PROJEKTI I ZBATIMIT

OBJEKTI: *“Rikualifikim urban i bllokut qe kufizohet nga BLV. Bajram Curri-
Blv Petro N. Luarasi – Rruga Taulantia - Rruga Ali Demi – Faza II” (Sinjalistika)*

PROJEKTUES:

ARCHISPACE SH.P.K.

Tiranë, Shqipëri

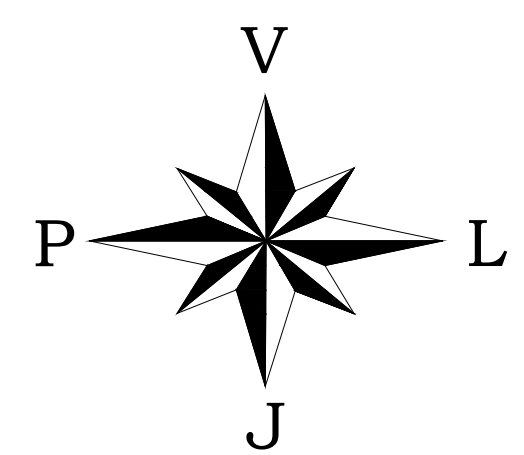


- SHENIME :**
-  RRUGA NE PROJEKT
 -  PROFILAT DHE NR. PERKATES
 -  NDERTESA
 -  DIMENSIONE TE RRUGES NE PROJEKT
 -  TROTUAR ME PLAKA
 -  EMERTIMI I SEGMENTIT RRUGOR & POZICIONI I TABELLES
 -  TABELA RRUGORE
 -  TRUPI I RRUGES & VLEZIME



**PROJEKT
INFRASTRUKTUROR**

**ZHVILLUES
BASHKIA TIRANE**

**EMERTIMI I FLETES
PLANIMETRIA E SINJALISTIKES**
 "RIKUALIFIKIMI URBAN I BLOKUT QE
 KUFIZOHET NGA VLV. BAJRAM CURRI
 - BLV PETRO N. LUARASI - RRUGA
 TAULANTIA - RRUGA ALI DEMI"
 FAZA II

SHKALLA : 1:500

NR. I FLETES **VI-01**

ARCHISPACE Sh.p.k.
 NR. LIC. N.6732/14
 ARK. RAIS PETRELA
 ING INFRASTRUKTURE
 EDISON DRISHTI
 ARK. LUCIANO BOJAXHIU

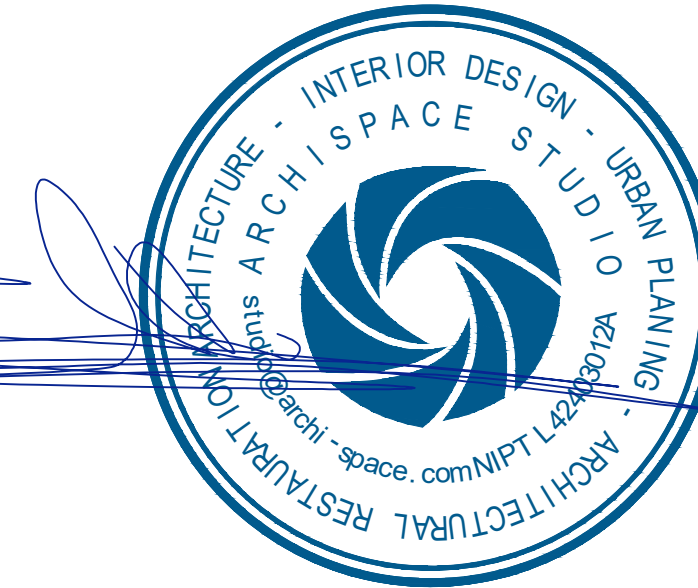

ARCHISPACE SHPK
 Te gjitha materialet qe serviren ne kete projekt / faqe jane origjinale dhe cdo riprodhim i tyre ne cdo forme pa pajtim tone konsiderohet shkelje ligjore. Jemi te lutur qe te gjitha pa perjashtim te respektoni te drejtat e autorit. Ne respektojmë te drejtën e autorit dhe për cdo material të huazuar kemi dhënë kreditet e duhura autorit. Që të kopjoni materialet tona, duhet të merrni pajtimin tonë.

TIRANE 2025

SHENJAT NDALUESE

SINJALET E RREZIKUT

SINJALET E PERPARESISE

MENYRA E VENDOSJES SE TABELAVE RRUGORE

Kufizim Maksimal i Shpejtesise

NO ENTER

Ndal dhe jep perparesi

Kthese

Vendkalim kembesoresh

Kryqezim me te drejte perparesi

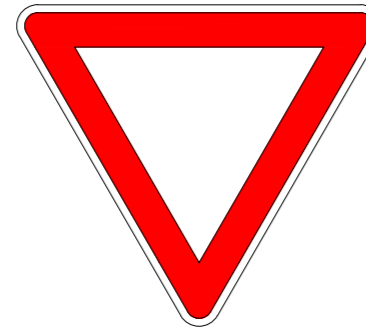
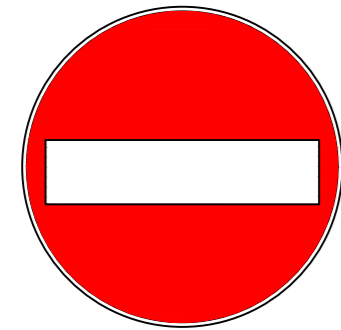

SINJALET E DREJTIMIT

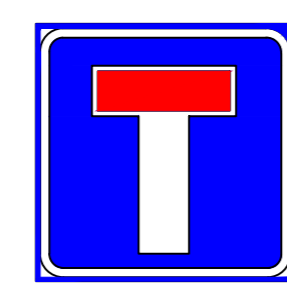

PERMASAT E SHENJAVE RRUGORE

PERMASAT E SHENJAVE RRUGORE

Shenje kuadratike

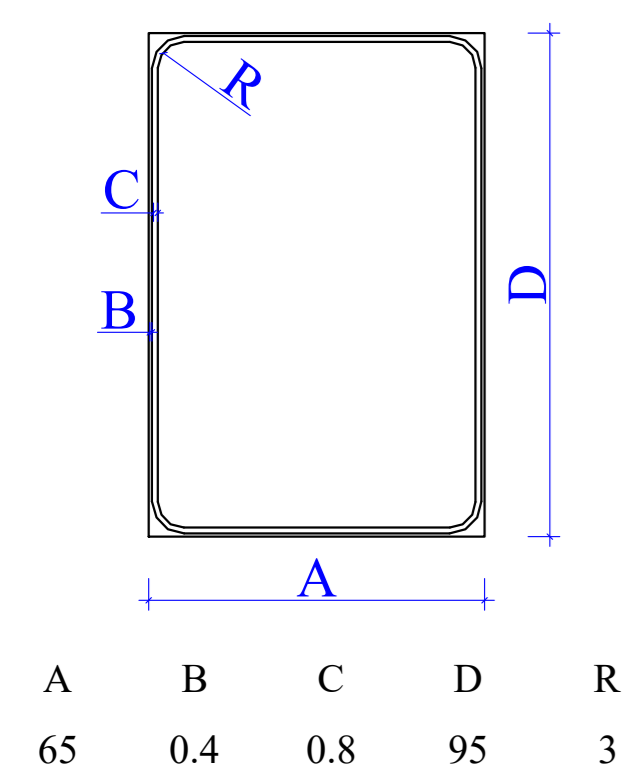

Modular i shenjave trekendore

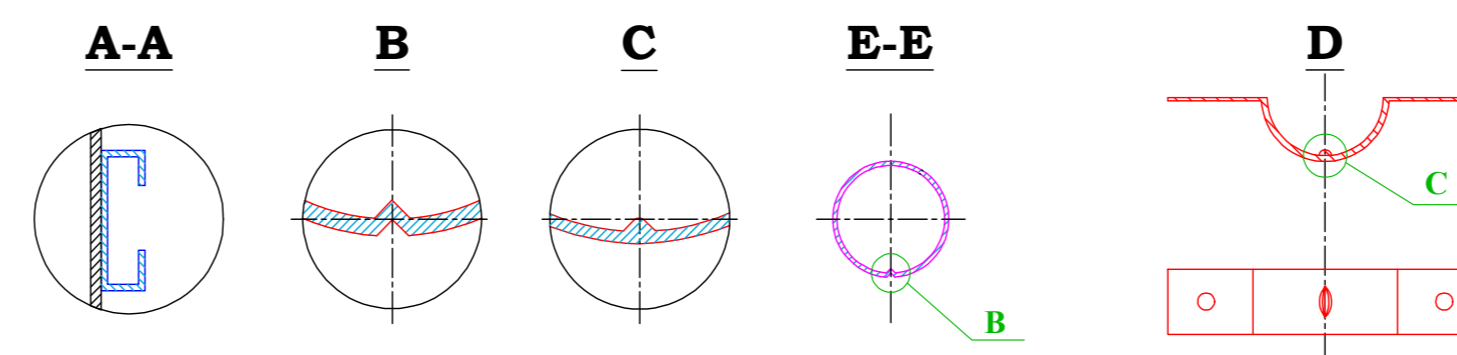
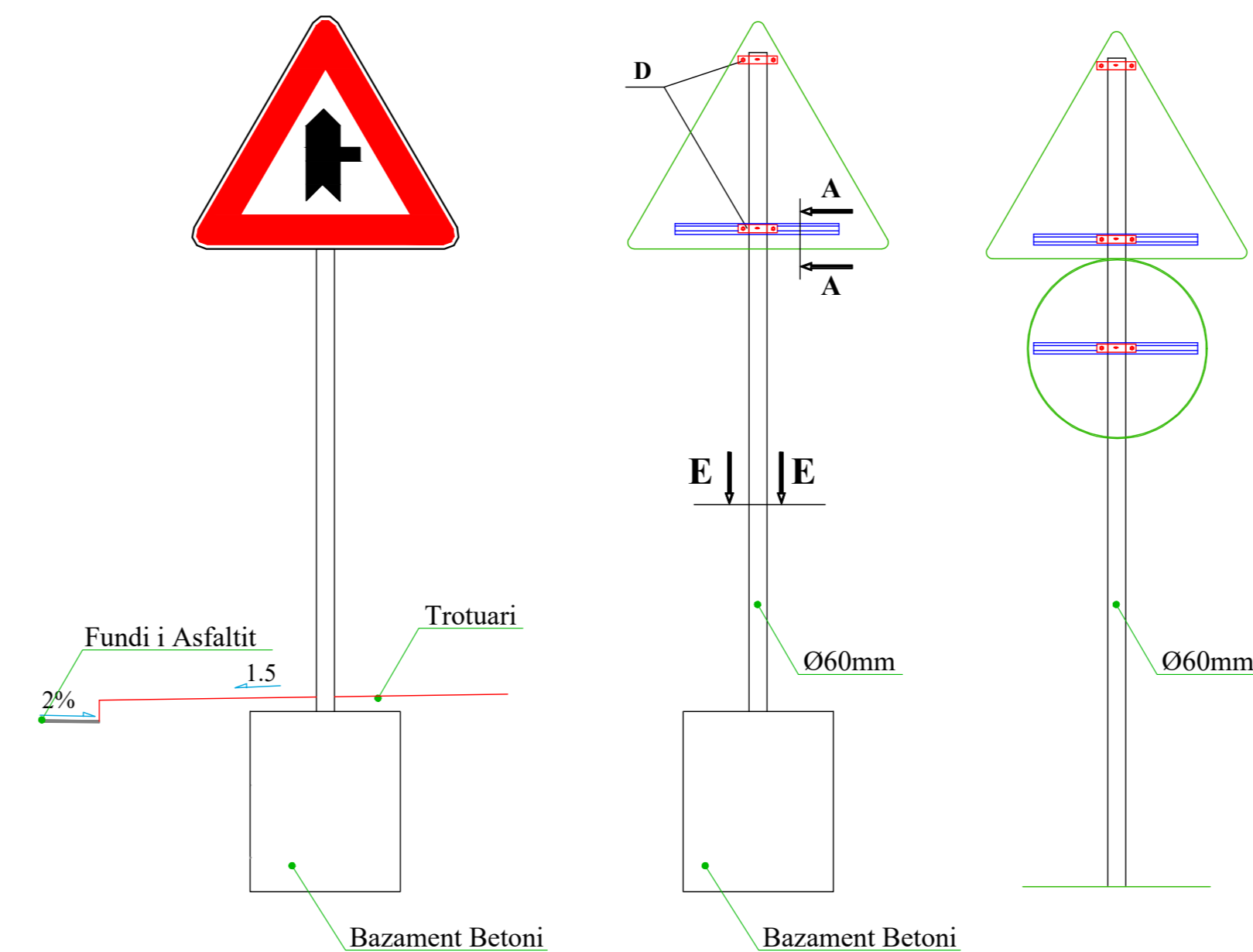
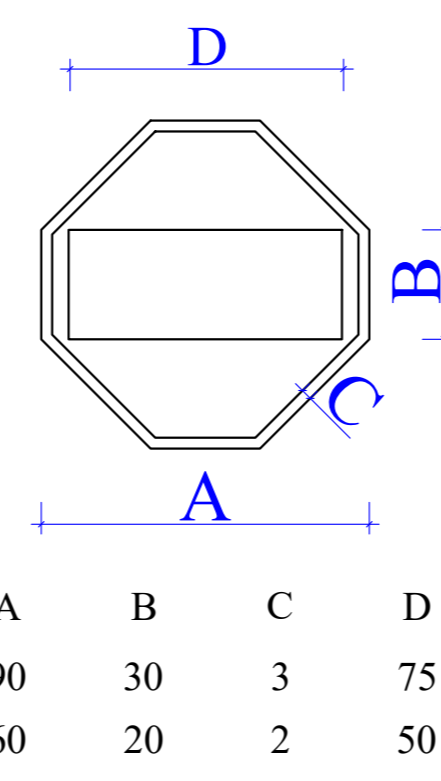
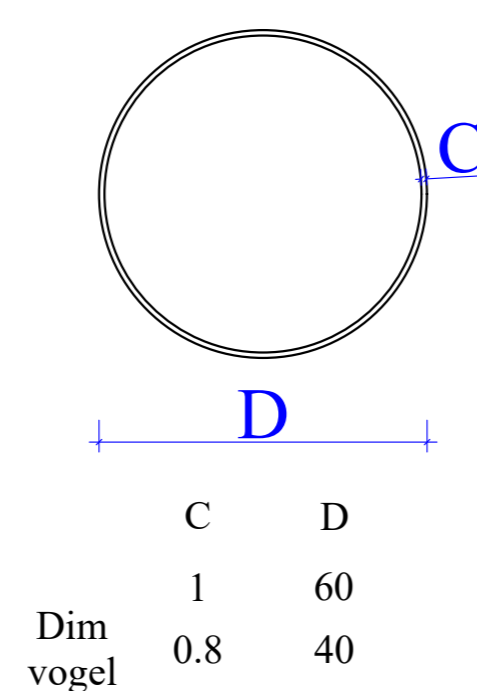
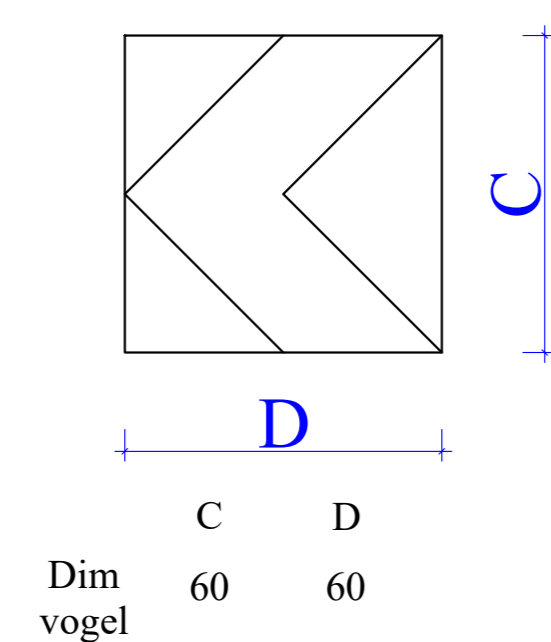
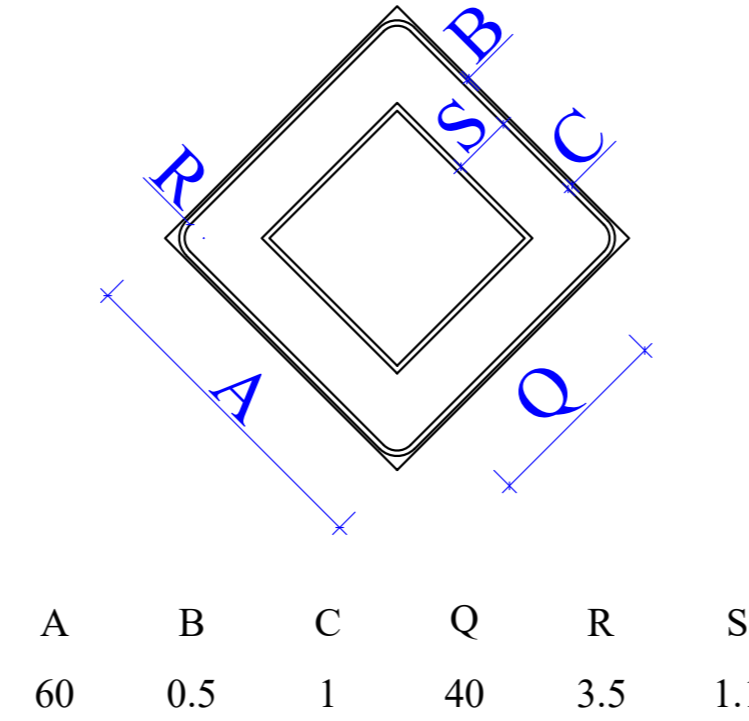
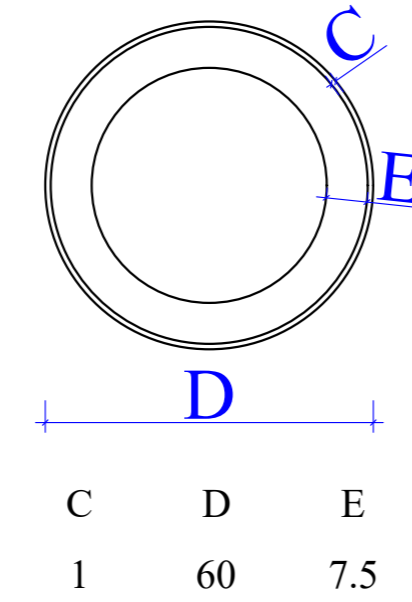
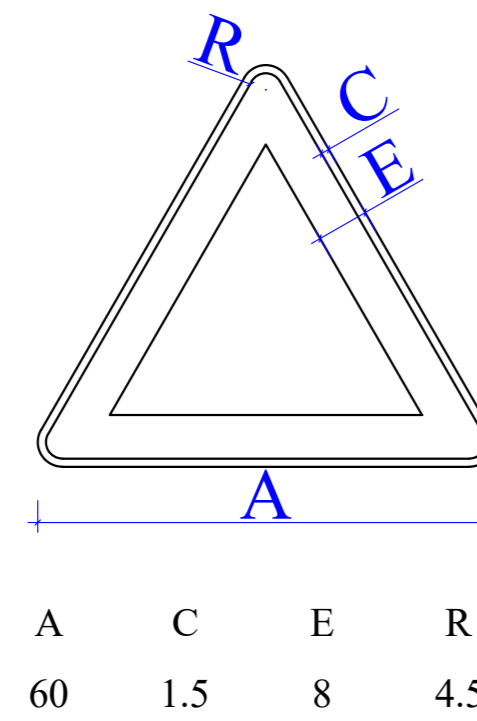
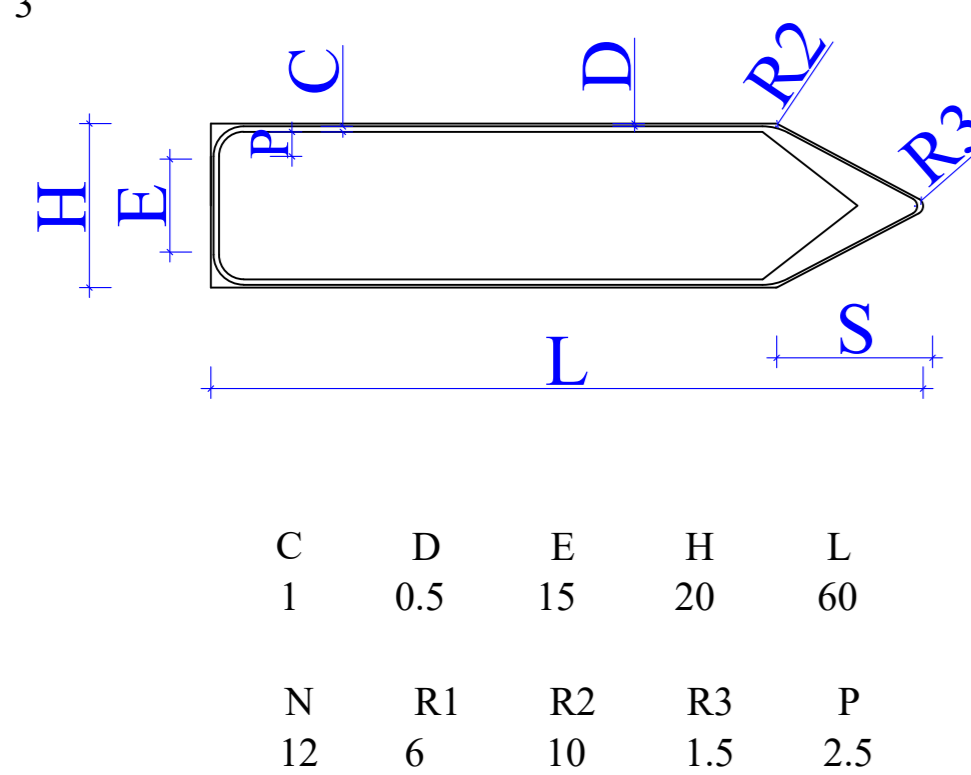
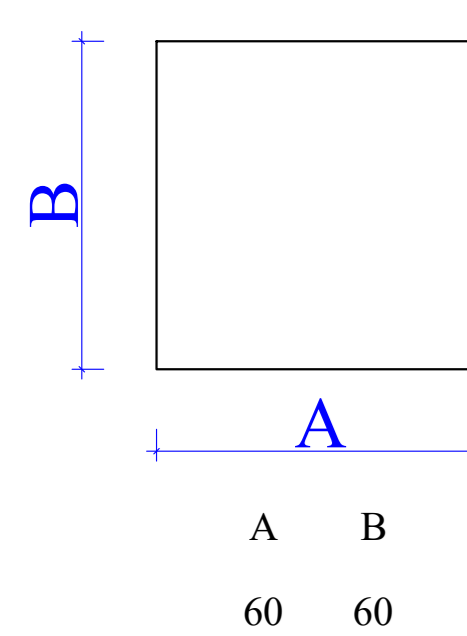
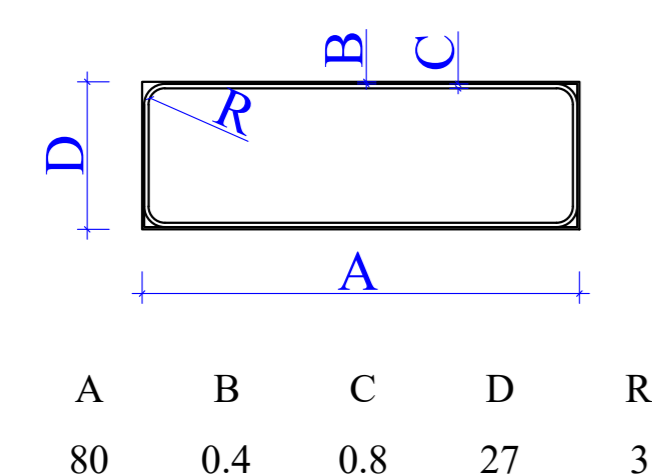

DIMENSIONET E SHIGJETAVE TE DREJTIMIT TE LEVIZJES

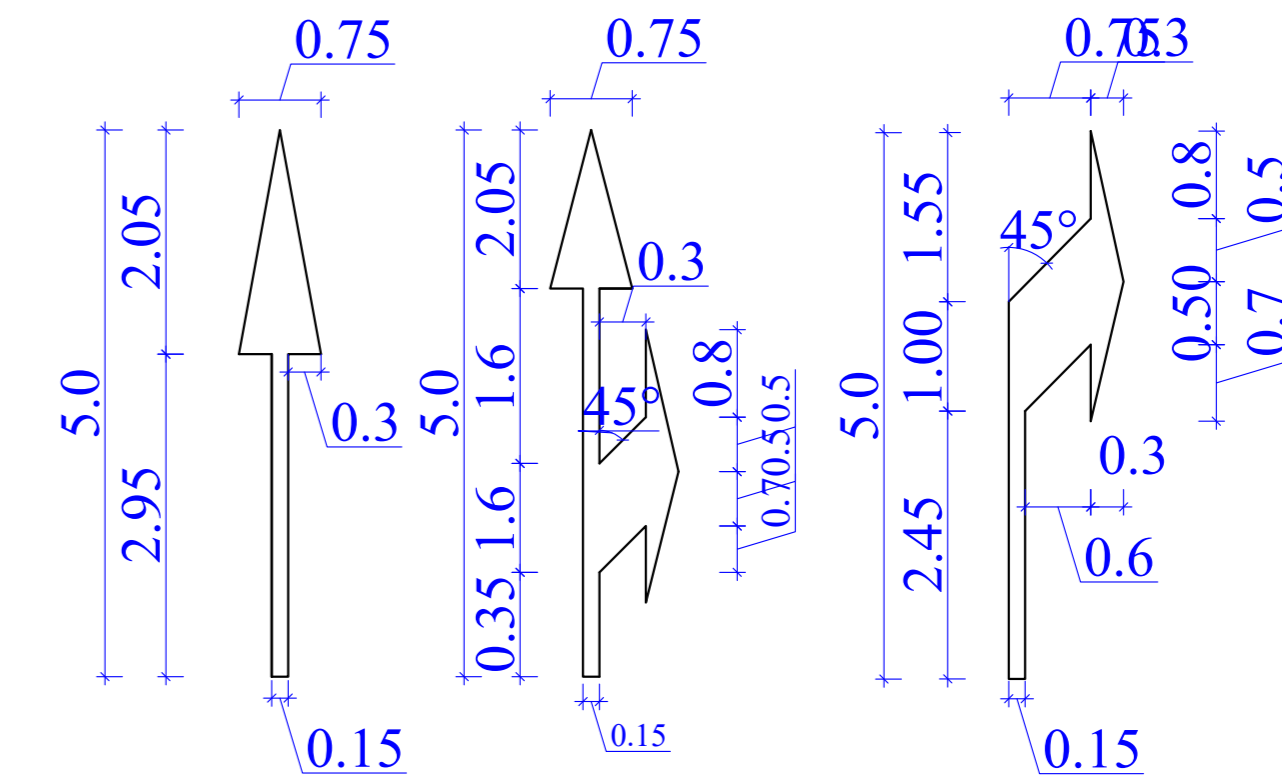

SHENIME :



PROJEKT INFRASTRUKTUROR

ZHVILLUES BASHKIA TIRANE

EMERTIMI I FLETES DETAJET E SINJALISTIKES
 "RIKUALIFIKIMI URBAN I BLOKUT QE KUFIZOHET NGA VLV. BAJRAM CURRI - BLV PETRO N. LUARASI - RRUGA TAULANTIA - RRUGA ALI DEMI" FAZA II

SHKALLA : FIT

NR. I FLETES VI-02

ARCHISPACE Sh.p.k. NR. LIC. N.6732/14

ARK. RAIS PETRELA
 ING INFRASTRUKTURE
 EDISON DRISHTI

ARK. LUCIANO BOJAXHIU



ARCHISPACE SHPK
 Te gjitha materialet qe serviren ne kete projekt / faqe jane origjinale dhe cdo riprodhim i tyre ne cdo forme pa pelqimin tone konsiderohet shkelje ligjore. Jeni te lutur qe te gjitha te perjashtim te respektoni te drejtat e autorit. Ne respektojme te drejten e autorit dhe per cdo material te huazuar kemi dhene kreditet e duhura autorit. Qe te kopjoni materialet tona, duhet te merrni pelqimin tone.