

LEGJENDE

-  Asfalt ekzistues
-  Aksi i rruges
-  Gjurme asfalti
-  Tabele sinjalistike
-  Tabele sinjalistike
-  Tabele sinjalistike
-  Tabele sinjalistike



BASHKIA KAMËZ

DREJTORIA E PRËJKTETEVE DHE INVESTIMEVE
DEPARTAMENTI I PRËJKTETEVE

Dr. e Projekteve e Investimeve	RAMADAN HYSA								
Prgj. Sektori i Projekteve	DENIS PRËNÇI								
STAFI TEKNIK PROJEKTES	<table border="1"> <tr> <td>Ing.</td> <td>EMANUELA MËZIU</td> </tr> <tr> <td>Ing.</td> <td>ARTUR ÇAJKA</td> </tr> <tr> <td>Ing.</td> <td>ALEKS DANI</td> </tr> <tr> <td>Ing.</td> <td>ARJOLA KURTI</td> </tr> </table>	Ing.	EMANUELA MËZIU	Ing.	ARTUR ÇAJKA	Ing.	ALEKS DANI	Ing.	ARJOLA KURTI
Ing.	EMANUELA MËZIU								
Ing.	ARTUR ÇAJKA								
Ing.	ALEKS DANI								
Ing.	ARJOLA KURTI								

Titulli i Projektit	Faza e Projektit
NDËRTIM RRUGËT BLOKU "PASKUQAN , KAMEZ, BATHORE".	PROJEKT ZBATIMI
Emertimi i Fletes	Data e Implementimit :
PLANIMETRI SINJALISTIKE	Shkalla e Vizatimit 1:750
	Fleta Nr. 20



LEGJENDE

-  Asfalt ekzistues
-  Aksi i rruges
-  Gjurmë asfalti
-  Tabele sinjalistike
-  Tabele sinjalistike
-  Tabele sinjalistike
-  Tabele sinjalistike

BASHKIA KAMËZ
 DREJTORIA E PROJEKTEVE DHE INVESTIMEVE
 DEPARTAMENTI I PROJEKTEVE

Dr. e Projekteve e Investimeve	RAMADAN HYSA
Prgj. Sektori i Projekteve	DENIS PRENÇI
STAFI TEKNIK	Ing. EMANUELA MËZIU
PROJEKTES	Ing. ARTUR ÇAJKA
	Ing. ALEKS DANI
	Ing. ARJOLA KURTI

Titulli i Projektit	NDËRTIM RRUGËT BLOKU "PAŠKUQAN , KAMEZ, BATHORE".
Emertimi i Fletës	PLANIMETRI SINJALISTIKE
Faza e Projektit	PROJEKT ZBATIMI
Data e Implementimit	
Shkalla e Vizatimit	1:750
Fleta Nr.	21

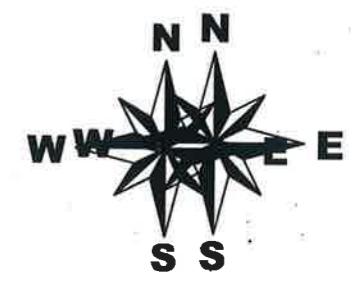

LEGJENDE

-  Asfalt ekzistues
-  Aksi i rruges
-  Gjurme asfalti
-  Tabele sinjalistike
-  Tabele sinjalistike
-  Tabele sinjalistike
-  Tabele sinjalistike

 **BASHKIA KAMEZ**
 DREJTORIA E PROJEKTEVE DHE INVESTIMEVE
 DEPARTAMENTI I PROJEKTEVE

Dr. e Projekteve e Investimeve	RAMADAN HYSA	
Prgj. Sektori i Projekteve	DENIS PRENÇI	
STAFI TEKNIK PROJEKTES	Ing. EMANUELA MËZIU	
	Ing. ARTUR ÇAJKA	
	Ing. ALEKS DANI	
	Ing. ARJOLA KURTI	

Titulli i Projektit	NDËRTIM RRUGËT BLOKU "PASKUQAN , KAMEZ, BATHORE".	Projekti PROJEKT ZBATIMI
Emertimi i Fletes	PLANIMETRI SINJALISTIKE	Data e Implementimit :
		Shkalla e Vizatimit 1:750
		Fleta Nr. 22



LEGJENDE

-  Asfalt ekzistues
-  Aksi i rruges
-  Gjurmë asfalti
-  Tabele sinjalistike
-  Tabele sinjalistike
-  Tabele sinjalistike
-  Tabele sinjalistike

 **BASHKIA KAMËZ**
 DREJTORIA E PROJEKTEVE DHË INVESTIMEVE
 DEPARTAMENTI I PROJEKTEVE

Dr. e Projekteve e Investimeve	RAMADAN.HYSA
Prgj. Sektori i Projekteve	DENIS PRENÇI

STAFI TEKNIK PROJEKTES	Ing.	EMANUELA MËZIU
	Ing.	ARTUR ÇAJKA
	Ing.	ALEKS DANI
	Ing.	ARJOLA.KURTI

Titulli i Projektit	NDËRTIM RRUGËT BLOKU "PASKUQAN , KAMEZ, BATHORE".
Emerimi i Fletes	PLANIMETRI SINJALISTIKE
Faza e Projektit	PROJEKT ZBATIMI
Data e implementimit :	
Shkalla e Vizimit	1:750
Fleta Nr.	24

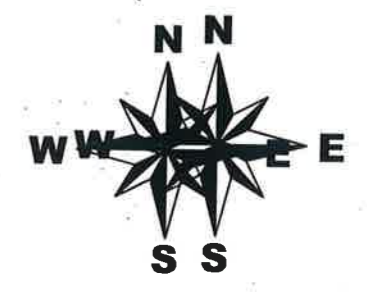

LEGJENDE

- Asphalt ekzistues
- Aksi i rruges
- Gjurme asfalti
- Tabele sinjalistike
- Tabele sinjalistike
- Tabele sinjalistike
- Tabele sinjalistike

BASHKIA KAMËZ
 DREJTORIA E PRËKJETEVE DHE INVESTIMEVE
 DEPARTAMENTI I PRËKJETEVE

Dr. e Projekteve e Investimeve	RAMADAN HYSA	
Prgj. Sektori i Projekteve	DENIŠ PRENÇI	
STAFI TEKNIK PROJEKTUES	Ing. EMANUELA MËZIU	
	Ing. ARTUR ÇAJKA	
	Ing. ALEKS DANI	
	Ing. ARJOLA KURTI	

Titulli i Projektit	Faza e Projektit
NDËRTIM RRUGËT BLOKU "PASKUQAN , KAMËZ, BATHORE".	PROJEKT ZBATIMI
Emertimi i Fletes	Data e Implementimit :
PLANIMETRI SINJALISTIKE	
	Shkalla e Vizatimit
	1:500
	Fleta Nr.
	25



BASHKIA KAMËZ

PROJEKT ZBATIMI

OBJEKTI:

NDËRTIM RRUGËT BLOKU "PASKUQAN , KAMËZ , BATHORE".

7.PROFILET GJATËSORE TË RRUGËVE

		BASHKIA KAMËZ	
		DREJTORIA E PROJEKTEVE DHE INVESTIMEVE DEPARTAMENTI I PROJEKTEVE	
Dr. e Projekteve e Investimeve		RAMADAN HYSA	
Përgj. e Sekt. të Projekteve		DENIS PRENÇI	
STAFI TEKNIK PROJEKTES	Ing.	EMANUELA MËZIU	
	Ing.	ARTUR ÇAJKA	
	Ing.	ALEKS DANI	
	Ing.	ARJOLA KURTI	
Titulli i Projektit		Faza e Projektit	
NDËRTIM RRUGËT BLOKU "PASKUQAN , KAMËZ , BATHORE".		PROJEKT ZBATIMI	
Emertimi i Fletes		Data e Implementimit :	
KAPAK		Shkalla e Vizatimit	
		Fleta Nr.	
		00	

PROFLET GJATËSORE TË RRUGËVE BLOKUT "PASKUQAN , KAMËZ , BATHORE".

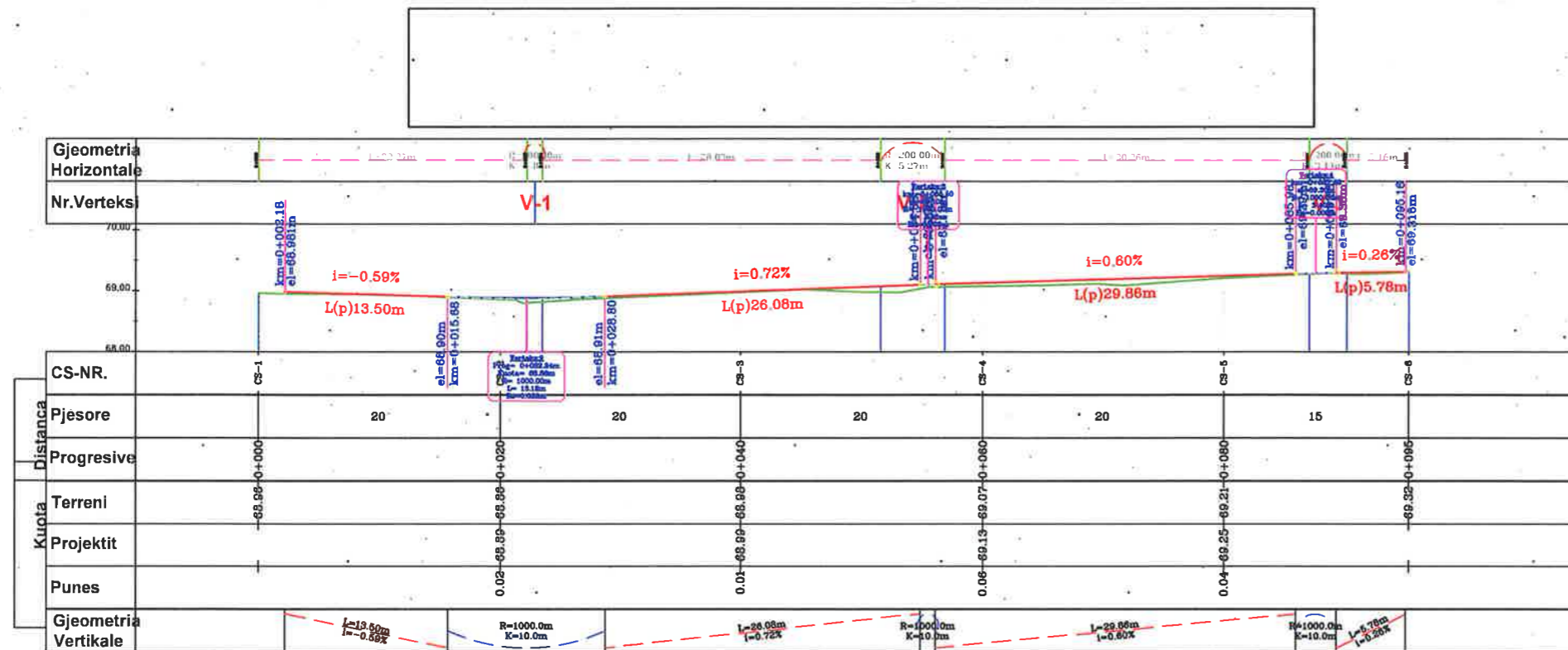
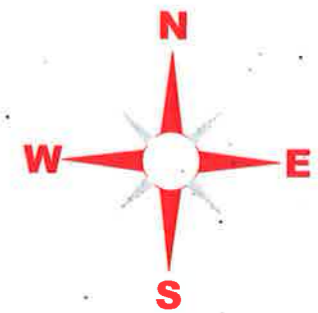

- LEGJENDA**
- NIVELETA E RRUGES
 - TERRENI NATYRAL

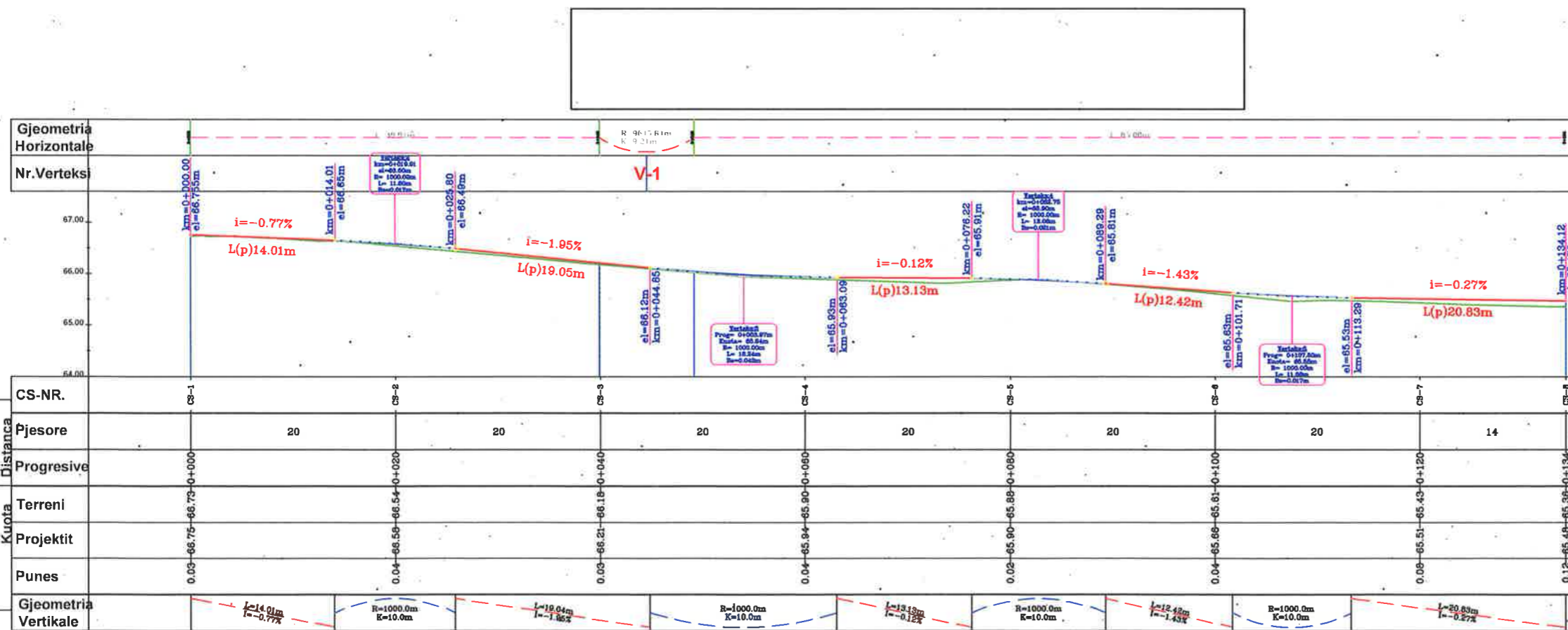

BASHKIA KAMEZ
 DREJTORIA E PROJEKTEVE DHE INVESTIMEVE
 DEPARTAMENTI I PROJEKTEVE

Dr. e Projekteve e Investimeve	RAMADAN HYSA
Pergj. Sektori i Projekteve	DENIS PRENCI
STAFI TEKNIK PROJEKTES	Ing. EMANUELA MËZIU Ing. ARTUR ÇAJKA Ing. ALEKS DANI Ing. ARJOLA KURTI

Titulli i Projektit	NDËRTIM RRUGËT BLOKUT "PASKUQAN , KAMËZ , BATHORE".
Faza e Projektit	PROJEKT ZBATIMI
Data e Implementimit	
Shkalla e Vizatimit	H 1:500 V 1:150
Fleta Nr.	01

Emertimi i Fletes
 PROFLET GJATESORE

PROFLET GJATËSORE TË RRUGËVE BLOKUT "PASKUQAN , KAMËZ , BATHORE".

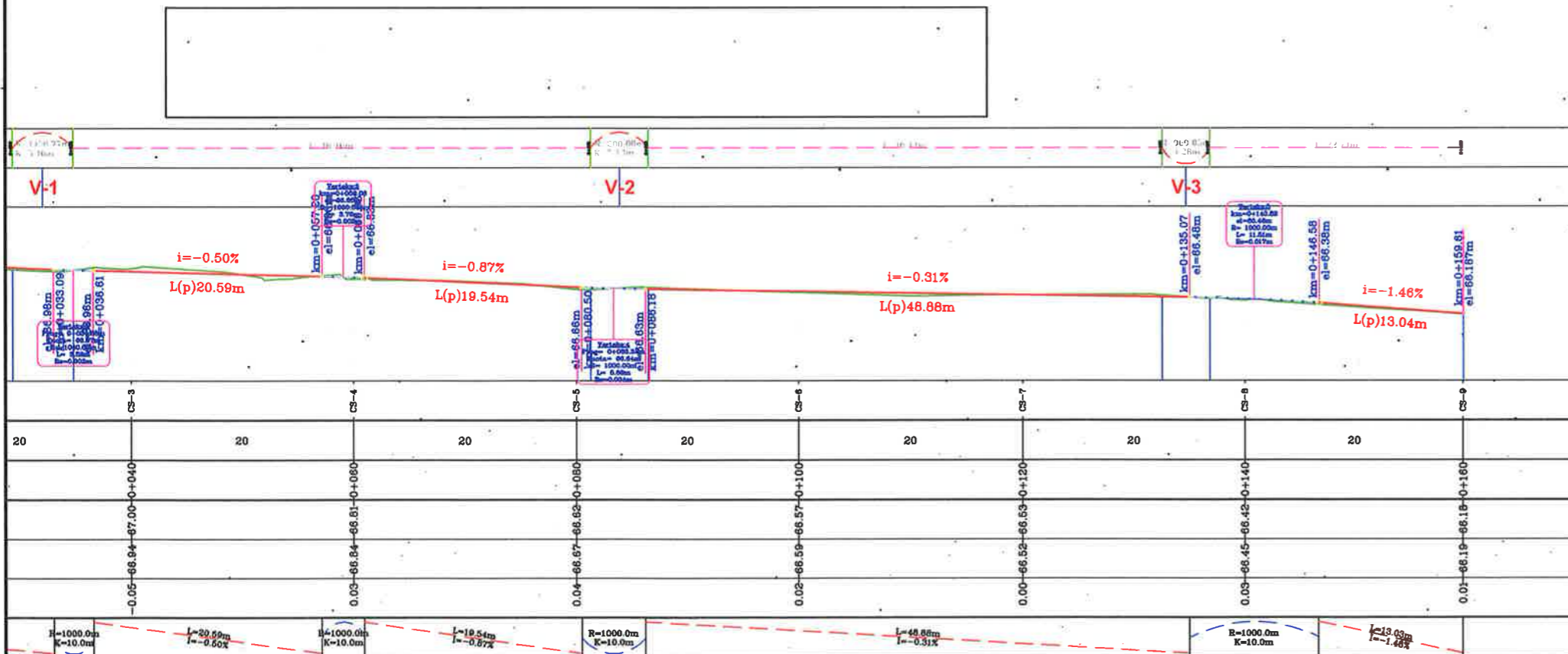
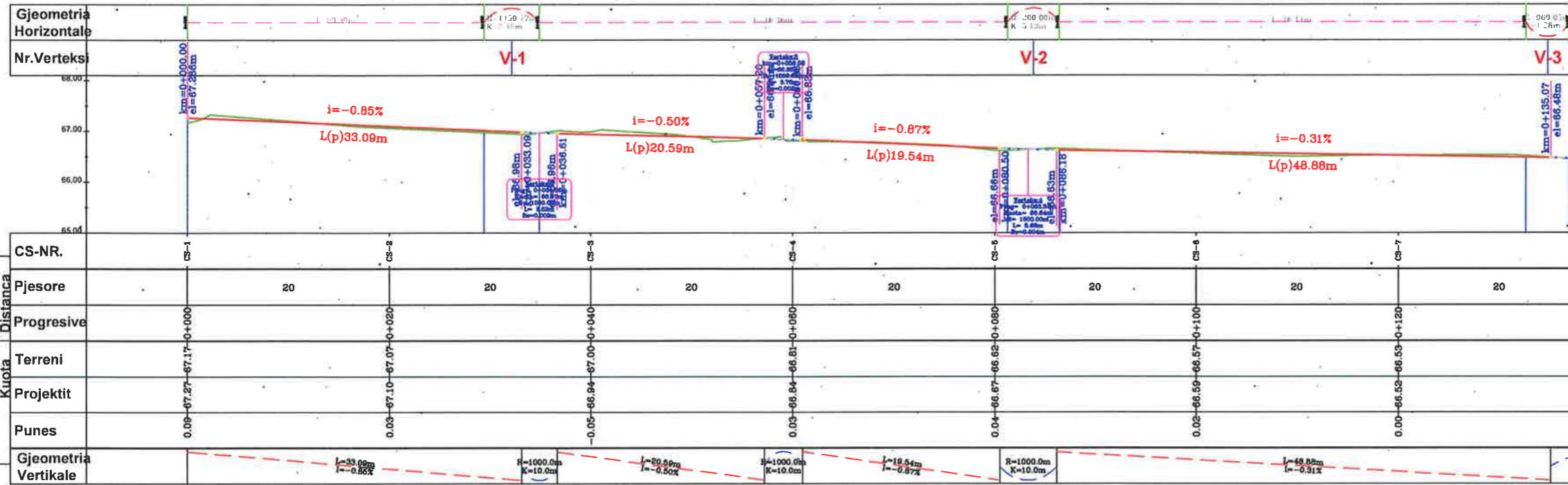
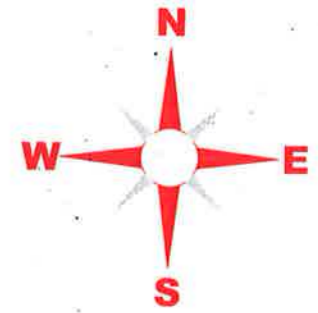

LEGJENDA

- NIVELETA E RRUGES
- TERRENI NATYRAL



BASHKIA KAMEZ

DREJTORIA E PROJEKTEVE DHE INVESTIMEVE
DEPARTAMENTI I PROJEKTEVE

Dr. e Projekteve e Investimeve	RAMADAN HYSA	
Pergj. Sektori i Projekteve	DENIS PRENCI	
STAFI TEKNIK PROJEKTES	Ing. EMANUELA MËZIU	
	Ing. ARTUR ÇAJKA	
	Ing. ALEKS DANI	
	Ing. ARJOLA KURTI	

Titulli i Projektit	NDËRTIM RRUGËT BLOKUT "PASKUQAN , KAMËZ , BATHORE".
Faza e Projektit	PROJEKT ZBATIMI
Data e Implementimit	
Shkalla e Vizatimit	H 1:500 V 1:150

Emertimi i Fietes
PROFLET GJATESORE

PROFLET GJATËSORE TË RRUGËVE BLOKUT "PASKUQAN , KAMËZ , BATHORE".

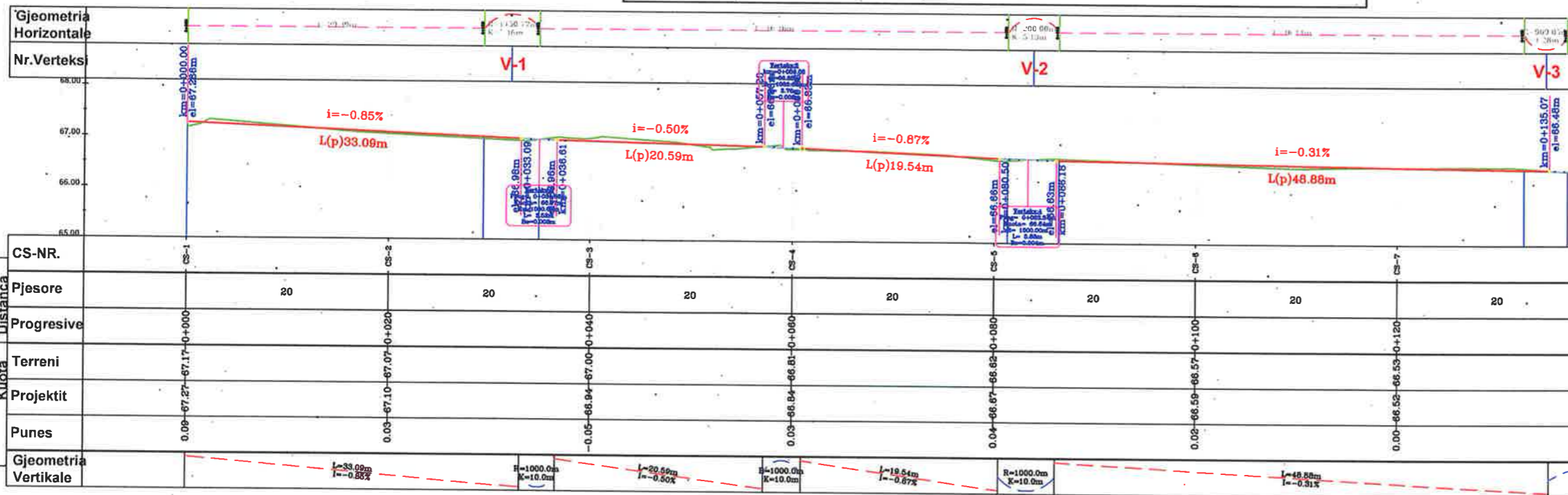
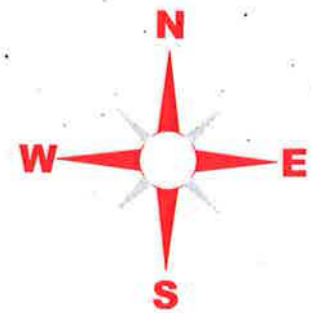

LEGJENDA

- NIVELETA E RRUGES
- TERRENI NATYRAL

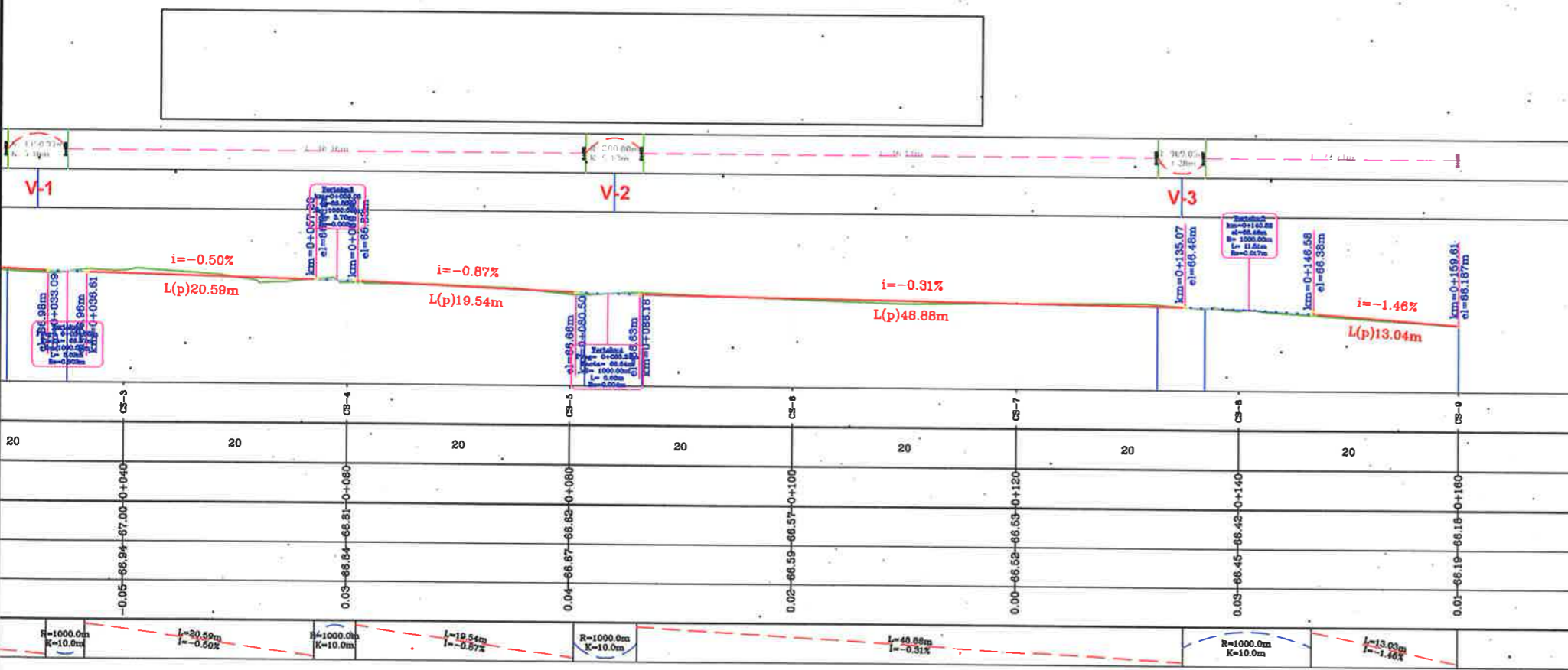

BASHKIA KAMEZ

DREJTORIA E PROJEKTEVE DHE INVESTIMEVE
DEPARTAMENTI I PROJEKTEVE

Dr. e Projekteve e Investimeve	RAMADAN HYSA
Pergj. Sektori i Projekteve	DENIS PRENCI
STAFI TEKNIK PROJEKTI	Ing. EMANUELA MËZIU
	Ing. ARTUR ÇAJKA
	Ing. ALEKS DANI
	Ing. ARJOLA KURTI

Titulli i Projektit	PROJEKT ZBATIMI
NDËRTIM RRUGËT BLOKUT "PASKUQAN , KAMËZ , BATHORE".	Data e Implementimit:
Emertimi i Fletes	Shkalla e Vizatimit: H 1:500 V 1:150
PROFLET GJATËSORE	Fleta Nr. 03

PROFLET GJATËSORE TË RRUGËVE BLOKUT "PASKUQAN , KAMËZ , BATHORE".

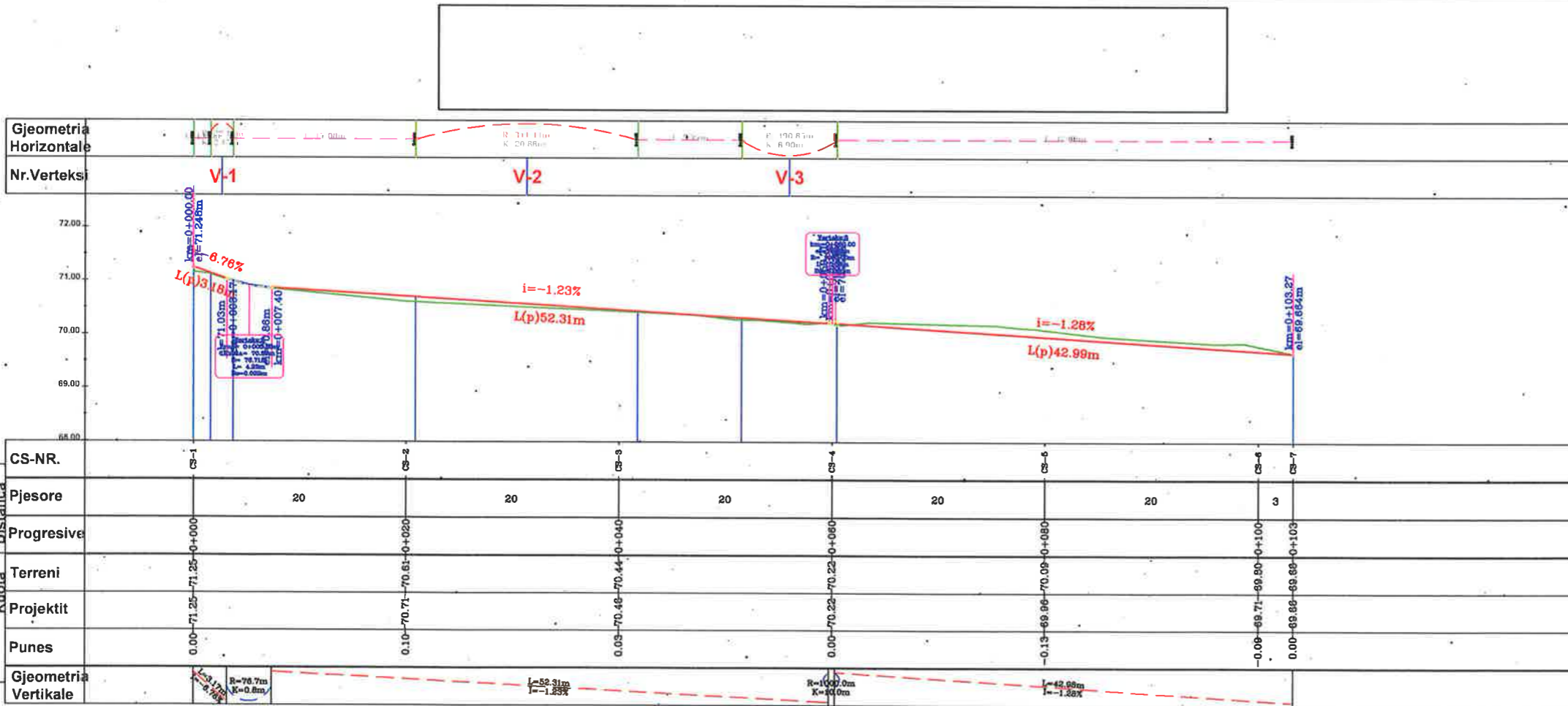
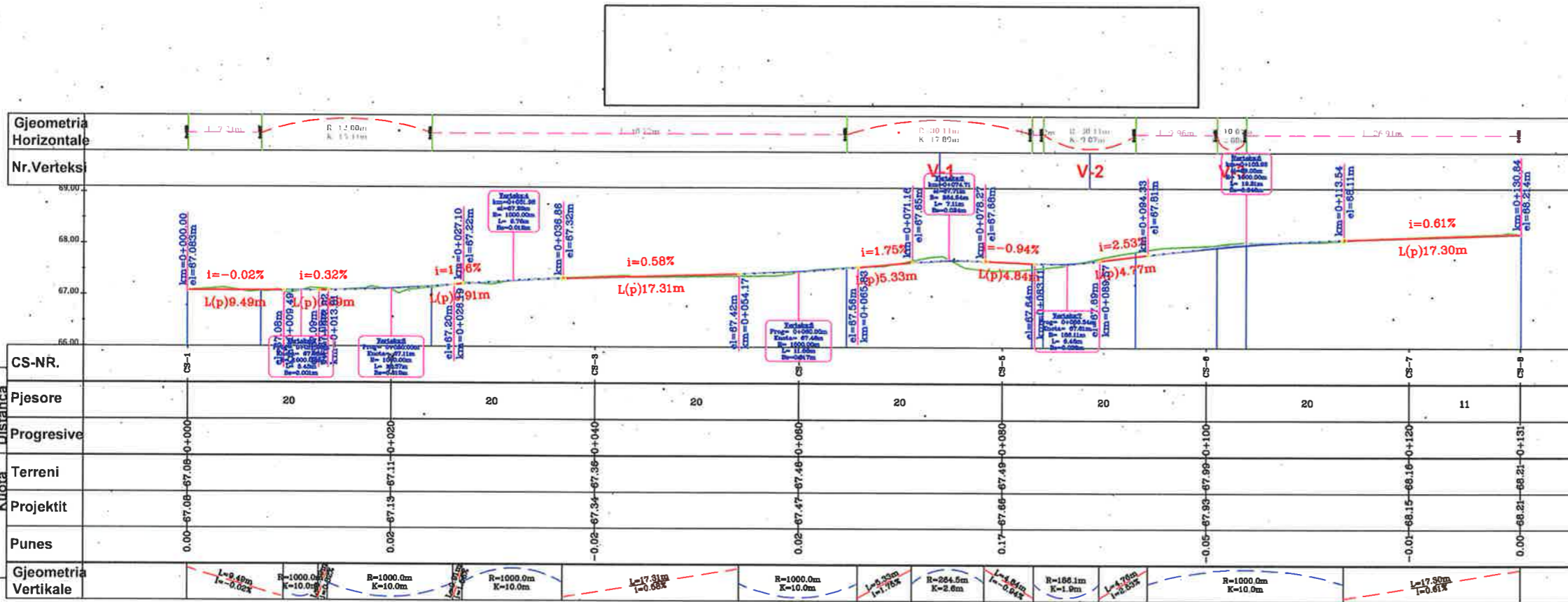
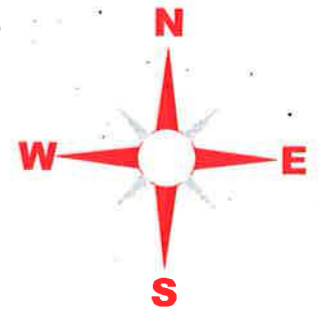

LEGJENDA

- NIVELETA E RRUGES
- TERRENI NATYRAL



BASHKIA KAMEZ

DREJTORIA E PROJEKTEVE DHE INVESTIMEVE
DEPARTAMENTI I PROJEKTEVE

Dr. e Projekteve e Investimeve	RAMADAN HYSA	
Pergj. Sektori i Projekteve	DENIS PRENÇI	
STAFI TEKNIK PROJEKTES	Ing. EMANUELA MËZIU	
	Ing. ARTUR ÇAJKA	
	Ing. ALEKS DANI	
	Ing. ARJOLA KURTI	

Titulli i Projektit	Faza e Projektit
NDËRTIM RRUGËT BLOKUT "PASKUQAN , KAMËZ , BATHORE".	PROJEKT ZBATIMI
Emertimi i Fietes	Data e implementimit :
PROFLET GJATESORE	Shkalla e Vizatimit H 1:500 V 1:150
	Fleta Nr.
	04

PROFLET GJATËSORE TË RRUGËVE BLOKUT "PASKUQAN , KAMËZ , BATHORE".

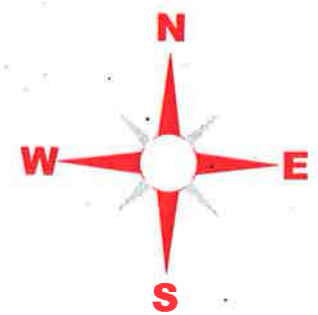
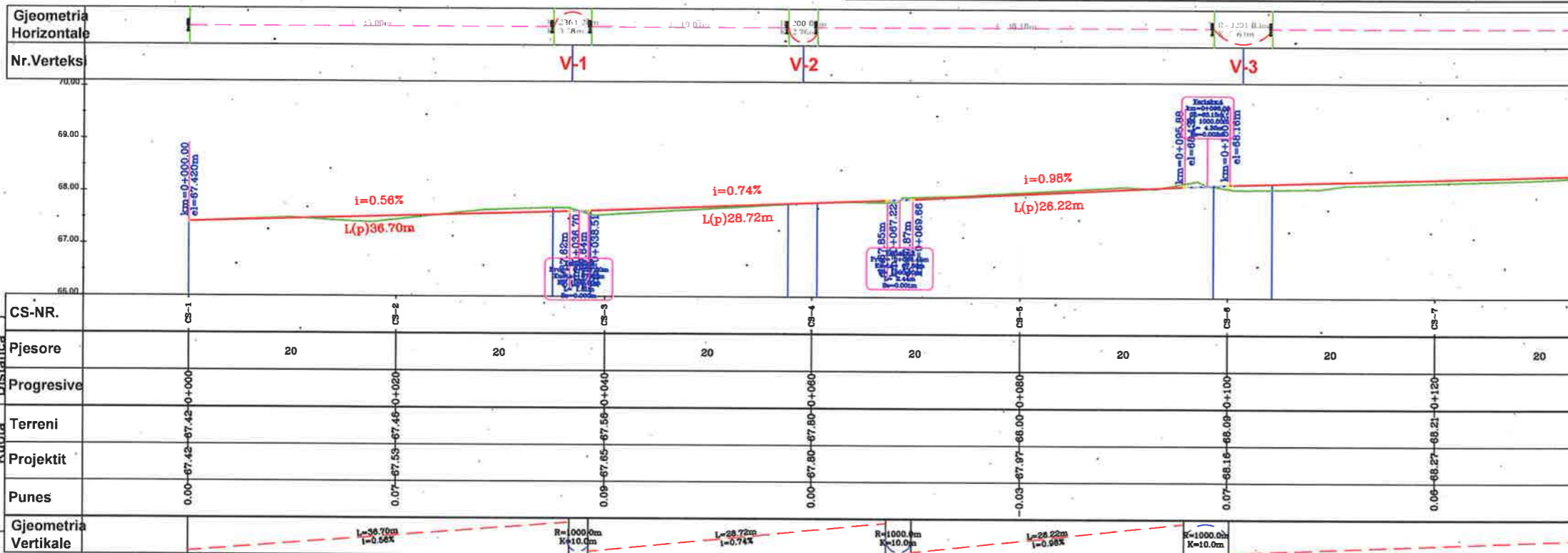

LEGJENDA

- NIVELETA E RRUGES
- TERRENI NATYRAL

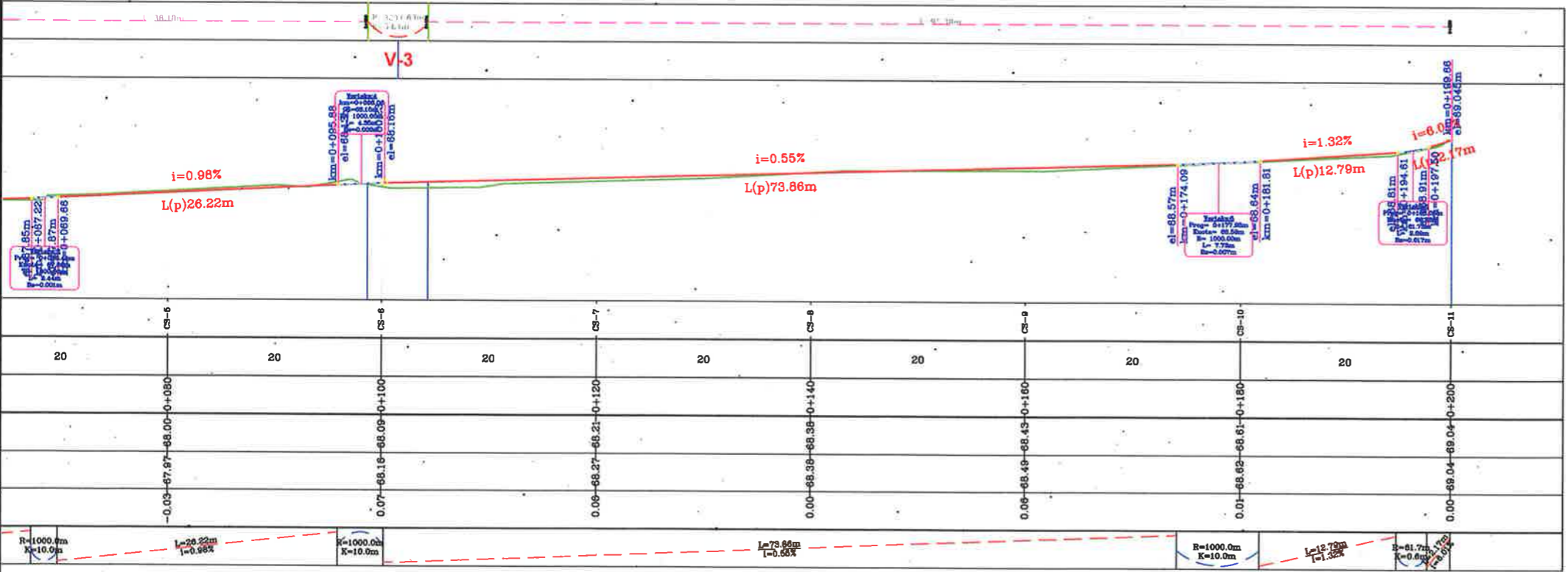

BASHKIA KAMEZ
 DREJTORIA E PROJEKTEVE DHE INVESTIMEVE
 DEPARTAMENTI I PROJEKTEVE

Dr. e Projekteve e Investimeve	RAMADAN HYSA
Pergi. Sektori i Projekteve	DENIS PRENÇI
STAFI TEKNIK PROJEKTES	Ing. EMANUELA MËZIU Ing. ARTUR ÇAJKA Ing. ALEKS DANI Ing. ARJOLA KURTI

Titulli i Projektit
 NDËRTIM RRUGËT BLOKUT "PASKUQAN , KAMËZ , BATHORE".

Faza e Projektit
 PROJEKT ZBATIMI

Shkalla e Vizatimit
 H 1:500 V 1:150

Emertimi i Fletes
 PROFLET GJATESORE

Fleta Nr.
 05

PROFLET GJATËSORE TË RRUGËVE BLOKUT "PASKUQAN , KAMËZ , BATHORE".

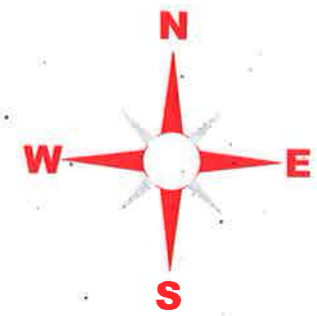

LEGJENDA

- NIVELETA E RRUGES
- TERRENI NATYRAL

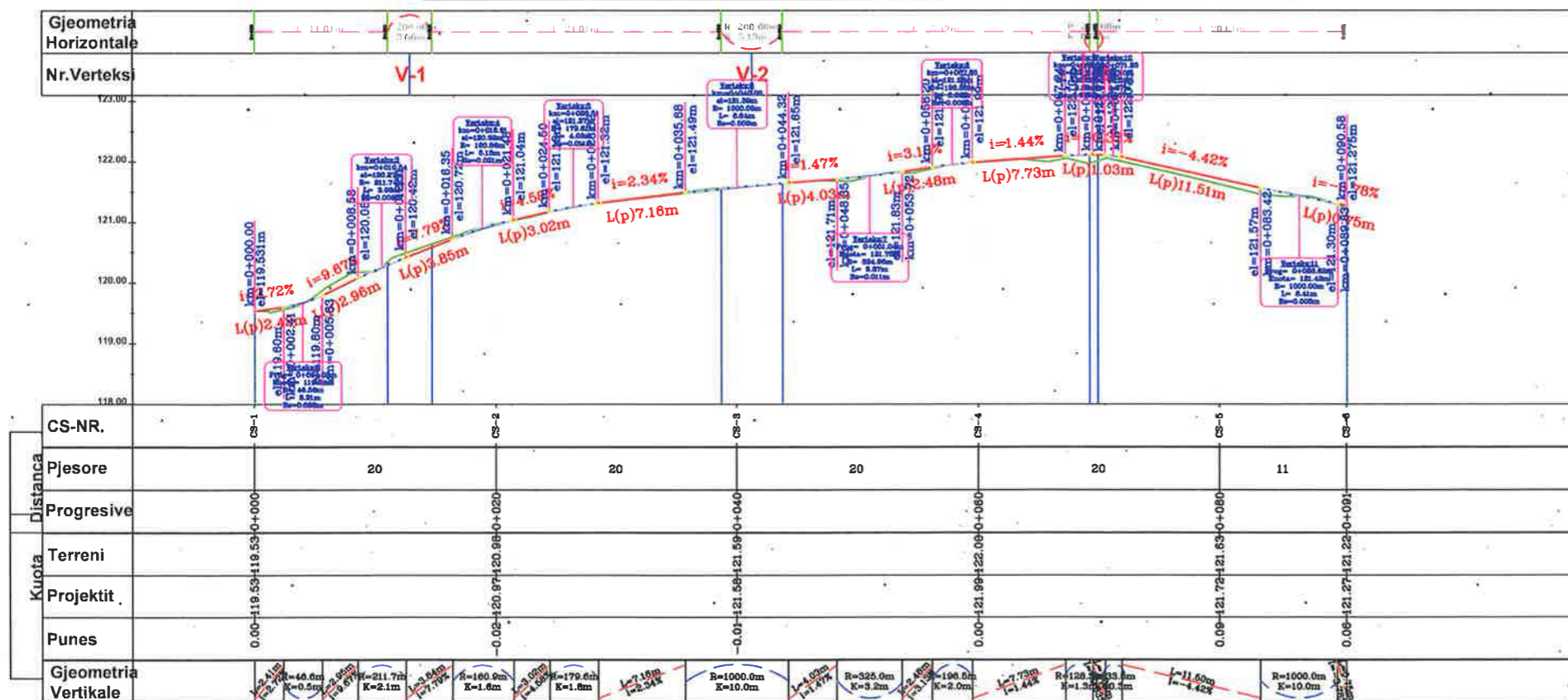

BASHKIA KAMEZ

DREJTORIA E PROJEKTEVE DHE INVESTIMEVE
DEPARTAMENTI I PROJEKTEVE

Dr. e Projekteve e Investimeve	RAMADAN HYSA
Pergj. Sektori i Projekteve	DENIS PRENÇI
STAFI TEKNIK PROJEKTES	Ing. EMANUELA MËZIU Ing. ARTUR ÇAJKA Ing. ALEKS DANI Ing. ARJOLA KURTI

Titulli i Projektit		Faza e Projektit
NDËRTIM RRUGËT BLOKUT "PASKUQAN , KAMËZ , BATHORE".		PROJEKT ZBATIMI
Emertimi i Fletes		Data e Implementimit :
PROFLET GJATESORE		Shkalla e Vizatimit H 1:500 V 1:150
		Fleta Nr.
		06

PROFLET GJATËSORE TË RRUGËVE BLOKUT "PASKUQAN , KAMËZ , BATHORE".

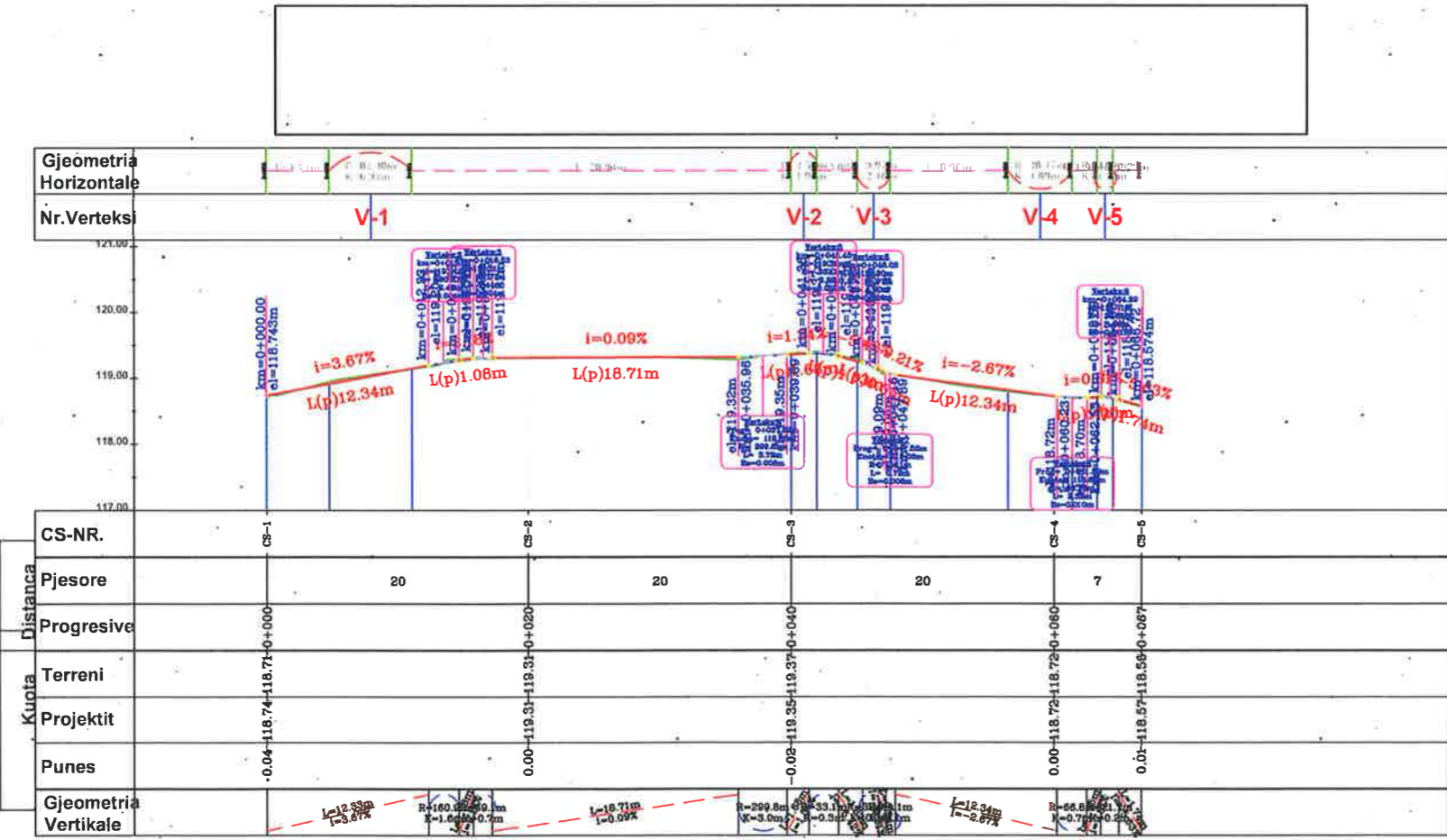
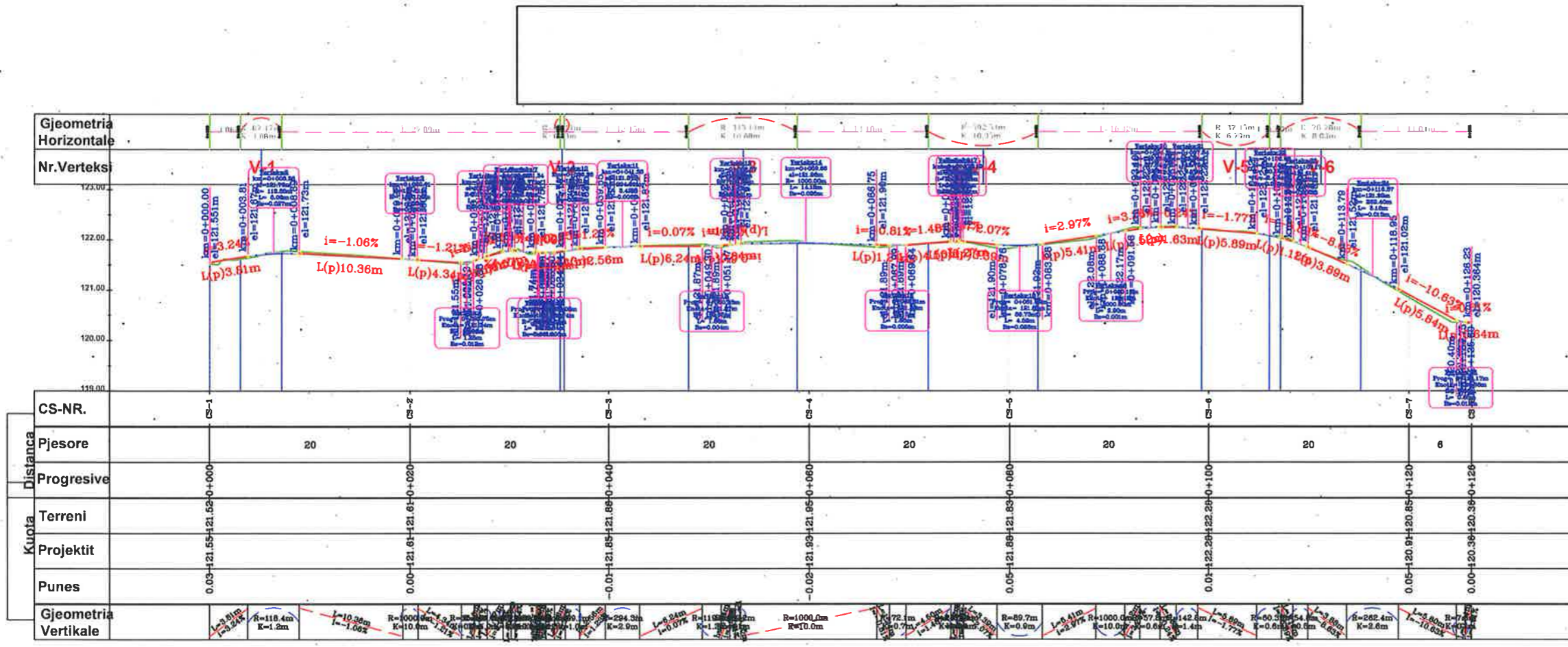
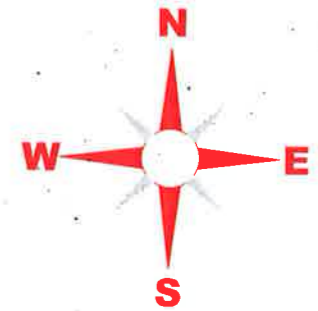

LEGJENDA

- NIVELETA E RRUGES
- TERRENI NATYRAL



BASHKIA KAMEZ

DREJTORIA E PROJEKTEVE DHE INVESTIMEVE
DEPARTAMENTI I PROJEKTEVE

Dr. e Projekteve e Investimeve	RAMADAN HYSA	<i>[Signature]</i>
Pergj. Sektori i Projekteve	DENIS PRENÇI	<i>[Signature]</i>
STAFI TEKNIK PROJEKTES	Ing. EMANUELA MËZIU	<i>[Signature]</i>
	Ing. ARTUR ÇAJKA	<i>[Signature]</i>
	Ing. ALEKS DANI	<i>[Signature]</i>
	Ing. ARJOLA KURTI	<i>[Signature]</i>

Titulli i Projektit		Faza e Projektit
NDËRTIM RRUGËT BLOKUT "PASKUQAN , KAMËZ , BATHORE".		PROJEKT ZBATIMI
Emertimi i Fletës		Shkalla e Vizatimit
PROFLET GJATESORE		H 1:500 V 1:150
		Fleta Nr.
		07

PROFILIET GJATËSORE TË RRUGËVE BLOKUT "PASKUQAN , KAMËZ , BATHORE".

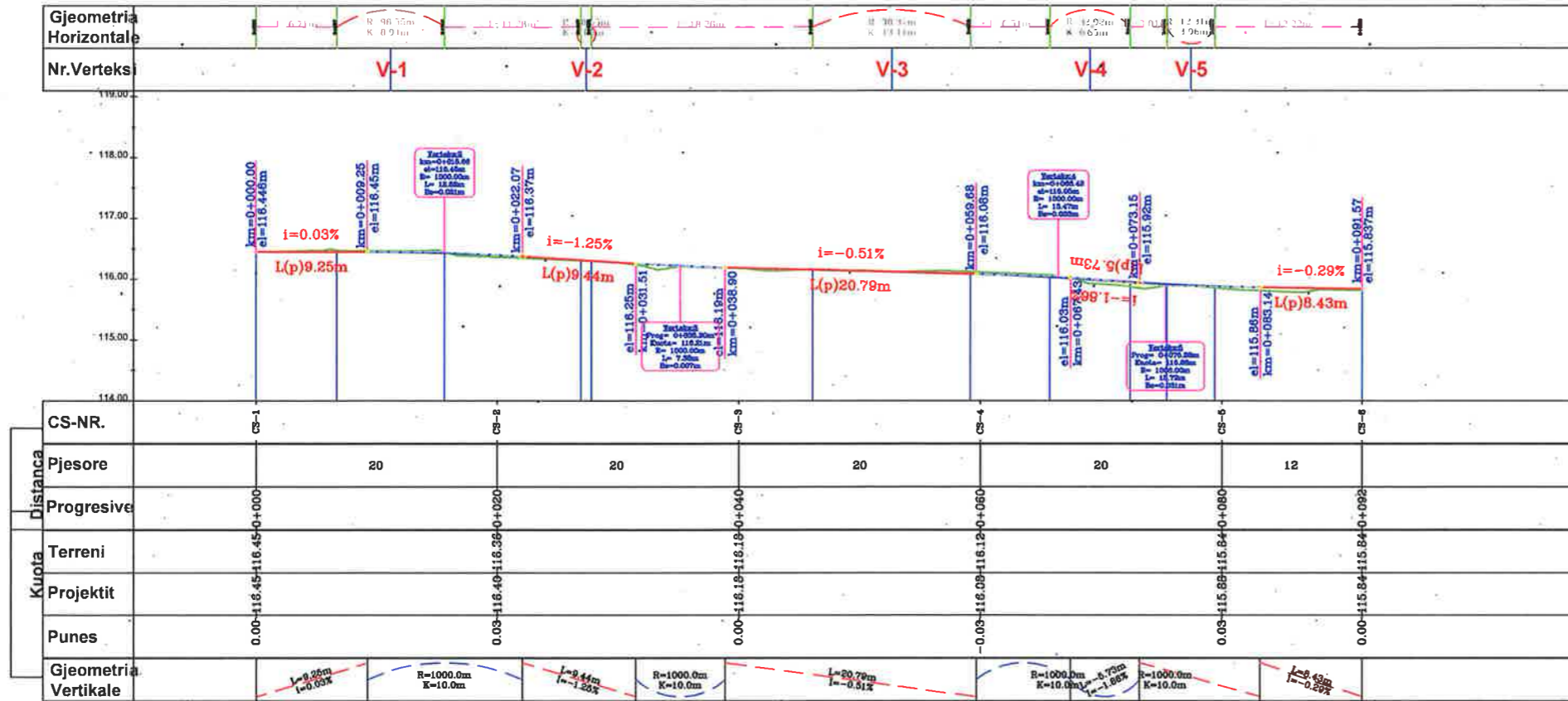
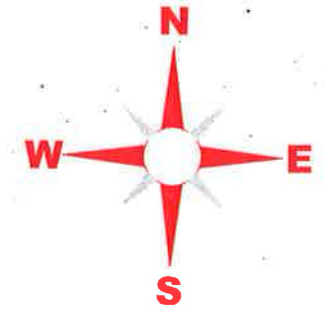

LEGJENDA

NIVELETA E RRUGES
 TERRENI NATYRAL

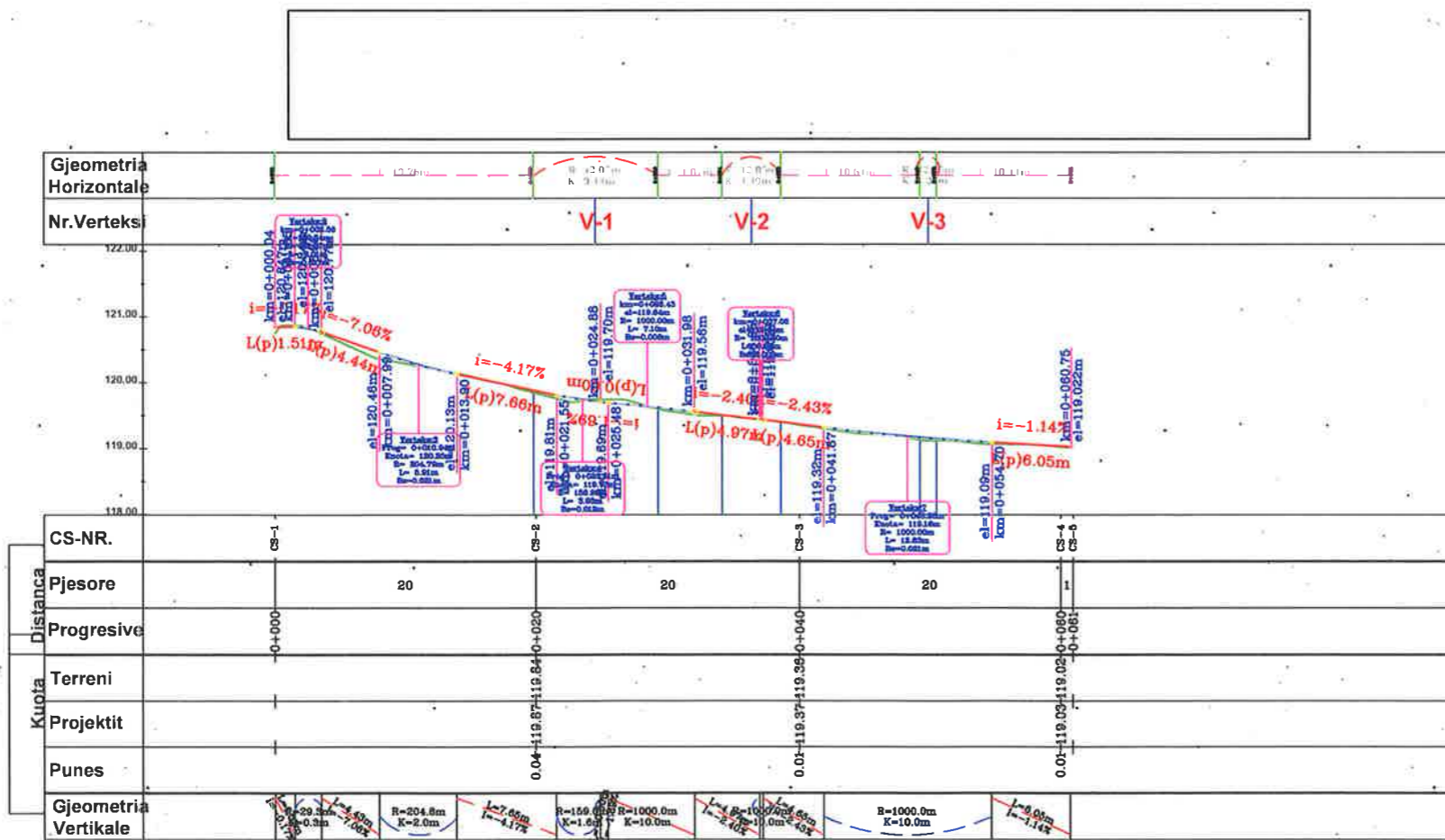

BASHKIA KAMEZ

DREJTORIA E PROJEKTEVE DHE INVESTIMEVE
DEPARTAMENTI I PROJEKTEVE

Dr. e Projekteve e Investimeve	RAMADAN HYSA	
Pergi. Sektori i Projekteve	DENIS PRËNÇI	
STAFI TEKNIK PROJEKTES	Ing. EMANUELA MËZIU	
	Ing. ARTUR ÇAJKA	
	Ing. ALEKS DANI	
	Ing. ARJOLA KURTI	

Titulli i Projektit
NDËRTIM RRUGËT BLOKU "PASKUQAN , KAMËZ , BATHORE".

Faza e Projektit
PROJEKT ZBATIMI

Data e Implementimit : _____

Shkalla e Vizatimit
H 1:500 V 1:150

Emertimi i Fletes
PROFILIET GJATESORE

Fleta Nr.
08

PROFLET GJATËSORE TË RRUGËVE BLOKUT "PASKUQAN , KAMËZ , BATHORE".

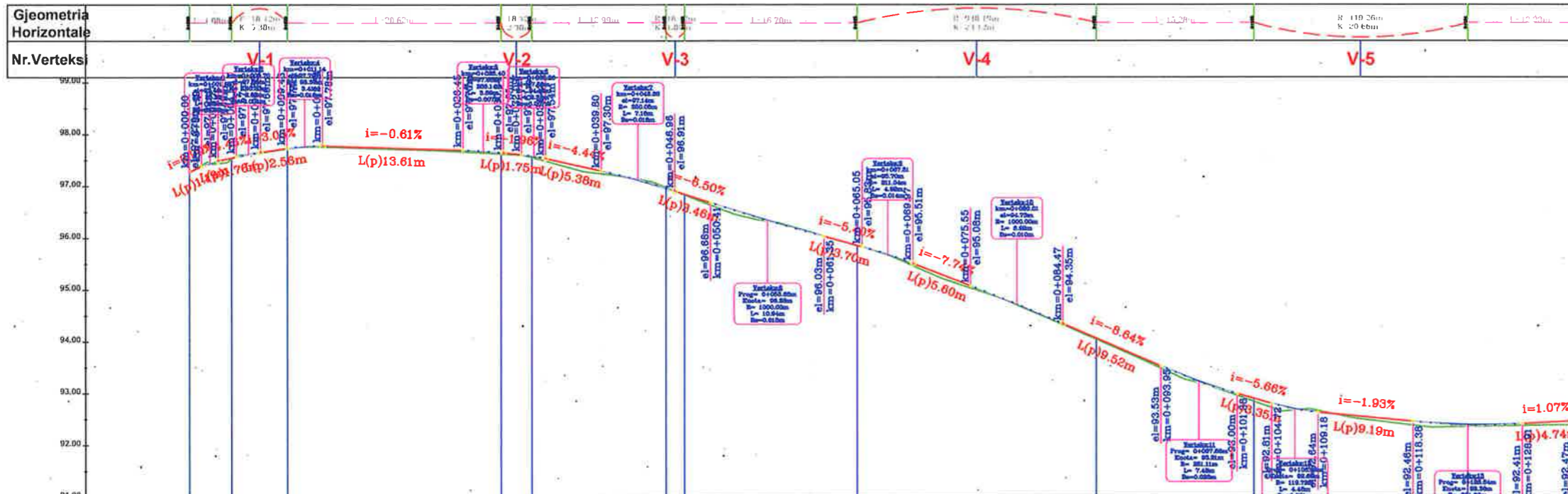
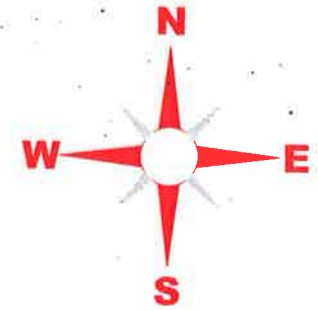

LEGJENDA

- NIVELETA E RRUGES
- TERRENI NATYRAL



BASHKIA KAMEZ

DREJTORIA E PROJEKTEVE DHE INVESTIMEVE
DEPARTAMENTI I PROJEKTEVE

Dr. e Projekteve e Investimeve	RAMADAN HYSA
Pergj. Sektori i Projekteve	DENIS PRENÇI
STAFI TEKNIK PROJEKTES	Ing. EMANUELA MËZIU Ing. ARTUR ÇAJKA Ing. ALEKS DANI Ing. ARJOLA KURTI

Titulli i Projektit	NDËRTIM RRUGËT BLOKUT "PASKUQAN , KAMËZ , BATHORE".
Faza e Projektit	PROJEKT ZBATIMI
Data e Implementimit	
Shkalla e Vizatimit	H 1:500 V 1:150
Emertimi i Flotes	PROFLET GJATESORE
Flota Nr.	09

PROFLET GJATËSORE TË RRUGËVE BLOKUT "PASKUQAN , KAMËZ , BATHORE".

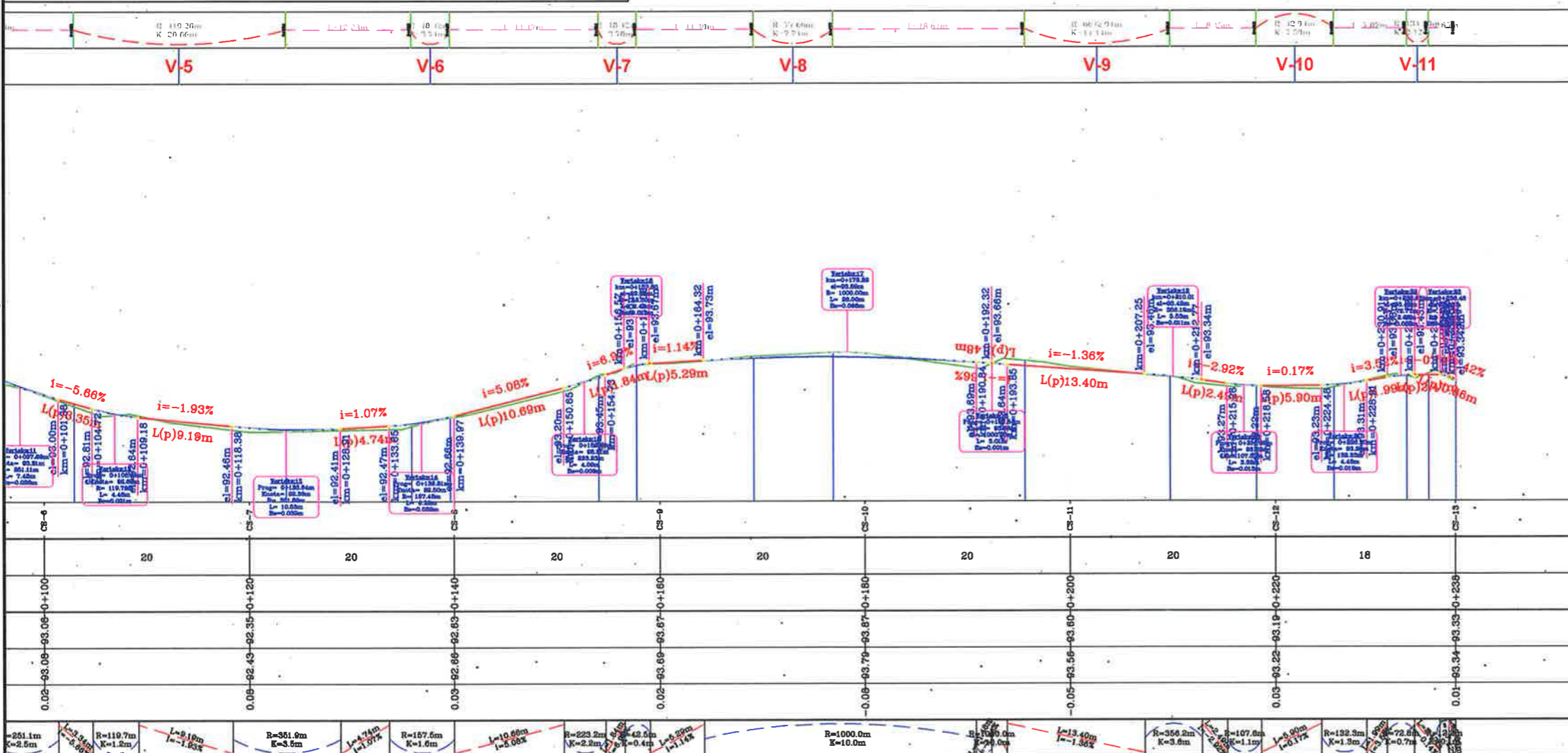
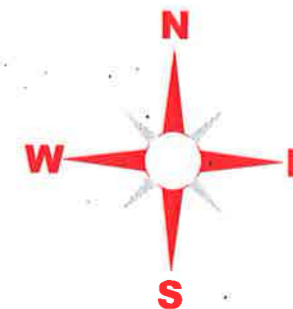

LEGJENDA

- NIVELETA E RRUGES
- TERRENI NATYRAL

BASHKIA KAMEZ
 DREJTORIA E PROJEKTEVE DHE INVESTIMEVE
 DEPARTAMENTI I PROJEKTEVE

Dr. e Projekteve e Investimeve	RAMADAN HYSA
Pergj. Sektori i Projekteve	DENIS PRENÇI
STAFI TEKNIK	Ing. EMANUELA MËZIU
PROJEKTES	Ing. ARTUR ÇAJKA
	Ing. ALEKS DANI
	Ing. ARJOLA KURTI

Titulli i Projektit	Faza e Projektit
NDËRTIM RRUGËT BLOKÛ "PASKUQAN , KAMËZ , BATHORE".	PROJEKT ZBATIMI
Emertimi i Fletes	Data e Implementimit :
PROFLET GJATËSORE	Shkalla e Vizatimit H 1:500 V 1:150
	Fleta Nr. 10

PROFLET GJATËSORE TË RRUGËVE BLOKUT "PASKUQAN , KAMËZ , BATHORE".

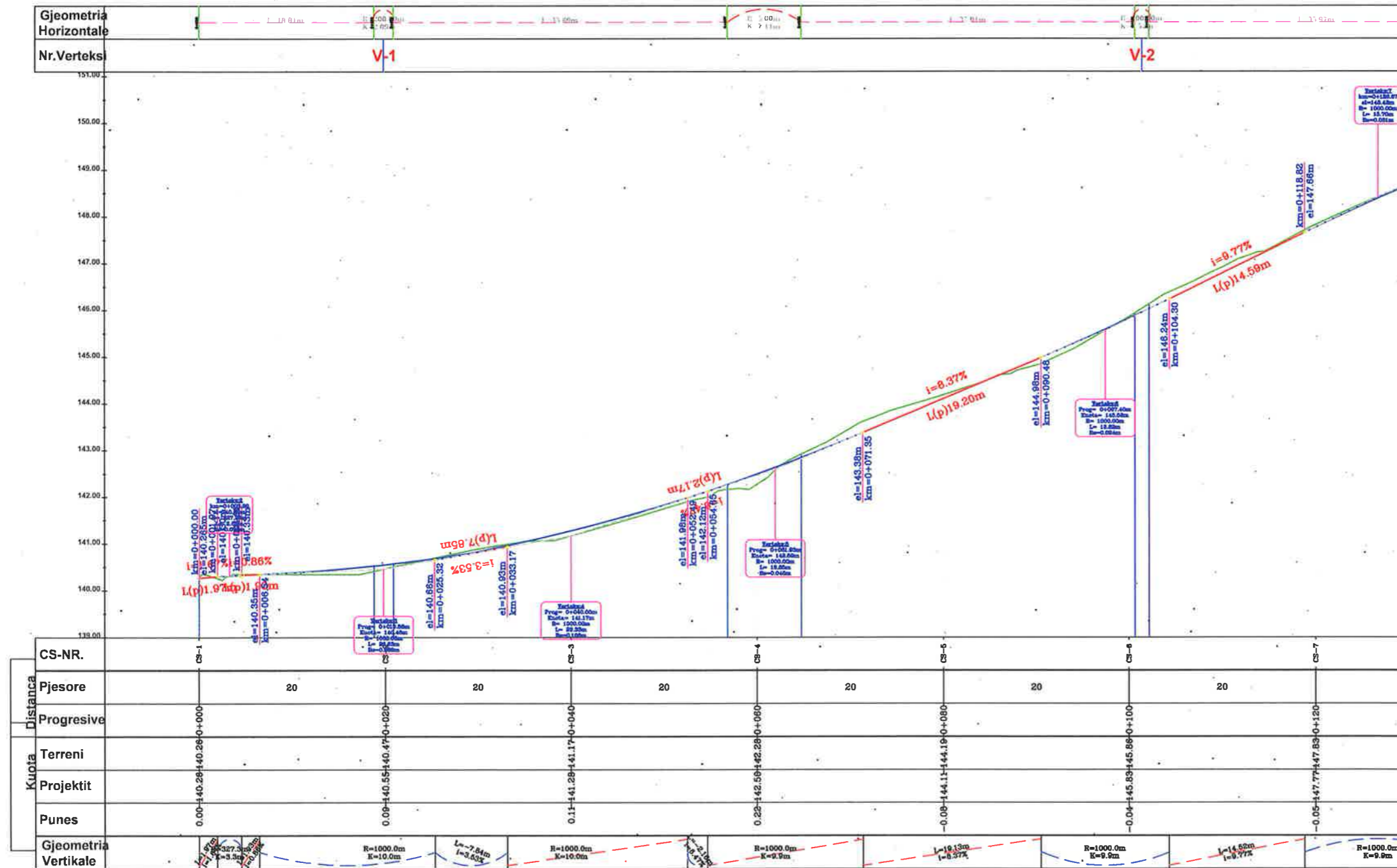
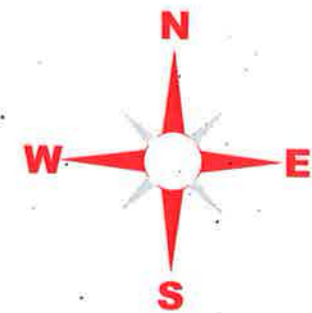

Gjeometria Horizontale
Nr. Verteks
CS-NR.
Distanca
Pjesore
Progresive
Kuota
Terreni
Projektit
Punes
Gjeometria Vertikale

LEGJENDA

- NIVELETA E RRUGES
- TERRENI NATYRAL

BASHKIA KAMEZ
DREJTORIA E PROJEKTEVE DHE INVESTIMEVE
DEPARTAMENTI I PROJEKTEVE

Dr. e Projekteve e Investimeve	RAMADAN HYSA	
Pergj. Sektori i Projekteve	DENIS PRENÇI	
STAFI TEKNIK PROJEKTES	Ing. EMANUELA MËZIU	
	Ing. ARTUR ÇAJKA	
	Ing. ALEKS DANI	
	Ing. ARJOLA KURTI	

Titulli i Projektit	NDËRTIM RRUGËT BLOKUT "PASKUQAN , KAMËZ , BATHORE".	Faza e Projektit	PROJEKT ZBATIMI
Emertimi i Fletes	PROFLET GJATESORE	Data e Implementimit	
		Shkalla e Vizatimit	H 1:500 V 1:150
		Fleta Nr.	11

PROFLET GJATËSORE TË RRUGËVE BLOKUT "PASKUQAN , KAMËZ , BATHORE".

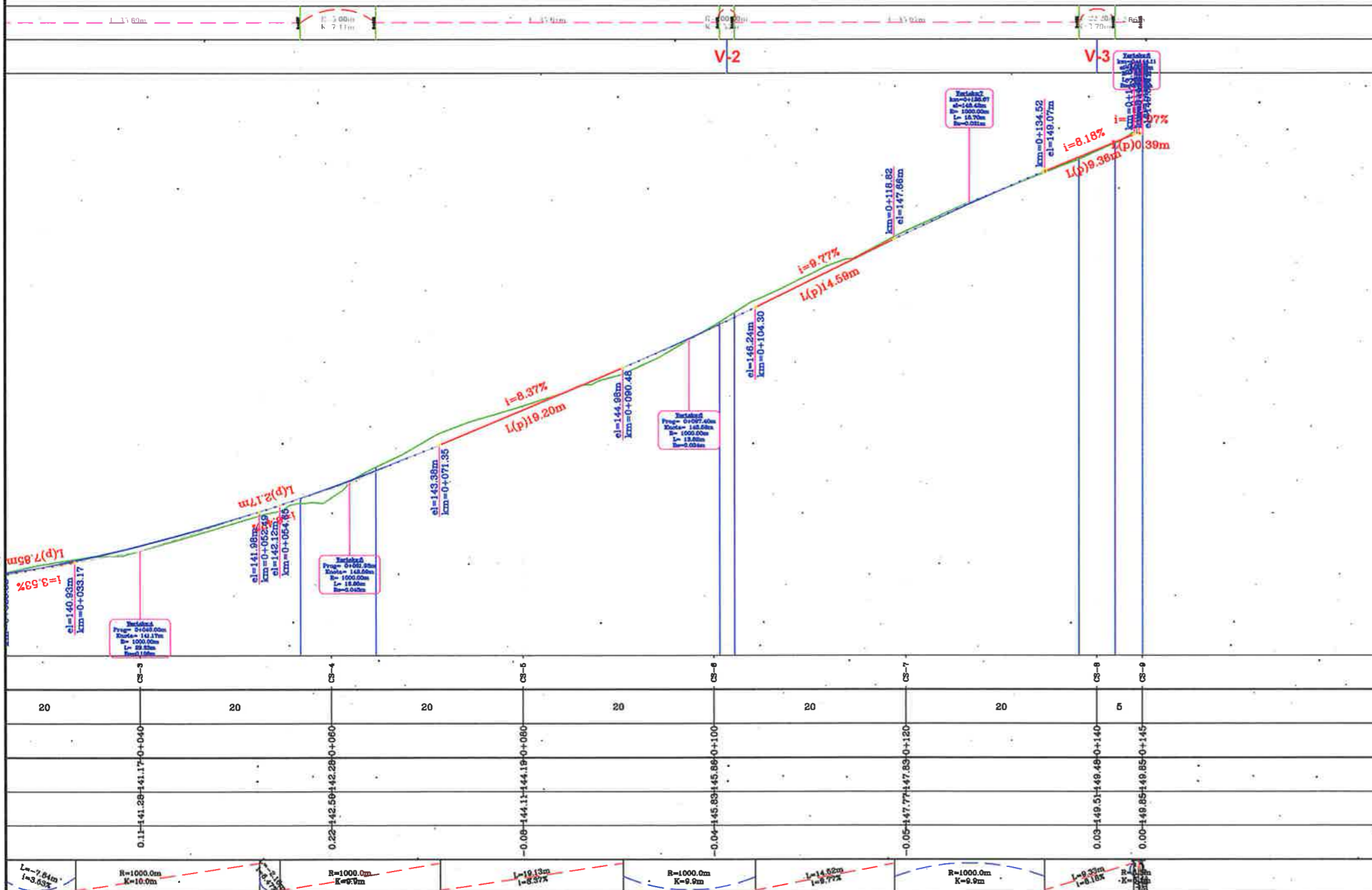
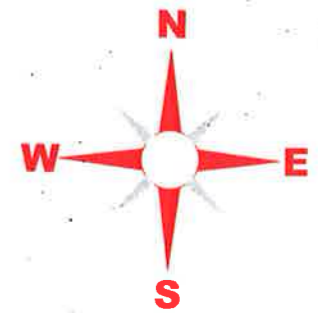

LEGJENDA

- NIVELETA E RRUGES
- TERRËNI NATYRAL



BASHKIA KAMEZ

DREJTORIA E PROJEKTEVE DHE INVESTIMEVE
DEPARTAMENTI I PROJEKTEVE

Dr. e Projekteve e Investimeve	RAMADAN HYSA
Pergj. Sektori i Projekteve	DENIS PRENCI
STAFI TEKNIKUS PROJEKTES	Ing. EMANUELA MËZIU Ing. ARTUR ÇAJKA Ing. ALEKS DANI Ing. ARJOLA KURTI

Titulli i Projektit	Faza e Projektit
NDËRTIM RRUGËT BLOKUT "PASKUQAN , KAMËZ , BATHORE".	PROJEKT ZBATIMI
Emergjimi i Fletes	Data e Implementimit:
PROFLET GJATESORE	Shkalla e Vizatimit H 1:500 V 1:150
	Flota Nr.
	12

PROFILI GJATËSORE TË RRUGËVE BLOKUT "PASKUQAN , KAMËZ , BATHORE".

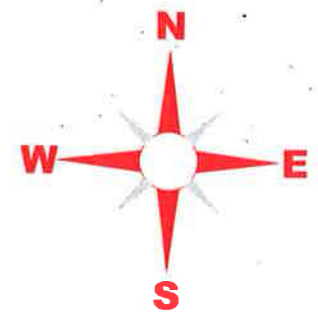
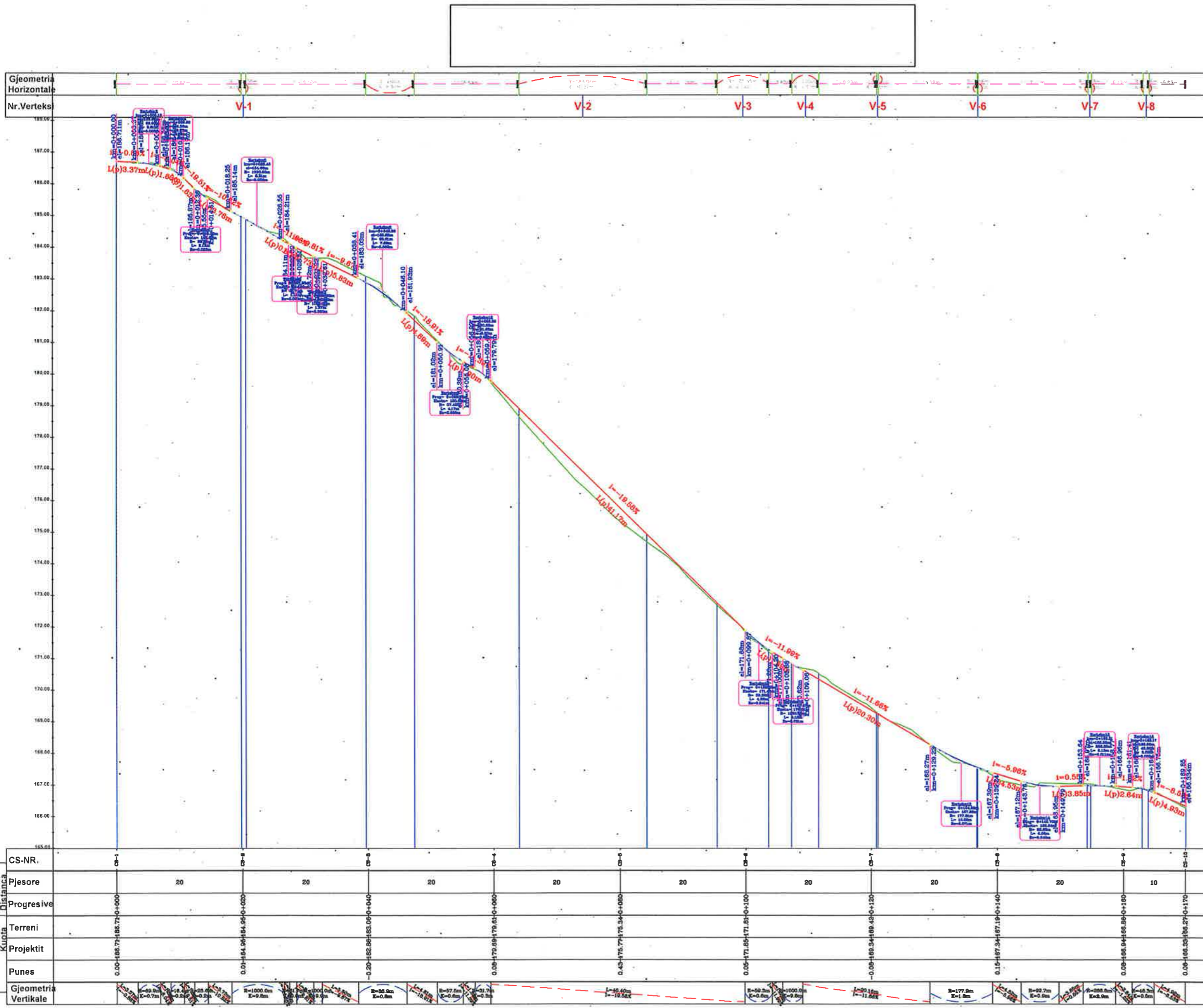

LEGJENDA

- NIVELETA E RRUGES
- TERRENI NATYRAL



BASHKIA KAMEZ

DREJTORIA E PROJEKTEVE DHE INVESTIMEVE
DEPARTAMENTI I PROJEKTEVE

Dr. e Projekteve e Investimeve	RAMADAN HYSA	
Pergj. Sektori i Projekteve	DENIS PRINÇI	
STAFI TEKNIK PROJEKTES	Ing. EMANUELA MËZIU Ing. ARTUR ÇAJKA Ing. ALEKS DANI Ing. ARJOLA KURTI	

CS-NR.	05-1	05-2	05-3	05-4	05-5	05-6	05-7	05-8	05-9	05-10	05-11	05-12	05-13	05-14	05-15	
Pjesore	20	20	20	20	20	20	20	20	20	20	20	20	10			
Progresive	0.00+188.71-186.71+0+000	0.01+184.26-184.99+0+000	-0.20+182.98-182.09+0+040		0.08+179.89+179.61+0+060		0.43+175.77+175.34+0+080		0.06+171.85+171.61+0+100		-0.08+169.34+169.49+0+120		0.15+167.34+167.19+0+140		0.09+165.04+166.89+0+160	0.09+165.33+166.27+0+170
Terreni																
Projektit																
Punes																
Gjeometria Vertikale																

Titulli i Projektit	NDËRTIM RRUGËT BLOKUT "PASKUQAN , KAMËZ , BATHORE".	Faza e Projektit	PROJEKT ZBATIMI
Emertimi i Fletes	PROFILI GJATESORE	Data e implementimit :	
		Shkalla e Vizatimit	H 1:600 V 1:150
		Fleta Nr.	13

PROFLET GJATËSORE TË RRUGËVE BLOKUT "PASKUQAN , KAMËZ , BATHORE".

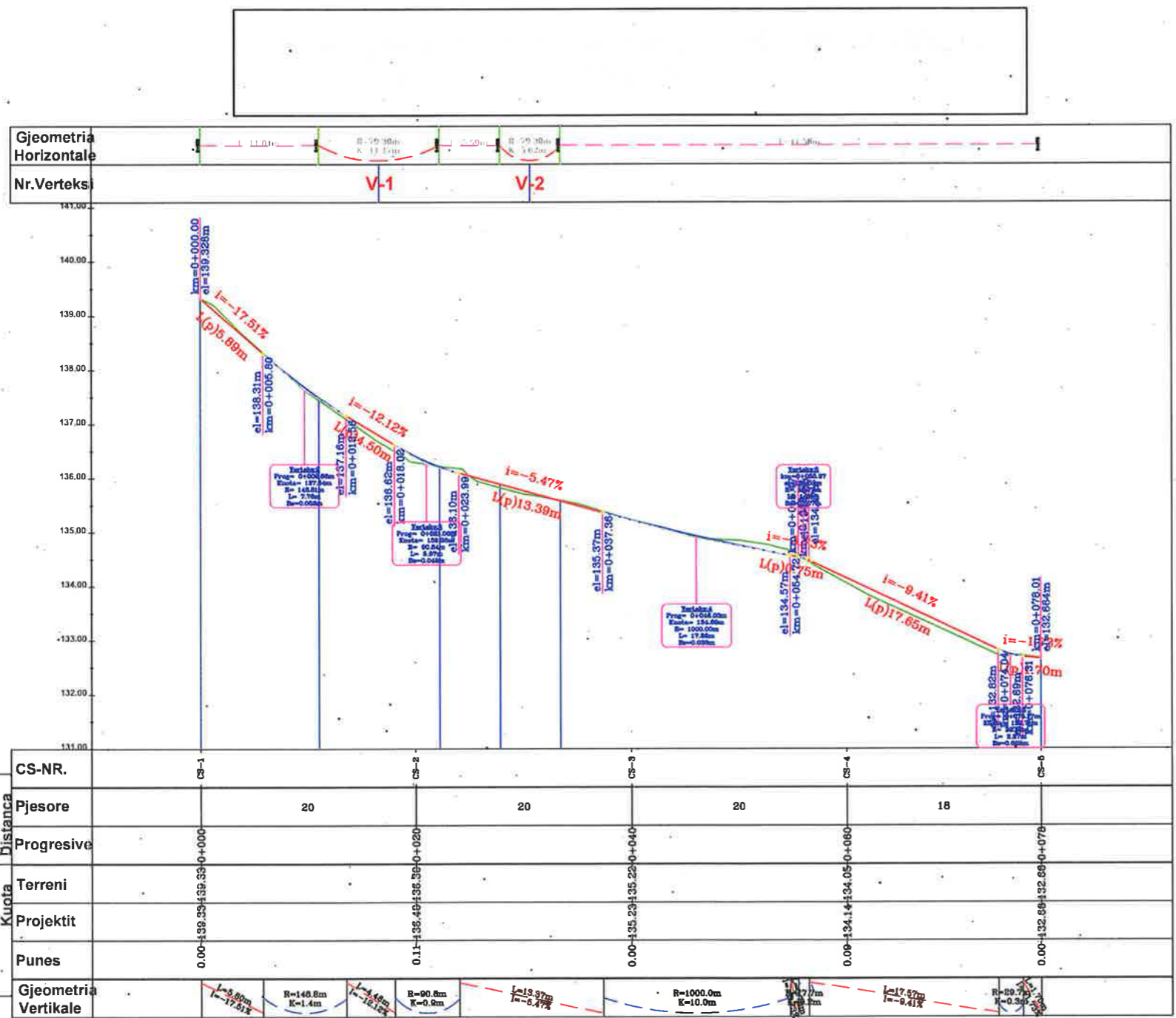
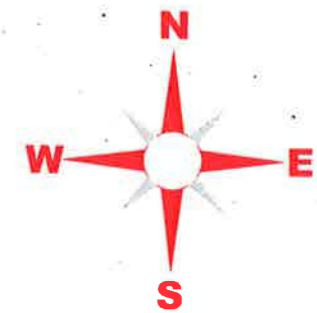

Gjeometria Horizontale	[Diagram showing horizontal alignment with curve lengths: 11.0m, 11.14m, 11.50m, 11.25m, 11.38m]					
Nr.Verteks	V-1		V-2			

CS-NR.	CS-1	CS-2	CS-3	CS-4	CS-6
Distanca Pjesore	20	20	20	18	
Progresive	0.00+139.29+139.39+0+000	0.11+136.49+136.39+0+020	0.00+135.23+135.22+0+040	0.09+134.14+134.05+0+060	0.00+132.66+132.69+0+076
Kuota Terreni					
Projektit					
Punes					
Gjeometria Vertikale	$i = -17.51\%$ $R = 140.8m$ $K = 1.4m$	$i = -12.12\%$ $R = 90.8m$ $K = 0.9m$	$i = -5.47\%$ $R = 1000.0m$ $K = 10.0m$	$i = -9.41\%$ $R = 59.7m$ $K = 0.36m$	

LEGJENDA

- NIVELETA E RRUGES
- TERRENI NATYRAL

BASHKIA KAMEZ
DREJTORIA E PROJEKTEVE DHE INVESTIMEVE
DEPARTAMENTI I PROJEKTEVE

Dr. e Projekteve e Investimeve	RAMADAN.HYSA
Pergj. Sektori i Projekteve	DENIS PRENÇI
STAFI TEKNIK PROJEKTES	Ing. EMANUELA MËZIU Ing. ARTUR ÇAJKA Ing. ALEKS DANI Ing. ARJOLA KURTI

Titulli i Projektit	NDËRTIM RRUGËT BLOKUT "PASKUQAN , KAMËZ , BATHORE".
Faza e Projektit	PROJEKT ZBATIMI
Data e Implementimit:	
Shkalla e Vizatimit	H 1:500 V 1:150
Emertimi i Fletes	PROFLET GJATESORE
Fleta Nr.	14

OBJEKTI:
NDËRTIM RRUGËT "BLLOKU PASKUQAN , KAMËZ , BATHORE "
BASHKIA KAMËZ

08.PROFILET TËRTHORE TË RRUGËVE

		BASHKIA KAMËZ	
DREJTORIA E PROJEKTEVE DHE INVESTIMEVE DEPARTAMENTI I PROJEKTEVE			
Dr. e Projekteve e Investimeve		RAMADAN HYSA	
Përgj. e Sekt. të Projekteve		DENIS PRENÇI	
STAFI TEKNIK PROJEKTES	Ing.	EMANUELA MËZIU	
	Ing.	ARTUR ÇAJKA	
	Ing.	ALEKS DANI	
	Ing.	ARJOLA KURTI	
Titulli i Projektit		Faza e Projektit	
NDËRTIM RRUGËT "BLLOKU PASKUQAN , KAMËZ , BATHORE "		PROJEKT ZBATIMI	
Emerenti i Fletes		Data e Implementimit :	
KAPAK		Shkalla e Vizimit	
		Fleta Nr.	
		00	

PROFILE TËRTHORE RRUGA SEG PING AZEM HAJDARI

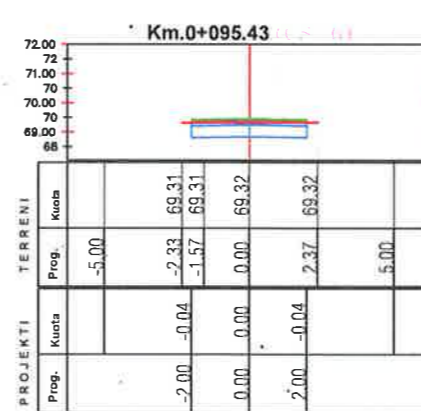
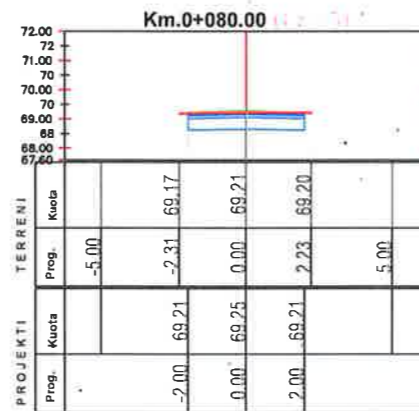
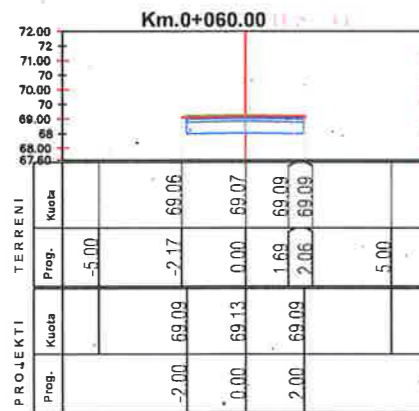
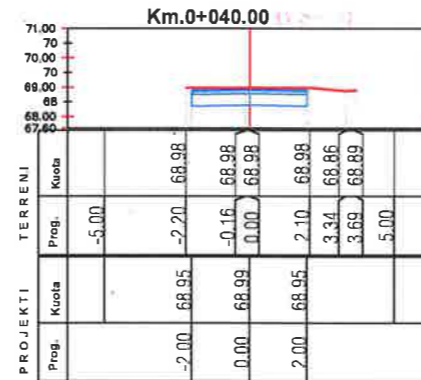
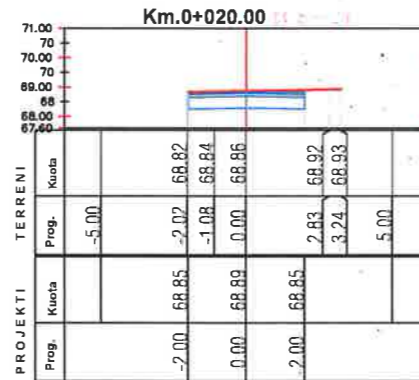
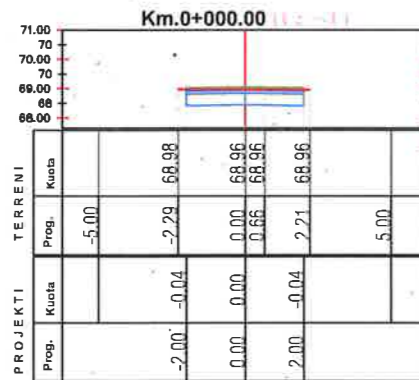
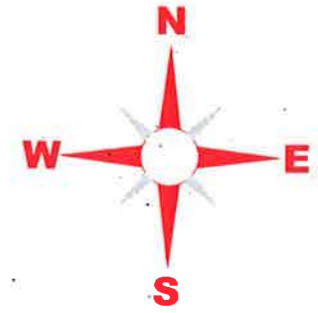

LEGJENDA

- NIVELETA E RRUGES
- TERRENI NATYRAL



BASHKIA KAMEZ

DREJTORIA E PROJEKTEVE DHE INVESTIMEVE
DEPARTAMENTI I PROJEKTEVE

Dr. e Projekteve e Investimeve	RAMADAN HYSA	
Pergj. Sektori i Projekteve	DENIS PRENCI	
STAFI TEKNIK PROJEKTES	Ing. EMANUELA MËZIU	
	Ing. ARTUR ÇAJKA	
	Ing. ALEKS DANI	
	Ing. ARJOLA KURTI	

Titulli i Projektit	NDËRTIM RRUGËT "BLOKU PASKUQAN , KAMËZ , BATHORE "	Faza e Projektit PROJEKT ZBATIMI
Emertimi i Fietes	PROFILET TËRTHORE	Data e Implementimit:
		Shkalla e Vizatimit H 1:250
		Fleta Nr. 01

PROFILE TËRTHORE RRUGA SEG PING MIQESA

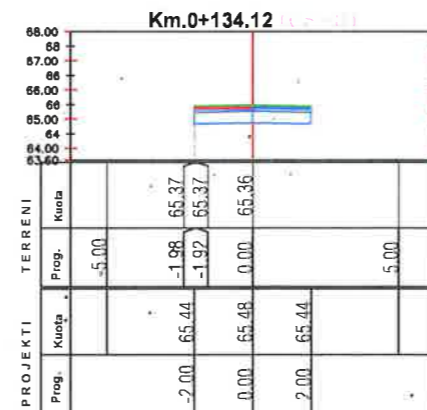
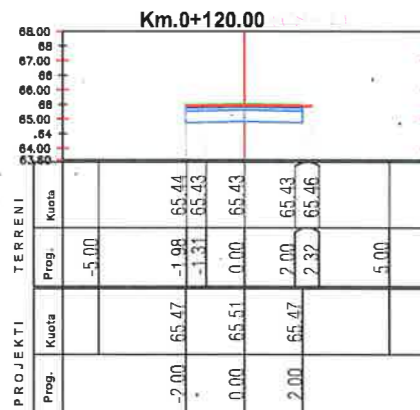
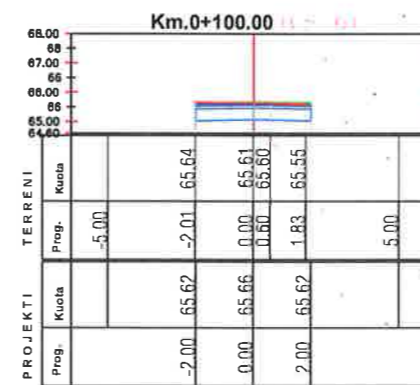
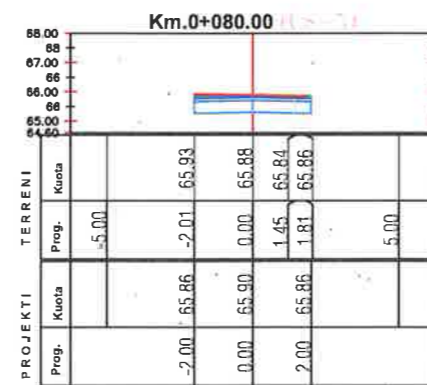
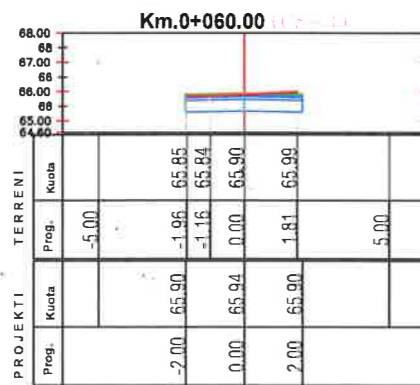
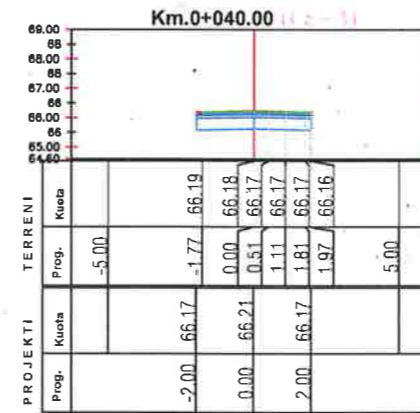
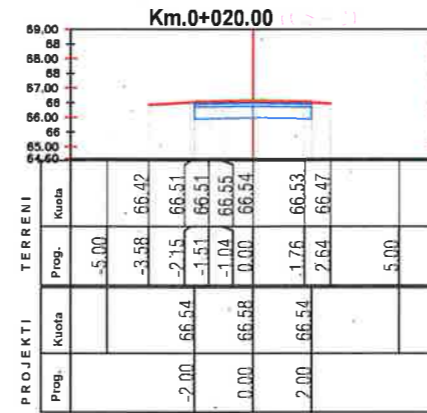
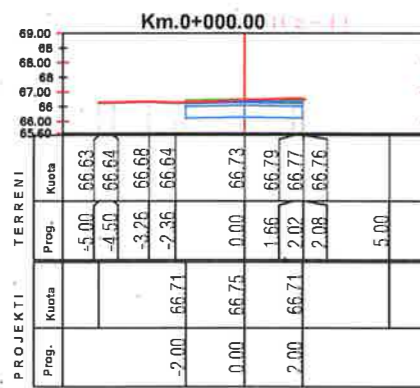
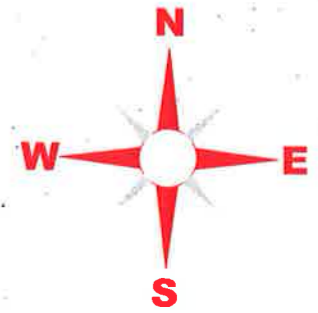

LEGJENDA

- NIVELETA E RRUGES
- TERRENI NATYRAL



BASHKIA KAMEZ

DREJTORIA E PROJEKTEVE DHE INVESTIMEVE
DEPARTAMENTI I PROJEKTEVE

Dr. e Projekteve e Investimeve	RAMADAN HYSA	
Pergj. Sektori i Projekteve	DENIS PRENCI	
STAFI TEKNIK PROJEKTUES	Ing. EMANUELA MËZIU	
	Ing. ARTUR ÇAJKA	
	Ing. ALEKS DANI	
	Ing. ARJOLA KURTI	

Titulli i Projektit
NDËRTIM RRUGËT "BLOKU PASKUQAN
, KAMEZ , BATHORE "

Faza e Projektit
PROJEKT ZBATIMI

Data e Implementimit :

Emertimi i Fietes
PROFLET TËRTHORE

Shkalla e Vizatimit
H 1:250

Fleta Nr.

PROFILE TËRTHORE RRUGA SEG 1 PING FAIK HOXHA

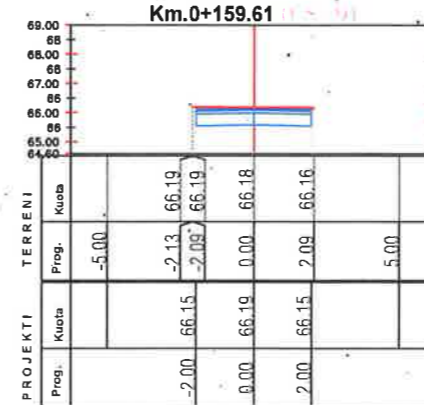
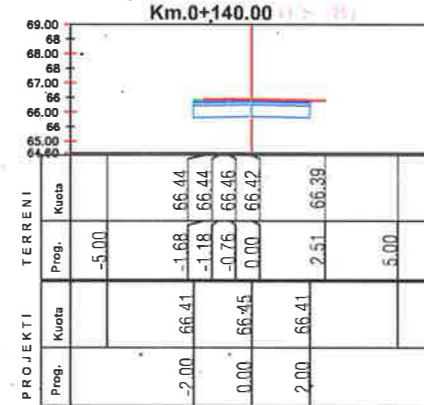
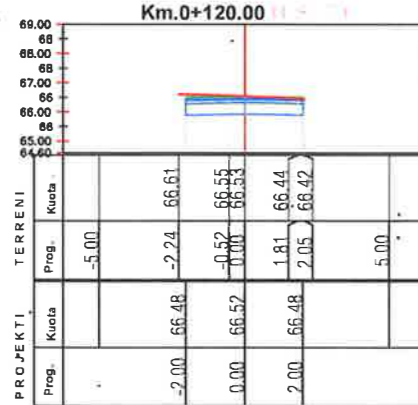
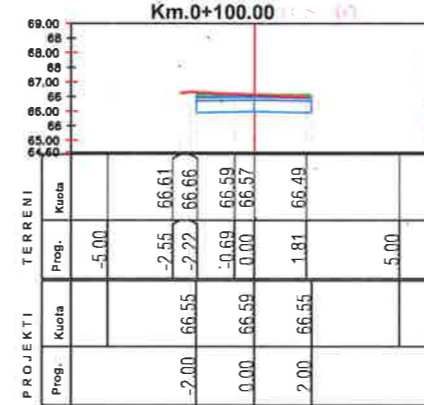
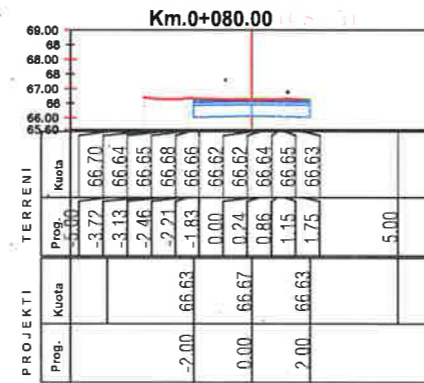
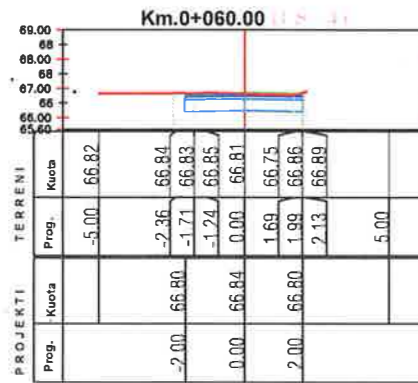
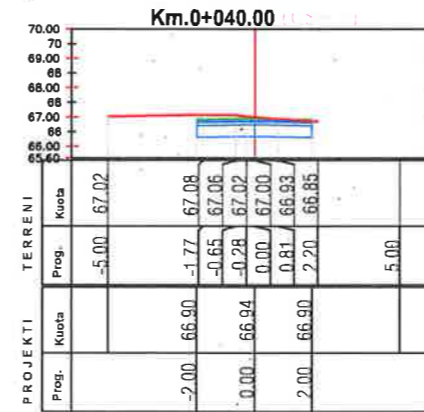
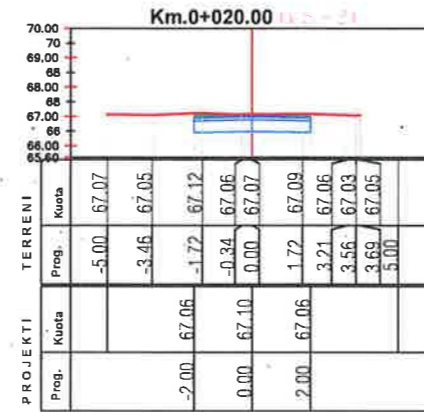
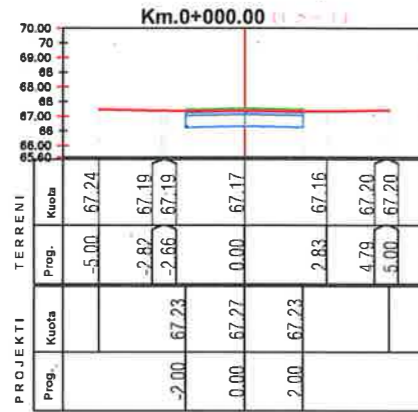
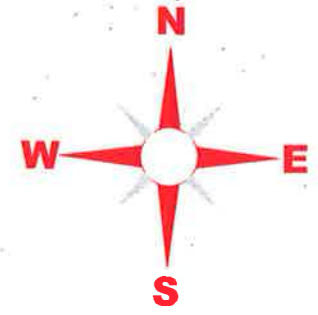

LEGJENDA

- NIVELETA E RRUGES
- TERRENI NATYRAL



BASHKIA KAMEZ

DREJTORIA E PROJEKTEVE DHE INVESTIMEVE
DEPARTAMENTI I PROJEKTEVE

Dr. e Projekteve e Investimeve	RAMADAN HYSA	
Pergj. Sektori i Projekteve	DENIS PRENÇI	
STAFI TEKNIK PROJEKTES	Ing. EMANUELA MËZIU	
	Ing. ARTUR ÇAJKA	
	Ing. ALEKS DANI	
	Ing. ARJOLA KURTI	

Titulli i Projektit	NDËRTIM RRUGËT "BLOKU PASKUQAN , KAMËZ , BATHORE "	Faza e Projektit PROJEKT ZBATIMI
Emertimi i Fletes	PROFILET TËRTHORE	Data e Implementimit:
		Shkalla e Vizatimit H 1:250
		Fleta Nr. 03

PROFILE TËRTHORE RRUGA RREZE DRITE

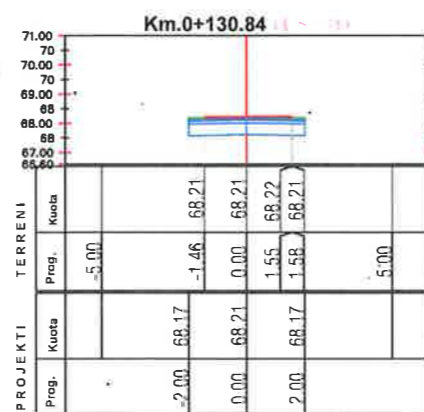
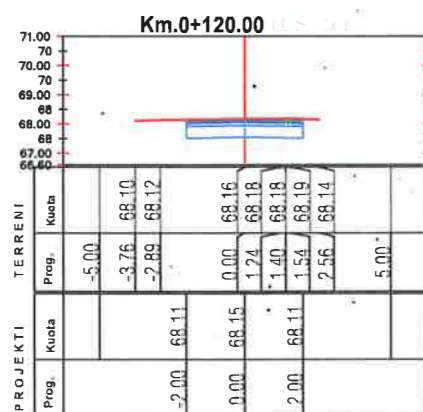
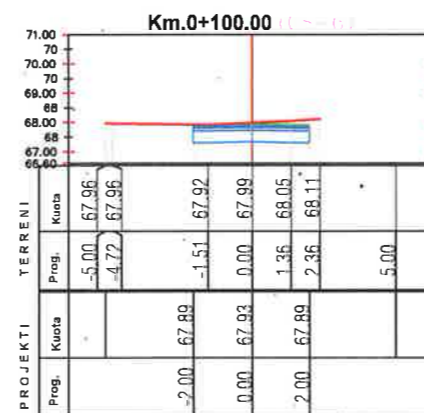
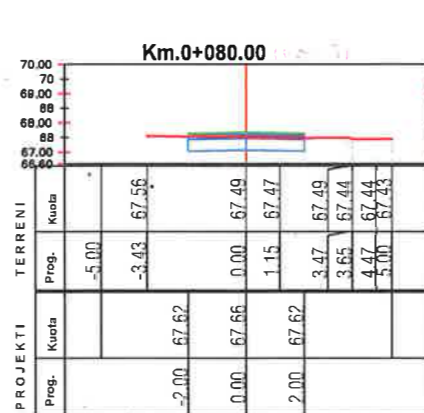
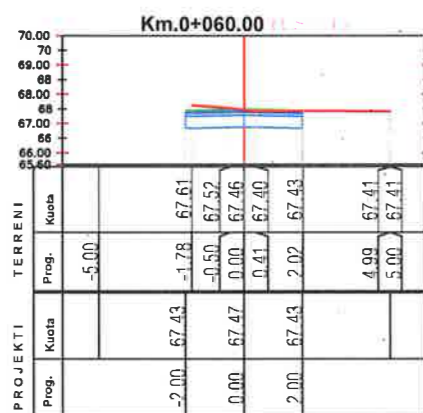
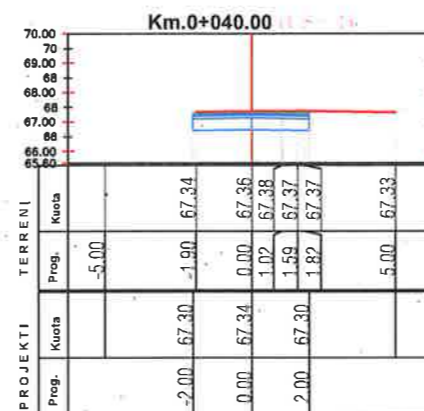
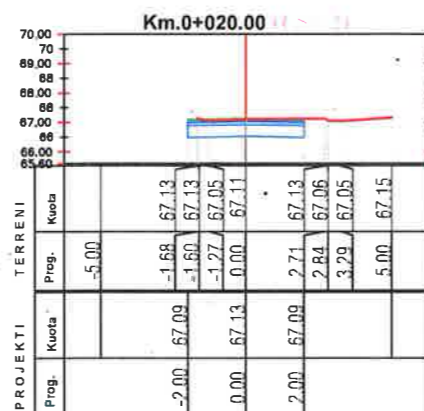
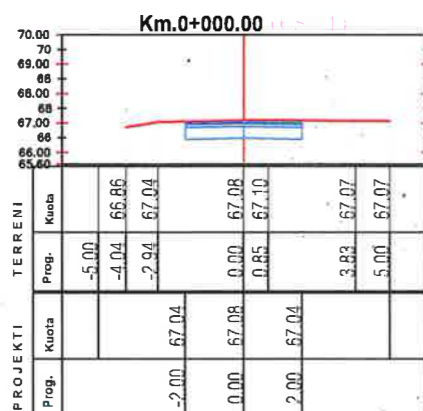
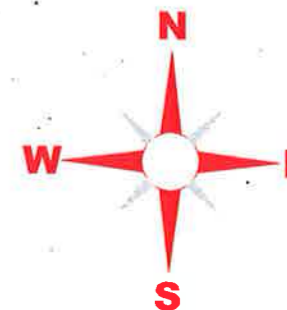

LEGJENDA

- NIVELETA E RRUGES
- TERRENI NATYRAL



BASHKIA KAMEZ

DREJTORIA E PROJEKTEVE DHE INVESTIMEVE
DEPARTAMENTI I PROJEKTEVE

Dr. e Projekteve e Investimeve	RAMADAN HYSA	
Pergj. Sektorit i Projekteve	DENIS PRENCI	
STAFI TEKNIK PROJEKTES	Ing. EMANUELA MËZIU	
	Ing. ARTUR ÇAJKA	
	Ing. ALEKS DANI	
	Ing. ARJOLA KURTI	

Titulli i Projektit
NDËRTIM RRUGËT "BLOKU PASKUQAN
, KAMËZ , BATHORE "

Faza e Projektit
PROJEKT ZBATIMI

Emertimi i Fletes
PROFILET TËRTHORE

Data e Implementimit:

Shkalla e Vizatimit
H 1:250

Fleta Nr.

PROFILE TËRTHORE RRUGA SEG 2 PING FAIK HOXHA

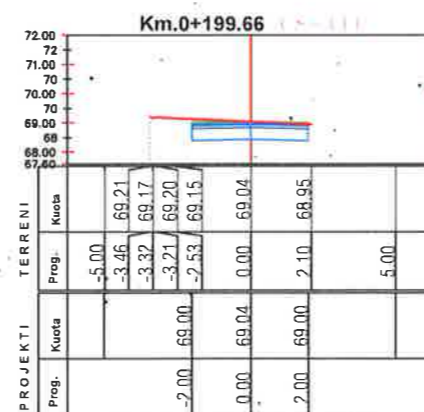
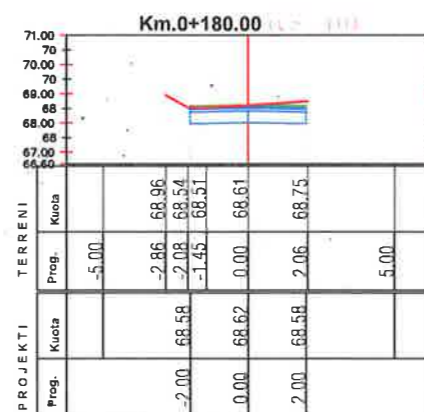
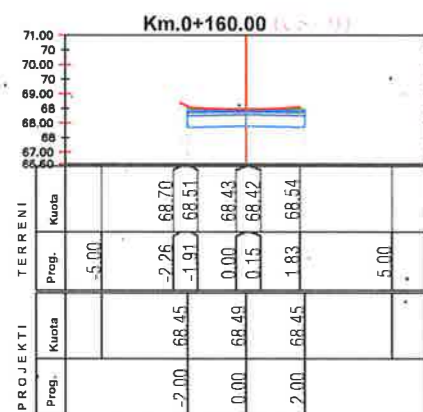
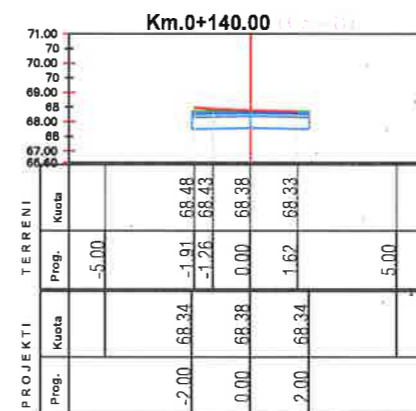
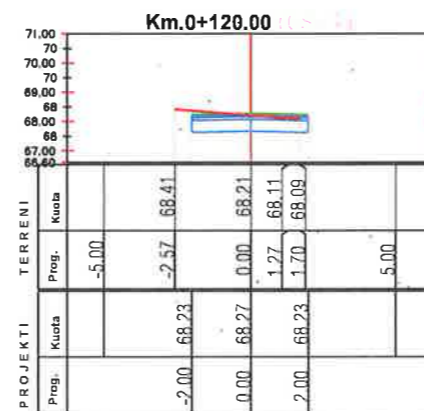
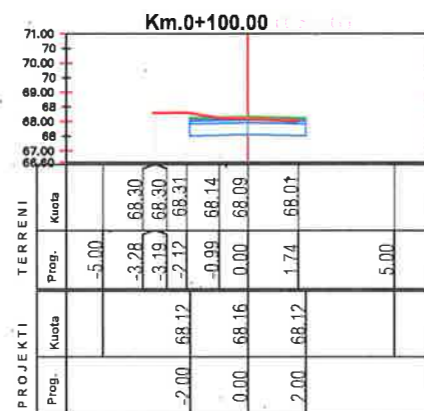
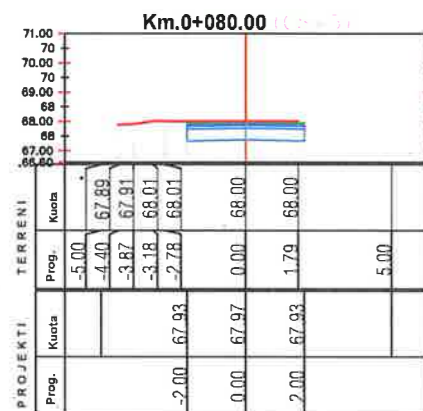
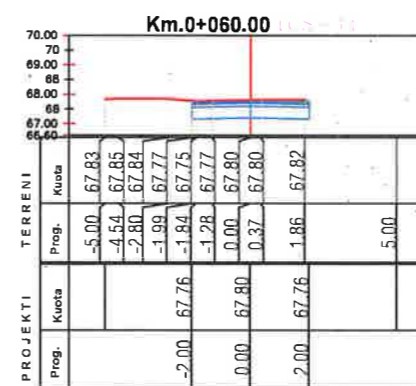
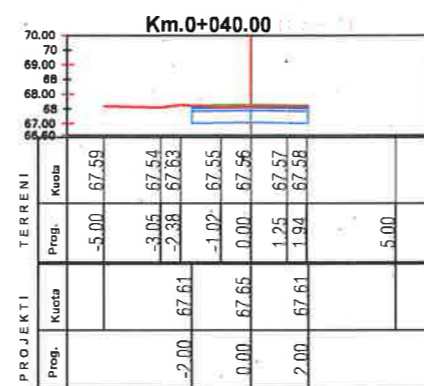
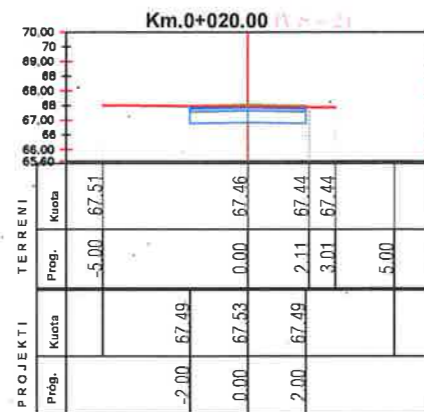
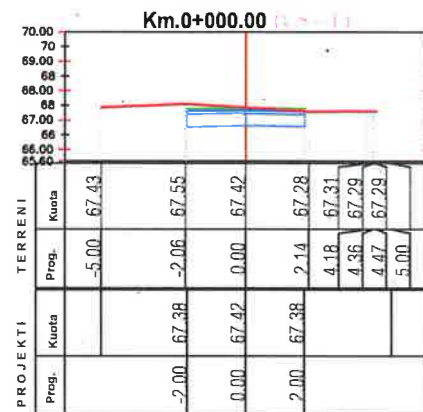
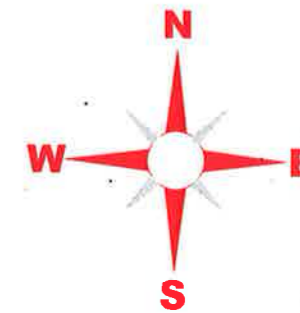

LEGJENDA

- NIVELETA E RRUGES
- TERRENI NATYRAL

BASHKIA KAMEZ
 DREJTORIA E PROJEKTEVE DHE INVESTIMEVE
 DEPARTAMENTI I PROJEKTEVE

Dr. e Projekteve e Investimeve	RAMADAN HYSA
Pergj. Sektori i Projekteve	DENIS PRENÇI
STAFI TEKNIK PROJEKTES	Ing. EMANUELA MËZIU
	Ing. ARTUR ÇAJKA
	Ing. ALEKS DANI
	Ing. ARJOLA KURTI

Titulli i Projektit	NDËRTIM RRUGËT "BLOKU PAŠKUGAN , KAMEZ , BATHORE "
Faza e Projektit	PROJEKT ZBATIMI
Emerlimi i Fletes	PROFLET TËRTHORE
Data e Implementimit	
Shkalla e Vizatimit	H 1:250
Fleta Nr.	05

PROFILE TËRTHORE RRUGA SEG 2 PING FAIK HOXHA

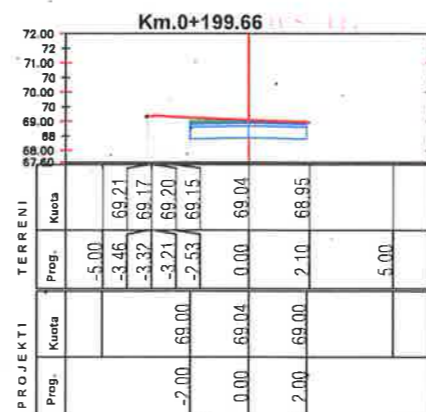
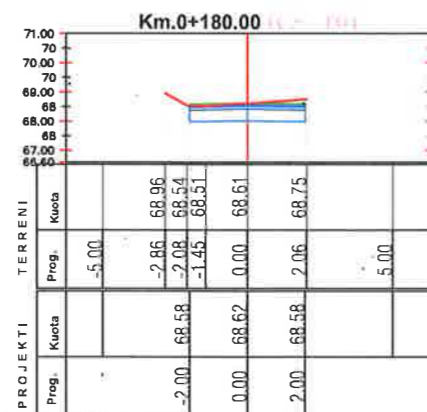
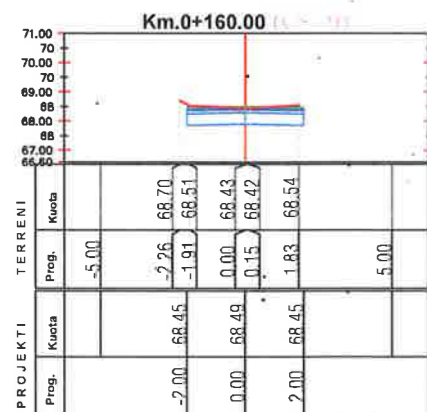
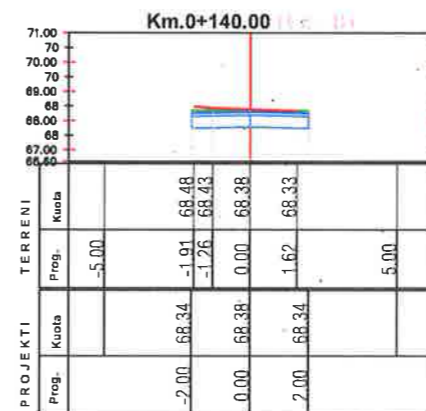
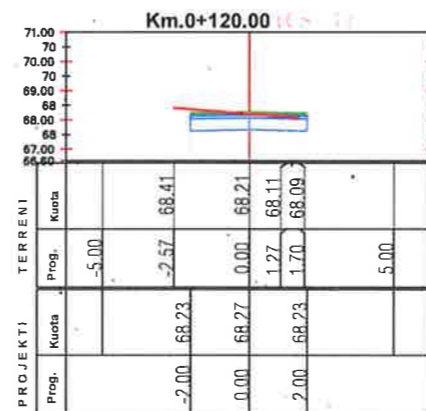
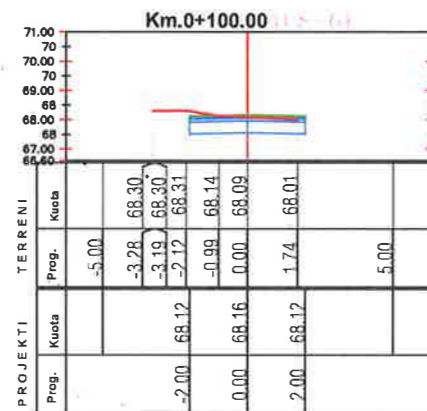
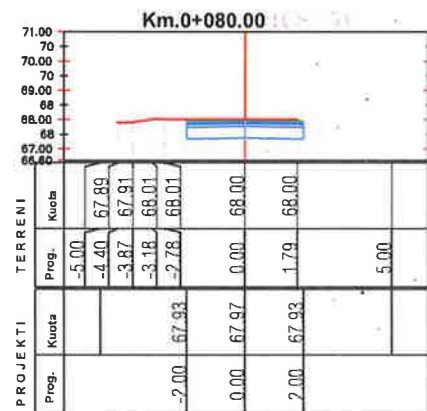
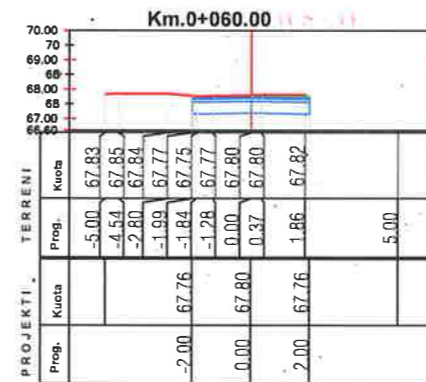
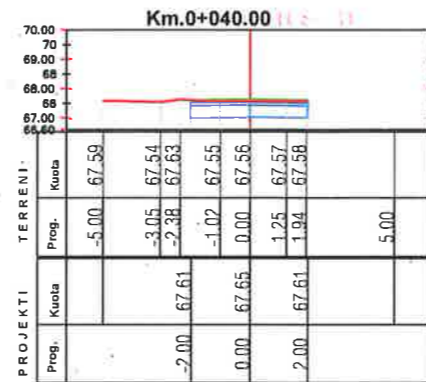
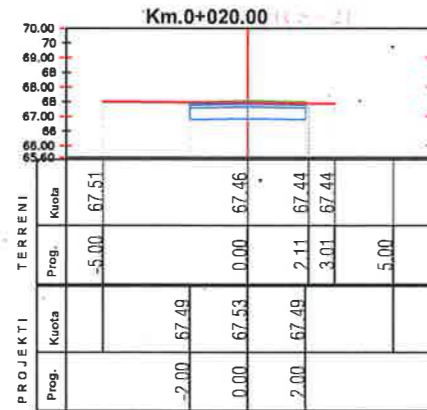
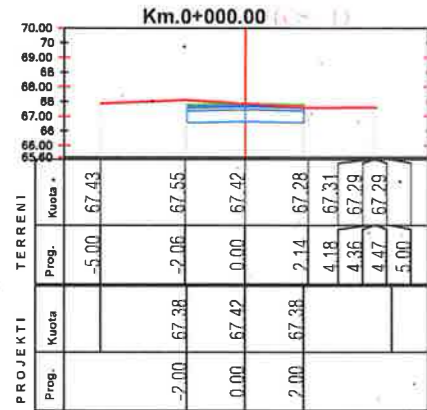
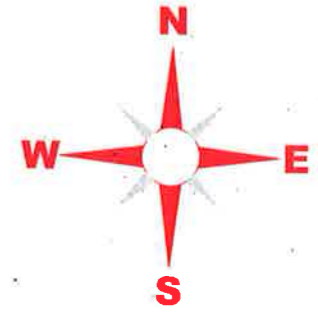

LEGJENDA

- NIVELETA E RRUGES
- TERRENI NATYRAL

BASHKIA KAMEZ
 DREJTORIA E PROJEKTEVE DHE INVESTIMEVE
 DEPARTAMENTI I PROJEKTEVE

Dr. e Projekteve e Investimeve	RAMADAN HYSA
Pergj. Sektori i Projekteve	DENIS PRENCI
STAFI TEKNIK	Ing. EMANUELA MËZIU
PROJEKTUES	Ing. ARTUR ÇAJKA
	Ing. ALEKS DANI
	Ing. ARJOLA KURTI

Titulli i Projektit	NDËRTIM RRUGËT "BLOKU PASKUQAN , KAMËZ , BATHORE "
Faza e Projektit	PROJEKT ZBATIMI
Data e Implementimit :	
Shkalla e Vizimit	H 1:250
Emertimi i Fletes	PROFLET TËRTHORE
Fleta Nr.	06

PROFILE TËRTHORE RRUGA SEG PING BESELIDHJA

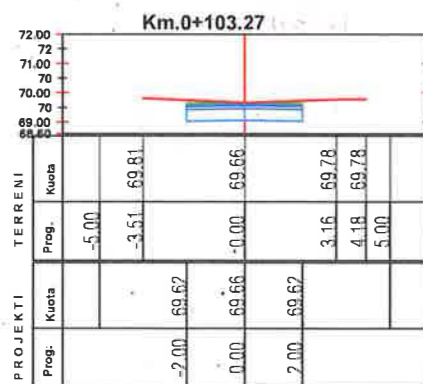
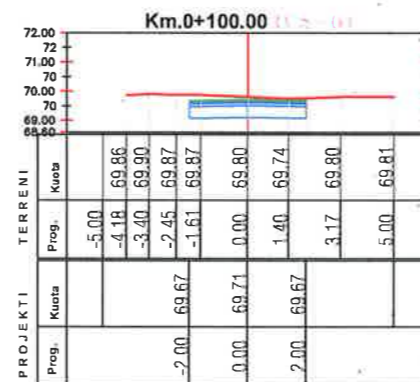
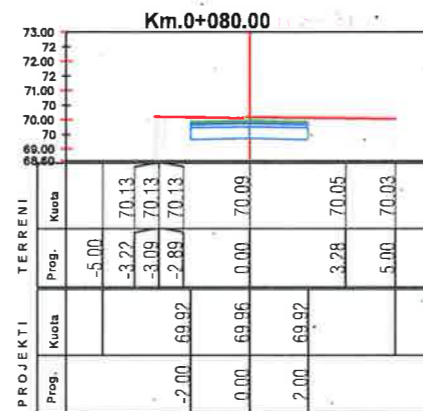
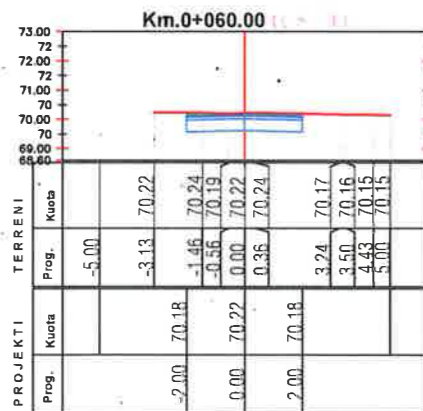
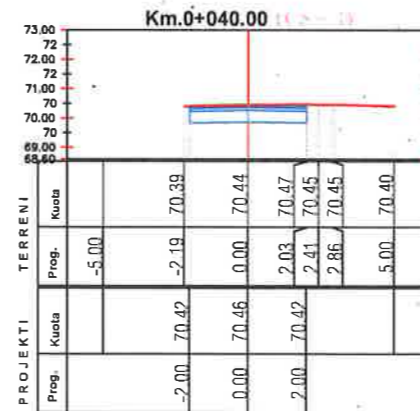
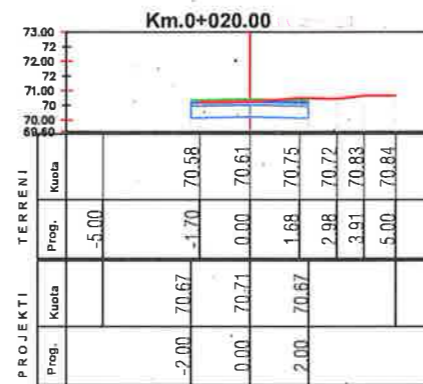
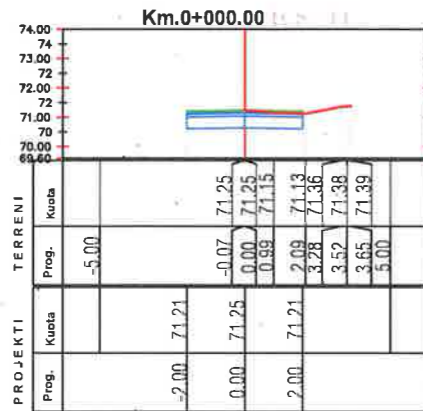
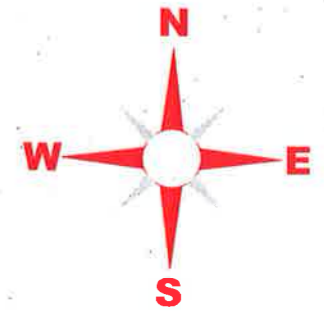

LEGJENDA

- NIVELETA E RRUGES
- TERRENI NATYRAL



BASHKIA KAMEZ

DREJTORIA E PROJEKTEVE DHE INVESTIMEVE
DEPARTAMENTI I PROJEKTEVE

Dr. e Projekteve e Investimeve	RAMADAN HYSA	
Pergj. Sektori i Projekteve	DENIS PRENÇI	
STAFI TEKNIK	Ing. EMANUELA MËZIU	
PROJEKTUES	Ing. ARTUR ÇAJKA	
	Ing. ALEKS DANI	
	Ing. ARJOLA KURTI	

Titulli i Projektit	NDËRTIM RRUGËT "BLOKU PASKUQAN , KAMËZ , BATHORE "	Faza e Projektit	PROJEKT ZBATIMI
Emertimi i Fieses	PROFILLET TËRTHORE	Data e Implementimit :	
		Shkalla e Vizatimit	H 1:250
		Fleta Nr.	07

PROFILE TËRTHORE RRUGA SEG PING MAHMUT DACI

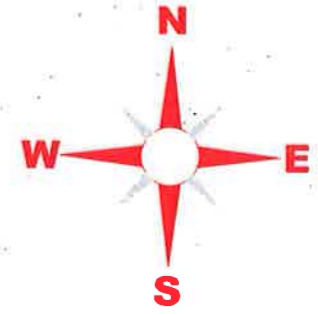
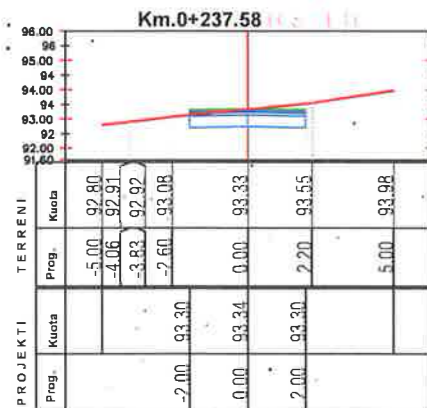
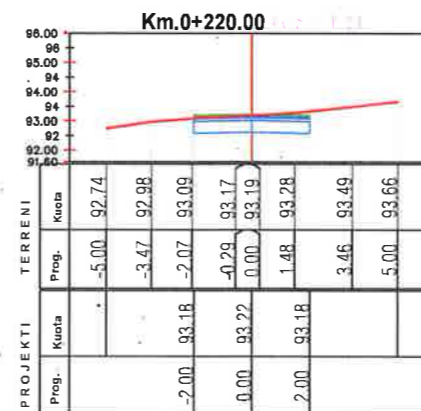
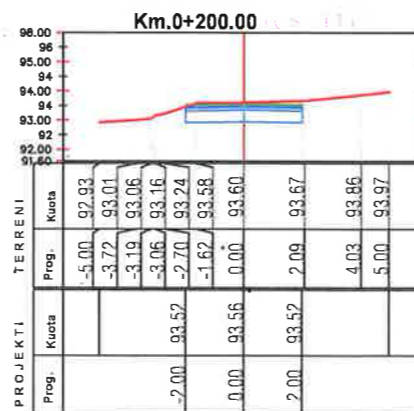
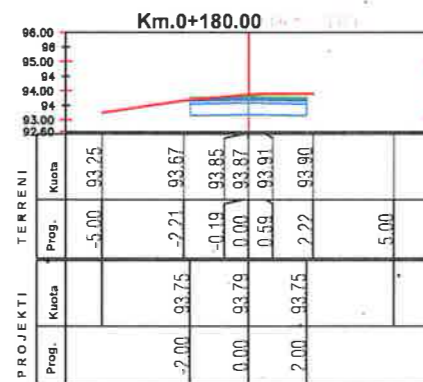
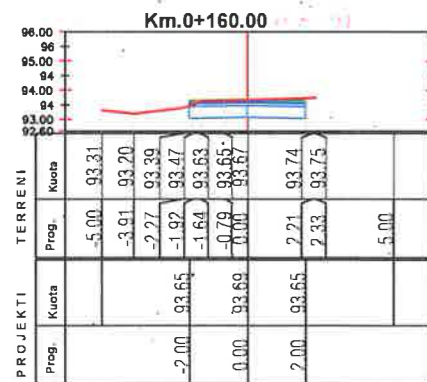
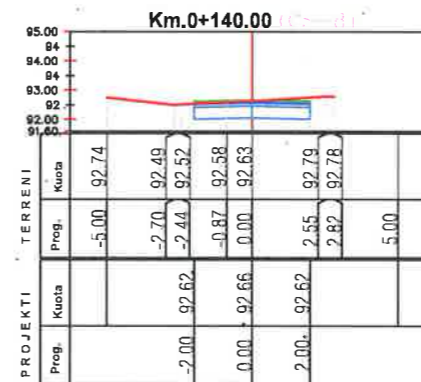
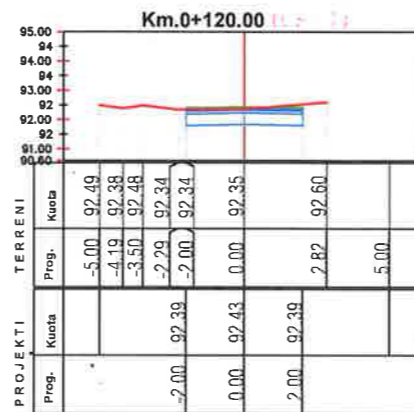
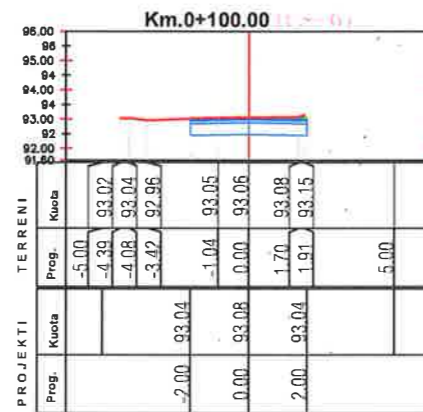
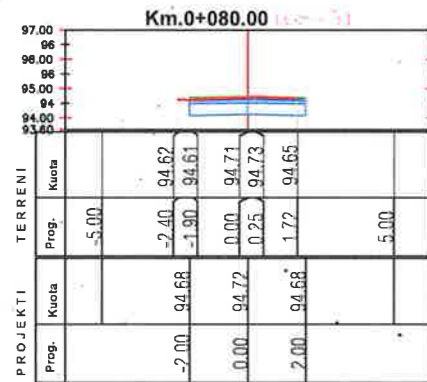
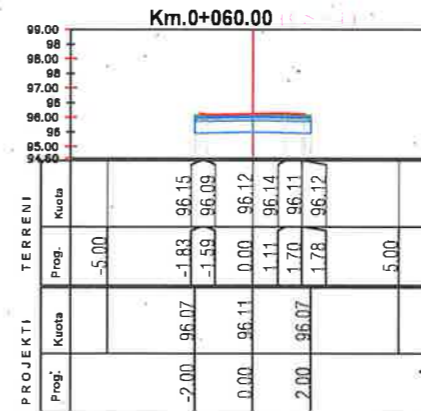
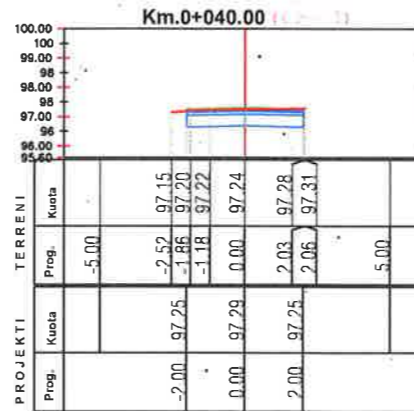
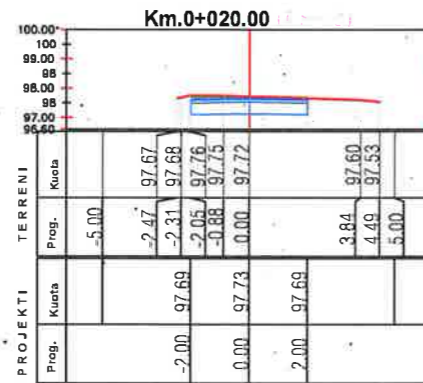
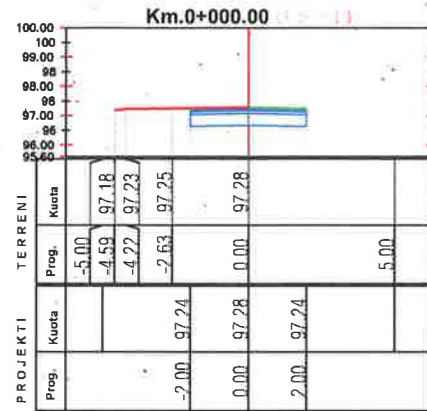

LEGJENDA

- NIVELETA E RRUGES
- TERRENI NATYRAL

BASHKIA KAMEZ
 DREJTORIA E PROJEKTEVE DHE INVESTIMEVE
 DEPARTAMENTI I PROJEKTEVE

Dr. e Projekteve e Investimeve	RAMADAN HYSA	
Pergj. Sektori i Projekteve	DENIS PRENCI	
STAFI TEKNIK PROJEKTES	Ing. EMANUELA MËZIU Ing. ARTUR ÇAJKA Ing. ALEKS DANI Ing. ARJOLA KURTI	

Titulli i Projektit	Faza e Projektit
NDËRTIM RRUGËT "BLOKU PASKUQAN , KAMËZ , BATHORE "	PROJEKT ZBATIMI
Emortimi i Fietes	Data e Implementimit :
PROFLET TËRTHORE	Shkalla e Vizatimit H 1:250
	Fleta Nr. 08

PROFILE TËRTHORE RRUGA SEG PING MEHDI FRASHERI

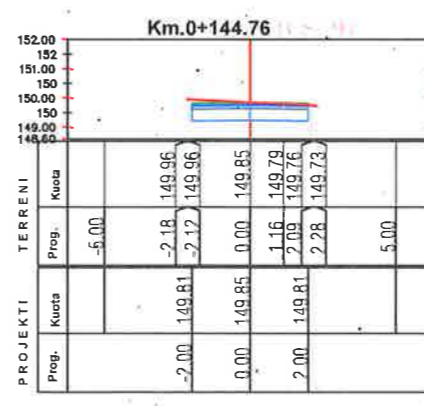
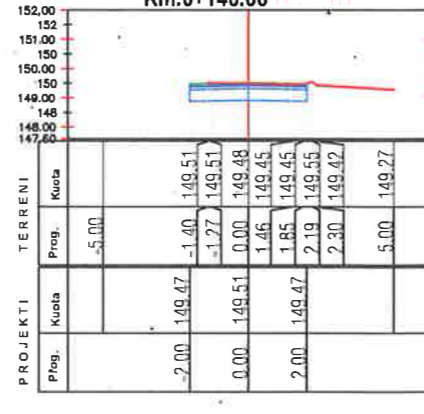
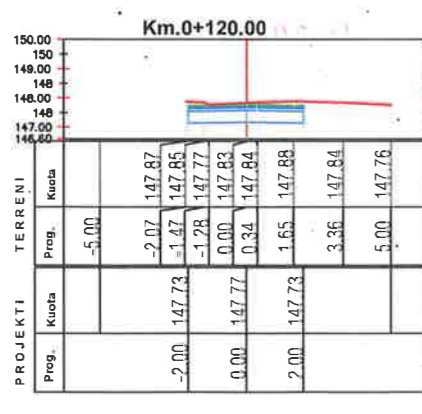
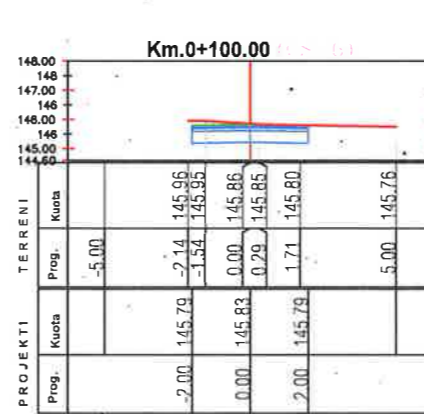
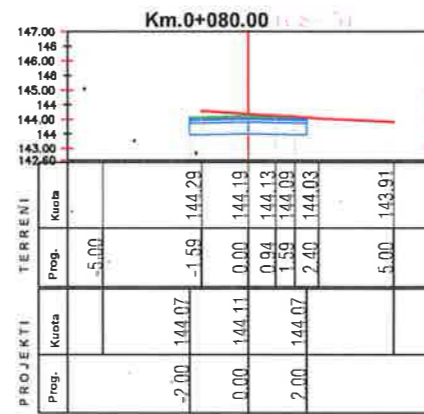
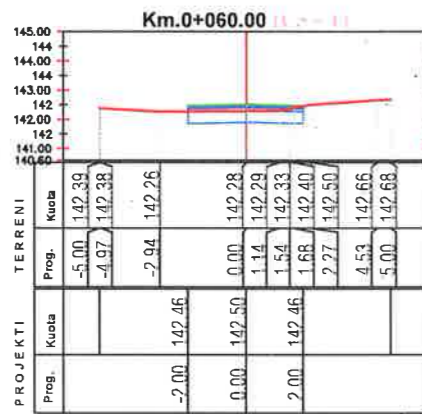
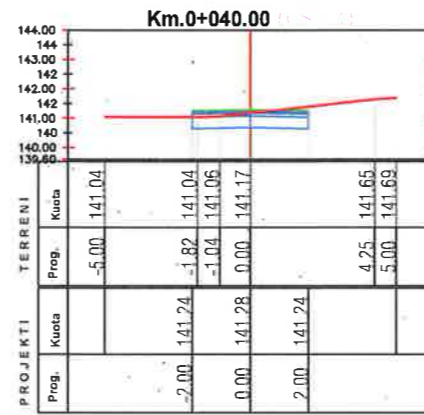
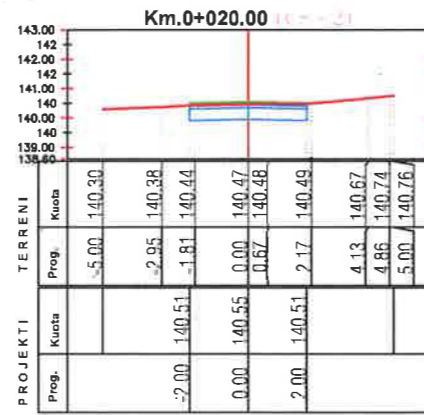
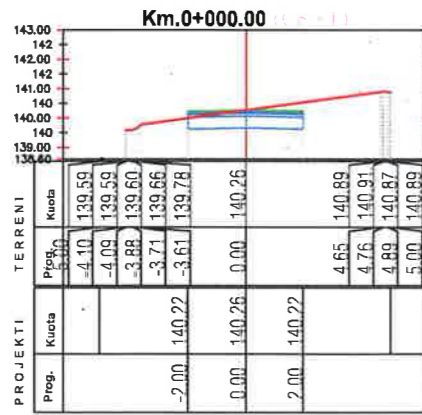
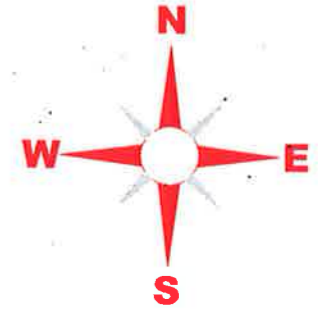

LEGJENDA

- NIVELETA E RRUGES
- TERRENI NATYRAL

BASHKIA KAMEZ
 DREJTORIA E PROJEKTEVE DHE INVESTIMEVE
 DEPARTAMENTI I PROJEKTEVE

Dr. e Projekteve e Investimeve	RAMADAN HYSA	
Pergj. Sektorit i Projekteve	DENIS PRENCI	
STAFI TEKNIK PROJEKTES	Ing. EMANUELA MEZIU	
	Ing. ARTUR ÇAJKA	
	Ing. ALEKS DANI	
	Ing. ARJOLA KURTI	

Titulli i Projektit	Faza e Projektit
NDËRTIM RRUGËT "BLOKU PASKUQAN , KAMËZ , BATHORE "	PROJEKT ZBATIMI
Emertimi i Fletës	Data e Implementimit :
PROFILET TËRTHORE	Shkalla e Vizatimit H 1:250
	Fleta Nr. 09

PROFILE TËRTHORE RRUGA SEG PING HALIT HAXHIA

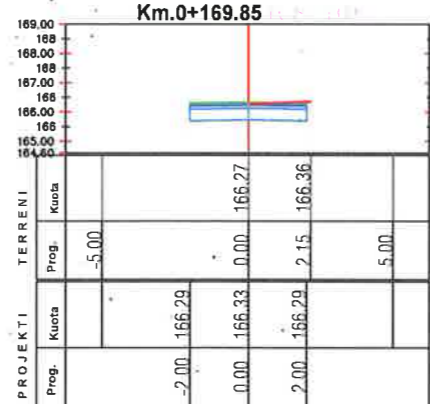
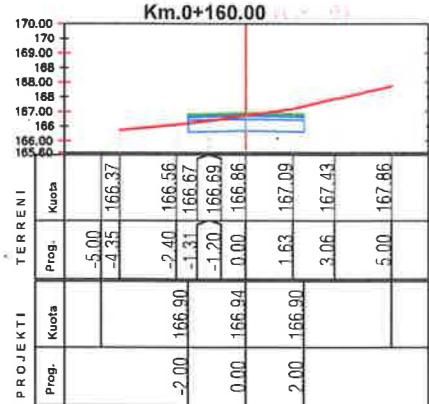
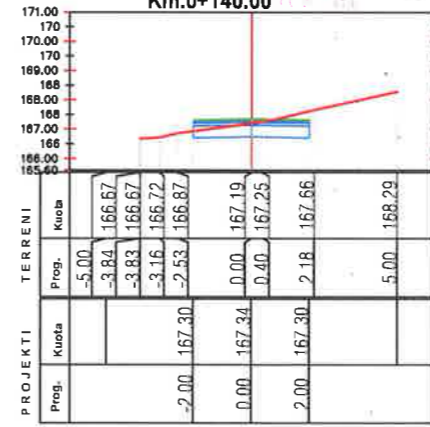
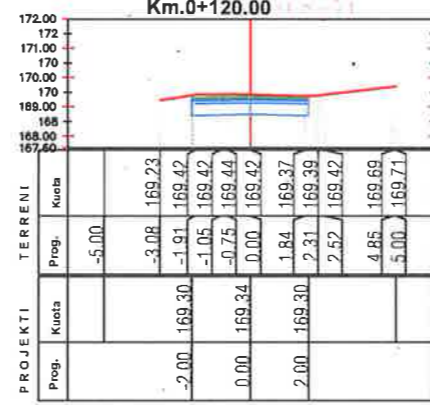
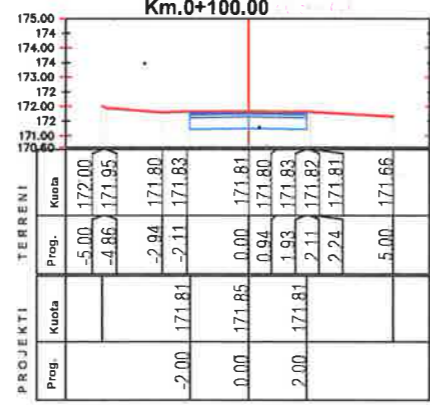
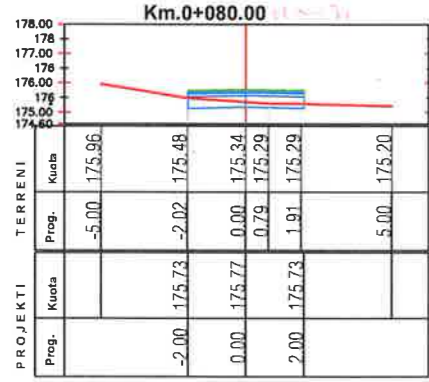
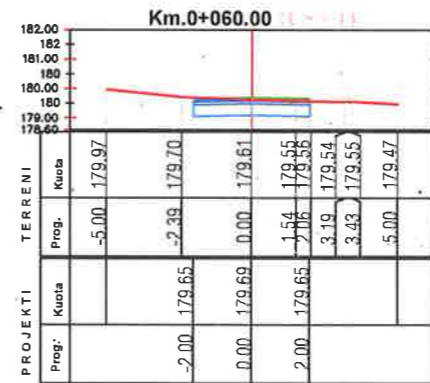
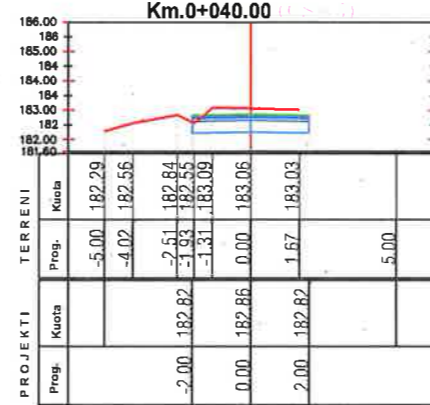
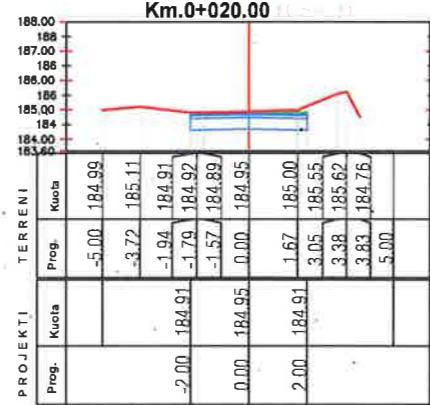
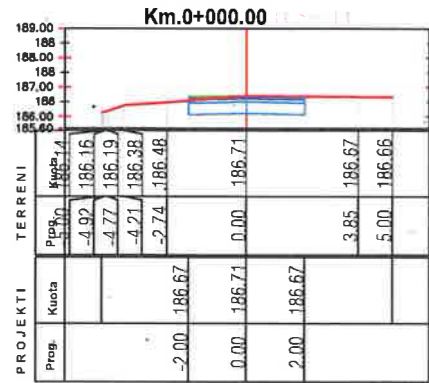
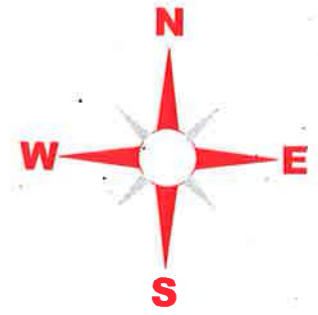

LEGJENDA

- NIVELETA E RRUGES
- TERRENI NATYRAL

BASHKIA KAMEZ
 DREJTORIA E PROJEKTEVE DHE INVESTIMEVE
 DEPARTAMENTI I PROJEKTEVE

Dr. e Projekteve e Investimeve	RAMADAN HYSA	
Pergj. Sektori i Projekteve	DENIS PRENÇI	
STAFI TEKNIK	Ing. EMANUELA MËZIU	
PROJEKTUES	Ing. ARTUR ÇAJKA	
	Ing. ALEKS DANI	
	Ing. ARJOLA KURTI	

Titulli i Projektit	NDËRTIM RRUGËT "BLOKU PASKUQAN , KAMËZ , BATHORE "	Faza e Projektit	PROJEKT ZBATIMI
Emertimi i Fletes	PROFILET TËRTHORE	Data e Implementimit:	
		Shkalla e Vizatimit	H 1:250
		Fleta Nr.	10

PROFILE TËRTHORE RRUGA SEG 1 PING MEMO META

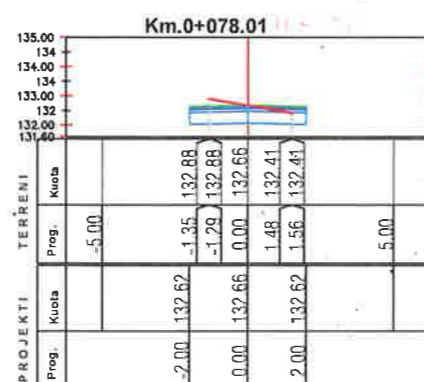
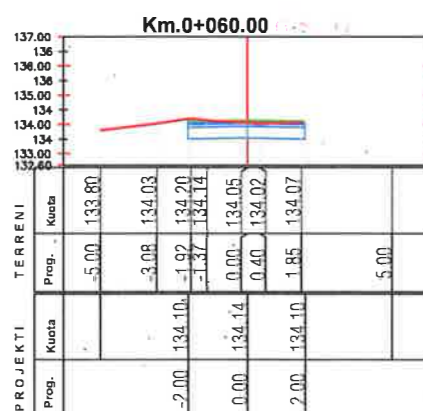
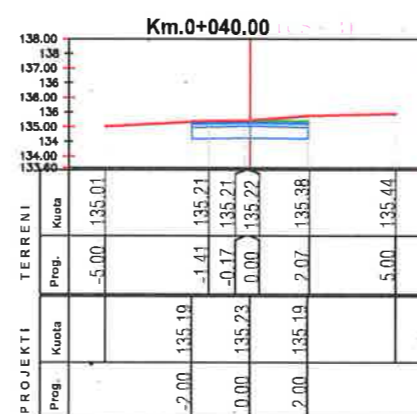
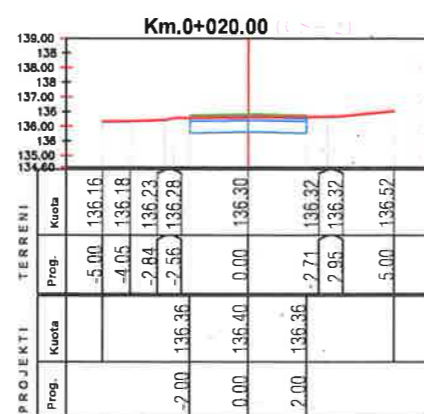
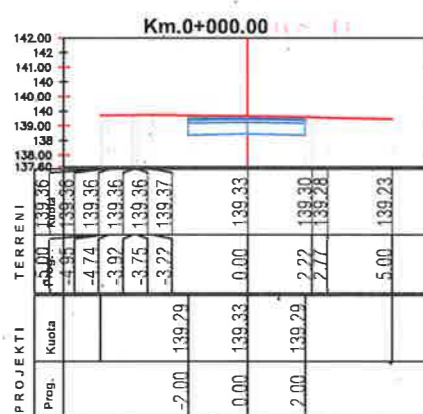
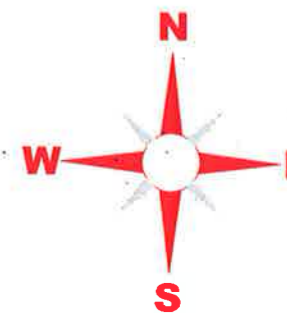

LEGJENDA

- NIVELETA E RRUGES
- TERRENI NATYRAL



BASHKIA KAMEZ

DREJTORIA E PROJEKTEVE DHE INVESTIMEVE
DEPARTAMENTI I PROJEKTEVE

Dr. e Projekteve e Investimeve RAMADAN HYSA

Pergj. Sektori i Projekteve DENIS PRENCI

STAFI TEKNIK
PROJEKTUES
Ing. EMANUELA MËZIU
Ing. ARTUR ÇAJKA
Ing. ALEKS DANI
Ing. ARJOLA KURTI

Titulli i Projektit
NDËRTIM RRUGËT "BLOKU PASKUQAN
, KAMËZ , BATHORE "

Faza e Projektit
PROJEKT ZBATIMI

Data e Implementimit :

Emertimi i Fietes

PROFILLET TËRTHORE

Shkalla e Vizatimit
H 1:250

Fleta Nr.

PROFILE TËRTHORE RRUGA SEG 2 PING MEMO META

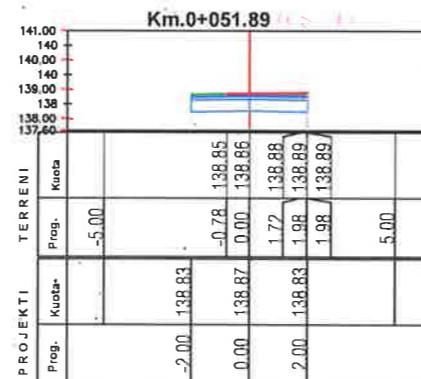
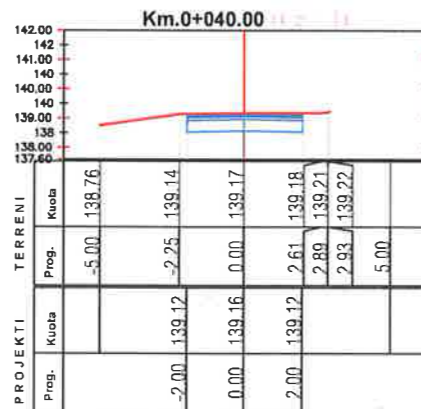
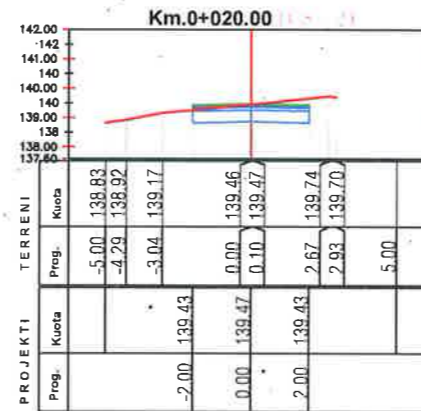
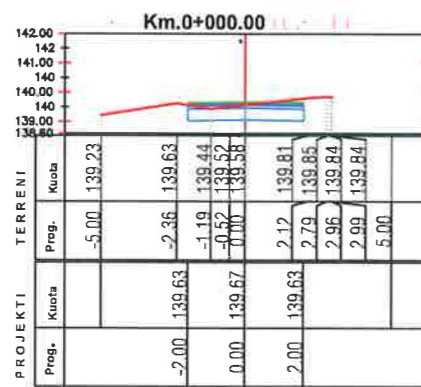
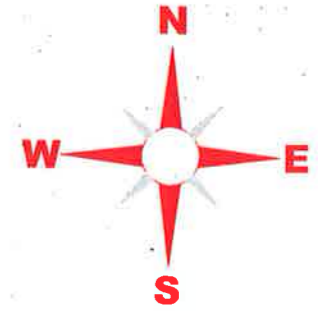

LEGJENDA

- NIVELETA E RRUGES
- TERRENI NATYRAL



BASHKIA KAMEZ

DREJTORIA E PROJEKTEVE DHE INVESTIMEVE
DEPARTAMENTI I PROJEKTEVE

Dr. e Projekteve e Investimeve	RAMADAN HYSA
Pergj. Sektori i Projekteve	DENIS PRENÇI
STAFI TEKNIK PROJEKTES	Ing. EMANUELA MËZIU Ing. ARTUR ÇAJKA Ing. ALEKS DANI Ing. ARJOLA KURTI.

Titulli i Projektit
NDËRTIM RRUGËT "BLOKU PASKUQAN
, KAMËZ , BATHORE "

Emertimi i Fletes
PROFILET TËRTHORE

Faza e Projektit
PROJEKT ZBATIMI

Shkalla e Vizatimit
H 1:250

Fleta Nr.
12

PROFILE TËRTHORE RRUGA SEG PING MITHAT FRASHERI

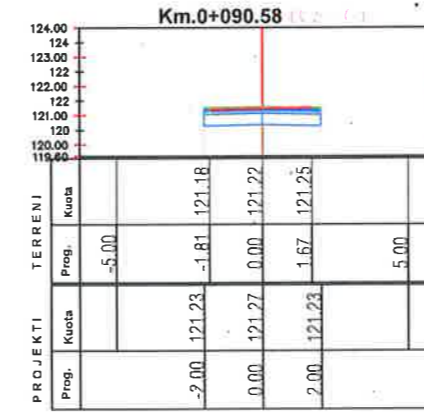
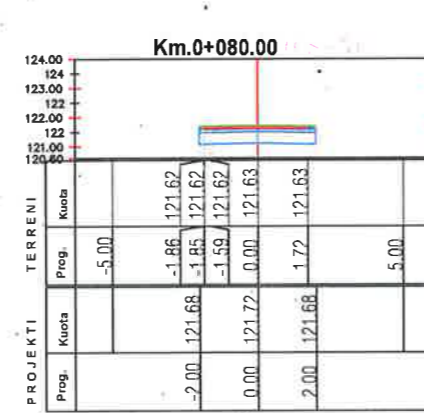
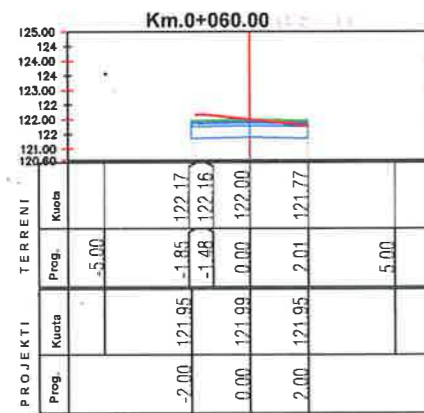
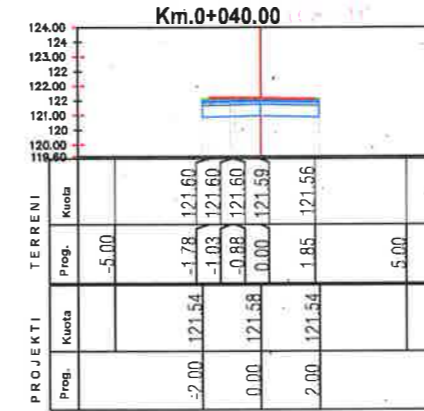
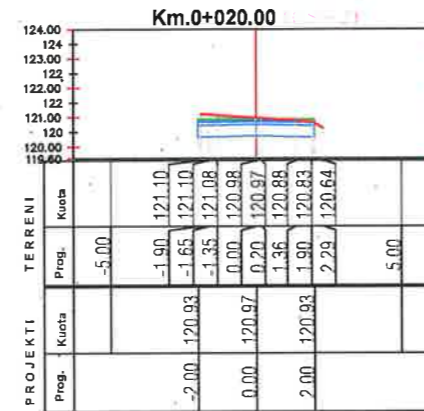
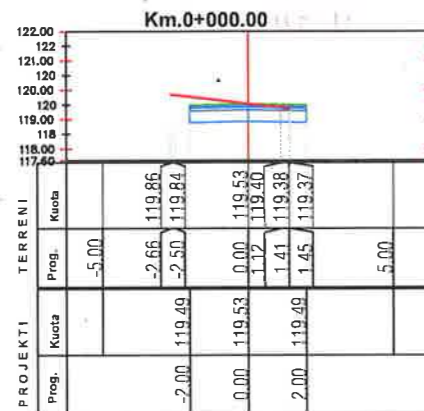
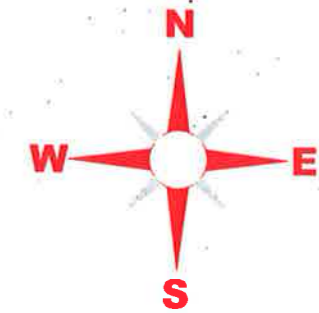

LEGJENDA

— NIVELETA E RRUGES

— TERRENI NATËRAL



BASHKIA KAMEZ

DREJTORIA E PROJEKTEVE DHE INVESTIMEVE
DEPARTAMENTI I PROJEKTEVE

Dr. e Projekteve e Investimeve	RAMADAN HYSA	
Pergj. Sektori i Projekteve	DENIS PRENGJI	
STAFI TEKNIK PROJEKTUES	Ing. EMANUELA MËZIU	
	Ing. ARTUR ÇAJKA	
	Ing. ALEKS DANI	
	Ing. ARJOLA KURTI	

Titulli i Projektit
NDËRTIM RRUGËT "BLOKU PASKUQAN
, KAMËZ , BATHORE "

Emertimi i Fletës

PROFILET TËRTHORE

Faza e Projektit
PROJEKT ZBATIMI

Data e Implementimit:

Shkalla e Vizatimit
H 1:250

Fleta Nr.

13

PROFILE TËRTHORE RRUGA SEG 1 ANDON ZAKO CAJUPI

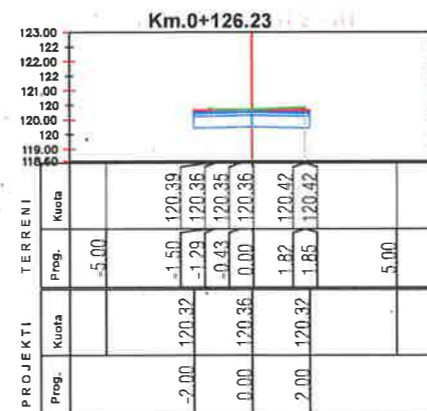
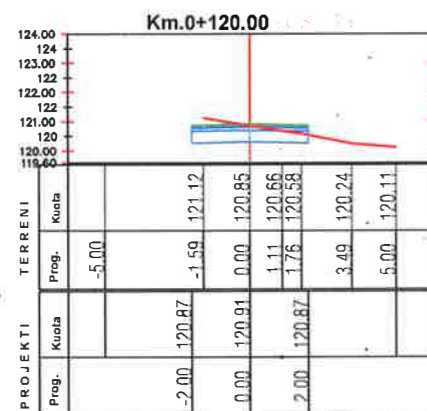
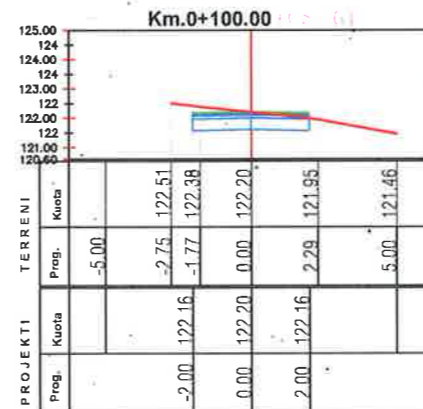
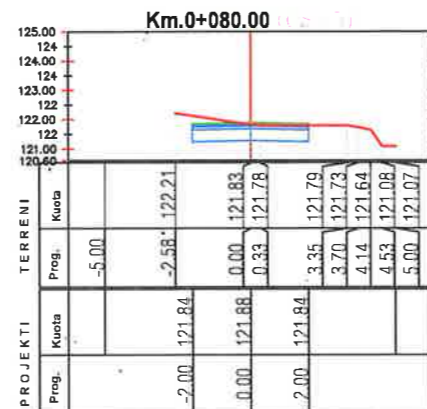
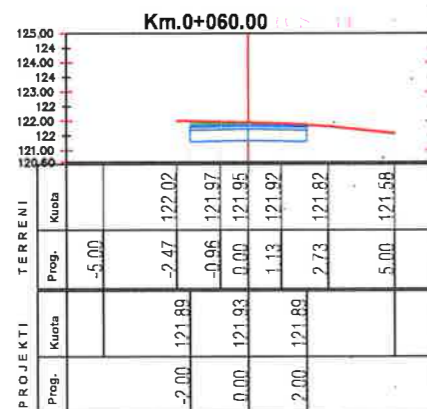
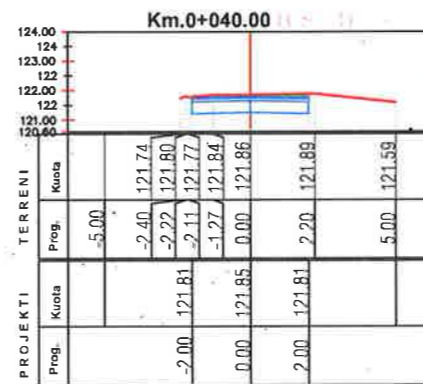
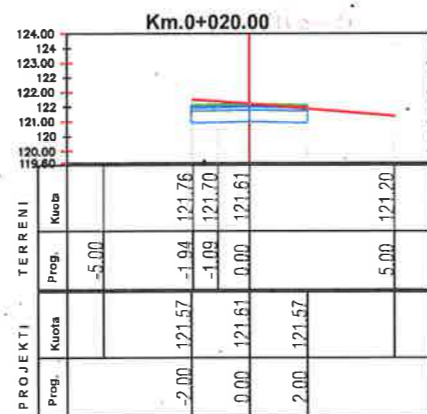
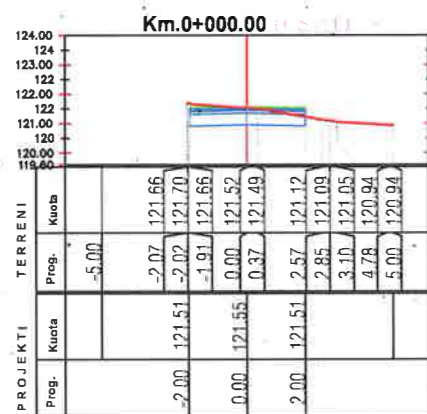
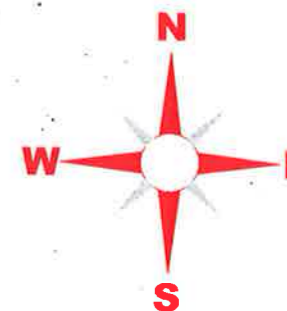

LEGJENDA

- NIVELETA E RRUGES
- TERRENI NATYRAL



BASHKIA KAMEZ

DREJTORIA E PROJEKTEVE DHE INVESTIMEVE
DEPARTAMENTI I PROJEKTEVE

Dr. e Projekteve e Investimeve	RAMADAN HYSA	
Pergj. Sektori i Projekteve	DENIS PRENÇI	
STAFI TEKNIK PROJEKTES	Ing. EMANUELA MËZIU	
	Ing. ARTUR ÇAJKA	
	Ing. ALEKS DANI	
	Ing. ARJOLA KURTI	

Titulli i Projektit
NDËRTIM RRUGËT "BLOKU PASKUQAN
, KAMËZ , BATHORE "

Faza e Projektit
PROJEKT ZBATIMI

Emertimi i Fletes

PROFLET TËRTHORE

Data e Implementimit :

Shkalla e Vizimit
H 1:250

Fleta Nr.

PROFILE TËRTHORE RRUGA SEG 2 ANDON ZAKO CAJUPI

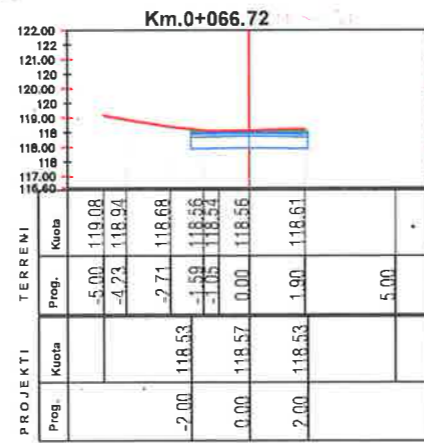
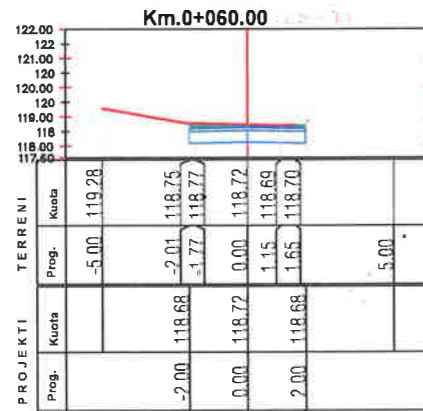
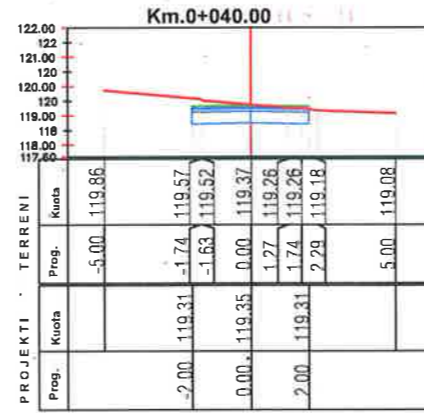
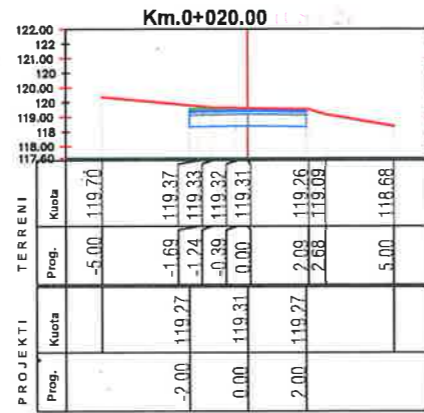
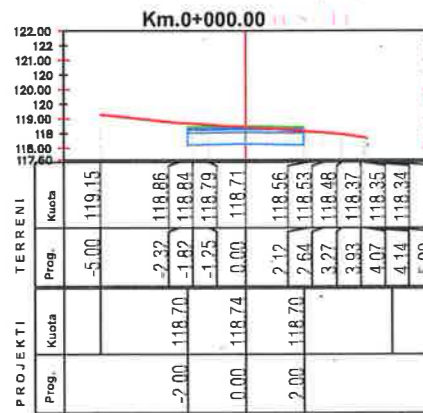
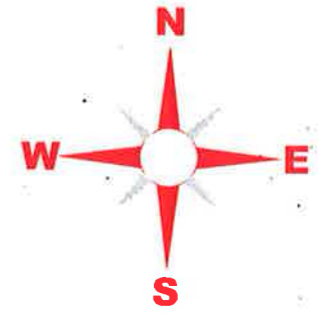

LEGJENDA

- NIVELETA E RRUGES
- TERRENI NATYRAL



BASHKIA KAMEZ

DREJTORIA E PROJEKTEVE DHE INVESTIMEVE
DEPARTAMENTI I PROJEKTEVE

Dr. e Projekteve e Investimeve	RAMADAN HYSA	
Pergj. Sektori i Projekteve	DENIS PRENÇI	
STAFI TEKNIK PROJEKTUES	Ing. EMANUELA MËZIU	
	Ing. ARTUR ÇAJKA	
	Ing. ALEKS DANI	
	Ing. ARJOLA KURTI	

Titulli i Projektit
NDËRTIM RRUGËT "BLOKU PASKUQAN
, KAMËZ , BATHORE "

Emertimi i Fletes
PROFLET TËRTHORE

Faza e Projektit
PROJEKT ZBATIMI
Data e Implementimit:
Shkalla e Vizatimit
H 1:250
Fleta Nr.

PROFILE TËRTHORE RRUGA ZIJA KOMBO

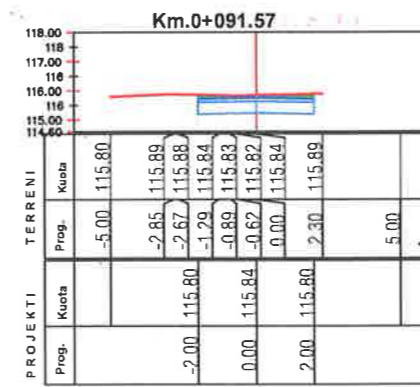
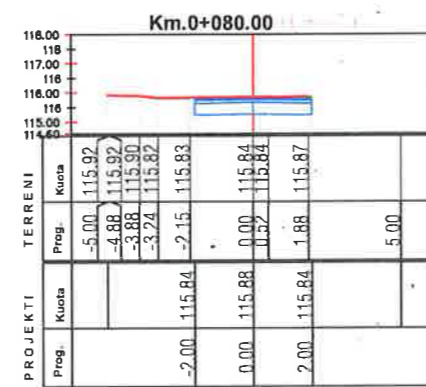
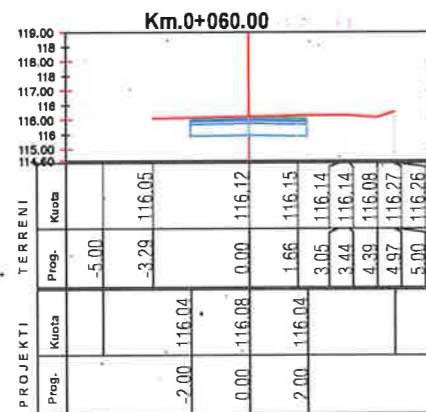
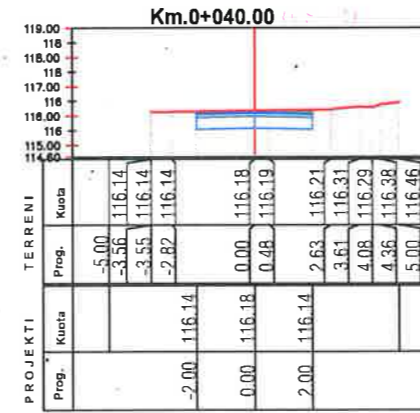
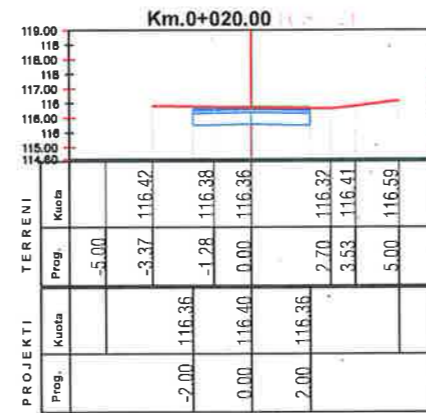
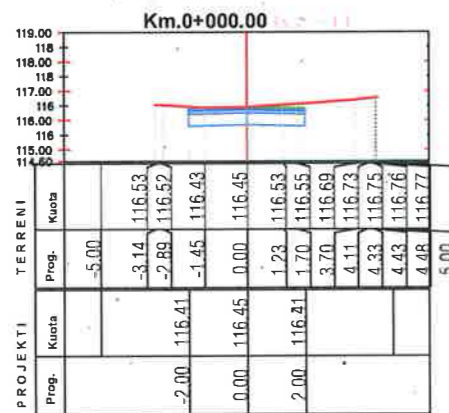
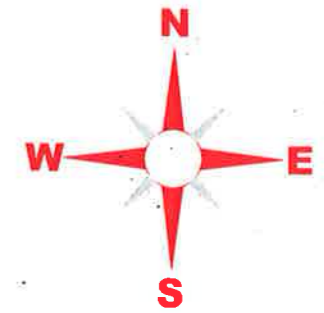

LEGJENDA

- NIVELETA E RRUGES
- TERRENI NATYRAL



BASHKIA KAMEZ

DREJTORIA E PROJEKTEVE DHE INVESTIMEVE
DEPARTAMENTI I PROJEKTEVE

Dr. e Projekteve e Investimeve	RAMADAN HËSA
Pergj. Sektori i Projekteve	DENIS PRENÇI
STAFI TEKNIK PROJEKTUES	Ing. EMANUELA MËZIU Ing. ARTUR ÇAJKA Ing. ALEKS DANI Ing. ARJOLA KURTI

Titulli i Projektit	Faza e Projektit
NDËRTIM RRUGËT "BLOKU PASKUQAN , KAMËZ , BATHORE "	PROJEKT ZBATIMI
Emeritimi i Fietes	Data e Implementimit :
PROFIELET TËRTHORE	Shkalla e Vizatimit H 1:250
	Fleta Nr. 16

PROFILE TËRTHORE RRUGA SEG PING XHEMAL ARANITI

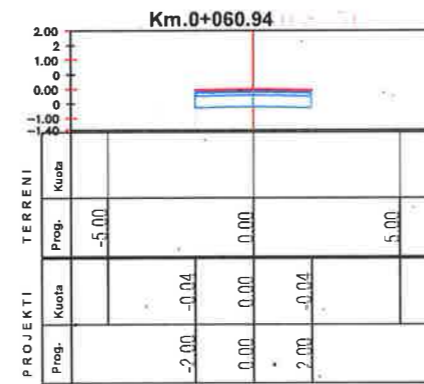
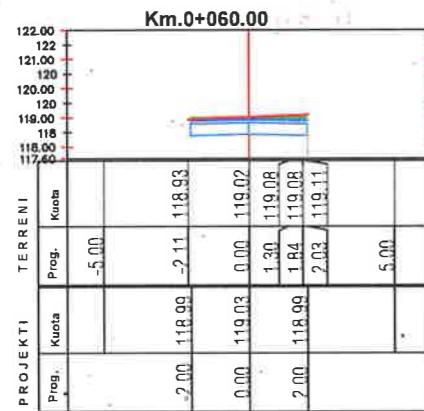
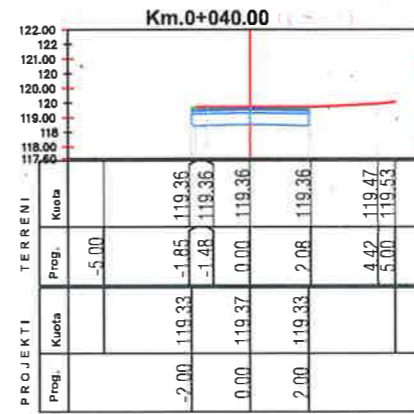
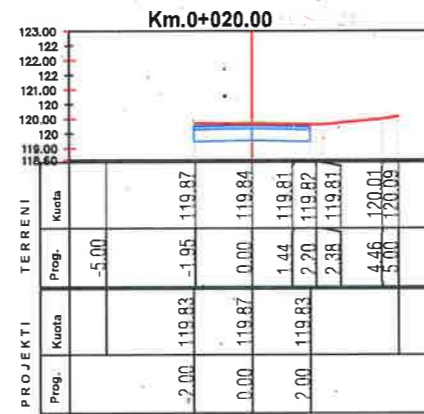
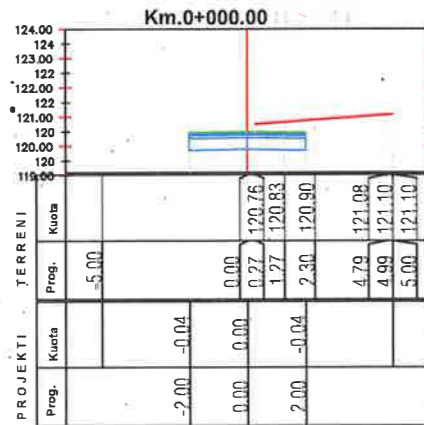
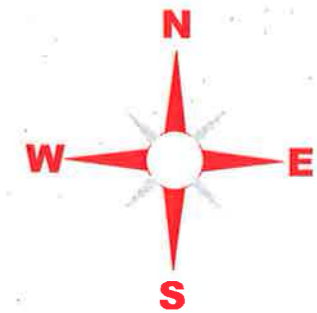

LEGJENDA

- NIVELETA E RRUGES
- TERRENI NATYRAL



BASHKIA KAMEZ

DREJTORIA E PROJEKTEVE DHE INVESTIMEVE
DEPARTAMENTI I PROJEKTEVE

Dr. e Projekteve e Investimeve	RAMADAN HYSA	
Pergj. Sektori i Projekteve	DENIS PRENÇI	
STAFI TEKNIK PROJEKTUES	Ing. EMANUELA MËZIU	
	Ing. ARTUR ÇAJKA	
	Ing. ALEKS DANI	
	Ing. ARJOLA KURTI	

Titulli i Projektit
NDËRTIM RRUGËT "BLOKU PASKUQAN
, KAMËZ, BATHORE "

Emertimi i Fletes

PROFLET TËRTHORE

Faza e Projektit
PROJEKT ZBATIMI

Data e Implementimit :

Shkalla e Vizatimit
H 1:250

Fleta Nr.

PROFILE TËRTHORE RRUGA SEG PING SKENDERBEU

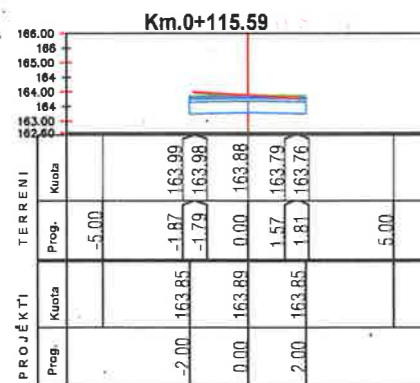
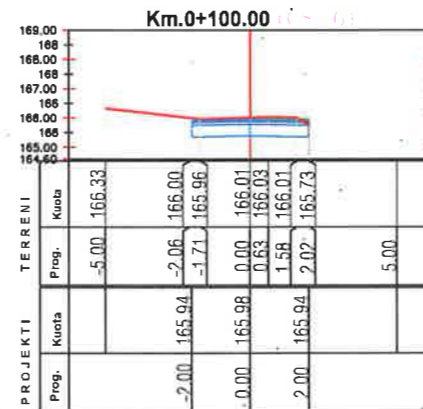
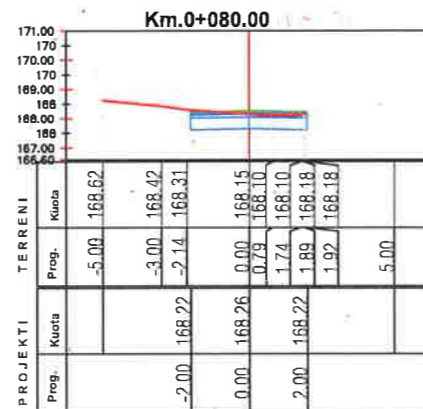
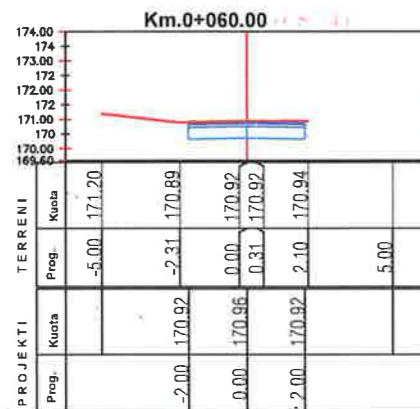
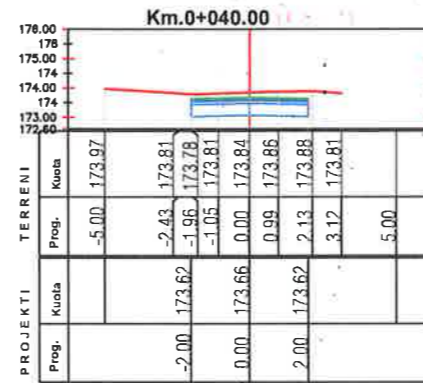
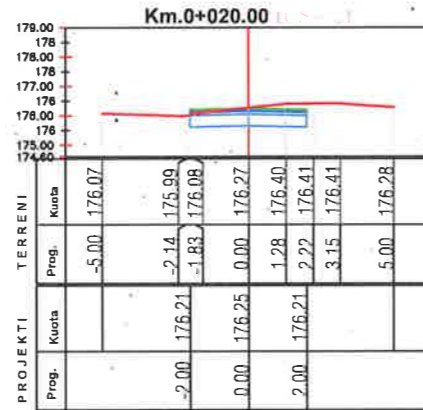
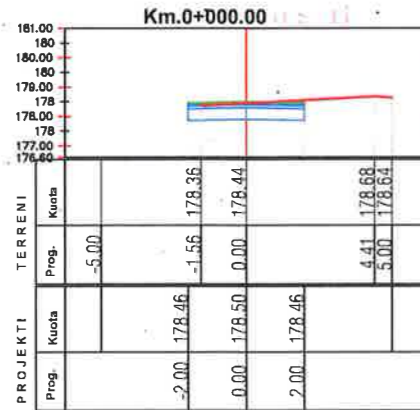
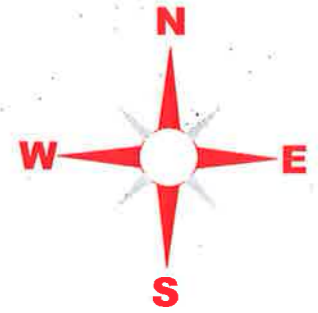

LEGJENDA

- NIVELETA E RRUGES
- TERRENI NATYRAL



BASHKIA KAMEZ

DREJTORIA E PROJEKTEVE DHE INVESTIMEVE
DEPARTAMENTI I PROJEKTEVE

Dr. e Projekteve e Investimeve	RAMADAN HYSA	
Pergj. Sektori i Projekteve	DENIS PRENÇI	
STAFI TEKNIK PROJEKTUES	Ing. EMANUELA MËZIU	
	Ing. ARTUR ÇAJKA	
	Ing. ALEKS DANI	
	Ing. ARJOLA KURTI	

Titulli i Projektit
NDËRTIM RRUGËT "BLOKU PASKUQAN
, KAMËZ , BATHORE "

Faza e Projektit
PROJEKT ZBATIMI

Emertimi i Fletes
PROFIELET TËRTHORE

Data e Implementimit :
Shkalla e Vizatimit
H 1:250
Fleta Nr.

PROFILE TËRTHORE RRUGA SEG PING SALI MURAT VRANISHTI

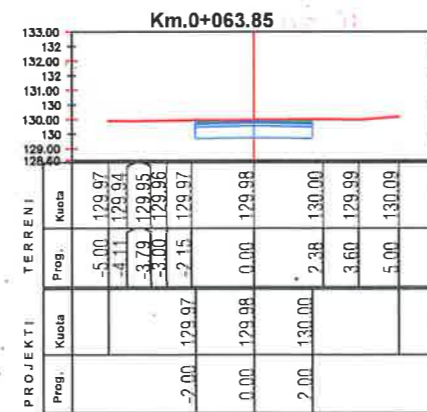
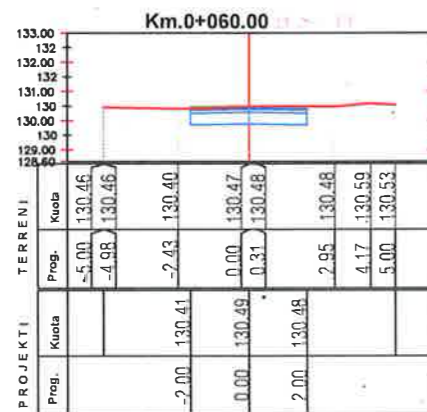
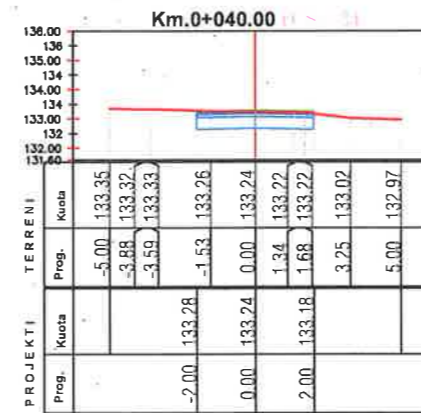
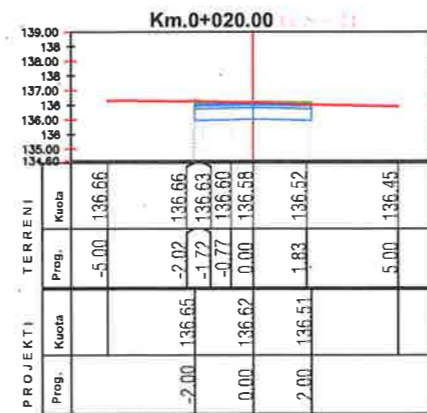
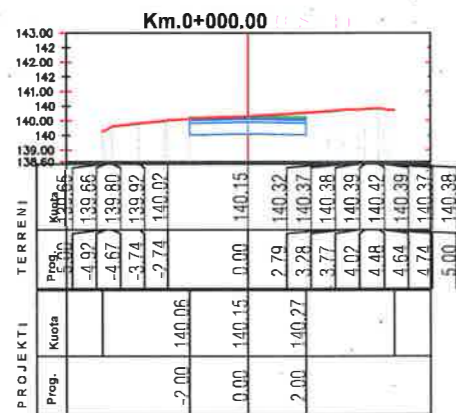
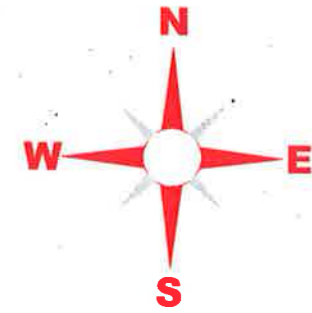

LEGJENDA

- NIVELETA E RRUGES
- TERRENI NATYRAL



BASHKIA KAMEZ

DREJTORIA E PROJEKTEVE DHE INVESTIMEVE
DEPARTAMENTI I PROJEKTEVE

Dr. e Projekteve e Investimeve	RAMADAN HYSA	
Pergj. Sektori i Projekteve	DENIS PRENÇI	
STAFI TEKNIK PROJEKTES	Ing. EMANUELA MËZIU	
	Ing. ARTUR ÇAJKA	
	Ing. ALEKS DANI	
	Ing. ARJOLA KURTI	

Titulli i Projektit
NDËRTIM RRUGËT "BLOKU PASKUQAN
, KAMËZ , BATHORE "

Emertimi i Fletes
PROFILET TËRTHORE

Faza e Projektit
PROJEKT ZBATIMI

Data e Implementimit:

Shkalla e Vizatimit
H 1:250

Fleta Nr.

PROFILE TËRTHORE RRUGA SEG 1 PING SALI MURAT VRANISHTI

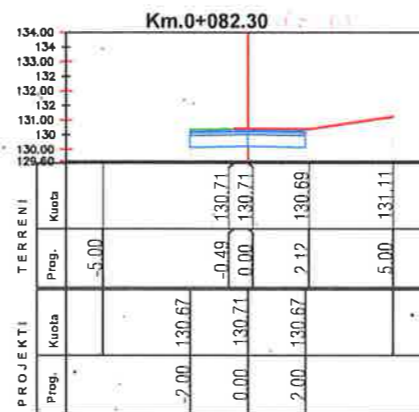
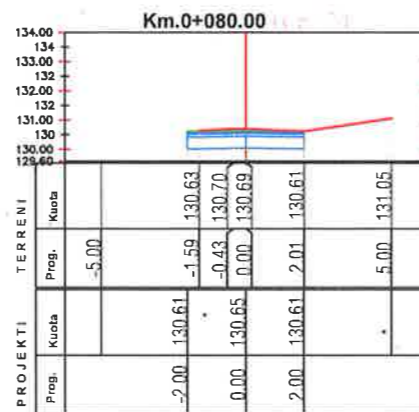
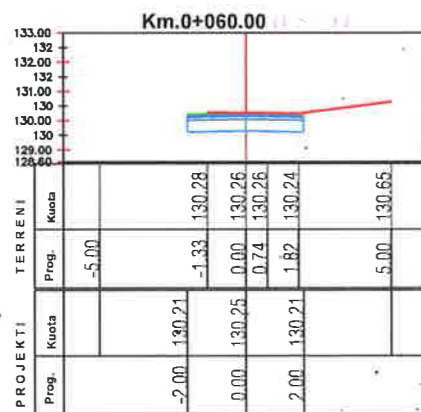
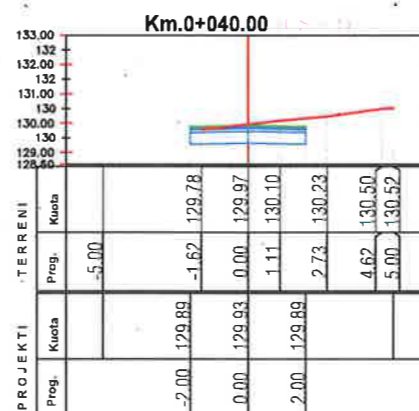
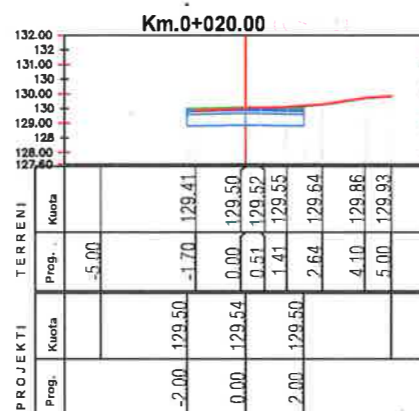
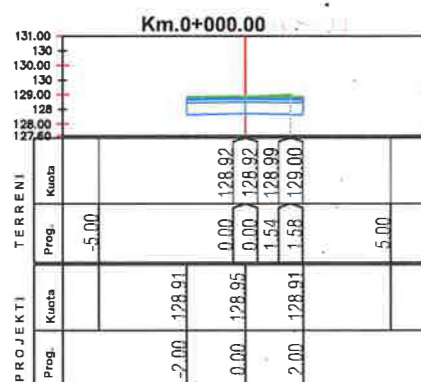
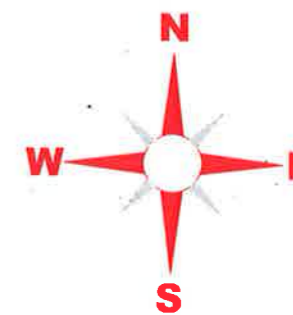

LEGJENDA

- NIVELETA E RRUGES
- TERRENI NATYRAL



BASHKIA KAMËZ

DREJTORIA E PROJEKTEVE DHE INVESTIMEVE
DEPARTAMENTI I PROJEKTEVE

Dr. e Projekteve e Investimeve	RAMADAN HYSA	
Pergj. Sektori i Projekteve	DENIS PRENÇI	
STAFI TEKNIK PROJEKTES	Ing. EMANUELA MËZIU	
	Ing. ARTUR ÇAJKA	
	Ing. ALEKS DANI	
	Ing. ARJOLA KURTI	

Titulli i Projektit
NDËRTIM RRUGËT "BLOKU PAŠKUQAN
, KAMËZ , BATHORE "

Faza e Projektit
PROJEKT ZBATIMI

Emeritimi i Fletes
PROFILET TËRTHORE

Data e Implementimit :

Shkalla e Vizatimit
H 1:250

Fleta Nr.

PROFILE TËRTHORE RRUGA SEG 1 PING IBRAHIM RUGOVA

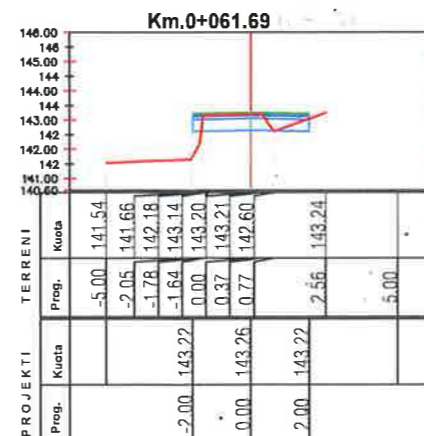
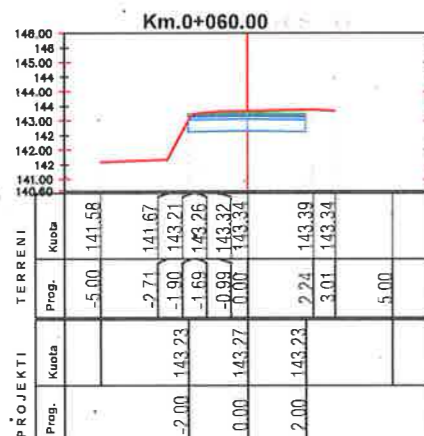
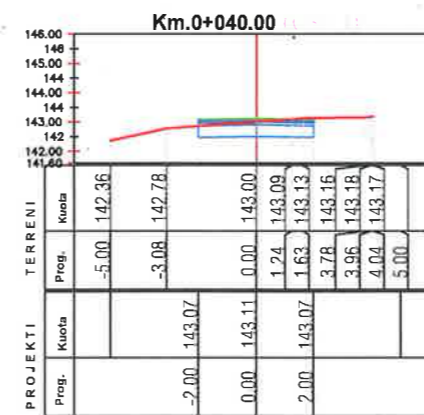
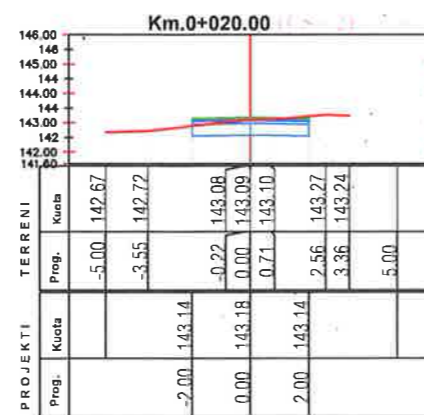
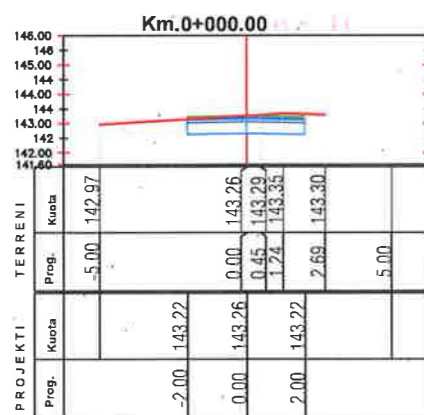
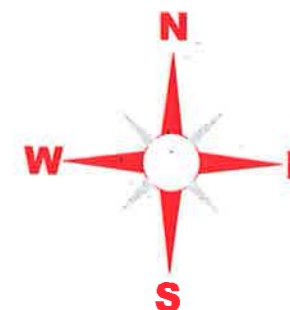

LEGJENDA

- NIVELETA E RRUGES
- TERRENI NATYRAL



BASHKIA KAMEZ

DREJTORIA E PROJEKTEVE DHE INVESTIMEVE
DEPARTAMENTI I PROJEKTEVE

Dr. e Projekteve e Investimeve	RAMADAN HYSA	
Pergj. Sektori i Projekteve	DENIS PRENÇI	
STAFI TEKNIK PROJEKTES	Ing. EMANUELA MËZIU	
	Ing. ARTUR ÇAJKA	
	Ing. ALEKS DANI	
	Ing. ARJOLA KURTI	

Titulli i Projektit
NDËRTIM RRUGËT "BLOKU PASKUQAN
, KAMËZ , BATHORE "

Faza e Projektit
PROJEKT ZBATIMI

Emertimi i Fletes
PROFILET TËRTHORE

Data e Implementimit
H 1:250

Fleta Nr.

PROFILE TËRTHORE RRUGA SEG 2 PING IBRAHIM RUGOVA

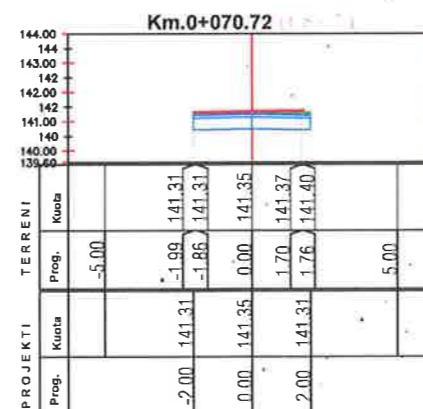
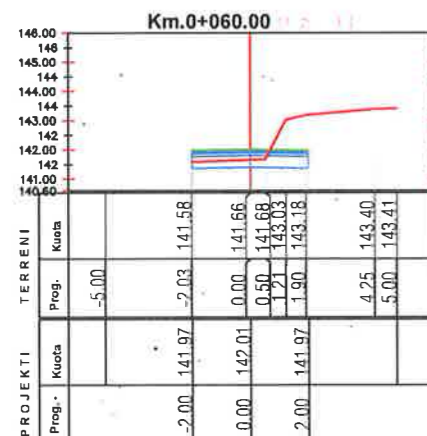
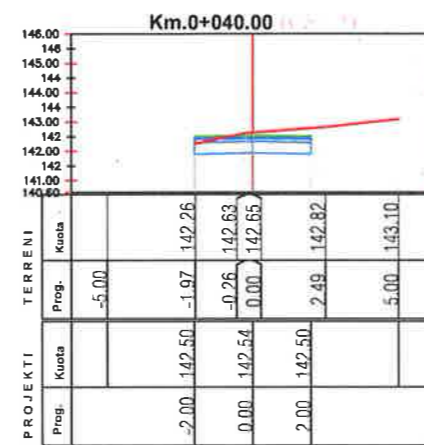
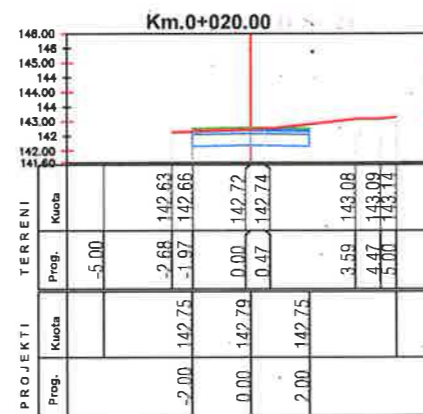
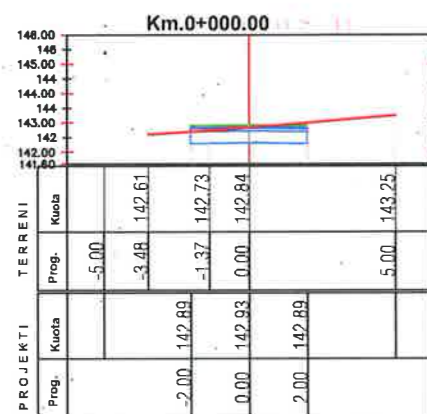
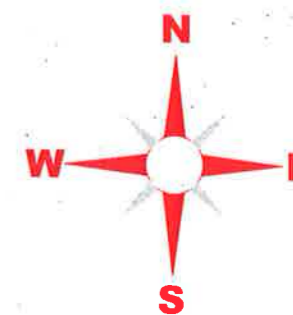

LEGJENDA

NIVELETA E RRUGES

TERRENI NATYRAL



BASHKIA KAMEZ

DREJTORIA E PROJEKTEVE DHE INVESTIMEVE
DEPARTAMENTI I PROJEKTEVE

Dr. e Projekteve e Investimeve	RAMADAN HYSA	
Pergj. Sektori i Projekteve	DENIS PREKCI	
STAFI TEKNIK PROJEKTVES	Ing. EMANUELA MËZIU	
	Ing. ARTUR ÇAJKA	
	Ing. ALEKS DANI	
	Ing. ARJOLA KURTI	

Titulli i Projektit
NDËRTIM RRUGËT "BLOKU PASKUQAN
, KAMËZ , BATHORE "

Faza e Projektit
PROJEKT ZBATIMI

Data e Implementimit :

Shkalla e Vizatimit
H 1:250

Emeritimi i Fletes

PROFLET TËRTHORE

Fleta Nr.

PROFILE TËRTHORE PEDONALE PASKUQAN

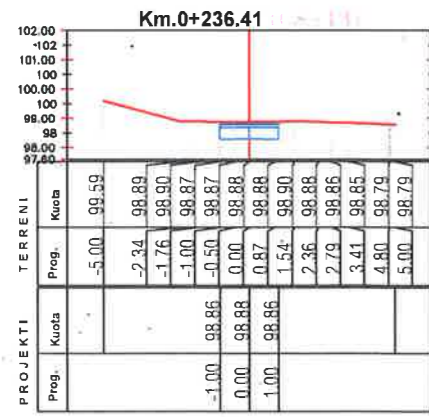
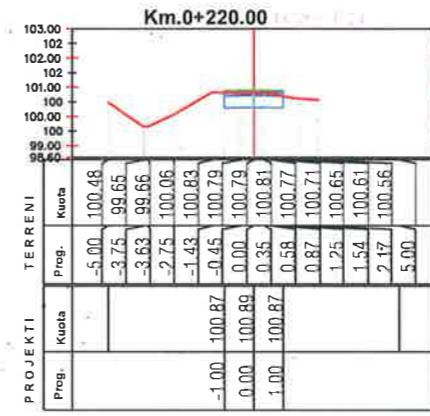
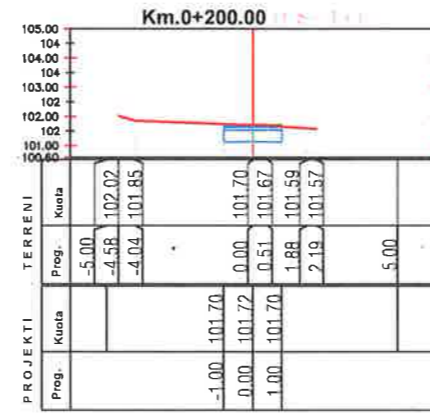
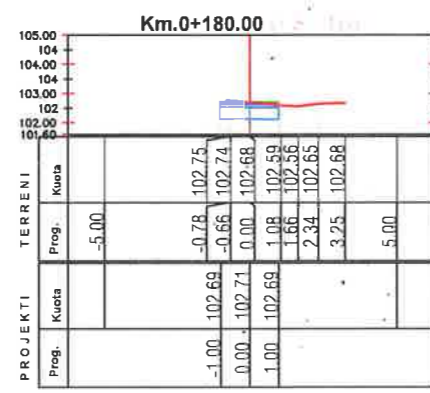
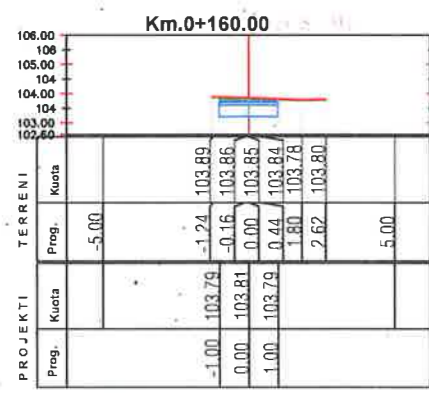
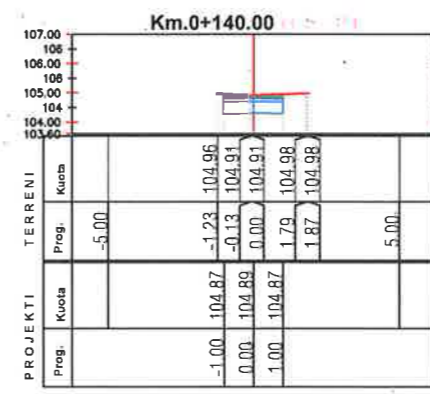
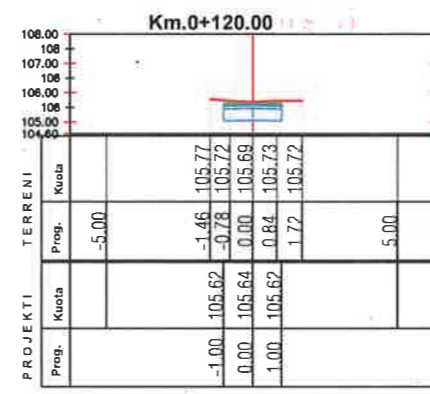
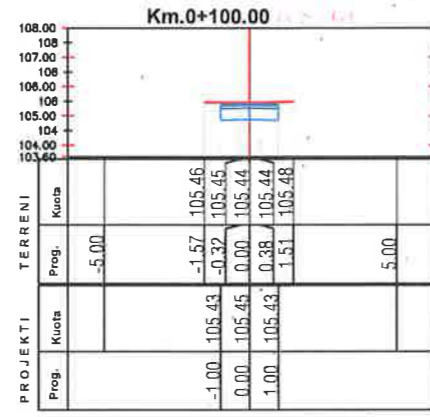
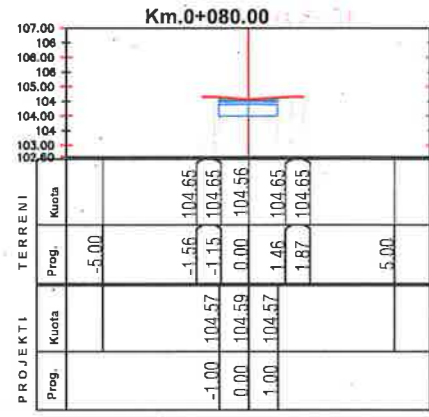
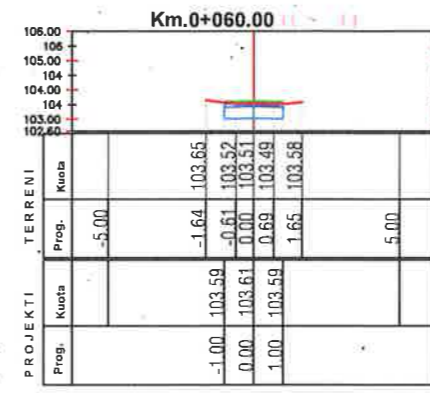
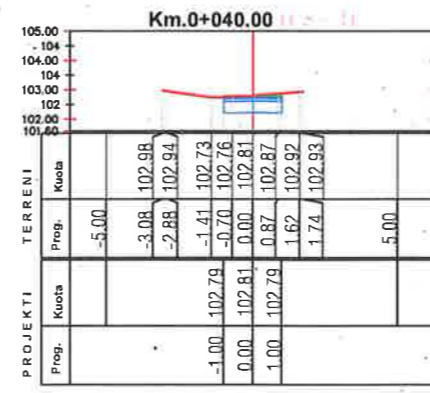
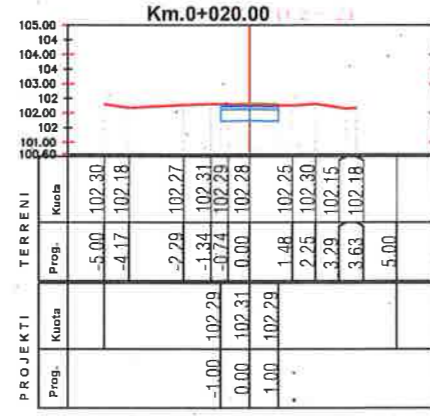
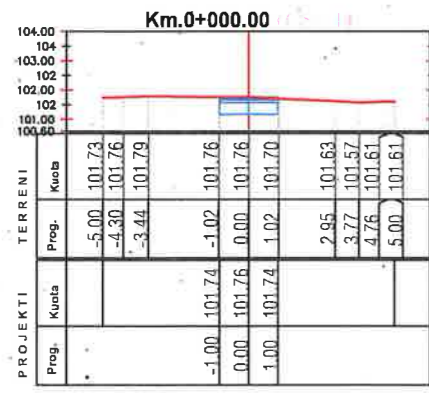
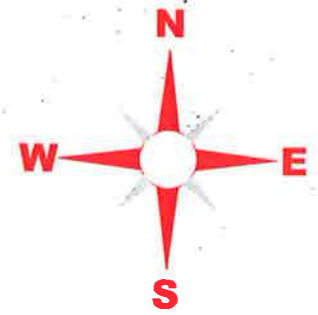

LEGJENDA

- NIVELETA E RRUGES
- TERRENI NATYRAL



BASHKIA KAMEZ

DREJTORIA E PROJEKTEVE DHE INVESTIMEVE
DEPARTAMENTI I PROJEKTEVE

Dr. e Projekteve e Investimeve	RAMADAN HYSA
Pergj. Sektori i Projekteve	DENIS PRENÇI
STAFI TEKNIK	Ing. EMANUELA MËZIU
PROJEKTUES	Ing. ARTUR ÇAJKA
	Ing. ALEKS DANI
	Ing. ARJOLA KURTI

Titulli i Projektit	NDËRTIM RRUGËT "BLOKU PASKUQAN , KAMËZ , BATHORE "	Faza e Projektit	PROJEKT ZBATIMI
Emertimi i Fletes	PROFIELET TËRTHORE	Data e Implementimit :	
		Shkalla e Vizatimit	H 1:250
		Fleta Nr.	23

PROFILE TËRTHORE RRUGA ABDYL FRASHERI

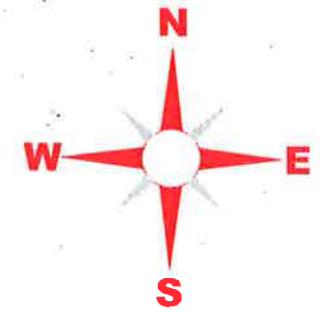
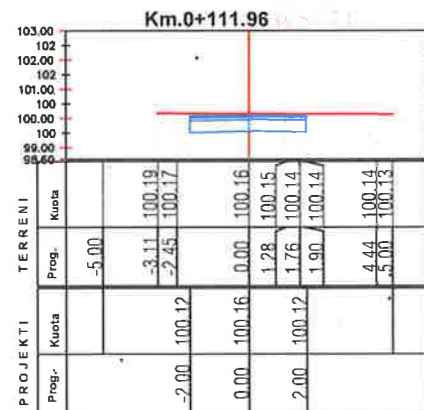
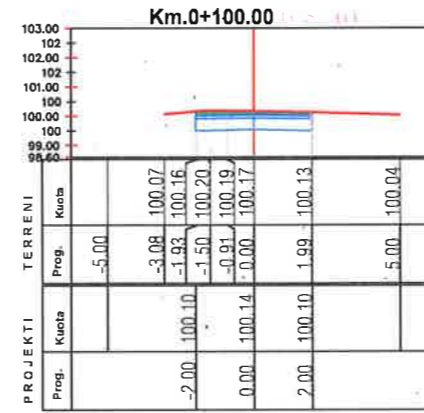
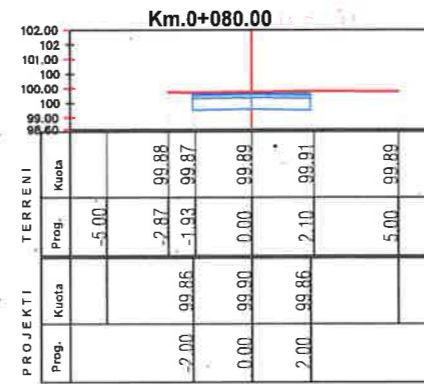
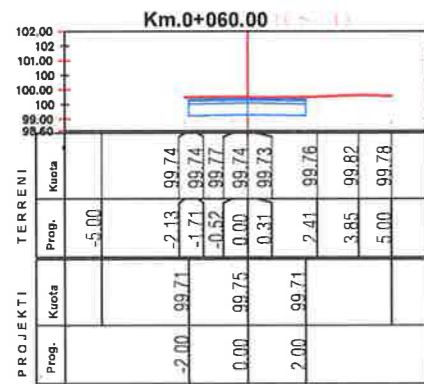
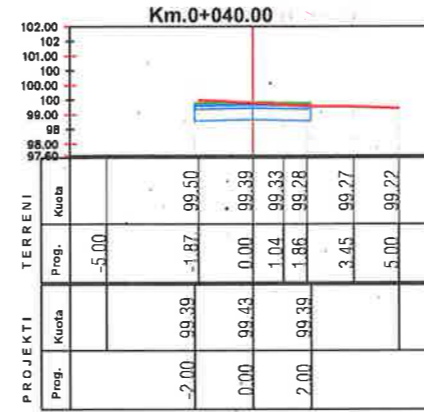
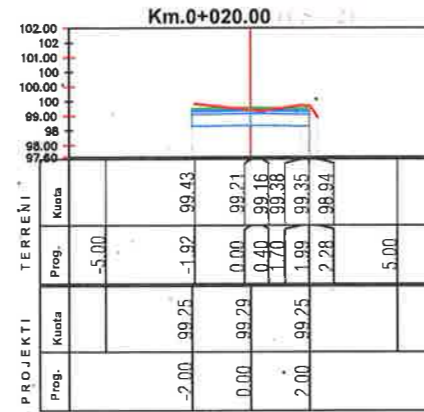
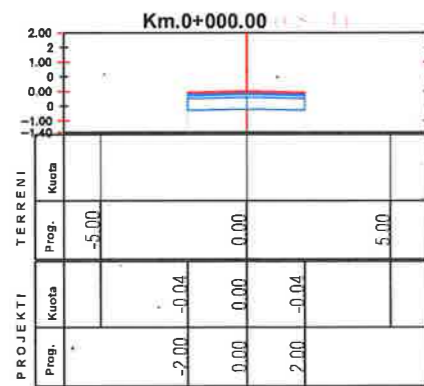

LEGJENDA

- NIVELETA E RRUGES
- TERRENI NATYRAL



BASHKIA KAMEZ

DREJTORIA E PROJEKTEVE DHE INVESTIMEVEVE
DEPARTAMENTI I PROJEKTEVE

Dr. e Projekteve e Investimeve	RAMADAN HYSA	
Pergj. Sektori i Projekteve	DENIS PRENÇI	
STAFI TEKNIK PROJEKTUES	Ing. EMANUELA MËZIU	
	Ing. ARTUR ÇAJKA	
	Ing. ALEKS DANI	
	Ing. ARJOLA KURTI	

Titulli i Projektit	Faza e Projektit
NDËRTIM RRUGËT "BLOKU PASKUQAN , KAMËZ , BATHORE "	PROJEKT.ZBATIMI
Emertimi i Flotes	Data e Implementimit:
PROFILET TËRTHORE	Shkalla e Vizimit:
	H 1:250
	Fieta Nr.
	24

PROFILE TËRTHORE RRUGA SEG PING FAN STILJAN NOLI

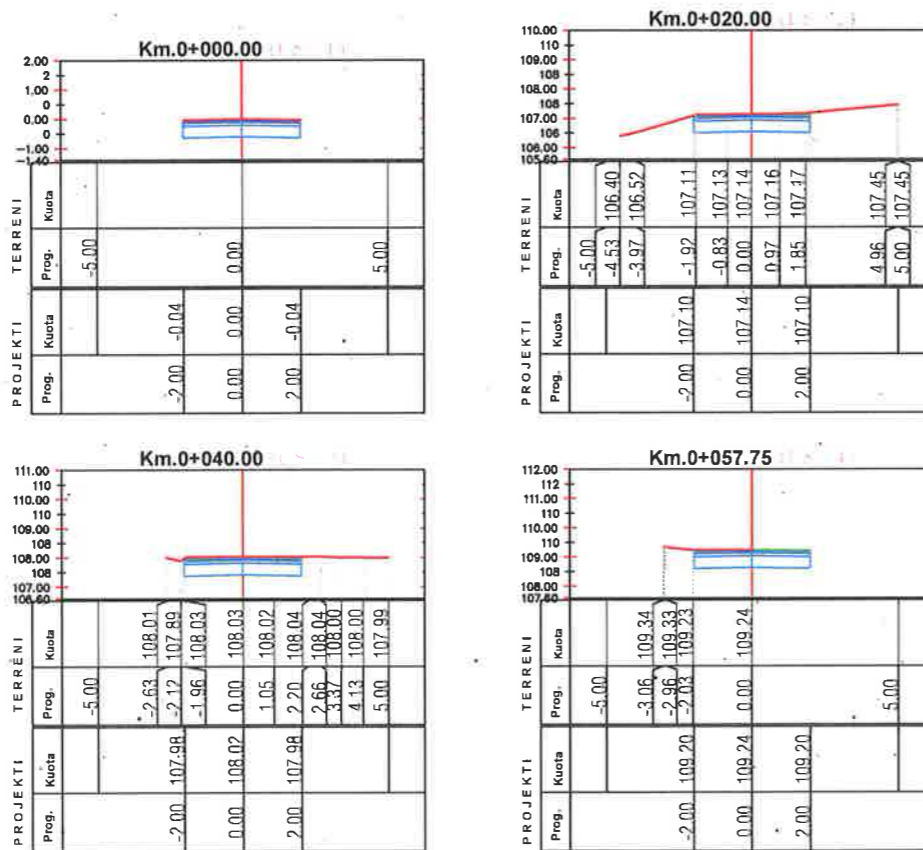
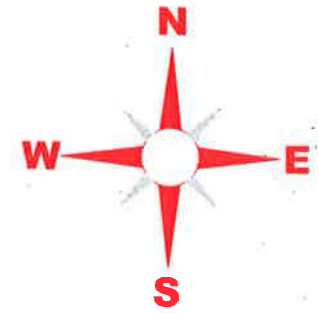

LEGJENDA

- NIVELETA E RRUGES
- TERRENI NATYRAL



BASHKIA KAMEZ

DREJTORIA E PROJEKTEVE DHE INVESTIMEVE
DEPARTAMENTI I PROJEKTEVE

Dr. e Projekteve e Investimeve	RAMADAN HYSA	
Pergj. Sektori i Projekteve	DENIS PRENÇI	
STAFI TEKNIK PROJEKTES	Ing. EMANUELA MËZIU	
	Ing. ARTUR ÇAJKA	
	Ing. ALEKS DANI	
	Ing. ARJOLA KURTI	

Titulli i Projektit
NDËRTIM RRUGËT "BLLÖKU PASKUQAN
, KAMËZ , BATHORE "

Emertimi i Fletes

PROFILET TËRTHORE

Faza e Projektit
PROJEKT ZBATIMI

Data e Implementimit :

Shkalla e Vizatimit
H 1:250

Fleta Nr.

PROFILE TËRTHORE RRUGA PRESOFONI KOKEDHIMA

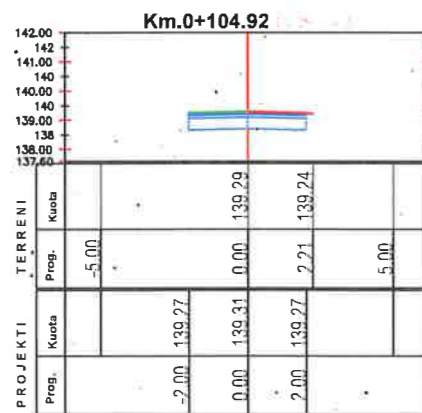
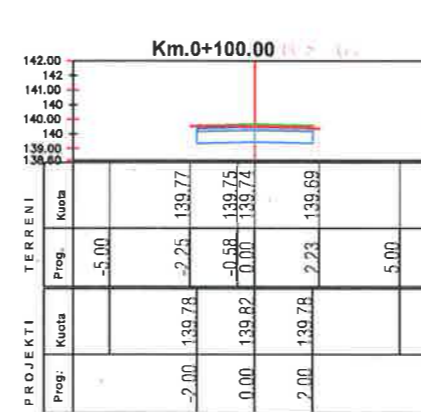
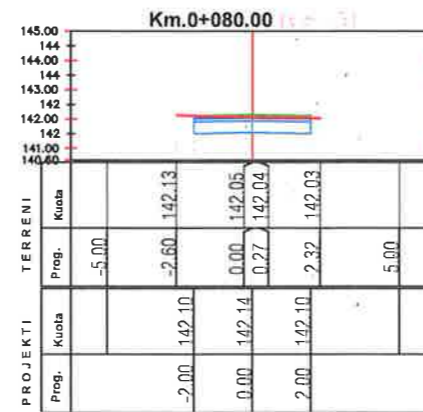
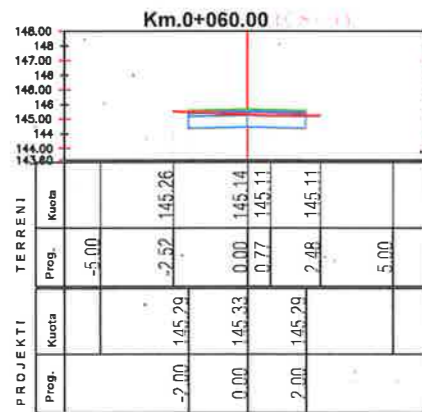
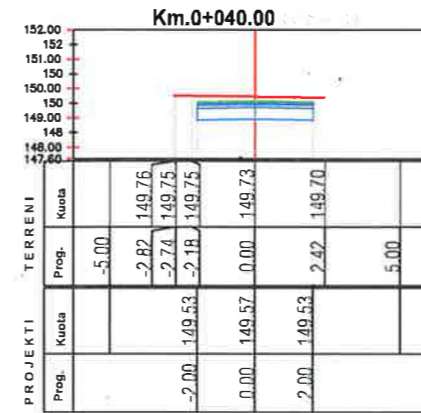
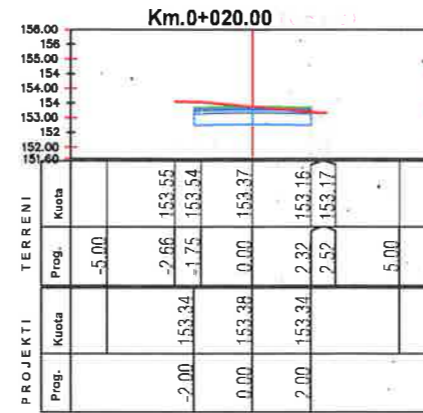
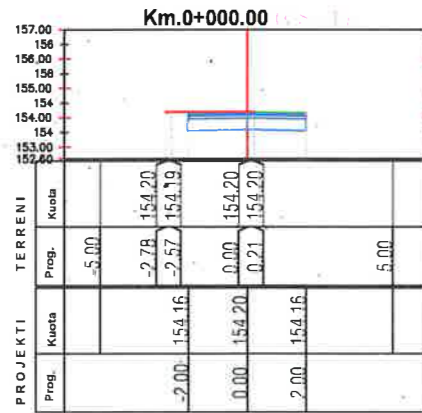
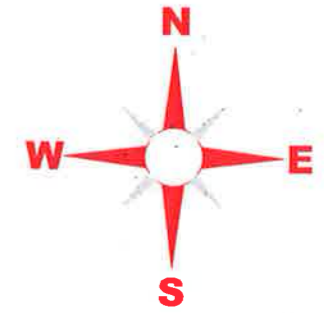

LEGJENDA

- NIVELETA E RRUGES
- TERRENI NATYRAL



BASHKIA KAMEZ

DREJTORIA E PROJEKTEVE DHE INVESTIMEVE
DEPARTAMENTI I PROJEKTEVE

Dr. e Projekteve e Investimeve	RAMADAN HYSA	
Pergj. Sektori i Projekteve	DENIS PRENÇI	
STAFI TEKNIK PROJEKTES	Ing. EMANUELA MËZIU	
	Ing. ARTUR ÇAJKA	
	Ing. ALEKS DANI	
	Ing. ARJOLA KURTI	

Titulli i Projektit
NDËRTIM RRUGËT "BLOKU PASKUQAN
, KAMËZ , BATHORE "

Emertimi i Fletes
PROFILET TËRTHORE

Faza e Projektit
PROJEKT ZBATIMI

Shkalla e Vizatimit
H 1:250

Fleta Nr.
26



BASHKIA KAMËZ

PROJEKT ZBATIMI

OBJEKTI:

NDERTIM RRUGËT BLOKU "PASKUQAN, KAMEZ, BATHORE".

9. PROFILET TËRTHORE TIP

		BASHKIA KAMËZ	
		DREJTORIA E PROJEKTEVE DHE INVESTIMEVE DEPARTAMENTI I PROJEKTEVE	
Dr. e Projekteve e Investimeve		RAMADAN HYSA	
Prgj. Sektori i Projekteve		DENIS PRENÇI	
STAFI TEKNIK PROJEKTES	Ing.	EMANUELA MEZIU	
	Ing.	ARTUR ÇAJKA	
	Ing.	ALEKS DANI	
	Ark.	ARJOLA KURTI	
Titulli i Projektit		Faza e Projektit	
NDËRTIM RRUGËT BLOKU "PASKUQAN, KAMEZ, BATHORE".		PROJEKT ZBATIMI	
Emertimi i Fletës		Data e Implementimit:	
PROFILI TËRTHOR TIP		Shkalla e Vizatimit	
		Fleta Nr.	
		00	

PROFIL TERTHOR TIP 1

OBJEKET: RRUGET SEG. 1 PINGUL IBRAHIM RUGOVA; SEG. 2 PINGUL IBRAHIM RUGOVA; PRESEFONI KOKEDHIMA AKSI 2; ANDOR ZAKO CAJUPI; PINGUL XHEMAL ARANTASI; PINGUL SALII MURAT VRANISHTI; SEG.PINGUL MEDI FRASHERI; SEG. PINGUL MEMO META; PINGUL FAN STILJAN NOLI; SEG. PINGUL HALIT HAXHIA; SEG. 1 PINGUL SADO KOSHENKO; SEG. 2 PINGUL SADO KOSHENKO; PINGUL SKENDERBEU; PINGUL MITHAT FRASHERI; ABDYL ELMAZI; RREZE DRITE; SEG. 1 PINGUL BESELIDHJA; PINGUL AZEM HAJDARI; PINGUL MIQESIA; SEG. 1 PINGUL FAIK KULLA; SEG.2 PINGUL FAIK KULLA

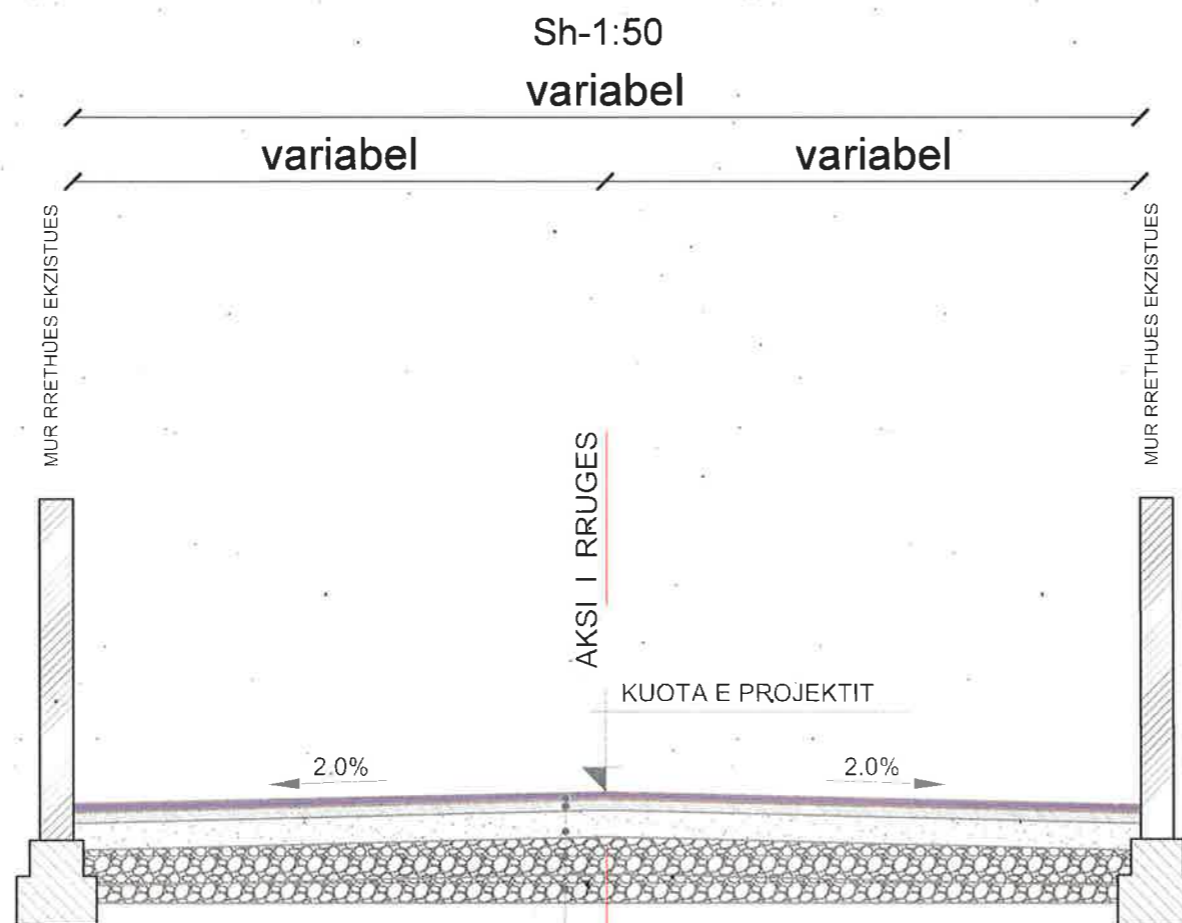

- SHTRESE ASFALTOBETONI 3cm
- SHTRESE BINDERI 5cm
- SHTRESE STABILIZANTI 10cm
- ÇAKELL MAKINERIE 20cm
- CAKELL & GUR GURORE ~20cm

BASHKIA KAMËZ
DREJTORIA E PROJEKTEVE DHE INVESTIMEVE
DEPARTAMENTI I PROJEKTEVE

Dr. e Projekteve e Investimeve RAMADAN HYSA
Prqj. Sektori i Projekteve DENIS PRENÇI

STAFI TEKNIK PROJEKTES	Ing.	EMANUELA MEZIU
	Ing.	ARTUR ÇAJKA
	Ing.	ALEKS DANI
	Ark.	ARJOLA KURTI

Titulli i Projektit	Faza e Projektit
NDËRTIM RRUËT BLOKU "PASKUQAN, KAMEZ, BATHORE".	PROJEKT ZBATIMI
Emerëtimi / Filies	Data e implementimit
PROFILI TERTHOR TIP	Shkalla e Vizatimit
	Fleta Nr.

01

PROFIL TERTHOR TIP 2
PINGUL RRUGA MAHMUT DACI

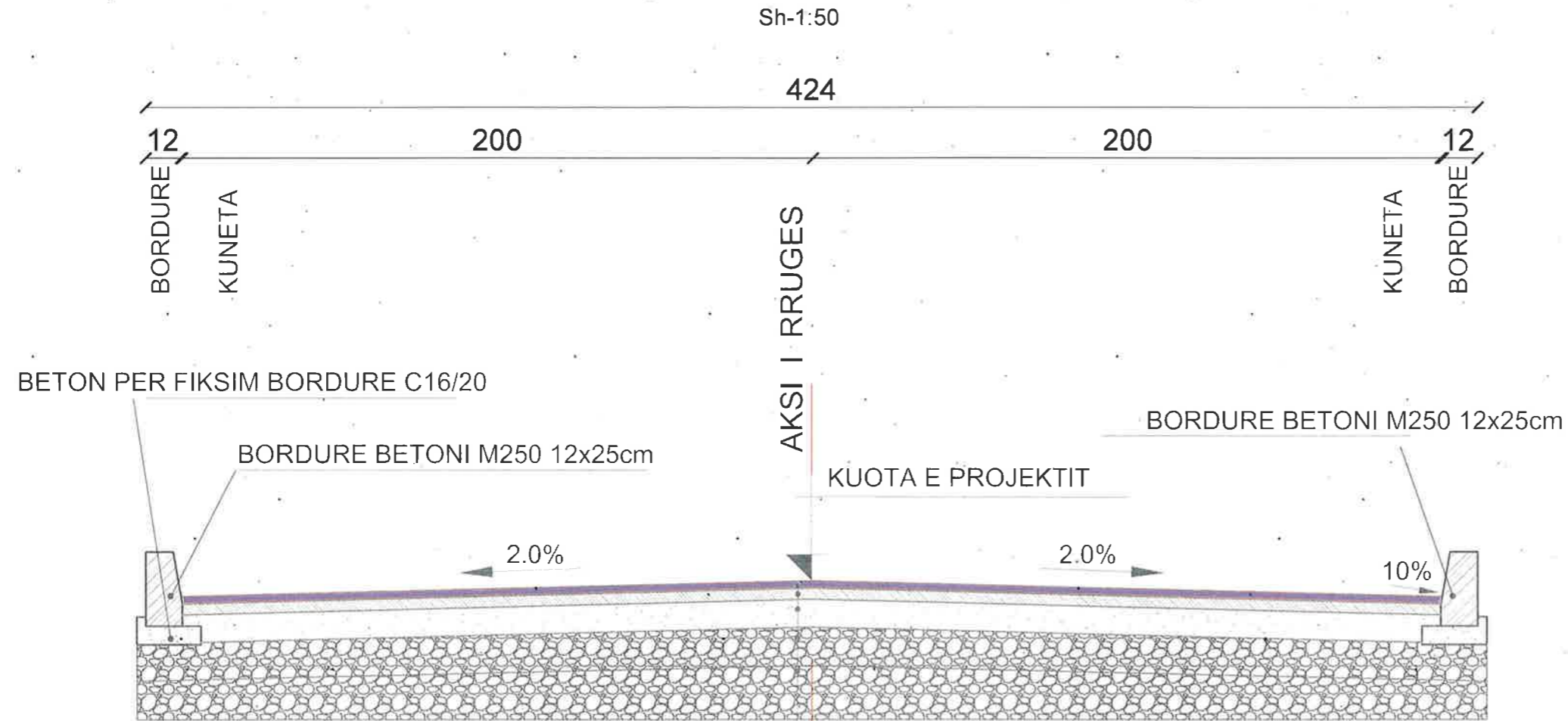

SHTRESE ASFALTOBETONI	3cm
SHTRESE BINDERI	5 cm
SHTRESE STABILIZANTI	10cm
ÇAKELL MAKINERIE	20cm
MBUSHJE ÇAKELL GUR KAVE	

 BASHKIA KAMËZ DREJTORIA E PROJEKTEVE DHE INVESTIMEVE DEPARTAMENTI I PROJEKTEVE			
			Dr. e Projekteve e Investimeve Prgj. Sektori i Projekteve
STAFI TEKNIK PROJEKTES	Ing.	EMANUELA MEZIU	
	Ing.	ARTUR ÇAJKA	
	Ing.	ALEKS DANI	
	Ark.	ARJOLA KURTI	
Titulli i Projektit		Faza e Projektit	
NDËRTIM RRUGËT BLOKU "PASKUQAN, KAMEZ, BATHORE".		PROJEKT ZBATIMI	
Emertimi i Fletes		Data e Implementimit :	
PROFILI TËRTHOR TIP		Shkalla e Vizimit	
		Fleta Nr.	
		02	

PROFIL TERTHOR TIP 3
NDERTIM RRUGA FAN STILJAN NOLI

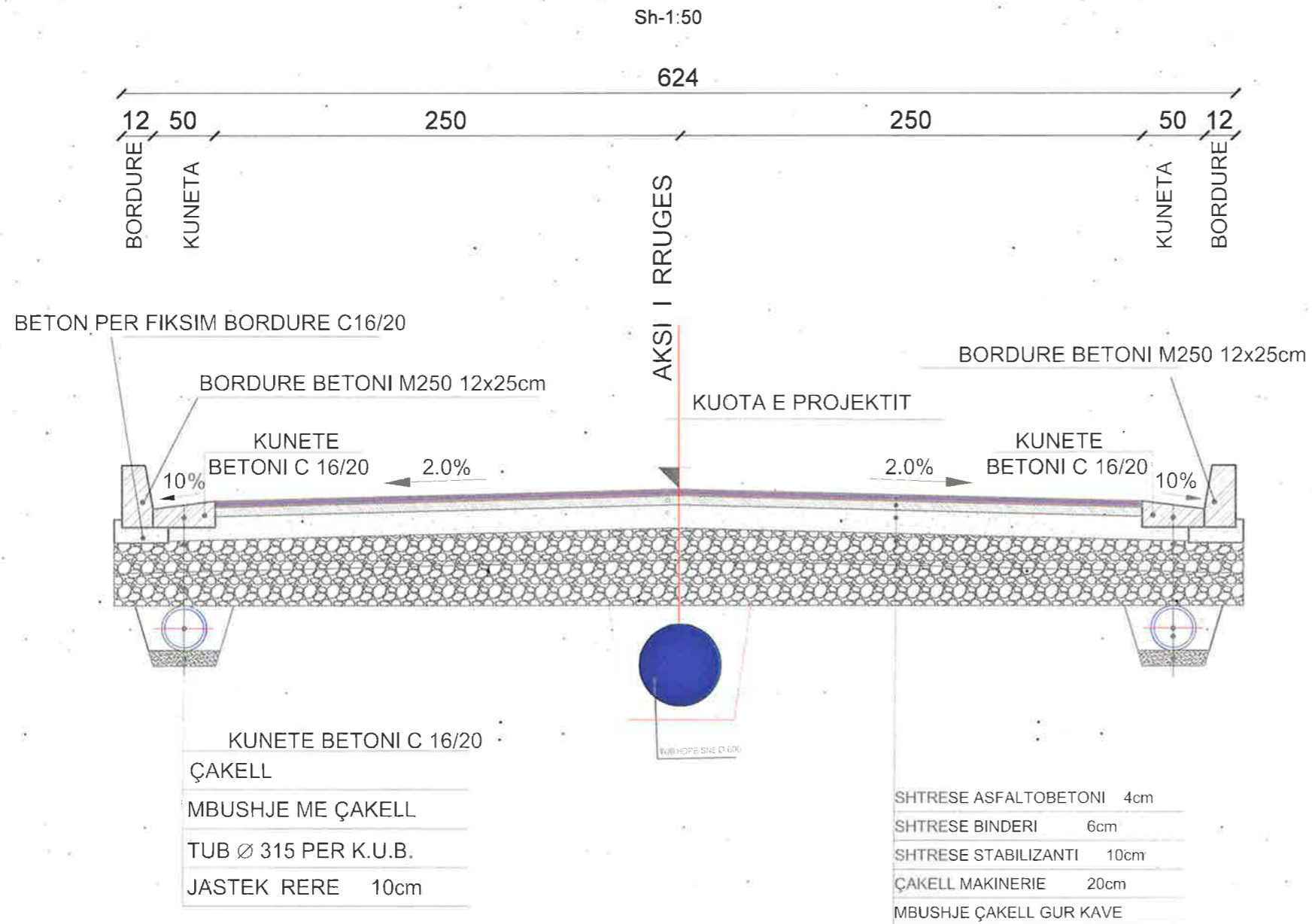

BASHKIA KAMËZ

DREJTORIA E PROJEKTEVE DHE INVESTIMEVE
DEPARTAMENTI I PROJEKTEVE

Dr. e Projekteve e Investimeve	RAMADAN HYSA	<i>[Signature]</i>
Prgj. Sektori i Projekteve	DENIS PREÇI	<i>[Signature]</i>

STAFI TEKNIK PROJEKTUES	Ing.	EMANUELA MEZIU	<i>[Signature]</i>
	Ing.	ARTUR ÇAJKA	
	Ing.	ALEKS DANI	
	Ark.	ARJOLA KURTI	

Titulli i Projektit	Faza e Projektit
NDËRTIM RRUGËT BLOKU "PASKUQAN, KAMEZ, BATHORE".	PROJEKT ZBATIMI
Emeritimi i Fietes	Data e Implementimit :
PROFILI TËRTHOR TIP	Shkalla e Vizatimit
	Fleta Nr.
	03

PROFIL TERTHOR TIP 4
NDERTIM RRUGA "PINGUL ZIJA KOMBO"

Sh-1:50

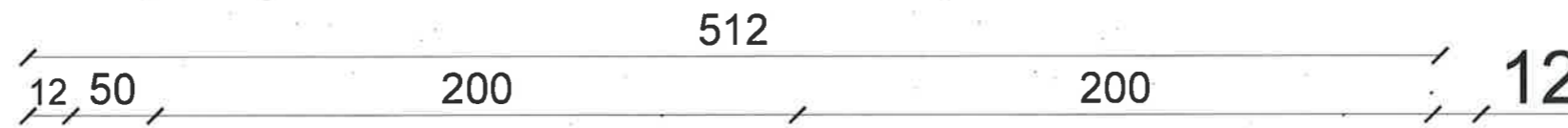

AKSI I RRUGES

BETON PER FIKSIM BORDURE C16/20

BORDURE BETONI M250 12x25cm

KUOTA E PROJEKTIT

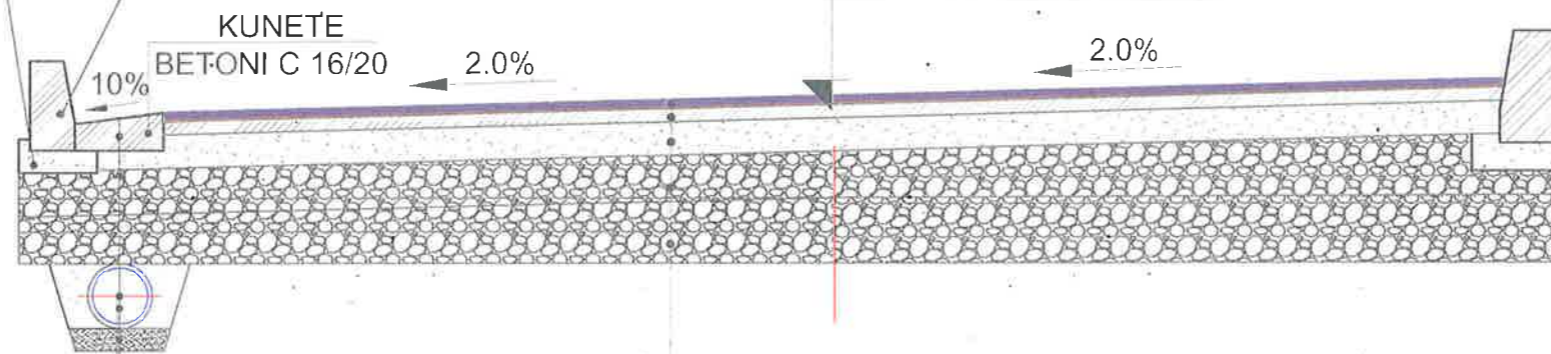

KUNETE
BETONI C 16/20

KUNETE BETONI C 16/20
ÇAKELL
TUB Ø 315 PER K.U.B.
MBUSHJE ME ÇAKELL
JASTEK RERE 10cm

SHTRESE ASFALTOBETONI 3cm
SHTRESE BINDERI 5cm
SHTRESE STABILIZANTI 10cm
ÇAKELL MAKINERIE 20cm
MBUSHJE ÇAKELL GUR KAVE

BASHKIA KAMËZ
DREJTORIA E PROJEKTEVE DHE INVESTIMEVE
DEPARTAMENTI I PROJEKTEVE

Dr. e Projekteve e Investimeve RAMADAN HUSA
Prgj. Sektori i Projekteve DENIS PRENÇI

STAFI TEKNIK
PROJEKTES
Ing. EMANUELA MEZIU
Ing. ARTUR ÇAJKA
Ing. ALEKS DANI
Ark. ARJOLA KURTI

Titulli i Projektit
NDËRTIM RRUGËT BLOKU
"PASKUQAN, KAMEZ, BATHORE".
Emertimi i Fietes
PROFILI TËRTHOR TIP-

Faza e Projektit
PROJEKT ZBATIMI
Data e Implementimit :
Shkalla e Vizatimit
Fleta Nr.
04

PROFIL TËRTHOR TIP 5
RIKONSTRUKSION RRUGA OSBE AKI 2 DHE BESELIDHJA AKSI 2

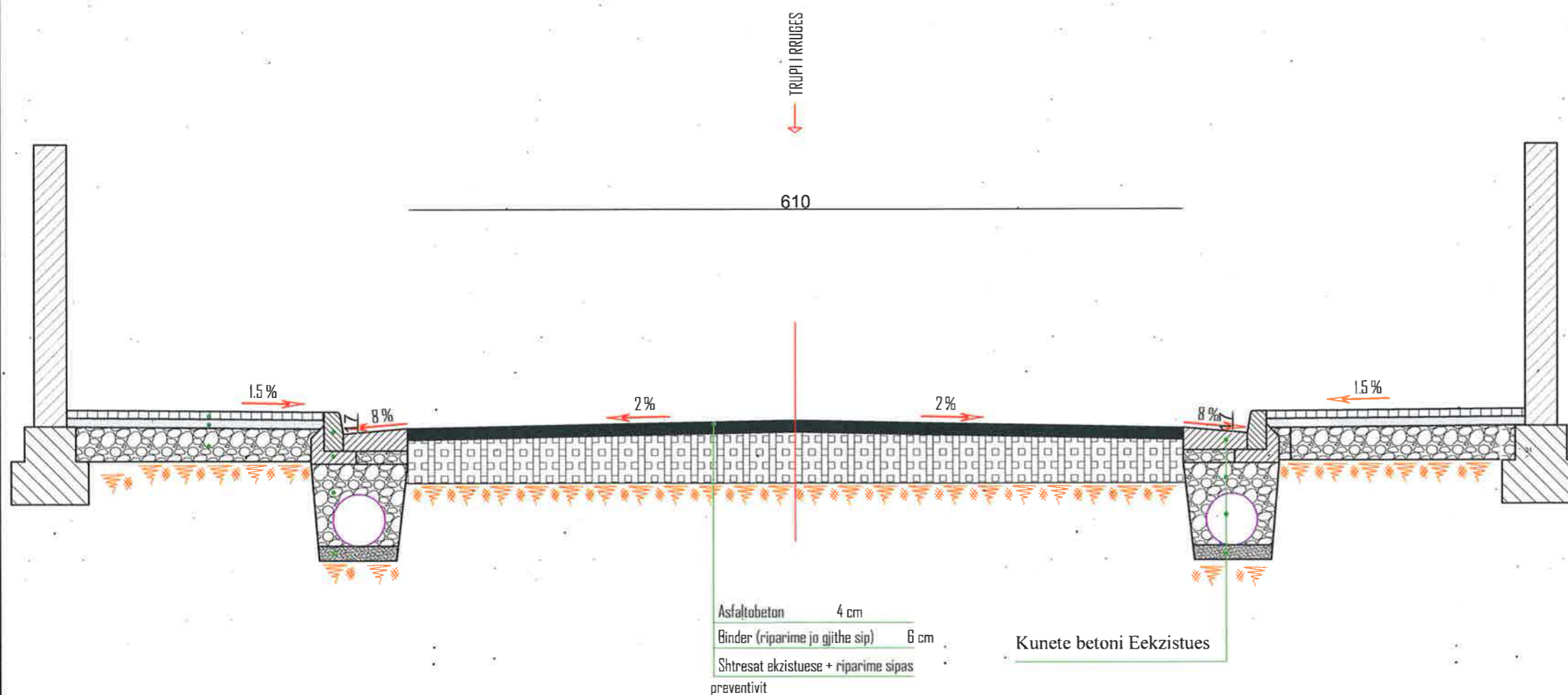

BASHKIA KAMËZ
DREJTORIA E PROJEKTEVE DHE INVESTIMEVE
DEPARTAMENTI I PROJEKTEVE

Dr. e Projekteve e Investimeve RAMADAN HYSA
Prgj. Sektori i Projekteve DENIS PRENCI

STAFI TEKNIK
PROJEKTES
Ing. EMANUELA MEZIU
Ing. ARTUR ÇAJKA
Ing. ALEKS DANI
Ark. ARJOLA KURTI

Titulli i Projektit
NDËRTIM RRUGËT BLOKU
"PASKUQAN, KAMEZ, BATHORE".
Emertimi i Fietes
PROFILI TËRTHOR TIP

Faza e Projektit
PROJEKT ZBATIMI
Data e implementimit :
Shkalla e Vizatimit
Fleta Nr.
05

PROFIL TERTHOR TIP 6
RIKONSTRUKSION RRUGA NENE TEREZA

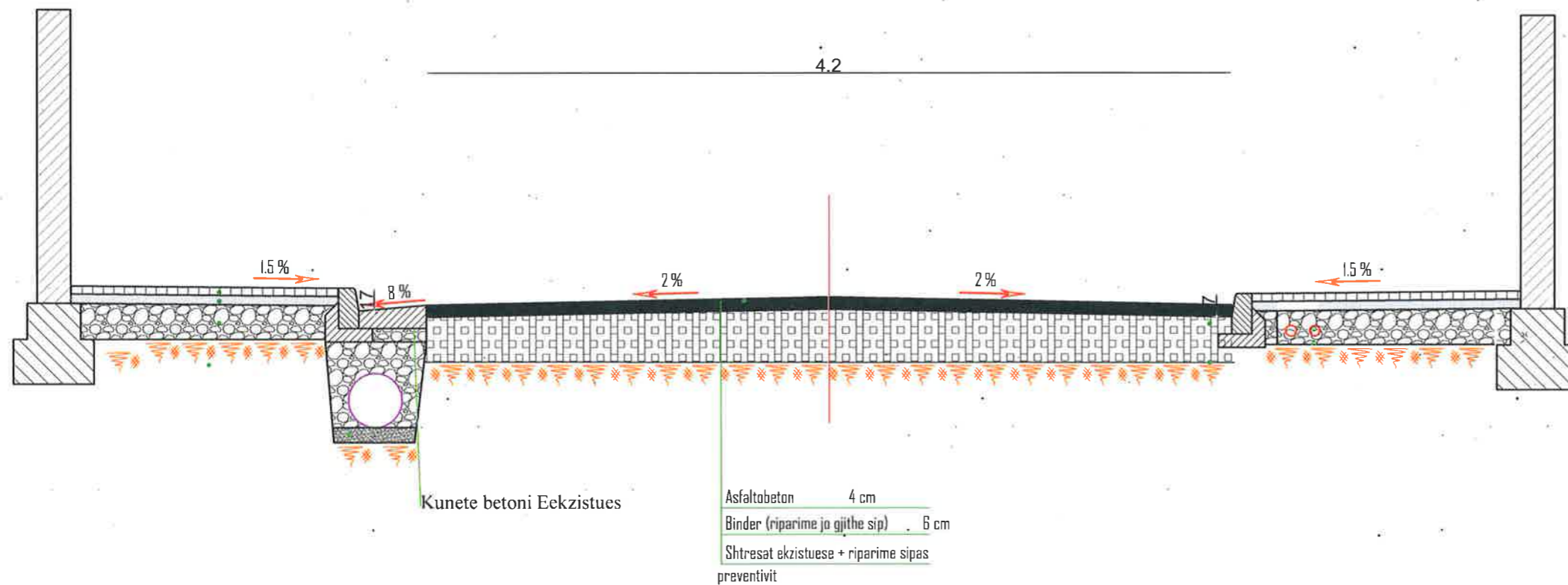

BASHKIA KAMËZ
DREJTORIA E PROJEKTEVE DHE INVESTIMEVE
DEPARTAMENTI I PROJEKTEVE

Dr. e Projekteve e Investimeve RAMADAN HYSA
Prgj. Sektori i Projekteve DENIS PRENÇI

STAFI TEKNIK I PROJEKTES	Ing.	EMANUELA MEZIU	
	Ing.	ARTUR ÇAJKA	
	Ing.	ALEKS DANI	
	Ark.	ARJOLA KURTI	

Titulli i Projektit
NDËRTIM RRUGËT BLOKU
"PASKUQAN, KAMEZ, BATHORE".

Faza e Projektit
PROJEKT ZBATIMI

Data e Implementimit:

Shkalla e Vizimit

Emertimi i Fieses
PROFILI TËRTHOR TIP

Fleta Nr.

06

PROFIL TERTHOR TIP 7
RRUGA AZEM GALICA

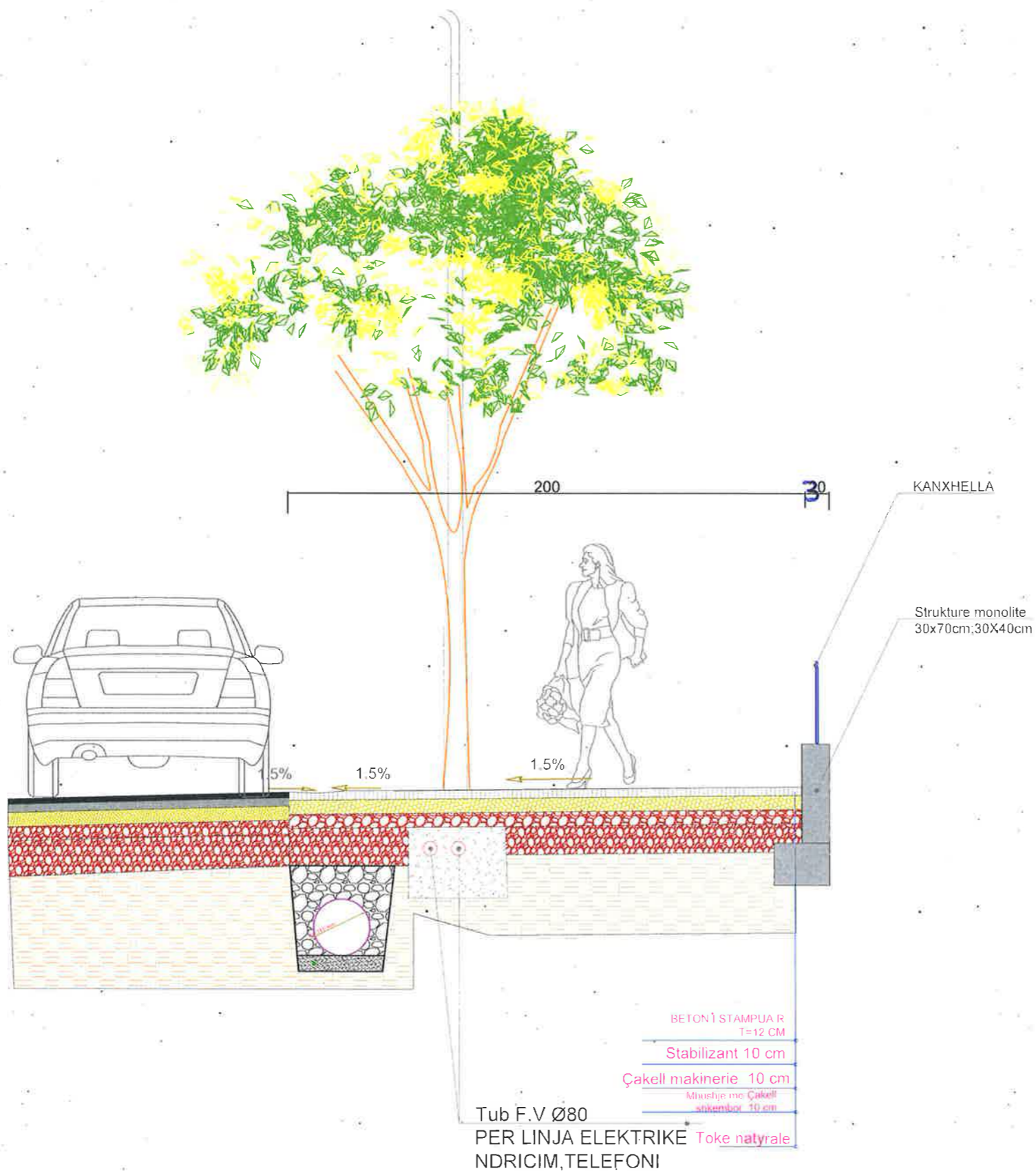

BASHKIA KAMËZ
DREJTORIA E PROJEKTEVE DHE INVESTIMEVE
DEPARTAMENTI I PROJEKTEVE

Dr. e Projekteve e Investimeve	RAMADAN HYSA	<i>[Signature]</i>
Prgj. Sektori i Projekteve	DENIS PRENÇI	<i>[Signature]</i>

STAFI TEKNIK PROJEKTES	Ing.	EMANUELA MEZIU	<i>[Signature]</i>
	Ing.	ARTUR ÇAJKA	
	Ing.	ALEKS DANI	
	Ark.	ARJOLA KURTI	

Titulli i Projektit	Faza e Projektit
NDËRTIM RRUGËT BLOKU "PASKUQAN, KAMEZ, BATHORE"	PROJEKT ZBATIMI
Emertimi i Fletes	Data e Implementimit :
PROFILI TËRTHOR TIP	Shkalla e Vizatimit
	Fieta Nr.
	07

PROFIL TERTHOR TIP 7/1
RRUGA AZEM GALICA

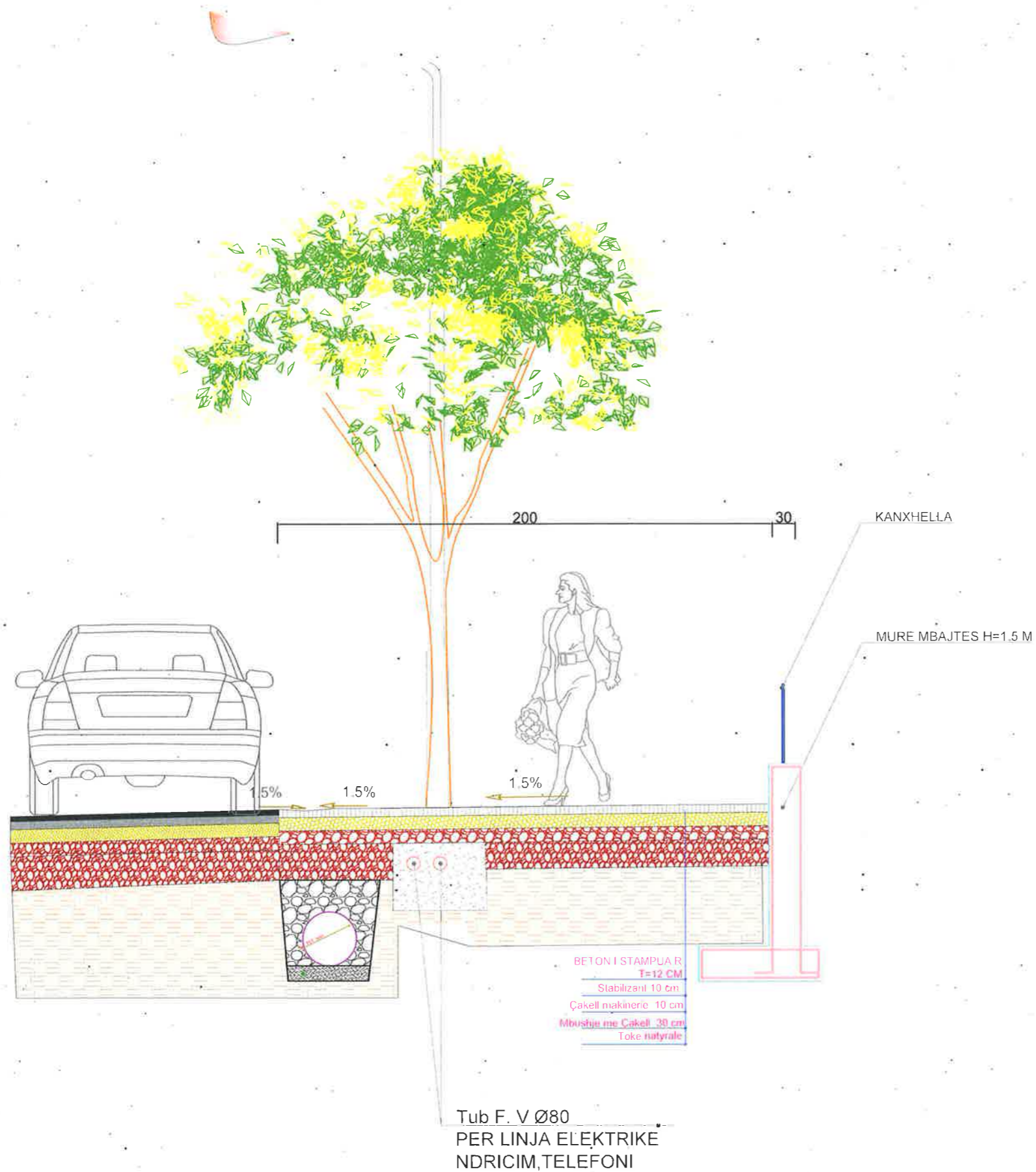

BASHKIA KAMËZ
DREJTORIA E PROJEKTEVE DHE INVESTIMEVE
DEPARTAMENTI I PROJEKTEVE

Dr. e Projekteve e Investimeve	RAMADAN HYSA	
Prgj. Sektori i Projekteve	DENIS PRENÇI	

STAFI TEKNIK PROJEKTES	Ing.	EMANUELA MEZIU	
	Ing.	ARTUR ÇAJKA	
	Ing.	ALEKS DANI	
	Ark.	ARJOLA KURTI	

Titulli i Projektit	Faza e Projektit
NDËRTIM RRUGËT BLOKU "PASKUQAN, KAMEZ, BATHORE".	PROJEKT ZBATIMI
Emertimi i Fletes	Data e Implementimit :
PROFILI TËRTHOR TIP	Shkalla e Vizatimit
	Fleta Nr.
	07/1

PROFIL TËRTHOR TIP 8 PEDONALE LIQENI I PASKUQANIT

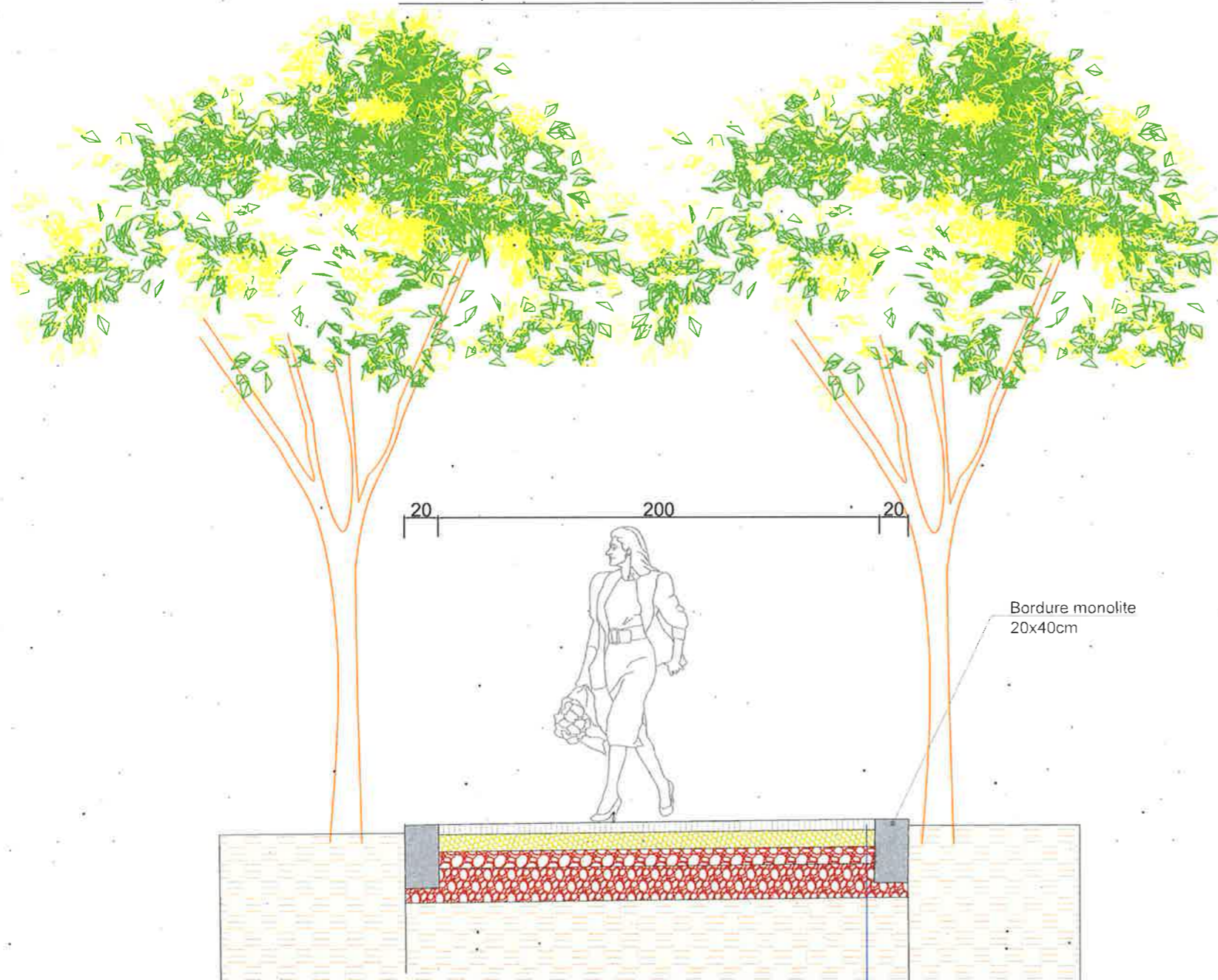

Bordure monolite
20x40cm

BETON I STAMPUA R
T=12 CM
Stabilizant 10 cm
Çakell makinerie 10 cm
Mbushje me Çakell 20 cm
Toke natyrale

BASHKIA KAMËZ
DREJTORIA E PROJEKTEVE DHE INVESTIMEVE
DEPARTAMENTI I PROJEKTEVE

Dr. e Projekteve e Investimeve	RAMADAN HYSA	[Signature]
Prgj. Sektori i Projekteve	DENIS PRENCI	[Signature]

STAFI TEKNIK PROJEKTUES	Ing.	EMANUELA MEZIU	[Signature]
	Ing.	ARTUR ÇAJKA	
	Ing.	ALEKS DANI	
	Ark.	ARJOLA KURTI	

Titulli i Projektit	Faza e Projektit
NDËRTIM RRUGËT BLOKU "PASKUQAN, KAMEZ, BATHORE".	PROJEKT ZBATIMI
Emertimi i Fietes	Data e Implementimit :
PROFILI TËRTHOR TIP.	Shtalla e Vizatimit
	Fleta Nr.

08



BASHKIA KAMËZ

PROJEKT ZBATIMI

OBJEKTI:

NDËRTIM RRUGËT "BLLOKU PASKUQAN, KAMEZ, BATHORE"

DETAJE



BASHKIA KAMËZ

DREJTORIA E PROJEKTEVE DHE INVESTIMEVE
DEPARTAMENTI I PROJEKTEVE

Dr. e Projekteve e Investimeve	RAMADAN HYSA
Përgj. Sekt. i Projekteve	DENIS PRENÇI
STAFI TEKNIK PROJEKTES	Ing. EMANUELA MËZIU
	Ing. ARTUR ÇAJKA
	Ing. ALEKS DANI
	Ark. ARJOLA KURTI

Titulli i Projektit
NDËRTIM RRUGËT "BLLOKU
PASKUQAN, KAMEZ,
BATHORE"

Emertimi i Fletës

DETAJET

Fjala e Projektit
PROJEKT ZBATIMI

Data e Implementimit

Shkalla e Vizimit

Fleta Nr.

KAPAKU

DETAJE KUB

PLANI I PUSETES KUSH
SH- 1:25

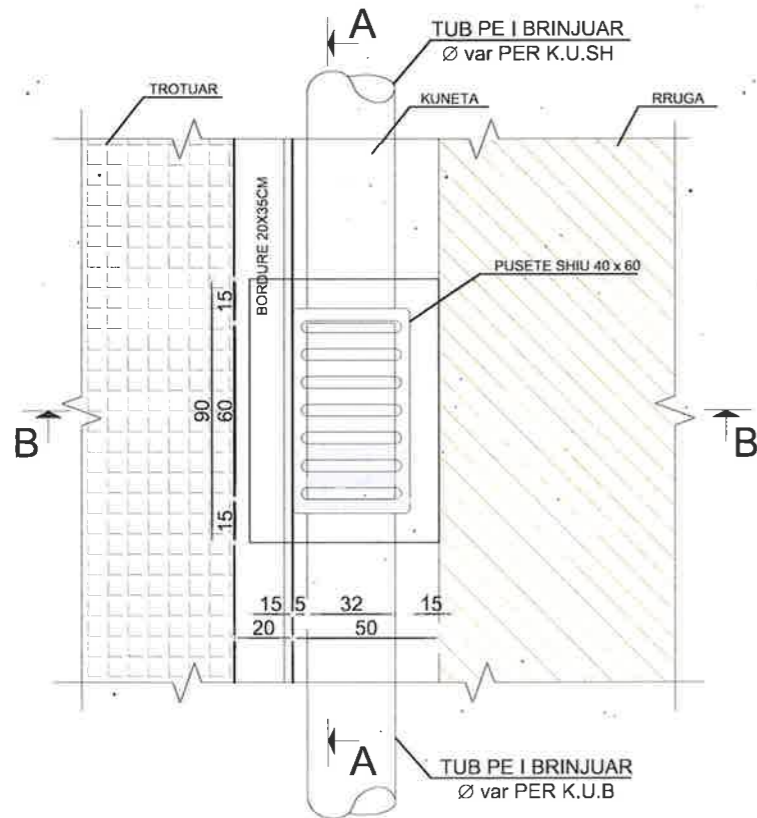

PRERJE B-B
(PER TUBA HDPE D=315MM)
SH- 1:25

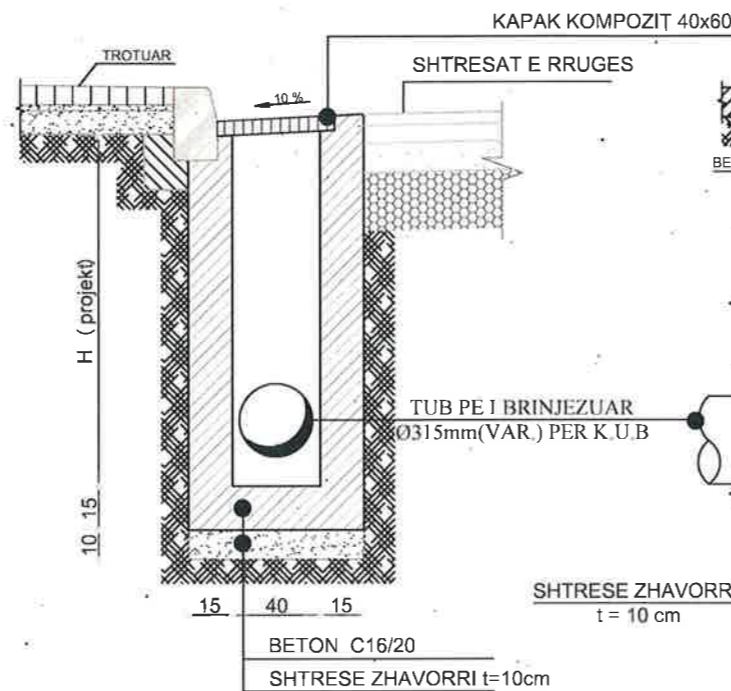

PRERJE A-A
SH- 1:25

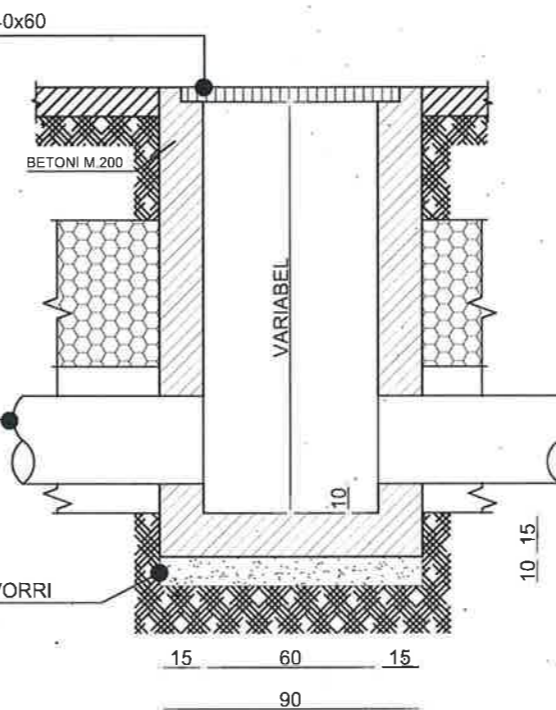

ZGARE GIZE 40X60cm
SH- 1:25

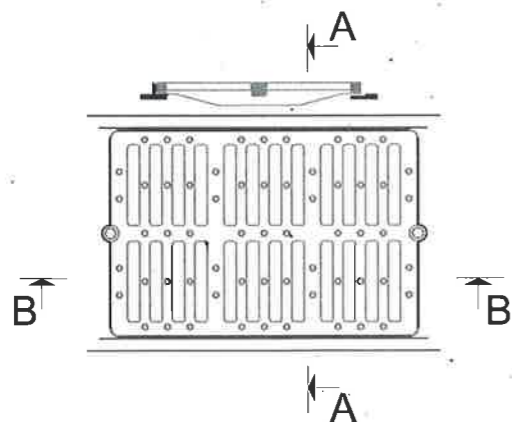

PRERJE A-A



PRERJE B-B

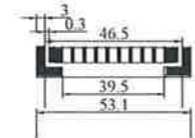

SHËNIME TEKNIKE :

- Muret e pusetes do te jene beton C16/20 dhe me trashesi 15cm.
- Telajo e kapakut do te jete gize i inkastruar me brezin e betonit dhe i vendosur ne nivelin e mbaruar te rruges sipas projektit.
- Fundi i tubit duhet te jete 10cm nga fundi i pusetes.
- Diametri i tubit do te jete sipas projektit ne plan.

- NE KETE FLETE JANE PARAQITUR DETAJET E NDERTIMIT TE PUSETES SE MBLEDHJES SE UJRAVE TE SHIUT TIP 60 x40 cm ME KAPAK GIZE.TIPI P-I. KETO LLOJ PUSETASH DO TE NDERTOHEN NE TE DY ANET E RRUGES NE DISTANCEN SIKUNDER JËPËT NE PLANIMETRINE E KANALIZIMIT TE UJRAVE TE SHIUT.
- ZGARA KOMPOZITE TE JETE E FIKSUAR ME MENTESHE NE SKATULL, NDERSA KJO E FUNDIT DUHET TE JETE FIKSUAR MIRE NE BETON PER TE MOS U VJEDHUR.

SHENIME TEKNIKE

- NE KETE FLETE PROJEKTI ESHTË DHENË SEKSIONI MINIMAL PËR GERMINËN E KANALEVE PËR KULLIMIN E UJRAVE TE SHIUT PËR KATESISHT PËR TUBA ME D_j=315 mm, PËR D_j=400 mm dhe pËr D_j=500mm. ESHTË KUSHT PËR MBROJTJEN E TUBAVE NGA KALIMI I MJETEVE NE RRUGE QE TRASHESIA E MBUSHJEVE MBI TUB TE JETE JO ME PAK SE 80 cm. ATJE KU KJO TRASHESIA NUK REALIZOHET DUHET QE TE NDERTOHEJ NJE SHTRESE BETONI ME TRASHESIA 20 cm ARMUAR ME RRJETE HEKURI ME D= 8 mm (20 x20) cm.

BASHKIA KAMËZ
DREJTORIA E PROJEKTEVE DHE INVESTIMEVE
DEPARTAMENTI I PROJEKTEVE

Dr. e Projekteve e Investimeve	RAMADAN HYSA
Përgj. Sekt. i Projekteve	DENIS PRENÇI
STAFI TEKNIK PROJEKTES	Ing. EMANUELA MËZIU Ing. ARTUR ÇAJKA Ing. ALEKS DANI Ark. ARJOLA KURTI

Titulli i Projektit	Faza e Projektit
NDËRTIM RRUGËT "BLLOKU PASKUQAN, KAMEZ, BATHORE"	PROJEKT ZBATIMI
Emertimi i Fletes	Data e Implementimit :
DETAJE KUB	Shkallë e Vizatimit : 1:25
	Fleta Nr. 01

PAMJE E TROTUARIT TE TROTUARIT ME BETON FORME

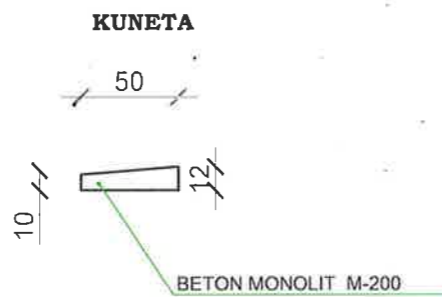
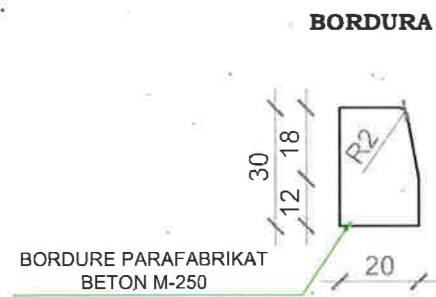
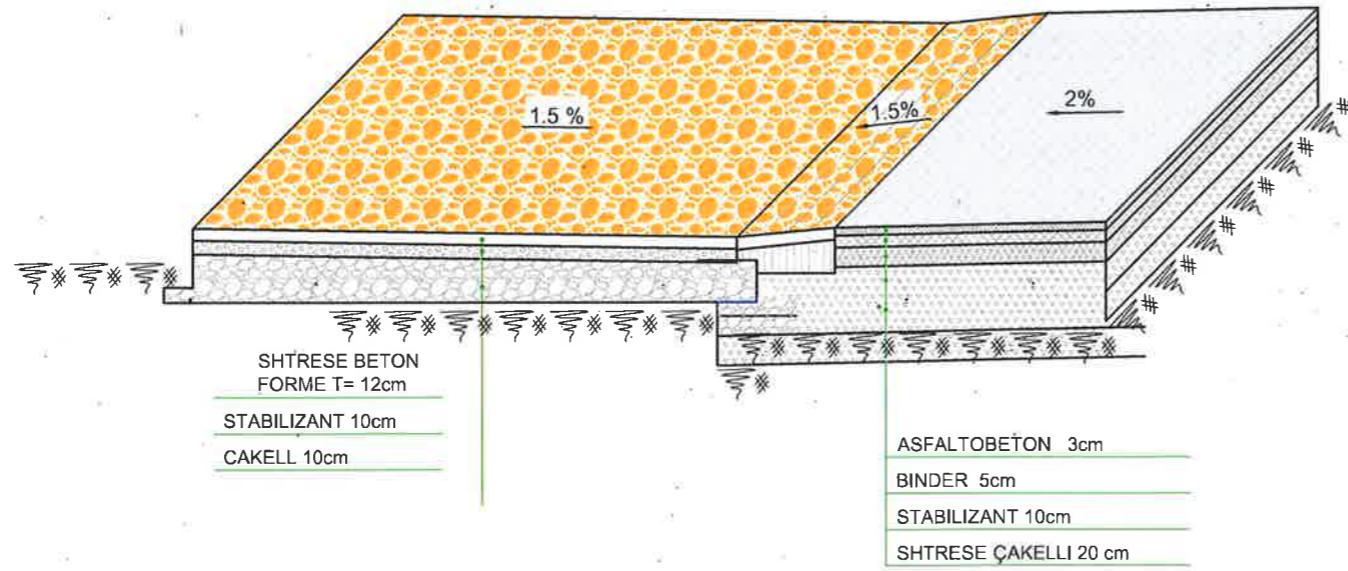

PLANIMETRIA

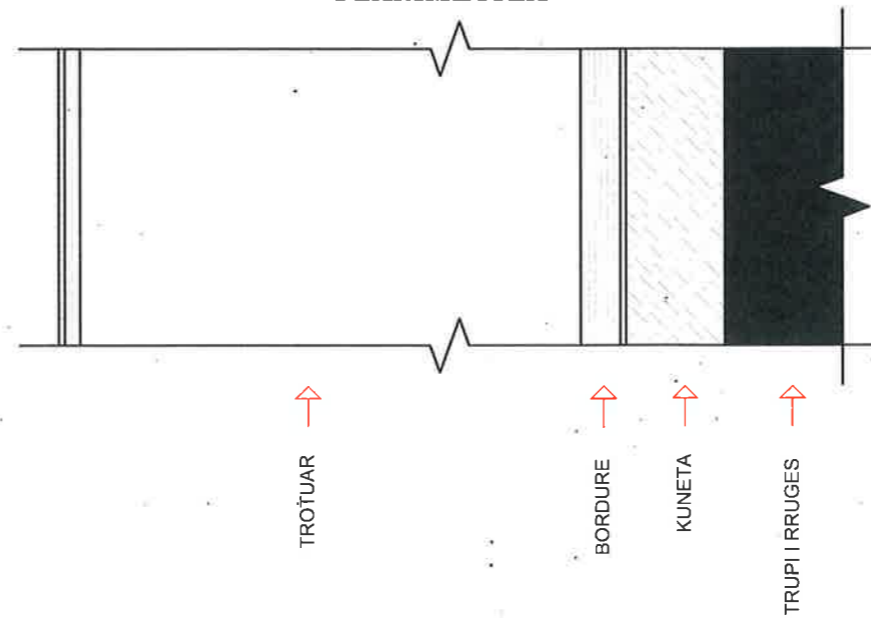

SHENIME :

1. Hapesira midis fugave mbushet me rere.
2. Ne rastet kur trotuari kufizohet me objekte ose mure rrethues, bordura nga ana e jashtme nuk vendoset.

BASHKIA KAMËZ
DREJTORIA E PROJEKTEVE DHE INVESTIMEVE
DEPARTAMENTI I PROJEKTEVE

Dr. e Projekteve e Investimeve	RAMADAN HYSA
Përgj. Sekt. i Projekteve	DENIS PRENÇI
STAFI TEKNIK PROJEKTES	Ing. EMANUELA MËZIU
	Ing. ARTUR ÇAJKA
	Ing. ALEKS DANI
	Ark. ARJOLA KURTI

Titulli i Projektit	NDËRTIM RRUGËT "BLLOKU PASKUQAN, KAMEZ, BATHORE"
Faza e Projektit	PROJEKT ZBATIMI
Data e Implementimit:	
Shkalla e Vizatimit	1:25
Emertimi i Fletes	DETAJE BORDURA DHE TROTUARI
Fleta Nr.	02

DETAJI PANDUSIT

PRERJA A-A SHK.1:50

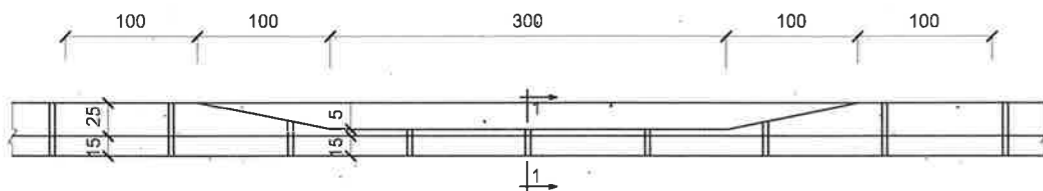

PLAN SHK.1:50

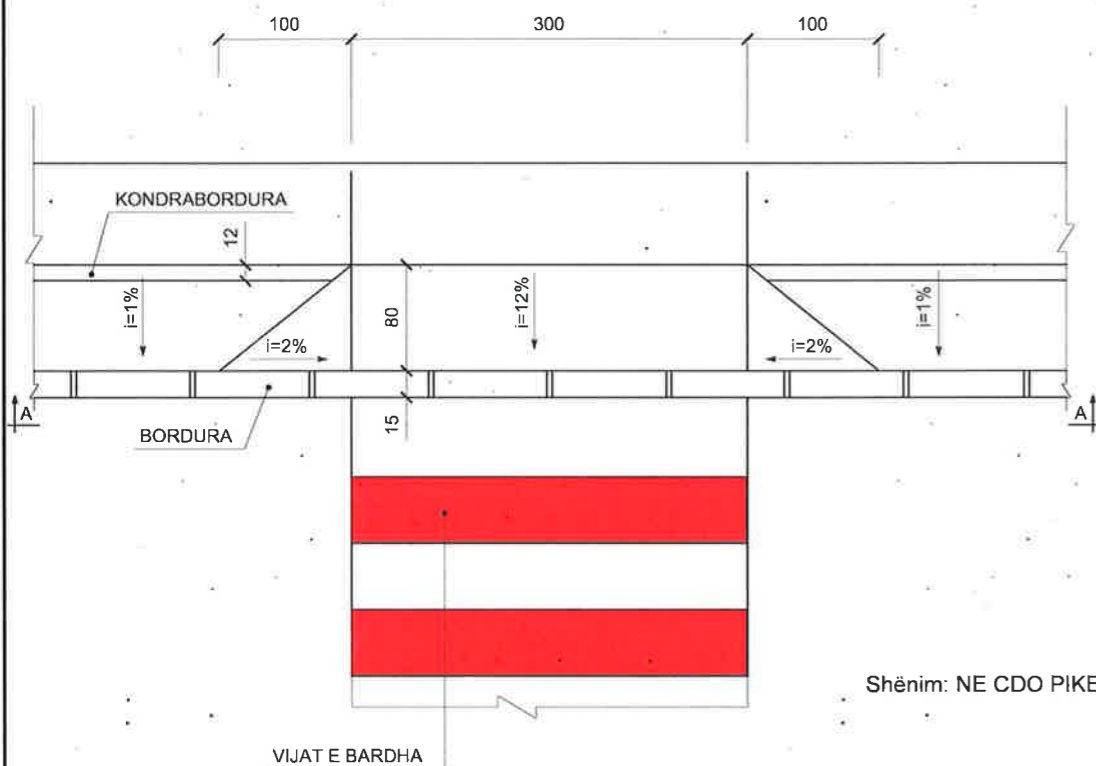

Shënim: NE CDO PIKE KU KRYQEZOHET RRUGA KRYESORE ME RRUGET DYTESORE DO TE VENDOSEN PANDUSET E TROTUAREVE

DETAJI I PRERJES SE RRUGES ME PANDUS Sh 1:15

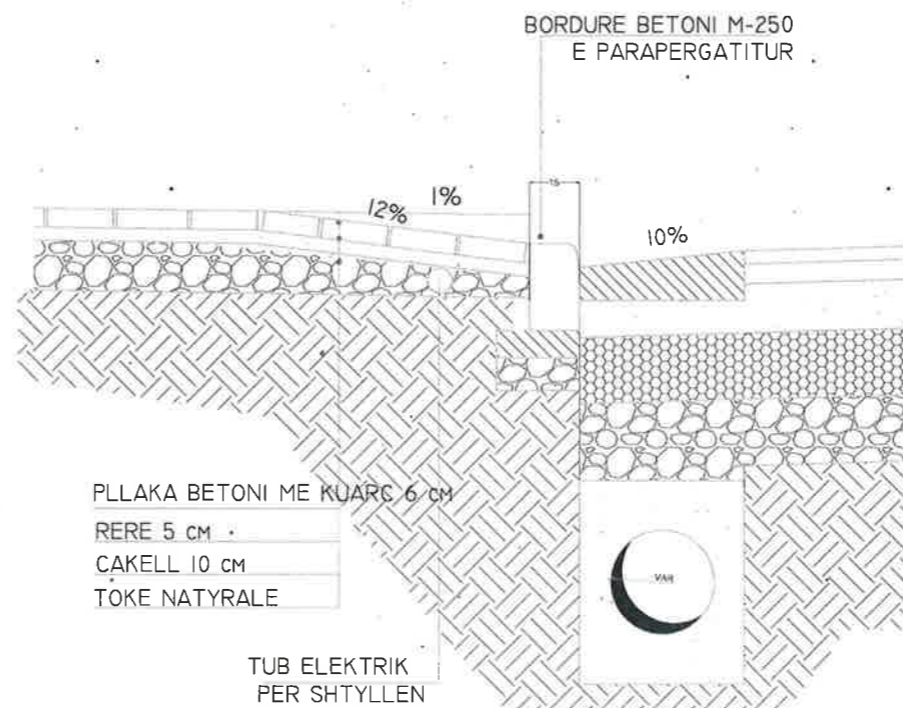



BASHKIA KAMËZ

DREJTORIA E PROJEKTEVE DHE INVESTIMEVE
DEPARTAMENTI I PROJEKTEVE

Dr. e Projekteve e Investimeve	RAMADAN HYSA	
Përgj. Sekt. i Projekteve	DENIS PRENÇI	
STAFI TEKNIK PROJEKTES	Ing. EMANUELA MËZIU	
	Ing. ARTUR ÇAJKA	
	Ing. ALEKS DANI	
	Ark. ARJOLA KURTI	
Titulli i Projektit NDËRTIM RRUGËT "BLOKU PASKUQAN, KAMEZ, BATHORE"		Faza e Projektit PROJEKT ZBATIMI
Emertimi i Fletës DETAJE PANDUSI		Data e Implimitimit: Shkalla e Vizimit 1:25 Fleta Nr. 03

PAMJE PEDONALE

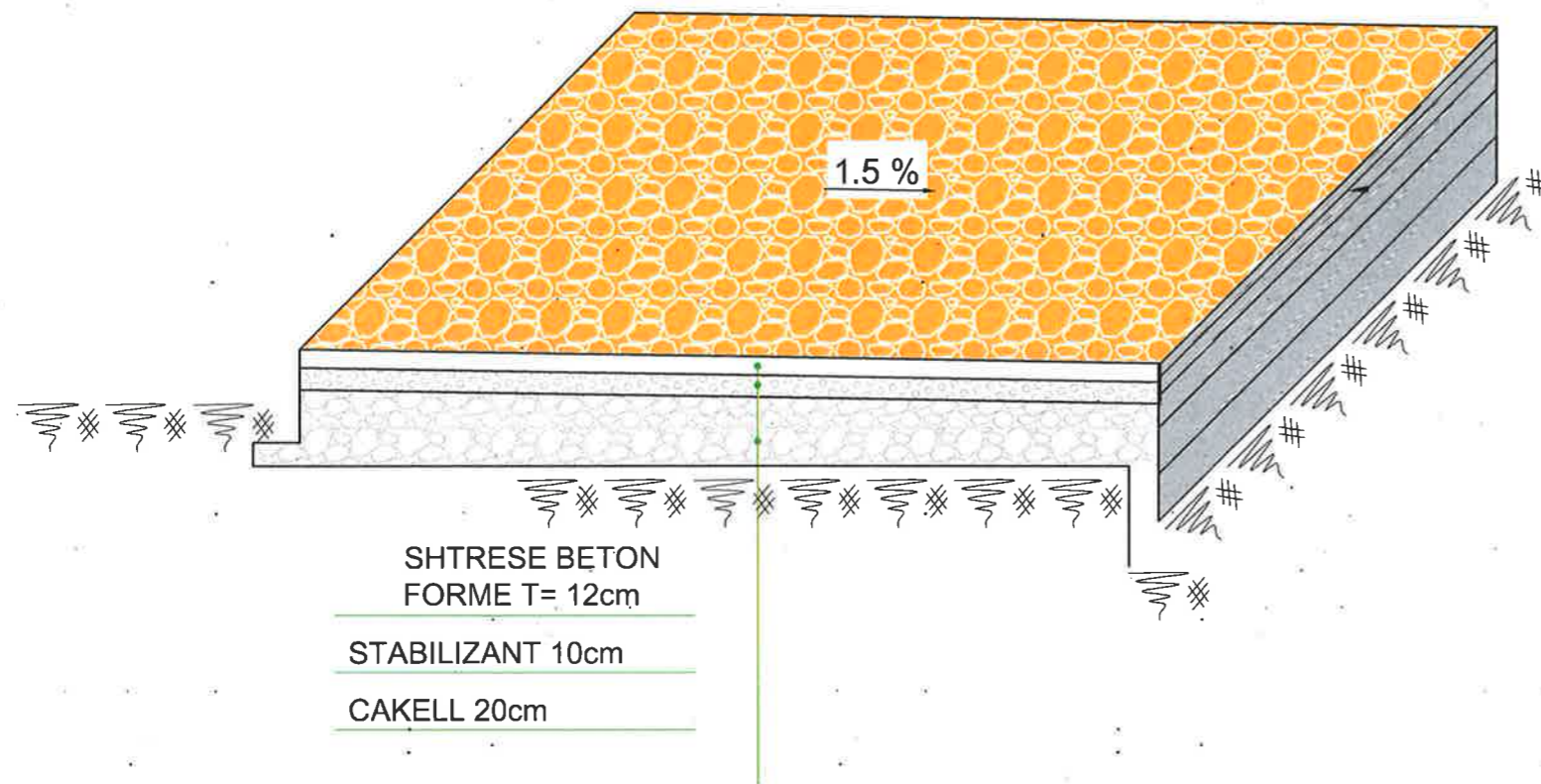

BASHKIA KAMËZ

DREJTORIA E PROJEKTEVE DHE INVESTIMEVE
DEPARTAMENTI I PROJEKTEVE

Dr. e Projekteve e Investimeve	RAMADAN HYSA	<i>[Signature]</i>
Përgj. Sekt. i Projekteve	DENIS PRENÇI	<i>[Signature]</i>
STAFI TEKNIK PROJEKTES	Ing. EMANUELA MËZIU	<i>[Signature]</i>
	Ing. ARTUR ÇAJKA	<i>[Signature]</i>
	Ing. ALEKS DANI	<i>[Signature]</i>
	Ark. ARJOLA KURTI	<i>[Signature]</i>

Titulli i Projektit	Faza e Projektit
NDËRTIM RRUGËT "BLOKU PASKUQAN, KAMEZ, BATHORE"	PROJEKT ZBATIMI
Emeritimi i Fletës	Data e Implementimit :
DETAJE BORDURA DHE TROTUARI	Shkalla e Vizatimit 1:25
	Fleta Nr. 02 (2)

VENDOSJA DHE MONTIMI I SHENJES RRUGORE

SHENJA LAJMERUESE

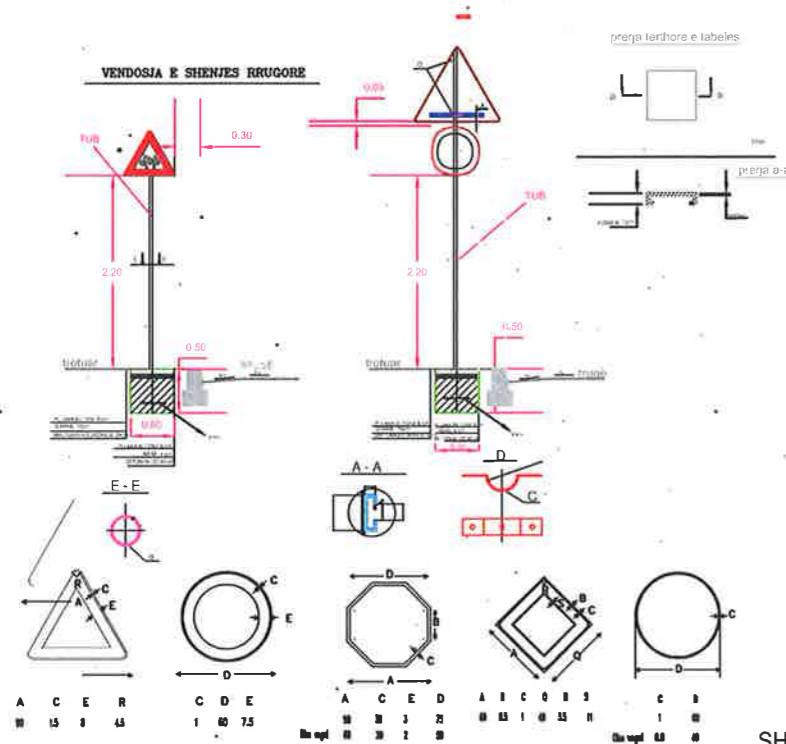

LAJMERIM PER NDERPRERJE NGA RRUGE DYTESORE, KTHESAT E KURBEZUARA, FEMIJET, KEMBESORET DHE PER NDALJE/DHENIE RRUGE

Trekëndeshi: e kuqe reflektuese
Sfondi: i bardhe reflektues
Simboli: i zi

Triangle: red reflective
Background: white reflective
Symbol: black

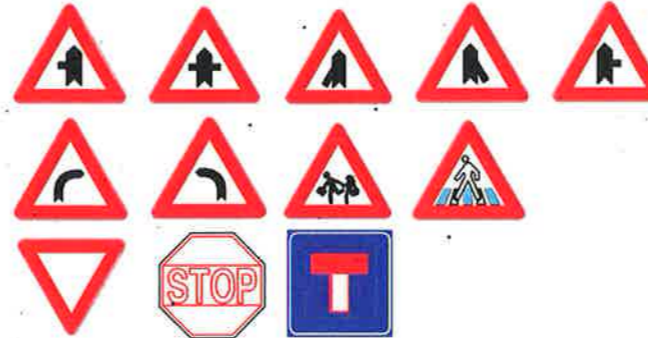

SHENJA NDALUESE

shenjat per kufirin e shpejtesise dhe ndalim parakalimin

rethi: e kuqe reflektuese
shenja: e zeze reflektuese



SHENIM: Shenjat rrugore per nga forma, madhesia, ngjyra reflektiviteti duhet te jene sipas Kodit Rrugor te Republikes se Shqiperise. Materiali praparefektiv duhet te kete jetegjatesi 10vjet per Clasin 2 dhe 7 vjet per Clasin 1. Simboli brenda shenjes rrugore duhet te jete i realizuar me boje te trajtuar me pjekje e cila nuk humbet treguesit praparefektiv. Shenja rrugore realizohet me llamarine çeliku e cila lyhet me boje opake kundrandra korozionidhe trajtohet me pjekje.

DETAJE Kurrizë artificiale h-5cm

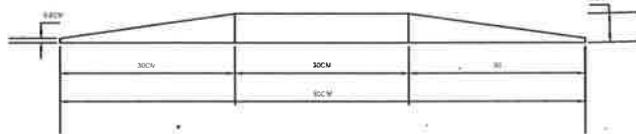

SHENJA DETYRUESE

Anet & Shigjetat: E bardhe reflektuese

Edge & arrow: white reflective



SHENJA PLOTESUESE

SHENJA E KTHESES NE NJE DREJTIM & DY DREJTIME



Shenja : e bardhe reflektuese
Sfondi: e zeze

SHENJA INFORMUESE



BASHKIA KAMËZ
DREJTORIA E PROJEKTEVE DHE INVESTIMEVE
DEPARTAMENTI I PROJEKTEVE

Dr. e Projekteve e Investimeve	RAMADAN HYSA	
Përgj. Sekt. i Projekteve	DENIS PRENÇI	
STAFI TEKNIK	Ing. EMANUELA MËZIU	[Signatures]
PROJEKTUES	Ing. ARTUR ÇAJKA	
	Ing. ALEKS DANI	
	Ark. ARJOLA KURTI	
Titulli i Projektit		Faza e Projektit
NDËRTIM RRUGËT "BLLOKU PASKUQAN, KAMEZ, BATHORE"		PROJEKT ZBATIMI
Emertimi i Fletes		Data e Implementimit:
DETAJE SINJALISTIKE		Shkalla e Vizatimit: 1:25
		Fleta Nr. 04

Prerje e kapakut prej gize

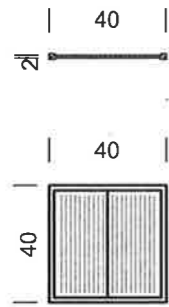
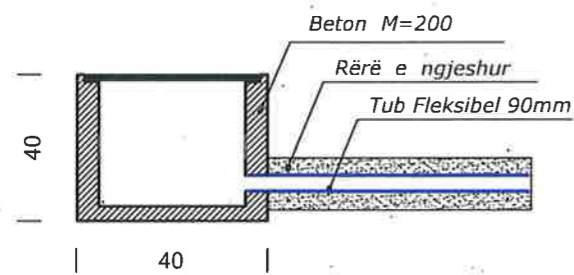

Kapaku i pusetës prej gize

Prerje e vendosjes së pusetave

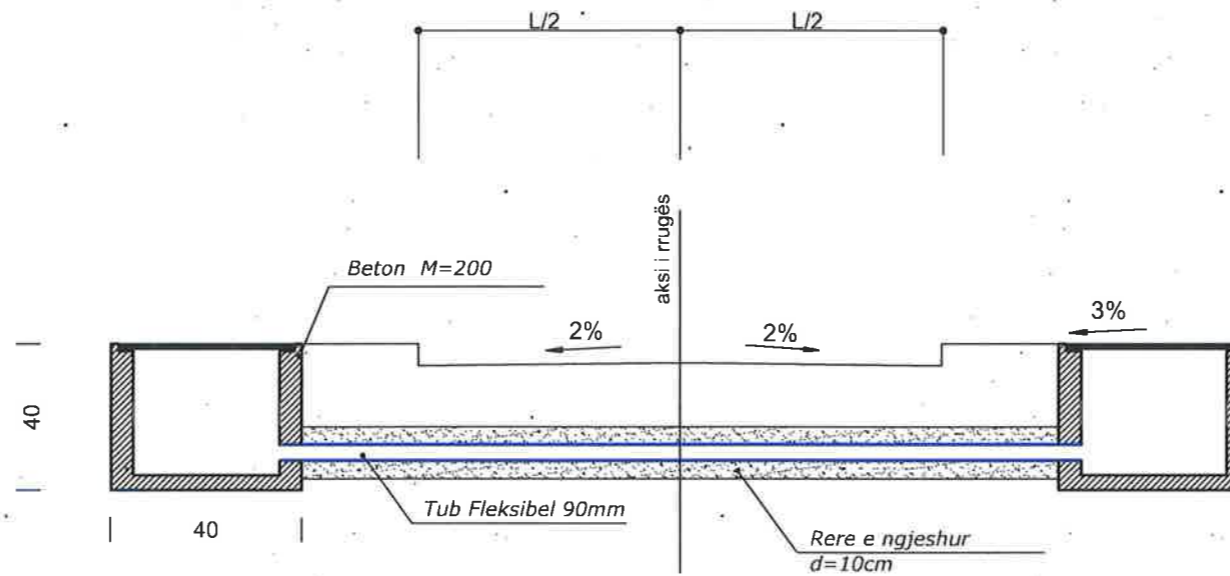

BASHKIA KAMËZ
 DREJTORIA E PROJEKTEVE DHE INVESTIMEVE
 DEPARTAMENTI I PROJEKTEVE

Dr. e Projekteve e Investimeve	RAMADAN HYSA
Përgj. Sekt. i Projekteve	DENIS PRENÇI
STAFI TEKNIK PROJEKTES	Ing. EMANUELA MËZIU Ing. ARTUR ÇAJKA Ing. ALEKS DANI Ark. ARJOLA KURTI

Titulli i Projektit	NDËRTIM RRUGËT "BLLOKU PASKUQAN, KAMEZ, BATHORE"
Emertimi i Fletës	DETAJE PUSETA ME KAPAK GIZE
Titulli i Projektit	PROJEKT ZBATIMI
Data e Implementimit :	
Shkalla e Vizimitit	
Fleta Nr.	05

Hollësi e inkastrimit të kolonës së ndriçuesit me lartësi H=9m

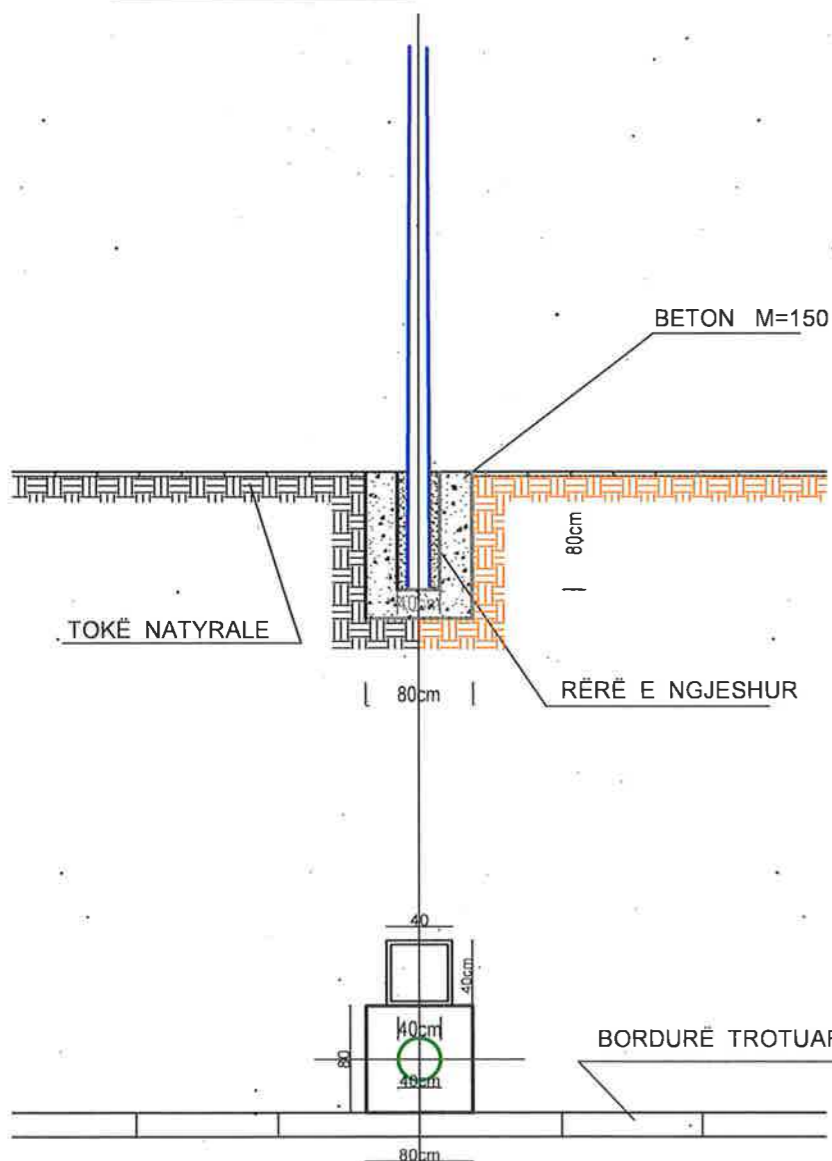

Hollësi e vendosjes së pusetës për Tub metalik 110mm

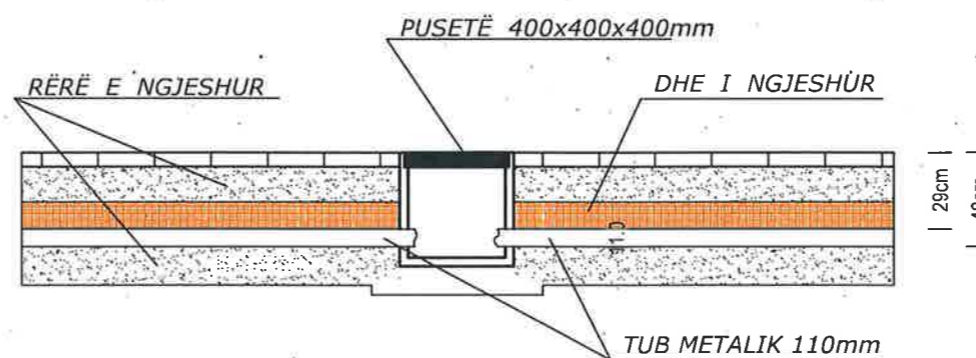

Hollësi e vendosjes së pusetës për Tub fleksibel 90mm

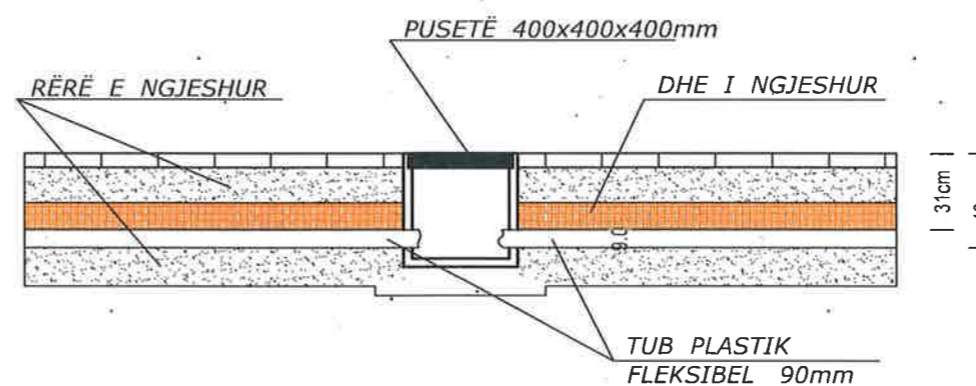

BASHKIA KAMËZ
 DREJTORIA E PROJEKTEVE DHE INVESTIMEVE
 DEPARTAMENTI I PROJEKTEVE

Dr. e Projekteve e Investimeve	RAMADAN HËSYA	
Përgj. Sekt. i Projekteve	DENIS PREKËÇI	
STAFI TEKNIK PROJEKTES	Ing. EMANUELA MËZIU	
	Ing. ARTUR ÇAJKA	
	Ing. ALEKS DANI	
	Ark. ARJOLA KURTI	

Titulli i Projektit	NDËRTIM RRUGËT "BLLOKU PASKUQAN, KAMEZ, BATHORE"	Faza e Projektit	PROJEKT ZBATIMI
Emertimi i Fletes	DETAJE INKASTRIMI	Data e Implementimit:	
		Shkalla e Vizatimit:	
		Fleta Nr.	06

Detaji Fiber Optike

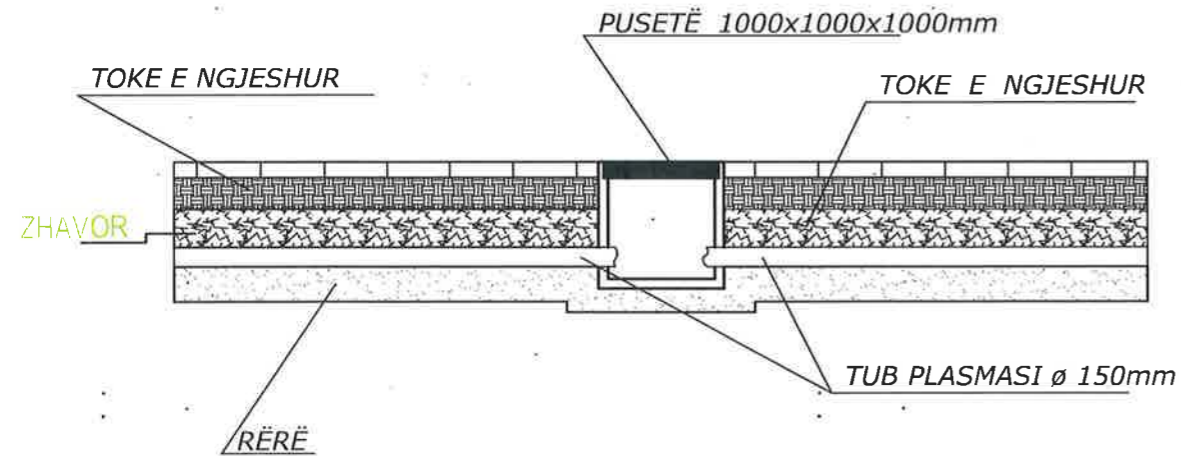
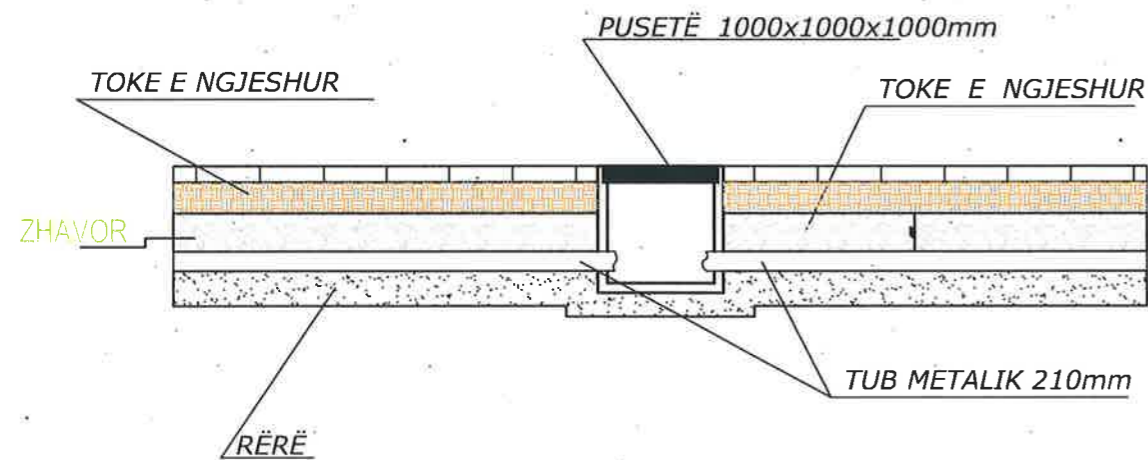

PRERJA TERTHORE

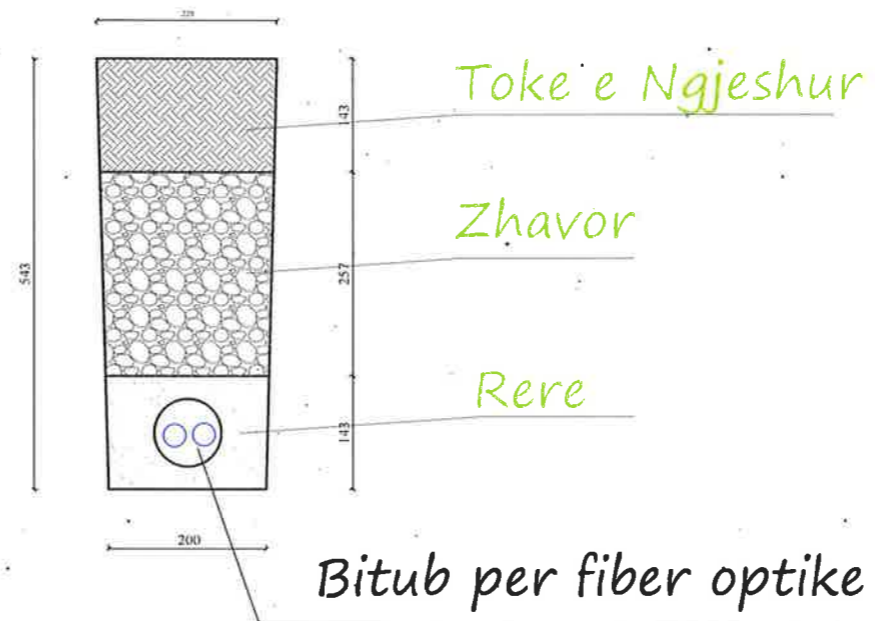

SHËNIME :

- Gjatë realizimit të intersektimeve kuota e vendosjes së pusetave mund të ndryshojë sipas rastit
- Tubi mund të vendoset me një pjerrësi të lehtë sipas nevojës , por gjithnjë thellësia minimale e vendosjes duhet të jetë 70cm nga sip. e asfaltit.



BASHKIA KAMËZ

DREJTORIA E PROJEKTEVE DHE INVESTIMEVE
DEPARTAMENTI I PROJEKTEVE

Dr. e Projekteve e Investimeve	RAMADAN HYSA
Përgj. Sekt. i Projekteve	DENIS PRENCI

STAFI TEKNIK PROJEKTES	Ing.	EMANUELA MËZIU	
	Ing.	ARTUR ÇAJKA	
	Ing.	ALEKS DANI	
	Ark.	ARJOLA KURTI	

Titulli i Projektit NDËRTIM RRUGËT "BLOKU PASKUQAN, KAMEZ, BATHORE"	Faza e Projektit PROJEKT ZBATIMI
Emertimi i Fietes DETAJE FIBER OPTIKE	Data e Implementimit : Shkalla e Vizatimit : Fleta Nr. : 07

MURE MBAJTES B/ARME **M-3** H=1.5M L= 34 ML

$[\sigma]_t=2\text{kg/cm}^2$ DHE 4kg/cm^2 , $\phi_m \geq 35^\circ$

SH. 1:25



TABELA E HEKURAVE
PER $[\sigma]_t=2\text{kg/cm}^2$ DHE 4kg/cm^2

NR.	Ø mm	L mm	SASIA cope	L m	PERMBLEDHJE E ARMATURES.			
					Ø mm	ΣL m	PESHA kg/ml	PESHA kg
1	12	1905	7	13.335	6	7.28	0.222	1.62
2	12	1905	5	9.525				
3	12	1000	15	15.00	12	69.98	0.888	62.14
3a	14	1000	3	3.00	14	3.00	1.208	3.62
4	12	1580	7	11.060				
5	12	1580	7	11.060				
6	12	1000	10	10.00				
7	6	520	6	3.12				
8	6	520	8	4.16				
9								
beton 0.81 m³/m					shuma	kg/ml	67.38	
beton rck=250kg/cm²						m³/ml	0.81	

SHENIME:

- MURI ESHTË PROJEKTUAR PER:
 - NGARKESE TE LEVIZESHME NE PRIZMIN E SHKATERIMIT $q=1.7\text{T/m}^2$
 - MBUSHJE MBRAPA TIJ ME MATERIAL SHKEMBOR ME KEND TE FERKIMIT TE MBRENDSEHEM $\phi \geq 35^\circ$.
 - NGARKESE TE LEJUAR NE TABAN $[\sigma]=2\text{kg/cm}^2$ DHE 4kg/cm^2
- MURI ESHTË PARASHIKUAR TE NDERTOHE:
 - ME BETON $rck=300\text{kg/cm}^2$
 - ARMATURE PREJ CELIKU Feb-40k.
- LARGESIA NGA FAQJA E BETONIT DERI TEK FAQJA E ARMATURES PUNESE DO TE MERRET 30mm.
- PERMASAT E BETONIT JANE DHENE NE CENTIMETRA (cm), TE ARMATURES SE HEKURIT NE MILIMETRA (mm).

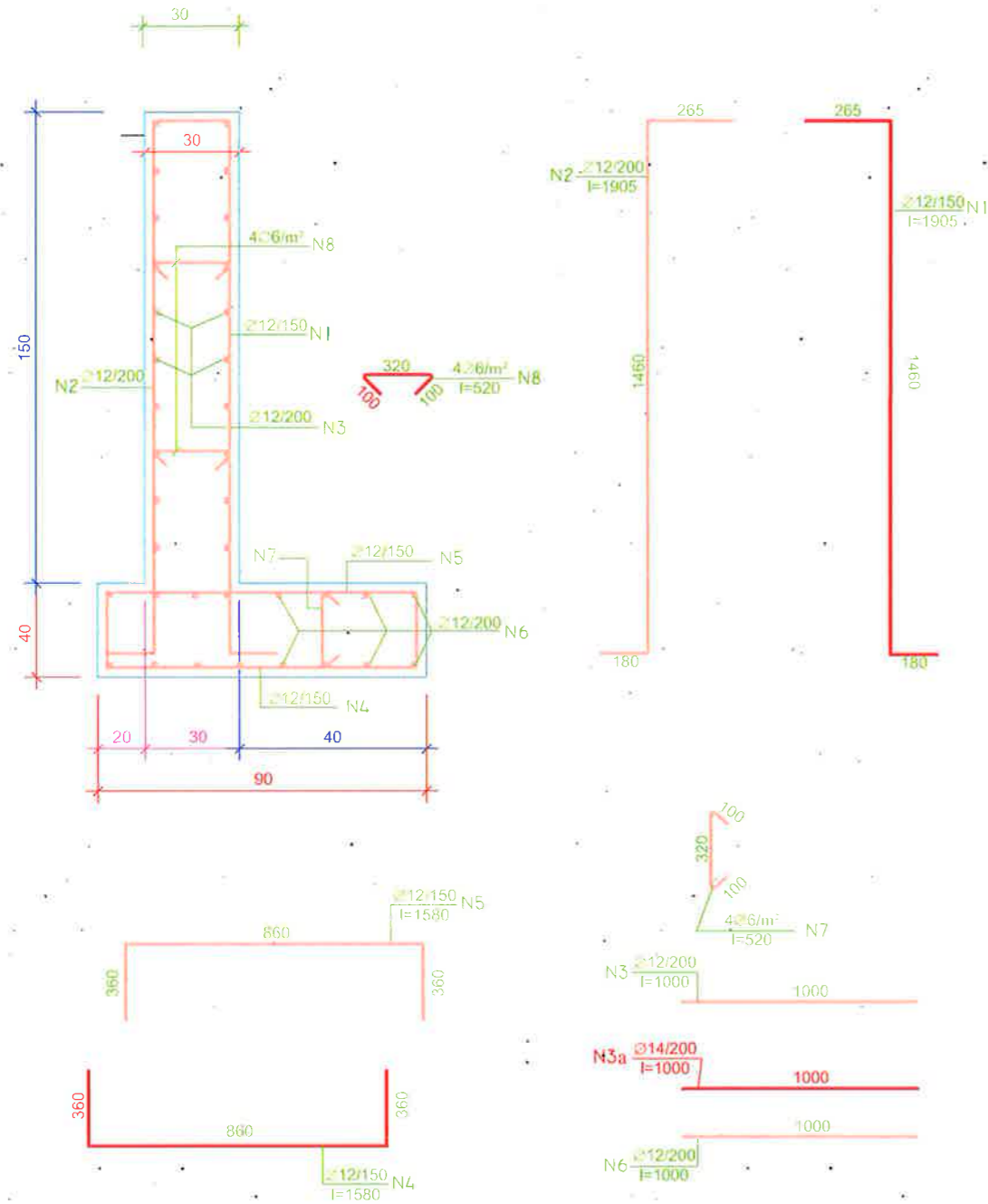
BASHKIA KAMËZ
DREJTORIA E PROJEKTEVE DHE INVESTIMEVE
DEPARTAMENTI I PROJEKTEVE

Dr. e Projekteve e Investimeve	RAMADAN HËSYA
Përgj. Sekt. i Projekteve	DENIS PRENCI
STAFI TEKNIK PROJEKTES	Ing. EMANUELA MËZIU
	Ing. ARTUR ÇAJKA
	Ing. ALEKS DANI
	Ark. ARJOLA KURTI
Titulli i Projektit	NDËRTIM RRUGËT "BLLOKU PASKUQAN, KAMEZ, BATHORE"
Emertimi i Fletës	PRERJE E ARMIMIT TE MUREVE MBAJTËSE
Faza e Projektit	PROJEKT ZBATIMI
Data e Implantimit:	
Shikalla e Vizatimit	
Fleta Nr.	08

NGRITJE PUSETE

PRERJE 1-1 Sh 1:20

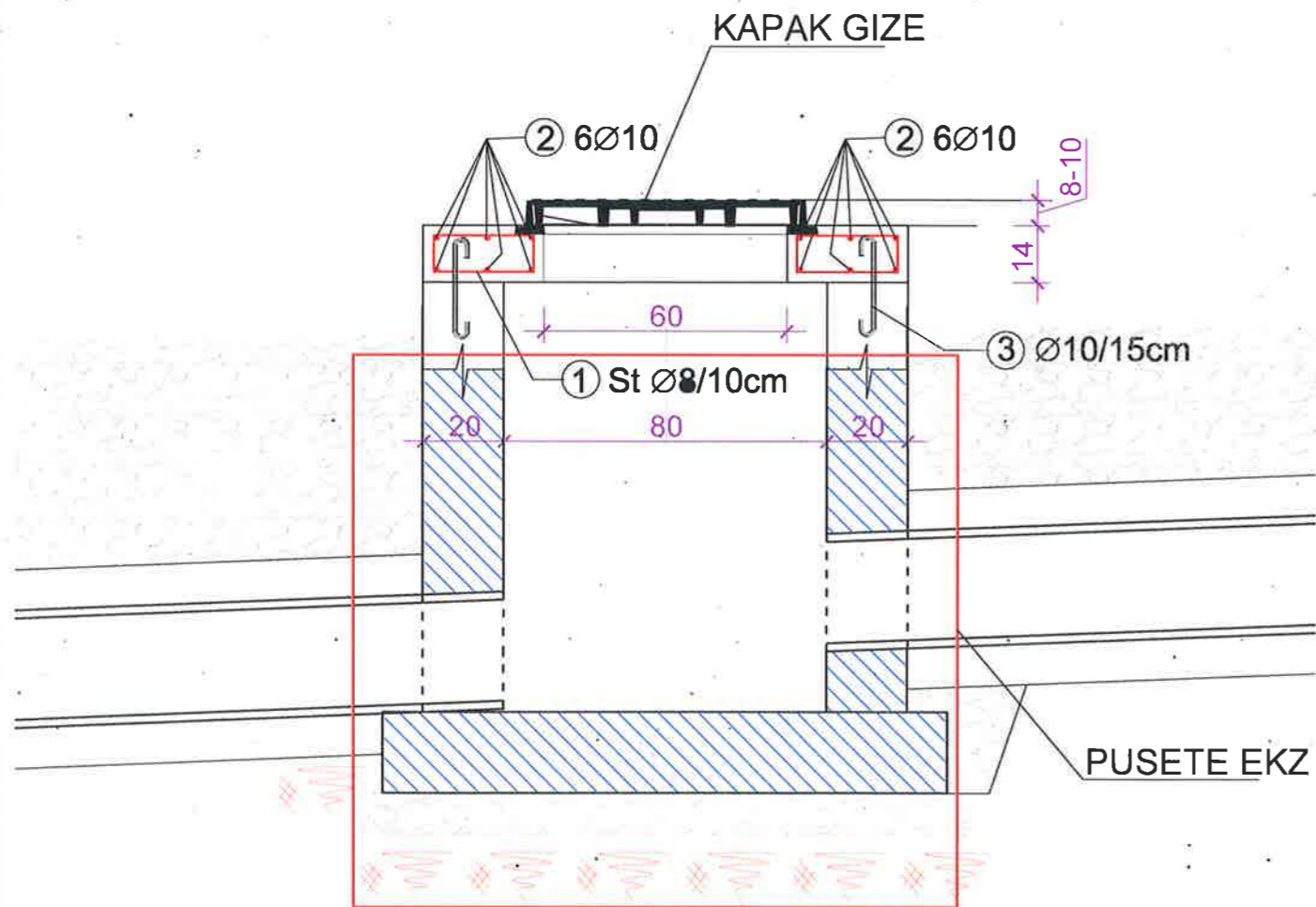

PRERJE 1-1 Sh 1:20

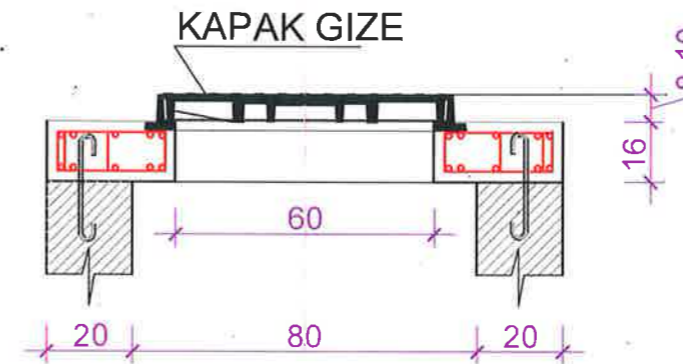

BASHKIA KAMËZ
 DREJTORIA E PROJEKTEVE DHE INVESTIMEVE
 DEPARTAMENTI I PROJEKTEVE

Dr. e Projekteve e Investimeve	RAMADAN HËSYA
Përgj. Sekt. i Projekteve	DENIS PRENÇI
STAFI TEKNIK PROJEKTES	Ing. EMANUELA MËZIU Ing. ARTUR ÇAJKA Ing. ALEKS DANI Ark. ARJOLA KURTI

Titulli i Projektit	Faza e Projektit
NDËRTIM RRUGËT "BLLOKU PASKUQAN, KAMEZ, BATHORE"	PROJEKT ZBATIMI
Emertimi i Fietes	Data e Implementimit :
DETAJ MBRINGRITJE PUSETE	Shkalla e Vizatimit
	Fleta Nr.
	09

SHTYLLE ELEKTRIKE ME PUSETE NE TOKE ME LIDHJE
EKUIPOTENCIALE DHE MORSETERIA E LINJES
SE NDRICIMIT

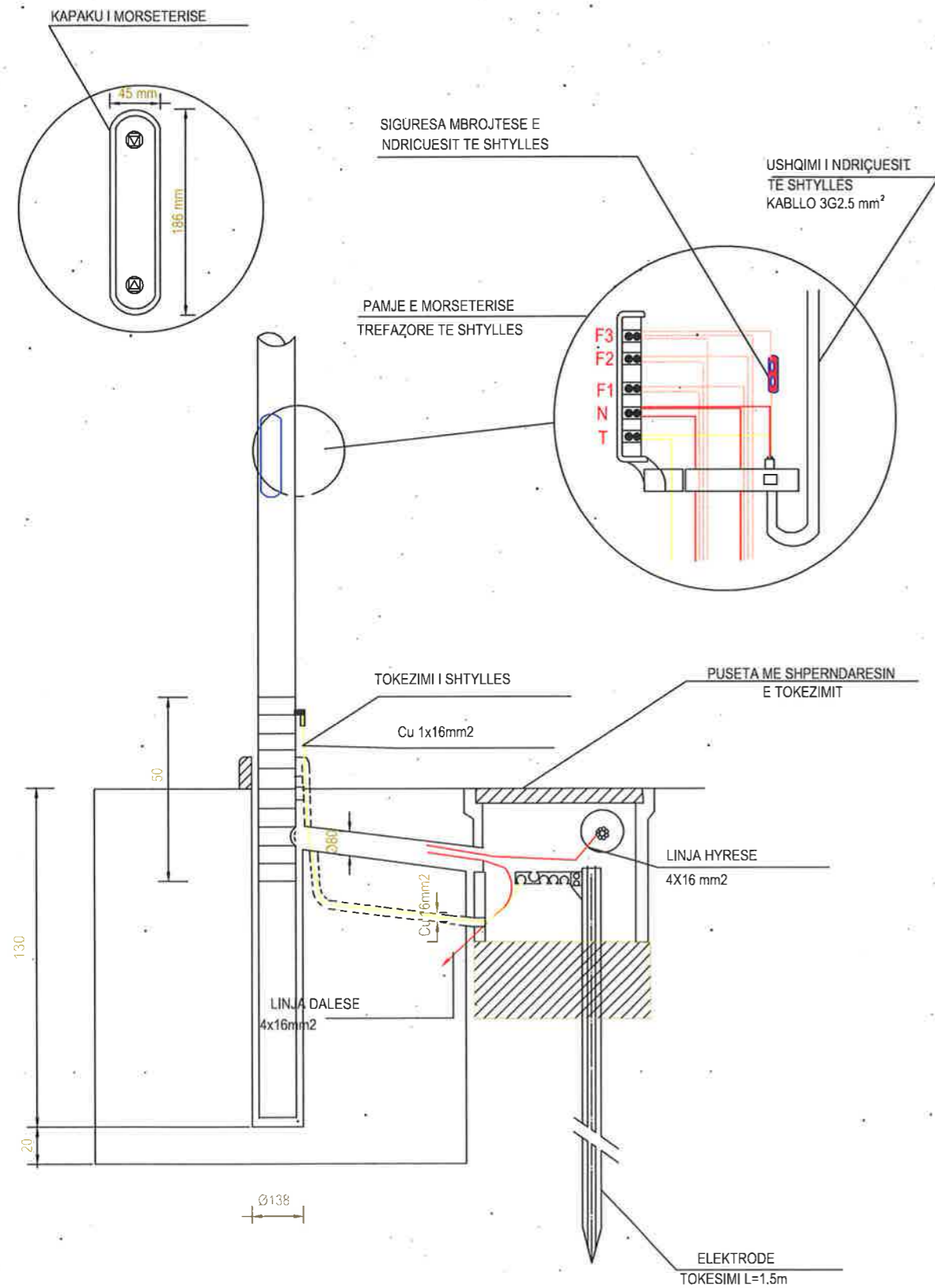

PLANI I DETAJIT TE PUSETES ,PLASTIKE 40X40X40 CM, SE NDRICIMIT
DHE I MONTIMIT TE SAJ NE TOKE ME TUB

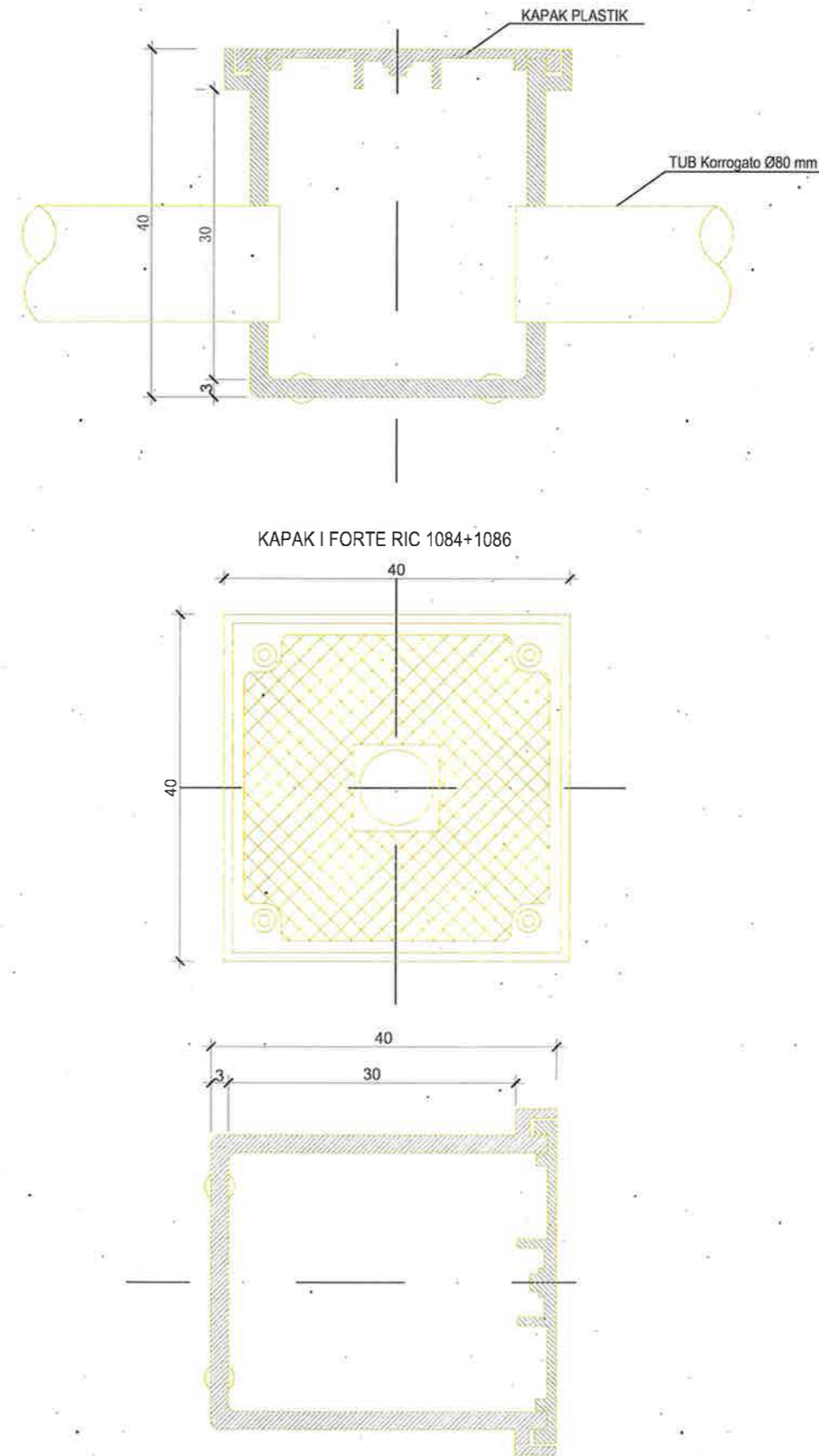

BASHKIA KAMËZ
DREJTORIA E PROJEKTEVE DHE INVESTIMEVE
DEPARTAMENTI I PROJEKTEVE

Dr. e Projekteve e Investimeve	RAMADAN HËSA	<i>[Signature]</i>
Përgj. Sekl. i Projekteve	DENIS PRENCI	<i>[Signature]</i>
STAFI TEKNIK	Ing. EMANUELA MËZIU	<i>[Signatures]</i>
PROJEKTUES	Ing. ARTUR ÇAJKA	
	Ing. ALEKS DANI	
	Ark. ARJOLA KURTI	

Titulli i Projektit	NDËRTIM RRUGËT "BLLOKU PASKUQAN, KAMEZ, BATHORE"	Faza e Projektit	PROJEKT ZBATIMI
Emertimi i Fletes	DETAJE TOKEZIMI, MORSETERIE, PUSETA PVC	Data e Implementimit	
		Shkalla e Vizatimit	
		Fleta Nr.	10