

REPUBLIKA E SHQIPËRISË
BASHKIA LEZHË

MIRATOHET
Kryetari
PJERIN NDREU

PROJEKT ZBATIMI

OBJEKTI :

SISTEMIMI I RRUGEVE TË BRENDSHME NË BASHKINE LEZHË

SISTEMIMI I RRUGES FAIK KONICA



PROJEKTUES : *ALBGOLDING 2E shpk*



PROJEKT ZBATIMI

PROJEKTI: "SISTEMIMI I RRUGËVE TË BRENDSHME NË BASHKINË LEZHË"

NËNOBJEKTI: SISTEMIMI I RRUGËS FAIK KONICA, BASHKIA LEZHË.

HOROGRAFIA



INVESTITORI
"Bashkia Lezhë"



PROJEKTUESI
"ALBGOLDING 2E"

*Studim Projektim - "Sistemimi i rrugëve të
brendshme në Bashkinë Lezhë".
Rruga Faik Konica*

HOROGRAFIA

FAZA - PROJEKT ZBATIM

SHKALLA

Data: 2026

VIZATIMI Nr:



ALBGOLDING 2E" sh.p.k

PROJEKTUES :

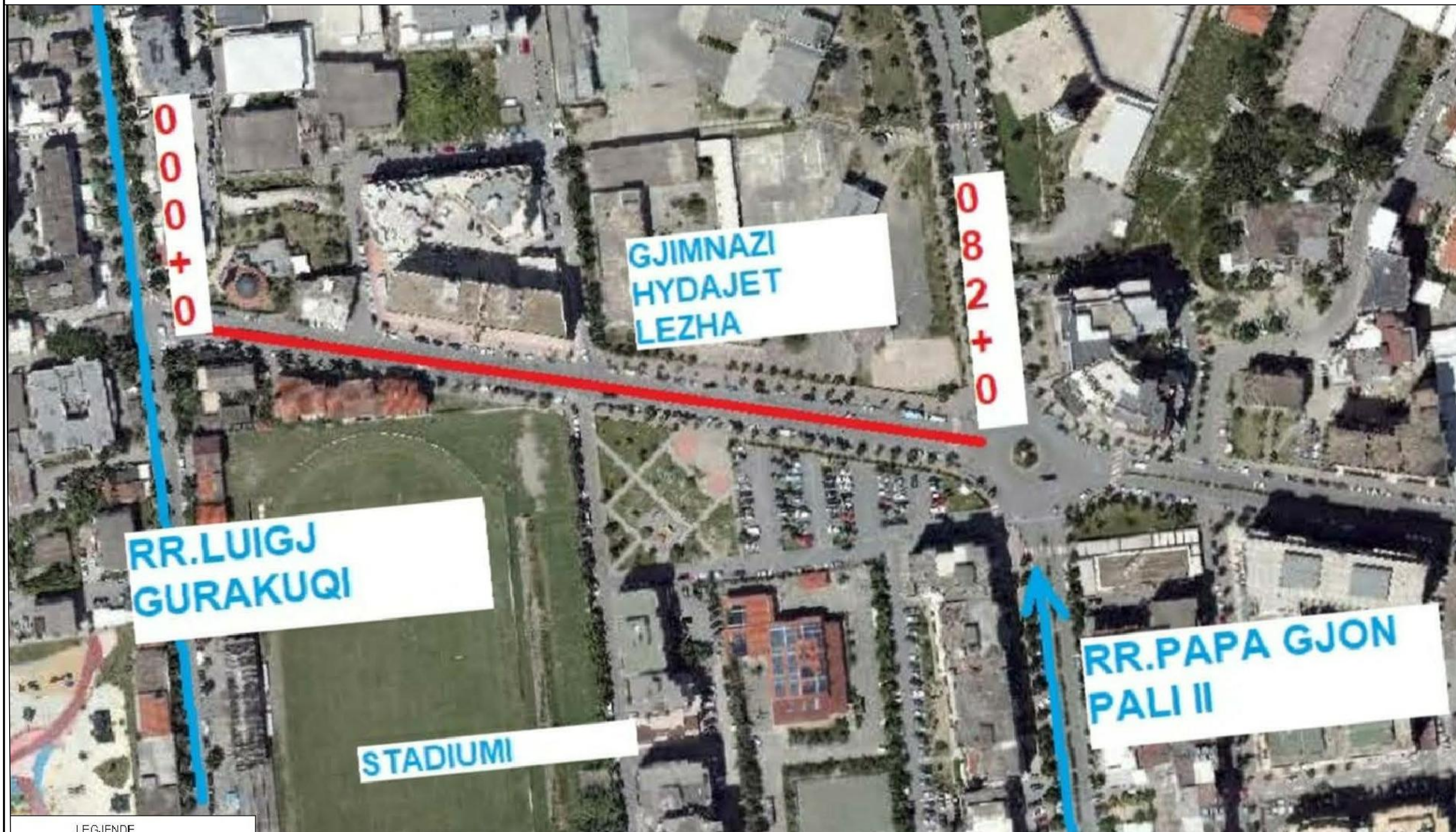
CONTACT :
E-MAIL : albgolding2e@gmail.com
Cel: +355 68 52 07 550
+355 68 20 85 763



LEGJENDE

 <p>INVESTITORI "Bashkia Lezhë"</p>	 <p>PROJEKTUESI "ALBGOLDING 2E"</p>	<p>Studim Projektim - "Sistemimi i rrugëve të brendshme në Bashkinë Lezhë". Rruga Faik Konica</p> <p>HOROGRAFIA</p>	<p>FAZA - PROJEKT ZBATIM</p> <table border="1"> <tr> <td>SHKALLA 1:400</td> <td>Data: 2026</td> </tr> <tr> <td colspan="2">VIZATIMI Nr:</td> </tr> </table>	SHKALLA 1:400	Data: 2026	VIZATIMI Nr:		<p>ALBGOLDING 2E" sh.p.k</p> <p>PROJEKTUES :</p> <p>CONTACT : E-MAIL : albgolding2e@gmail.com Cel: +355 68 52 07 550 +355 68 20 85 763</p>
SHKALLA 1:400	Data: 2026							
VIZATIMI Nr:								





PROJEKT ZBATIMI

PROJEKTI: "SISTEMIMI I RRUGËVE TË BRENDSHME NË BASHKINË LEZHË"

NËNOBJEKTI: SISTEMIMI I RRUGËS FAIK KONICA, BASHKIA LEZHË.

PROFILI TIP

 INVESTITORI "Bashkia Lezhë"	 PROJEKTUESI "ALBGOLDING 2E"	<i>Studim Projektim - Sistemimi i rrugëve të brendshme në Bashkinë Lezhë Rruga Faik Konica</i>		FAZA - PROJEKT ZBATIM		ALBGOLDING 2E" sh.p.k CONTACT : E-MAIL : albgolding2e@gmail.com Cel: +355 68 52 07 550 +355 68 20 85 763
		PROFILI TIP	SHKALLA	Data: 2026	PROJEKTUESI:	
				VIZATIMI Nr:		

PROFILI TIP I

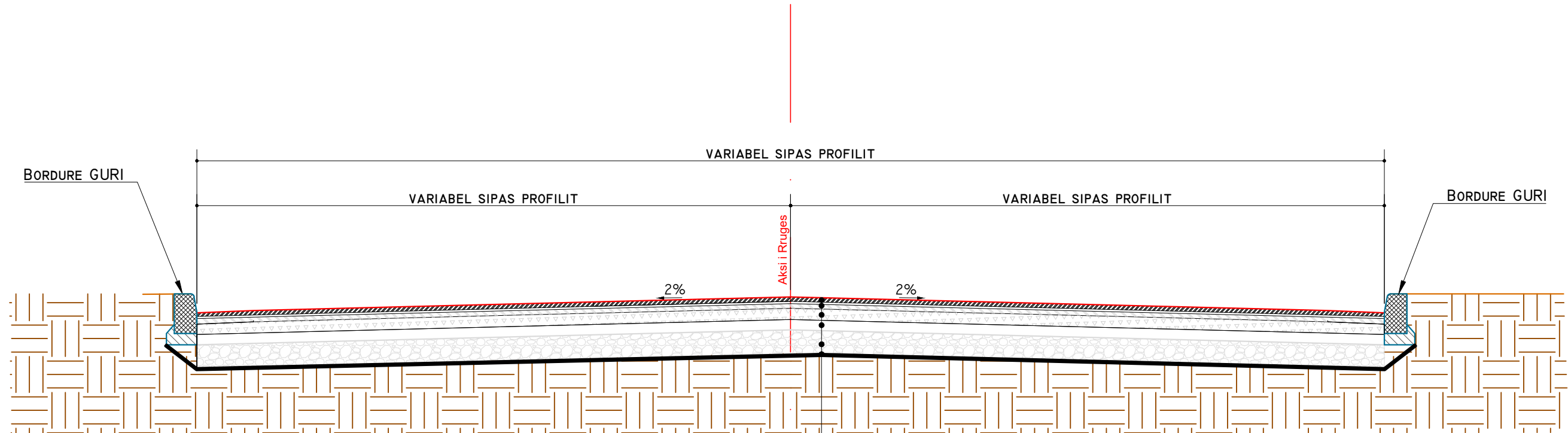

- Shtrese me pllaka mermeri/guri 8-10 cm
- Shtrese llaç cimento i majme M50, t=5cm
- Shtrese betoni 15 cm me zgare Ø8 20x20 cm
- Shtrese stabilizanti, t=5cm
- Shtrese çakulli (material gurore), t=20cm, i ngjeshur
- Shtrese Gjeotekstil
- Toke natyrale



INVESTITORI
"Bashkia Lezhë"



PROJEKTUESI
"ALBGOLDING 2E"

Studim Projektim - Sistemi i rrugëve të
brendshme në Bashkinë Lezhë
Rruga Faik Konica

Profili Tip

FAZA - PROJEKT ZBATIM

SHKALLA 1:40

Data: 2026

VIZATIMI Nr:

PROJEKTUESI:

ALBGOLDING 2E" sh.p.k

CONTACT :
E-MAIL : albgolding2e@gmail.com
Cel: +355 68 52 07 550
+355 68 20 85 763

PROFILI TIP 2

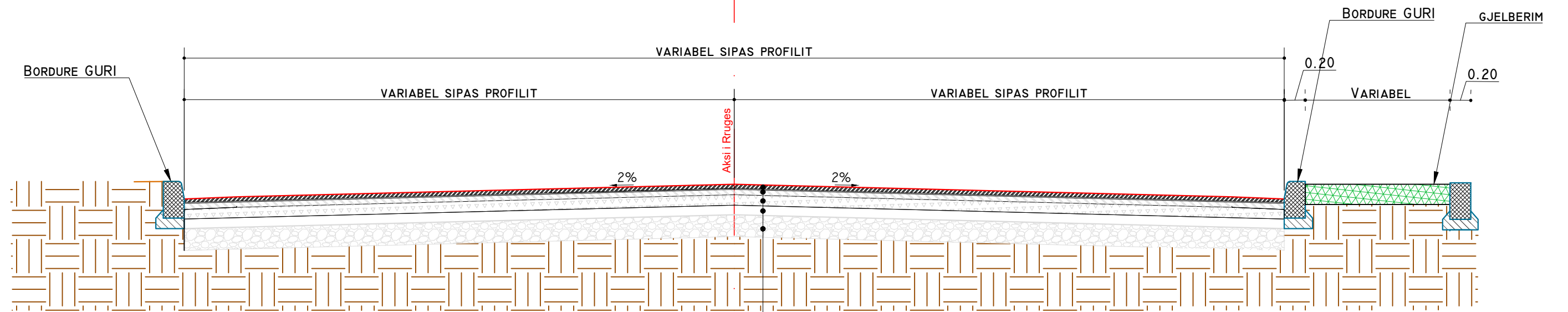

- Shtrese me pllaka mermeri/guri 8-10 cm
- Shtrese llaç cimento i majme M50, t=5cm
- Shtrese betoni 15 cm me zgare Ø8 20x20 cm
- Shtrese stabilizanti, t=5cm
- Shtrese çakulli (material gurore), t=20cm, i ngjeshur
- Shtrese Gjeotekstil
- Toke natyrale



INVESTITORI
"Bashkia Lezhë"



PROJEKTUESI
"ALBGOLDING 2E"

Studim Projektim - Sistemi i rrugëve të
brendshme në Bashkinë Lezhë
Rruga Faik Konica

Profili Tip

FAZA - PROJEKT ZBATIM

SHKALLA 1:40

Data: 2026

VIZATIMI Nr:

PROJEKTUESI:

ALBGOLDING 2E" sh.p.k

CONTACT :
E-MAIL : albgolding2e@gmail.com
Cel: +355 68 52 07 550
+355 68 20 85 763





PROJEKT ZBATIMI

PROJEKTI: "SISTEMIMI I RRUGËVE TË BRENDSHME NË BASHKINË LEZHË"

NËNOBJEKTI: SISTEMIMI I RRUGËS FAIK KONICA, BASHKIA LEZHË.

DETAJE

 INVESTITORI "Bashkia Lezhë"	 PROJEKTUESI "ALBGOLDING 2E"	<i>Studim Projektim - Sistemimi i rrugëve të brendshme në Bashkinë Lezhë Rruga Faik Konica</i> DETAJE	FAZA - PROJEKT ZBATIM		ALBGOLDING 2E" sh.p.k CONTACT : E-MAIL : albgolding2e@gmail.com Cel: +355 68 52 07 550 +355 68 20 85 763
			SHKALLA	Data: 2026	
			VIZATIMI Nr:		

MOBILIMI URBAN - DETAJE



ELEMENT URBAN PËR MENAXHIMIN E MBETJEVE

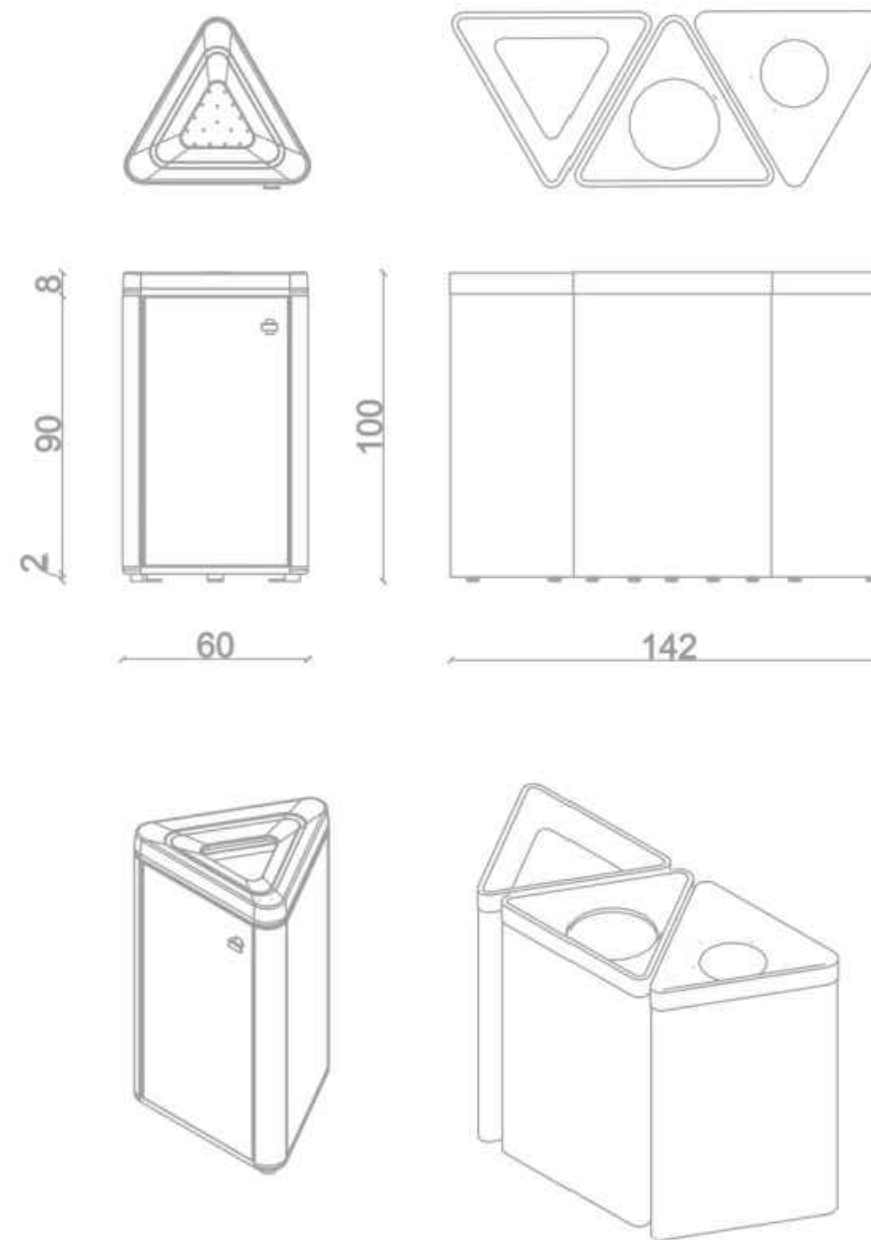

INVESTITORI
"Bashkia Lezhë"



PROJEKTUESI
"ALBGOLDING 2E"

Studim Projektim - Sistemimi i rrugëve të
brendshme në Bashkinë Lezhë
Rruga Faik Konica

DETAJE

FAZA - PROJEKT ZBATIM

SHKALLA 1:40

Data: 2026

VIZATIMI Nr:

PROJEKTUESI

ALBGOLDING 2E" sh.p.k

CONTACT :
E-MAIL : albgolding2e@gmail.com
Cel: +355 68 52 07 550
+355 68 20 85 763

MOBILIMI URBAN - DETAJE



Shenim: Nricuesit jane te perbere nga celiku korten te cilit ne pjese e sipërme ne forme rombi do ti brendashkruhet shiriti LED (tipit high-power LED).

NDRIÇUES URBAN TE LARTE
MATERIALI : ÇELIK CORTEN

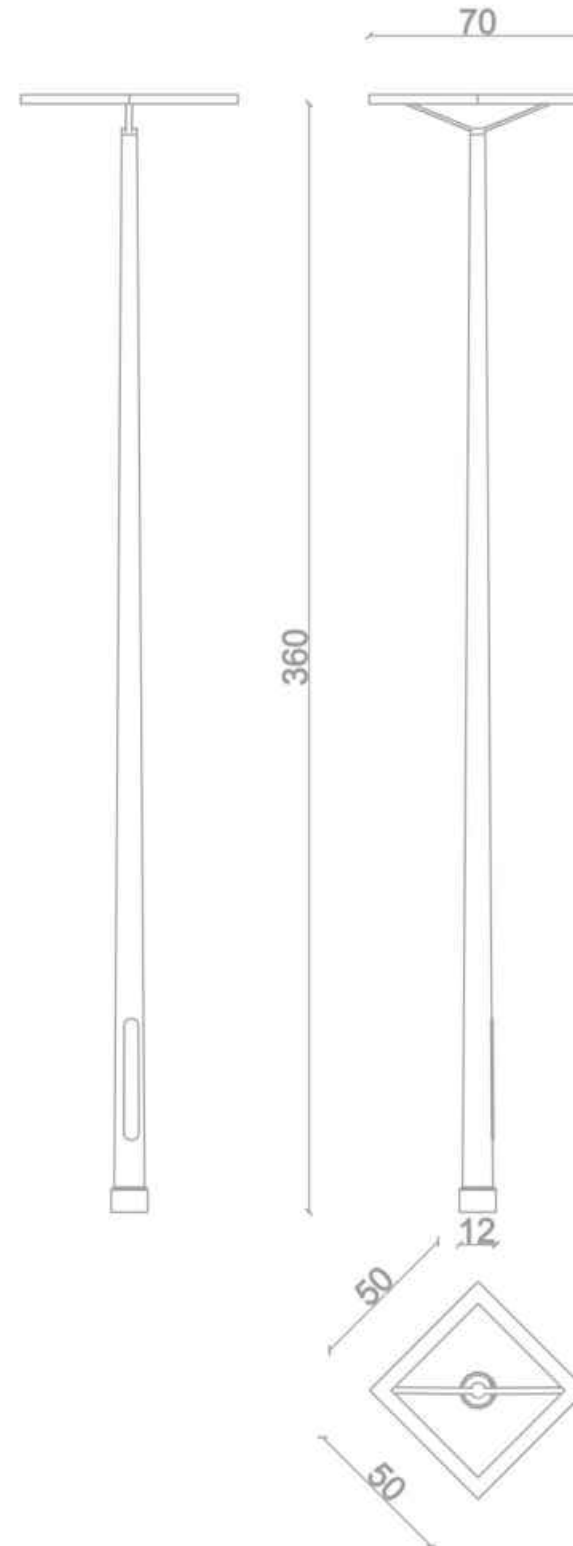

TABELE INFORMUESE
MATERIALI : ÇELIK CORTEN

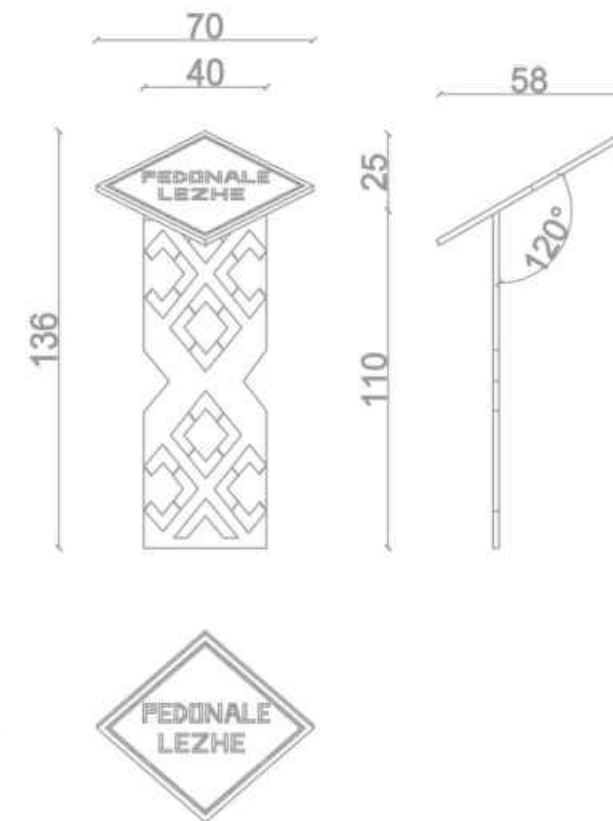

INVESTITORI
"Bashkia Lezhë"



PROJEKTUESI
"ALBGOLDING 2E"

Studim Projektim - Sistemimi i rrugëve të
brendshme në Bashkinë Lezhë
Rruga Faik Konica

Detaje

FAZA - PROJEKT ZBATIM

SHKALLA 1:40

Data: 2026

VIZATIMI Nr:

PROJEKTUESI:

ALBGOLDING 2E" sh.p.k

CONTACT :
E-MAIL : albgolding2e@gmail.com
Cel: +355 68 52 07 550
+355 68 20 85 763

MOBILIMI URBAN - DETAJE



INSTALACIONE METALIKE ME MOTIVE TRADICIONALE
MATERIALI : ÇELIK CORTEN



MBAJTËSE BIÇIKLETASH METALIKE
MATERIALI : ÇELIK CORTEN

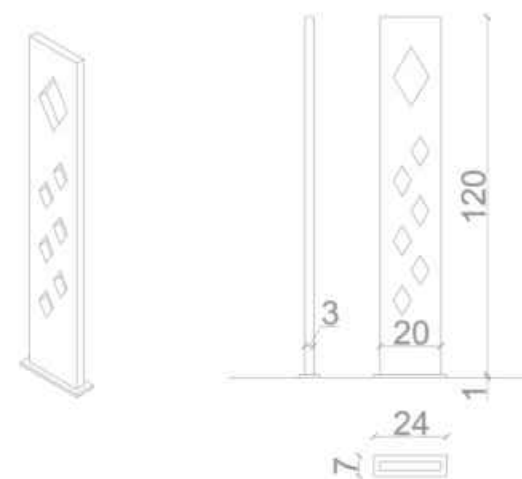
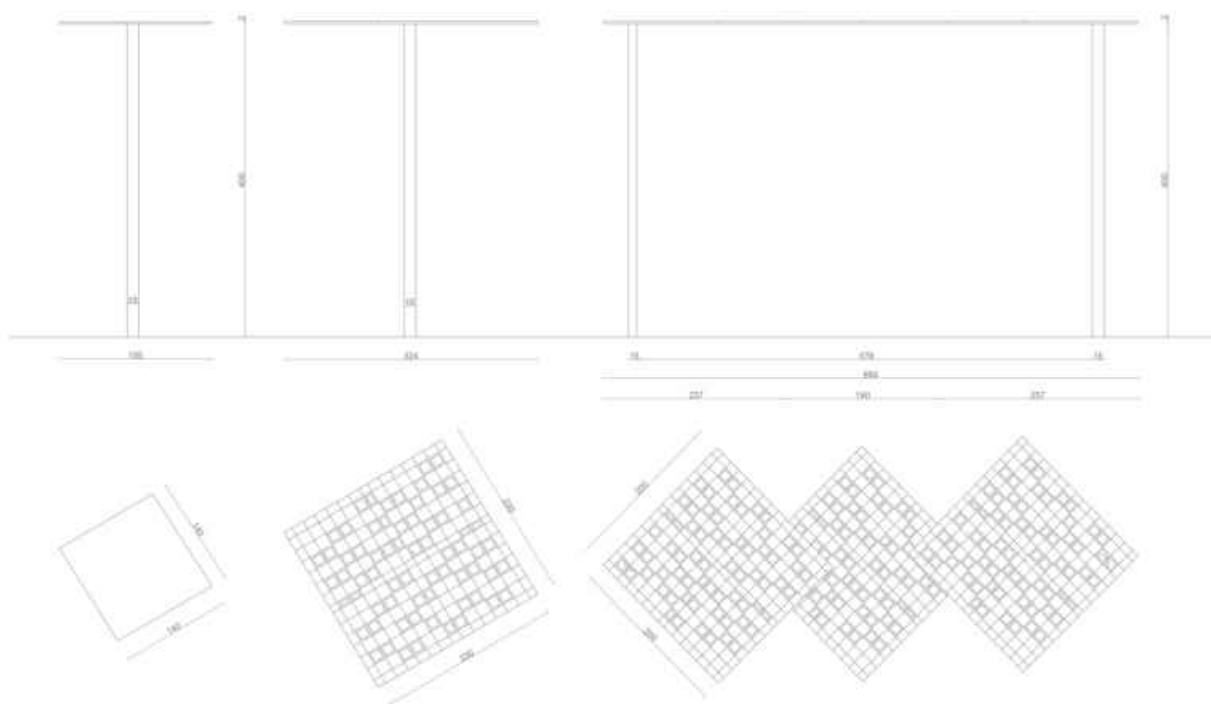

Shenim: Parashikohet mundësia e bashkëngjitjes së ndriçimit linear me shirit LED në perimetrin e rombit, me qëllim rritjen e cilësisë estetike dhe funksionale në orët e natës



INVESTITORI
"Bashkia Lezhë"



PROJEKTUESI
"ALBGOLDING 2E"

Studim Projektim - Sistemimi i rrugëve të brendshme në Bashkinë Lezhë Rruga Faik Konica

Detaje

FAZA - PROJEKT ZBATIM

SHKALLA 1:40

Data: 2026

VIZATIMI Nr:

PROJEKTUESI:

ALBGOLDING 2E" sh.p.k

CONTACT :
E-MAIL : albgolding2e@gmail.com
Cel: +355 68 52 07 550
+355 68 20 85 763

LLOJI DHE DIMENSIONIMI I GUREVE - PEDONALE LEZHE



GURI I SHENGJINIT

(sip. e bardha ne plan)

Gjeresi : 25 cm
Gjatesi : 25 cm - (e lire)
Trashesi : 8 cm



GURI I KALIVAÇIT

(sip. e zeza ne plan)

Gjeresi : 25 cm
Gjatesi : 25 cm - (e lire)
Trashesi : 8 cm

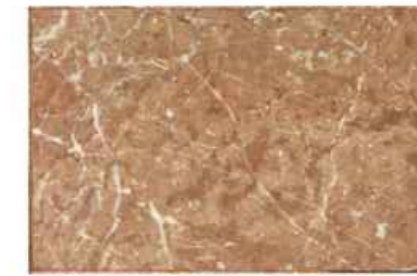

GURI I REPSIT

(sip. e kuqe ne plan)

Gjeresi : 25 cm
Gjatesi : 25 cm - (e lire)
Trashesi : 8 cm

GURI I BURRELIT
(gri i erret)



INVESTITORI
"Bashkia Lezhë"



PROJEKTUESI
"ALBGOLDING 2E"

Studim Projektim - Sistemitimi i rrugëve të
brendshme në Bashkinë Lezhë
Rruga Faik Konica

DETAJE

FAZA - PROJEKT ZBATIM

SHKALLA 1:40

Data: 2026

VIZATIMI Nr:

PROJEKTUESI

ALBGOLDING 2E" sh.p.k

CONTACT :
E-MAIL : albgolding2e@gmail.com
Cel: +355 68 52 07 550
+355 68 20 85 763





PROJEKT ZBATIMI

PROJEKTI: "SISTEMIMI I RRUGËVE TË BRENDSHME NË BASHKINË LEZHË"

NËNOBJEKTI: SISTEMIMI I RRUGËS FAIK KONICA, BASHKIA LEZHË.

PLANI I KUB

	INVESTITORI "Bashkia Lezhë"		PROJEKTUESI "ALBGOLDING 2E"	Studim Projektim - Sistemimi i rrugëve të brendshme në Bashkinë Lezhë Rruga Faik Konica		FAZA - PROJEKT ZBATIM		ALBGOLDING 2E" sh.p.k CONTACT : E-MAIL : albgolding2e@gmail.com Cel: +355 68 52 07 550 +355 68 20 85 763
				PLANI I KUB		SHKALLA	Data: 2026	
				VIZATIMI Nr:				



- LEGJENDE**
- Shtrese me gure
 - Gjelberim
 - Pusete KUSH
 - DN 315 PPE Dimension i kanalizimeve te Ujerve te Shiut



INVESTITORI
"Bashkia Lezhë"



PROJEKTUESI
"ALBGOLDING 2E"

*Studim Projektim - Sistemi i rrugëve të brendshme në Bashkinë Lezhë
Rruga Faik Konica*

PLANI I KANALIZIMEVE TE UJRAVE TE BARDHA

FAZA - PROJEKT ZBATIM

SHKALLA 1:400	Data: 2026
VIZATIMI Nr:	

PROJEKTUES : **ALBGOLDING 2E" sh.p.k**

CONTACT :
E-MAIL : albgolding2e@gmail.com
Cel: +355 68 52 07 550
+355 68 20 85 763

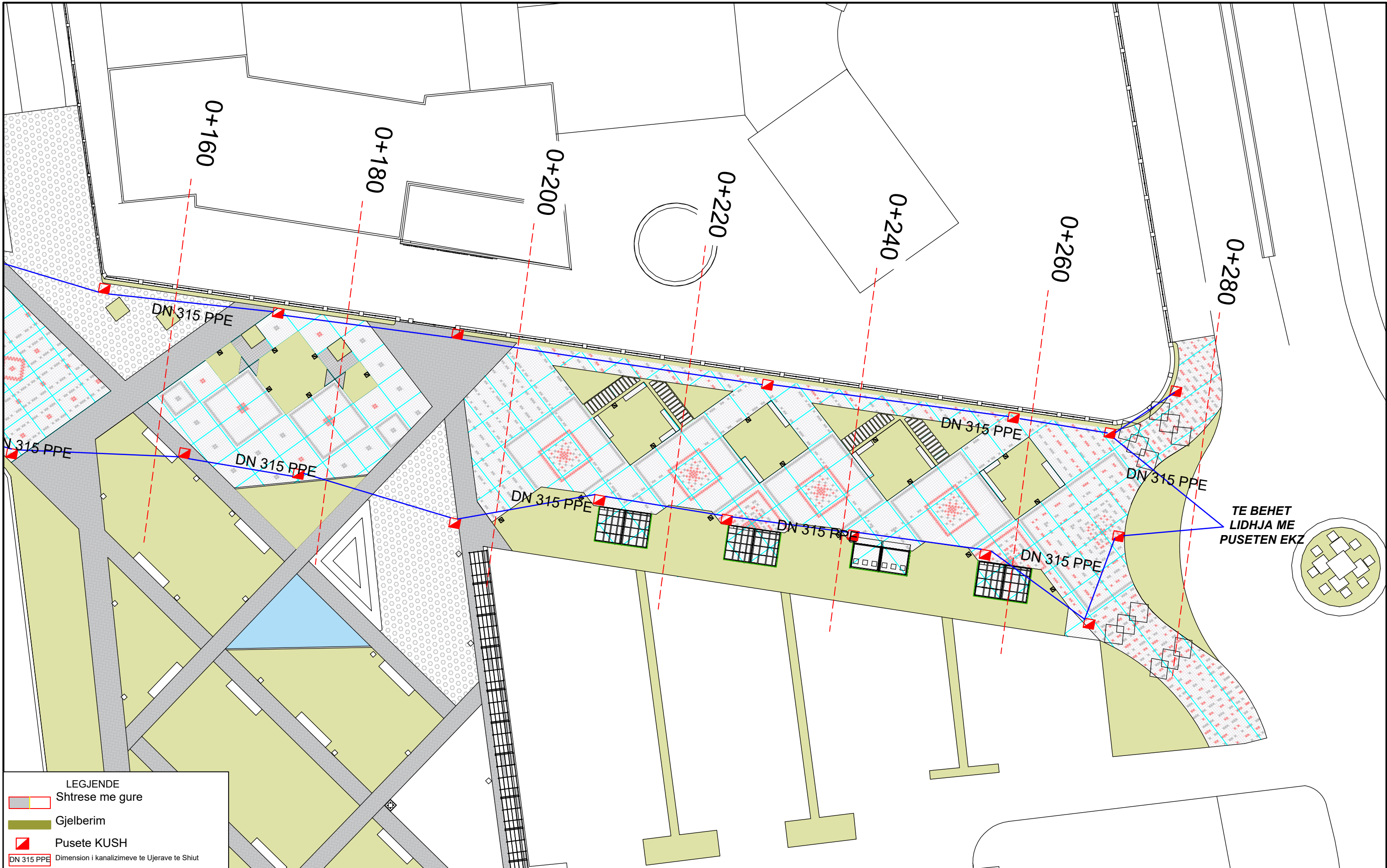

- LEGJENDE**
- Shtrese me gure
 - Gjelberim
 - Pusete KUSH
 - DN 315 PPE Dimension i kanalizimeve te Ujerrave te Shiut



INVESTITORI
"Bashkia Lezhë"



PROJEKTUESI
"ALBGOLDING 2E"

Studim Projektim - Sistemimi i rrugëve të brendshme në Bashkinë Lezhë
Rruga Faik Konica

PLANI I KANALIZIMEVE TE UJRAVE TE BARDHA

FAZA - PROJEKT ZBATIM

SHKALLA 1:400	Data: 2026
VIZATIMI Nr:	

PROJEKTUES : **ALBGOLDING 2E" sh.p.k**

CONTACT :
E-MAIL : albgolding2e@gmail.com
Cel: +355 68 52 07 550
+355 68 20 85 763





PROJEKT ZBATIMI

PROJEKTI: "SISTEMIMI I RRUGËVE TË BRENDSHME NË BASHKINË LEZHË"

NËNOBJEKTI: SISTEMIMI I RRUGËS FAIK KONICA", BASHKIA LEZHË.

PREZANTIM I PROJEKTIT

 INVESTITORI "Bashkia Lezhë"	 PROJEKTUESI "ALBGOLDING 2E"	<i>Studim Projektim - Sistemimi i rrugëve të brendshme në Bashkinë Lezhë Rruga Faik Konica</i> PREZANTIM	FAZA - PROJEKT ZBATIM		ALBGOLDING 2E" sh.p.k CONTACT : E-MAIL : albgolding2e@gmail.com Cel: +355 68 52 07 550 +355 68 20 85 763
			SHKALLA	Data: 2026	
			VIZATIMI Nr:		



PEDONALJA E LEZHËS



INVESTITORI
"Bashkia Lezhë"



PROJEKTUESI
"ALBGOLDING 2E"

*Studim Projektim - Sistemit i rrugëve të
brendshme në Bashkinë Lezhë
Rruga Faik Konica*

PREZANTIM

FAZA - PROJEKT ZBATIM

SHKALLA 1:40

Data: 2026

VIZATIMI Nr:

PROJEKTUESI

ALBGOLDING 2E" sh.p.k

CONTACT :
E-MAIL : albgolding2e@gmail.com
Cel: +355 68 52 07 550
+355 68 20 85 763

ZONA 4
(MALESIA E MADHE)

ZONA 3
(ZADRIMA)

ZONA 2
(KALLMETI)

ZONA 1
(MIRDITA)

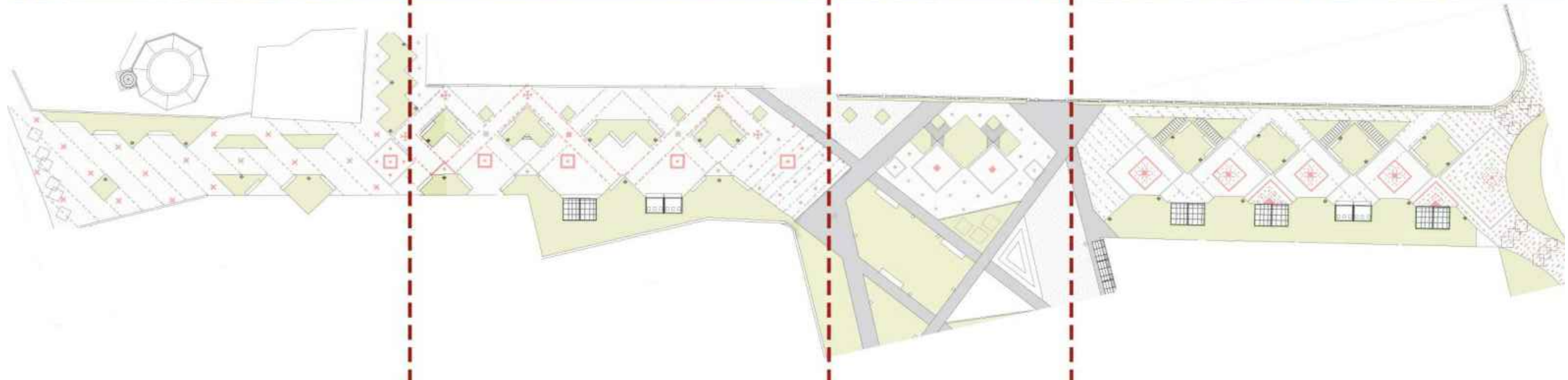

INVESTITORI
"Bashkia Lezhë"



PROJEKTUESI
"ALBGOLDING 2E"

Studim Projektim - Sistemitimi i rrugëve të
brendshme në Bashkinë Lezhë
Rruga Faik Konica

PREZANTIM

FAZA - PROJEKT ZBATIM

SHKALLA 1:40

Data: 2026

VIZATIMI Nr:

PROJEKTUESI

ALBGOLDING 2E" sh.p.k

CONTACT :
E-MAIL : albgolding2e@gmail.com
Cel: +355 68 52 07 550
+355 68 20 85 763



PROJEKT ZBATIMI

PROJEKTI: "SISTEMIMI I RRUGËVE TË BRENDSHME NË BASHKINË LEZHË"



NËNOBJEKTI: SISTEMIMI I RRUGËS FAIK KONICA, BASHKIA LEZHË.

PLANI I NDRIÇIMIT

 INVESTITORI "Bashkia Lezhë"	 PROJEKTUESI "ALBGOLDING 2E"	<i>Studim Projektim - Sistemimi i rrugëve të brendshme në Bashkinë Lezhë Rruga Faik Konica</i> PLANI I NDRIÇIMIT	FAZA - PROJEKT ZBATIM		ALBGOLDING 2E" sh.p.k PROJEKTUES : CONTACT : E-MAIL : albgolding2e@gmail.com Cel: +355 68 52 07 550 +355 68 20 85 763
			SHKALLA	Data: 2026	
			VIZATIMI Nr:		



LEGJENDE

	Shtrese me gure
	Gjelberim
	Shtylle Ndricimi



INVESTITORI
"Bashkia Lezhë"



PROJEKTUESI
"ALBGOLDING 2E"

*Studim Projektim - Sistemimi i rrugëve të brendshme në Bashkinë Lezhë
Rruga Faik Konica*

Plani NDRICIMIT

FAZA - PROJEKT ZBATIM

SHKALLA 1400	Data: 2026
VIZATIMI Nr:	

PROJEKTUES : ALBGOLDING 2E" sh.p.k

CONTACT :
E-MAIL : albgolding2e@gmail.com
Cel: +355 68 52 07 550
+355 68 20 85 763

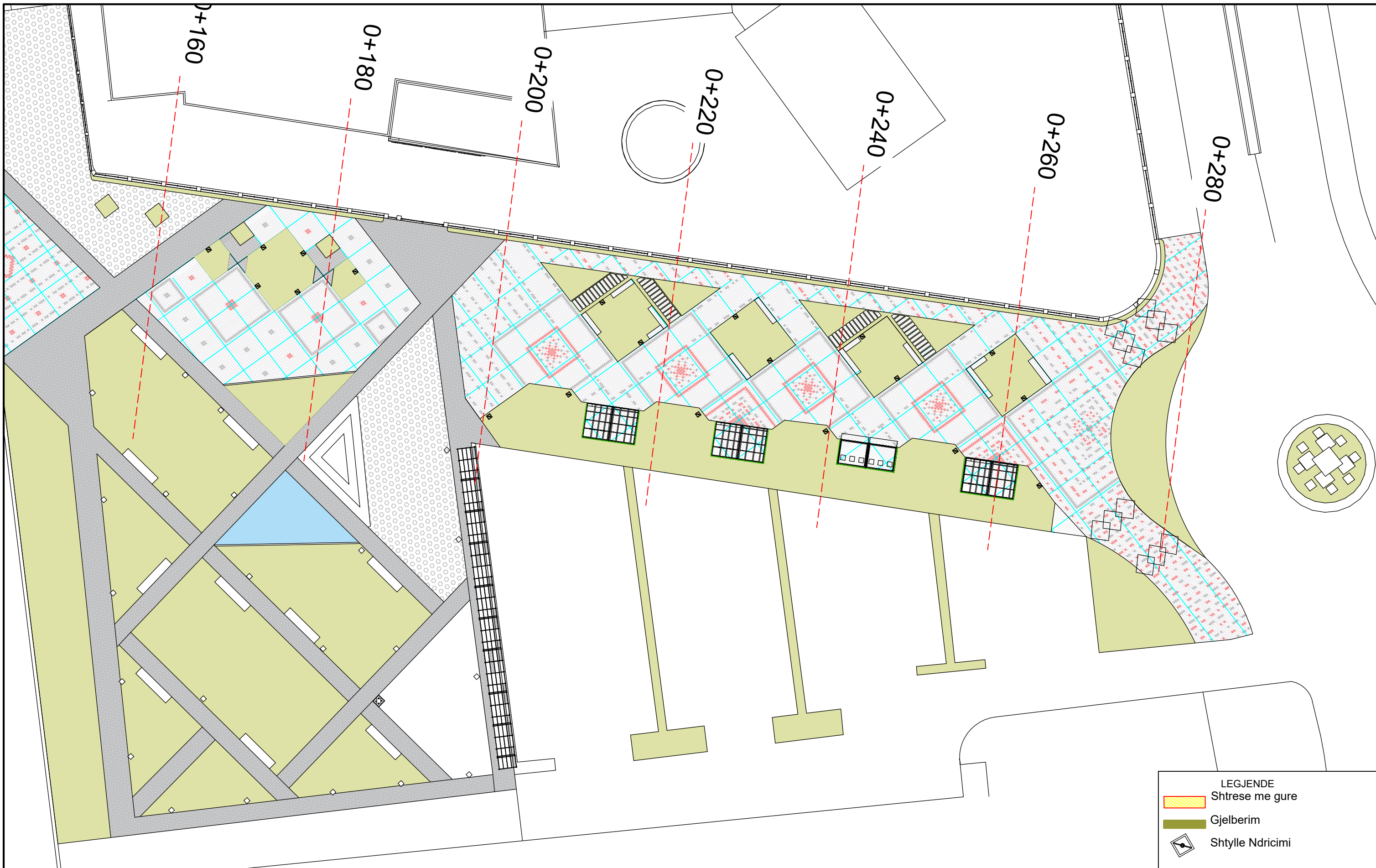

LEGJENDE	
	Shtrese me gure
	Gjelberim
	Shtylle Ndricimi



INVESTITORI
"Bashkia Lezhë"



PROJEKTUESI
"ALBGOLDING 2E"

Studim Projektim - Sistemimi i rrugëve të
brendshme në Bashkinë Lezhë
Rruga Faik Konica

Plani NDRICIMIT

FAZA - PROJEKT ZBATIM

SHKALLA 1:400	Data: 2026
VIZATIMI Nr:	

PROJEKTUES : ALBGOLDING 2E" sh.p.k

CONTACT :
E-MAIL : albgolding2e@gmail.com
Cel: +355 68 52 07 550
+355 68 20 85 763



PROJEKT ZBATIMI

PROJEKTI: "SISTEMIMI I RRUGËVE TË BRENDSHME NË BASHKINË LEZHË"

NËNOBJEKTI: SISTEMIMI I RRUGËS FAIK KONICA, BASHKIA LEZHË.

PLANIMETRIA



INVESTITORI
"Bashkia Lezhë"



PROJEKTUESI
"ALBGOLDING 2E"

*Studim Projektim - Sistemimi i rrugëve të
brendshme në Bashkinë Lezhë
Rruga Faik Konica*

Planimetria

FAZA - PROJEKT ZBATIM

SHKALLA

Data: 2026

VIZATIMI Nr:

ALBGOLDING 2E" sh.p.k

PROJEKTUES :

CONTACT :
E-MAIL : albgolding2e@gmail.com
Cel: +355 68 52 07 550
+355 68 20 85 763



LEGJENDE

- Shtrese me gure
- Gjelberim



INVESTITORI
"Bashkia Lezhë"



PROJEKTUESI
"ALBGOLDING 2E"

Studim Projektim - Sistemimi i rrugëve të
brendshme në Bashkinë Lezhë
Rruga Faik Konica

Planimetria

FAZA - PROJEKT ZBATIM

SHKALLA 1:400

Data: 2026

VIZATIMI Nr:

PROJEKTUES :

ALBGOLDING 2E" sh.p.k

CONTACT :
E-MAIL : albgolding2e@gmail.com
Cel: +355 68 52 07 550
+355 68 20 85 763

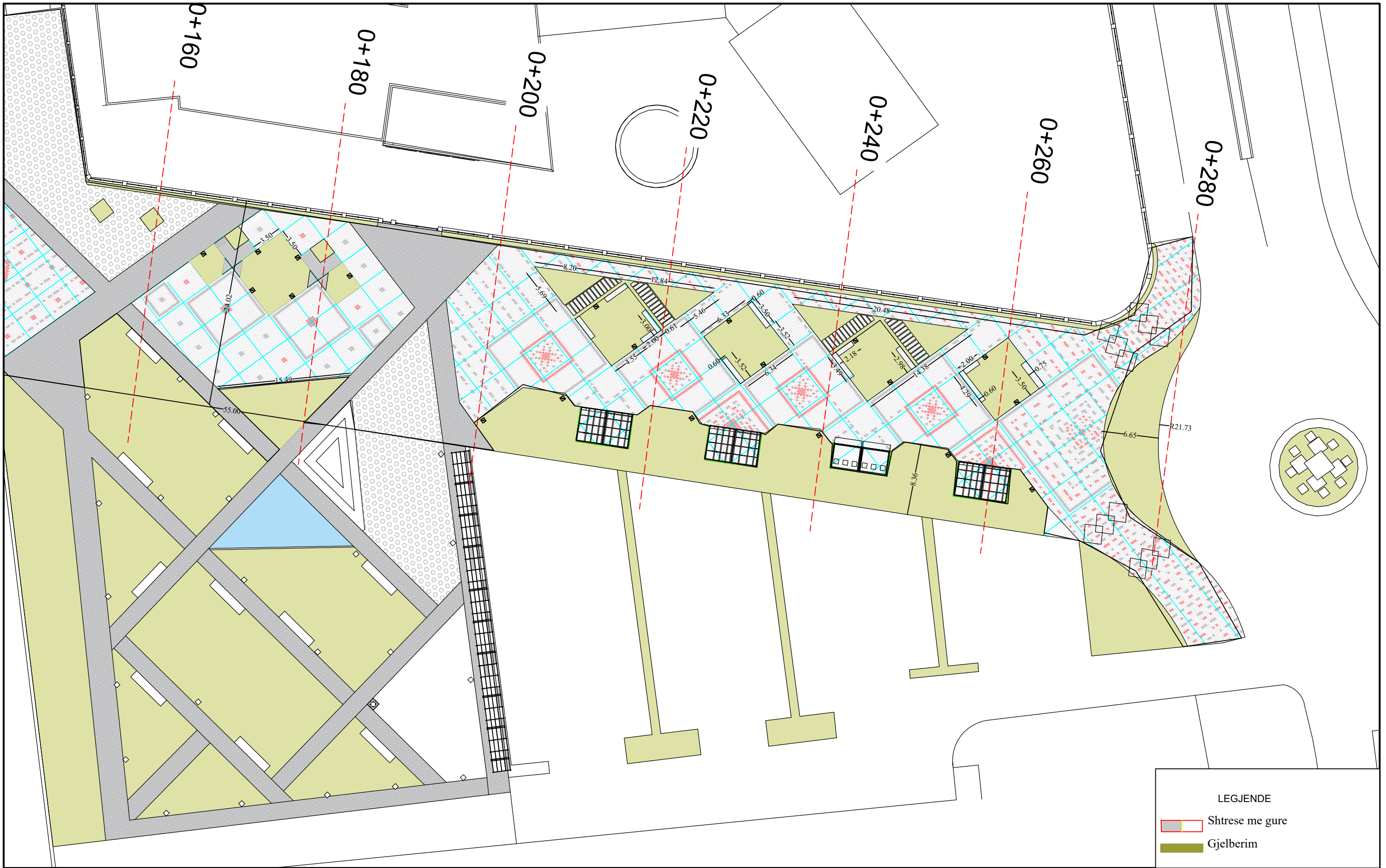

INVESTITORI
"Bashkia Lezhë"



PROJEKTUESI
"ALBGOLDING 2E"

Studim Projektim - Sistemi i rrugëve të brendshme në Bashkinë Lezhë
Rruga Faik Konica

Planimetria

FAZA - PROJEKT ZBATIM

SHKALLA 1:400 Data: 2026

VIZATIMI Nr:

ALBGOLDING 2E" sh.p.k

PROJEKTUES :

CONTACT :
E-MAIL : albgolding2e@gmail.com
Cel: +355 68 52 07 550
+355 68 20 85 763



LEGJENDE

- Shtrese me gure
- Gjelberim



INVESTITORI
"Bashkia Lezhë"



PROJEKTUESI
"ALBGOLDING 2E"

Studim Projektim - Sistemi i rrugëve të
brendshme në Bashkinë Lezhë
Rruga Faik Konica

Planimetria

FAZA - PROJEKT ZBATIM

SHKALLA 1:250

Data: 2026

VIZATIMI Nr:

PROJEKTUES :

ALBGOLDING 2E" sh.p.k

CONTACT :
E-MAIL : albgolding2e@gmail.com
Cel: +355 68 52 07 550
+355 68 20 85 763

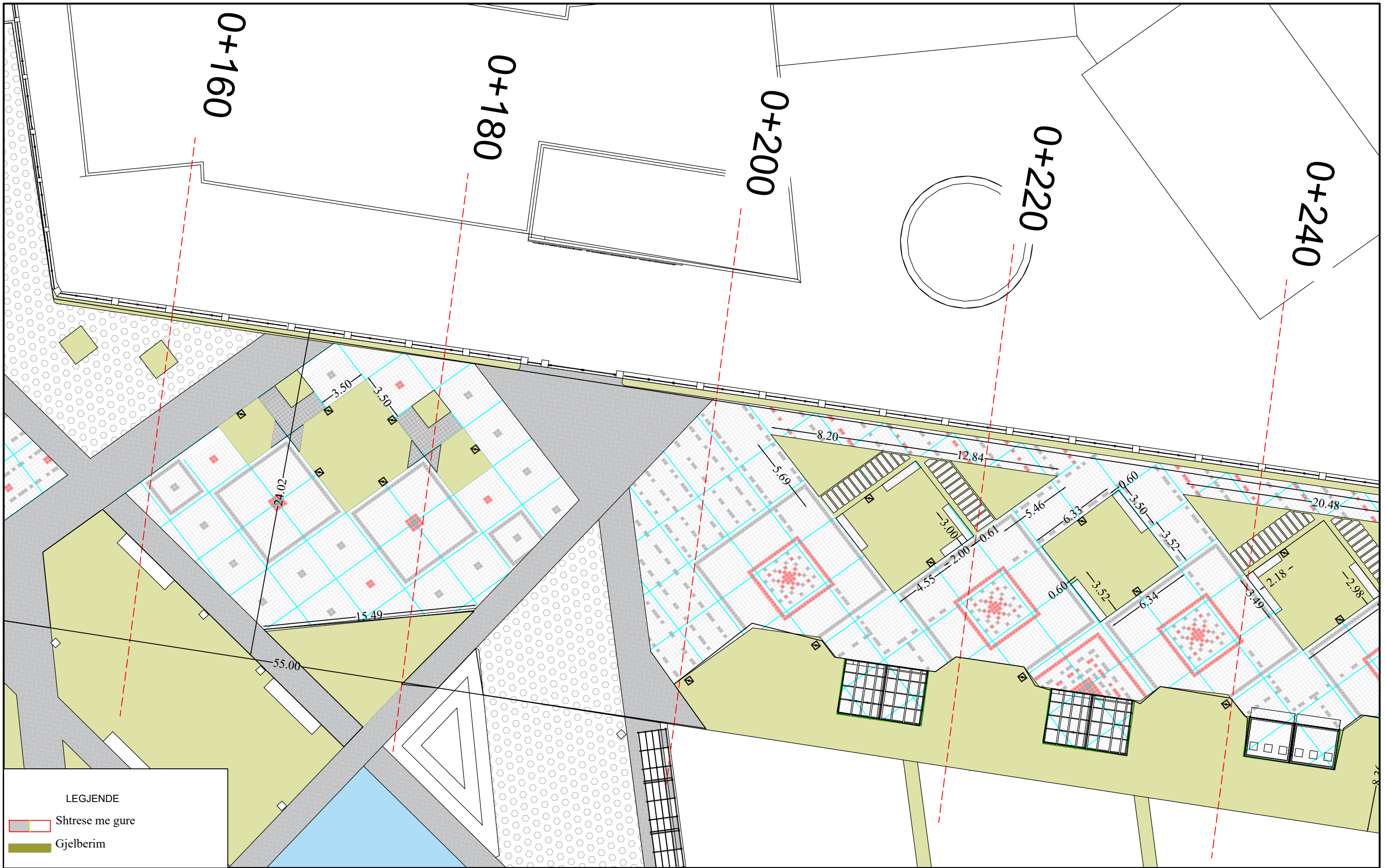

LEGJENDE

- Shtrese me gure
- Gjelberim



INVESTITORI
"Bashkia Lezhë"



PROJEKTUESI
"ALBGOLDING 2E"

Studim Projektim - Sistemi i rrugëve të
brendshme në Bashkinë Lezhë
Rruga Faik Konica

Planimetria

FAZA - PROJEKT ZBATIM

SHKALLA 1:250

Data: 2026

VIZATIMI Nr:



PROJEKTUES :

ALBGOLDING 2E" sh.p.k

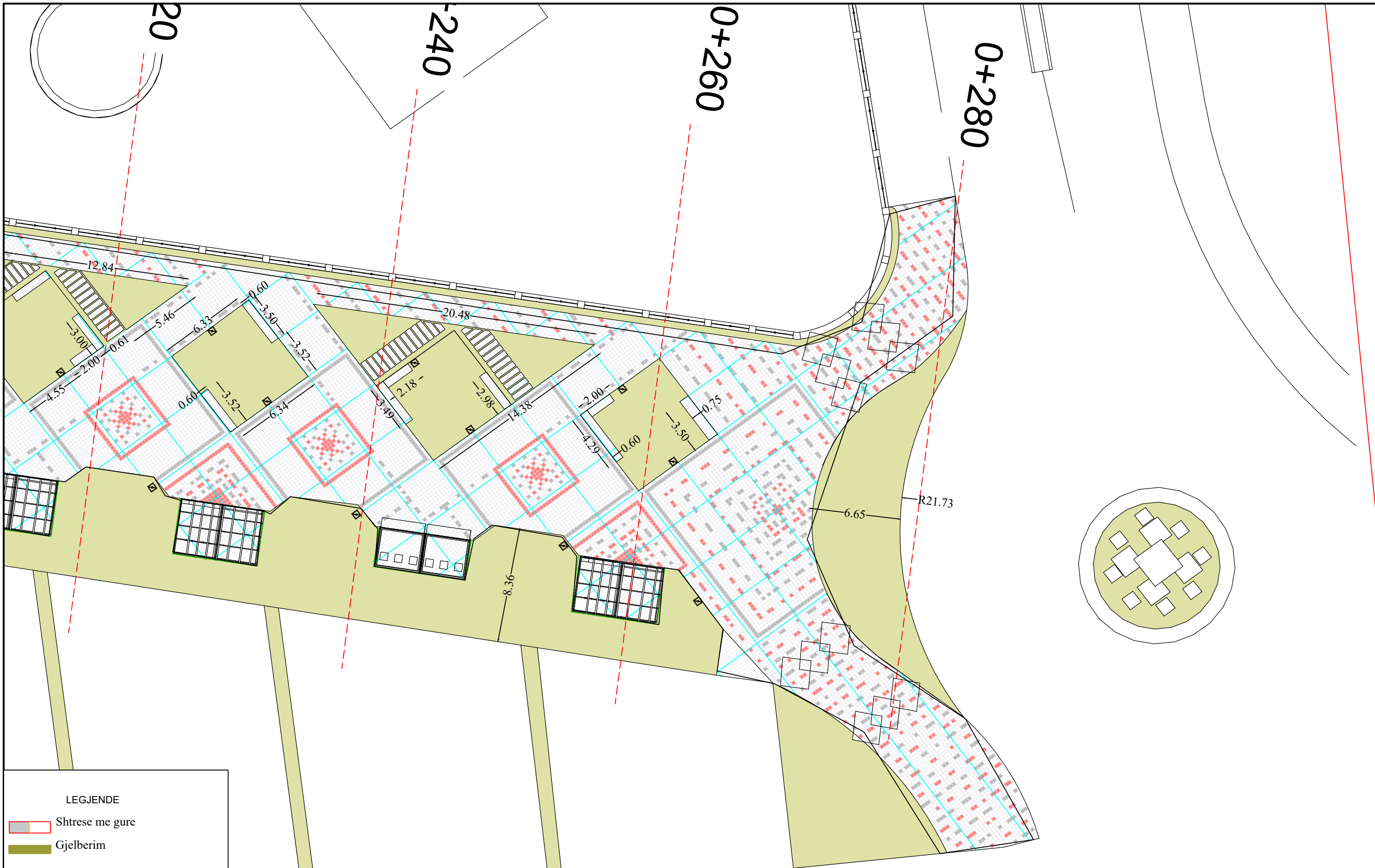
CONTACT :
E-MAIL : albgolding2e@gmail.com
Cel: +355 68 52 07 550
+355 68 20 85 763



LEGJENDE

-  Shtrese me gure
-  Gjelberim



INVESTITORI
"Bashkia Lezhë"



PROJEKTUESI
"ALBGOLDING 2E"

Studim Projektim - Sistemimi i rrugëve të
brendshme në Bashkinë Lezhë
Rruga Faik Konica

Planimetria

FAZA - PROJEKT ZBATIM

SHKALLA 1:250

Data: 2026

VIZATIMI Nr:

PROJEKTUES :

ALBGOLDING 2E" sh.p.k

CONTACT :
E-MAIL : albgolding2e@gmail.com
Cel: +355 68 52 07 550
+355 68 20 85 763



PROJEKT ZBATIMI

PROJEKTI: "SISTEMIMI I RRUGËVE TË BRENDSHME NË BASHKINË LEZHË"

NËNOBJEKTI: SISTEMIMI I RRUGËS FAIK KONICA, BASHKIA LEZHË.

PLANI I SHTRIMIT



INVESTITORI
"Bashkia Lezhë"



PROJEKTUESI
"ALBGOLDING 2E"

*Studim Projektim - Sistemimi i rrugëve të
brendshme në Bashkinë Lezhë
Rruga Faik Konica*

Plani i shtrimit

FAZA - PROJEKT ZBATIM

SHKALLA

Data: 2026

VIZATIMI Nr:

ALBGOLDING 2E" sh.p.k

PROJEKTUES :

CONTACT :
E-MAIL : albgolding2e@gmail.com
Cel: +355 68 52 07 550
+355 68 20 85 763



LEGJENDE

 Shtrese me gure

 Gjelberim



INVESTITORI
"Bashkia Lezhë"



PROJEKTUESI
"ALBGOLDING 2E"

*Studim Projektim - Sistemi i rrugëve të brendshme në Bashkinë Lezhë
Rruga Faik Konica*

PLANI I SHTRIMIT

FAZA - PROJEKT ZBATIM

SHKALLA 1:400	Data: 2026
VIZATIMI Nr:	

ALBGOLDING 2E" sh.p.k

PROJEKTUES :

CONTACT :
E-MAIL : albgolding2e@gmail.com
Cel: +355 68 52 07 550
+355 68 20 85 763

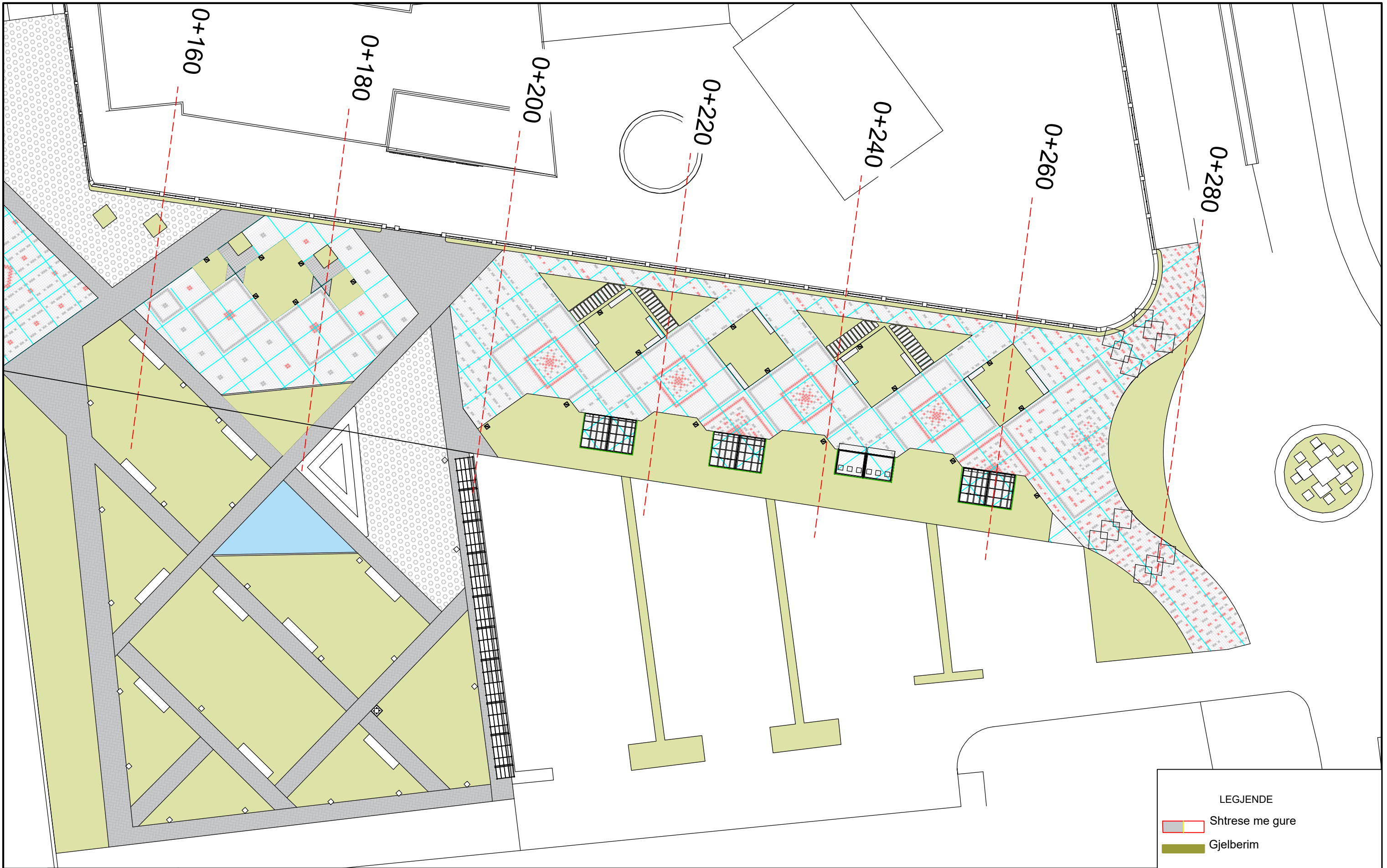

LEGJENDE	
	Shtrese me gure
	Gjelberim



INVESTITORI
"Bashkia Lezhë"



PROJEKTUESI
"ALBGOLDING 2E"

Studim Projektim - Sistemi i rrugëve të
brendshme në Bashkinë Lezhë
Rruga Faik Konica

PLANI I SHTRIMIT

FAZA - PROJEKT ZBATIM

SHKALLA 1:400	Data: 2026
VIZATIMI Nr:	

ALBGOLDING 2E" sh.p.k

PROJEKTUES :

CONTACT :
E-MAIL : albgolding2e@gmail.com
Cel: +355 68 52 07 550
+355 68 20 85 763



PROJEKT ZBATIMI

PROJEKTI: "SISTEMIMI I RRUGËVE TË BRENDSHME NË BASHKINË LEZHË"

NËNOBJEKTI: SISTEMIMI I RRUGËS FAIK KONICA, BASHKIA LEZHË.

ILUSTRIME 3D



INVESTITORI
"Bashkia Lezhë"



PROJEKTUESI
"ALBGOLDING 2E"

*Studim Projektim - Sistemimi i rrugëve të
brendshme në Bashkinë Lezhë
Rruga Faik Konica*

PAMJE 3D

FAZA - PROJEKT ZBATIM

SHKALLA

Data: 2026

VIZATIMI Nr:

ALBGOLDING 2E" sh.p.k

PROJEKTUES :

CONTACT :
E-MAIL : albgolding2e@gmail.com
Cel: +355 68 52 07 550
+355 68 20 85 763



INVESTITORI
"Bashkia Lezhë"



PROJEKTUESI
"ALBGOLDING 2E"

*Studim Projektim - Sistemi i rrugëve të
brendshme në Bashkinë Lezhë
Rruga Faik Konica*

PAMJE 3D

FAZA - PROJEKT ZBATIM

SHKALLA

Data: 2026

VIZATIMI Nr:

PROJEKTUES :

ALBGOLDING 2E" sh.p.k

CONTACT :
E-MAIL : albgolding2e@gmail.com
Cel: +355 68 52 07 550
+355 68 20 85 763



INVESTITORI
"Bashkia Lezhë"



PROJEKTUESI
"ALBGOLDING 2E"

*Studim Projektim - Sistemi i rrugëve të
brendshme në Bashkinë Lezhë
Rruga Faik Konica*

PAMJE 3D

FAZA - PROJEKT ZBATIM

SHKALLA

Data: 2026

VIZATIMI Nr:

PROJEKTUES :

ALBGOLDING 2E" sh.p.k

CONTACT :
E-MAIL : albgolding2e@gmail.com
Cel: +355 68 52 07 550
+355 68 20 85 763



INVESTITORI
"Bashkia Lezhë"



PROJEKTUESI
"ALBGOLDING 2E"

*Studim Projektim - Sistemimi i rrugëve të
brendshme në Bashkinë Lezhë
Rruga Faik Konica*

PAMJE 3D

FAZA - PROJEKT ZBATIM

SHKALLA

Data: 2026

VIZATIMI Nr:

PROJEKTUES :

ALBGOLDING 2E" sh.p.k

CONTACT :
E-MAIL : albgolding2e@gmail.com
Cel: +355 68 52 07 550
+355 68 20 85 763

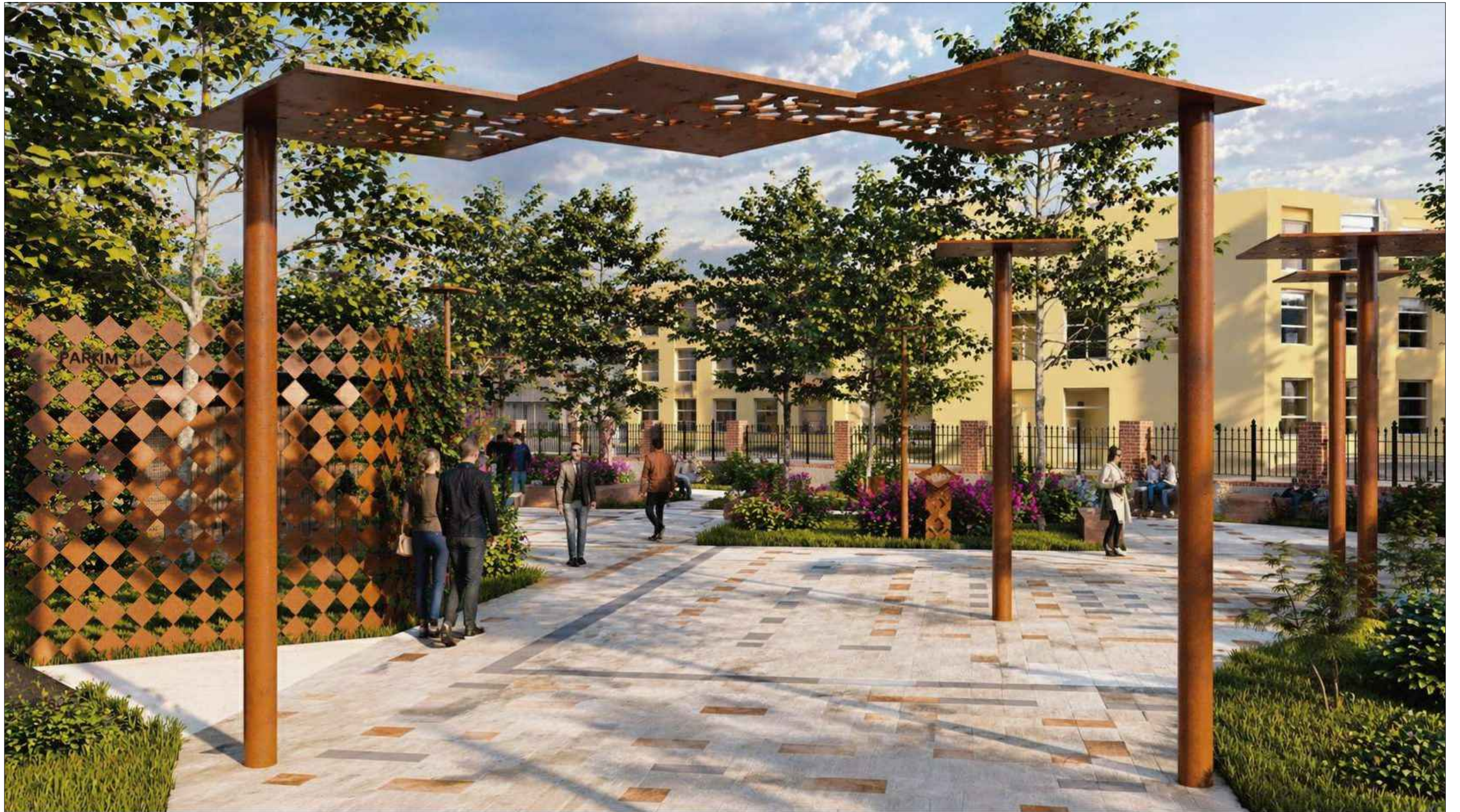

INVESTITORI
"Bashkia Lezhë"



PROJEKTUESI
"ALBGOLDING 2E"

*Studim Projektim - Sistemi i rrugëve të
brendshme në Bashkinë Lezhë
Rruga Faik Konica*

PAMJE 3D

FAZA - PROJEKT ZBATIM

SHKALLA

Data: 2026

VIZATIMI Nr:

PROJEKTUES :

ALBGOLDING 2E" sh.p.k

CONTACT :
E-MAIL : albgolding2e@gmail.com
Cel: +355 68 52 07 550
+355 68 20 85 763



INVESTITORI
"Bashkia Lezhë"



PROJEKTUESI
"ALBGOLDING 2E"

*Studim Projektim - Sistemimi i rrugëve të
brendshme në Bashkinë Lezhë
Rruga Faik Konica*

PAMJE 3D

FAZA - PROJEKT ZBATIM

SHKALLA

Data: 2026

VIZATIMI Nr:

PROJEKTUES :

ALBGOLDING 2E" sh.p.k

CONTACT :
E-MAIL : albgolding2e@gmail.com
Cel: +355 68 52 07 550
+355 68 20 85 763



INVESTITORI
"Bashkia Lezhë"



PROJEKTUESI
"ALBGOLDING 2E"

*Studim Projektim - Sistemimi i rrugëve të
brendshme në Bashkinë Lezhë
Rruga Faik Konica*

PAMJE 3D

FAZA - PROJEKT ZBATIM

SHKALLA

Data: 2026

VIZATIMI Nr:

PROJEKTUES :

ALBGOLDING 2E" sh.p.k

CONTACT :
E-MAIL : albgolding2e@gmail.com
Cel: +355 68 52 07 550
+355 68 20 85 763



INVESTITORI
"Bashkia Lezhë"



PROJEKTUESI
"ALBGOLDING 2E"

*Studim Projektim - Sistemi i rrugëve të
brendshme në Bashkinë Lezhë
Rruga Faik Konica*

PAMJE 3D

FAZA - PROJEKT ZBATIM

SHKALLA

Data: 2026

VIZATIMI Nr:

PROJEKTUES :

ALBGOLDING 2E" sh.p.k

CONTACT :
E-MAIL : albgolding2e@gmail.com
Cel: +355 68 52 07 550
+355 68 20 85 763



INVESTITORI
"Bashkia Lezhë"



PROJEKTUESI
"ALBGOLDING 2E"

*Studim Projektim - Sistemi i rrugëve të
brendshme në Bashkinë Lezhë
Rruga Faik Konica*

PAMJE 3D

FAZA - PROJEKT ZBATIM

SHKALLA

Data: 2026

VIZATIMI Nr:

PROJEKTUES :

ALBGOLDING 2E" sh.p.k

CONTACT :
E-MAIL : albgolding2e@gmail.com
Cel: +355 68 52 07 550
+355 68 20 85 763



INVESTITORI
"Bashkia Lezhë"



PROJEKTUESI
"ALBGOLDING 2E"

*Studim Projektim - Sistemimi i rrugëve të
brendshme në Bashkinë Lezhë
Rruga Faik Konica*

PAMJE 3D

FAZA - PROJEKT ZBATIM

SHKALLA

Data: 2026

VIZATIMI Nr:

PROJEKTUES :

ALBGOLDING 2E" sh.p.k

CONTACT :
E-MAIL : albgolding2e@gmail.com
Cel: +355 68 52 07 550
+355 68 20 85 763



INVESTITORI
"Bashkia Lezhë"



PROJEKTUESI
"ALBGOLDING 2E"

*Studim Projektim - Sistemimi i rrugëve të
brendshme në Bashkinë Lezhë
Rruga Faik Konica*

PAMJE 3D

FAZA - PROJEKT ZBATIM

SHKALLA

Data: 2026

VIZATIMI Nr:

PROJEKTUES :

ALBGOLDING 2E" sh.p.k

CONTACT :
E-MAIL : albgolding2e@gmail.com
Cel: +355 68 52 07 550
+355 68 20 85 763



INVESTITORI
"Bashkia Lezhë"



PROJEKTUESI
"ALBGOLDING 2E"

*Studim Projektim - Sistemimi i rrugëve të
brendshme në Bashkinë Lezhë
Rruga Faik Konica*

PAMJE 3D

FAZA - PROJEKT ZBATIM

SHKALLA

Data: 2026

VIZATIMI Nr:

PROJEKTUES :

ALBGOLDING 2E" sh.p.k

CONTACT :
E-MAIL : albgolding2e@gmail.com
Cel: +355 68 52 07 550
+355 68 20 85 763



INVESTITORI
"Bashkia Lezhë"



PROJEKTUESI
"ALBGOLDING 2E"

*Studim Projektim - Sistemimi i rrugëve të
brendshme në Bashkinë Lezhë
Rruga Faik Konica*

PAMJE 3D

FAZA - PROJEKT ZBATIM

SHKALLA

Data: 2026

VIZATIMI Nr:

PROJEKTUES :

ALBGOLDING 2E" sh.p.k

CONTACT :
E-MAIL : albgolding2e@gmail.com
Cel: +355 68 52 07 550
+355 68 20 85 763



PROJEKT ZBATIMI

PROJEKTI: "SISTEMIMI I RRUGËVE TË BRENDSHME NË BASHKINË LEZHË"

NËNOBJEKTI: SISTEMIMI I RRUGËS FAIK KONICA, BASHKIA LEZHË.

RILEVIMI TOPOGRAFIK



INVESTITORI
"Bashkia Lezhë"



PROJEKTUESI
"ALBGOLDING 2E"

*Studim Projektim - Sistemimi i rrugëve të
brendshme në Bashkinë Lezhë
Rruga Faik Konica*

RILEVIMI TOPOGRAFIK

FAZA - PROJEKT ZBATIM

SHKALLA

Data: 2026

VIZATIMI Nr:

ALBGOLDING 2E" sh.p.k

PROJEKTUES :

CONTACT :
E-MAIL : albgolding2e@gmail.com
Cel: +355 68 52 07 550
+355 68 20 85 763



INVESTITORI
"Bashkia Lezhë"



PROJEKTUESI
"ALBGOLDING 2E"

*Studim Projektim - Sistemi i rrugëve të
brendshme në Bashkinë Lezhë
Rruga Faik Konica*

RILEVIM TOPOGRAFIK

FAZA - PROJEKT ZBATIM

SHKALLA 1:1000	Data: 2026
VIZATIMI Nr:	

ALBGOLDING 2E" sh.p.k

PROJEKTUES :

CONTACT :
E-MAIL : albgolding2e@gmail.com
Cel: +355 68 52 07 550
+355 68 20 85 763