

AUTORITETI KONTRAKTOR:  
BASHKIA DIBËR



MIRATOHET  
BASHKIA DIBËR  
KRYETARI  
Z. RAHIM SPAHIU

KONSULENTI: "2 ED" sh.p.k



"2 ED" sh.p.k

# PROJEKT - ZBATIMI

PROJEKT

**Objekti:** "Sistemim asfaltim i rruges se lagjes LLixha, Bashkia Diber"

VITI 2022

AUTORITETI KONTRAKTOR:  
BASHKIA DIBËR



KONSULENTI: "2 ED" sh.p.k



Adresa: Rruga "Bardhyl", Njesia Bashkiake nr. 8, TIRANË



# PROJEKT - ZBATIMI

VITI 2022

"2 ED"

sh.p.k

- Rilevimi Topografik
- Aksi me Elementët Gjeometrikë
- Planimetria dhe Profili Gjatësor
- Seksionet Tërthore
- Profilet Tip të Rrugës
- Planimetria dhe Detajet K.U.Z

PROJEKT

**Objekti:** "Sistemim asfaltim i rruges se lagjes L Lixha, Bashkia Diber"



Porositë  
BASHKIA DIBER

Objekti: Sistemim asfaltim i rruges se lagjes LLixha, Bashkia Diber

Emertimi:

AKSI ME ELEMENTET GJEOMETRIK

PROJEKT ZBATIMI

GRUPI PROJEKTES	Ing.Hidro. Mark PEMAJ	Firma: [Stamp]
	Ing.Top. Bilbil NURÇE	Firma: -ALBANI-
Periudha:	QESHOR 2022	
	Shkalla:	1:1000
	Fleta:	Nr.





**2D** PROJEKTIM  
DESIGN  
SUPERVISION  
KOLAUDIM  
Adresa: Rruga "Bardhyf", Njesia Bashkiake nr. 8, TIRANE



Porositesi  
**BASHKIA DIBER**

**Objekti:** Sistemim asfaltim i rruges se lagjes L Lixha, Bashkia Diber

Emertimi:

RILEVIMI I RRUGES

PROJEKT ZBATIMI

GRUPI  
PROJEKTUES

Ing. Hidro. Mark PEMAJ  
Ing. Top. Bilbil NURÇE

Periudha:  
QESHOR 2022



Firma:  
Firma:  
Shkalla: 1:1000  
Fleta: Nr. 1

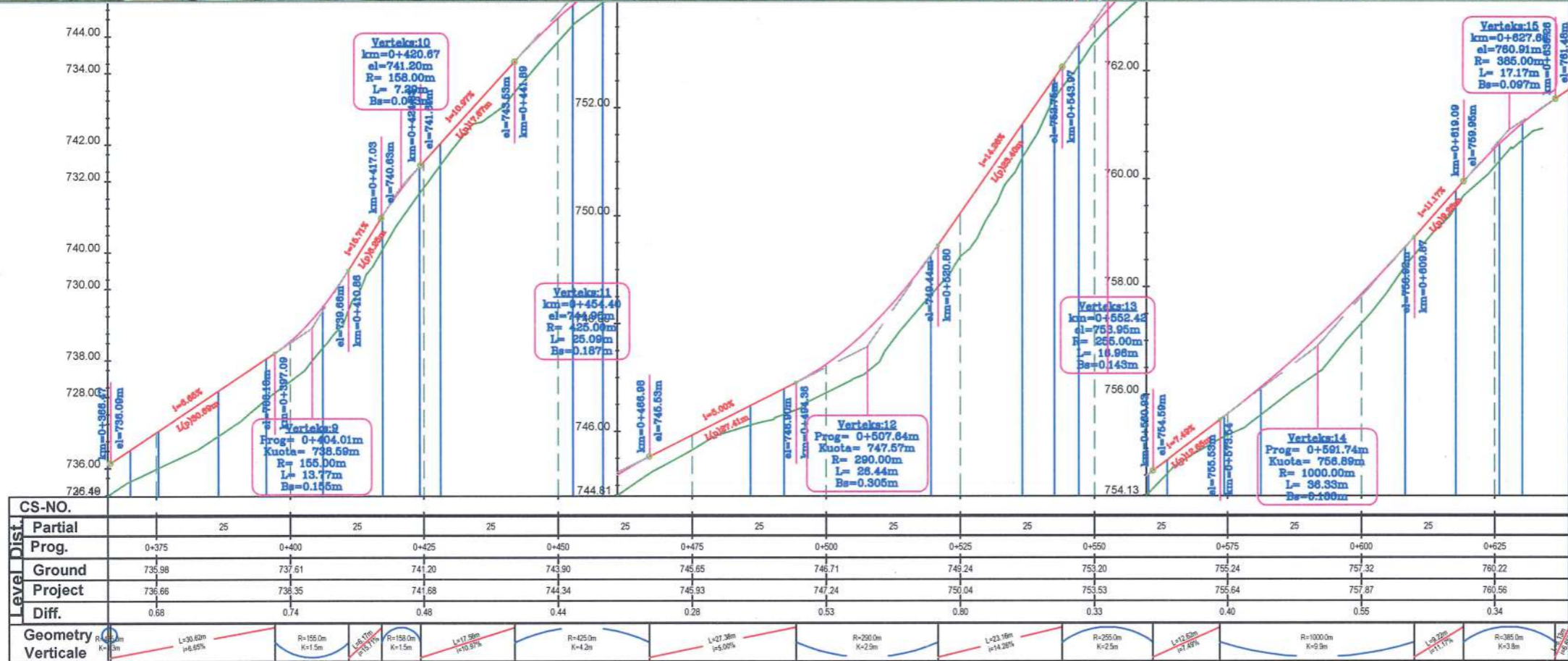

CS-NO.	Partial	25	25	25	25	25	25	25	25	25	25	25	25	25	25	25
Prog.	0+375	0+400	0+425	0+450	0+475	0+500	0+525	0+550	0+575	0+600	0+625					
Ground	735.98	737.61	741.20	743.90	745.65	746.71	749.24	753.20	755.24	757.32	760.22					
Project	736.66	738.35	741.68	744.34	745.93	747.24	750.04	753.53	755.64	757.87	760.56					
Diff.	0.68	0.74	0.48	0.44	0.28	0.53	0.80	0.33	0.40	0.55	0.34					

**2D** PROJEKTIM  
DESIGN  
SUPERVISION  
KOLAUDIM  
Adresa: Rruga "Bardhyt", Njesia Bashkiake nr. 8, TIRANE

Porositesi  
**BASHKIA DIBER**

Objekti: Sistemim asfaltim i rruges se lagjes Llixha, Bashkia Diber

Emertimi:  
PLANIMETRIA &  
PROFILI GJATESOR

PROJEKT ZBATIMI

GRUPI PROJEKTES  
Ing.Hidro. Mark PEMAJ  
Ing.Top. Bilbil NURÇE  
Periudha:  
QESHOR 2022

Firma:  
Firma:  
Shkalla: 1:1000  
Fleta: Nr. 2

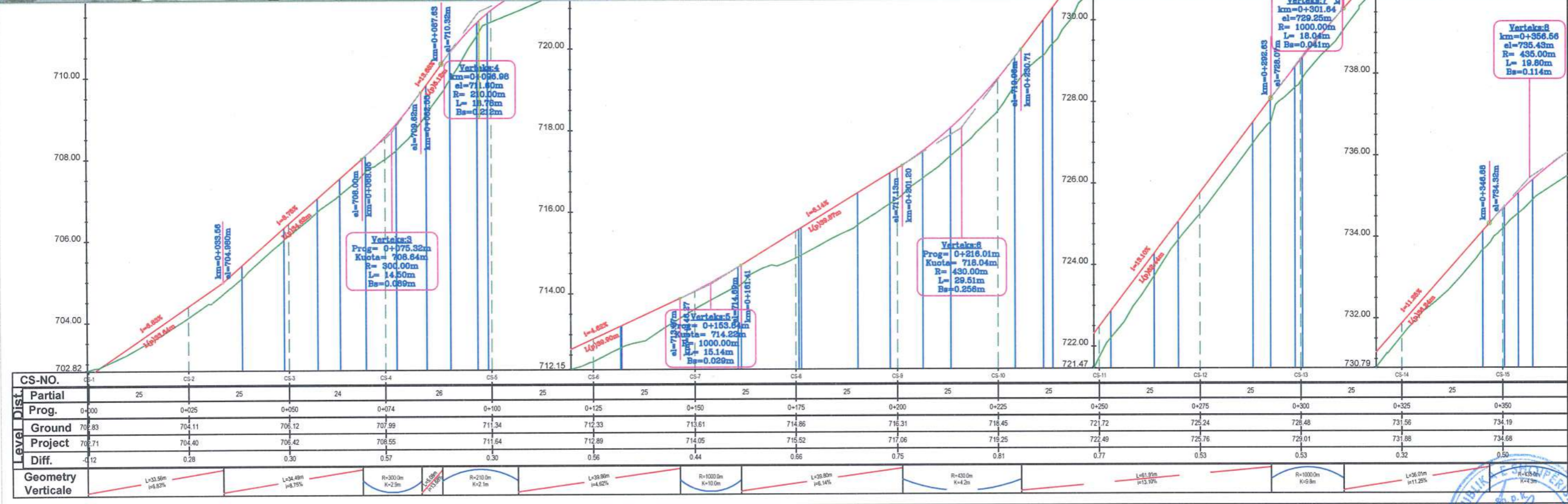

**2ED** PROJEKTIM  
DESIGN  
SUPERVISION  
KOLAUDIM  
Adresa: Rruga "Bardhyl", Njesia Bashkiake nr. 8, TIRANE

**Porositesi**  
**BASHKIA DIBER**

**Objekti:** Sistemim asfaltim i rruges se lagjes LLixha, Bashkia Diber

**Emertimi:**  
**PLANIMETRIA & PROFILI GJATESOR**

**PROJEKT ZBATIMI**

**GRUPI PROJEKTUES**  
Ing. Hidro. Mark PEMAJ  
Ing. Top. Bilbil NURÇE

**Periudha:**  
**QESHOR 2022**

**Firma:** [Stamp]  
**Firma:** [Stamp]

Shkalla: 1:1000  
Fleta: Nr. 1

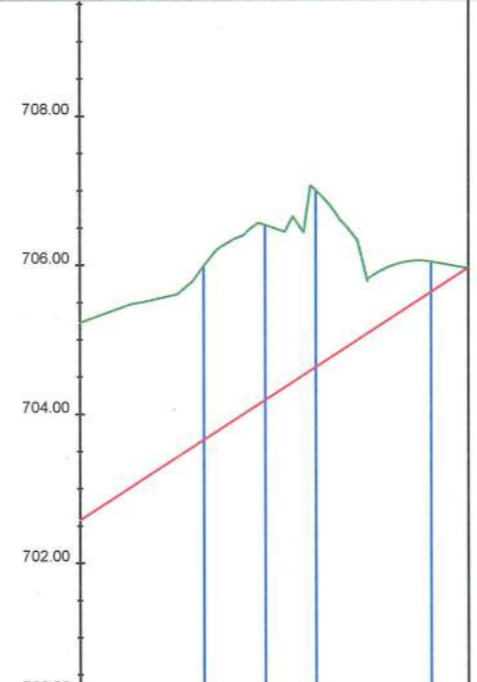

CS-NO.	CS-1	CS-2	CS-3	CS-4
Partial	20	20	12	
Prog.	0+00	0+020	0+040	0+052
Ground	705.23	706.30	705.89	705.97
Project	702.58	703.87	705.16	705.96
Diff.	-2.65	-2.43	-0.73	-0.01

Geometry Verticale  
 L=68.80m  
 P=6.45%

**2D** PROJEKTIM  
 DESIGN  
 SUPERVISION  
 KOLAUDIM  
 Adresa: Rruga "Bardhyl", Njesia Bashkiake nr. 8, TIRANE

Porositesi  
**BASHKIA DIBER**

**Objekti:** Sistemim asfaltim i rruges se lagjes Llixha, Bashkia Diber

Emertimi:  
**PLANIMETRIA & PROFILI GJATESOR**

**PROJEKT ZBATIMI**

GRUPI PROJEKTUES	Ing.Hidro. Mark PEMAJ	Firma:
	Ing.Top. Bilbil NURÇE	Firma:
Periudha:	QESHOR 2022	
Fleta:	Nr. 1	Shkalla: 1:1000





**2D** PROJEKTIM  
DESIGN  
SUPERVISION  
KOLAUDIM  
Adresa: Rruga "Bardhyt", Njesia Bashkiake nr. 8, TIRANE

 Porositesi  
**BASHKIA DIBER**

**Objekti:** Sistemim asfaltim i rruges se lagjes L Lixha, Bashkia Diber

Emertimi:  
**HOROGRAFIA**

**PROJEKT ZBATIMI**

GRUPI PROJEKTUES  
Ing. Hidro. Mark PEMAJ  
Ing. Top. Bilbil NURÇE  
Periudha:  
**QESHOR 2022**

Firma:  
  
Firma:  
  
Shkalla: 1:1000  
Fleta: Nr. 1





— Tub HDPE Ø315mm      ● Pusele kontrolli 1x1x1.5-2m  
 — Tub HDPE Ø250mm      ● Pusele Shkakimi 0.8x0.8x1m

**PRERJA TERTHORE KUZ TUB HDPE Ø315mm**  
 (Technical drawing showing cross-section of a 315mm HDPE pipe with a control manhole)

**PRERJA TERTHORE KUZ TUB HDPE Ø250mm**  
 (Technical drawing showing cross-section of a 250mm HDPE pipe with a reduction manhole)

**2D** PROJEKTIM  
 DESIGN  
 SUPERVISION  
 KOLAUDIM  
 Adresa: Rruga "Barahy", Njesia Bashkiake nr. 8, TIRANE

**Porositesi**  
**BASHKIA DIBER**  
**Objekti:** Sistemim asfaltim i rruges se lagjes LLixha, Bashkia Diber

**Emertimi:**  
 PLANIMETRIA KUZ  
**PROJEKT ZBATIMI**

**GRUPI PROJEKTUES**  
 Ing. Hidro. Mark PEMAJ      Firma:  
 Ing. Top. Bilbil NURÇE      Firma:  
**QESHOR 2022**  
 Periudha:  
 Shkalla: 1:1000  
 Fleta: Nr. 1





**2D** PROJEKTIM  
DESIGN  
SUPERVISION  
KOLAUDIM  
Adresa: Rruga "Bardhyt", Njesia Bashkiake nr. 8, TIRANE

 **Porositesi**  
**BASHKIA DIBER**

**Objekti:** Sistemim asfaltim i rruges se lagjes LLixha, Bashkia Diber

Emertimi:  
**SINJALISTIKA**

**PROJEKT ZBATIMI**

GRUPI PROJEKTES  
Ing. Hidro. Mark PEMAJ  
Ing. Top. Bilbil NURÇE

Periudha:  
**QESHOR 2022**

Firma:  
  
Firma:  
Shkalla: 1:1000  
Fleta: Nr. 1

Profili terthor tip 1 i rruges kryesore  
Km 0+000 - Km 0+053

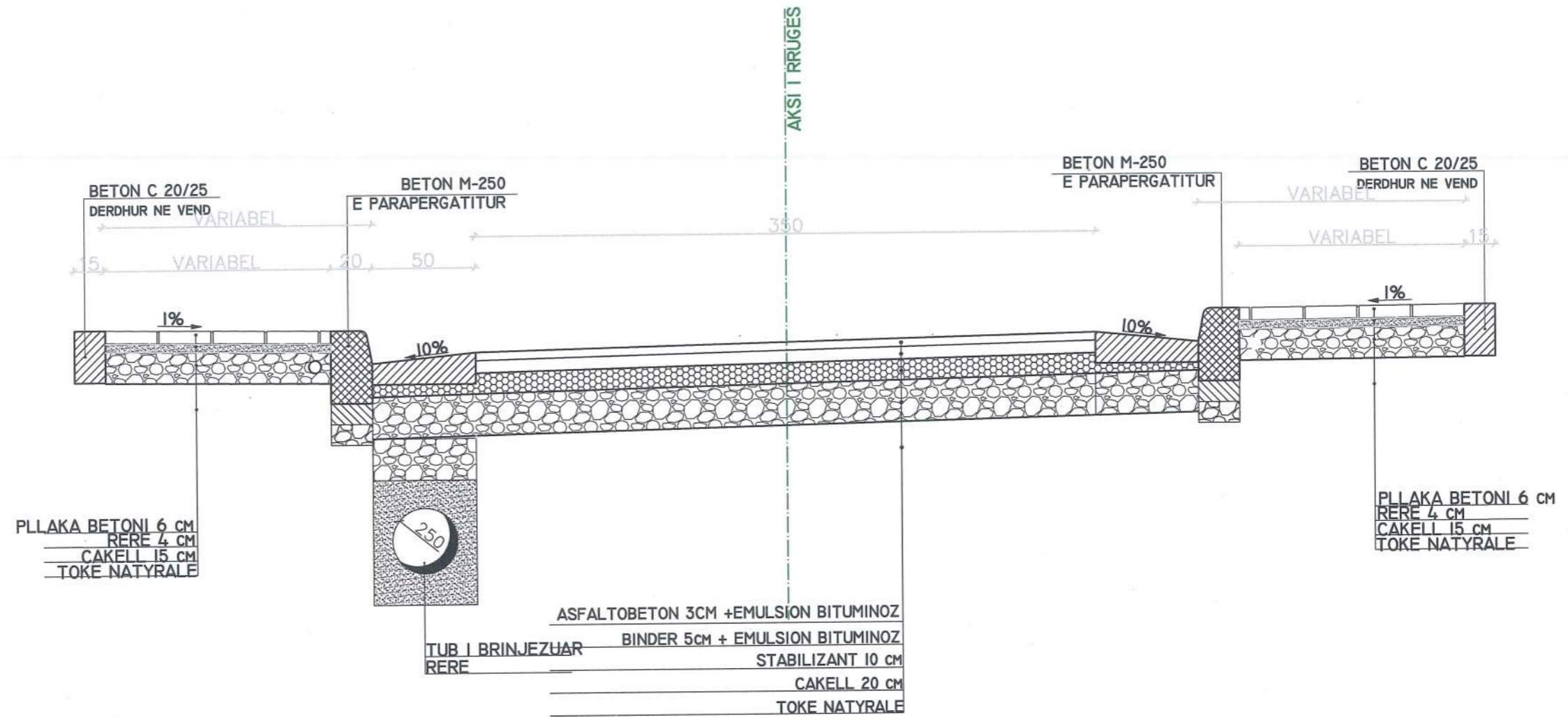

**2ED** PROJEKTIM  
DESIGN  
SUPERVISION  
KOLAUDIM  
Adresa: Rruga "Bardhyt", Njesia Bashkiake nr. 8, TIRANE



Porositesi  
**BASHKIA DIBER**

Objekti: Sistemim asfaltim i rruges se  
lagjes Llixha, Bashkia Diber

Emertimi:

PROFILET TIP TE RRUGES

PROJEKT - ZBATIMI

GRUPI  
PROJEKTUES

Ing. Hidro. Mark PEMAJ

Ing. Top. Bilbil NURÇE

Periudha:

QESHOR 2022

Firma:

Firma:

Shkalla: 1:25

Fleta: Nr. 1



Profili terthor tip 2 i rruges kryesore  
Km 0+053 - Km 0+074

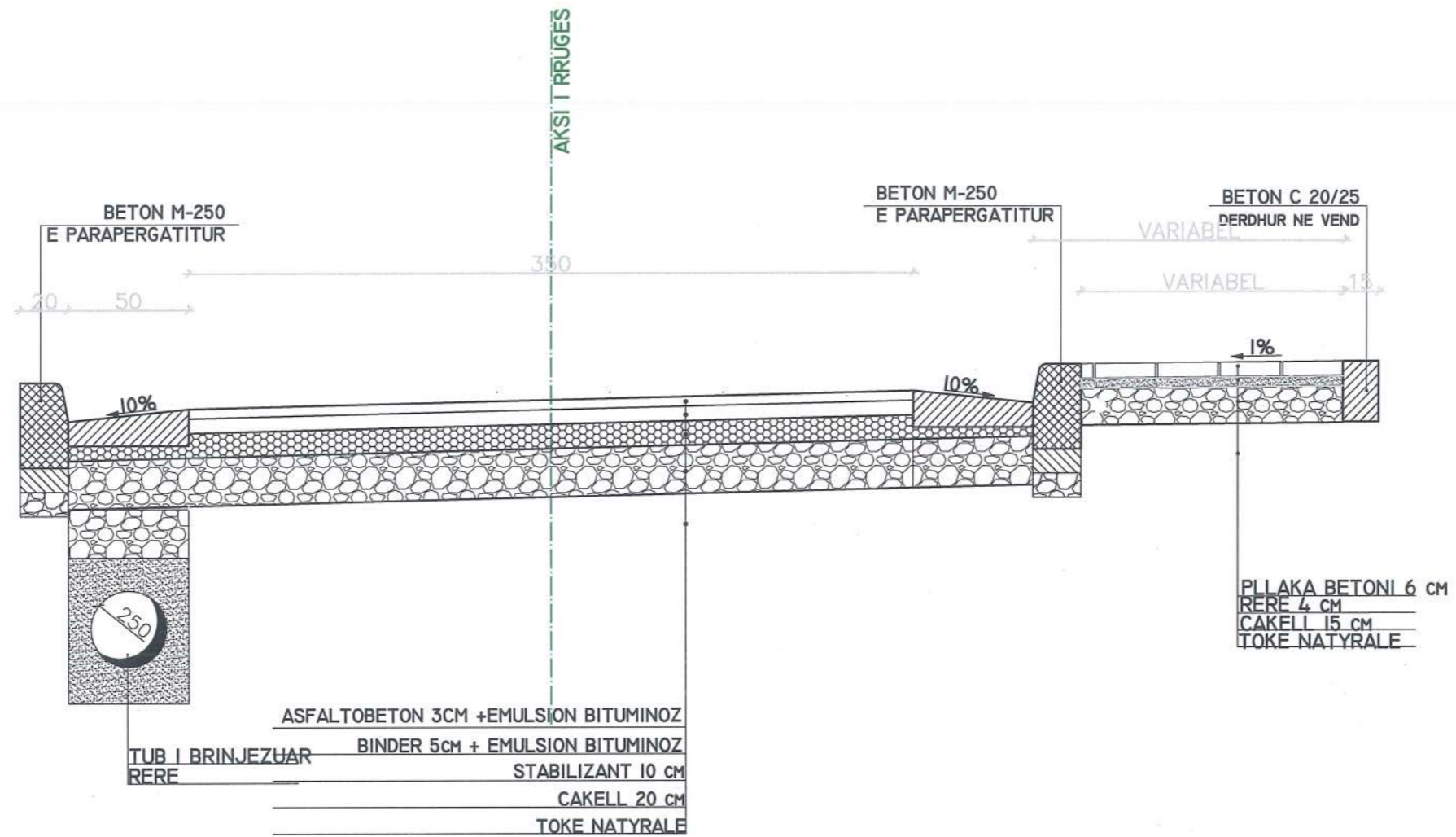

**2D** PROJEKTIM  
DESIGN  
SUPERVISION  
KOLAUDIM  
Adresa: Rruga "Bardhyl", Njesia Bashkiake rr. 8, TIRANE



Porositesi  
**BASHKIA DIBER**

Objekti: Sistemim asfaltim i rruges se lagjes L Lixha, Bashkia Diber

Emertimi:

PROFLET TIP TE RRUGES

PROJEKT - ZBATIMI

GRUPI  
PROJEKTUES

Ing.Hidro. Mark PEMAJ

Ing.Top. Bilbil NURÇE

Periudha:

QESHOR 2022

Firma:

Firma:

Shkalla:

Fleta:

1:25

Nr. 2



**Profili terthor tip 3 i rruges kryesore**  
**Km 0+074 - Km 0+422**  
**Km 0+519-Km 0+529**

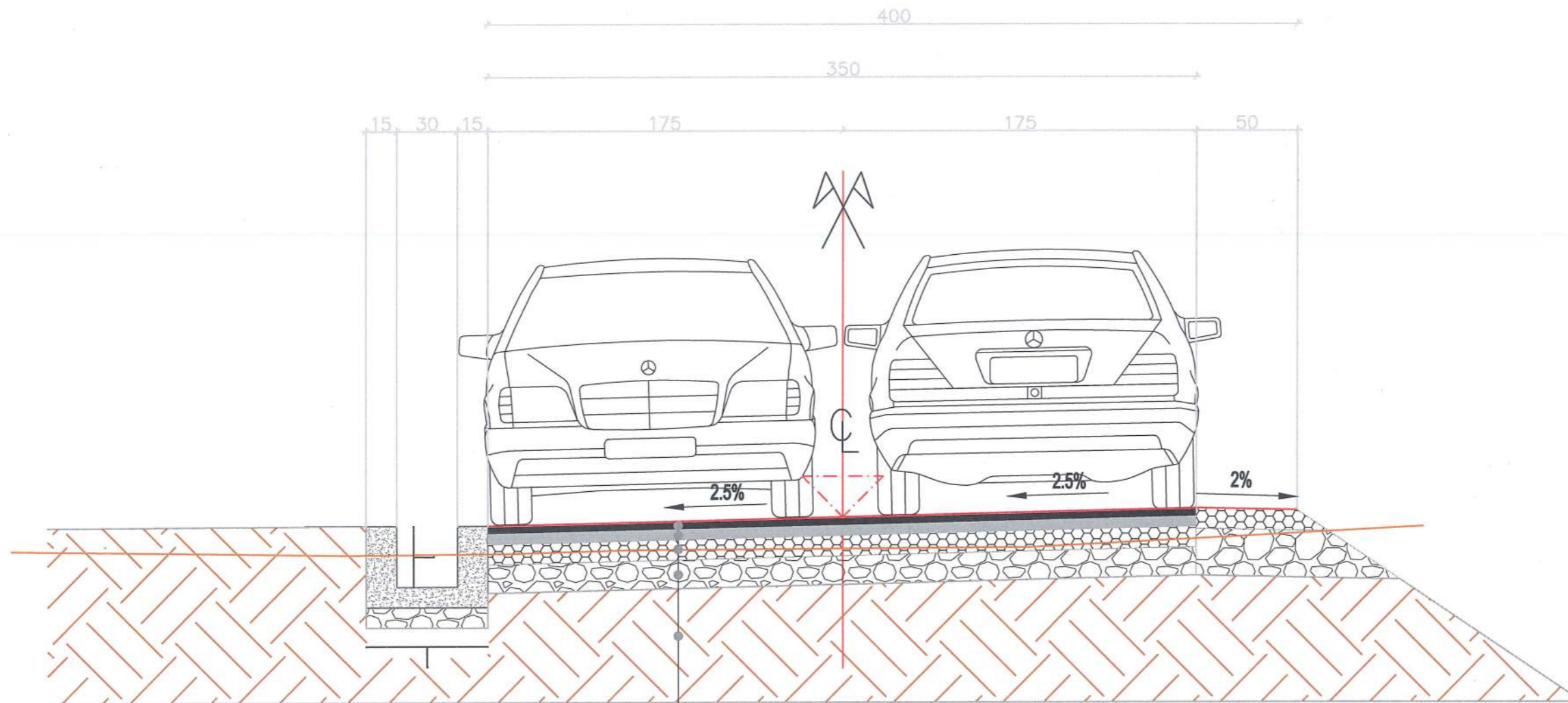

- Shtrese asfaltbetoni me zall lavatriçe, 3 cm, perhapur e ngjeshur me makineri
- Shtrese binderi me zall lavatriçe, 5 cm, perhapur e ngjeshur me makineri
- Shtrese stabilizant t=10cm, perhapur e ngjeshur me makineri
- Shtrese çakelli t=20cm, perhapur e ngjeshur me makineri
- Toke natyrale

**2D** PROJEKTIM  
 DESIGN  
 SUPERVISION  
 KOLAUDIM  
 Adresa: Rruga "Bardhyl", Njesia Bashkiake nr. 8, TIRANE



Porositesi  
**BASHKIA DIBER**

**Objekti:** Sistemim asfaltim i rruges se lagjes Llixha, Bashkia Diber

Emertimi:

**PROFLET TIP TE RRUGES**

**PROJEKT - ZBATIMI**

GRUPI  
 PROJEKTUES

Ing.Hidro. Mark PEMAJ

Ing.Top. Bilbil NURÇE

Periudha:

**QESHOR 2022**

Firma:

Firma:

Shkalla: 1:25

Fleta: Nr. 3



Profili terthor tip 4 i rruges kryesore  
Km 0+0422 - Km 0+519

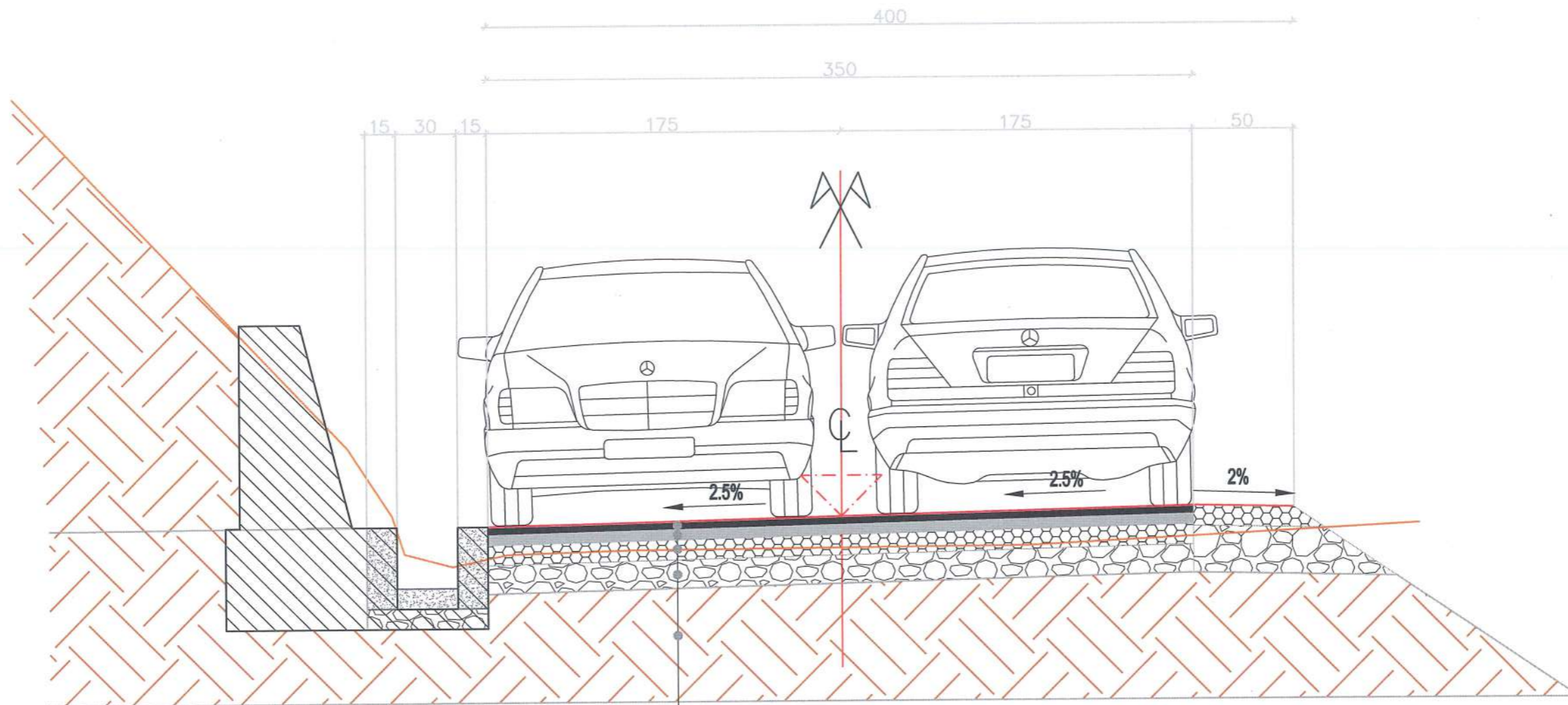

- Shtrese asfaltobetoni me zall lavatriçe, 3 cm, perhapur e ngjeshur me makineri
- Shtrese binderi me zall lavatriçe, 5 cm, perhapur e ngjeshur me makineri
- Shtrese stabilizant t=10cm, perhapur e ngjeshur me makineri
- Shtrese çakelli t=20cm, perhapur e ngjeshur me makineri
- Toke natyrale

**2D** PROJEKTIM  
DESIGN  
SUPERVISION  
KOLAUDIM  
Adresa: Rruga "Bardhyl", Njesia Bashklike rr. 8, TIRANË



Porositesi  
**BASHKIA DIBER**

**Objekti:** Sistemim asfaltim i rruges se lagjes Llixha, Bashkia Diber

Emertimi:

**PROFLET TIP TE RRUGES**

**PROJEKT - ZBATIMI**

GRUPI  
PROJEKTUES

Ing. Hidro. Mark PEMAJ  
Ing. Top. Bilbil NURÇE

Firma:  
Firma:

Periudha:  
**QESHOR 2022**

Shkalla: 1:25  
Fleta: Nr. 4



**Profili terthor tip 5 i rruges kryesore  
Km 0+0529 - Km 0+630**

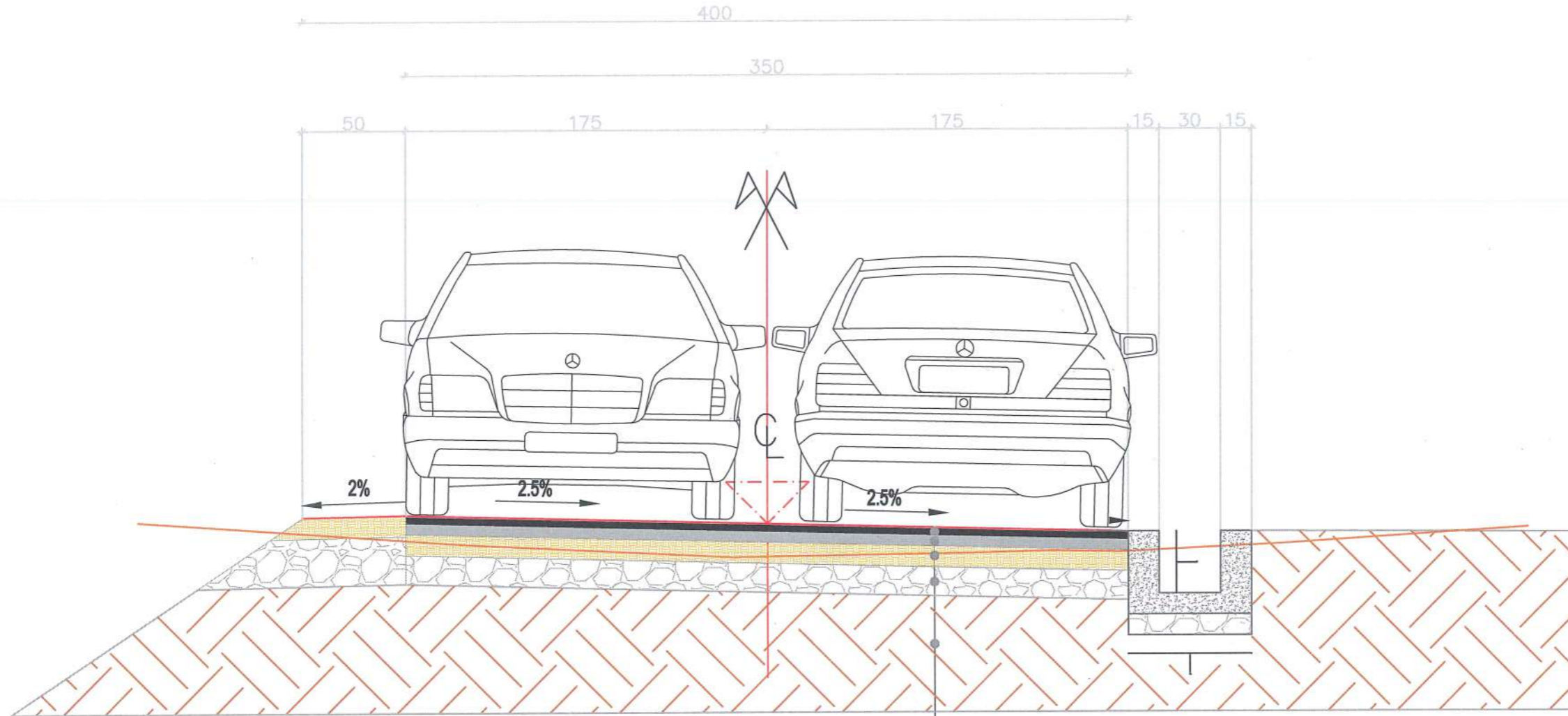

- Shtrese asfaltobetoni me zall lavatriçe, 3 cm, perhapur e ngjeshur me makineri
- Shtrese binderi me zall lavatriçe, 5 cm, perhapur e ngjeshur me makineri
- Shtrese stabilizant t=10cm, perhapur e ngjeshur me makineri
- Shtrese çakelli t=20cm, perhapur e ngjeshur me makineri
- Toke natyrale

**2D** PROJEKTIM  
DESIGN  
SUPERVISION  
KOLAUDIM  
Adresa: Rruga "Bardhyl", Njesia Bashkiake nr. 8, TIRANE



Porositesi  
**BASHKIA DIBER**

**Objekti:** Sistemim asfaltim i rruges se lagjes Llixha, Bashkia Diber

Emertimi:

**PROFLET TIP TE RRUGES**

**PROJEKT - ZBATIMI**

GRUPI  
PROJEKTUES

Ing. Hidro. Mark PEMAJ

Ing. Top. Bilbil NURÇE

Periudha:

**QESHOR 2022**

Firma:

Firma:

Shkalla: 1:25

Fleta: Nr. 5



# PUSETE KONTROLI PER KANALIZIMET E UJERAVE TE ZEZA

PLANIMETRIA SH. 1 / 25

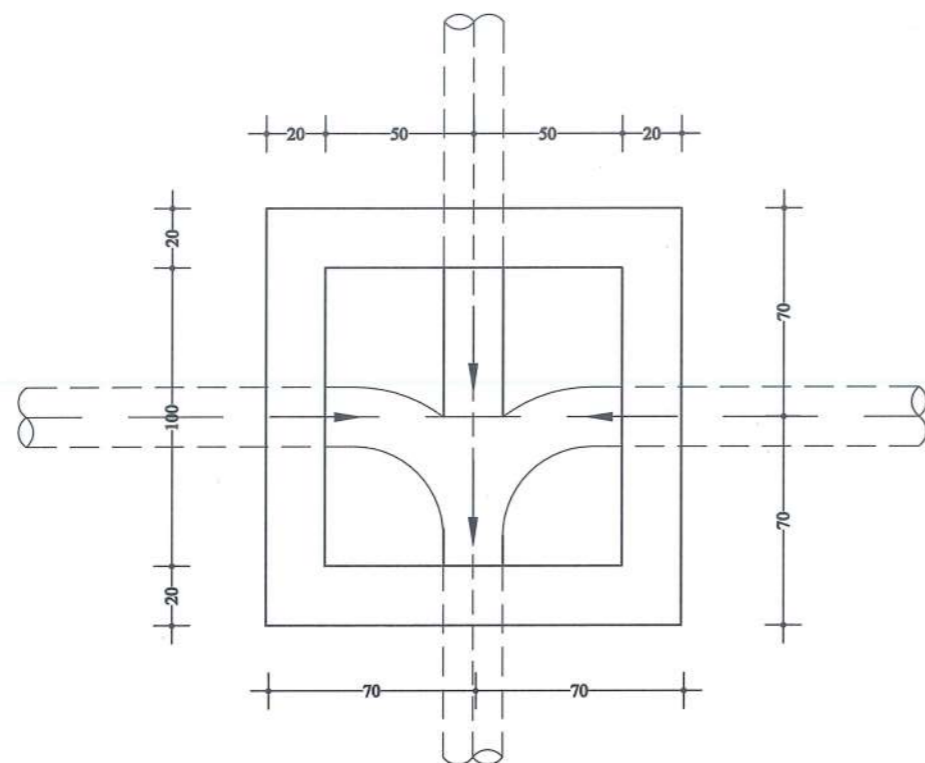

PLANIMETRIA E HYRJES NE PUSETE SH. 1 / 25

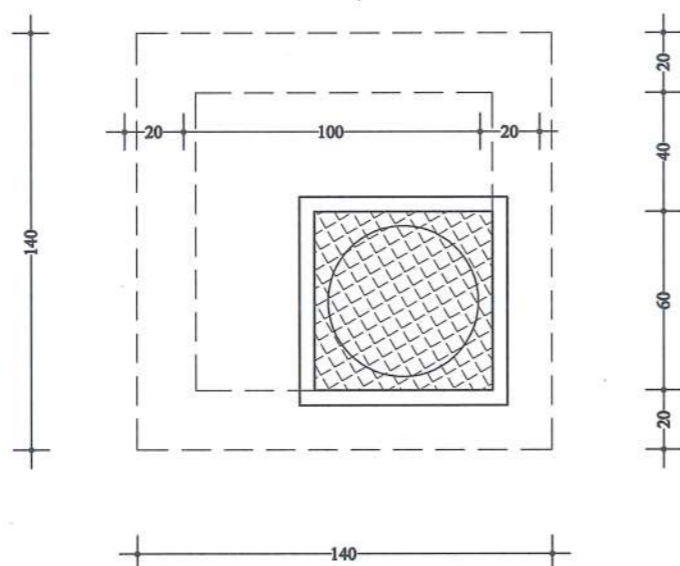

PRERJA 1 - 1 S H.1:25

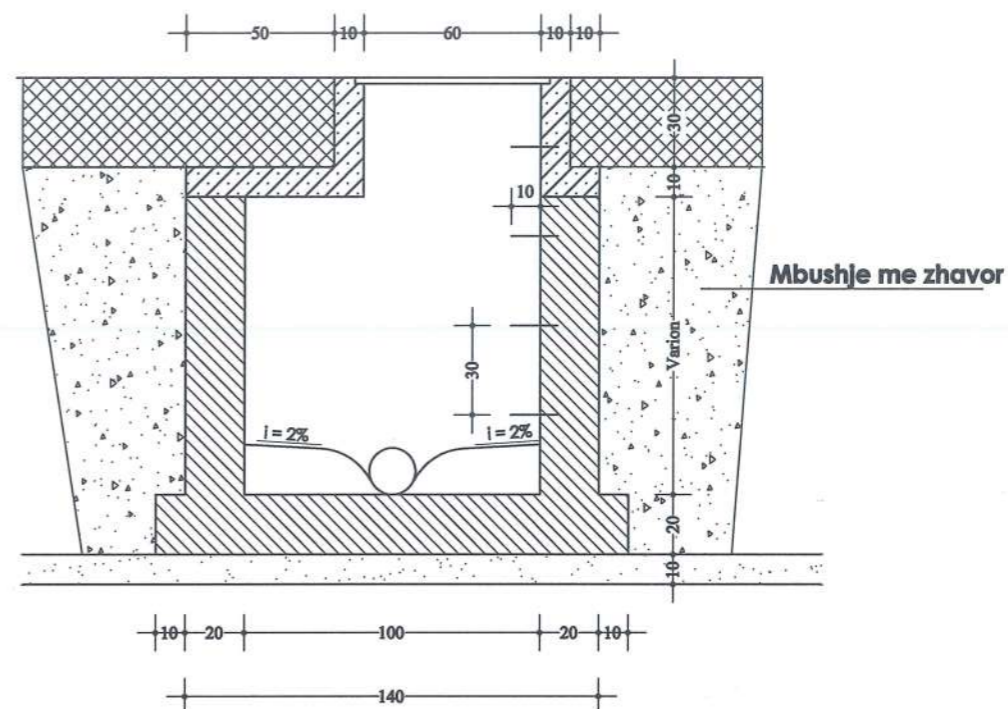

**SHENIME:**

1. Betoni per mure ulluk dhe dysHEME do te behet me beton M - 150, ndersa per solete beton M - 200
2. Hekuril qe do te perdoret te jete Ç-3 me Rak = 2100 kg/cm<sup>2</sup>
3. Rekomandohete qe kapaket do te jene prej gize (ne rast mungese ato mund te zevendesohen me kapake prej betoni te armuar)
4. Niveli i kapakeve do te jete ne nivel me rugen
5. Niveli i kapakeve do te jete 30 cm mbi token kur ajo eshte jashte ruges
6. Çdo puse te kanalizimesh do te kete lidhje sekondare ne te dyja anet e ruges

**2D** PROJEKTIM  
DESIGN  
SUPERVISION  
KOLAUDIM  
Adresa: Rruga "Barthyl", Njesia Bashkiake rr. 8, TIRANE



Porositesi  
**BASHKIA DIBER**

Objekti: Sistemim asfaltim i rruges se lagjes Llixha, Bashkia Dibër

Emertimi:

DETAJE TE PUSETES K.U.Z

PROJEKT - ZBATIMI

GRUPI  
PROJEKTUES

Ing. Hidro. Mark PEMAJ

Ing. Top. Bilbil NURÇE

Periudha:

QESHOR 2022

Firma:

Firma:

Shkalla:

Fleta:

1:25

Nr. 1





# TROTUARI, BORDURAT DHE KUNETA

PRERJE E TROTUARIT

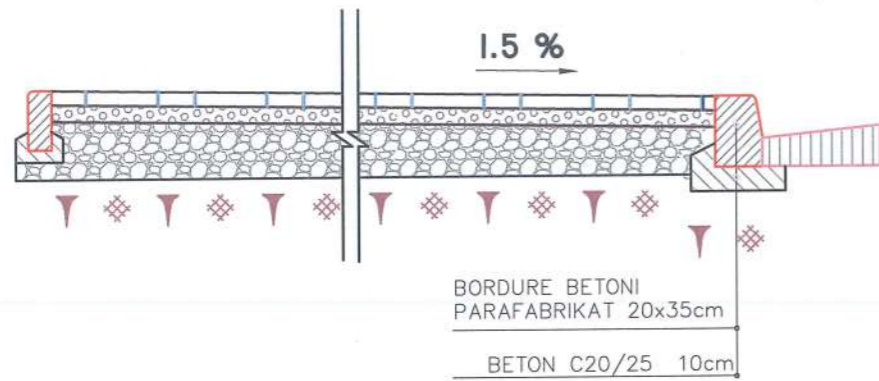

PAMJE E BORDURAVE DHE TROTUARIT

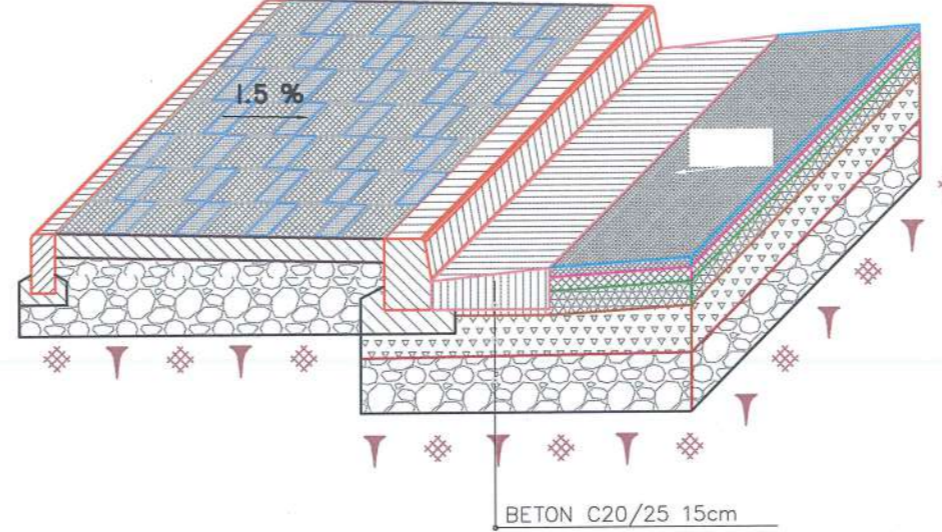

PLAN PLANIMETRIA

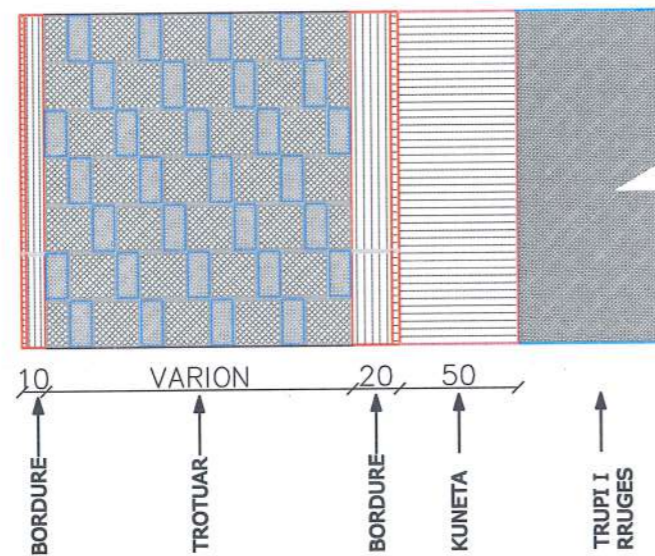

BORDURA

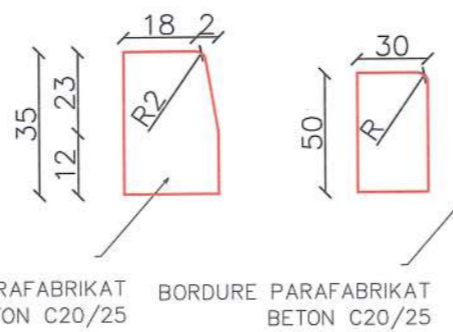

BORDURE PARAFABRIKAT BETON C20/25

KUNETA

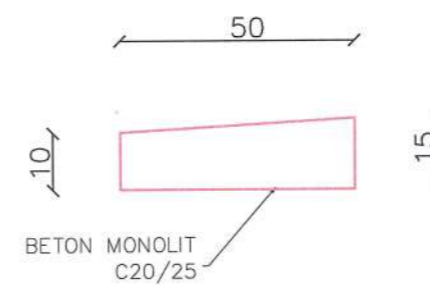

PLAKAT

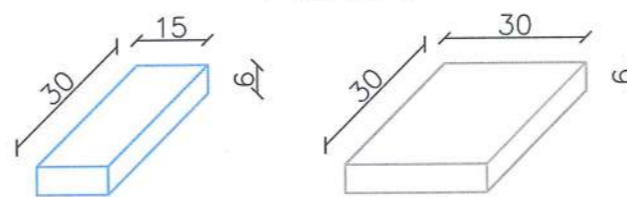

Bordure e larte 1m C20/25



Bordure e larte 0.5m C20/25

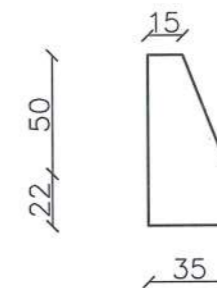

Porositesi  
**BASHKIA DIBER**

Objekti: Sistemim asfaltim i rruges se lagjes Llixha, Bashkia Diber

Emertimi:  
**DETAJE TROTUARI**

**PROJEKT - ZBATIMI**

GRUPI PROJEKTUES  
Ing. Hidro. Mark PEMAJ  
Ing. Top. Bilbil NURÇE

Periudha:  
**QESHOR 2022**



Firma:  
Firma:  
Shkalla: 1:30  
Fleta: Nr. 1

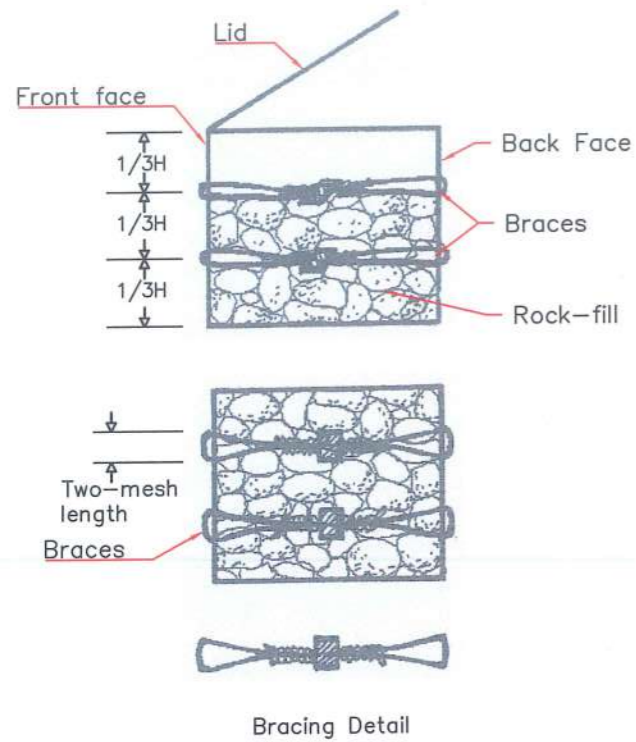

Gabion filling and bracing placement

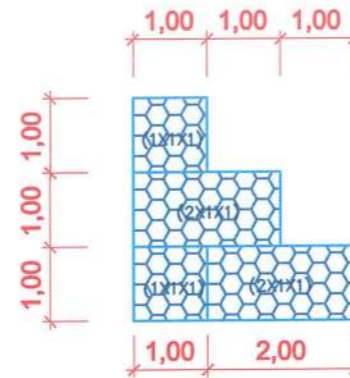
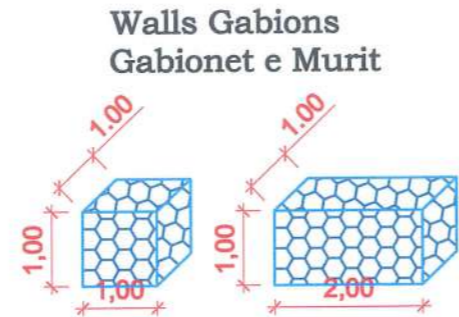

Mattress Gabions At Base of Wall  
Gabionet e Qilimit Ne Bazen e Murit

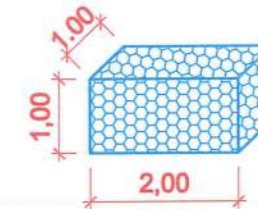

Mattress Gabions Above the Wall  
Gabionet e Qilimit mbi Mur

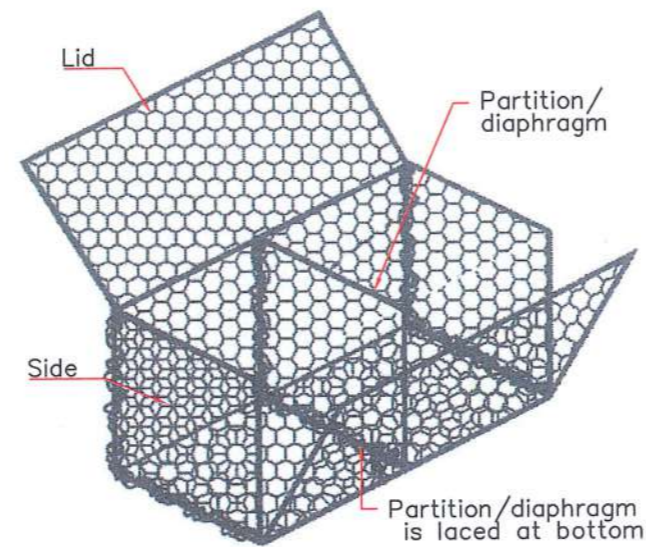
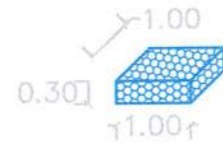

Link Gabion components

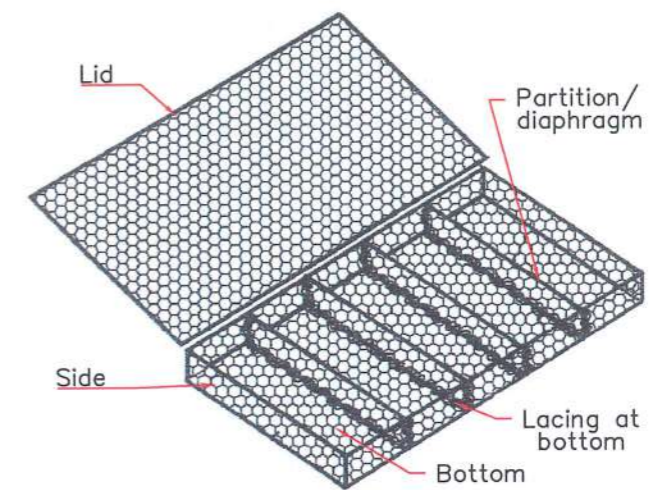

Link Mattress components



Porositesi  
BASHKIA DIBER

Objekti: Sistemim asfaltim i rruges se lagjes Llixha, Bashkia Diber

Emertimi:

DETAJE GABIONI

PROJEKT - ZBATIMI

GRUPI  
PROJEKTES

Ing.Hidro. Mark PEMAJ  
Ing.Top. Bilbil NURÇE

Firma:  
Firma:

Periudha:  
QESHOR 2022

Shkalla: 1:30  
Fleta: Nr. 1



MURI PRITES H=1.5  
SIP.=1.57m<sup>2</sup>

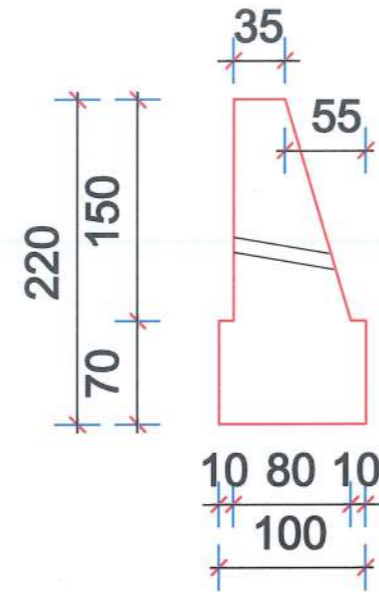

MURI PRITES H=1.0  
SIP.=0.85m<sup>2</sup>

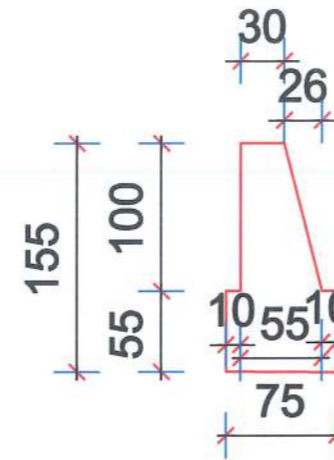

KANALI I BETONIT  
SIP.=0.21m<sup>2</sup>

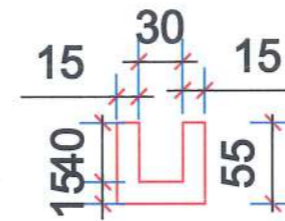

**2D** PROJEKTIM  
DESIGN  
SUPERVISION  
KOLAUDIM  
Adresa: Rruga "Bardhyl", Njesia Bashkiake nr. 8, TIRANE



Porositesi  
BASHKIA DIBER

Objekti: Sistemim asfaltim i rruges se  
lagjes LLixha, Bashkia Diber

Emertimi:

DETAJE

PROJEKT - ZBATIMI

GRUPI  
PROJEKTUES

Ing.Hidro. Mark PEMAJ

Ing.Top. Bilbil NURÇE

Periudha:

QESHOR 2022

Firma:

Firma:

Shkalla: 1:50

Fleta: Nr. 1



# SHENJAT PARANDALUESE

Trekendeshi: e kuqe reflektive

Sfondi: e kuqe reflektive

Simboli: zeze

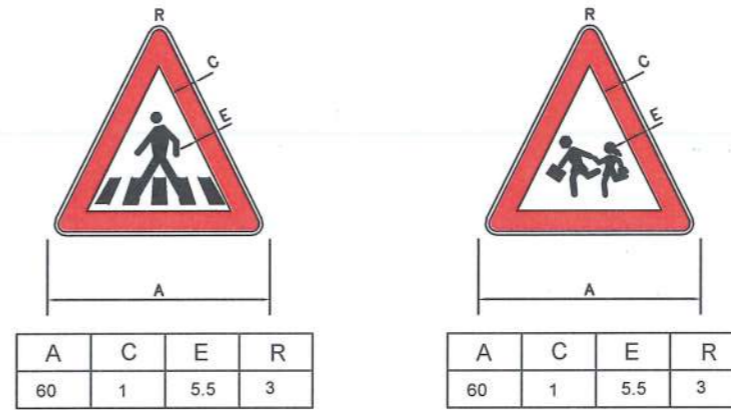
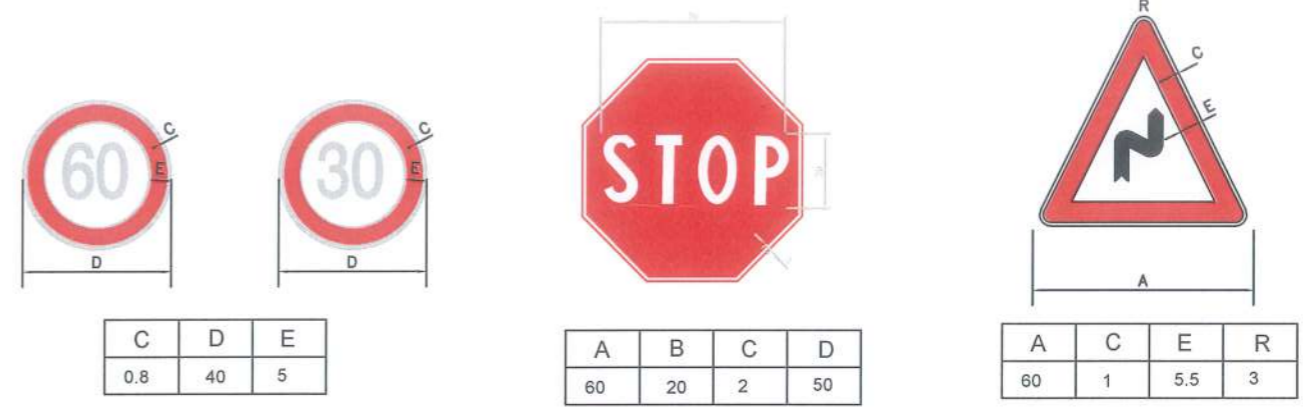
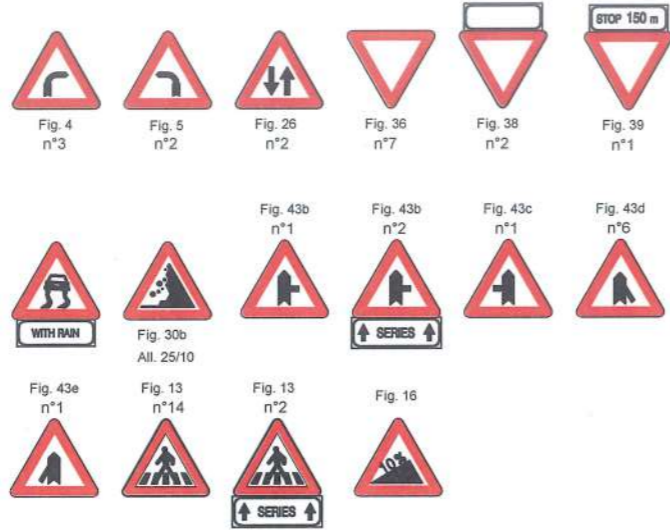

# TABELAT INFORMUESE

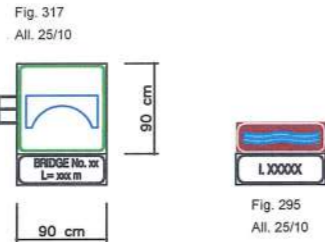

Limit shpejtesie

Rrethi: e kuqe reflektive

Simboli: e zeze reflektive

Ndalim parakalimi

Cepi & sfondi: e bardhe reflektive

Rrethi: e kuqe reflektive

Simboli: e zeze dhe kuqe reflektive

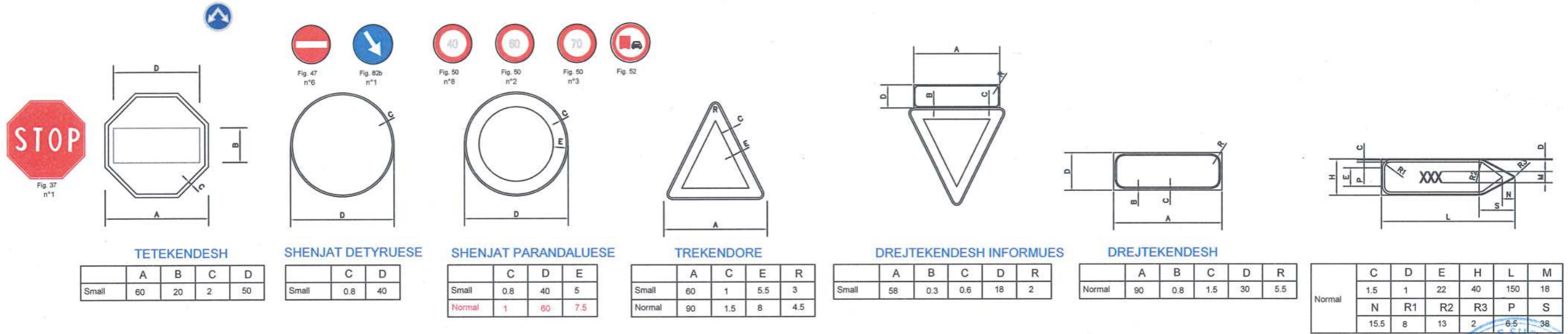

**2D** PROJEKTIM DESIGN SUPERVISION KOLAUDIM

Adresa: Rruga "Bardhyf", Njesia Bashkiake nr. 8, TIRANE

Porositesi  
**BASHKIA DIBËR**

Objekti: Sistemim asfaltim i rruges se lagjes L Lixha, Bashkia Diber

Emertimi:  
**DETAJET E SINJASTIKES**

**PROJEKT ZBATIMI**

GRUPI PROJEKTES

Ing. Hidro. Mark PEMAJ  
Ing. Top. Bilbil NURÇE

PERIUDHA:  
**QESHOR 2022**

Firma: [Stamp]  
Firma: [Stamp]

Shkalla: 1:50  
Fleta: Nr. 1

## VIJEZIMI I RRUGEVE

### VIJEZIMI NE KUFIJETE E RRUGES Tipi A "vazhduar"

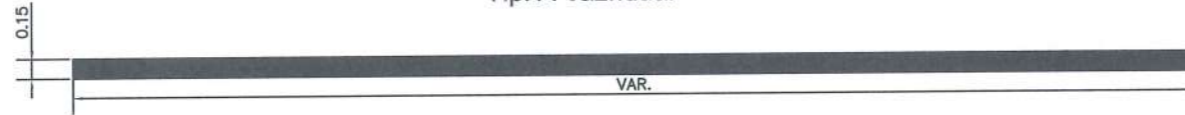

Linjë paralajmëruese tek nyjet, kthesat dhe pikat e tjera të rrezikshme

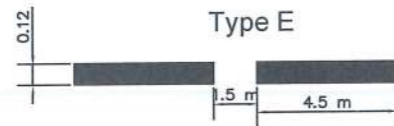

Vijëzimi tek cepi i karrexhatës, tek nyjet ose vendndodhjet anësore.

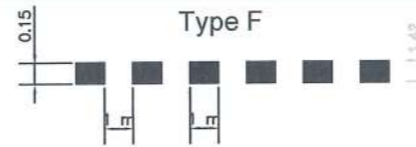

Vijëzimi i aksit qëndror ose vijëzimi i korsisë për shpejtësi <math>< 50 \text{ km/h}</math>

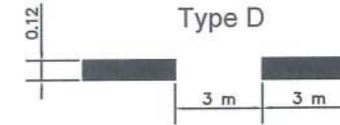

Udhëzuesi për automjetet që duhet të kalojnë nëpër një nyje.  
Zakonisht përdoret tek nyjet komplekse.

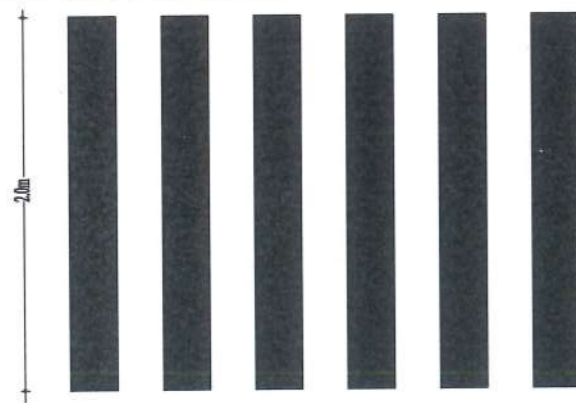
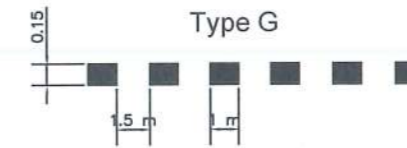

### VIJEZIMI NE AKS TE RRUGES Tipi A "vazhduar"

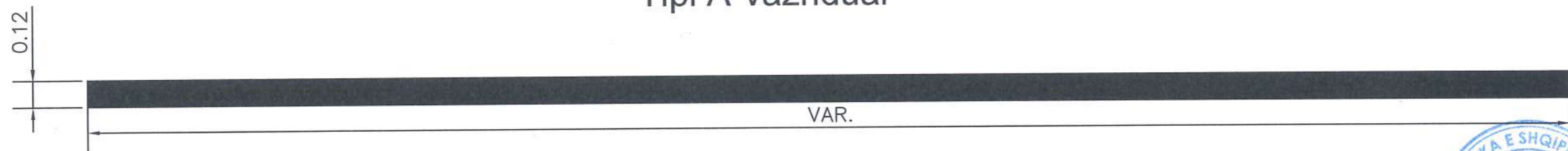

**2D** PROJEKTIM  
DESIGN  
SUPERVISION  
KOLAUDIM  
Adresa: Rruga "Bardhyf", Njesia Bashklike rr. B.TIRANE

Porositesi  
**BASHKIA DIBËR**

**Objekti:** Sistemim asfaltim i rruges se lagjes Llixha, Bashkia Diber

Emertimi:  
**DETAJET E SINJASTIKES**

**PROJEKT ZBATIMI**

GRUPI PROJEKTUES	Ing.Hidro. Mark PEMAJ	Firma:
	Ing.Top. Bilbil NURÇE	Firma:
Periudha: <b>QESHOR 2022</b>	Shkalla:	1:50
	Fleta:	Nr. 2



VENDOSJA E TABELAVE

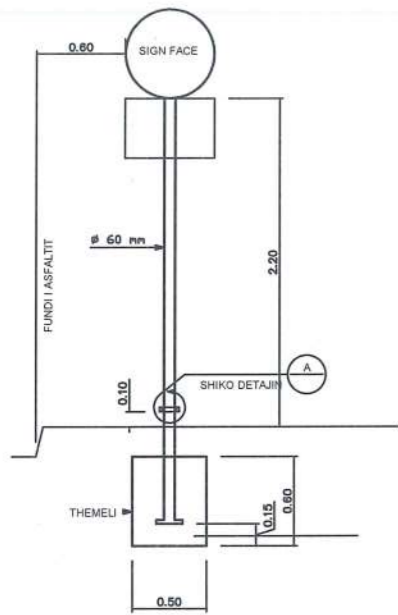

VENDOSJA E NJE TABELE

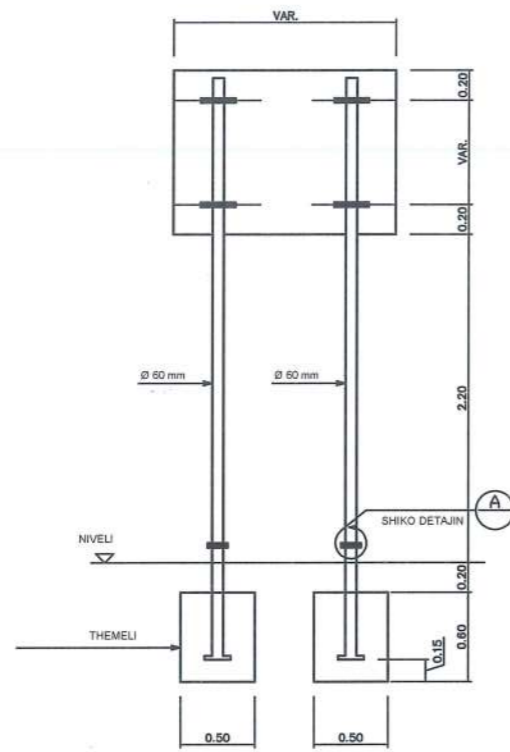

VENDOSJA E E DY TABELAVE

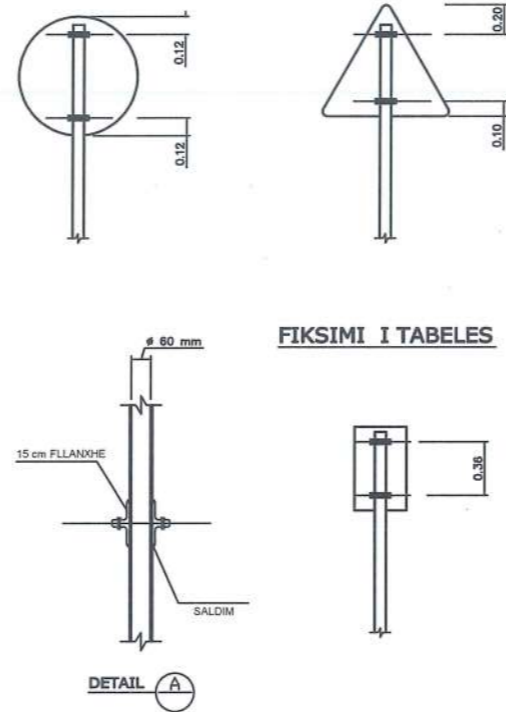

FIKSIMI I TABELES

INDIKATORI I CEPIT TE RRUGES

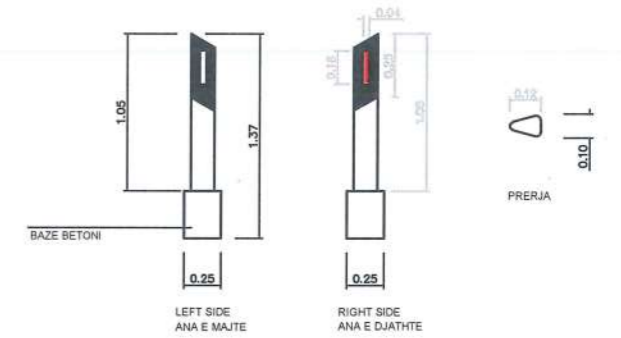

LEFT SIDE ANA E MAJTE  
RIGHT SIDE ANA E DJATHTE

SHENIM: INDIKATORET E FUNDIT TE RRUGES VENDOSEN NE NJE DISTANCE PREJ 50 m.  
NE RAST SE VENDOSEN NE GUARDRAIL TE RRUGES ATO FIKSOHEN NE FADEN E TYRE.



FIKSUES NE CEPAT E MUREVE TE BETONIT

	<p>Porositesi <b>BASHKIA DIBËR</b></p>	<p>Emertimi: <b>DETAJET E SINJASTIKES</b></p>	<p>GRUPI PROJEKTUES</p> <p>Ing.Hidro. Mark PEMAJ Firma: </p> <p>Ing.Top. Bilbil NURÇE Firma: </p>
	<p><b>Objekti:</b> Sistemim asfaltim i rruges se lagjes LLixha, Bashkia Diber</p>	<p><b>PROJEKT ZBATIMI</b></p>	
		<p>Shkalla: 1:50</p>	
		<p>Fleta: Nr. 3</p>	

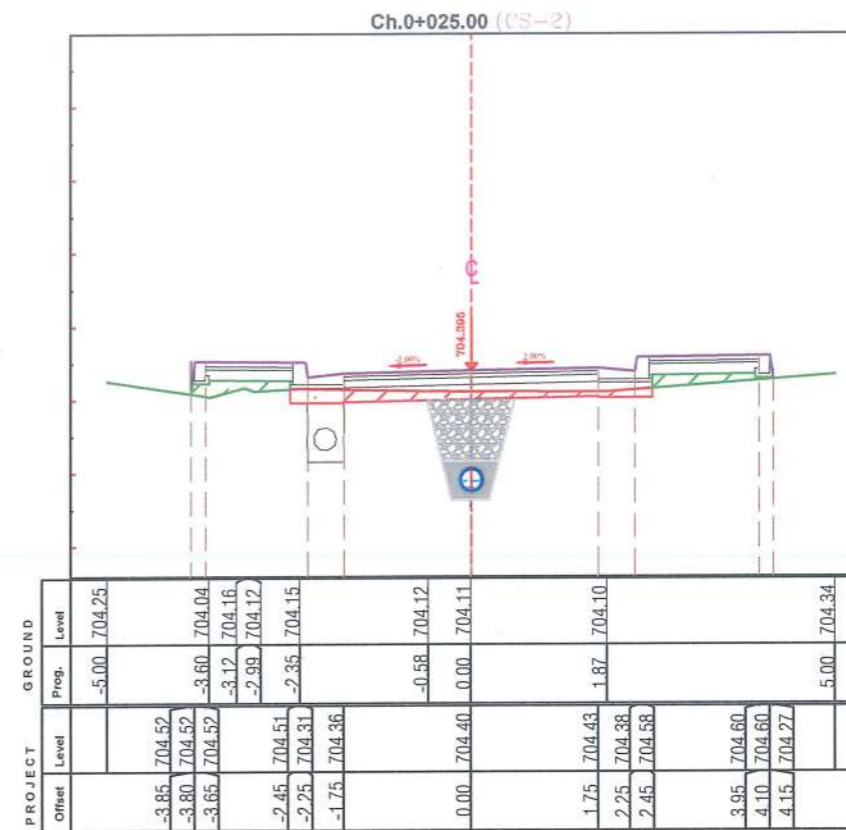
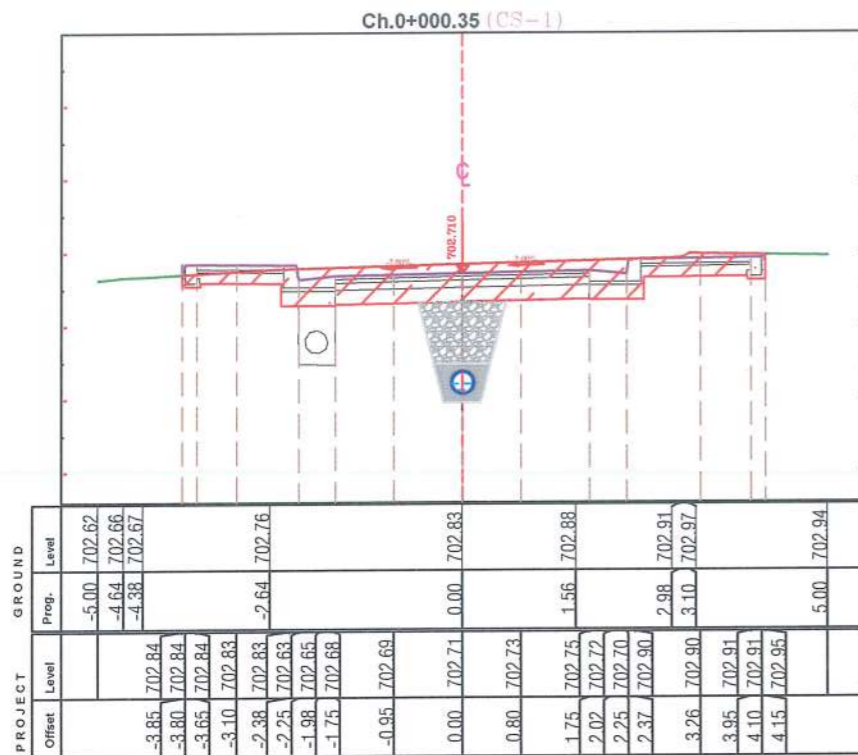

**2D** PROJEKTIM  
DESIGN  
SUPERVISION  
KOLAUDIM  
Adresa: Rruga "Barshyl", Njesia Bashkiake nr. 8, TIRANE

Porositesi  
**BASHKIA DIBER**

Objekti: Sistemim asfaltim i rruges se  
lagjes Llixha, Bashkia Diber

Emertimi:

PRERJET TERTHORE

PROJEKT ZBATIMI

GRUPI  
PROJEKTUES  
Ing. Hidro. Mark PEMAJ  
Ing. Top. Bilbil NURÇE

Firma:  
Firma:

Periudha:  
QESHOR 2022

Shkalla: 1:100

Fleta: Nr. 1









Ch.0+125.00 (CS-6)

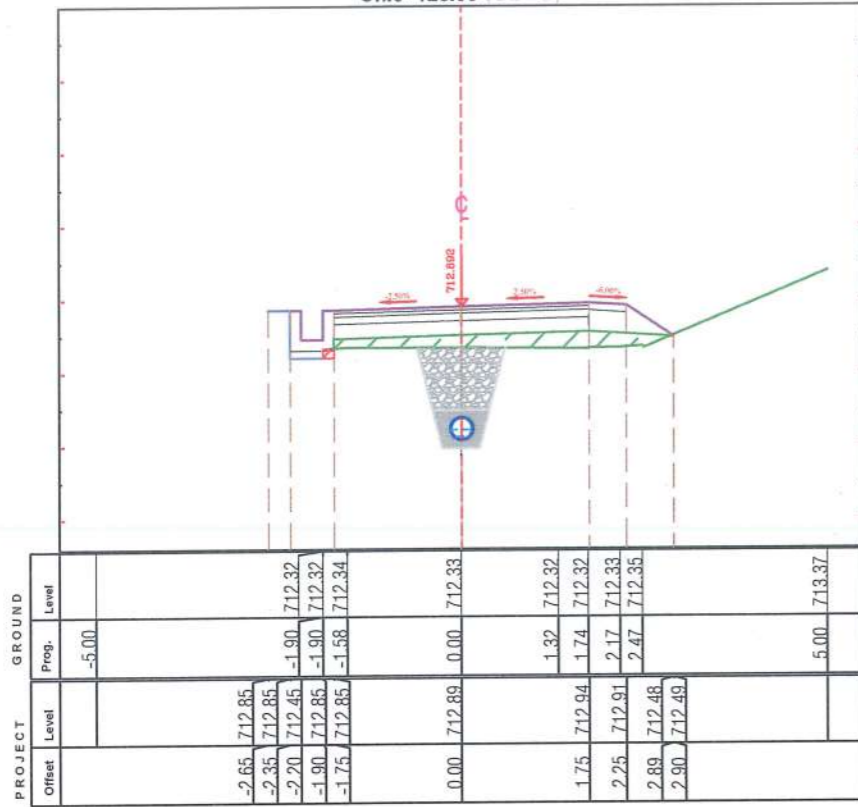

Ch.0+150.00 (CS-7)

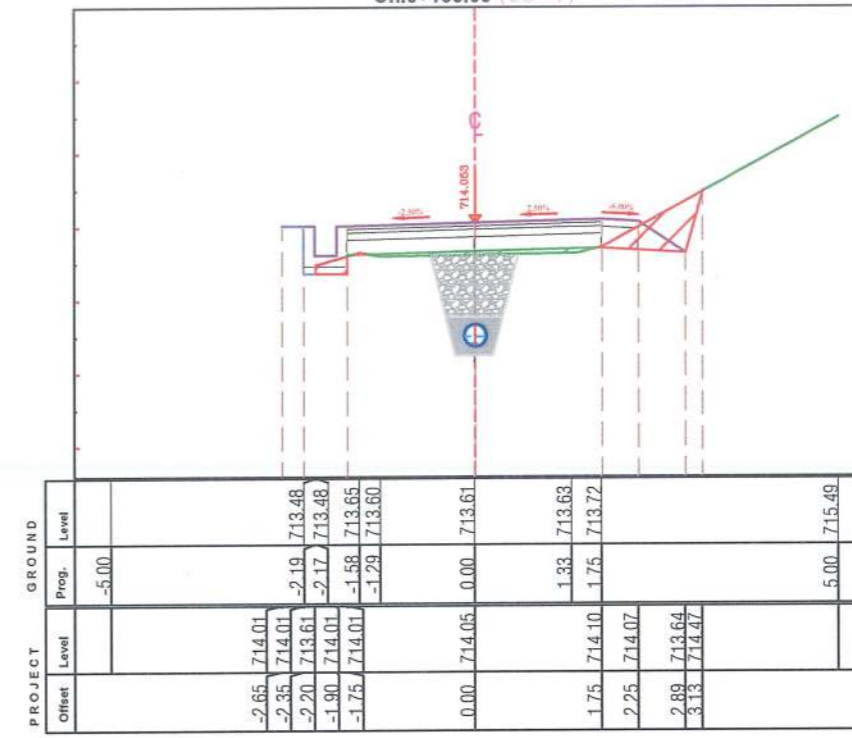

**Objekti:** Sistemim asfaltim i rruges se lagjes LLixha, Bashkia Diber

**Emertimi:**  
PRERJET TERTHORE

**PROJEKT ZBATIMI**

GRUPI PROJEKTUES	Ing.Hidro. Mark PEMAJ	Firma:	
	Ing.Top. Bilbil NURÇE *	Firma:	
<b>Periudha:</b>	<b>QESHOR 2022</b>		Shkalla: 1:100
	Fleta:	Nr. 4	



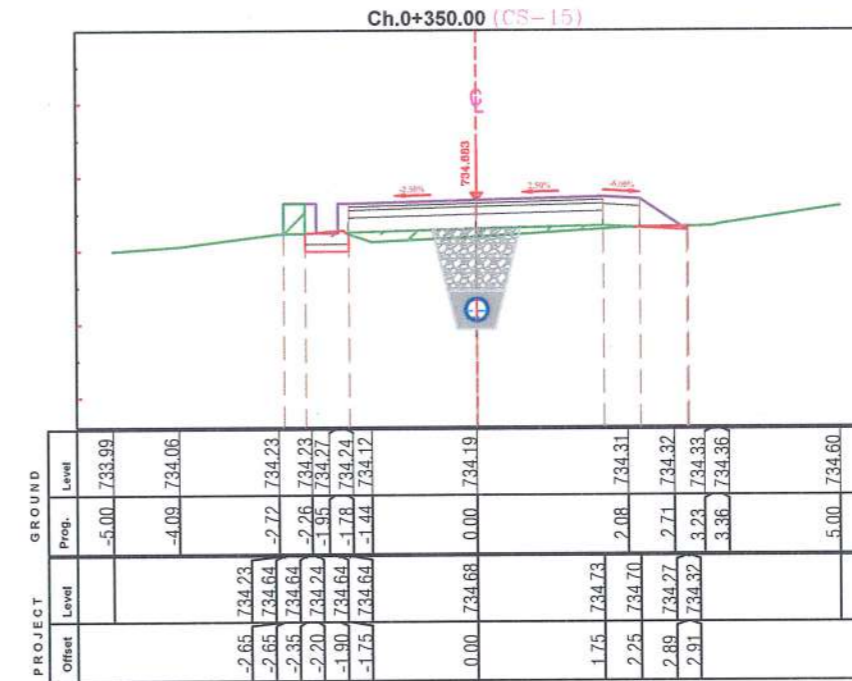
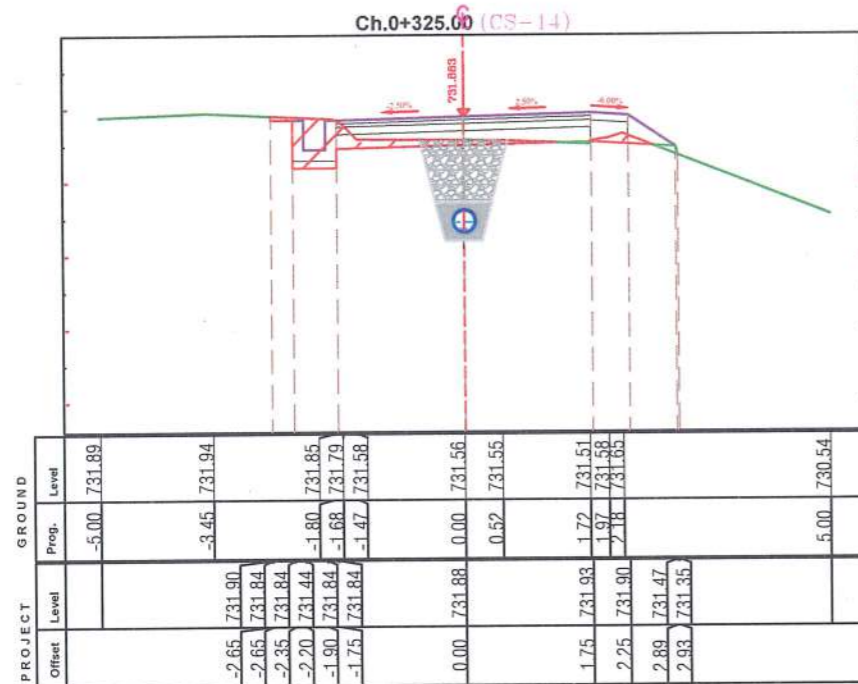
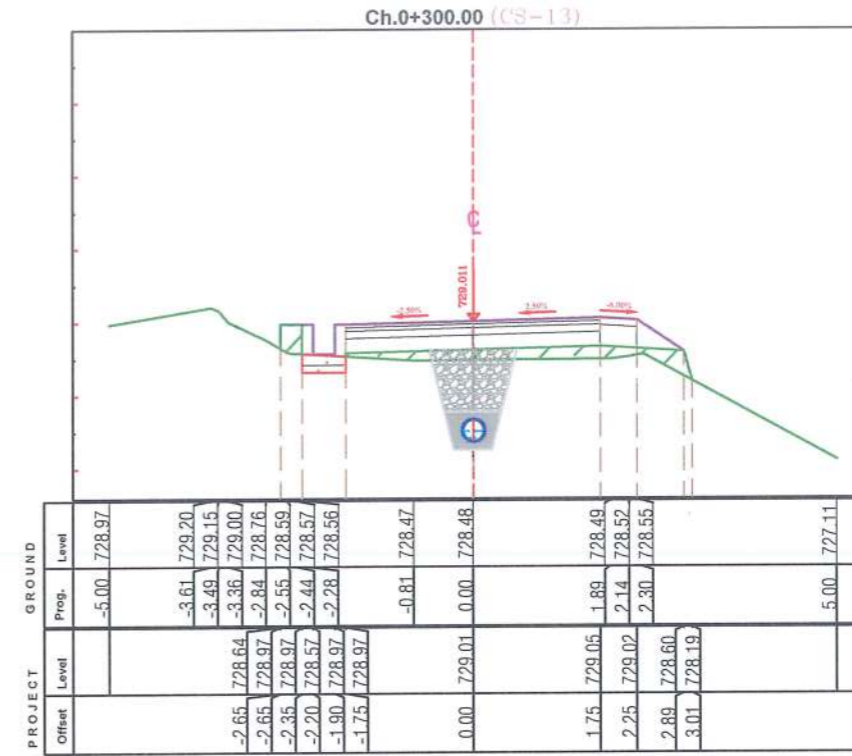
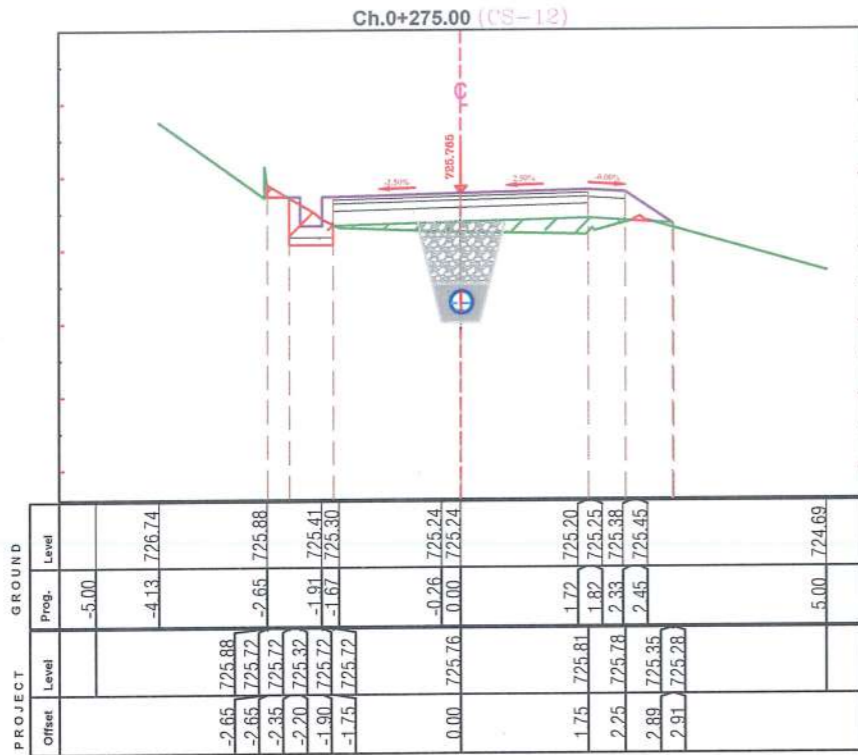

**2D** PROJEKTIM  
DESIGN  
SUPERVISION  
KOLAUDIM  
Adresa: Rruga "Bardhyl", Njesia Bashkiake nr. 8, TIRANE

Porositesi  
**BASHKIA DIBER**

Objekti: Sistemim asfaltim i rruges se  
lagjes LLixha, Bashkia Diber

Emertimi:

PRERJET TERTHORE

PROJEKT ZBATIMI

GRUPI  
PROJEKTUES

Ing. Hidro. Mark PEMAJ

Ing. Top. Bilbil NURÇE

Periudha:

QESHOR 2022

Firma:

Firma:

Shkalla: 1:100

Fleta: Nr. 6



Ch.0+375.00 (CS-16)

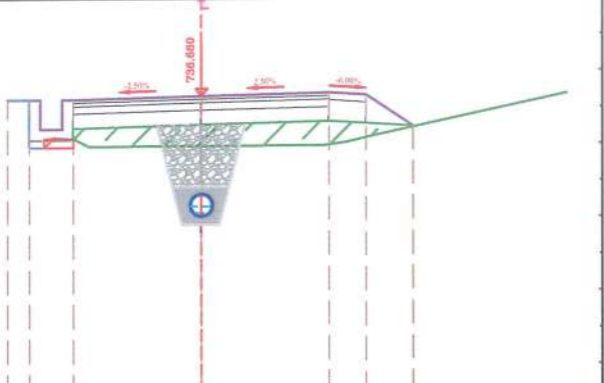

PROJECT		GROUND	
Offset	Level	Prog.	Level
		-5.00	
-2.65	736.62	-2.15	736.08
-2.35	736.62	-2.11	736.09
-2.20	736.22	-2.01	736.10
-1.90	736.62	-1.73	736.08
-1.75	736.62	-1.53	735.97
0.00	736.66	-0.32	735.98
		0.00	735.98
1.75	736.70	1.67	735.99
2.25	736.67	1.98	736.03
2.89	736.24	2.39	736.12
2.90	736.23		
		5.00	736.68

Ch.0+400.00 (CS-17)

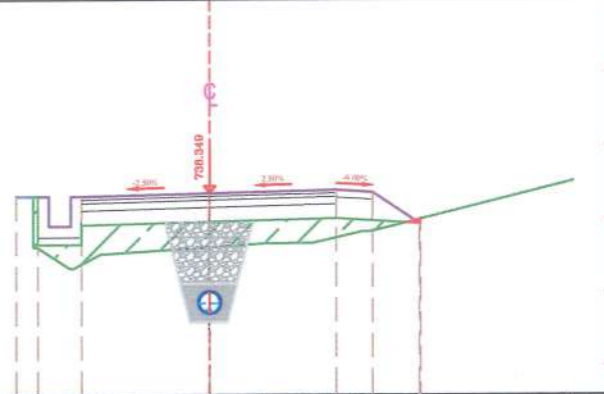

PROJECT		GROUND	
Offset	Level	Prog.	Level
		-5.00	
-2.65	738.31	-2.42	737.62
-2.35	738.31	-2.35	737.61
-2.20	737.91	-1.87	737.32
-1.90	738.31	-1.41	737.52
-1.75	738.31		
0.00	738.35	0.00	737.61
		0.78	737.66
1.75	738.38	1.42	737.67
2.25	738.36	1.57	737.70
2.89	737.93	2.11	737.82
2.91	737.99	2.23	737.82
		5.00	738.51

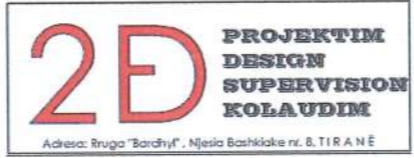

Porositesi  
**BASHKIA DIBER**

**Objekti:** Sistemim asfaltim i rruges se lagjes LLixha, Bashkia Diber

Emertimi:  
**PRERJET TERTHORE**

**PROJEKT ZBATIMI**

GRUPI PROJEKTUES	Ing. Hidro. Mark PEMAJ	Firma:
	Ing. Top. Bilbil NURÇE	Firma:
Periudha:	Shkalla:	1:100
<b>QESHOR 2022</b>	Fleta:	Nr. 7



Ch.0+425.00 (CS-18)

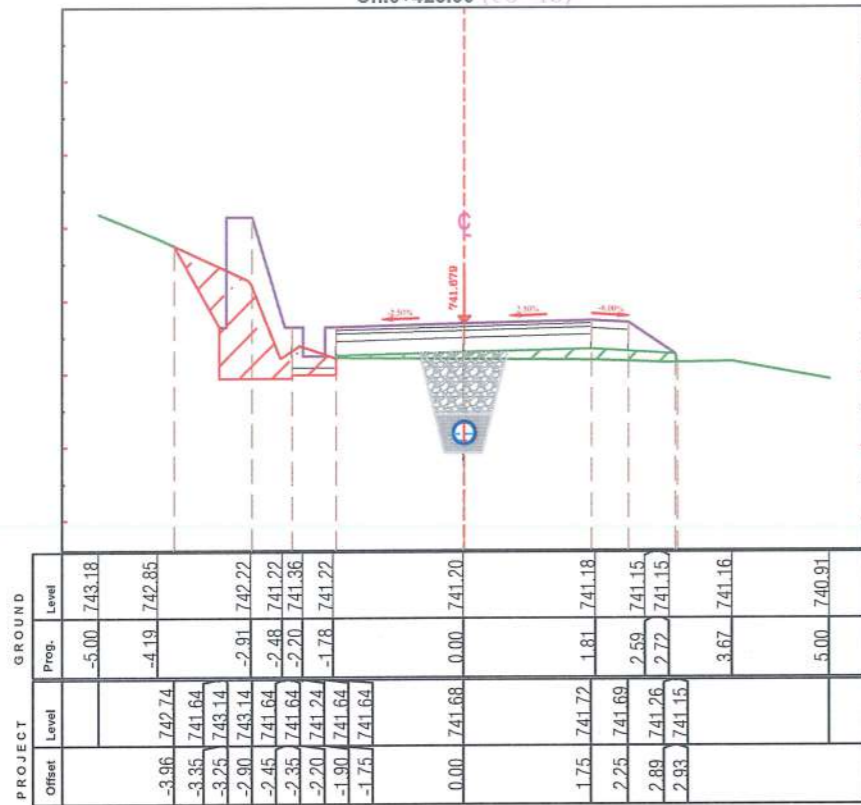

Ch.0+450.00 (CS-19)

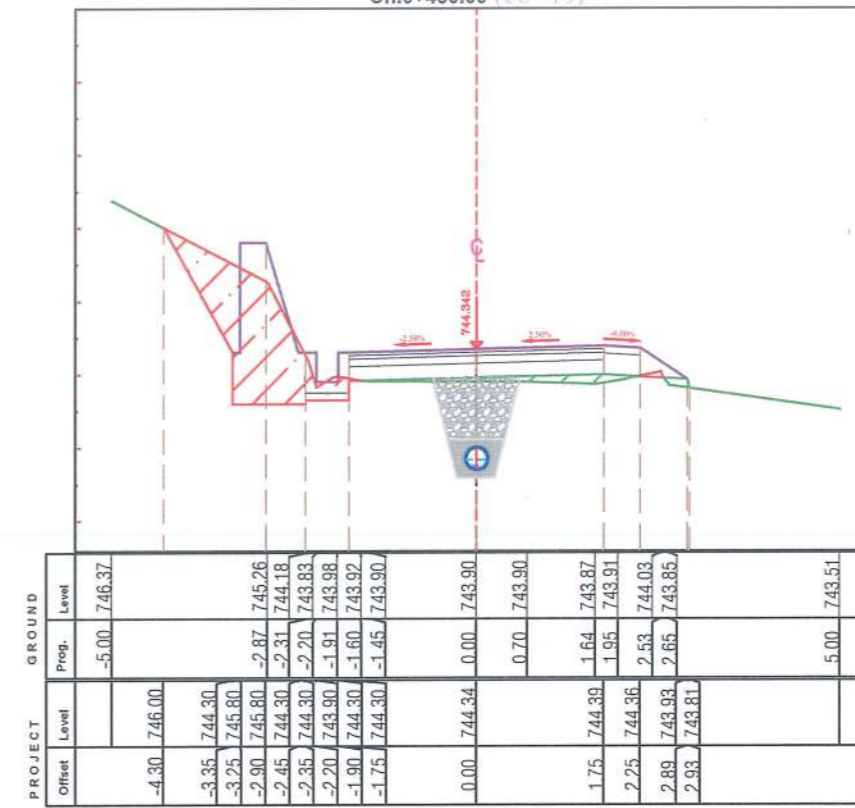

Porositesi  
**BASHKIA DIBER**

**Objekti:** Sistemim asfaltim i rruges se lagjes L.Lixha, Bashkia Diber

Emertimi:

PRERJET TERTHORE

PROJEKT ZBATIMI

GRUPI  
PROJEKTUES

Ing. Hidro. Mark PEMAJ

Ing. Top. Bilbil NURÇE

\* Firma: [Stamp]

\* Firma: [Stamp]

Periudha:

QESHOR 2022

Shkalla: 1:100

Fleta: Nr. 8









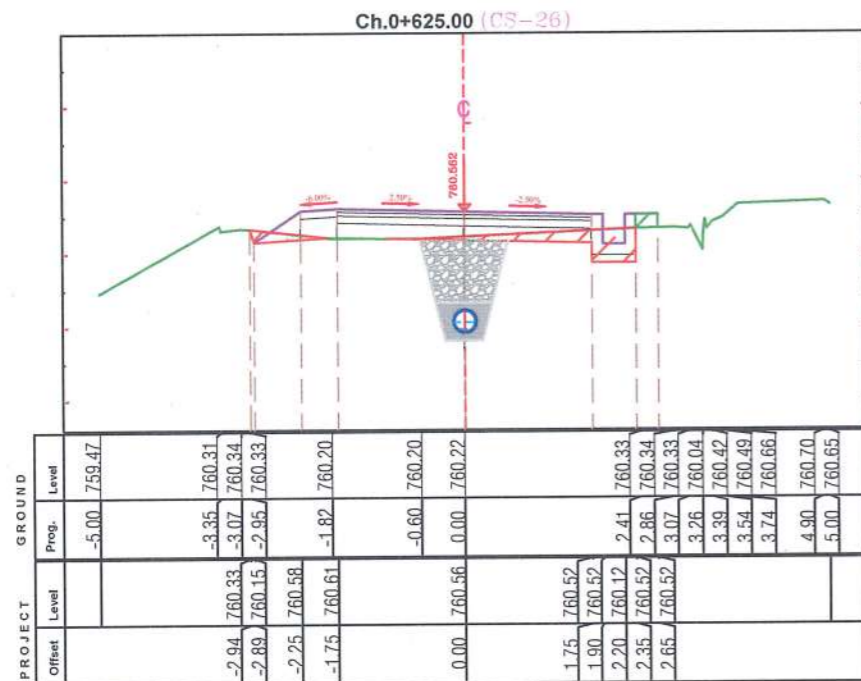
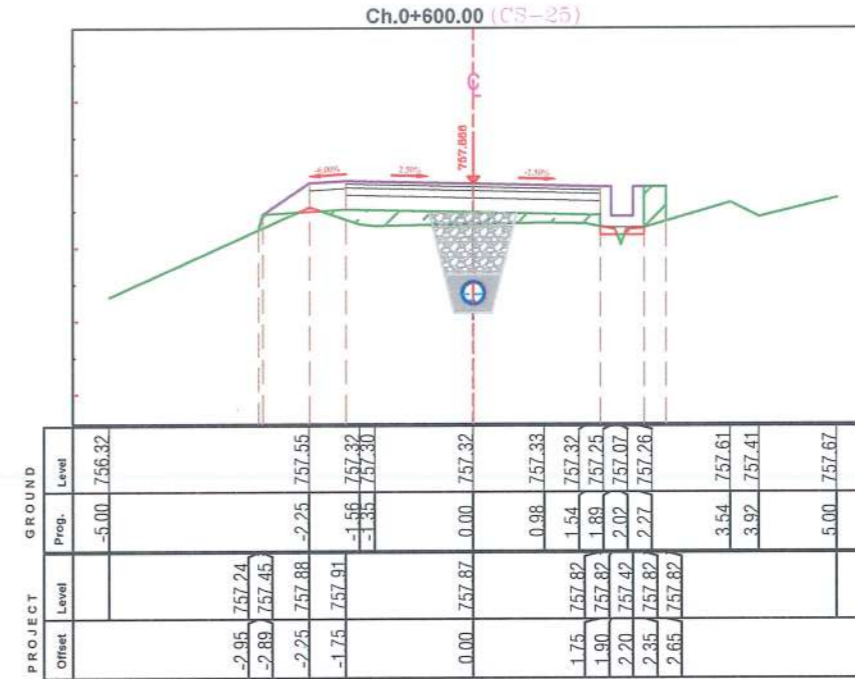
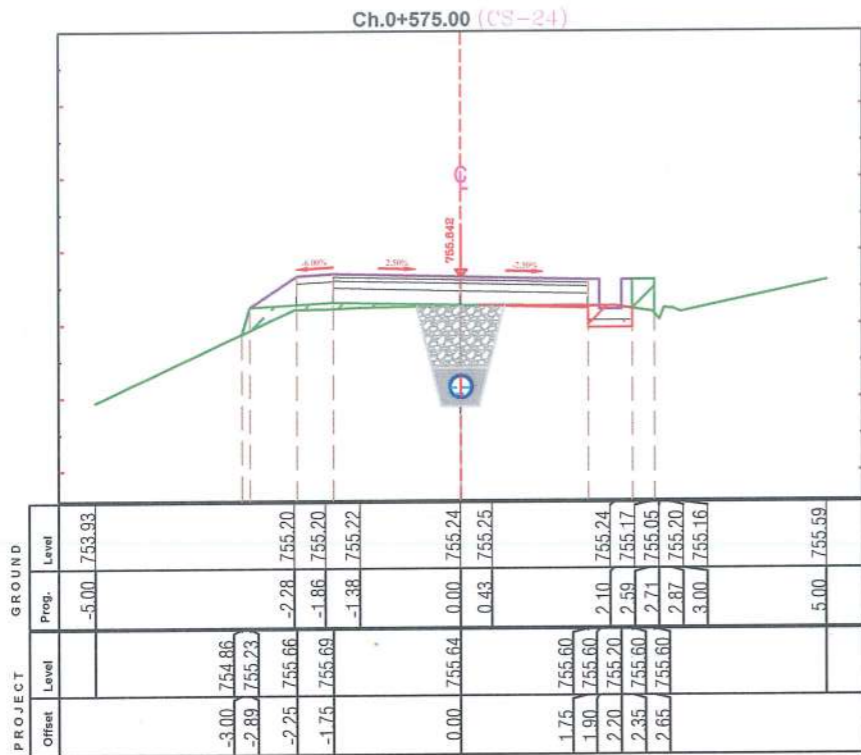

**2D** PROJEKTIM  
DESIGN  
SUPERVISION  
KOLAUDIM  
Adresa: Rruga "Bardhyl", Njesia Bashkiake nr. 8, TIRANE



Porositesi  
**BASHKIA DIBER**

**Objekti:** Sistemim asfaltim i rruges se lagjes Llixha, Bashkia Diber

Emertimi:

PRERJET TERTHORE

PROJEKT ZBATIMI

GRUPI  
PROJEKTUES

Ing.Hidro. Mark PEMAJ

Firma:

Ing.Top. Bilbil NURÇE

Firma:

Periudha:

QESHOR 2022

Shkalla: 1:100

Fleta: Nr. 11





Ch.0+040.00 (CS-3)

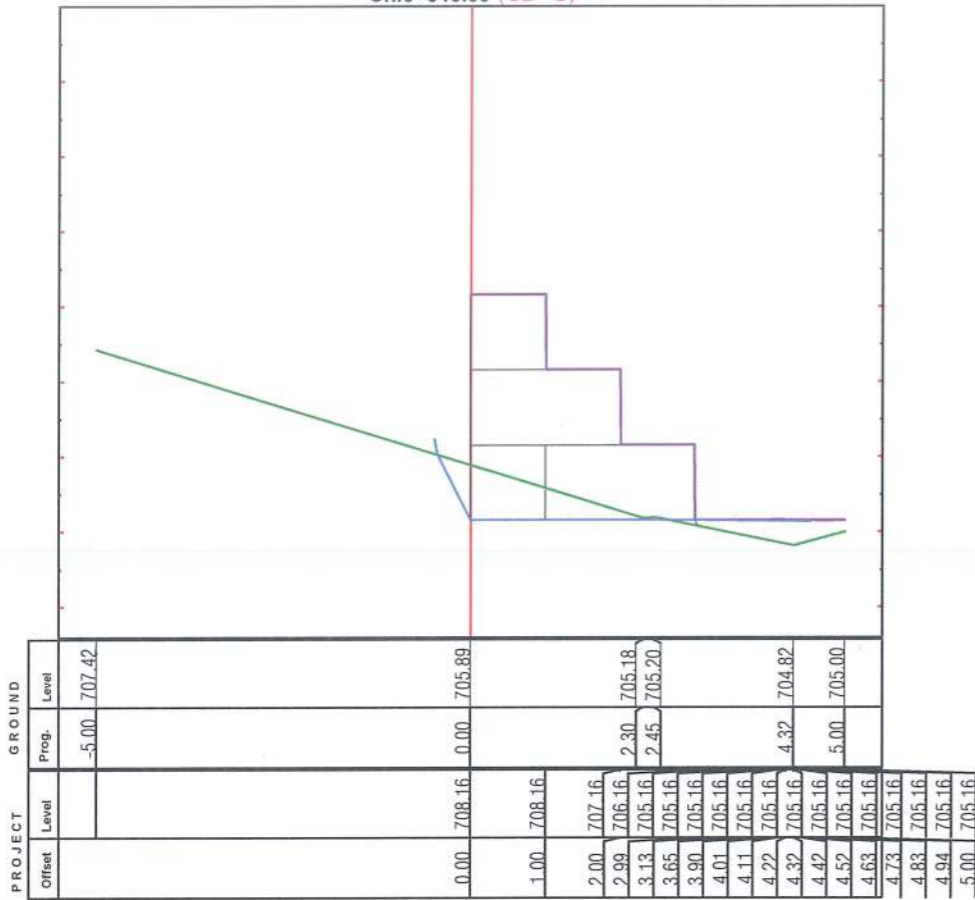

Ch.0+048.28 (CS-4)

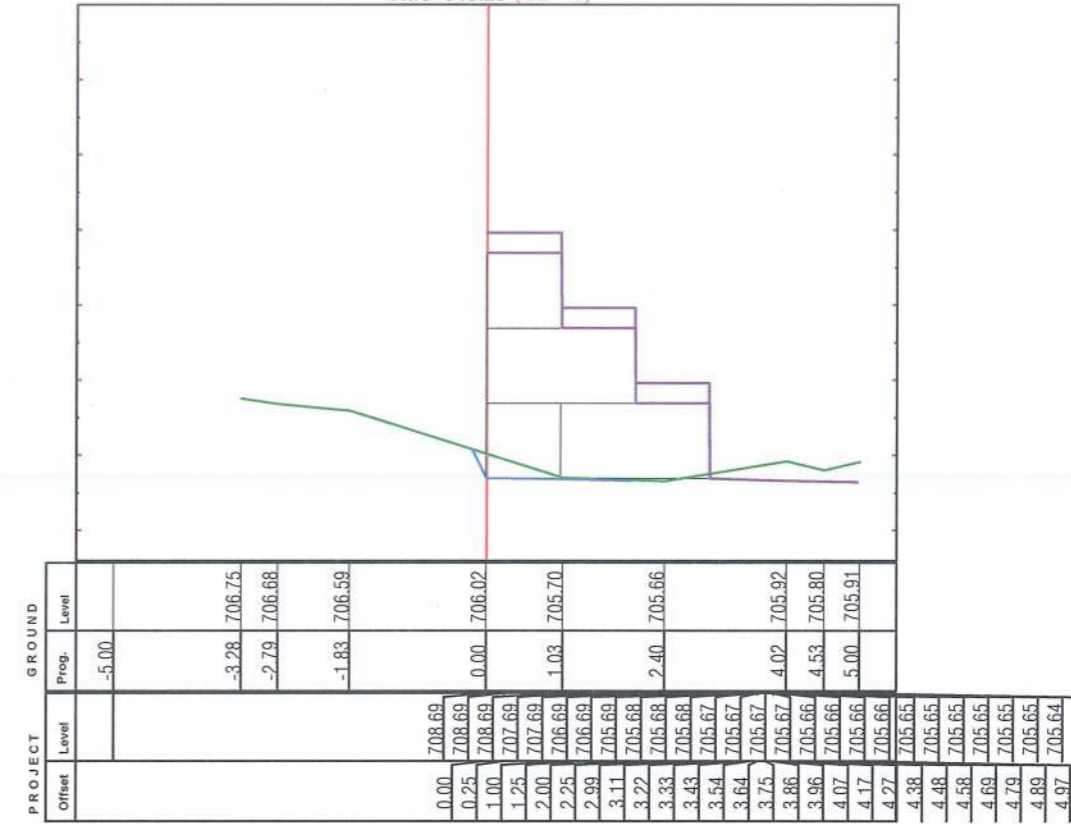

Porositesi  
BASHKIA DIBER

Objekti: Sistemim asfaltim i rruges se lagjes Llixha, Bashkia Diber

Emertimi:

PRERJET TERTHORE

PROJEKT ZBATIMI

GRUPI  
PROJEKTUES

Ing.Hidro. Mark PEMAJ

Firma:

Ing.Top. Bilbil NURÇE

Firma:

Periudha:

QESHOR 2022

Shkalla: 1:100

Fleta: Nr. 2

