



Grupi projektues

Fila Nr.:

D 0

Profili terthor progresiv

Emertimi Rruges:

EVER MEMBER DATA FROM

Vanqish Mbroce

Anduen Mbroce

SHKALLA: A3 1:200

DISTANCA PËSORE PROJEKTI

KUOTE PROJEKTI

PROGRESIVI I PROJEKTI

DISTANCA PËSORE E TERRENT

KUOTE TERRENT

TERRENTI PROGRESIV

Kuota Ref.: 330.00

Shkalla: 1:200

Progresivi: 1+880.00

SEKSIONI 95

AKSI

1.04	341.71	-3.54	11.67	345.15	-15.00
0.75	340.67	-2.50		341.65	-3.33
1.75	340.64	-1.75	3.33		
	340.57	0.00		340.84	0.00
1.75	340.50	1.75	0.91	340.61	0.91
0.75	340.47	2.50	0.95	340.59	1.87
	340.52	2.55	1.81	340.40	3.68
			1.36	340.60	5.05
			4.42		
			4.66	340.36	9.47
			0.87	340.14	14.13
				340.00	15.00

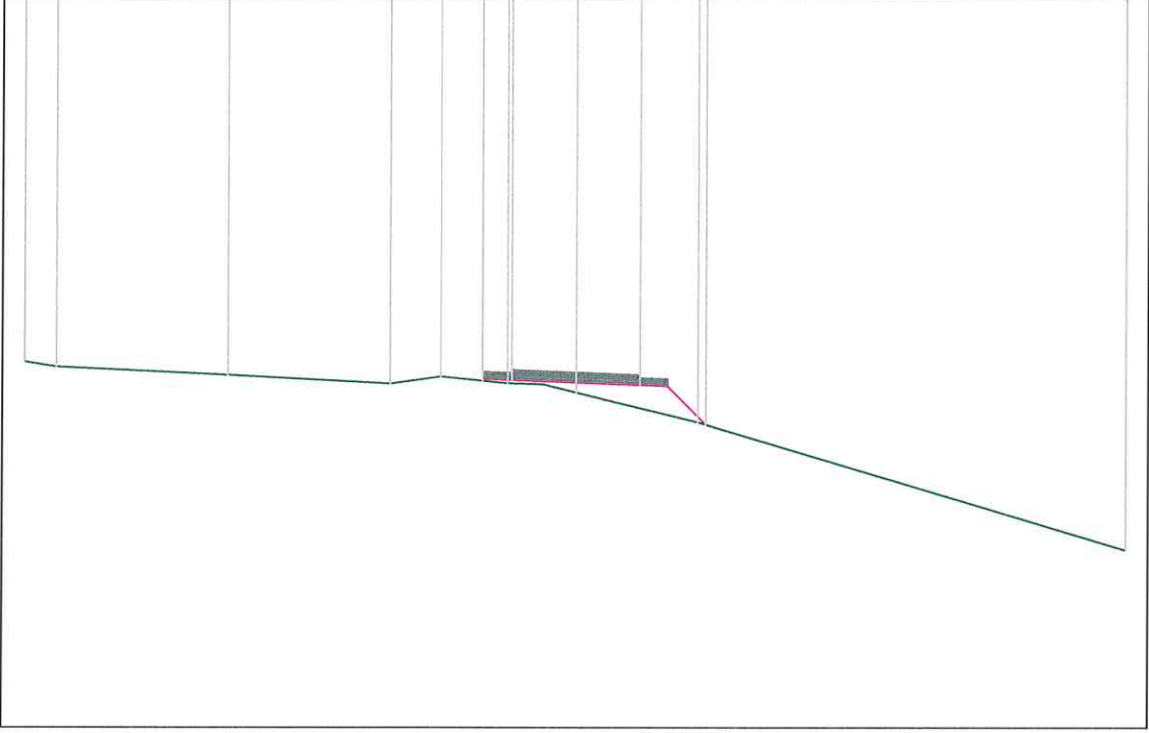



PROJEKTI: "ASFALTIM RRUGE TE BRENDSHIME KOCUL"  
Faza e projekt: Projekt Zbatimi



Grupi projektues: C.E.C

Field No.:	0
SHKALLA:	A3 1:200
Emertimi i objektit:	Profilat terthor progresiv
MEMBER	DATA
MEMBER	DATA
MEMBER	DATA
MEMBER	DATA

DISTANCA PËSORE PROJEKTI	12.92
KUOTE PROJEKTI	342.85
PROGRESIVI I PROJEKTI	-2.51
DISTANCA PËSORE E TERRENT	12.36
KUOTE TERRENT	342.76
TERRENTI PROGRESIV	-15.00

0.75	342.85	-2.51	0.59	342.76	-2.08
1.75	342.84	-1.75	1.49	342.97	-1.49
1.75	342.80		1.07	342.85	0.00
0.75	342.77	1.75	1.52	342.76	1.07
0.81	342.76	2.50		342.36	2.64
	342.22	3.31			
				339.84	15.00

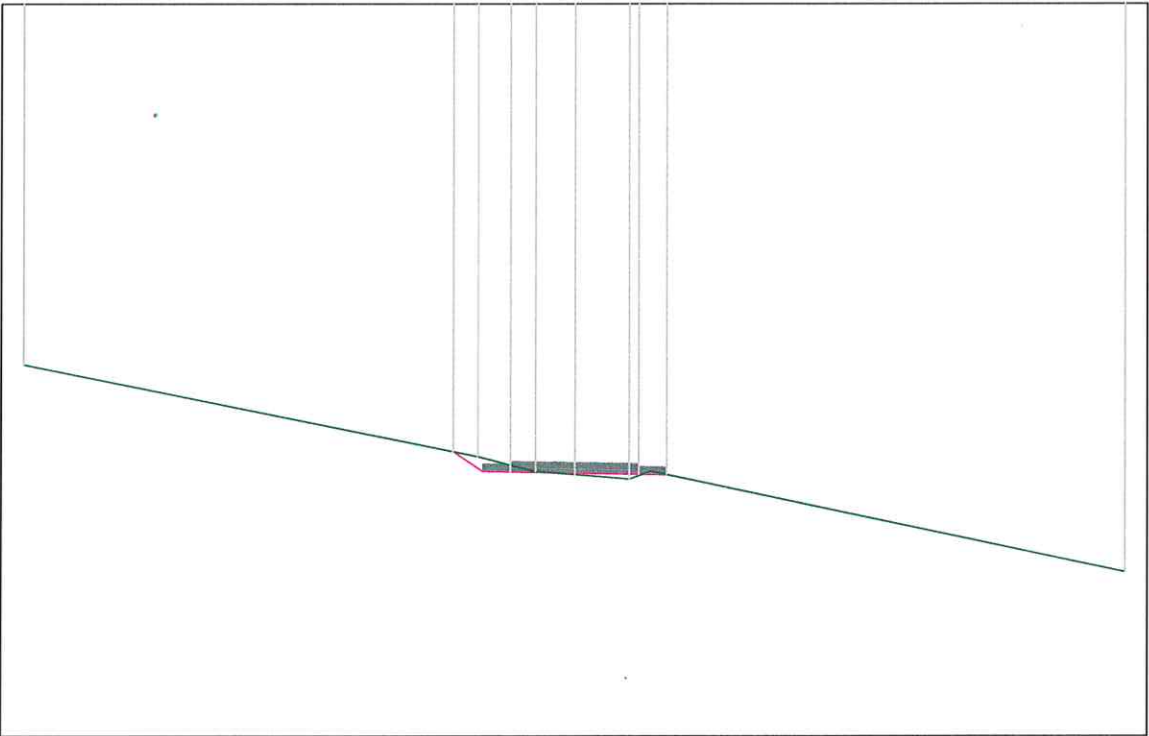

AKSI  
SEKSIONI 96  
Progresivi: 1+900.00  
Shkalla: 1:200  
Kuota Ref.: 330.00



PROJEKTI: "ASFALTIM RRUGE TE BRENDSHME KOCUL"  
Faza e projektit: Projekt Zbatimi



Grupi projektues

EMER MEMBER

DATA

FORMA

Emertimi i objektit:

Profiliat terthor progresiv

Fila Nr.:

D 0

Numri i shtetit

SHKALLA: A3 1:200

DISTANCA PËSORE PROJEKTI

KUOTE PROJEKTI

PROGRESIVI I PROJEKTI

DISTANCA PËSORE E TERRENT

KUOTE TERRENT

TERRENTI PROGRESIV

1327	-2.80	344.83	1327	-15.00
0.38	-2.50	345.02		
0.75	-1.75	345.03		
1.75		345.04	1.38	-1.41
1.75	1.75	345.05	1.29	0.00
0.75	2.50	345.06		1.29
1.94	4.44	343.76		
			1371	
			340.95	15.00

AKSI  
SEKSIONI 97  
Progresivi: 1+920.00  
Shkalla: 1:200  
Kuota Ref.: 340.00

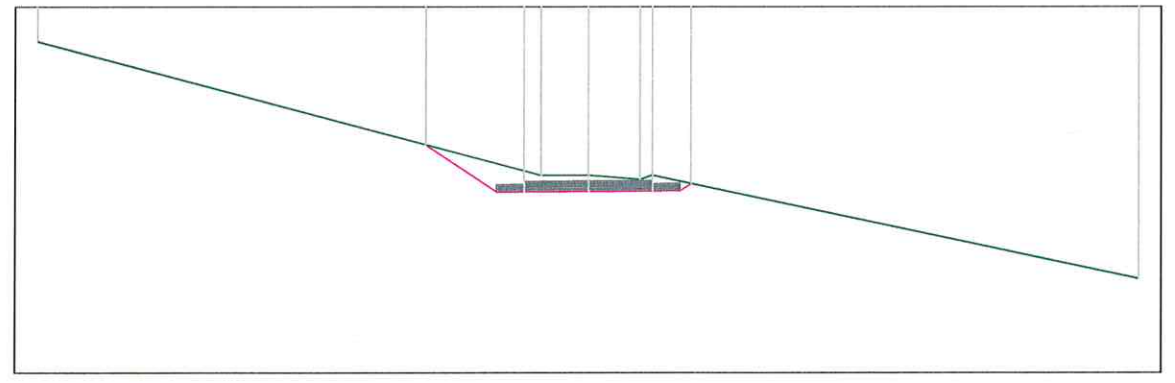



Grupi projektues

EMER MEXHERR	DATA	FORMA
Vangjush Mbrice		
Andren Mbrice		

Fleta Nr.:  
Emertimi i fletës:

Profiliat terthor progresiv

DISTANCA PËSORE PROJEKTI

KUOTE PROJEKTI

PROGRESIVI I PROJEKTI

DISTANCA PËSORE E TERRENT

KUOTE TERRENT

TERRENTI PROGRESIV

9.79	349.23	-15.00	
4.22	347.28	-5.21	
-3.03	346.85		
-2.50	347.20		
-1.75	347.22		
0.75	347.28		
1.75	347.33		
1.75	347.35		
2.55	345.66		
5.49	345.06		
6.48	343.28		
1.15	342.96		

AKSI  
SEKSIONI 98  
Progresivi: 1+940.00  
Shkalla: 1:200  
Kuota Ref.: 340.00

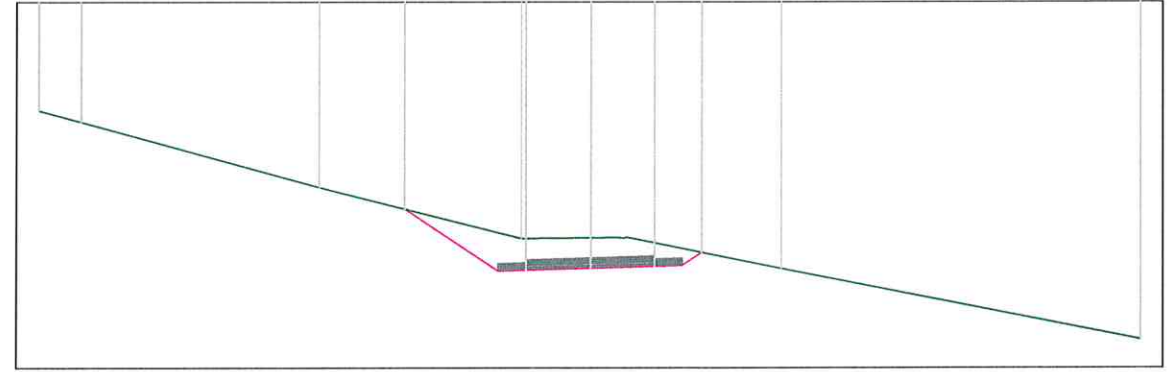



Projekt Zbatimi  
Faza e projektit  
"ASFALTIM RRUGE TE BRENDSHME KOCUL"



EMERITIM BATES:	FORMA:	DATA:	PROJ.:
EMERITIM BATES:	FORMA:	DATA:	PROJ.:
EMERITIM BATES:	FORMA:	DATA:	PROJ.:
EMERITIM BATES:	FORMA:	DATA:	PROJ.:

SHKALLA: A3 1:200  
Fila Nr.: D 0

DISTANCE PUESORE PROJEKTI

KUOTE PROJEKTI

PROGRESIVI I PROJEKTI

DISTANCA PUESORE E TERRENT

KUOTE TERRENT

TERRENTI PROGRESIV

AKSI  
SEKSIONI 99  
Progresivi: 1+960.00  
Shkalla: 1:200  
Kuota Ref.: 340.00

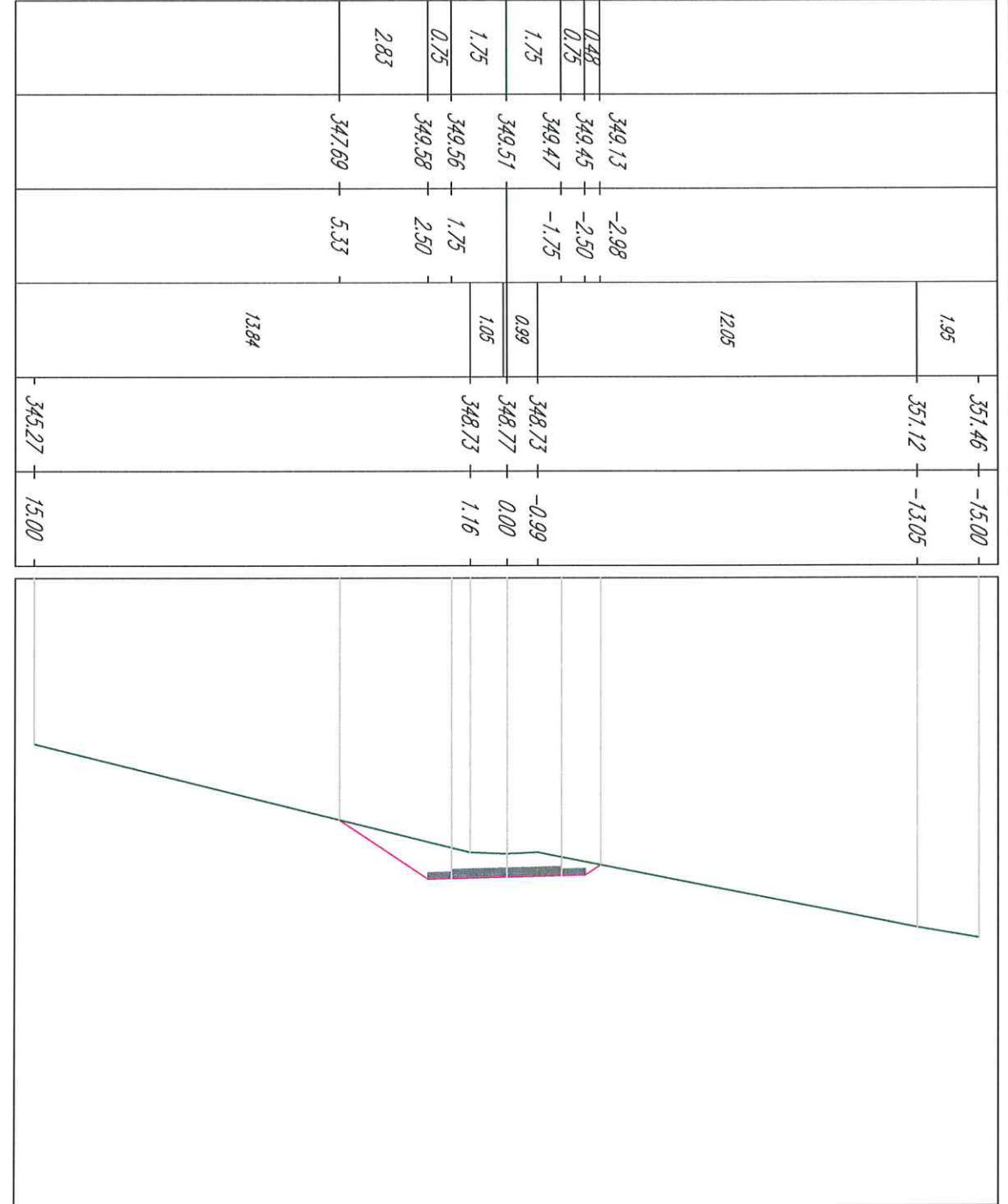

Profilat terthor progresiv



Grupi projektues

EMER MEMVER  
Vanqush Mbrice  
Andren Mbrice

FORM  
DATA  
FIRM

Emeritimi Reres:

Profiliat terthor progresiv

Folia Nr.:

D 0

Numri serial

SHKALLA: A3 1:200

DISTANCE PËSORE PROJEKTI

KUOTE PROJEKTI

PROGRESIVI I PROJEKTI

DISTANCA PËSORE E TERRENT

KUOTE TERRENT

TERRENTI PROGRESIV

AKSI  
SEKSIONI 100  
Progresivi: 1+980.00  
Shkalla: 1:200  
Kuota Ref.: 350.00

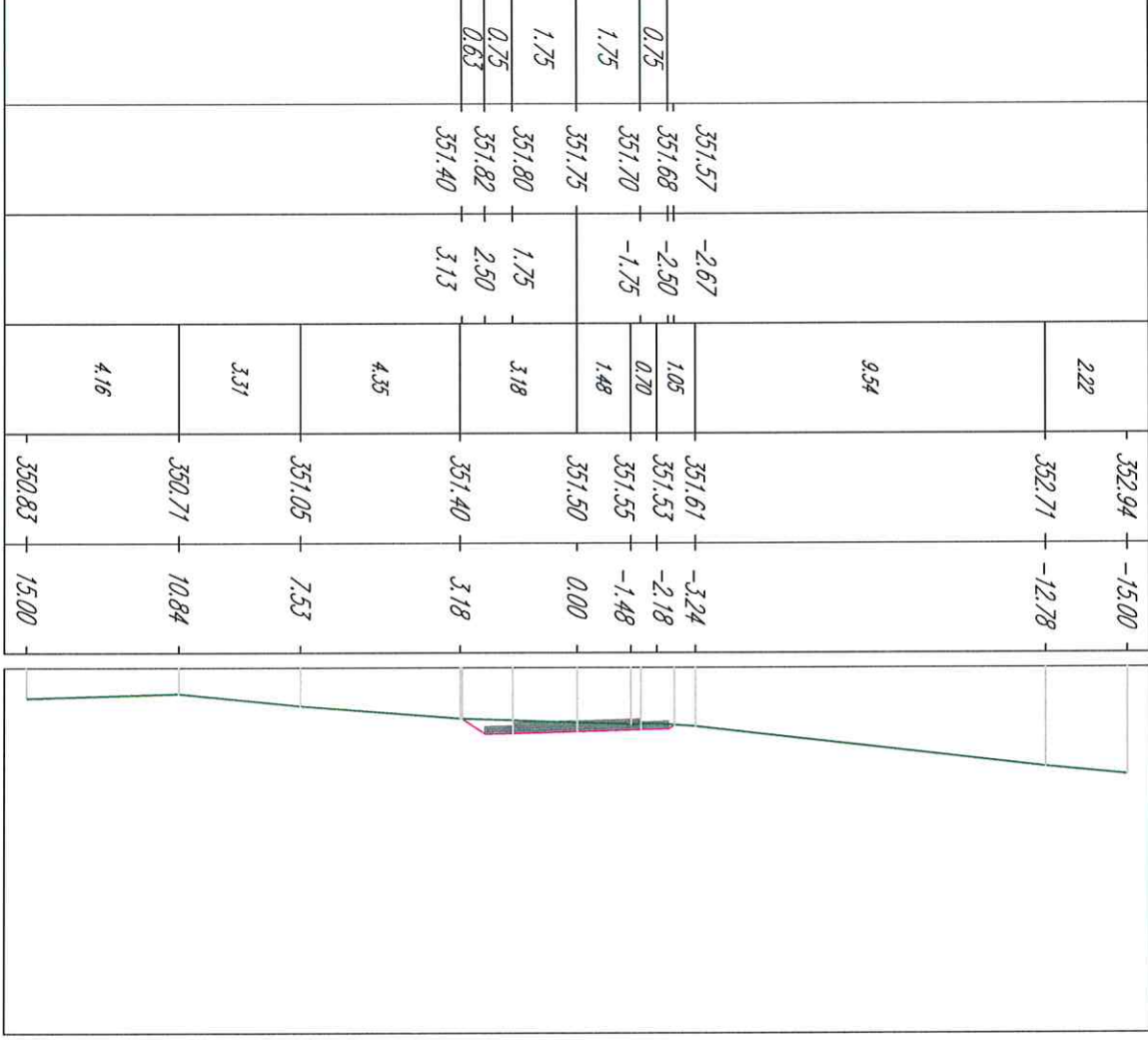



Grupi projektues

EMERITUS MEMBER	DATA:	PRAMA:
Vanjush Mbrice		
Andren Mbrice		

Emeritus Mbrice:

Profilat terthor progresiv

SHKALLA: A3 1:200	Figura Nr.: D 0
-------------------	-----------------

DISTANCE PUESORE PROJEKTI

KUOTE PROJEKTI

PROGRESIVI I PROJEKTI

DISTANCA PUESORE E TERRENI

KUOTE TERRENI

TERRENI PROGRESIV

AKSI  
SEKSIONI 101  
Progresivi: 1+988.73  
Shkalla: 1:200  
Kuota Ref.: 350.00

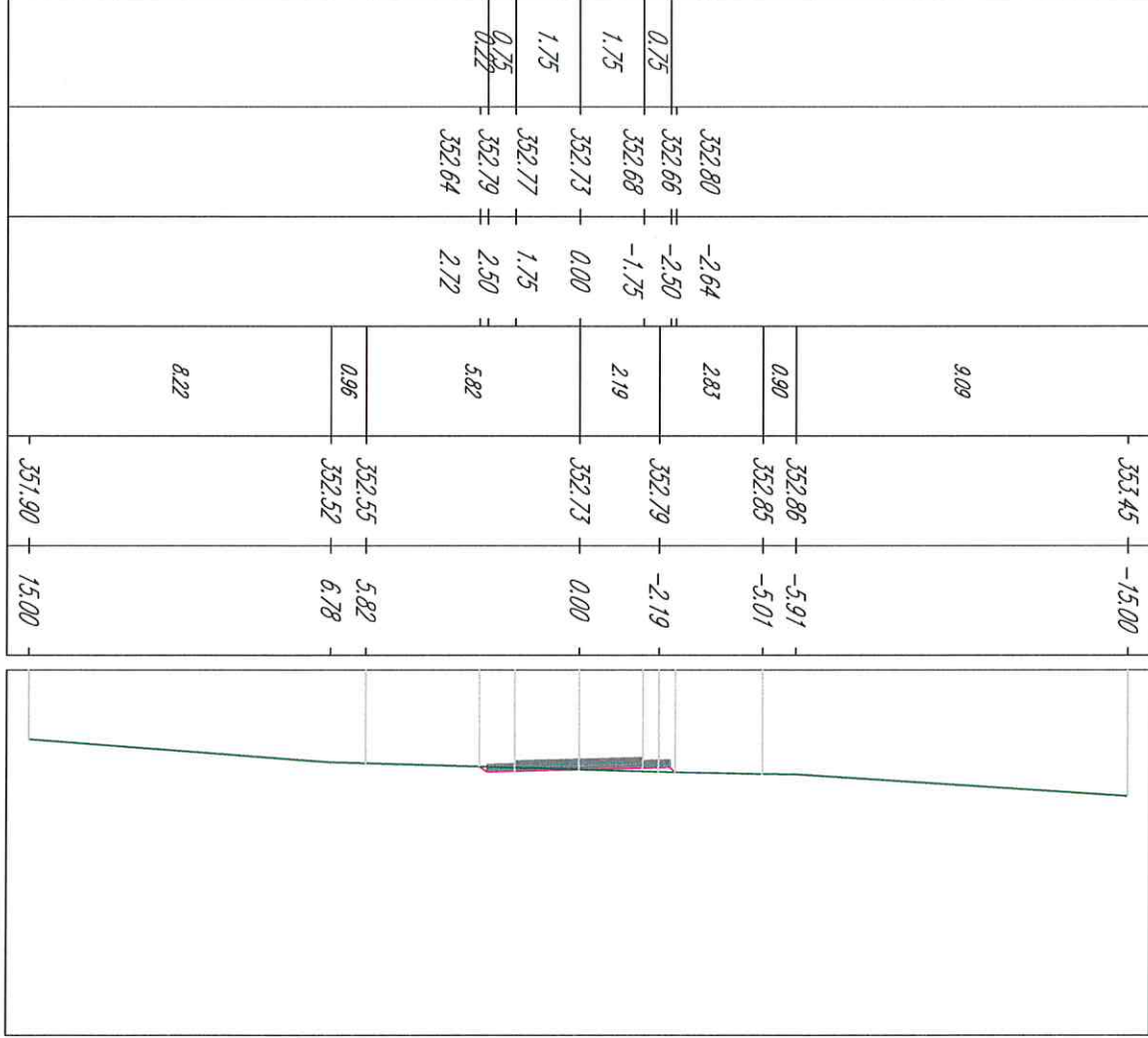

Shenime

Investition:  Bashkia, Selencia

Emertimi i projektit: "ASFALTIM RRUGE TE BRENDSHME KOCUL"

Faza e Projektit: PROJEKT ZBATIM

Projekti i infrastrukturës

Konsulent:  C.E.C Group  
 Emeritues: Emetri Albiemeri  
 Firma: 

Projektoi: Emetri Albiemeri  
 Veprob. Miraqe: 

Emertimi i projektit: Emetri Albiemeri  
 Veprob. Miraqe: 

Dwg. Nr. B1.01

Emertimi i llojit: Planimetria e Simjaktës

KM:

Shkalla: A3 - 1:500







Shenime	
Investitor: Bashkia Shqiptare e Tiranës	
Emertimi i projektit: "ASFALTIM RRUGE TE BRENDSHME KOCUL"	
Faza e Projektit: PROJEKT ZBATIM	
Projekt i infrastrukturës	
Konsulent: C.E.C Group	
Projektoi: Emert Albicmer	Firma:
Instaloi: Vangjel MARRAGE	Instaloi Sistem:
Instaloi: Andon MARRAGE	Instaloi Sistem:
Detyruesi: B1.02	
Emertimi i hetesës: Planimetria e Shtepshikes	
KM:	
Shkalla: A3 - 1:500	





Shenime

Investitor: Bashkia Selenice

Emetimi i Projektit: "ASFALTIM RRUGE TE BRENDSHME KOCUL"

Faza e Projektit: PROJEKT ZBATIM

Projekti i infrastrukturës

Konsulent: CEC Group Civil Engineering Consultants

Projektori: Emer Mbiemer	Firma:
Inzh. Shkencë: Vangjel MARIÇE	
Inzh. Shkencë: Ardian MARIÇE	

Dwg. Nr. B1.03

Emetimi i Retes: Planimetria e Shtjeshkes

KM:

Shkallë: A3 - 1:500



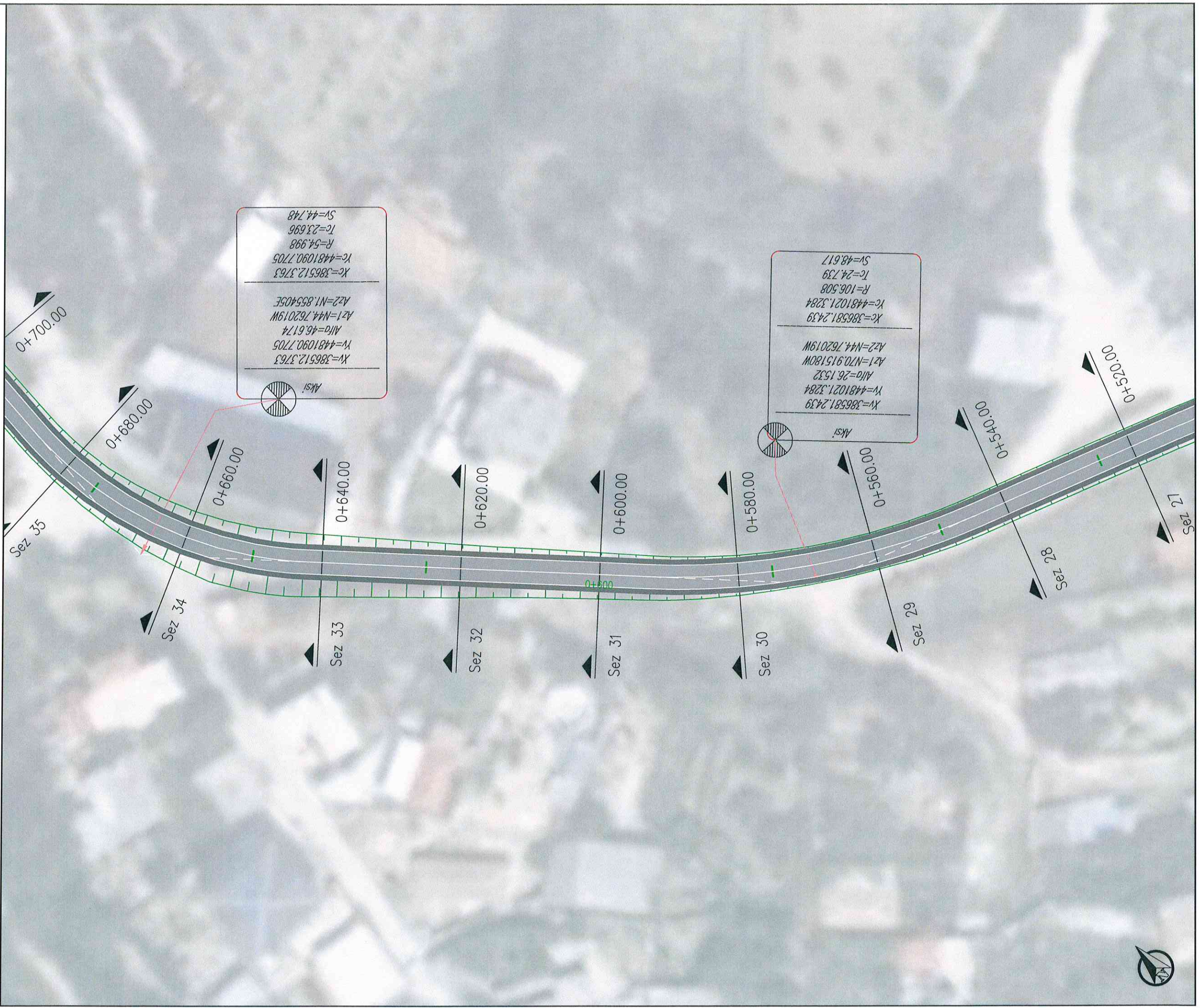

$Kc=386512.3763$   
 $Kv=386512.3763$   
 $Yc=4481090.7705$   
 $Yv=4481090.7705$   
 $Az1=N44.762019W$   
 $Az2=N1.855405E$   
 $R=54.998$   
 $Tc=23.696$   
 $Sv=44.748$

$Kc=386581.2439$   
 $Kv=386581.2439$   
 $Yc=4481021.3284$   
 $Yv=4481021.3284$   
 $Az1=N70.915180W$   
 $Az2=N44.762019W$   
 $R=106.508$   
 $Tc=24.739$   
 $Sv=48.617$

Shenime

Investitor: Beshkia Selencia

Emetimi i projektit: "ASFALTIM RRUGE TE BRENDSHAME KOCUL"

Faza e Projektit: PROJEKT ZBATIM

Projekti i infrastrukturës

Konsulent: C.E.C Group

Projektoi: Emner Mbiemter	Firma:
Isht. Shtetror	Vergjesh. Shtetror
Isht. Shtetror	Autonom. Shtetror

Civil Engineering Consultants  
TRANE - ALBANIA  
C.E.C GROUP

Dwg. No. B1.04

Emetimi i Hecës: Planimetria e Shtjeshkes

KM.

Skalë: A3 - 1:500

Investitor: REPUBLIKA SHQIPËRIE - AGENCIA SELENICE - SHIPIMET DHE BASHKIMET

Basivka Selenice

Investitor

Asfaltim rrugë të brendshme kocol.

Faza e Projektit

PROJEKT ZBATIM

Projekti i infrastrukturës

Konsulent

C.E.C Group

Civil Engineering Consultants

Projektori: Emner Alibemir

Forma

Projekti: Emner Alibemir

Emri i Autorit: Emner Alibemir

Emri i Autorit: Emner Alibemir

Shkalla: A3 - 1:500

Planimetria e Shpalljes

KM.

Dok. Nr. B1.05

Emertimi i Rrës:

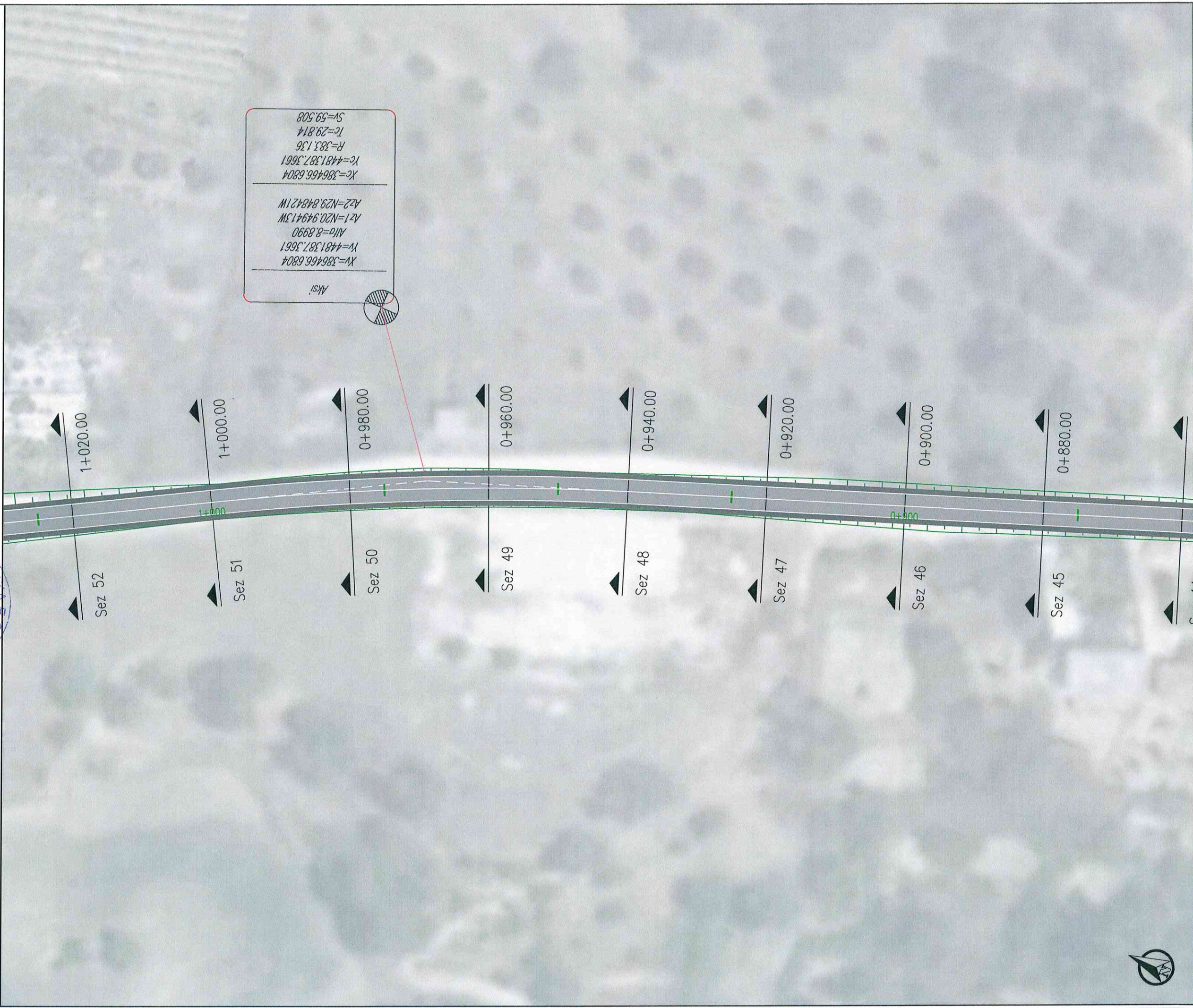

Shenime



Investitor: Bashkia e Selence  
Emertimi i projektit: "ASFALTIMI I RRUGËVE TË BRENDSHMË KOCUL"

Faza e Projektit: PROJEKTI ZBATIM

Projekti i infrastrukturës

Konsulent: C.E.C Group

Projektoi: Tamer Alibemir  
Emri i temës: Tema  
Emri i shërbimit: Shërbimi i temës  
Emri i sistemit: Sistemi i shërbimit



Dwg. Nr. B1.06

Emertimi i Reces: Planimetria e Simjashkës

KM.

Shkalla:

A3 - 1:500





Shenime

Investitor: Bashkia Selence

Emetimi i Projektit: "ASFALTIM RRUGE TE BRENDSHME KOCUL"

Faza e Projektit: PROJEKT ZBATIM

Projekti i infrastruktures

Konsulent: C.E.C Group

Projektoi	Emner Mbeshtet	Firma
Emner Mbeshtet	Yngjorsh Mbeshtet	
Emner Mbeshtet	Yngjorsh Mbeshtet	

Logo: CIVIL ENGINEERING CONSULTANTS C.E.C GROUP TIRANE - ALBANIA

Dwg. Nr. B1.07

Planimetria e Sinjalitikes

KM.

Skala: A3 - 1:500



*Aksi*

$X_v = 386287.1241$
$Y_v = 4481686.1850$
$Alfa = 14.1801$
$Az1 = N21.201793W$
$Az2 = N7.021681W$
$X_c = 386287.1241$
$Y_c = 4481686.1850$
$R = 110.123$
$T_c = 13.697$
$S_v = 27.254$

Shenime



Investitor  
 Bashkia Selenice  
 Emeritimi projektit  
 "ASFALTIM RRUGE TE BRENDSHME KOCUL"

Faza e Projektit  
 PROJEKT ZBATIM

Projekti i infrastrukturës

Konsulenti  
**C.E.C Group**  
 Civil Engineering Consultants

Projektoi	Emer Mbiemer	Firma
Insh. Nderim	Vangjel MBRICE	
Insh. Nderim		

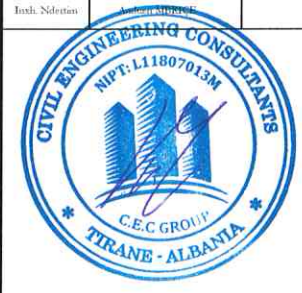

Dwg.Nr. B1.08

Emertimi fletes:  
 Planimetria e Sinjalistikës

KM.

Shkalla:  
 A3 - 1:500





Asi:

$X_1 = 388279,7255$   
 $Y_1 = 4481746,2546$   
 $M_1 = 19,1937$   
 $K_2 = N/26,215368W$

---

$X_2 = 388279,7255$   
 $Y_2 = 4481746,2546$   
 $R = 88,207$   
 $I_2 = 14,914$   
 $S = 29,549$

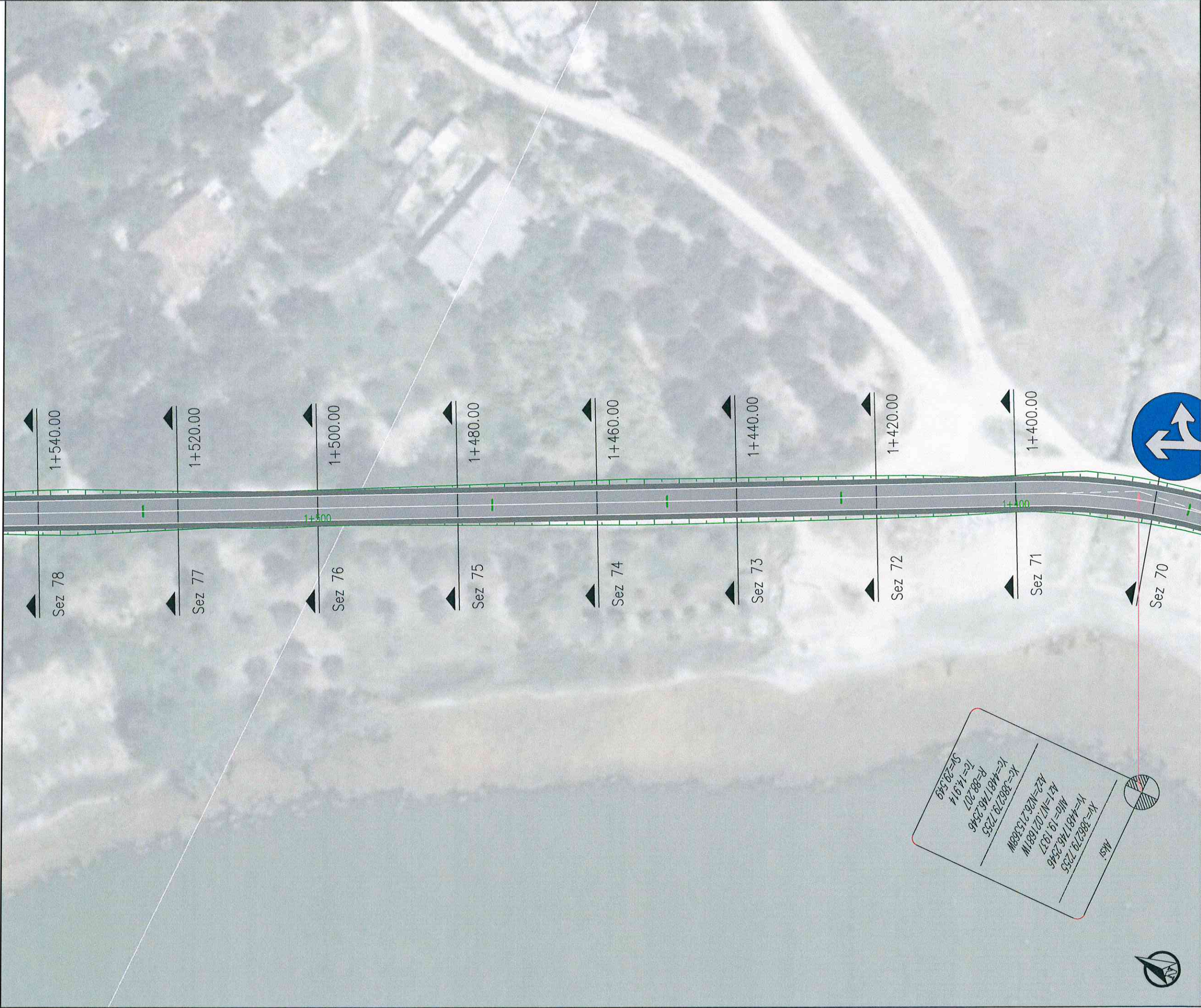

Shenime	
Investitor: Bashkia e Shkupit	
Emertimi i projektit: "ASFALTIM RRUGE TE BRENDSHME KOCUL"	
Faza e Projektit: PROJEKT ZBATIM	
Projekt i infrastrukturës	
Konsulent: C.E.C Group	
Projektoi: Eamer Abicmer	Firma:
Testi i skemës: Vergjohë Shkurtç	
Testi i skemës: Ardhën Shkurtç	
	
Dwg. Nr. B1.09	
Planimetria e Simjastës	
KM.	
Shkallë: A3 - 1:500	



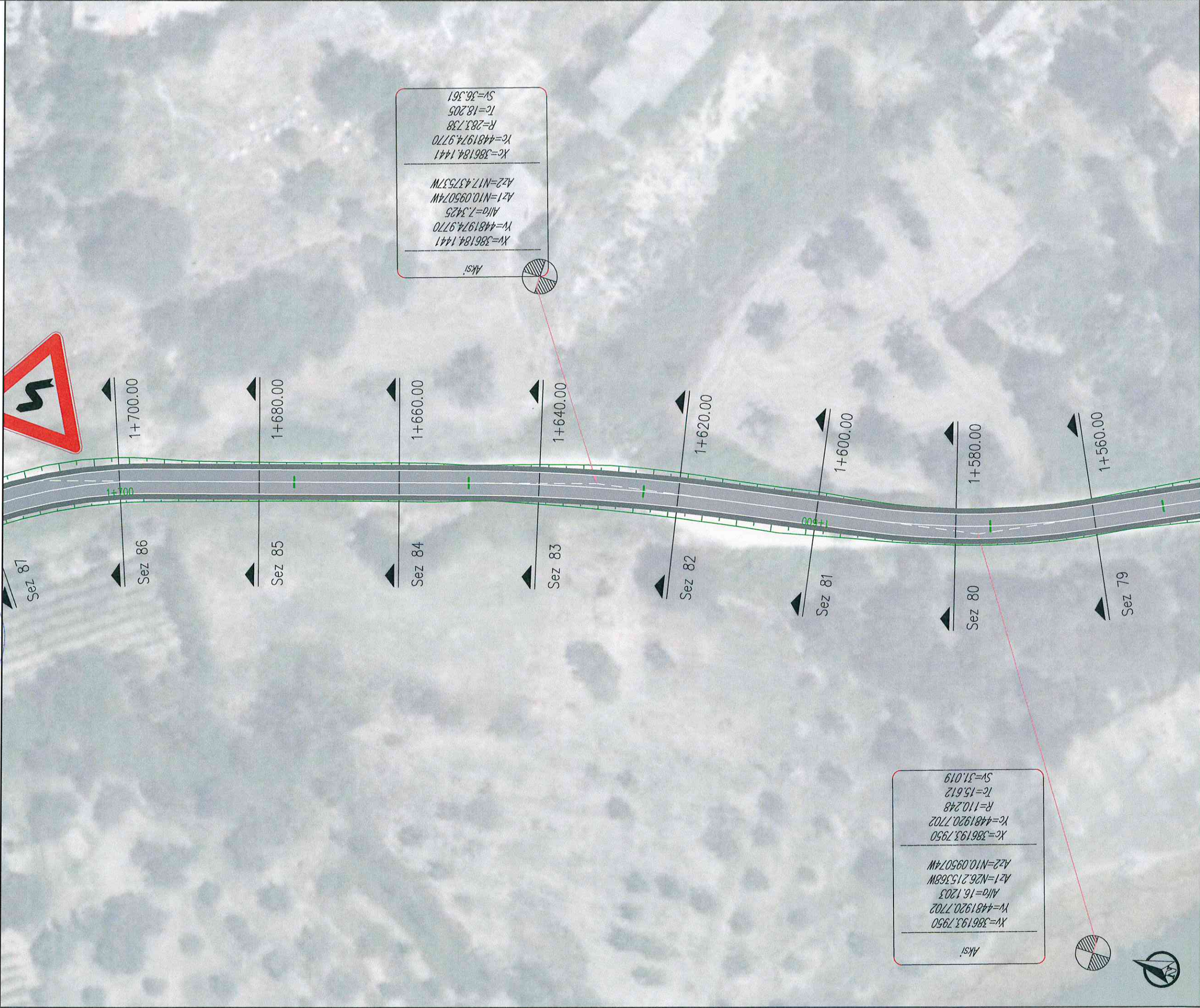

Aksi

X=386184.1441  
 Y=4481974.9770  
 A/a=7.3425  
 Az1=N10.095074W  
 Az2=N17.437537W  
 R=283.738  
 Tc=18.205  
 Sv=36.361

Aksi

X=386193.7950  
 Y=4481920.7702  
 A/a=16.1203  
 Az1=N26.215368W  
 Az2=N10.095074W  
 R=110.248  
 Tc=15.612  
 Sv=31.019

Shenime

Investitor: Bashkia e Shkupit

Emertimi i projektit: "ASFALTIM RRUGE TE BRENDSHAME KOÇUL"

Faza e Projektit: PROJEKT ZBATIM

Projekti i infrastruktures

Konsulent: C.E.C Group

Firma: Tamer Albaner

Dwg. Nr. B1.10

Emertimi i Bases: Planimetria e Simfalsikes

KM.

Shkalla: A3 - 1:500

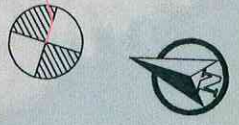



$Xc=386098,7434$   
 $Yc=4482159,6828$   
 $Az1=N85,590619E$   
 $AIfa=18,9869$   
 $R=71,194$   
 $Tc=11,905$   
 $Sv=23,593$

$Xc=386156,0830$   
 $Yc=4482064,3150$   
 $Az1=N17,437537W$   
 $Az2=N62,062001W$   
 $AIfa=44,6245$   
 $R=72,586$   
 $Tc=29,788$   
 $Sv=56,533$

Shenime	
Emertimi i projektit "ASFALTIM RRUGE TE BRENDSHAME KOCUL"	
Faza e Projektit: PROJEKT ZBATIM	
Projekti: infrastruktures	
Konsulent: C.E.C Group	
Projektori: Emerit Albentser	Firma:
Emri i autorit: Kujdesuesi	Adresa:
Emri i autorit: Kujdesuesi	Adresa:
Dwg. Nr. B1.11	
Planimetri e Simjalskes	
KM.	
Shkalla: A3 - 1:500	

REPUBLICA E SHQIPERISE - ENJE  
Bashkia Selence  
Inspector













Investitor: Bashkia Selimë  
 Emertimi i projektit: "ASFALTIM RRUGË TE BRENDSHME KOCUL"

Faza e Projektit: PROJEKT ZBATIM

Projekt i infrastrukturës

Konsulent: C.E.C Group

Projektoi: Emër Albemër  
 bashkëpunuesi: Vangjel Arbërja  
 bashkëpunuesi: Anxheta Arbërja



Dwg.Nr:

Emertimi i Reces: Dëgjatë Shtetërore

KM:

Shkalla: A3 - 1:500

Sinjalet tipike të informimit

(Dimensionet janë në cm)

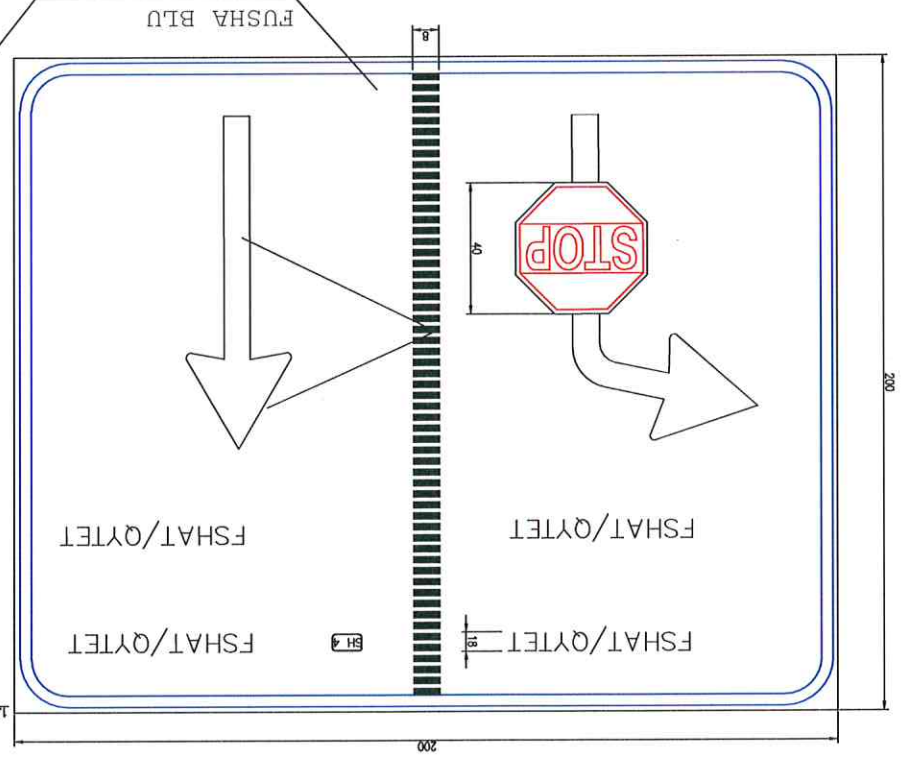

DIMENSIONET E SINJALEVE STANDARTE

(Dimensionet janë në mm)

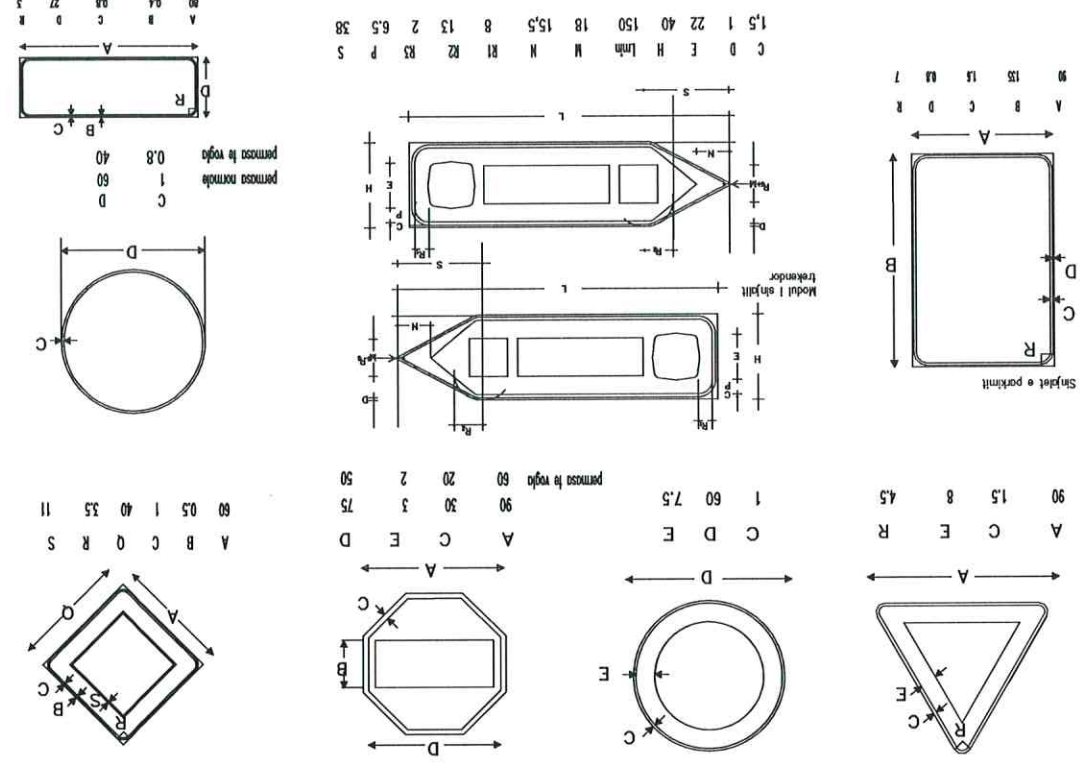

Vendosja e sinjaleve informative

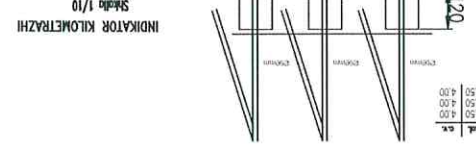

INDIKATOR KILOMETRAZH  
 SH 1/10

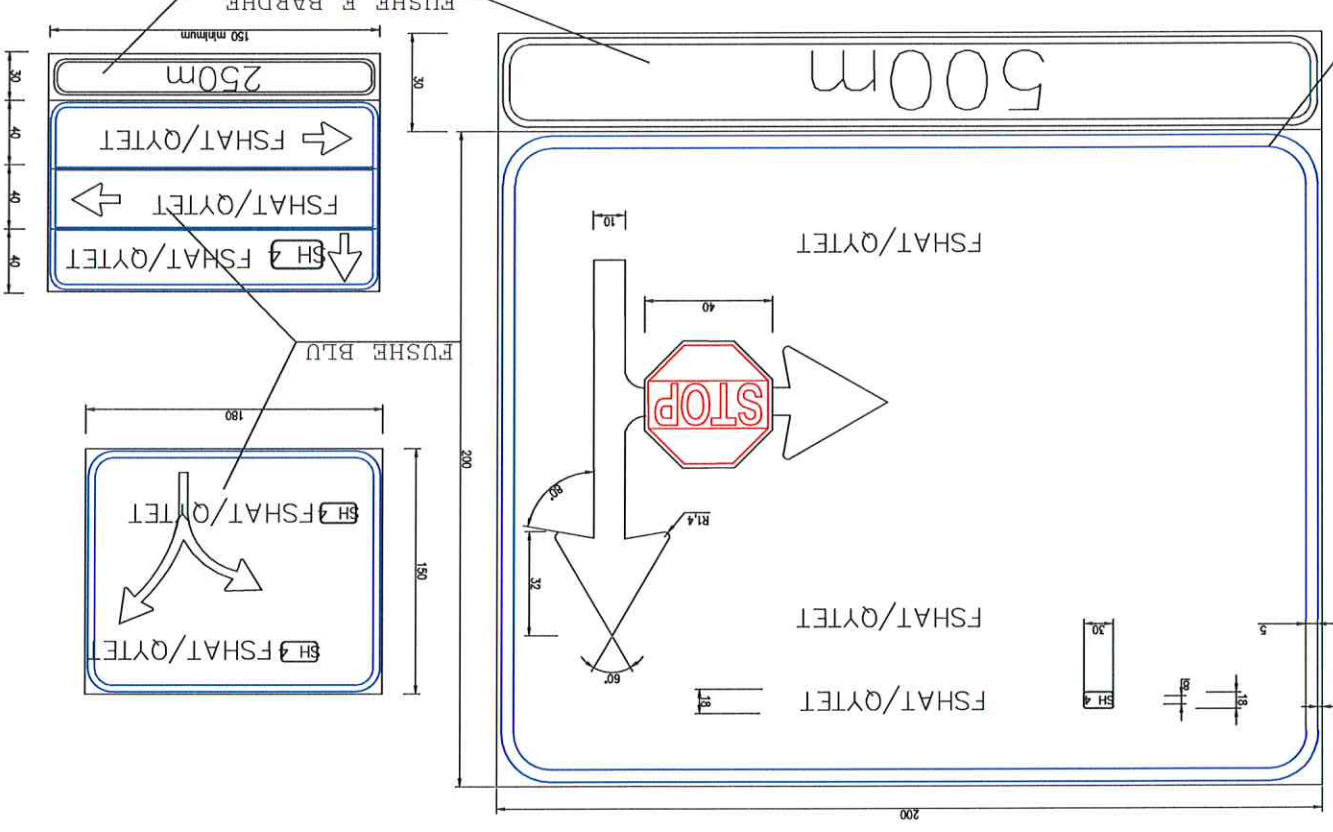
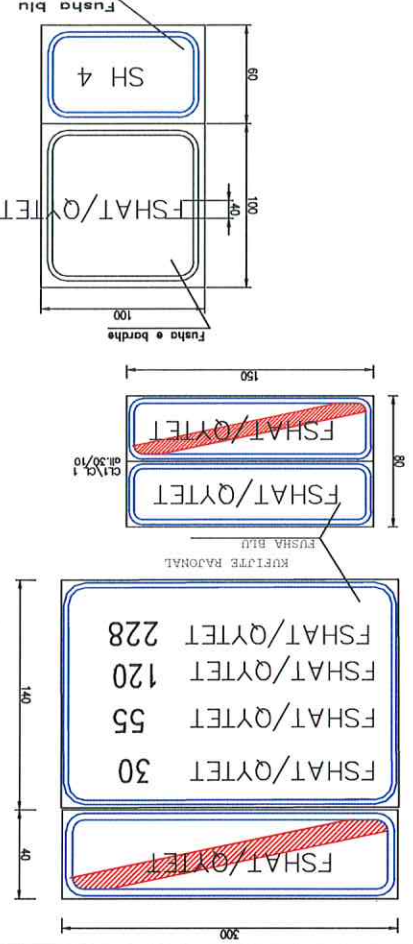
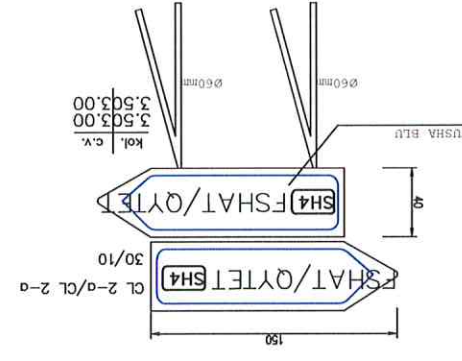

FUSHE E BARDHE

FUSHE BLU

Shenime

Shkallë: A3 - 1:500

KM.

Emertimi i detaj: Detaje Singule

Dag.Nr.

**CIVIL ENGINEERING CONSULTANTS**  
 TIRANE - ALBANIA  
 C.E.C GROUP  
 NPT-L180703M

Projektori	Emneri	Albioner	Firma
hah. Shtetsh	hah. Shtetsh	hah. Shtetsh	hah. Shtetsh

Konsulent

**C.E.C Group**  
 Civil Engineering Consultants

Projekti i infrastruktures

Faza e Projektit

PROJEKT ZBATIM

"ASFALTIM RRUGË TE BRENDSHME KOCUL"

Emertimi i projektit

Bashkia Selence

Investitor

REPUBLIKA E SHQIPËRI

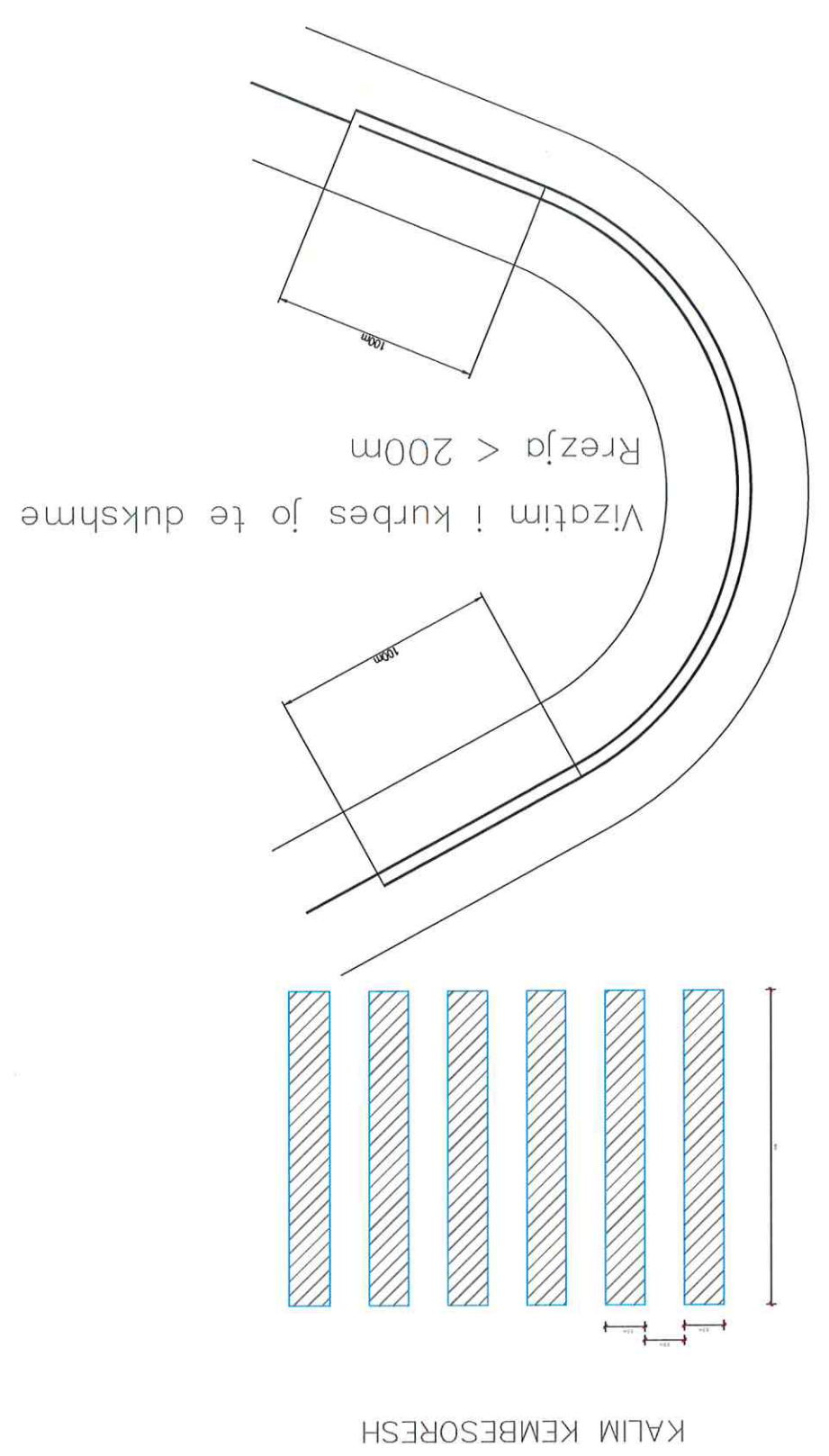
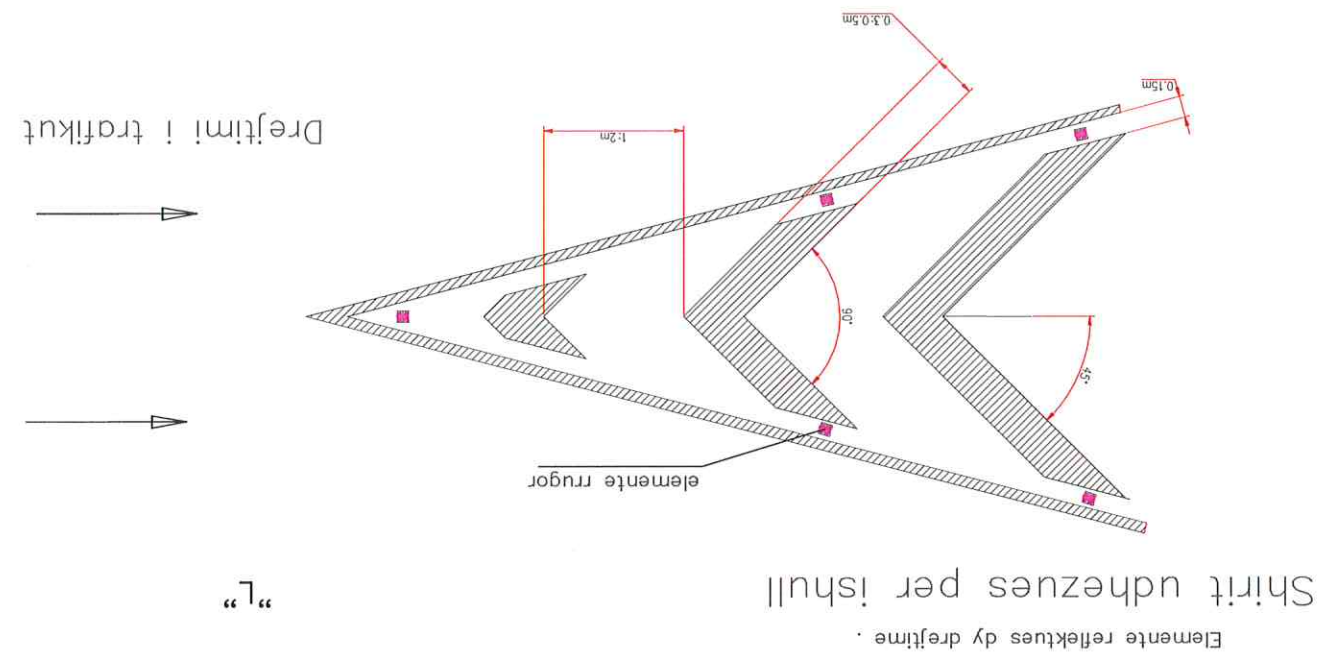
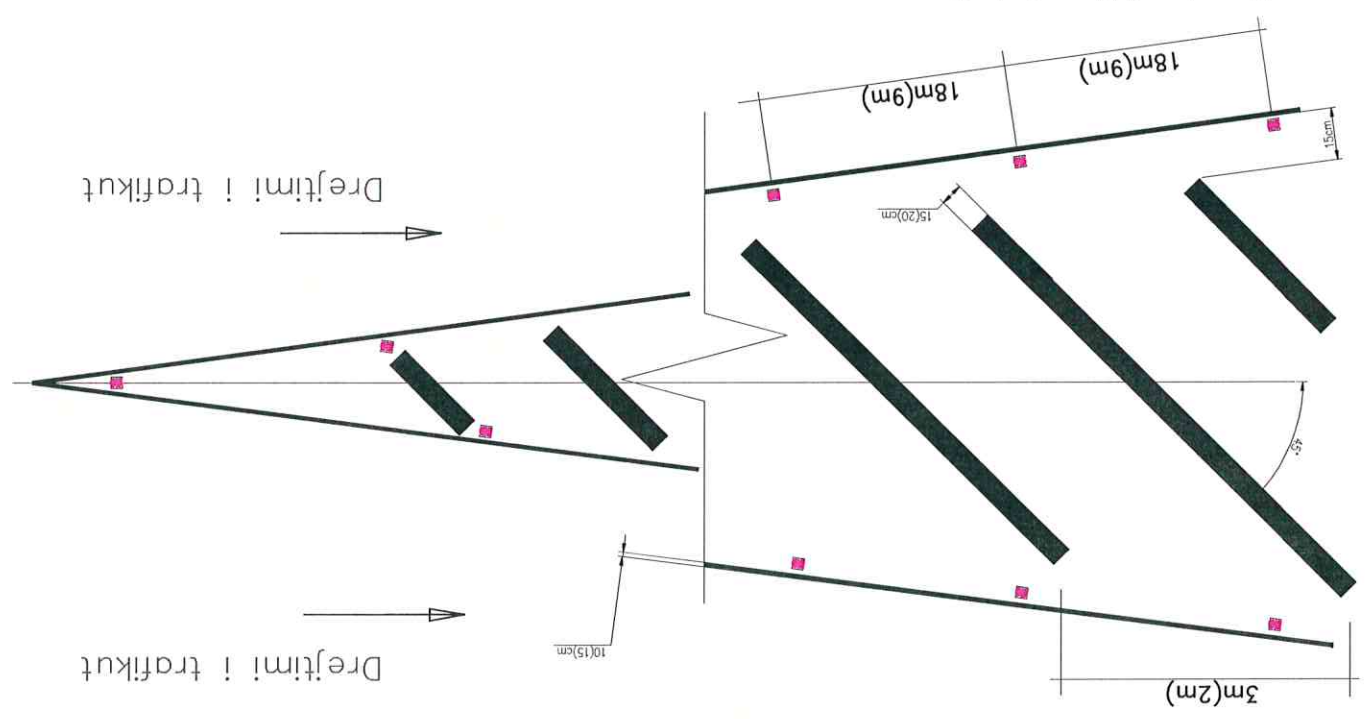
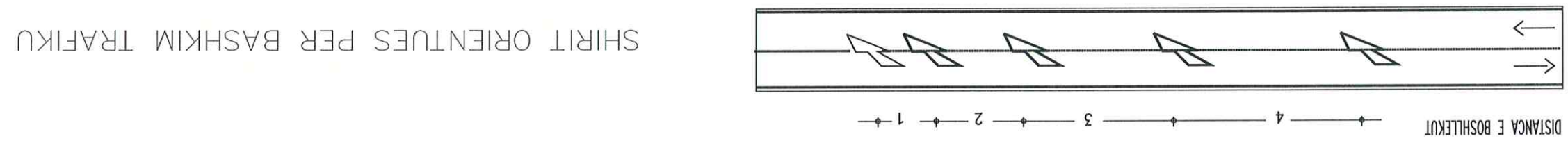



VIJAT E MARKIMIT TE RRUGES

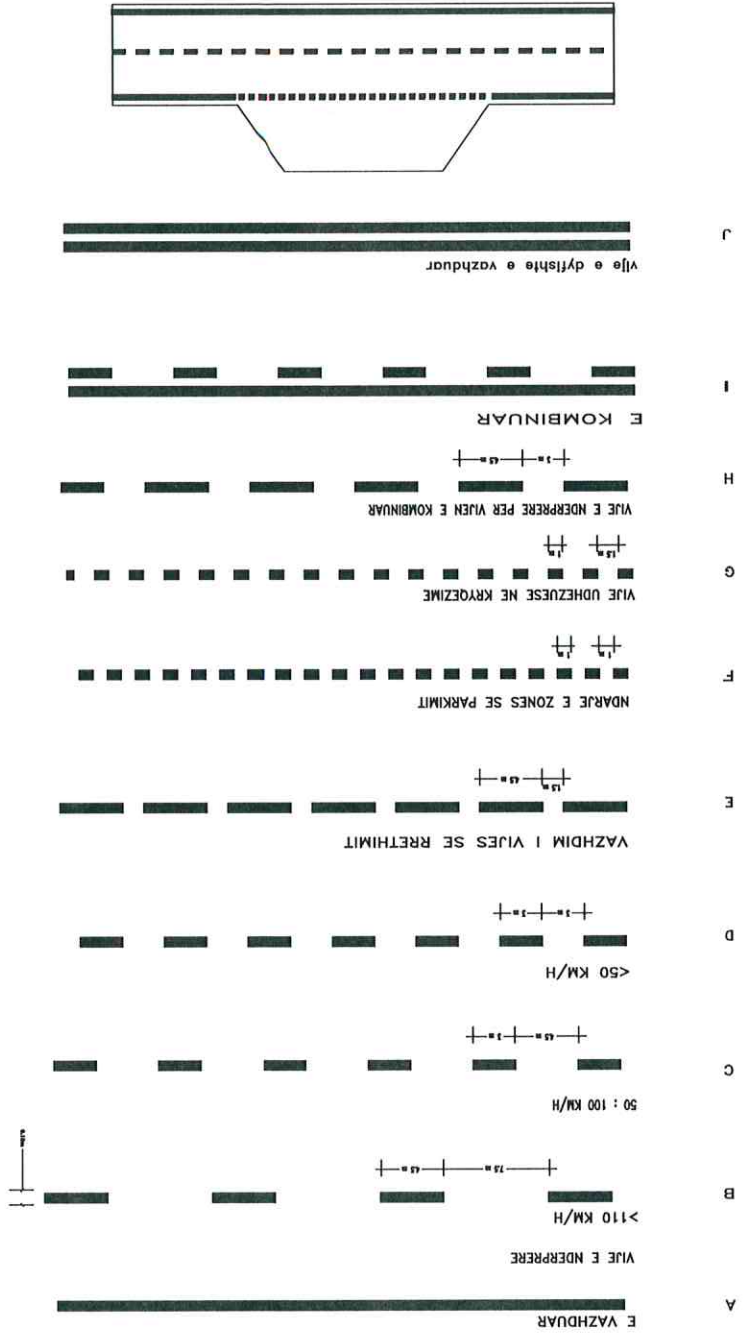

SHIRITAT E MARKIMIT TE RRUGES

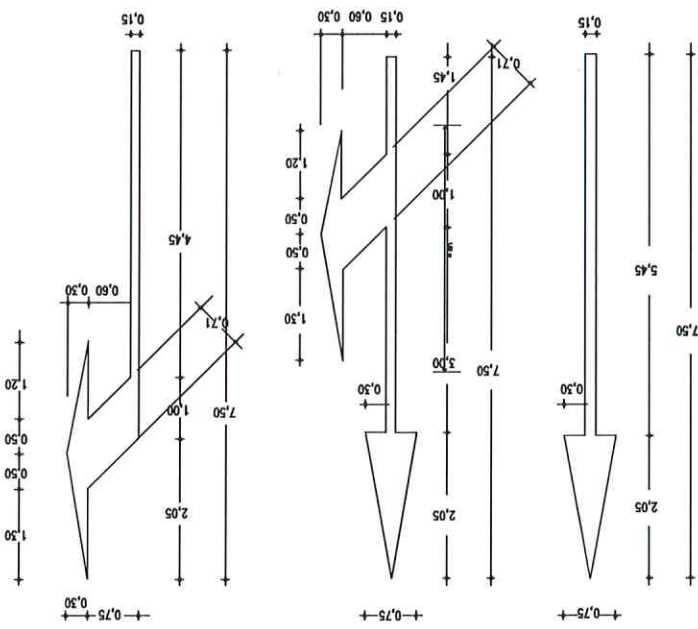

SINJALET JEP PEPARESIS

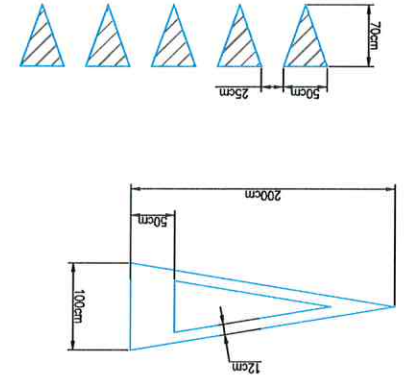

Dimensionet jane ne m

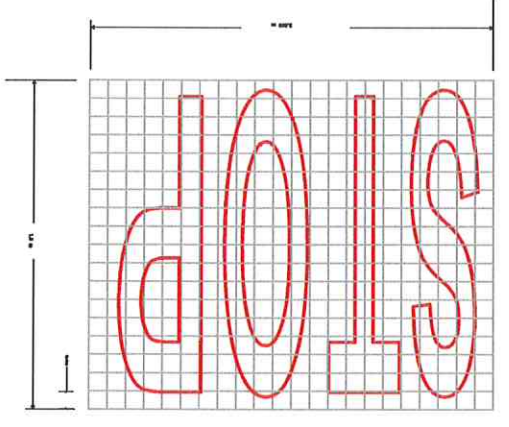
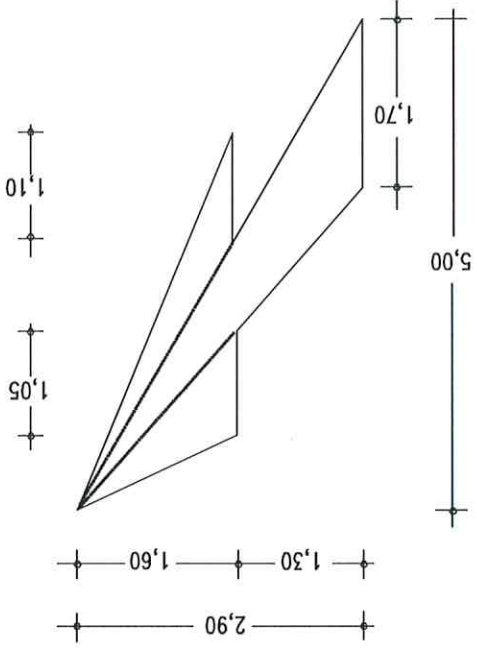

Shenime

Projekti i infrastrukturës

PROJEKT ZBATIM

Faza e Projektit

"ASFALTIM RRUGË TE BRENDSHME KOCUL"

Investitor

Bashkia Selitice

Emertimi i projektit

Konsulent

C.E.C Group

Civil Engineering Consultants

Firma

Emner Mbiemret

Projektoi

Faqe Mbiemret

Task. Schemat

Vergjesh Mbiemret

Task. Schemat

Author Mbiemret

KM

Shtalle

A3 - 1:500