

PROJEKT ZBATIMI

OBJEKTI:Rehabilitim i Rrjetit të Ujesjellësit `` Lagjia Zall Mner``,Kamez



— Kufiri i zones se Projektit

479824.465
4580742.323

[https://geoportal.asig.gov.al/ofron të dhëna gjeohapësinore të ofruara nga autoritetet publike përgjegjëse.](https://geoportal.asig.gov.al/ofron-te-dhena-gjeohapësinore-te-ofruara-nga-autoritetet-publike-pergjegjese)
Përgjegjësia për saktësinë e të dhënave është e autoritetit publik që i ka krijuar ato.

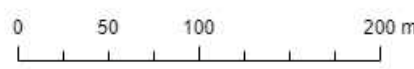

STUDIO PROJEKTIMI
Liçense N.6591/7
"ROALB STUDIO" sh.p.k

Rehabilitim i Rrjetit të Ujesjellësit `` Lagjia Zall Mner``,Kamez	ING.HAMZA KAZIA	Liç. nr.1039/3	
	Ing.Hidroteknik Defrim XHEMALI	Liç. nr.1142/2	
EMERTIMI I FLETES ORTOFOTO ZONES KAPAKU I PROJEKTTIT	ING TOP.EDMOND NDOJ	Liç. nr.T.1299	
	KAMEZ 2023	SHK1/2000	FL.1

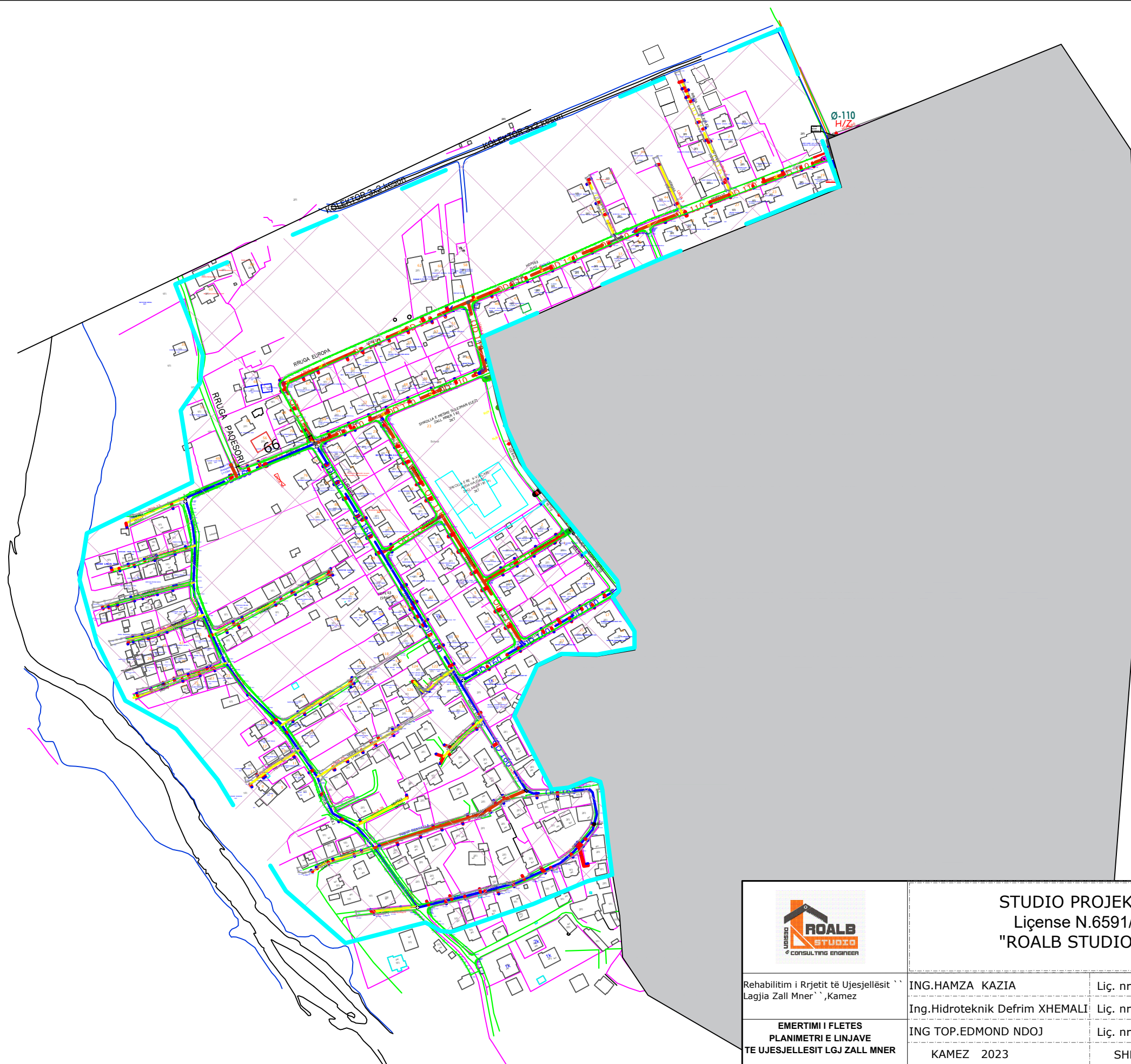



ZONE E PROJEKTIT
 S≈21ha

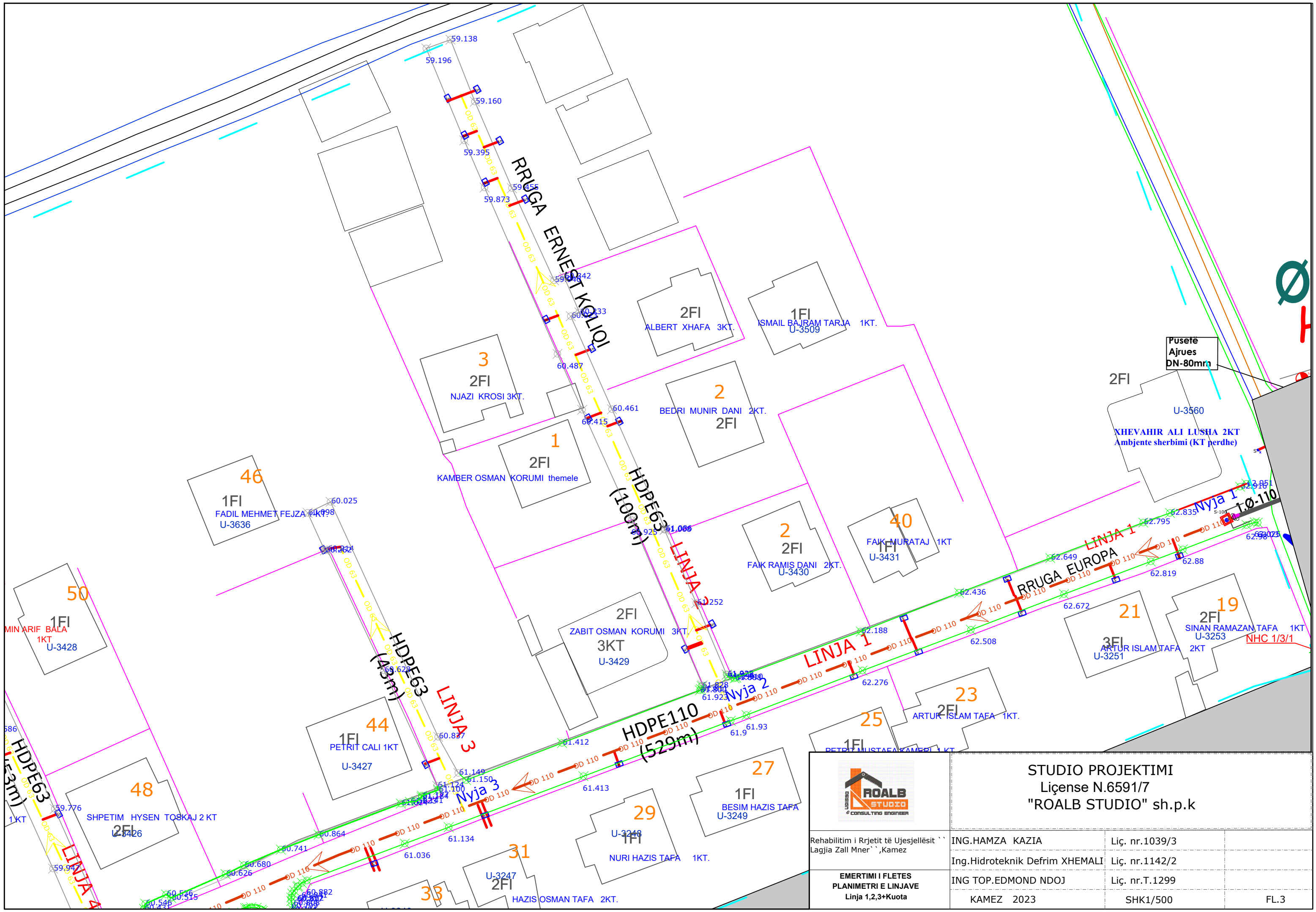

STUDIO PROJEKTIMI
 Liçense N.6591/7
 "ROALB STUDIO" sh.p.k

Rehabilitim i Rrjetit të Ujesjellësit Lagja Zall Mner, Kamez	ING.HAMZA KAZIA	Liç. nr.1039/3	
	Ing.Hidroteknik Defrim XHEMALI	Liç. nr.1142/2	
EMERTIMI I FLETES PLANIMETRI E LINJAVE TE UJESJELLESIT LGJ ZALL MNER	ING TOP.EDMOND NDOJ	Liç. nr.T.1299	
	KAMEZ 2023	SHK1/2000	FL.2



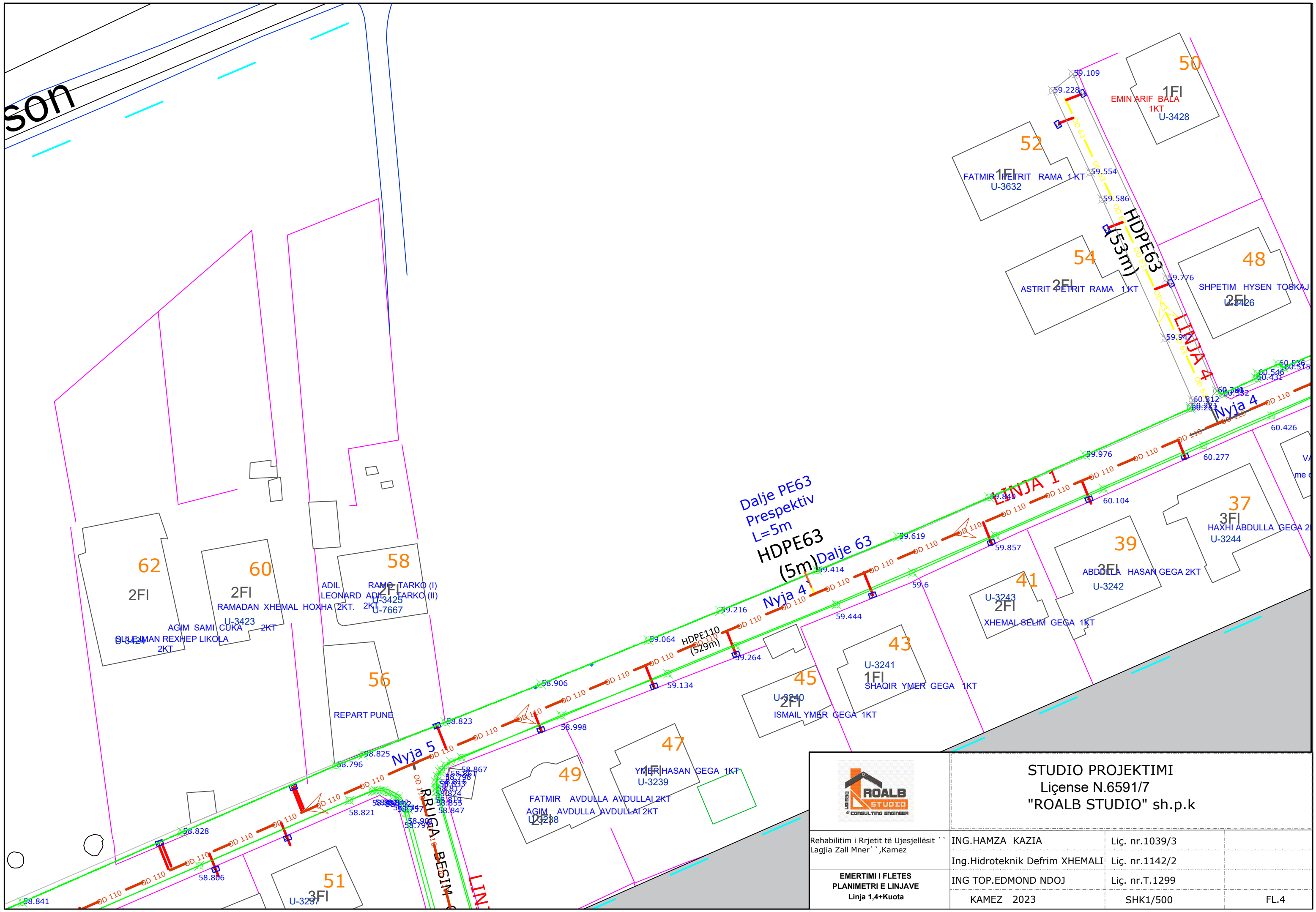

		STUDIO PROJEKTIMI Liçense N.6591/7 "ROALB STUDIO" sh.p.k	
		Rehabilitim i Rrjetit të Ujesjellësit të Lagjia Zall Mner, Kamez	ING.HAMZA KAZIA
EMERTIMI I FLETES PLANIMETRI E LINJAVE Linja 1,2,3+Kuota	Ing.Hidroteknik Defrim XHEMALI	Liç. nr.1142/2	
	ING TOP.EDMOND NDOJ	Liç. nr.T.1299	
	KAMEZ 2023	SHK1/500	FL.3

son

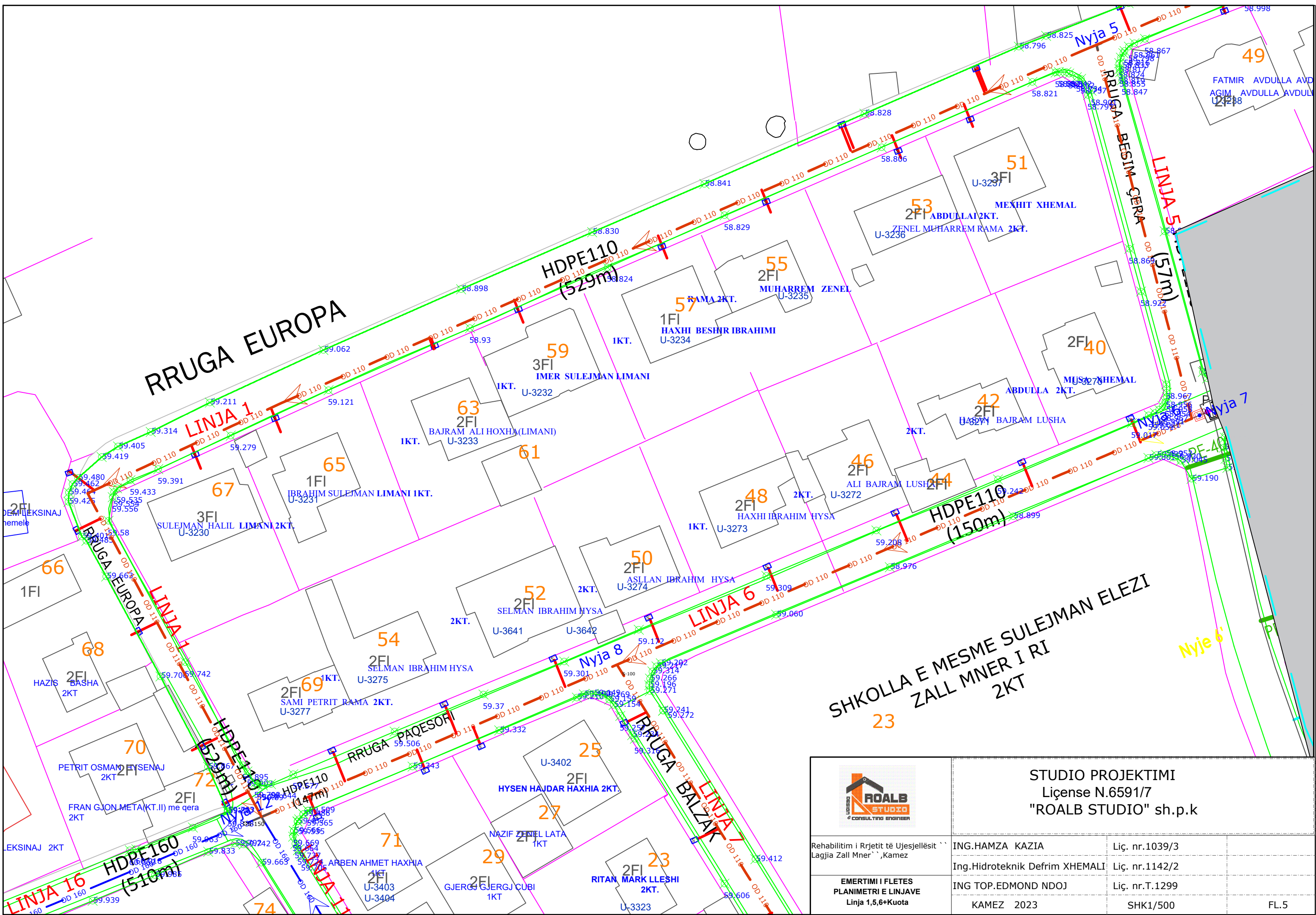

	STUDIO PROJEKTIMI Liçense N.6591/7 "ROALB STUDIO" sh.p.k		
	Rehabilitim i Rrjetit të Ujesjellësit Lagjia Zall Mner` ,Kamez	ING.HAMZA KAZIA Ing.Hidroteknik Defrim XHEMALI	Liç. nr.1039/3 Liç. nr.1142/2
EMERTIMI I FLETES PLANIMETRI E LINJAVE Linja 1,4+Kuota	ING TOP.EDMOND NDOJ KAMEZ 2023	Liç. nr.T.1299 SHK1/500	FL.4



	STUDIO PROJEKTIMI Liçense N.6591/7 "ROALB STUDIO" sh.p.k		
	Reabilitim i Rrjetit të Ujesjellësit Lagjia Zall Mner I Ri, Kamez	ING.HAMZA KAZIA Ing.Hidroteknik Defrim XHEMALI ING TOP.EDMOND NDOJ	Liç. nr.1039/3 Liç. nr.1142/2 Liç. nr.T.1299
EMERTIMI I FLETES PLANIMETRI E LINJAVE Linja 1,5,6+Kuota	KAMEZ 2023	SHK1/500	

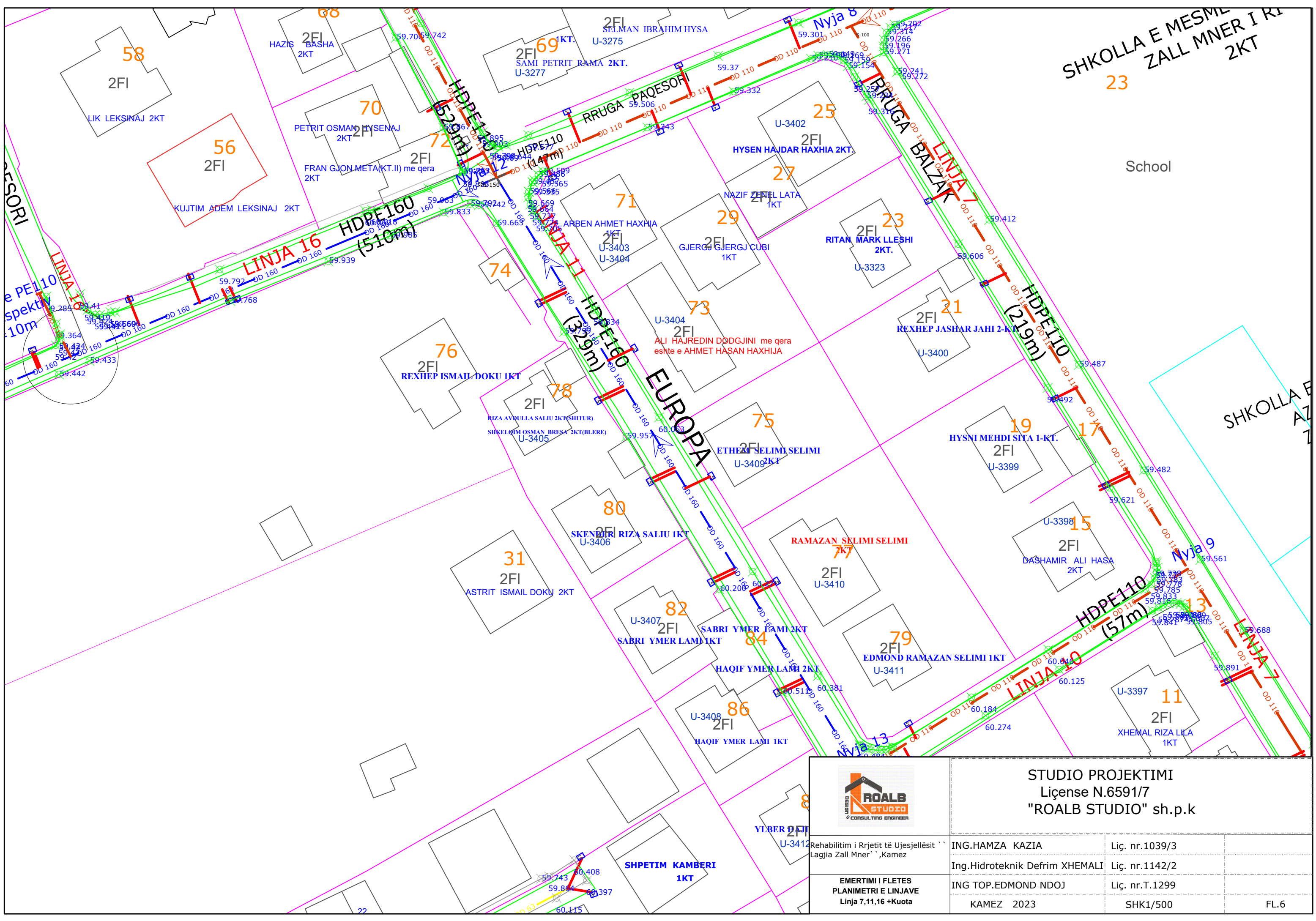

	STUDIO PROJEKTIMI Liçense N.6591/7 "ROALB STUDIO" sh.p.k	
	Reabilitim i Rrjetit të Ujesjellësit Lagjia Zall Mner` ,Kamez	ING.HAMZA KAZIA Ing.Hidroteknik Defrim XHEMALI
EMERTIMI I FLETES PLANIMETRI E LINJAVE Linja 7,11,16 +Kuota	ING TOP.EDMOND NDOJ KAMEZ 2023	Liç. nr.T.1299 SHK1/500
		FL.6

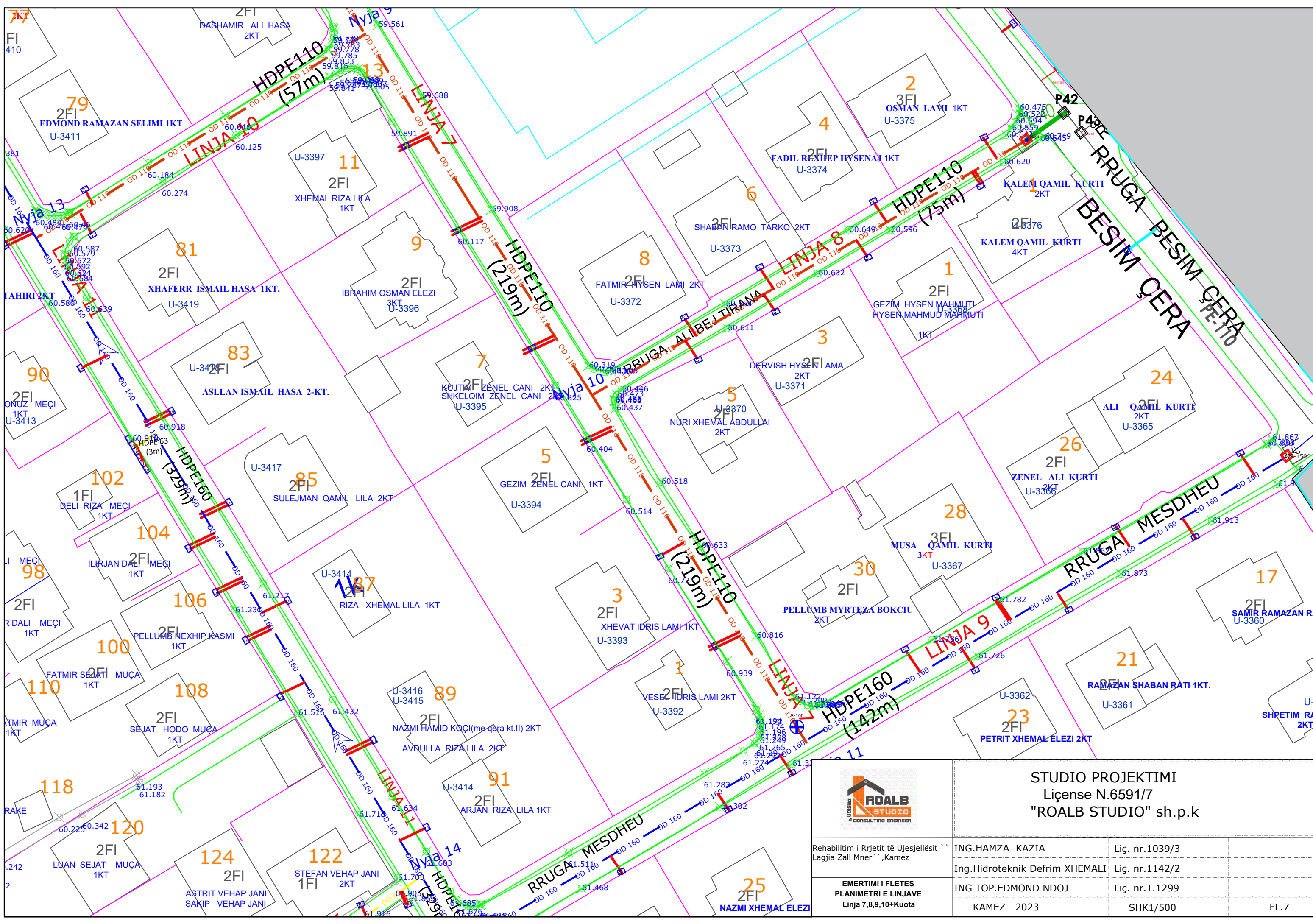

		STUDIO PROJEKTIMI Liçense N.6591/7 "ROALB STUDIO" sh.p.k	
Reabilitim i Rrjetit të Ujesjellësit Lagjia Zall Mner, Kamez		ING.HAMZA KAZIA Ing.Hidroteknik Defrim XHEMALI	Liç. nr.1039/3 Liç. nr.1142/2
EMERTIMI I FLETES PLANIMETRI E LINJAVE Linja 7,8,9,10+Kuota		ING.TOP.EDMOND NDOJ KAMEZ 2023	Liç. nr.T.1299 SHK1/500
			FL.7

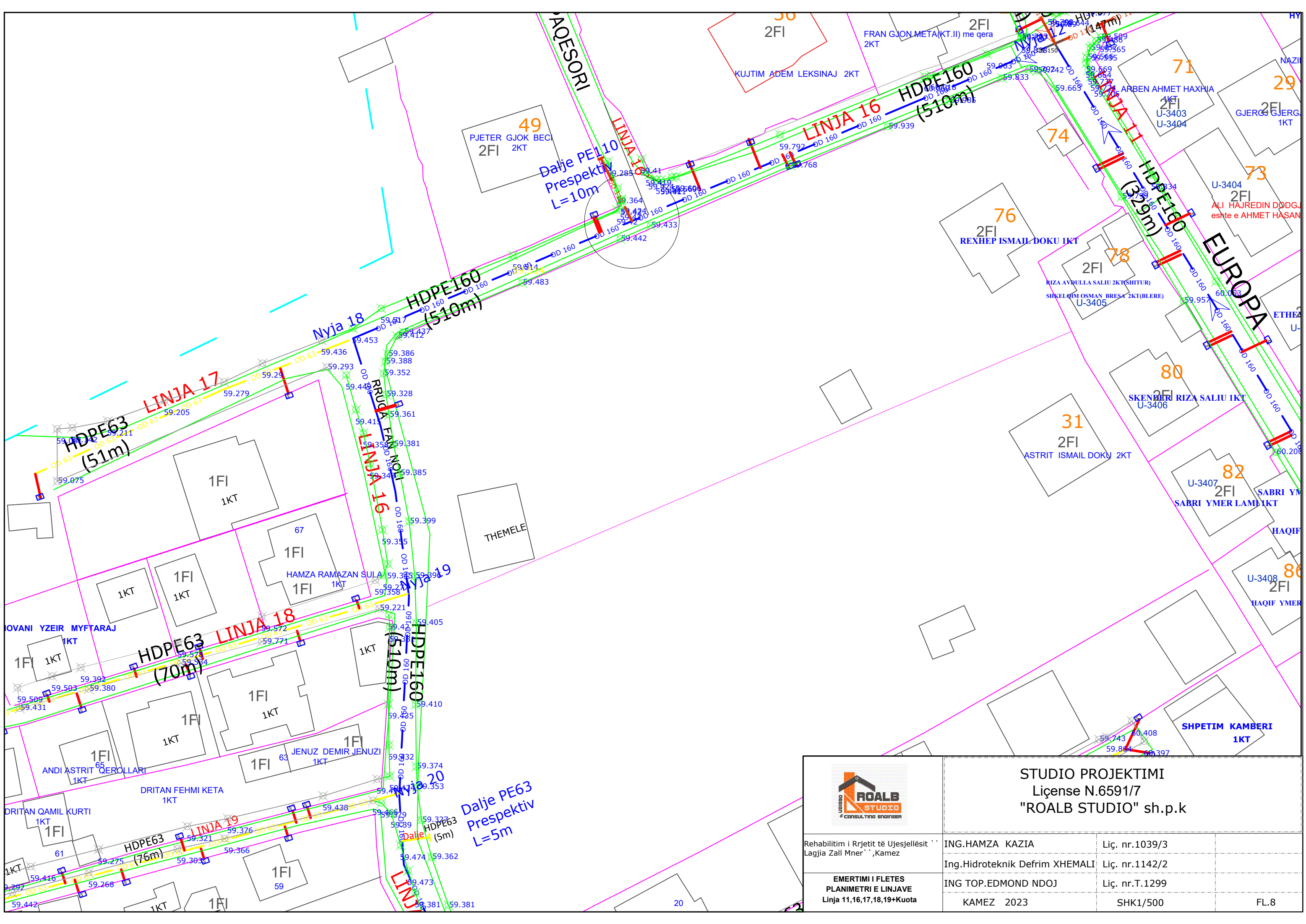

	STUDIO PROJEKTIMI Liçense N.6591/7 "ROALB STUDIO" sh.p.k		
	Rehabilitim i Rrjetit të Ujesjellësit Lagjia Zall Mner` ,Kamez	ING.HAMZA KAZIA Ing.Hidroteknik Defrim XHEMALI	Liç. nr.1039/3 Liç. nr.1142/2
EMERTIMI I FLETES PLANIMETRI E LINJAVE Linja 11,16,17,18,19+Kuota	ING TOP.EDMOND NDOJ KAMEZ 2023	Liç. nr.T.1299 SHK1/500	FL.8

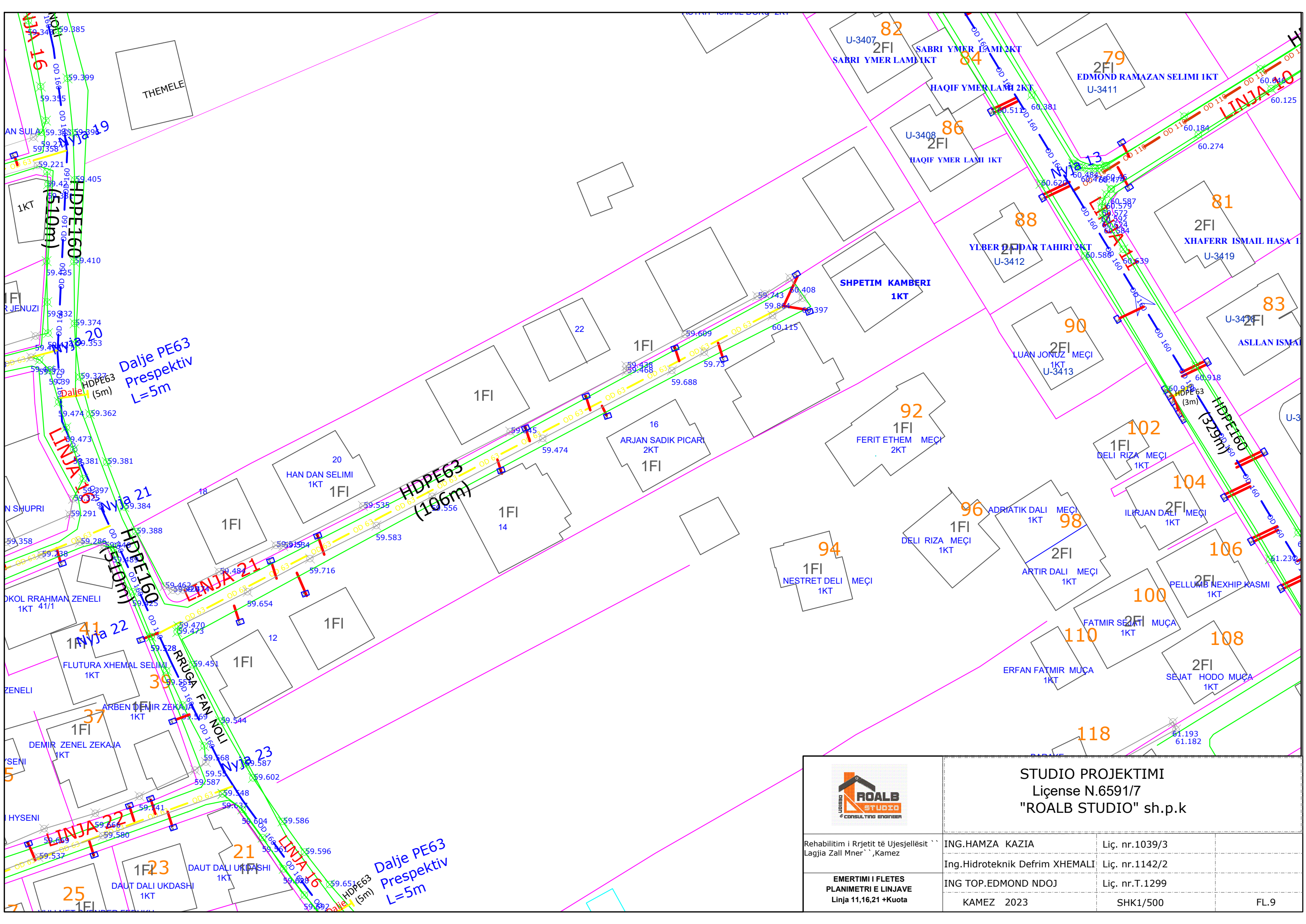

STUDIO PROJEKTIMI
 Liçense N.6591/7
 "ROALB STUDIO" sh.p.k

Rehabilitim i Rrjetit të Ujesjellësit të Lagjia Zall Mner, Kamez	ING.HAMZA KAZIA	Liç. nr.1039/3	
	Ing.Hidroteknik Defrim XHEMALI	Liç. nr.1142/2	
EMERTIMI I FLETES PLANIMETRI E LINJAVE Linja 11,16,21 +Kuota	ING TOP.EDMOND NDOJ	Liç. nr.T.1299	
	KAMEZ 2023	SHK1/500	FL.9

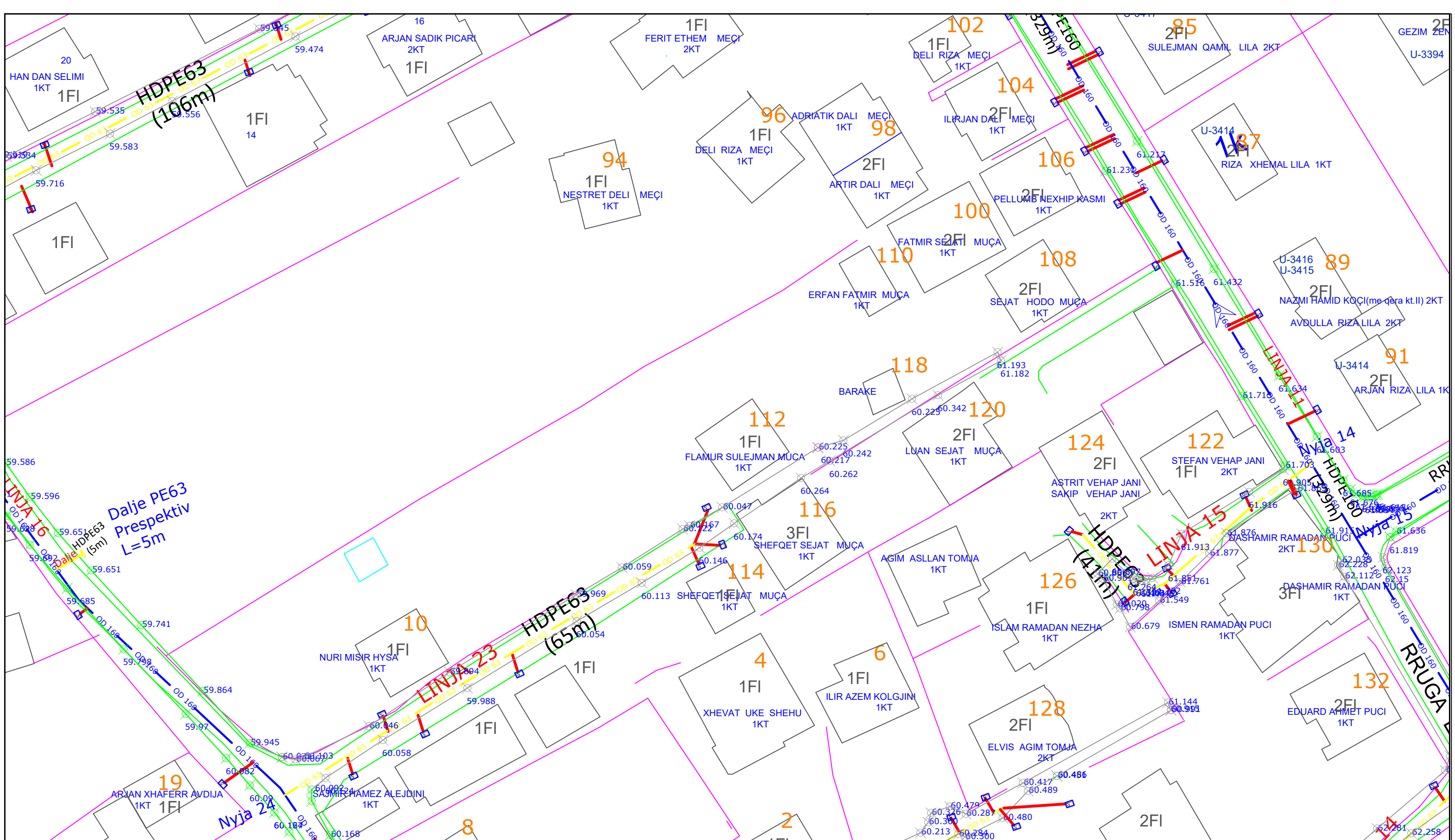

STUDIO PROJEKTIMI
 Liçense N.6591/7
 "ROALB STUDIO" sh.p.k

Rehabilitim i Rrjetit të Ujesjellësit
 Lagjia Zall Mner", Kamez
**EMERTIMI I FLETES
 PLANIMETRI E LINJAVE
 Linja 11,16,23 +Kuota**

ING.HAMZA KAZIA
 Ing.Hidroteknik Defrim XHEMALI
 ING TOP.EDMOND NDOJ
 KAMEZ 2023

Liç. nr.1039/3
 Liç. nr.1142/2
 Liç. nr.T.1299
 SHK1/500
 FL.10

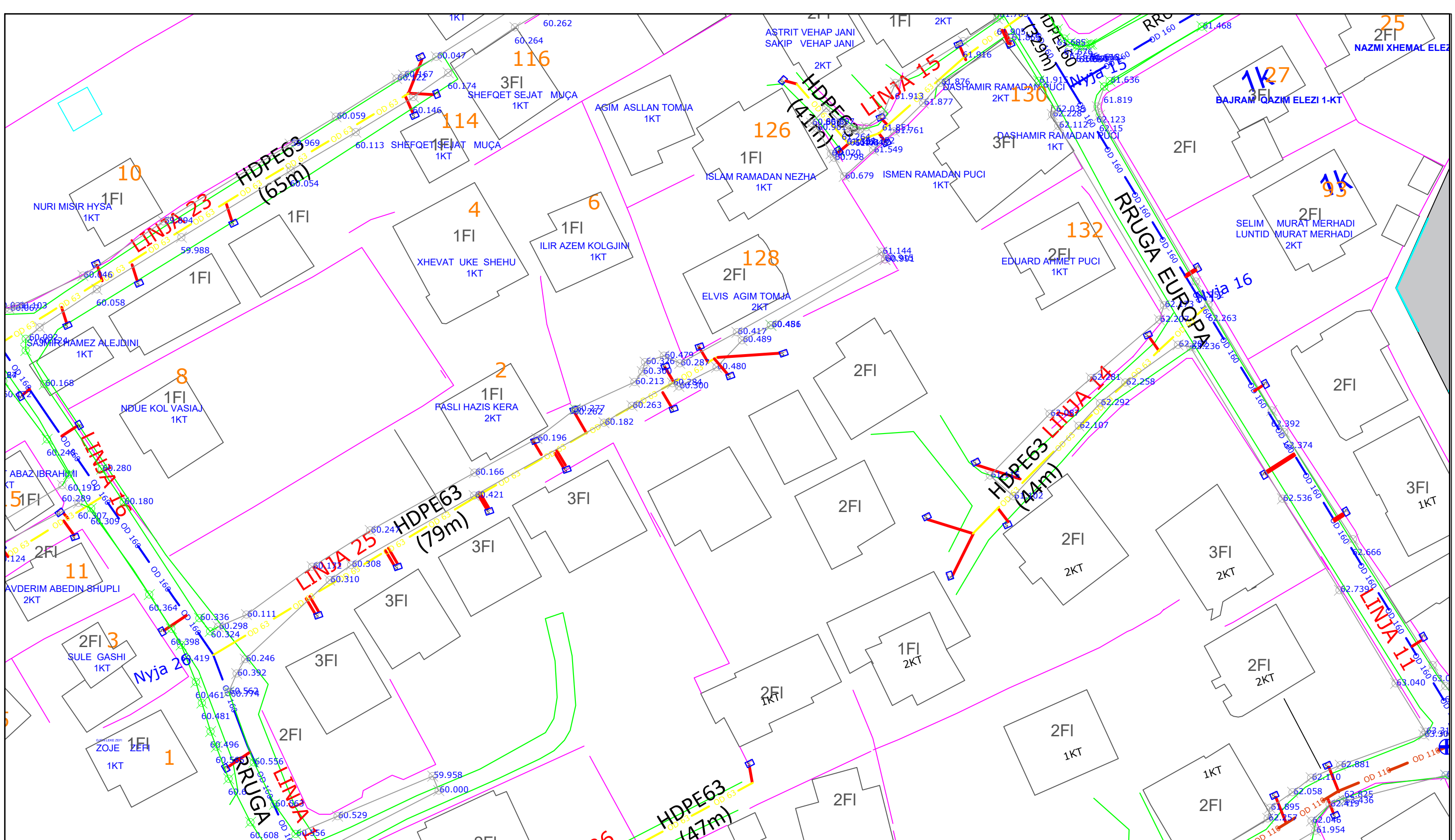

STUDIO PROJEKTIMI
Liqense N.6591/7
"ROALB STUDIO" sh.p.k

Rehabilitim i Rrjetit të Ujesjellësit "Lagjia Zall Mner", Kamez
EMERTIMI I FLETES PLANIMETRI E LINJAVE
Linja 11,14,15,23,25,26 +Kuota

ING.HAMZA KAZIA	Liq. nr.1039/3
Ing.Hidroteknik Defrim XHEMALI	Liq. nr.1142/2
ING TOP.EDMOND NDOJ	Liq. nr.T.1299
KAMEZ 2023	SHK1/500
	FL.11

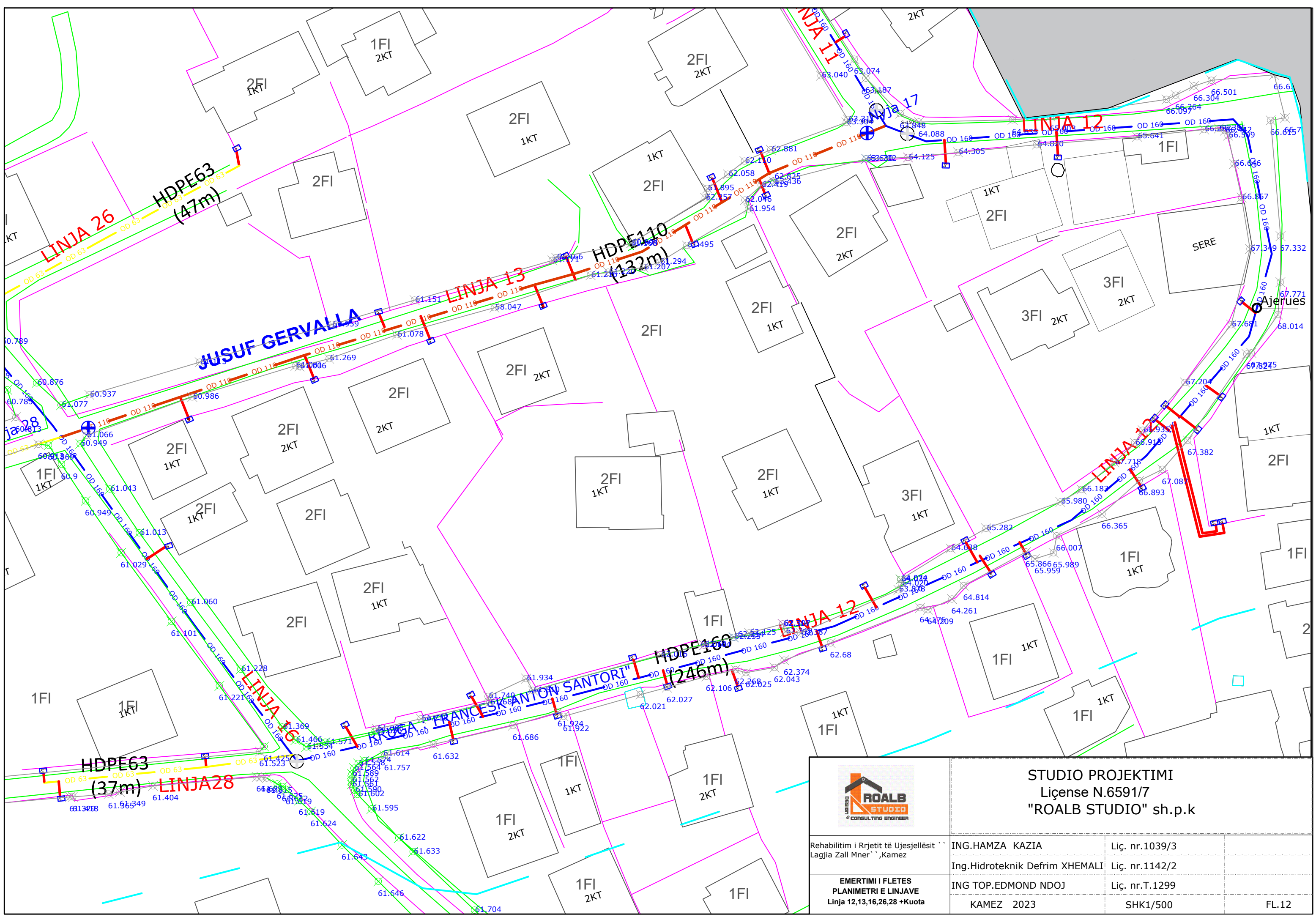

	STUDIO PROJEKTIMI Liçense N.6591/7 "ROALB STUDIO" sh.p.k		
	Rehabilitim i Rrjetit të Ujesjellësit Lagjia Zall Mner` ,Kamez	ING.HAMZA KAZIA Ing.Hidroteknik Defrim XHEMALI	Liç. nr.1039/3 Liç. nr.1142/2
EMERTIMI I FLETES PLANIMETRI E LINJAVE Linja 12,13,16,26,28 +Kuota	ING.TOP.EDMOND NDOJ KAMEZ 2023	Liç. nr.T.1299 SHK1/500	FL.12

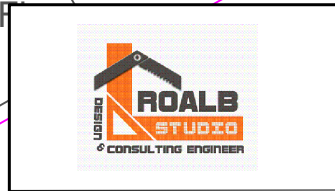
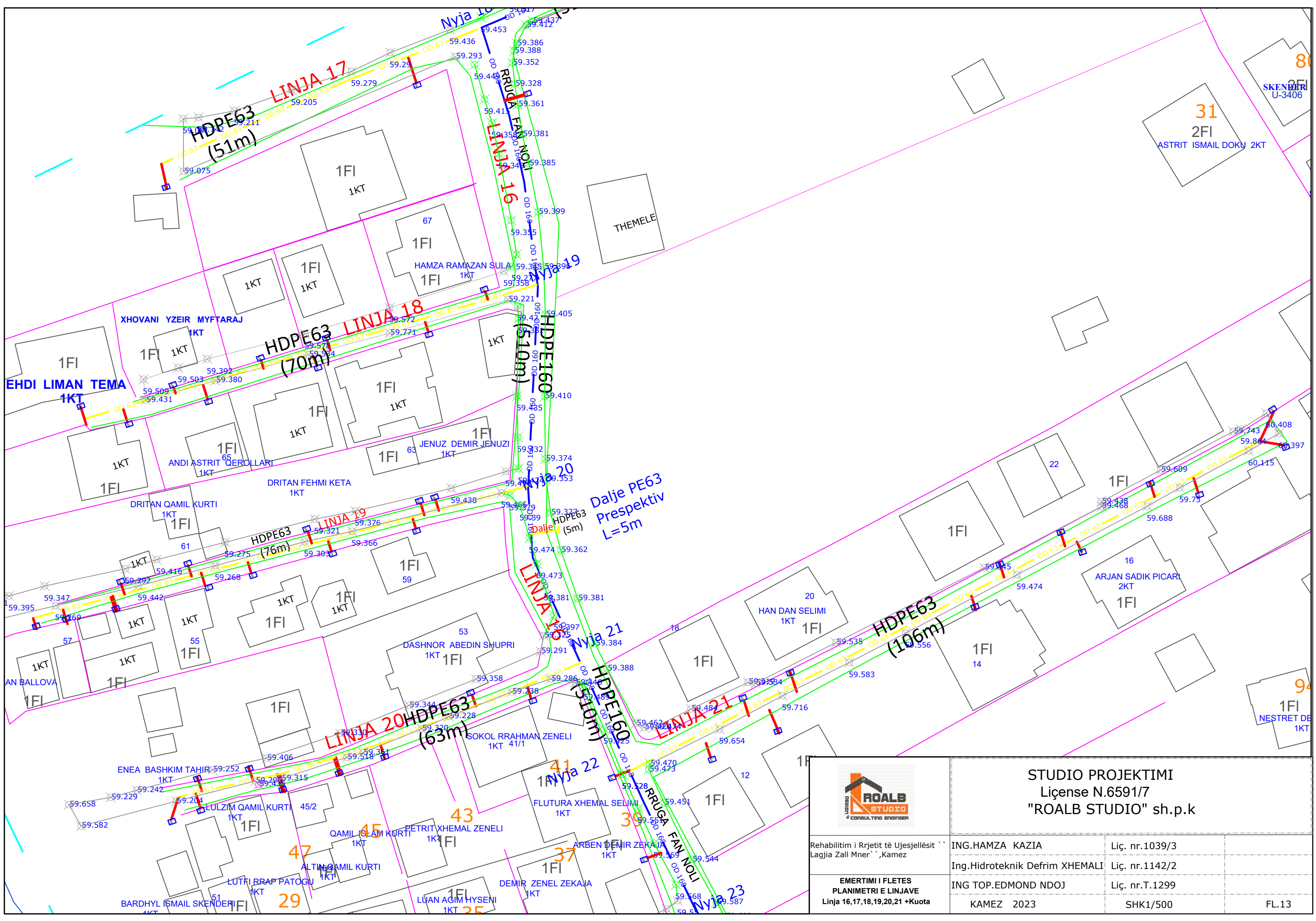

STUDIO PROJEKTIMI
 Liçense N.6591/7
 "ROALB STUDIO" sh.p.k

Rehabilitim i Rrjetit të Ujesjellësit të
 Lagjia Zall Mner, Kamez

**EMERTIMI I FLETES
 PLANIMETRI E LINJAVE
 Linja 16,17,18,19,20,21 +Kuota**

ING.HAMZA KAZIA	Liç. nr.1039/3
Ing.Hidroteknik Defrim XHEMALI	Liç. nr.1142/2
ING TOP.EDMOND NDOJ	Liç. nr.T.1299
KAMEZ 2023	SHK1/500
	FL.13

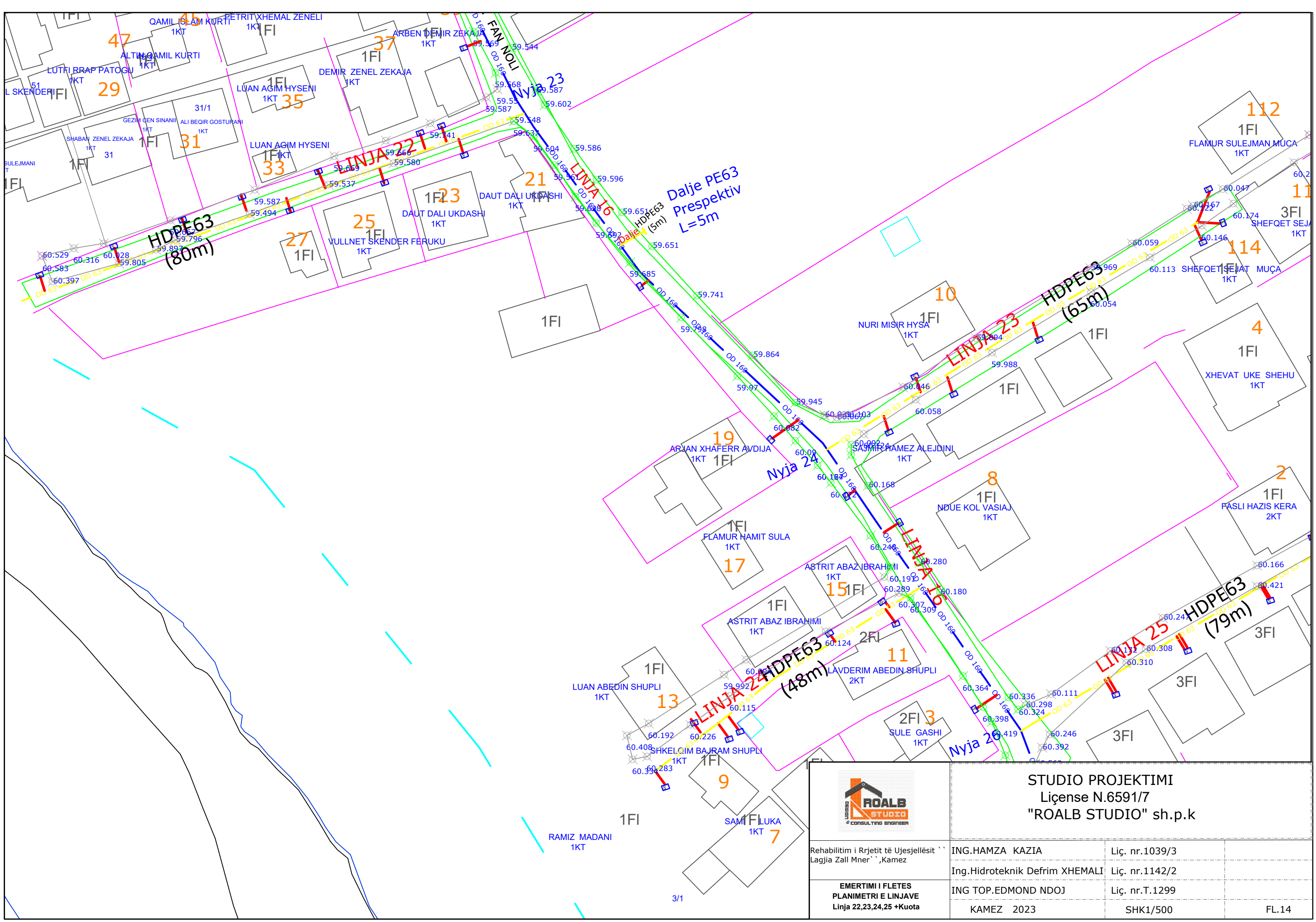

STUDIO PROJEKTIMI
 Liçense N.6591/7
 "ROALB STUDIO" sh.p.k

Rehabilitim i Rrjetit të Ujesjellësit të Lagjia Zall Mner, Kamez	ING.HAMZA KAZIA	Liç. nr.1039/3
	Ing.Hidroteknik Defrim XHEMALI	Liç. nr.1142/2
EMERTIMI I FLETES PLANIMETRI E LINJAVE Linja 22,23,24,25 +Kuota	ING TOP.EDMOND NDOJ	Liç. nr.T.1299
	KAMEZ 2023	SHK1/500
		FL.14

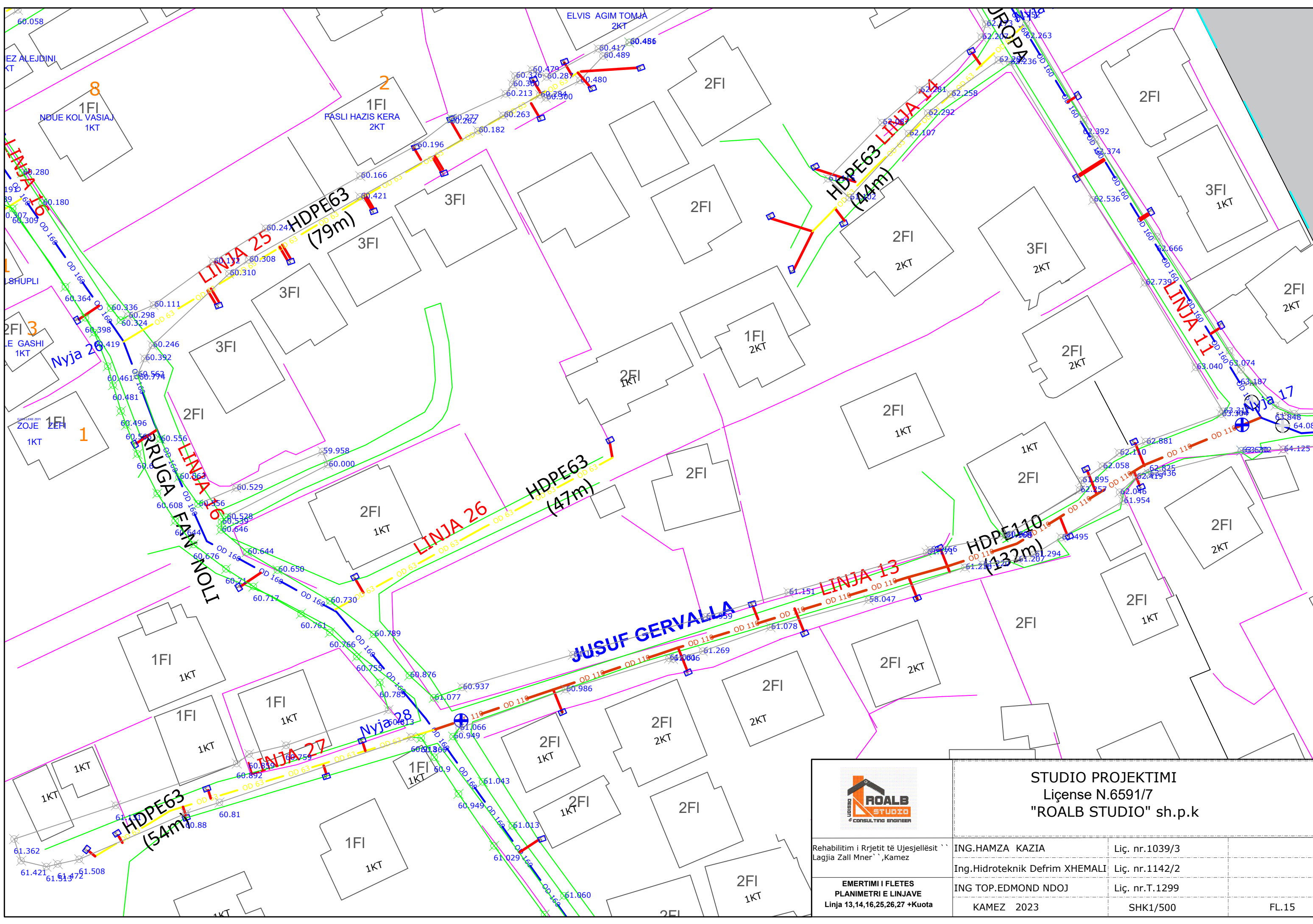

		STUDIO PROJEKTIMI Liçense N.6591/7 "ROALB STUDIO" sh.p.k	
Rehabilitim i Rrjetit të Ujesjellësit Lagjia Zall Mner'', Kamez		ING.HAMZA KAZIA Ing.Hidroteknik Defrim XHEMALI	Liç. nr.1039/3 Liç. nr.1142/2
EMERTIMI I FLETES PLANIMETRI E LINJAVE Linja 13,14,16,25,26,27 +Kuota		ING TOP.EDMOND NDOJ KAMEZ 2023	Liç. nr.T.1299 SHK1/500 FL.15

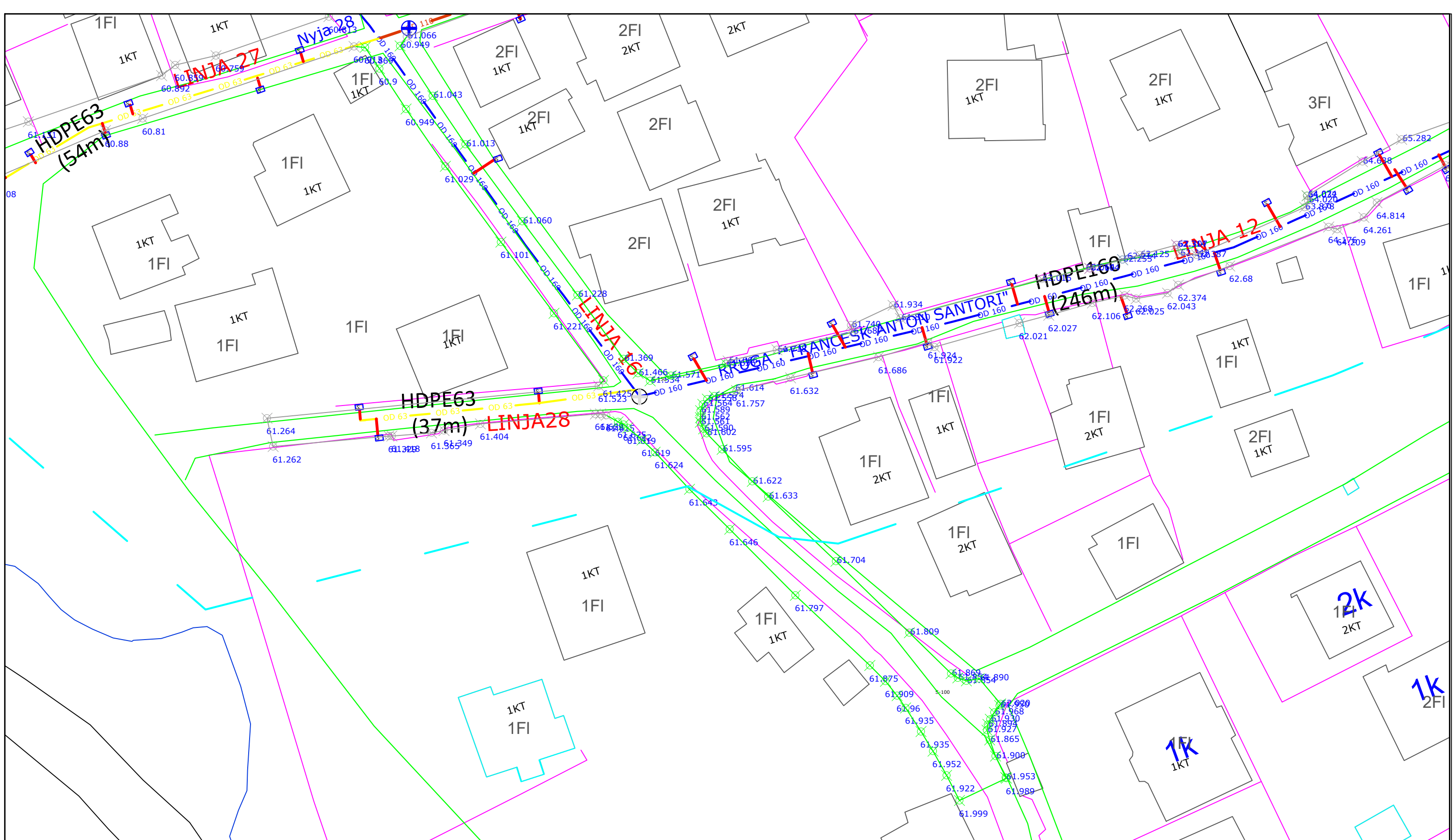

STUDIO PROJEKTIMI
 Liçense N.6591/7
 "ROALB STUDIO" sh.p.k

Rehabilitim i Rrjetit të Ujesjellësit të Lagjia Zall Mner, Kamez	ING.HAMZA KAZIA	Liç. nr.1039/3	
	Ing.Hidroteknik Defrim XHEMALI	Liç. nr.1142/2	
EMERTIMI I FLETES PLANIMETRI E LINJAVE Linja 12,27,28 +Kuota	ING TOP.EDMOND NDOJ	Liç. nr.T.1299	
	KAMEZ 2023	SHK1/500	FL.16

INSTALIMI TIP I NJE MATESI

LIDHJE BANESE OD 25 ME NJE 1 DALJE -20mm
Detaji i lidhjes me banesen, shiko anash

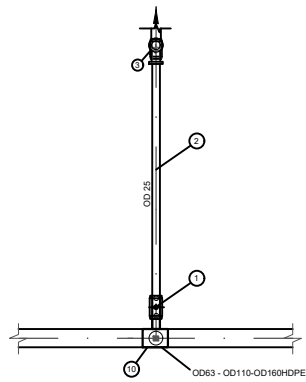

LIDHJE BANESE E VETME HDPE OD20 - TIPI A

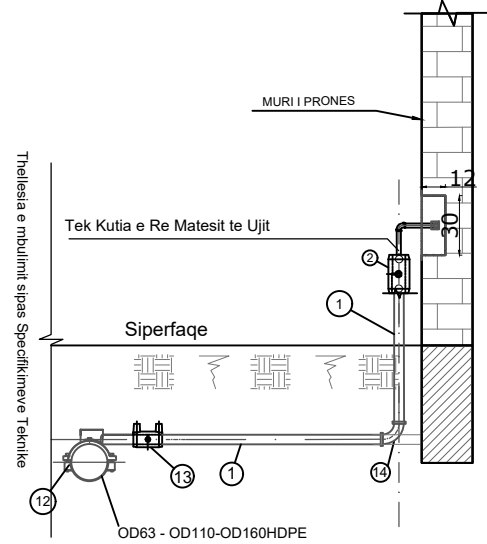

Prerja Terthore A-A

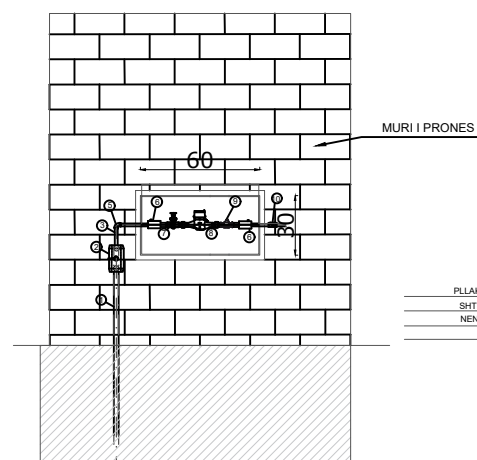

Prerja Terthore B - B

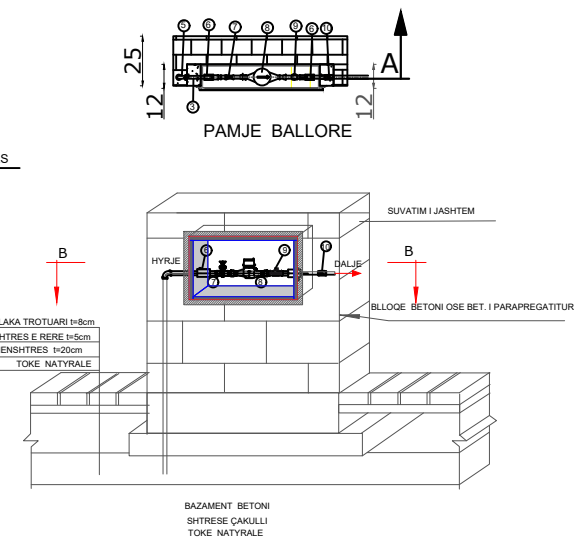

Nr	Pershkrimi	Njesia	Sasia
1	Tub HDPE OD25	ml	variabel
2	Reduktor elektro fuziv OD25 / OD 20	copë	1
3	Tub HDPE OD20	ml	variabel
5	Brryl elektro fuziv OD 20	copë	1
6	Adaptor EF mashkull i filetuar OD 20/ 1/2"	copë	2
7	Saracineske Bronxi Dn15, dopio femer filetuar + volant	copë	1
8	Mates Uji Dn 15, Q _s =2.5m ³ /h perfshire Hollandez mashkull/femer filetuar Dn15	copë	1
9	Kundralvalvul Bronxi DN25	copë	1
10	Aksesor tranzit qe varet tubi ekzistues OD20/ODxx	copë	1
11	Kuti metalik me mbyllje	copë	1
12	Qafore OD160-110-63/ me dalje elektrofuzeve OD25	copë	1
13	Bashkues elektro fuziv OD 25	copë	1
14	Brryl elektro fuziv OD 25	copë	1

INSTALIMI TIP PER DY MATESA

LIDHJE BANESE OD 32 ME NJE 2 DALJE -20mm
Detaji i lidhjes me banesen, shiko anash

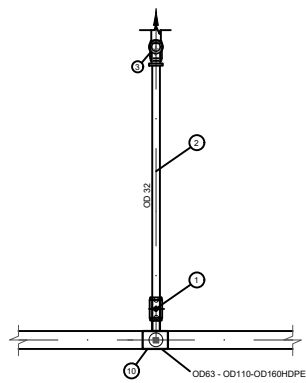

LIDHJE BANESE E VETME HDPE OD20 - TIPI A

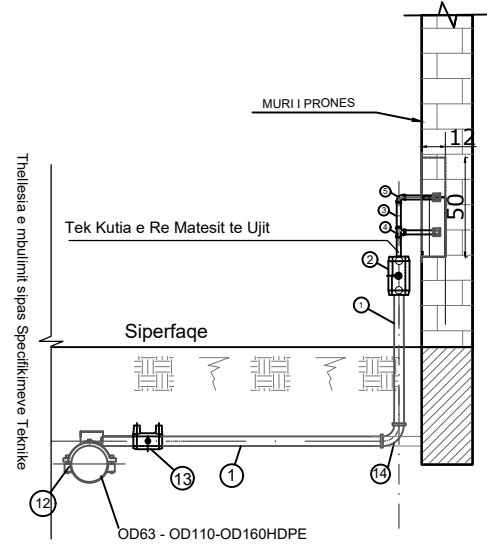

Prerja Terthore A-A

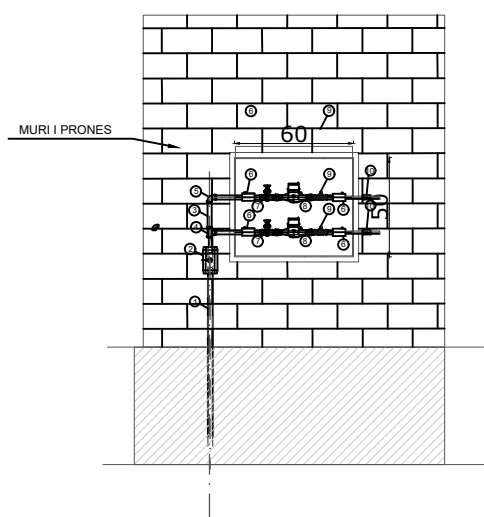

Prerja Terthore B - B

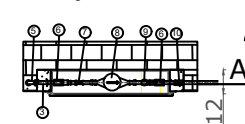

Nr	Pershkrimi	Njesia	Sasia
1	Tub HDPE OD32	ml	variabel
2	Reduktor elektro fuziv OD32 / OD 20	copë	1
3	Tub HDPE OD20	ml	variabel
4	Ti elektro fuziv OD 20	copë	1
5	Brryl elektro fuziv OD 20	copë	1
6	Adaptor EF mashkull i filetuar OD 20/ 1/2"	copë	4
7	Saracineske Bronxi Dn15, dopio femer filetuar + volant	copë	2
8	Mates Uji Dn 15, Q _s =2.5m ³ /h perfshire Hollandez mashkull/femer filetuar Dn15	copë	2
9	Kundralvalvul Bronxi DN25	copë	2
10	Aksesor tranzit qe varet tubi ekzistues OD20/ODxx	copë	2
11	Kuti metalik me mbyllje	copë	1
12	Qafore OD160-110-63 me dalje elektrofuzeve OD32	copë	1
13	Bashkues elektro fuziv OD 32	copë	1
14	Brryl elektro fuziv OD 32	copë	1



STUDIO PROJEKTIMI
Liçense N.6591/7
"ROALB STUDIO" sh.p.k

Rehabilitim i Rrjetit të Ujesjellësit
Lagjia Zall Mner, Kamez

**EMERTIMI I FLETES
DETAJE LIDHJE SHTEPIAKE**

ING.HAMZA KAZIA
Ing.Hidroteknik Defrim XHEMALI
ING TOP.EDMOND NDOJ
KAMEZ 2023

Liç. nr.1039/3
Liç. nr.1142/2
Liç. nr.T.1299
SHK1/500

FL.17

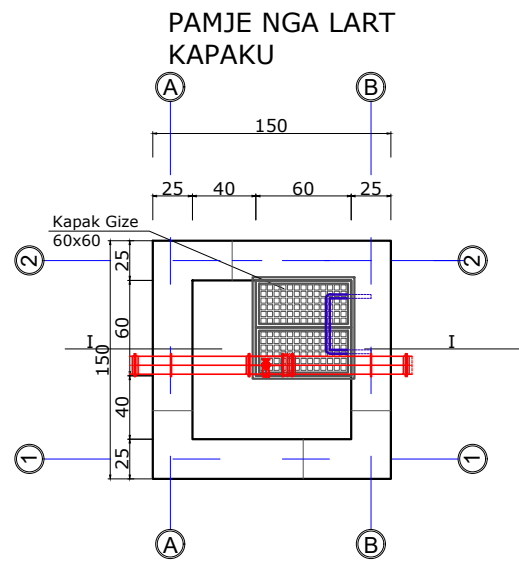

Armimi i Soletes se Pusetes



TABELA E SPECIFIKIMIT TE ARMATURES										
Lloji	Sasia	Poz	d	l(cm)	cope	l(m)	Pesha/nj	Pesha	TOTALI(kg)	
Armatura (e soletes se poshtme)	2	1	10	170	7	11.9	0.647	7.70	15.41	
	2	2	12	170	7	11.9	0.932	11.09	22.19	
	2	3	10	83	5	4.15	0.647	2.69	5.37	
	2	4	12	83	5	4.15	0.932	3.87	7.74	
	1	D1	8	83	5	4.15	0.414	1.72	1.72	
SHUMA per soleta shufrat poshte									52	
Armatura (e soletes se sipërme)	2	1	10	170	7	11.9	0.647	7.70	15.41	
	2	2	12	170	7	11.9	0.932	11.09	22.19	
	2	3	10	83	5	4.15	0.647	2.69	5.37	
	2	4	12	83	5	4.15	0.932	3.87	7.74	
	1	D1	8	83	5	4.15	0.414	1.72	1.72	
SHUMA per soleta shufrat sipër									52	
SHUMA HEKUR SOLETA E PUSETES									105	
Emertimi	sasia	sip. TerthH	V. betonit	RAPORTI HEKUR/ BETON SOLETA						308
BETON	1	1.700	0.20	0.3						



TABELA E SPECIFIKIMIT TE ARMATURES										
Lloji	Sasia	Poz	d	l(cm)	cope	l(m)	Pesha/nj	Pesha	TOTALI(kg)	
Muri 1 & 2	2	1	12	160	11	17.6	0.932	16.41	32.81	
	2	1a	10	160	11	17.6	0.647	11.39	22.79	
	2	2	12	100	11	11	0.932	10.25	20.51	
	2	2a	10	90	11	9.9	0.647	6.41	12.82	
	2	3	12	160	11	17.6	0.932	16.41	32.81	
	2	3a	10	160	11	17.6	0.647	11.39	22.79	
2	4	8	80	18	14.4	0.414	5.97	11.93		
2	s	8	39	20	7.8	0.414	3.23	6.46		
SHUMA per 1 & 2									163	
Muri A & B	2	1	12	160	11	17.6	0.932	16.41	32.81	
	2	1a	10	160	11	17.6	0.647	11.39	22.79	
	2	2	12	100	11	11	0.932	10.25	20.51	
	2	2a	10	90	11	9.9	0.647	6.41	12.82	
	2	3	12	160	11	17.6	0.932	16.41	32.81	
	2	3a	10	160	11	17.6	0.647	11.39	22.79	
2	4	8	80	18	14.4	0.414	5.97	11.93		
2	s	8	39	20	7.8	0.414	3.23	6.46		
SHUMA per A & B									163	
SHUMA HEKUR 1 & 2+A & B									326	
Emertimi	sasia	sip. TerthH	V. betonit	RAPORTI HEKUR/ BETON Muri 1 & 2+A & B						174
BETON	1	1.250	1.50	1.9						

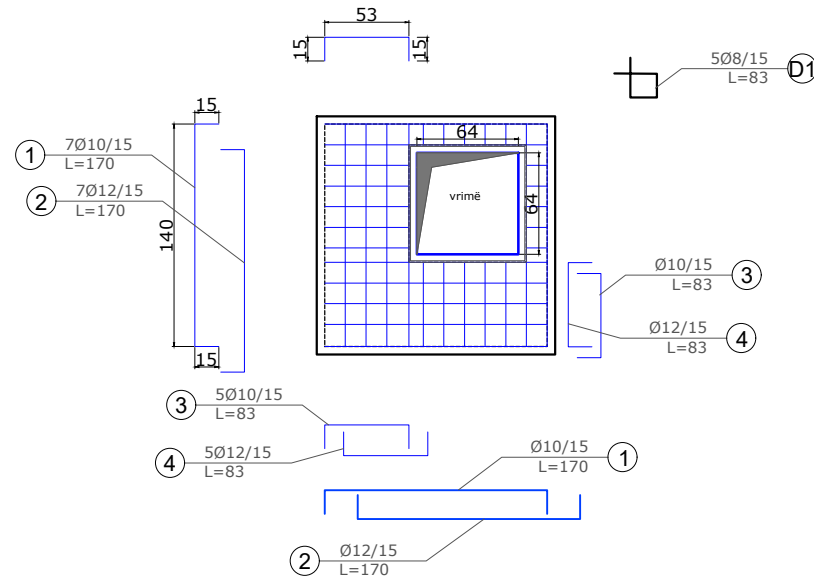

Armimi i Pusetes

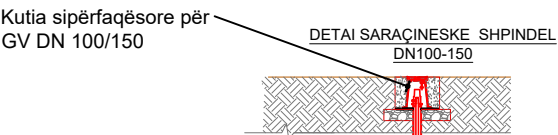
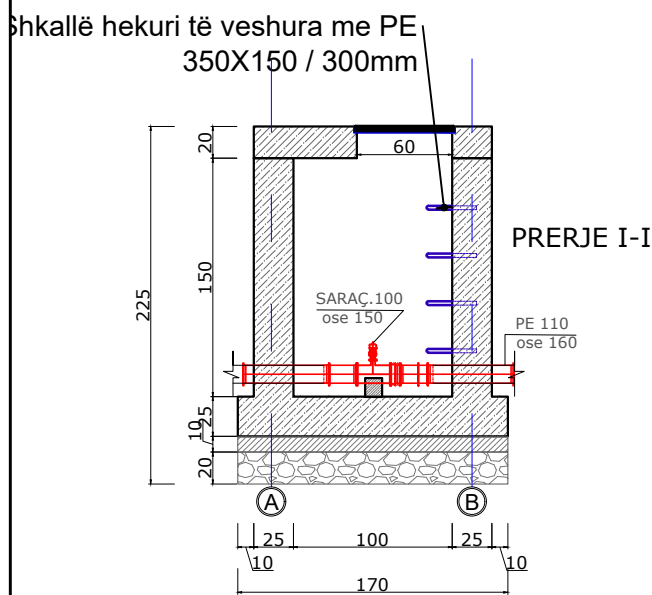
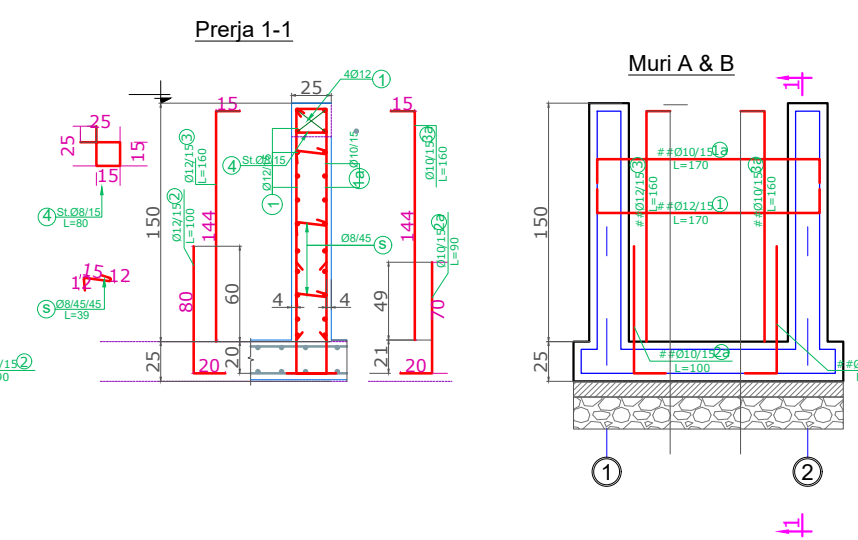
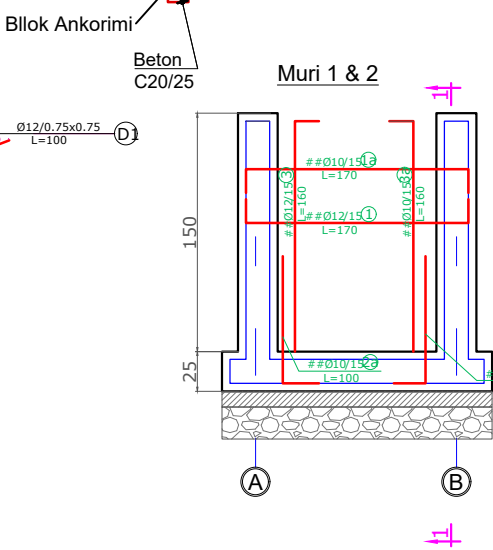
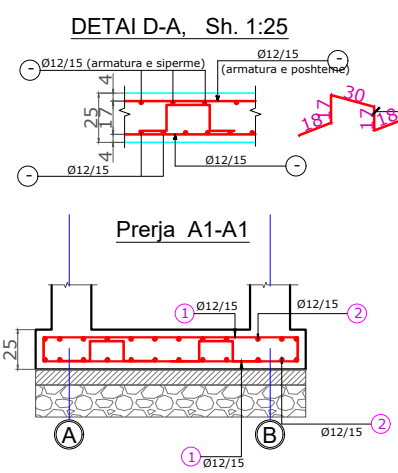
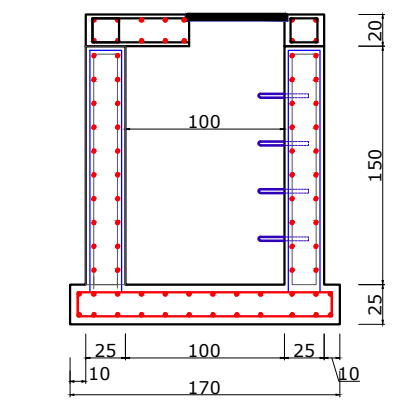

Pllaka e themelit



TABELA E SPECIFIKIMIT TE ARMATURES										
Lloji	Sasia	Poz	d	l(cm)	cope	l(m)	Pesha/nj	Pesha	TOTALI(kg)	
Pllaka e themelit /zg. e poshtme)	1	1	12	190	11	20.9	0.932	19.48	19.48	
	1	2	12	190	11	20.9	0.932	19.48	19.48	
	1	D1	12	100	6	6	0.932	5.59	5.59	
SHUMA per Pllaka e Themelit zgara e poshtme									45	
Pllaka e themelit /zg. e sipërme)	1	1	12	190	11	20.9	0.932	19.48	19.48	
	1	2	12	190	11	20.9	0.932	19.48	19.48	
SHUMA per Pllaka e Themelit zgara e sipërme									39	
SHUMA HEKUR Pllaka e Themelit zgara e poshtme+sipërme									84	
Emertimi	sasia	sip. TerthH	V. betonit	RAPORTI HEKUR/ BETON Pllaka e Themelit						116
BETON	1	2.890	0.25	0.72						



Rehabilitim i Rrjetit të Ujesjellësit
Lagjia Zall Mner, Kamez

**EMERTIMI I FLETES
DETAJE E HOLLESI PUSETA**

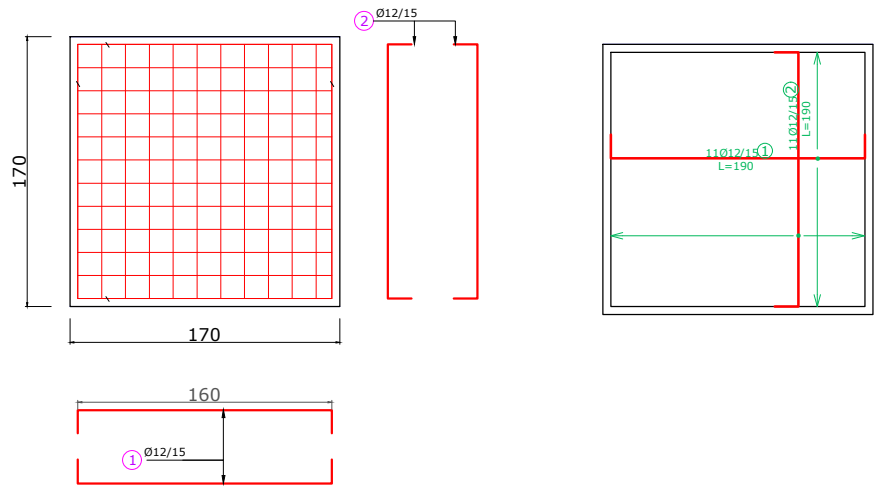
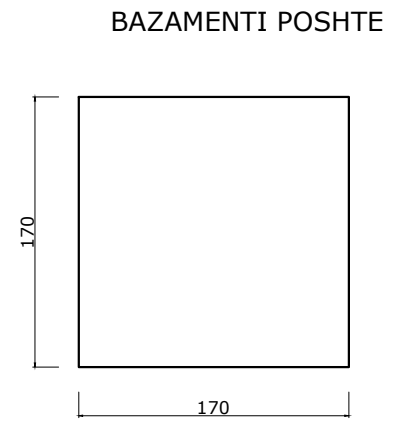
STUDIO PROJEKTIMI
Licëse N.6591/7
"ROALB STUDIO" sh.p.k

ING.HAMZA KAZIA	Liç. nr.1039/3	
Ing.Hidroteknik Defrim XHEMALI	Liç. nr.1142/2	
ING TOP.EDMOND NDOJ	Liç. nr.T.1299	
KAMEZ 2023	SHK1/500	FL.18

PROFIL TERTHOR GERMIMI PER RRUGE ME ASFALT

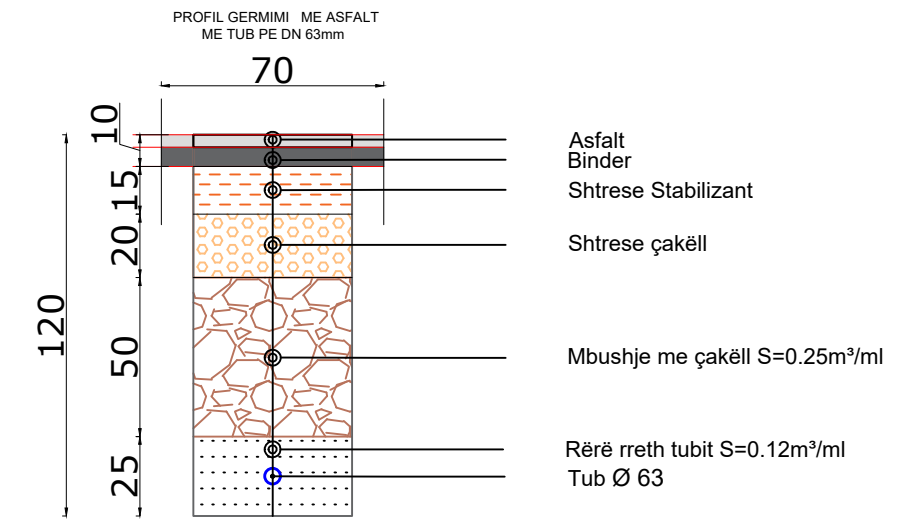
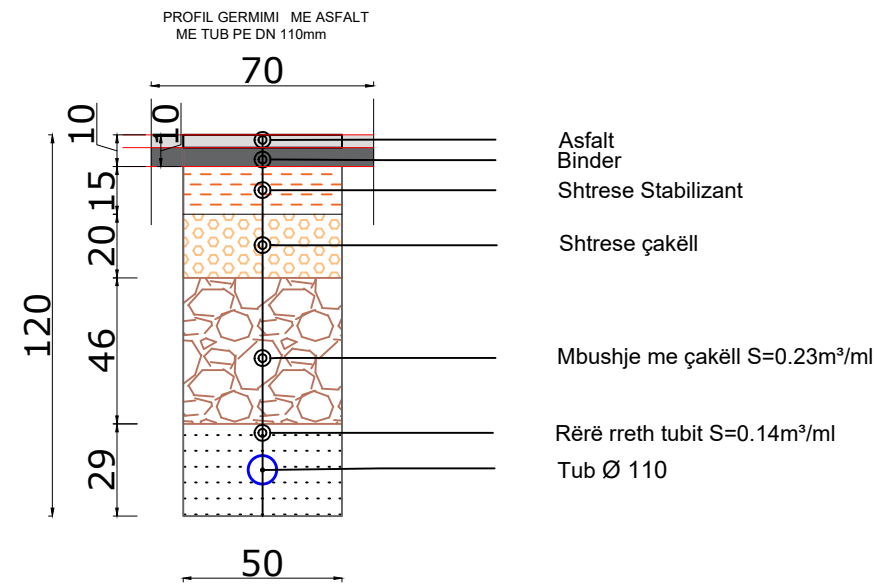
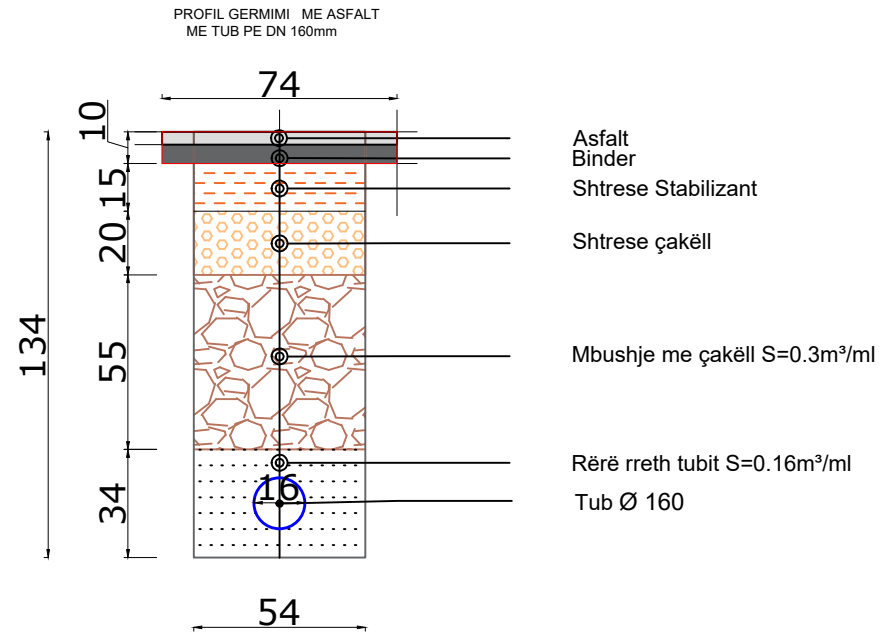

PROFIL TERTHOR GERMIMI PER RRUGE ME ÇAKULL

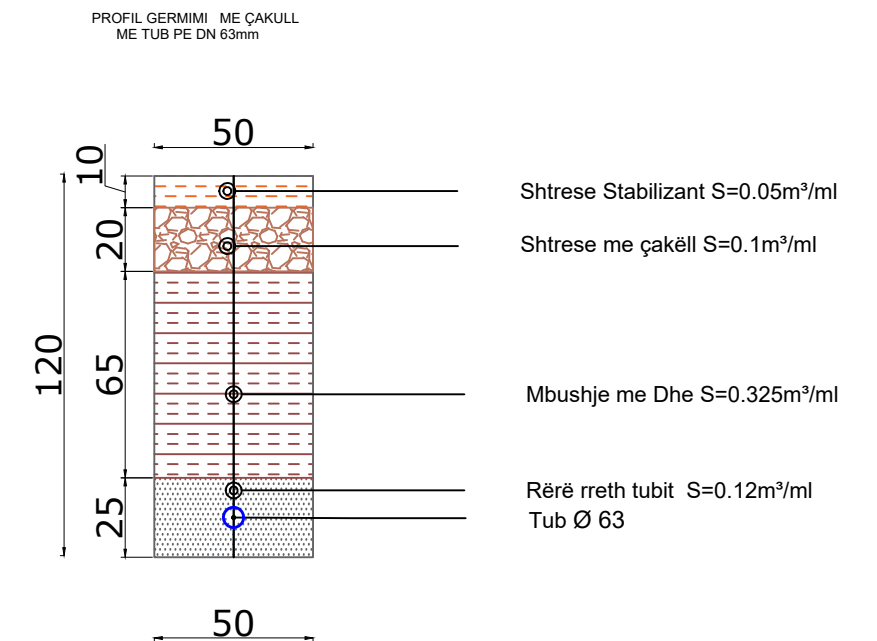
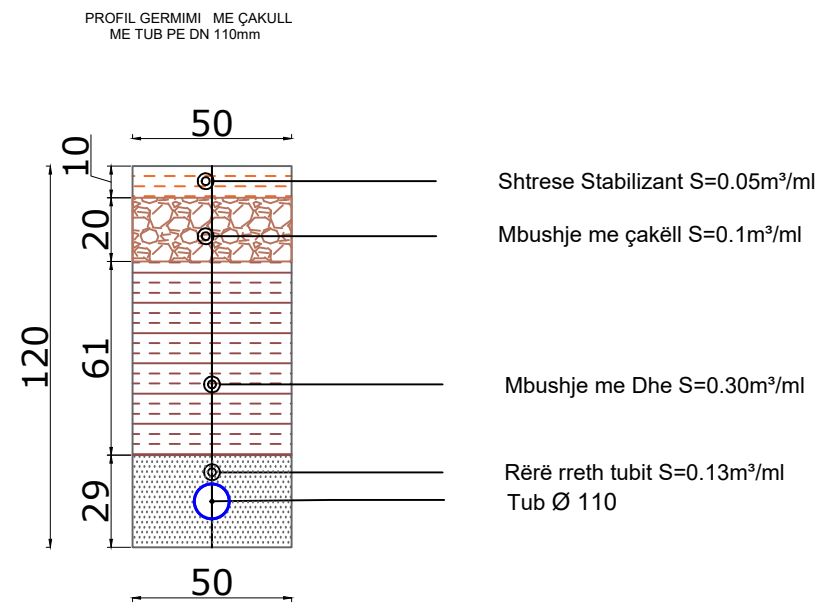
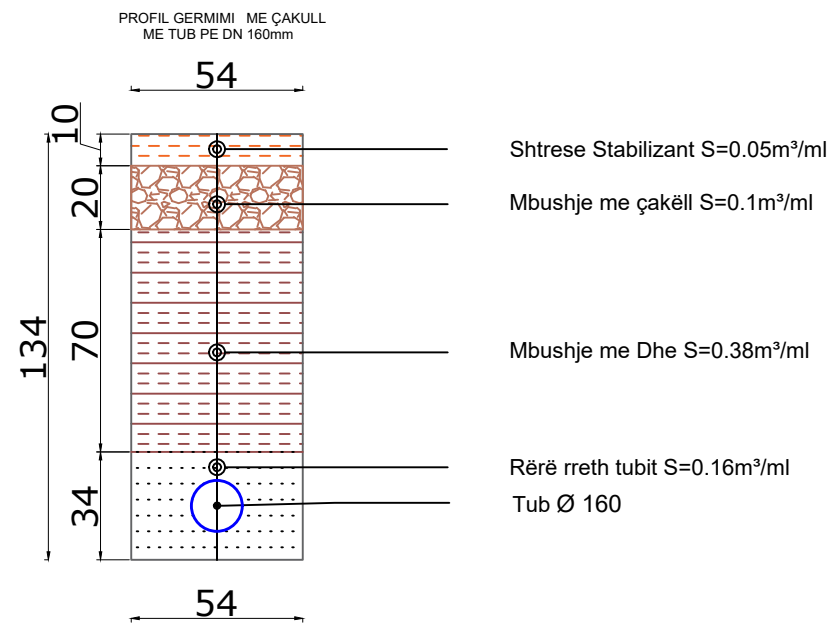

STUDIO PROJEKTIMI
Liçense N.6591/7
"ROALB STUDIO" sh.p.k

Rehabilitim i Rrjetit të Ujesjellësit Lagjia Zall Mner, Kamez	ING.HAMZA KAZIA	Liç. nr.1039/3	
	Ing.Hidroteknik Defrim XHEMALI	Liç. nr.1142/2	
EMERTIMI I FLETES PROFIL TERTHORE GERMIMI	ING TOP.EDMOND NDOJ	Liç. nr.T.1299	
	KAMEZ 2023	SHK1/25	FL.19

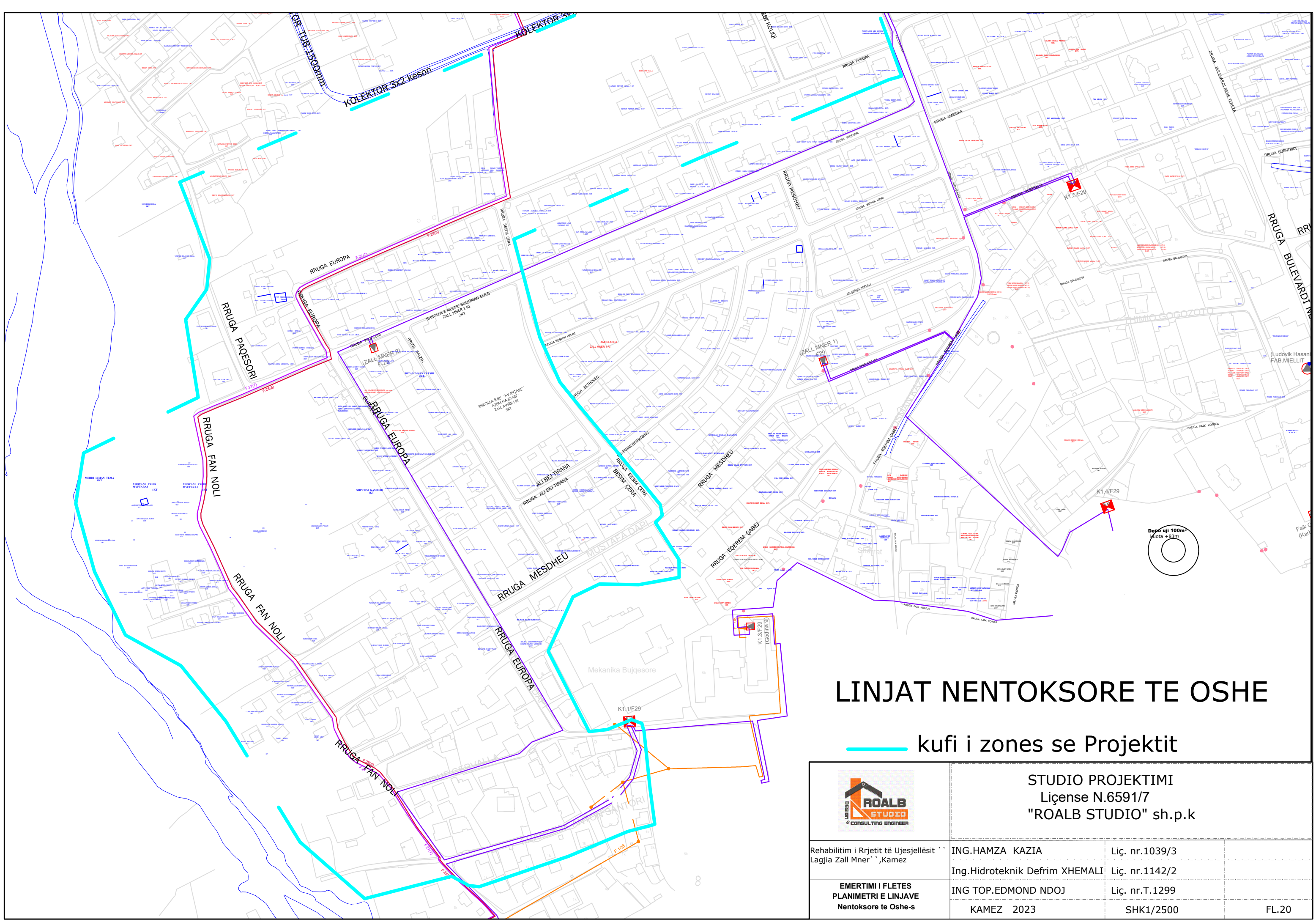

LINJAT NENTOKSORE TE OSHE

— kufi i zones se Projektit

	STUDIO PROJEKTIMI Liçense N.6591/7 "ROALB STUDIO" sh.p.k		
	Reabilitim i Rrjetit të Ujesjellësit Lagjia Zall Mner` ,Kamez	ING.HAMZA KAZIA Ing.Hidroteknik Defrim XHEMALI	Liç. nr.1039/3 Liç. nr.1142/2
EMERTIMI I FLETES PLANIMETRI E LINJAVE Nentoksore te Oshe-s	ING TOP.EDMOND NDOJ KAMEZ 2023	Liç. nr.T.1299 SHK1/2500	FL.20

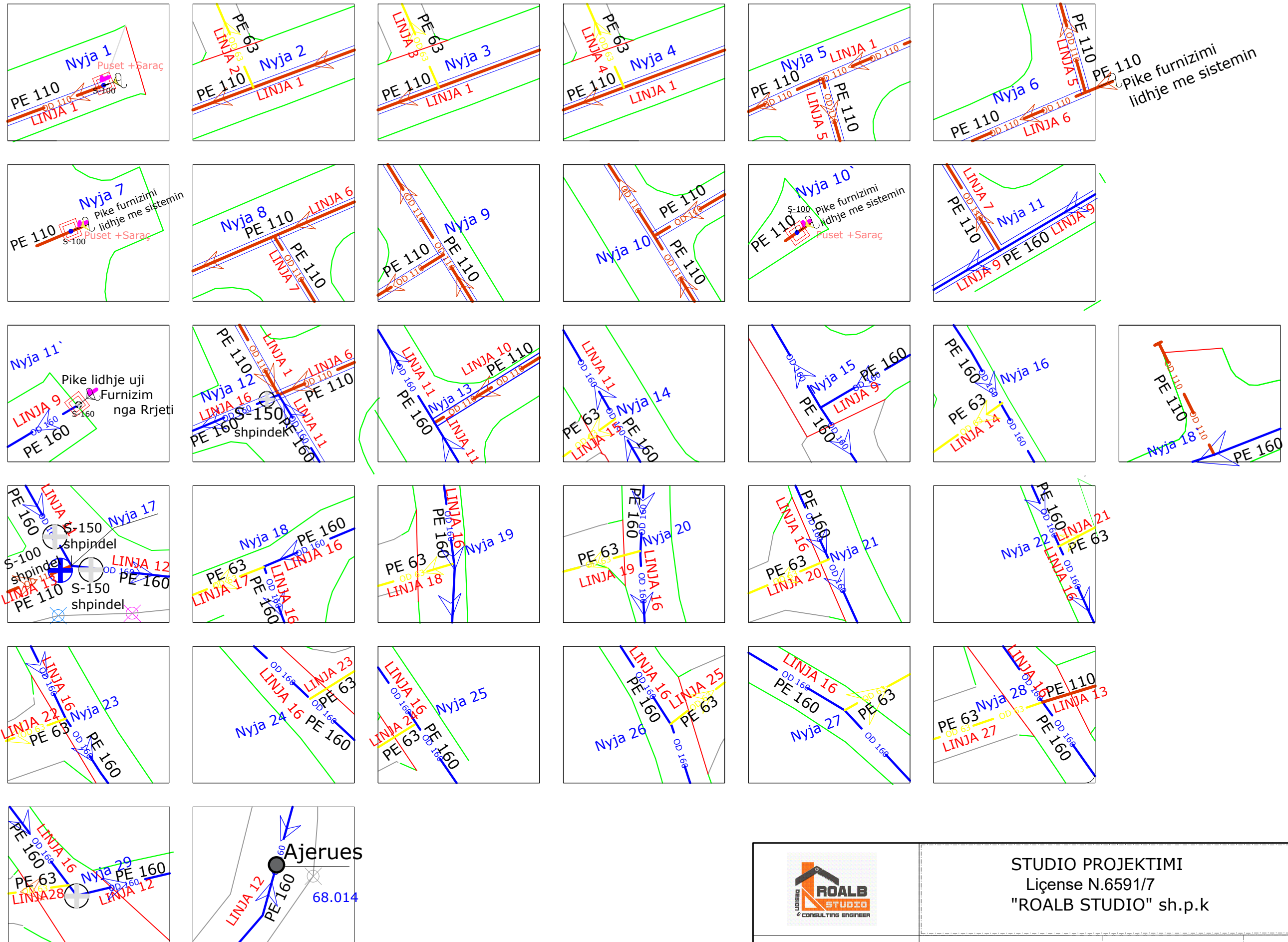

PE 110 pike furnizimi lidhje me sistemin

Nyja 7 Pike furnizimi lidhje me sistemin Puset + Saraç

Nyja 11' Pike lidhje uji Furnizim nga Rrjeti

S-100 shpindel S-150 shpindel PE 110 shpindel

Ajerues 68.014



STUDIO PROJEKTIMI
 Liçense N.6591/7
 "ROALB STUDIO" sh.p.k

Rehabilitim i Rrjetit të Ujesjellësit të Lagjia Zall Mner, Kamez	ING.HAMZA KAZIA	Liç. nr.1039/3	
	Ing.Hidroteknik Defrim XHEMALI	Liç. nr.1142/2	
EMERTIMI I FLETES Nyjet 1-29 +Ajruesi	ING TOP.EDMOND NDOJ	Liç. nr.T.1299	
	KAMEZ 2023	SHK1/___	FL.21