



REPUBLIKA E SHQIPËRISE
BASHKIA POLIÇAN

Blerje materialesh per rikonstruksionin e shesheve, rrugeve dhe godinave publike te Bashkise Polican

MIRATOHET
KRYETARI I BASHKIA POLIÇAN
Adriatik ZOTKAJ



Emertimi i Projektit:		Projektoi:	
Blerje materialesh per rikonstruksionin e shesheve, rrugeve dhe godinave publike te Bashkise Polican		Ing. Ferdinand AVDIUJ 	
Faza	Projekt Ide	Kapitulli:	Projekti Arkitekturik
		Nr. Fletes:	A - 00
		Data:	Janar 2024

Plani i Vendosjes se Objekteve Sh. 1:500

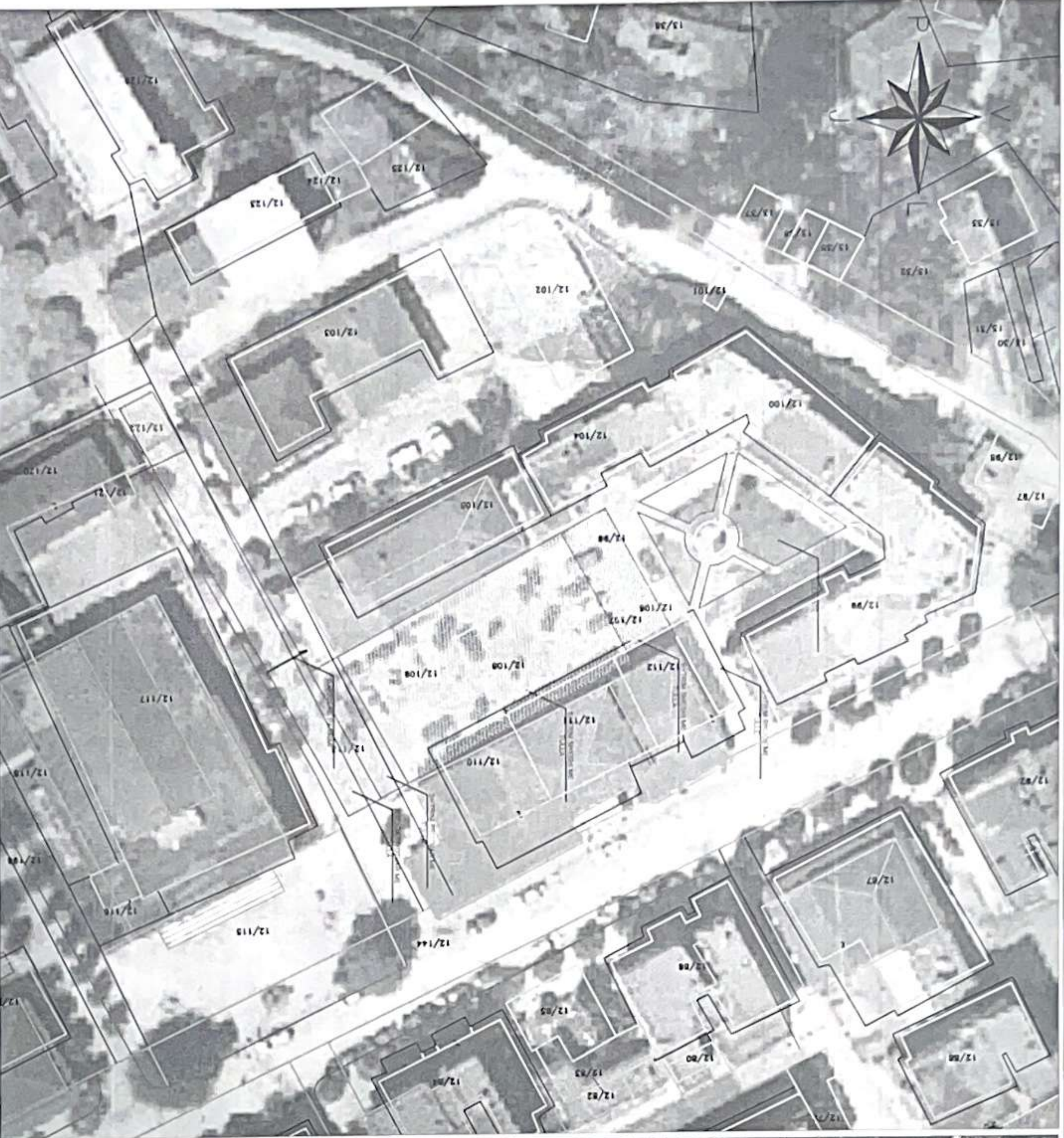

Plani i Vendosjes ne raport me Qytetin Sh. 1:2500

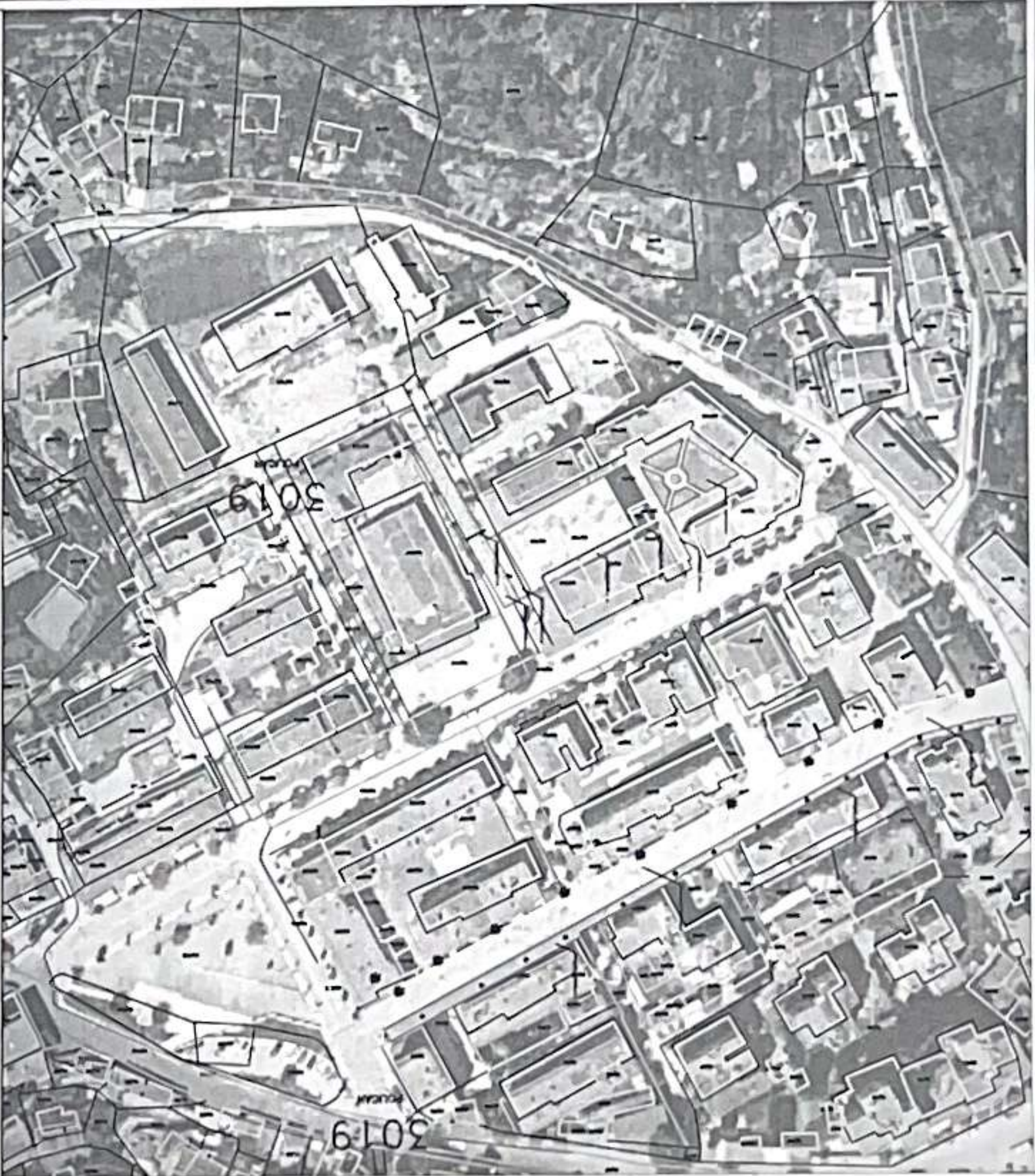

Rikonstruksion i sheshit te parkimit Bashkia Polican

 BASHKIA POLICAN		REPUBLICA E SHQIPERISE	
REPUBLICAN SHQIPTAR BASHKIA POLICAN		REPUBLICAN SHQIPTAR BASHKIA POLICAN	
Emertimi i Projektit: Rikonstruksion i sheshit te parkimit Bashkia Polican		Emertimi i Fletes: Planvendosje e Objekteve	
Projekti Ide		Shkallia:	
Projektoi: Ing. Ferdinand AVDIUJ		Kapitulli: Nr. Fletes A - 01	
Data: Janar 2024		Procesesi: A - 01	

Blerje materialesh per rikonstruksimin e sheshve, rrugëve dhe godinave publike te Bashkise Polican



- PARKIMI BASHKI:**
- SIP. TROTUARE ME GURE TE PERMASAVE 76 M2
 - SIP. SHESHI ME GURE TE PERMASAVE 1100 M2
 - SIP. RRUGES ME GURE TE PERMASAVE 295 M2

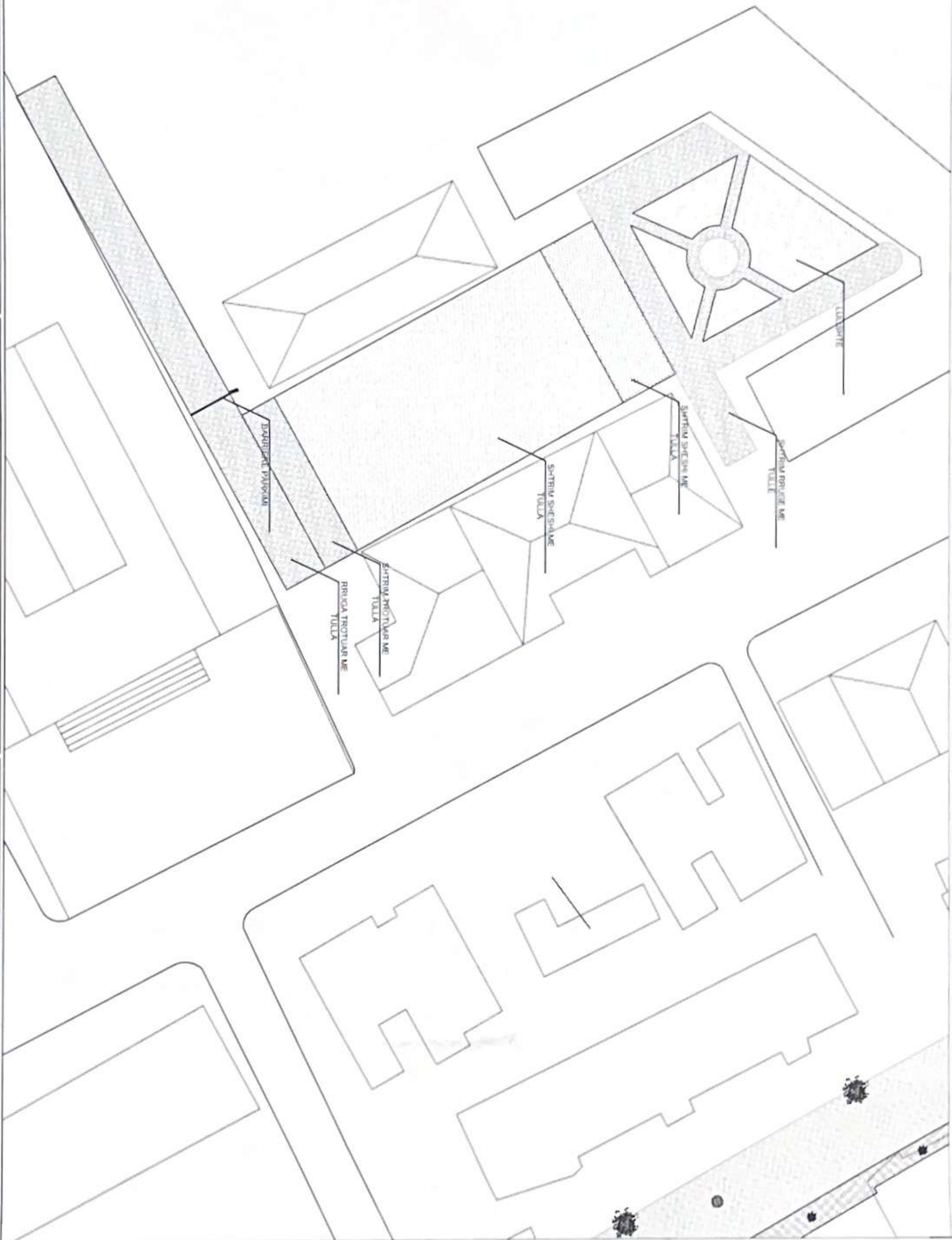

		Emertimi i Projektit: Blerje materialesh per rikonstruksimin e sheshve, rrugëve dhe godinave publike te Bashkise Polican		Emertimi i Fletes: Rikonstruksimi i sheshit te parkimit Bashkia Polican		Projektoi: Ing. Ferdinand AVDIUJ	
REPUBLIKA E SHQIPËRIE BASHKIA E POLICAN		Faza: Projekt Ide		Shkalla: 1 : 125		Kapitulli: Nr. Fletes: Projekti Arkitekturik A - 02	
Data: Janar 2024		(Signature)					

Plani i Vendosjes se Objekteve Sh. 1:1000

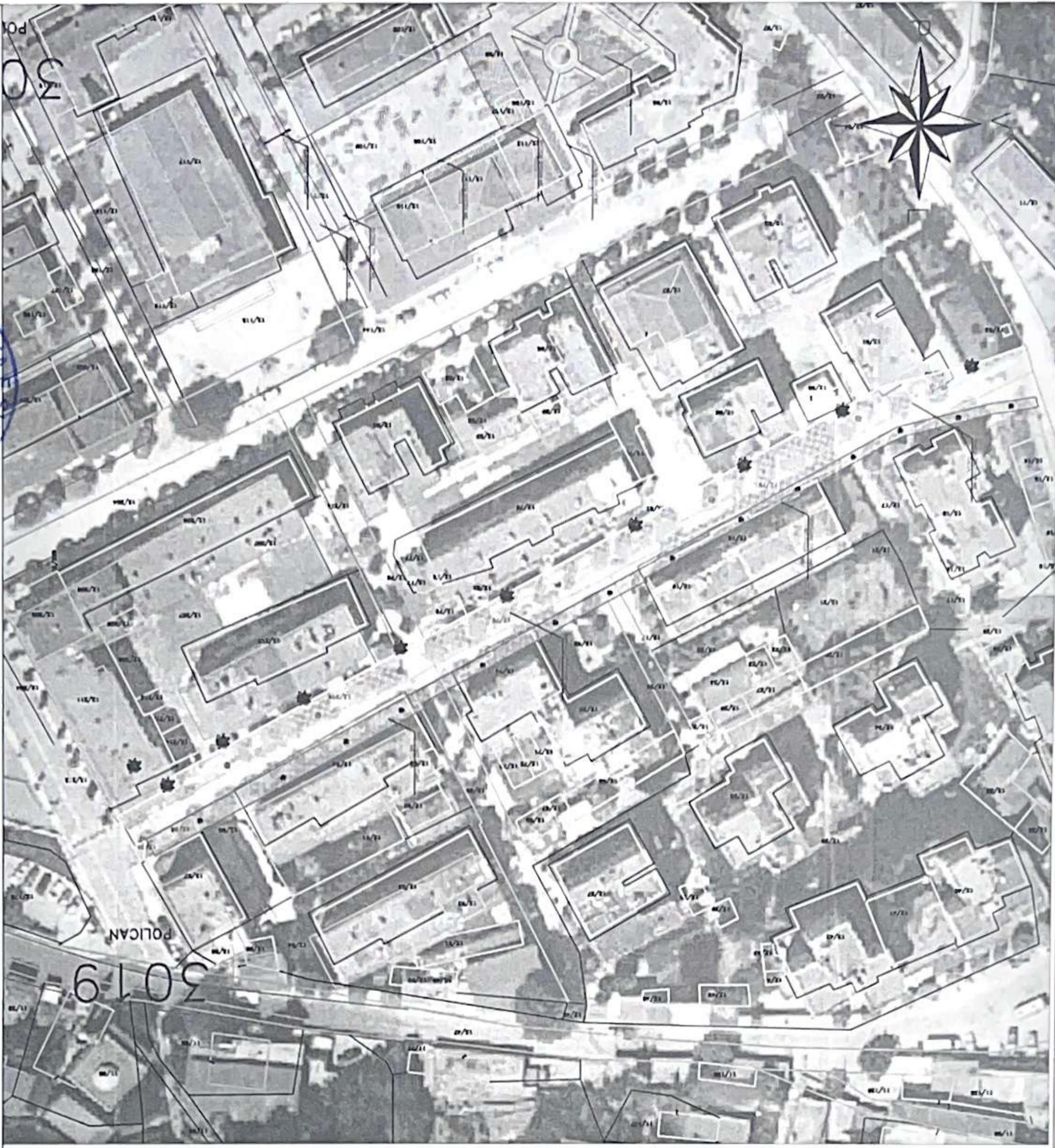

Plani i Vendosjes ne raport me Qytetin Sh. 1:2500



Rikonstrukcion "Rruga e Mesit" Bashkia Polican



REPUBLIKA E SHQIPRISE
BASHKIA POLICAN

Emertimi i Projektit:
Rikonstrukcion i rruges se mesit Bashkia Polican

Emertimi i Fletes:
Planvendosje e Objekteve

Projektoi:
Ing Ferdinand AVDIJA

Kapitulli:	Promesia
Nr. Fletes:	A - 03
Data:	Janar 2024



Blerje materialesh per rikonstruksimin e shesheve, rrugëve dhe godinave publike te Bashkise Polican

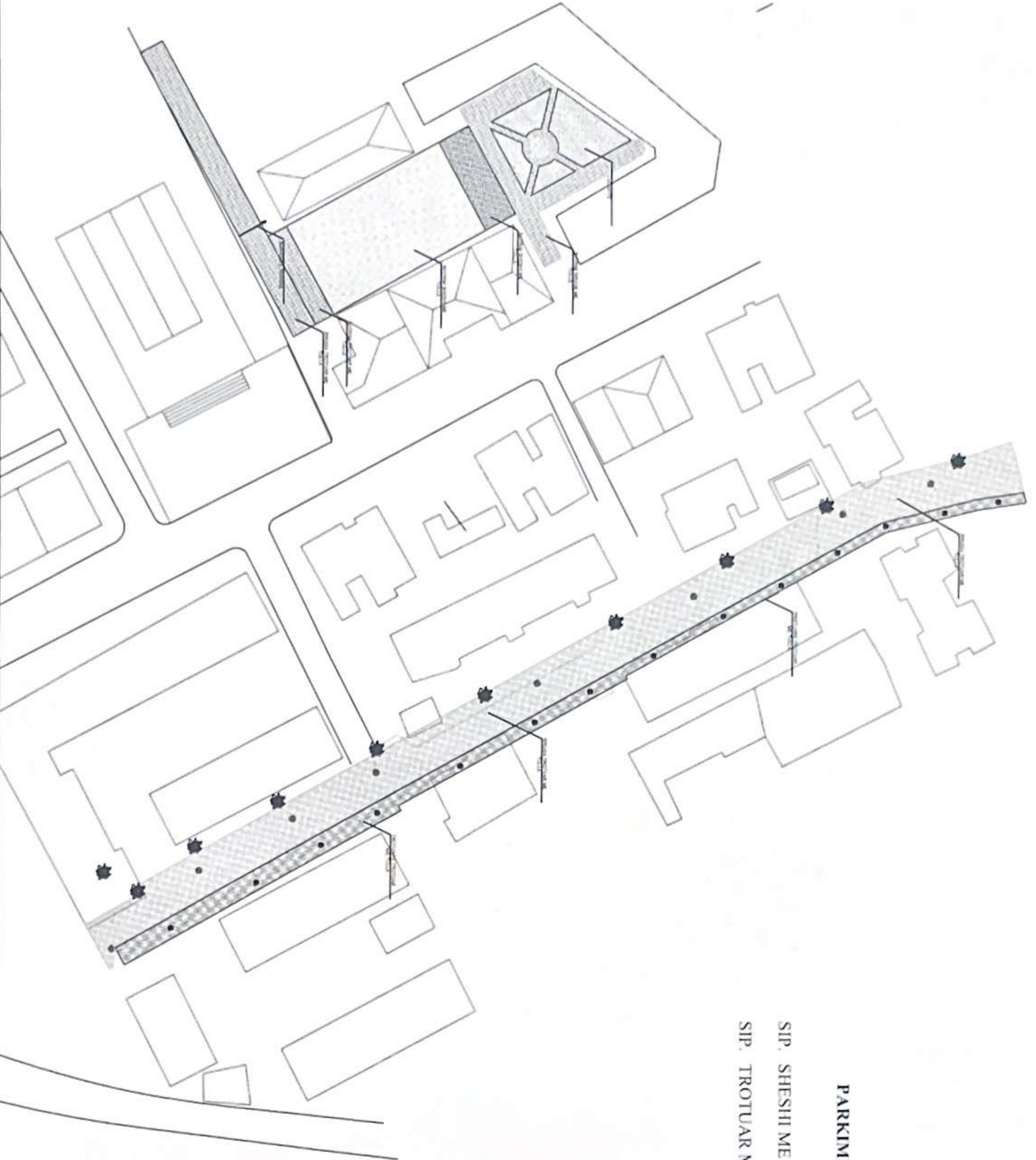

PARKIMI BASHKI:

SIP. SHESHI ME GURE TE PERMASAVE 1630 M2

SIP. TROTUAR ME GURE TE PERMASAVE 520 M2

		Emertimi i Projektit: Blerje materialesh per rikonstruksimin e shesheve, rrugëve dhe godinave publike te Bashkise Polican		Emertimi i Fletes: Rikonstruksim i rruges se mesit Bashkia Polican		Projektoji: Ing Ferdinand AVDIJ		Kapitulli: Nr. Fletes: Projekti Arkitektura A - 04	
REPUBLIKA E SHQIPËRISË BASHKIA E POLICAN		Nr. Shkalla: 1 : 125		Data: Janar 2024		(Signature)			



Plani i Vendosjes se Objekteve Sh. 1:1000

Plani i Vendosjes ne raport me Qytetin Sh. 1:2500

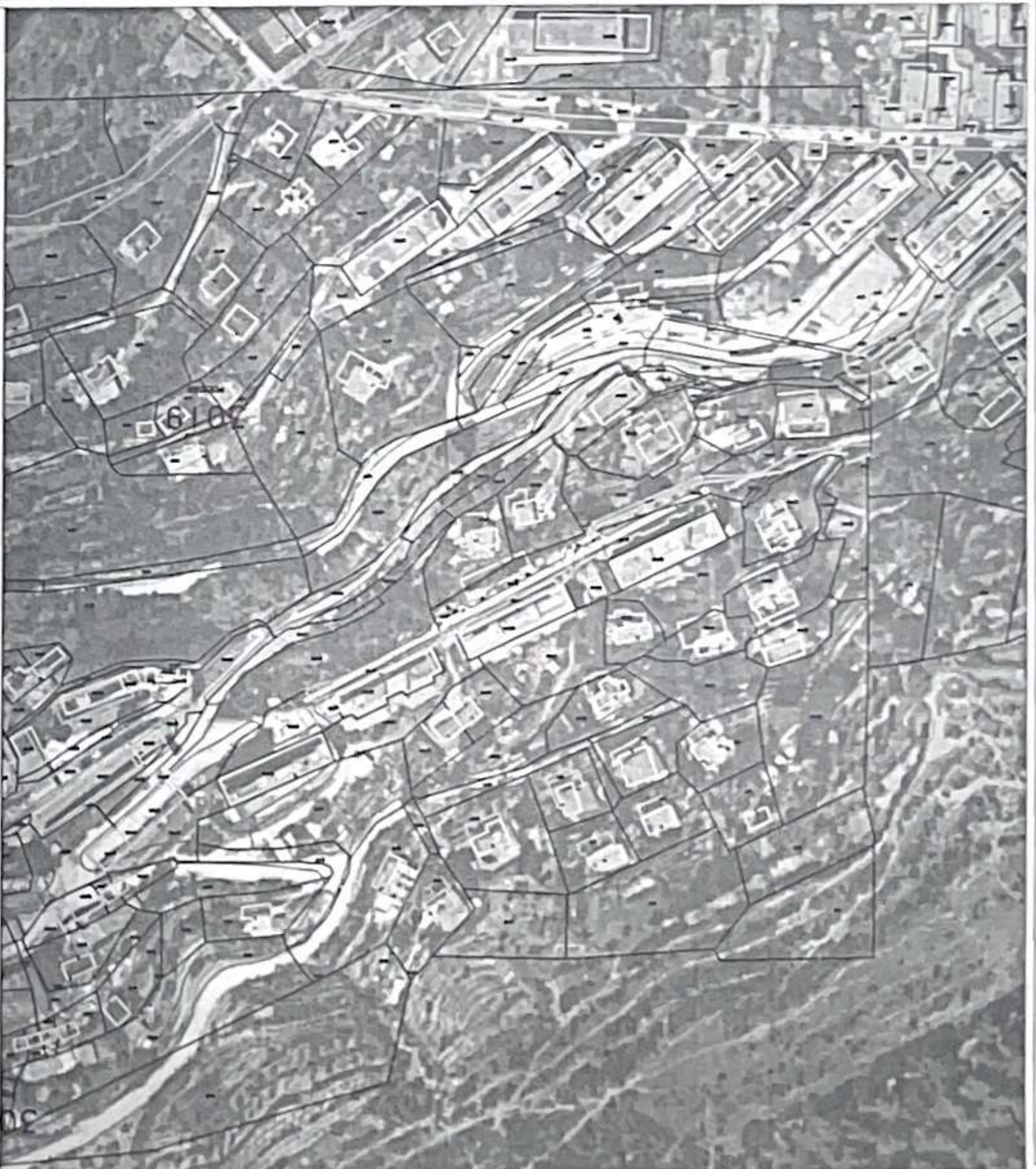

Rikonstruksion lagjia "Poligon" Bashkia Polican



BASHKIA

REPUBLIKA E SHQIPERISE
BASHKIA POLICAN

Emertimi i Projektit:

Rikonstruksion lagjia "Poligon" Bashkia Polican

Emertimi i Fletes:

Planvendosje e Objekteve

Projektoi:

Ing Ferdinand AVDIU

Kapitulli:

Promesia

Nr. Fletes:

A - 05

Data:

Janar 2024

Foto:

Projekti Ide

Shkalla:



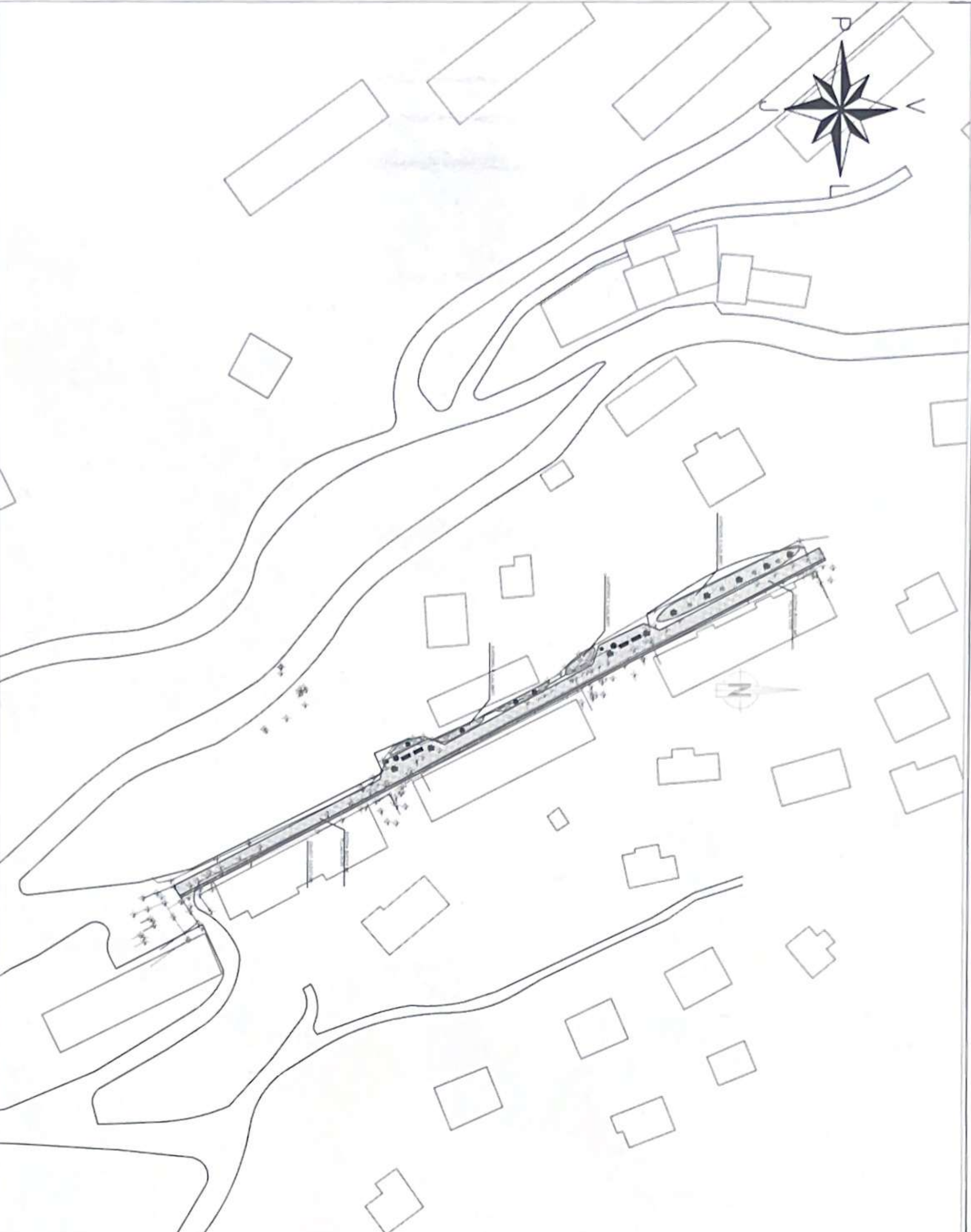

Blerje materialesh per rikonstruksionin e shesheve, rrugeve dhe godinave publike te Bashkise Polican



PARKIMI BASHKI:

SIP. TROTUARE ME GURE TE PERMASAVE 20 X 80 M2

SIP. SHESHI ME GURE TE PERMASAVE 20 X 470 M2

			
Emertimi i Projektit: Blerje materialesh per rikonstruksionin e shesheve, rrugeve dhe godinave publike te Bashkise Polican		Emertimi i Fletes: Rikonstruksion lagjia "Poligon" Bashkia Polican	
Faza Projekti Ide		Shkalla: 1 : 125	
Projektoti: Ing. Ferdinand AVDIUJ		Projektu Arkitektonik	
Kapitulli:		Nr. Fletes: A - 06	
Data:		Janar 2024	



**Rikonstruksion i ambienteve të
qëndrës për moshën e tretë Bashkia
Polican**

Emertimi i Projektit:

Rikonstruksion i ambienteve të qëndrës për
moshën e tretë Bashkia Polican

Faza

Projekt Ide

Emertimi i Fletes:

Planvendosje e Objekteve

Skallat:

Projektori:

Ing.Ferdinand AVDIJAJ

Kapitulli:

Promesura

Nr. Fletes:

A - 07

Data:

Janar 2024

BASHKIA





REPUBLIKA E SHQIPËRISË
BASHKIA POLICAN

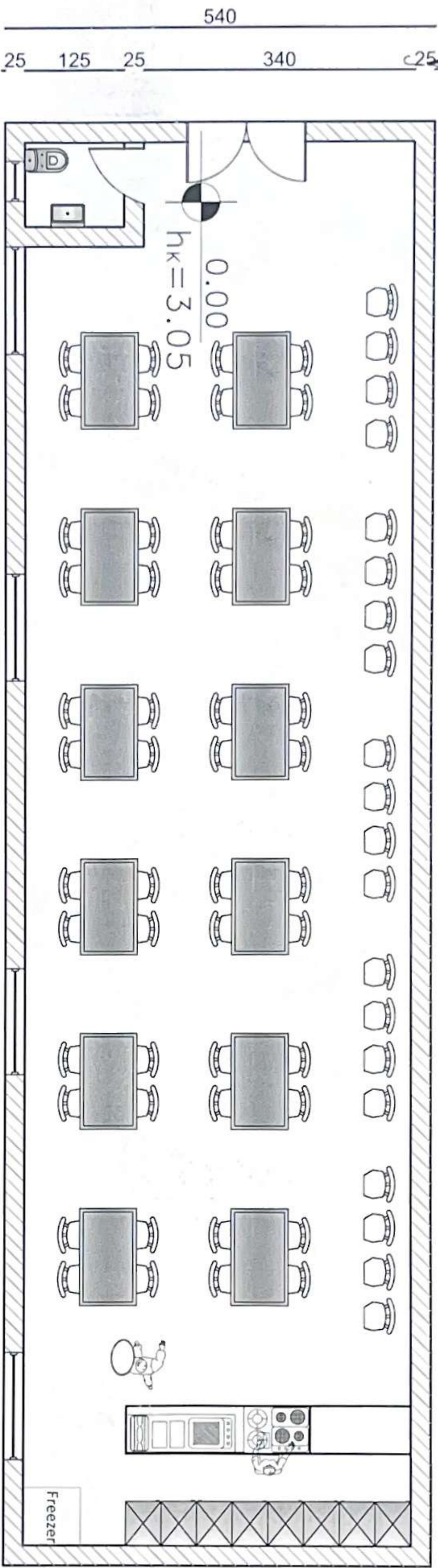

Blerje materialesh per rikonstruksionin e shesheve, rrugëve dhe godinave publike te Bashkise Polican



(Sip. ndertimit 98.3 m²)
(Sip. e shfrytezuar 86.7 m²)

		REPUBLIK E SHQIPËS BASHKIA POLICAN		Emertimi i Projektit: Blerje materialesh per rikonstruksionin e shesheve, rrugëve dhe godinave publike te Bashkise Polican		Emertimi i Fletes: Rikonstruksion i ambienteve të qëndrës për moshën e tretë Bashkia Polican		Projektori: Ing.Ferdinand AVDIUJ 		Kapitulli: Nr. Fletes: A - 08	
Faza		Projekt Ide		Shkalla: 1 : 125		Date: Janar 2024					

Blerje materialesh per rikonstruksionin e shesheve, rrugeve dhe godinave publike te Bashkise Polican

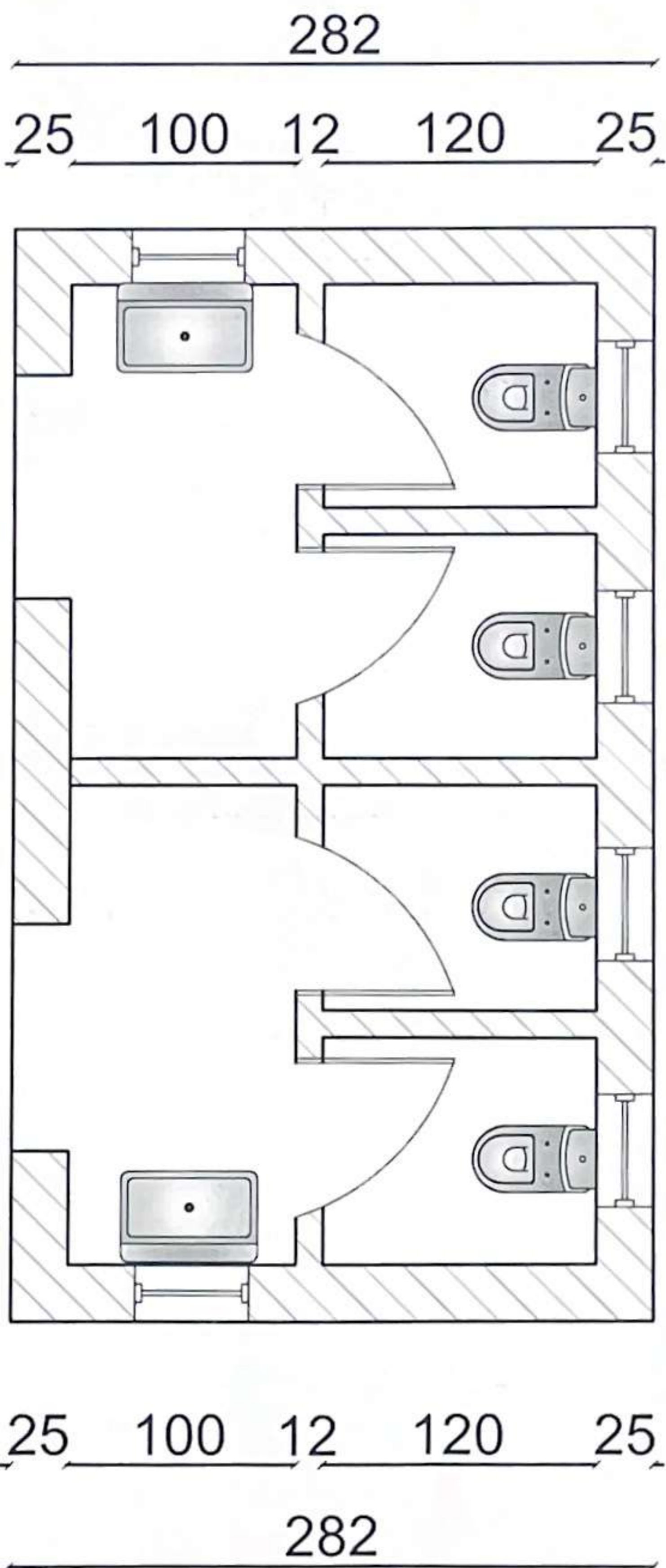

		Emertimi i Projektit: Blerje materialesh per rikonstruksionin e shesheve, rrugeve dhe godinave publike te Bashkise Polican		Emertimi i Fletes: Banjo Publike Bashkia Polican		Projektori: Ing.Ferdinand AVDIU		Kapitulli: Projekti Arkitekturik	
REPUBLIKA E SHQIPËRISË BASHKIA E POLICAN		Faza: Projekt Ide		Shtylla: 1 : 125		Data: Janar 2024		Nr. Fletes: A - 10	



Blerje materialesh per rikonstruksionin e shesheve, rrugëve dhe godinave publike te Bashkise Polican

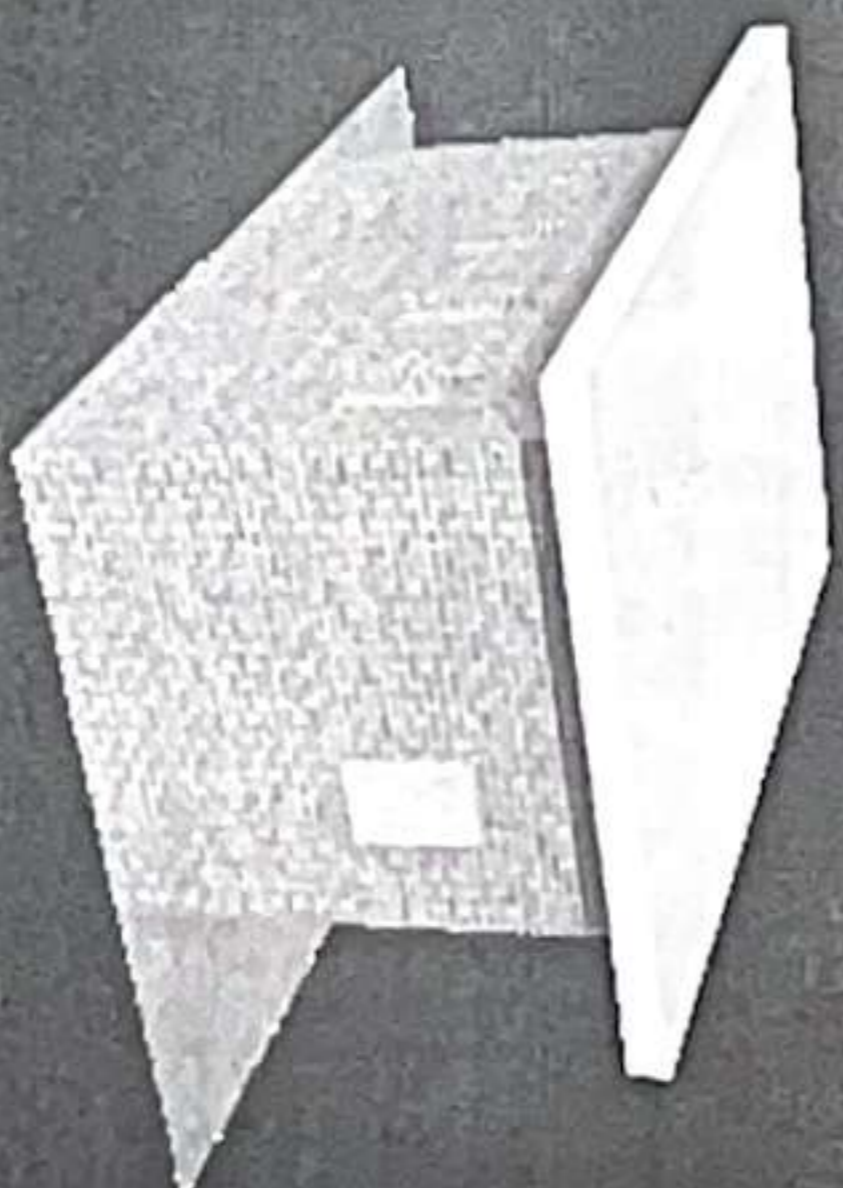
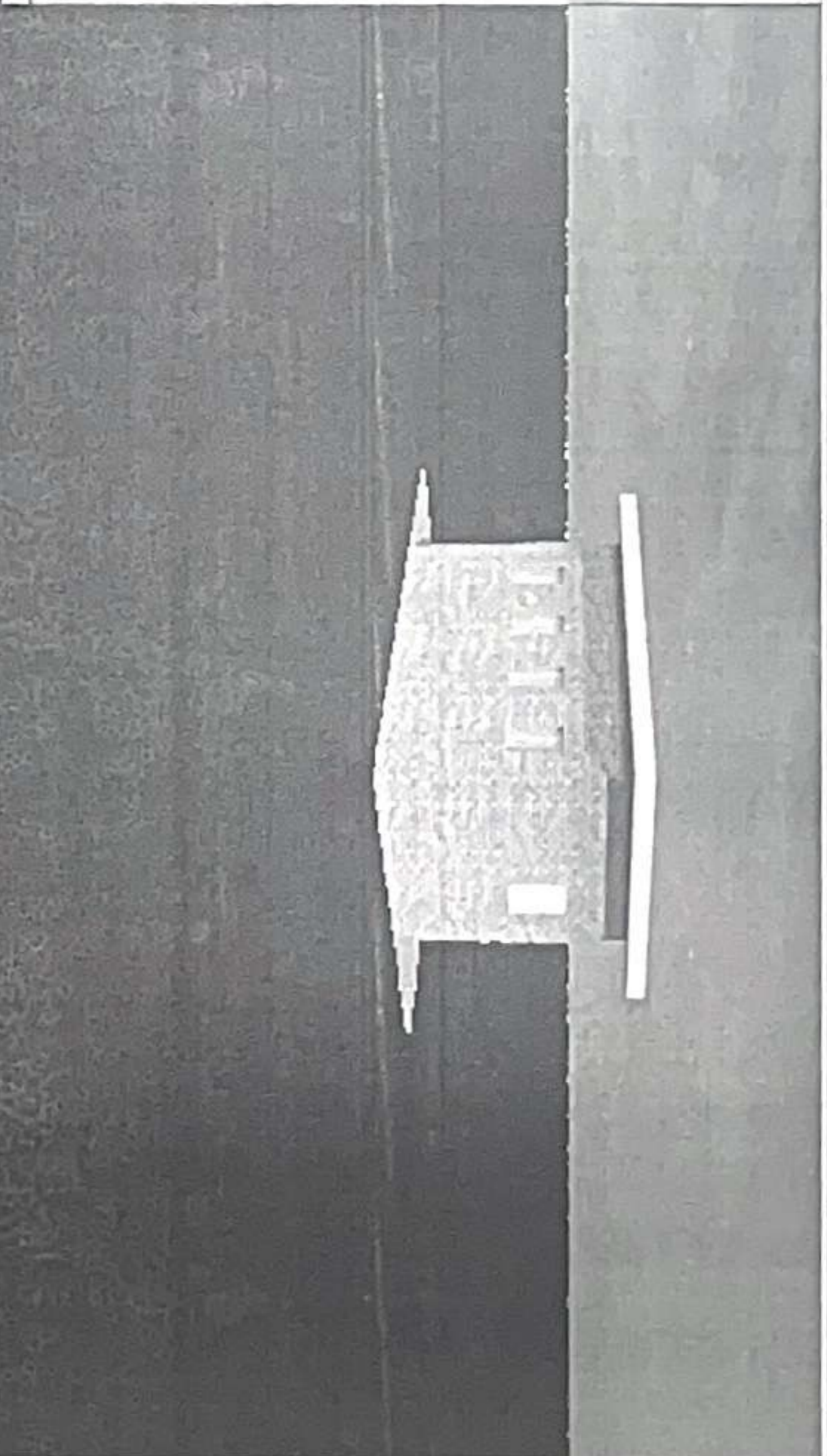
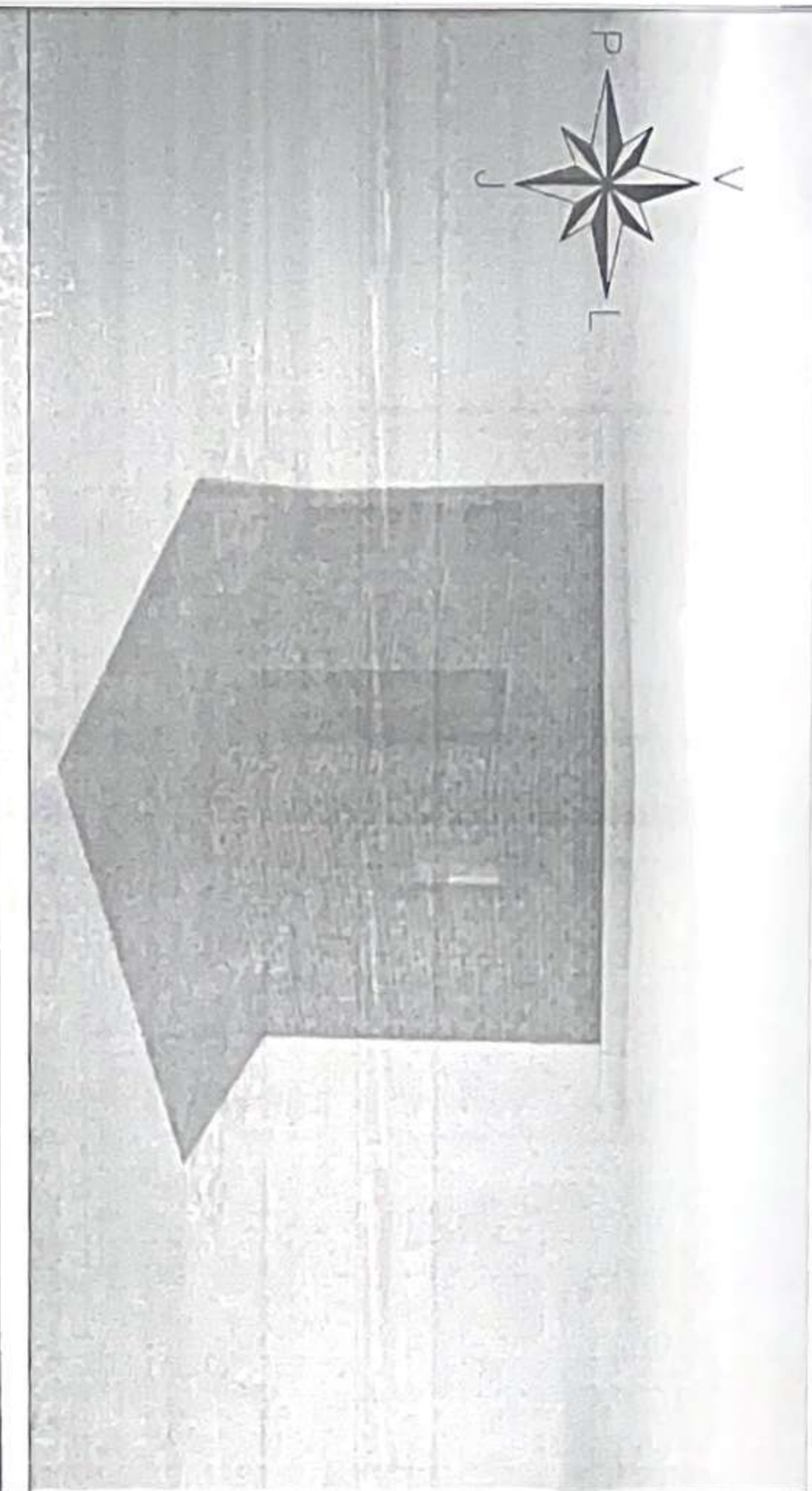

		REPUBLIKA E SHqipërisë BASHKIA E POLICAN	
Emertimi i Projektit: Blerje materialesh per rikonstruksionin e shesheve, rrugëve dhe godinave publike te Bashkise Polican		Emertimi i Fletes: Barjo Publike Bashkia Polican	
Faza Projekt Ide	Shkalla: 1 : 125	Projektor: Ing Ferdinand AVDIU	Kapitulli: Nr. Fletes: Data:
			Projekti Arkitekturik A - 11 Janar 2024



Blerje materialesh per rikonstrukcionin e shesheve, rrugëve dhe godinave publike te Bashkise Polican



MENYRA E NDERTIMIT TE STOLAVE

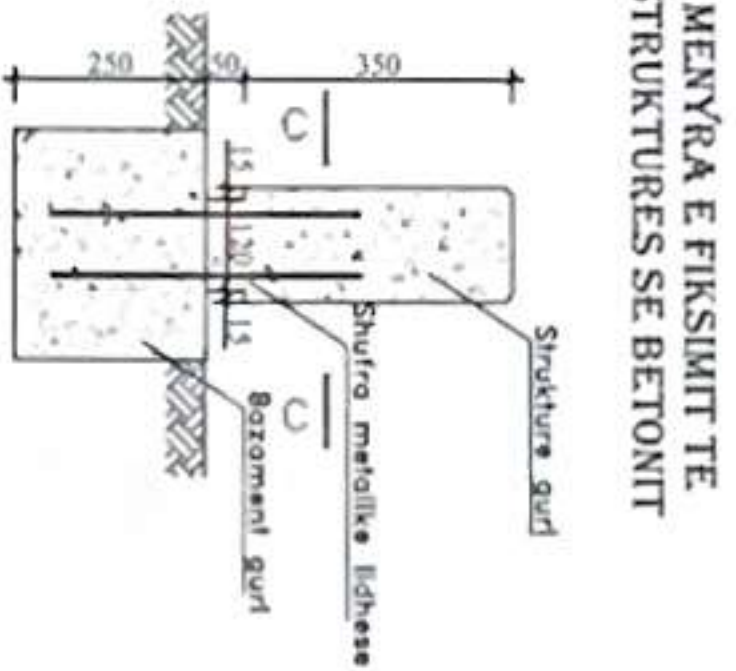
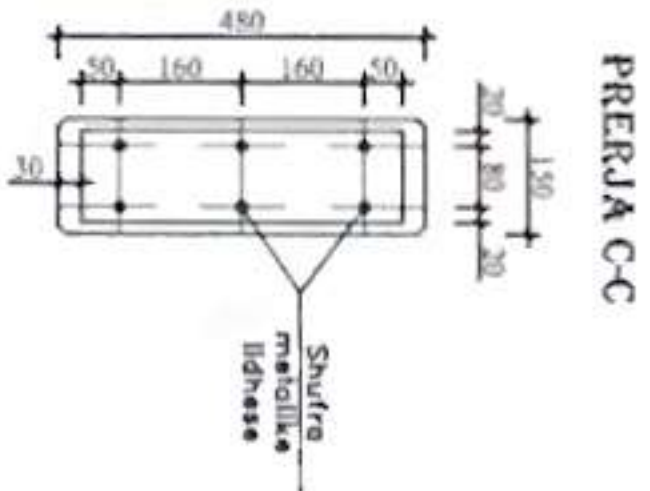
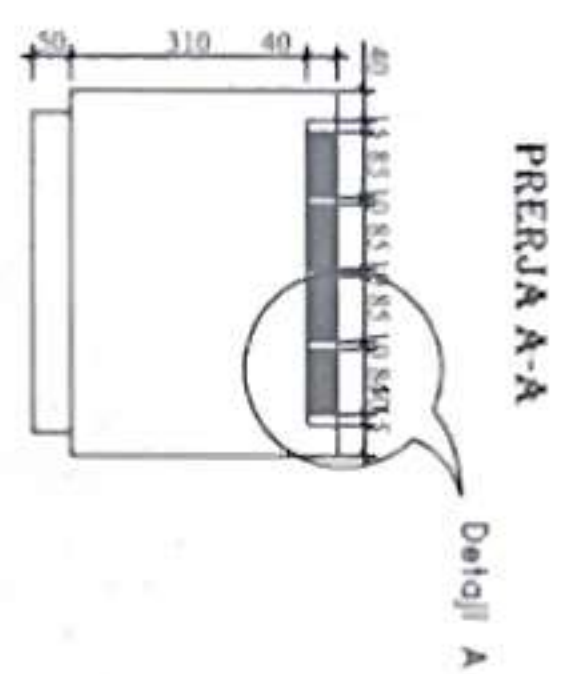
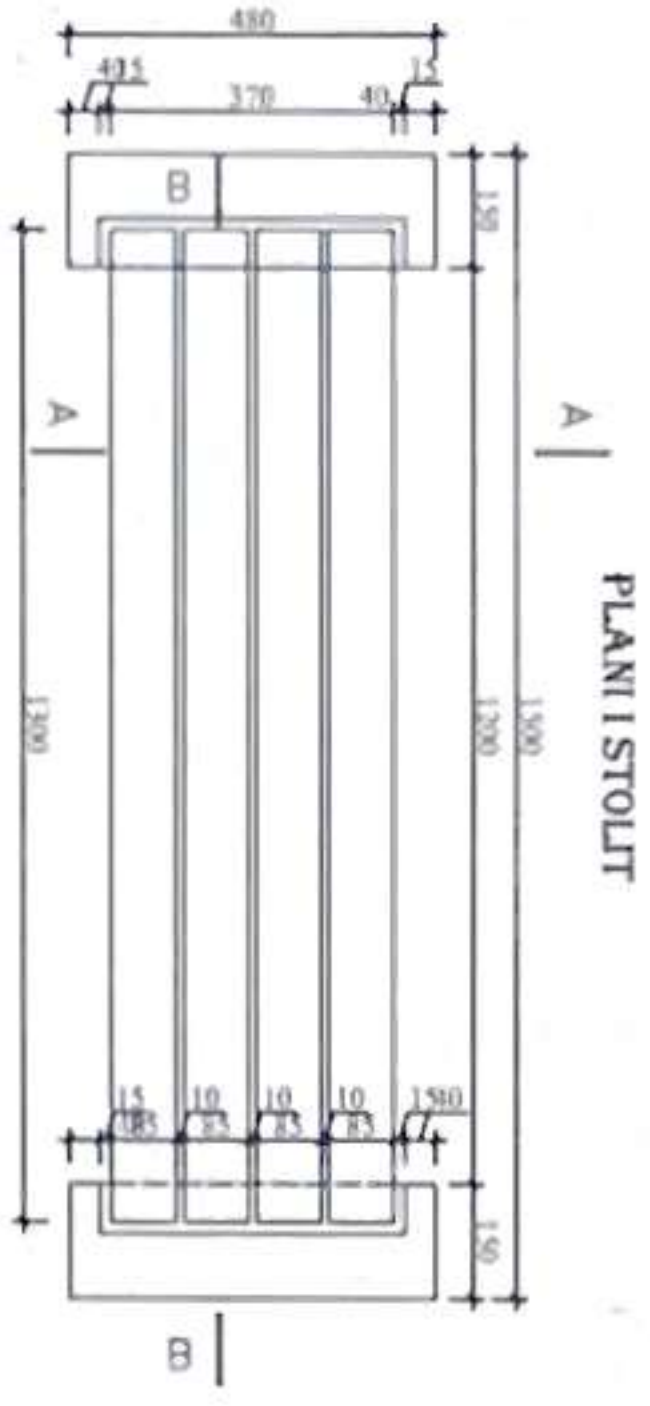
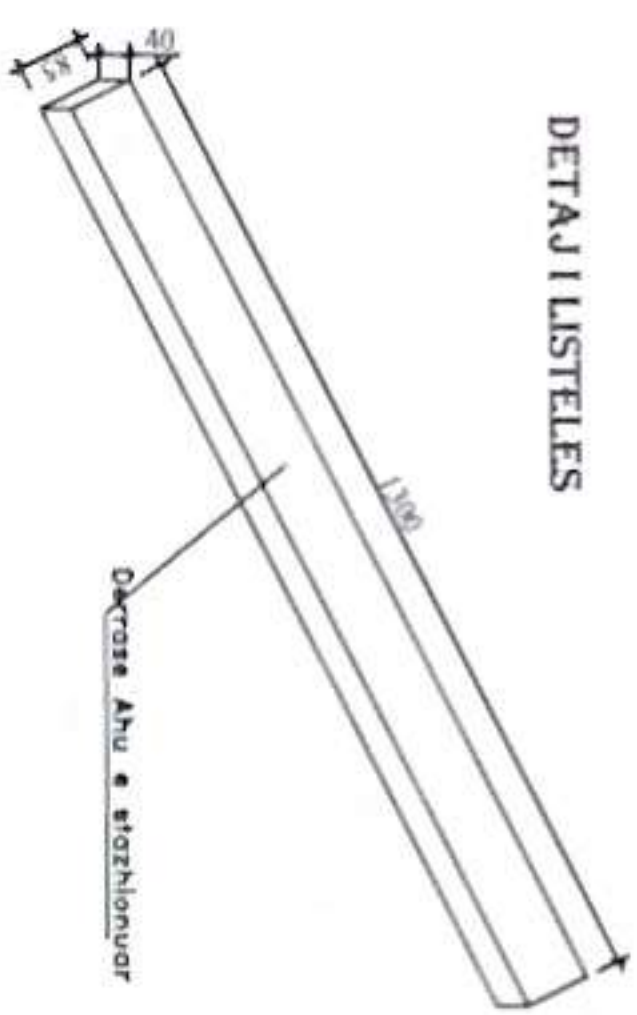
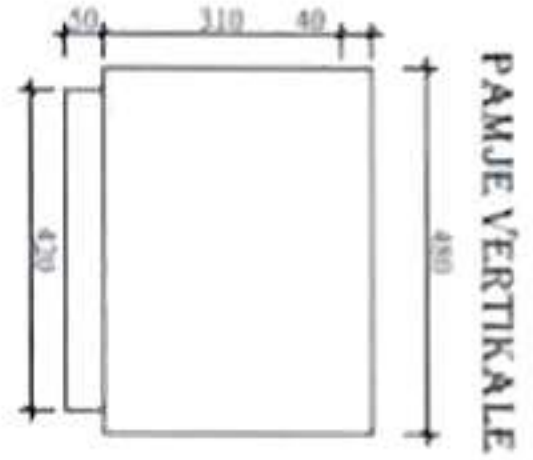

DETALJ 'A'

Fiksimit i clementeve te drurit ne gur

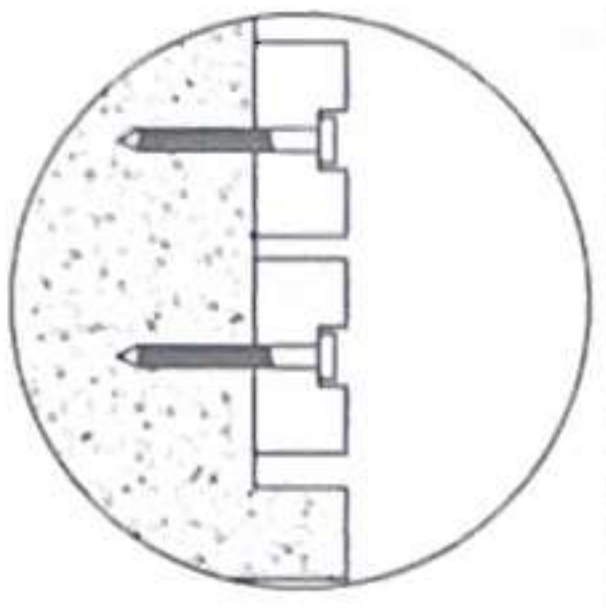

PRERJA B-B

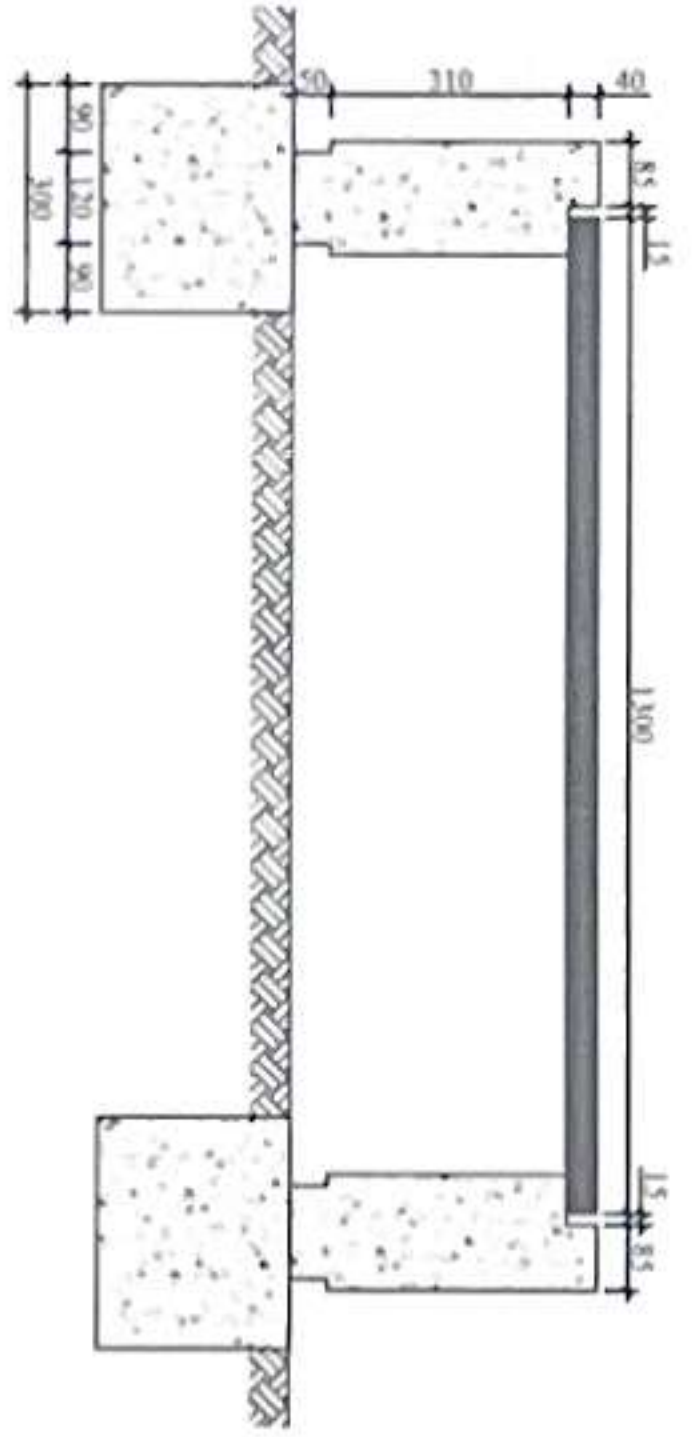

Shënime konstruktive:
 Shtohet dhe te jete konstruksione i perzier gur, dhe ndryshime drurit.
 Mbetjet e shtetit dhe te rindertes per gjatë te fiksimit me vete me qese me rreze qese.
 Ekzistencat per gjatë 50-120cm dhe te fiksimit me vete ndryshimet i shikohet te gjatë me vete R=10mm me 1/pe.

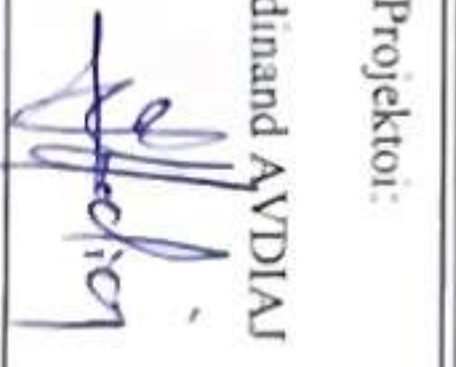
		REPUBLIKA E SHQIPËRISË BASHKIA E POLICAN	
Emertimi i Projektit: Blerje materialesh per rikonstrukcionin e shesheve, rrugëve dhe godinave publike te Bashkise Polican		Emertimi i Fletes: Detaje Teknike	
Faza: Projekti Ide		Shkallja: 1 : 125	
Projektori: Ing.Ferdinand AVDIUJ		Kapitulli: Projekti Arkitekturik	
		Nr. Fletes: A - 12	
Data: Janar 2024		Data:	

Blerje materialesh per rikonstrukcionin e shesheve, rrugëve dhe godinave publike te Bashkise Polican



MENYRA E NDERTIMIT KOSHAVE HEDHJEN E MBETURINAVE

PAMJE VERTIKALE

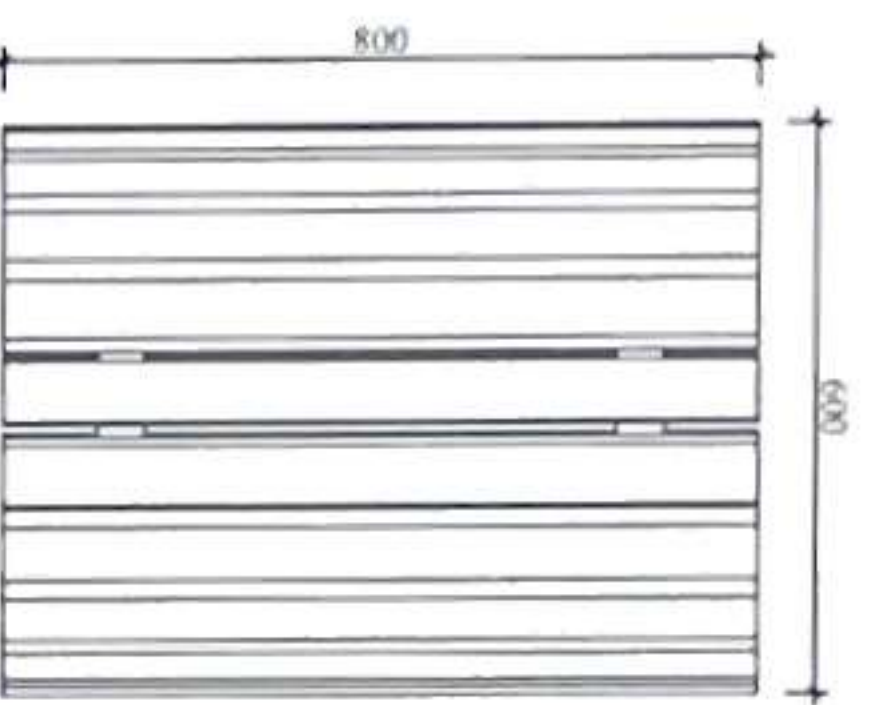

PRERJA A-A

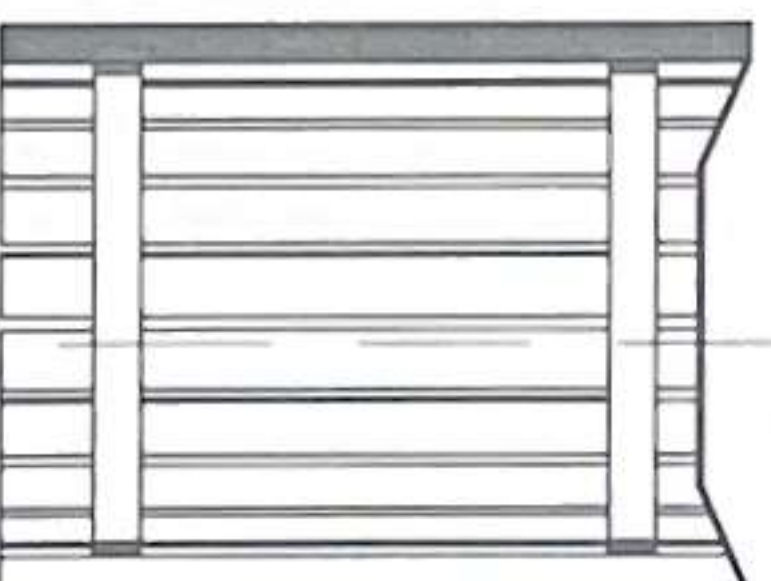

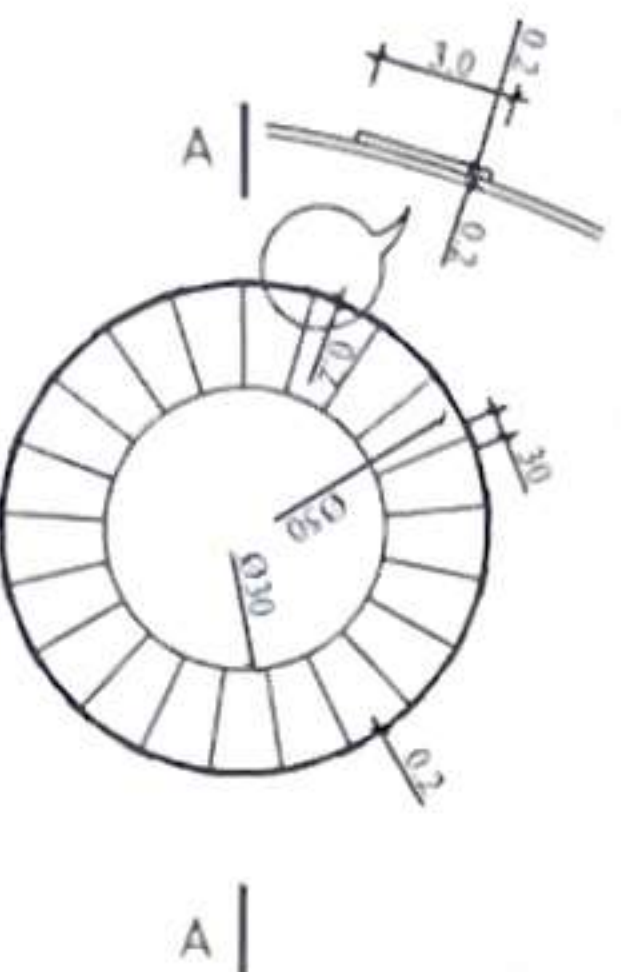

PLANI I KOSHIT



SHEVIME:

KOSHI DO TE PERGATITET ME ELEMENTE METALIKE ME SPESOR 2MM, TE FIKSUAR NE DY UNAZA METALIKE
TE VENDOSURA NE ANEN E BRENDSHME TE KOSHIT, TE SPOSTUARA 15CM NGA SKAJET.
FIKSIMI I ELEMENTIVE DO TE REALIZOHET ME SALDIM.
PJESA E ANESORE DO FUNKSIONOJE SI KAPAK ME MENTESHJE.
BRENDA KOSHIT DO VENDOST NJE KOSH TJETER ME LLAMARINE TE ZINGUAR DHE ME VRIMA 85MM
TE VENDOSURA CDO 3CM.

		REPUBLIKA E SHQIPERISE BASHKIA POLICAN		Emertimi i Projektit: Blerje materialesh per rikonstrukcionin e shesheve, rrugëve dhe godinave publike te Bashkise Polican	
Emertimi i Projektit: Blerje materialesh per rikonstrukcionin e shesheve, rrugëve dhe godinave publike te Bashkise Polican		Emertimi i Fletes: Detaje Teknike		Projektori: Ing. Ferdinand AVDIJA 	
Faza Projekti Ide		Shkallia: 1 : 125		Kapitulli: Projektu Arkitekturik	
		Nr. Fletes: A - 13		Data: Janar 2024	



Blerje materialesh per rikonstruksimin e shesheve, rrugëve dhe godinave publike te Bashkise Polican



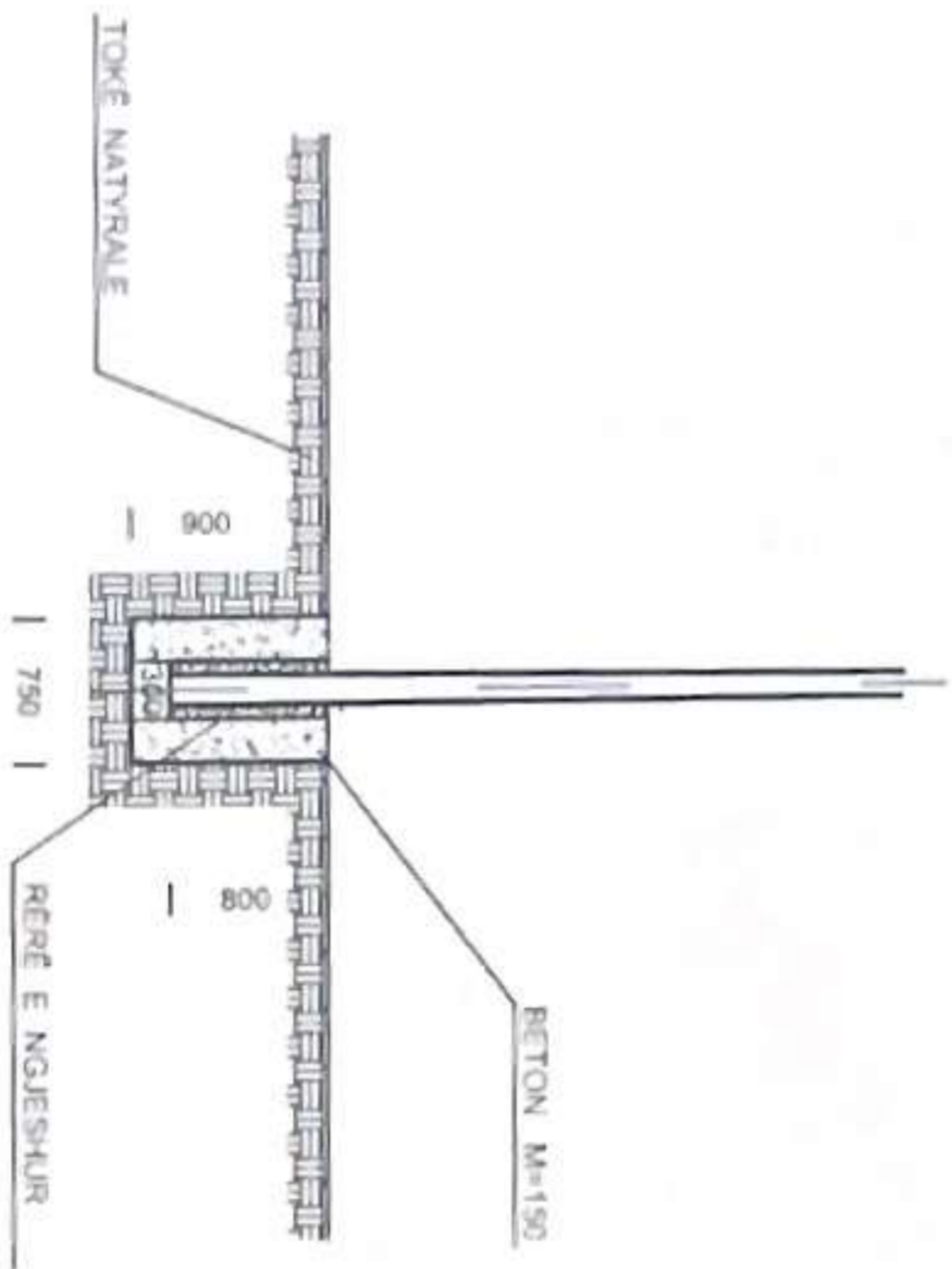

Hollësi e inkastrimit të kolonës së ndriquesit

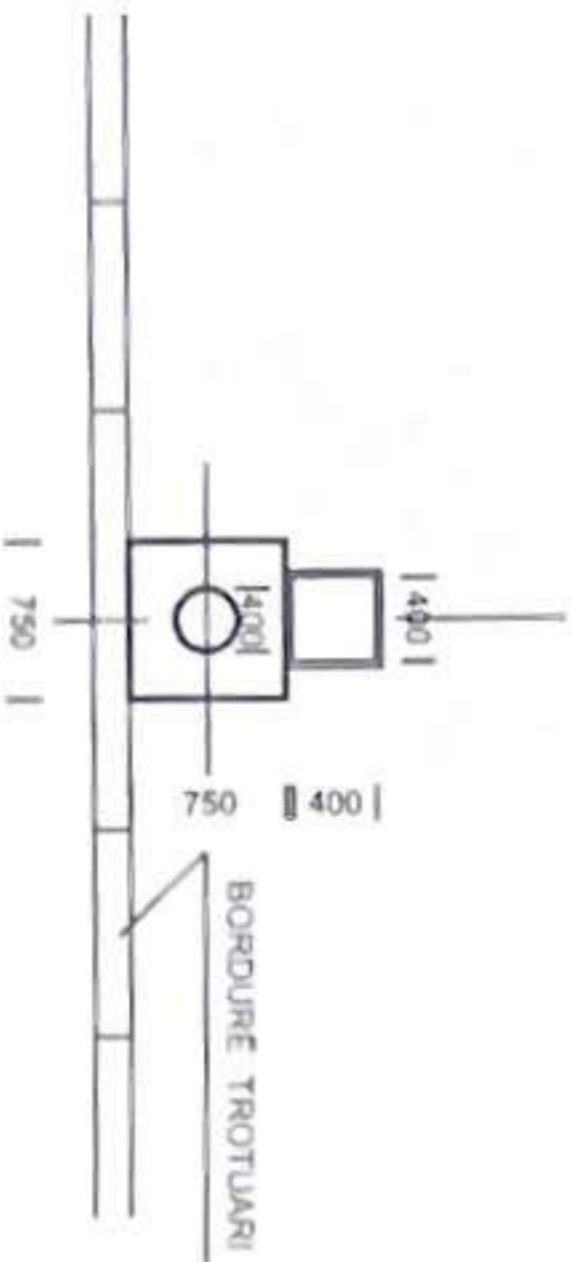
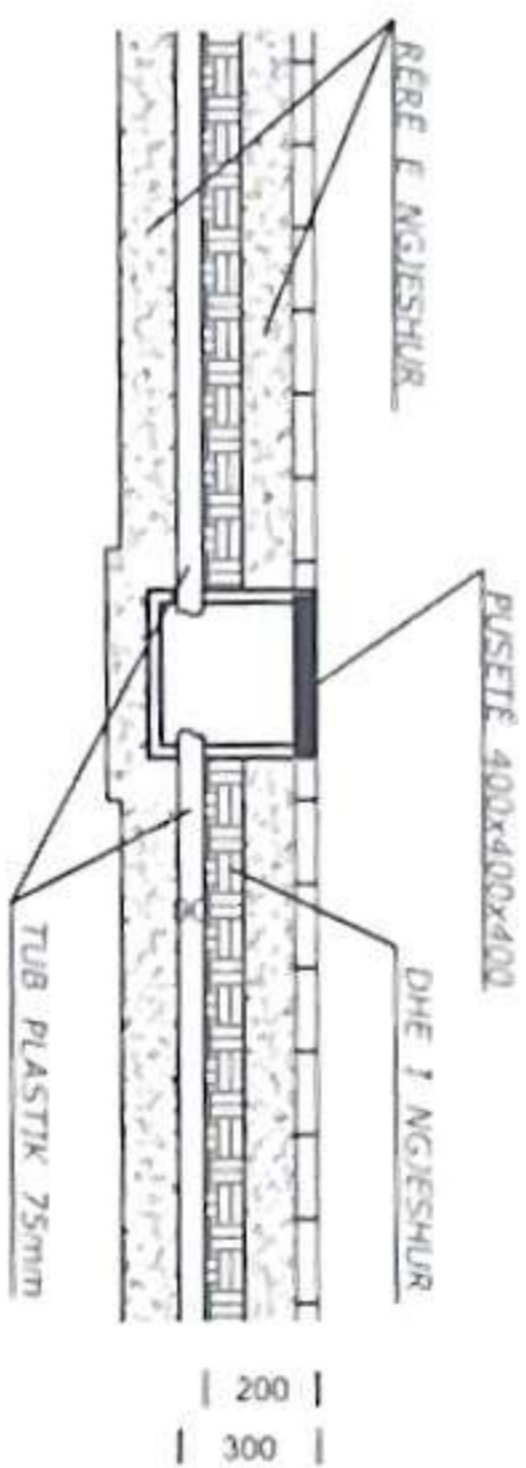

Hollësi e vendosjes së pusetës



		Emertimi i Projektit: Blerje materialesh per rikonstruksimin e shesheve, rrugëve dhe godinave publike te Bashkise Polican		Emertimi i Fletes: Detaje Teknike		Projektori: Ing Ferdinand AVDIUJ 		Kapitulli: Projekt i Arkitekturik	
REPUBLIKA SHQIPËRE BASHKISE POLICAN		Faza: Projekti Ide		Shtylla: 1 : 125		Nr. Fletes: A - 14		Data: Janar 2024	



Blerje materialesh per rikonstrukcionin e shesheve, rrugëve dhe godinave publike te Bashkise Polican



Shtrimi i sheshit me gur

Gur dekorativ me permasa (20xvariabellx4)

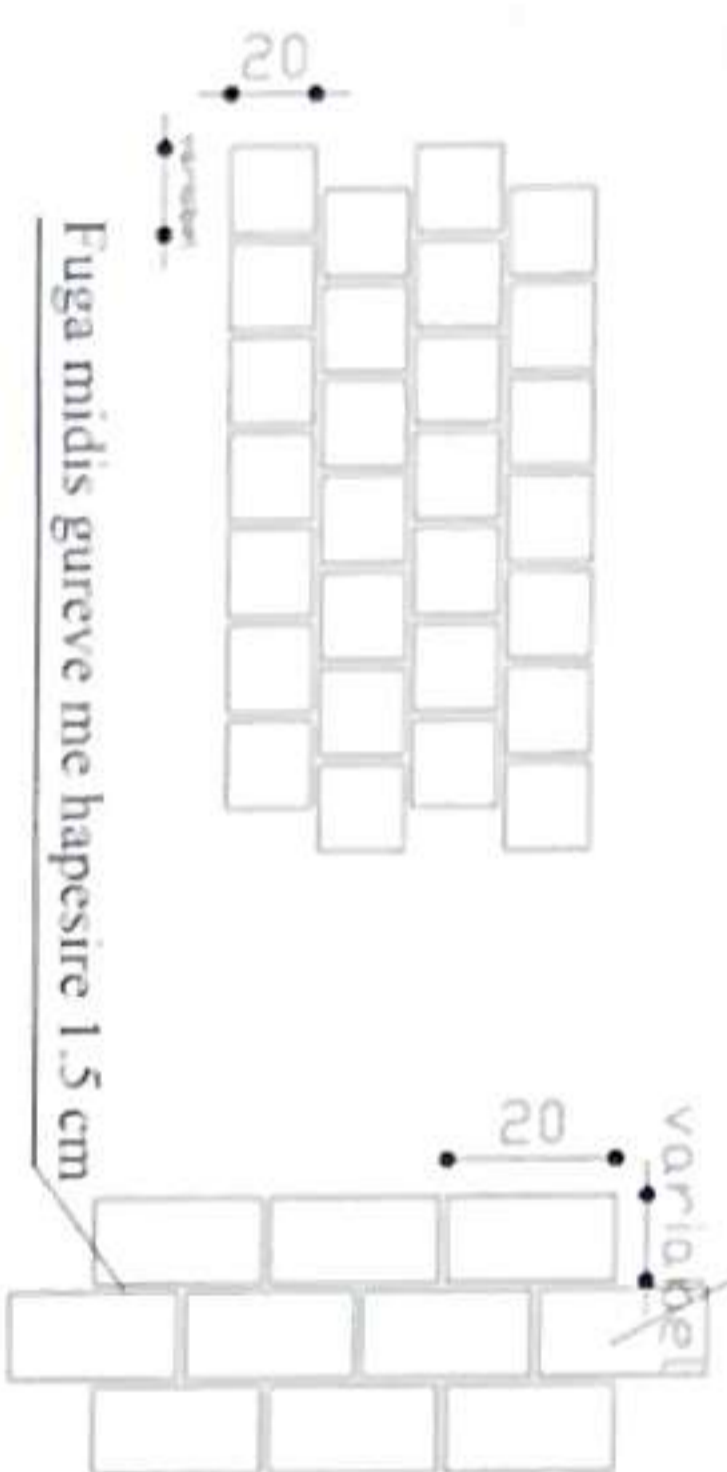

Fuga midis gureve me hapesire 1.5 cm

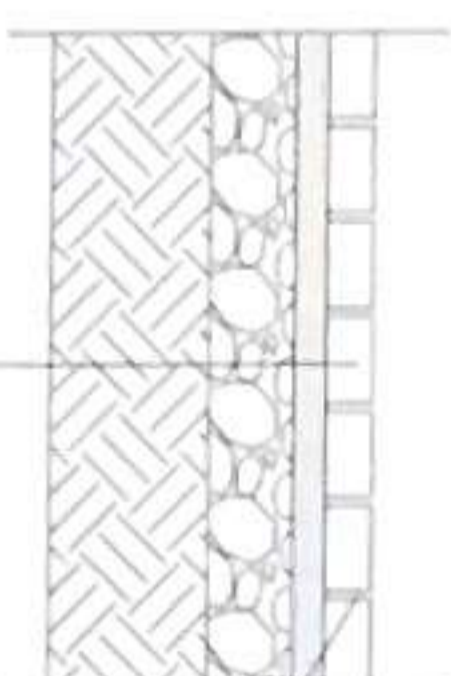

Fuga midis gureve me hapesire 1.5 cm

Gur dekorativ me permasa (te ndryshme)

Shtrese llaci me vendosjen e gurit

Shtrese betoni me trasheti t=10cm

Shtrese cakulli (zhavor) me trashësi t=15 cm

	Emertimi i Projektit:		Emertimi i Fletes:		Projektori:		Kapitulli:	Projekti Arkitektonik
	Blerje materialesh per rikonstrukcionin e shesheve, rrugëve dhe godinave publike te Bashkise Polican		Detaje Teknike		Ing.Ferdinand VDIJAJ		Nr. Fletes:	A - 15
Bashkia Polican		Projekti Ide		Shkallja:		Data:		Janar 2024
1 : 125								



Blerje materialesh per rikonstrukcionin e shesheve, rrugëve dhe godinave publike te Bashkise Polican

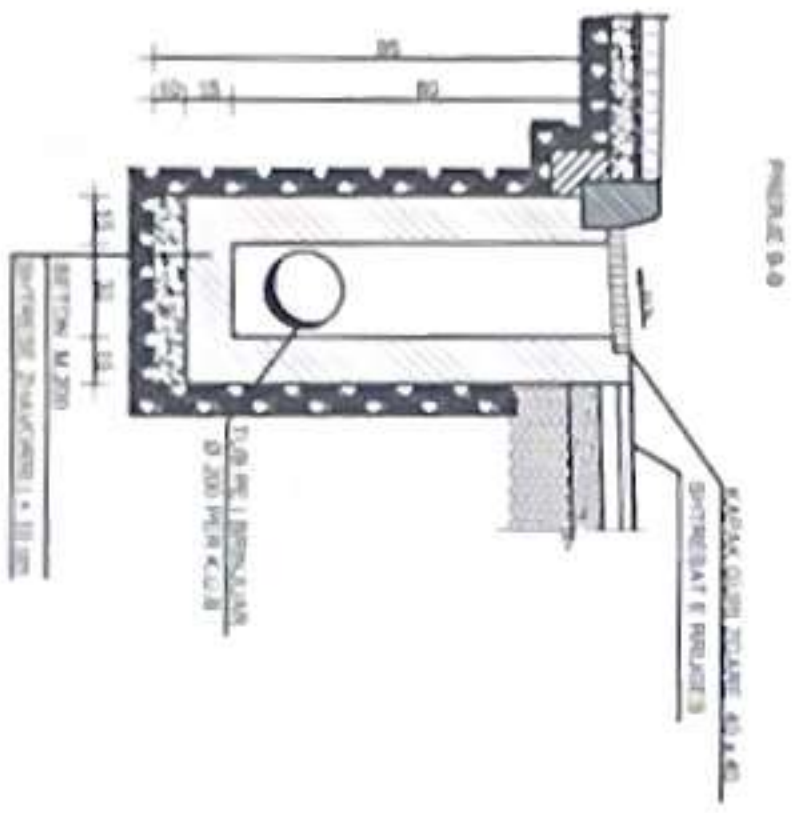
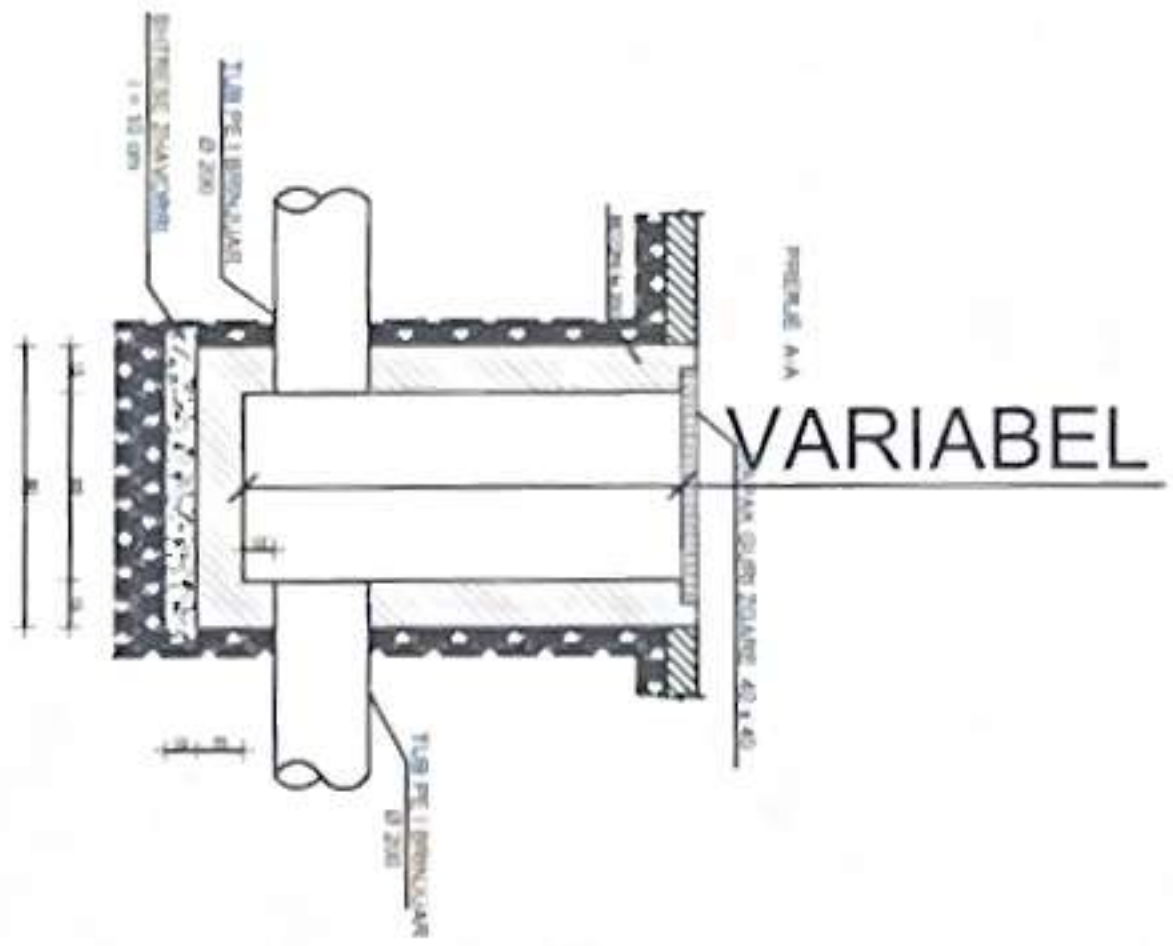
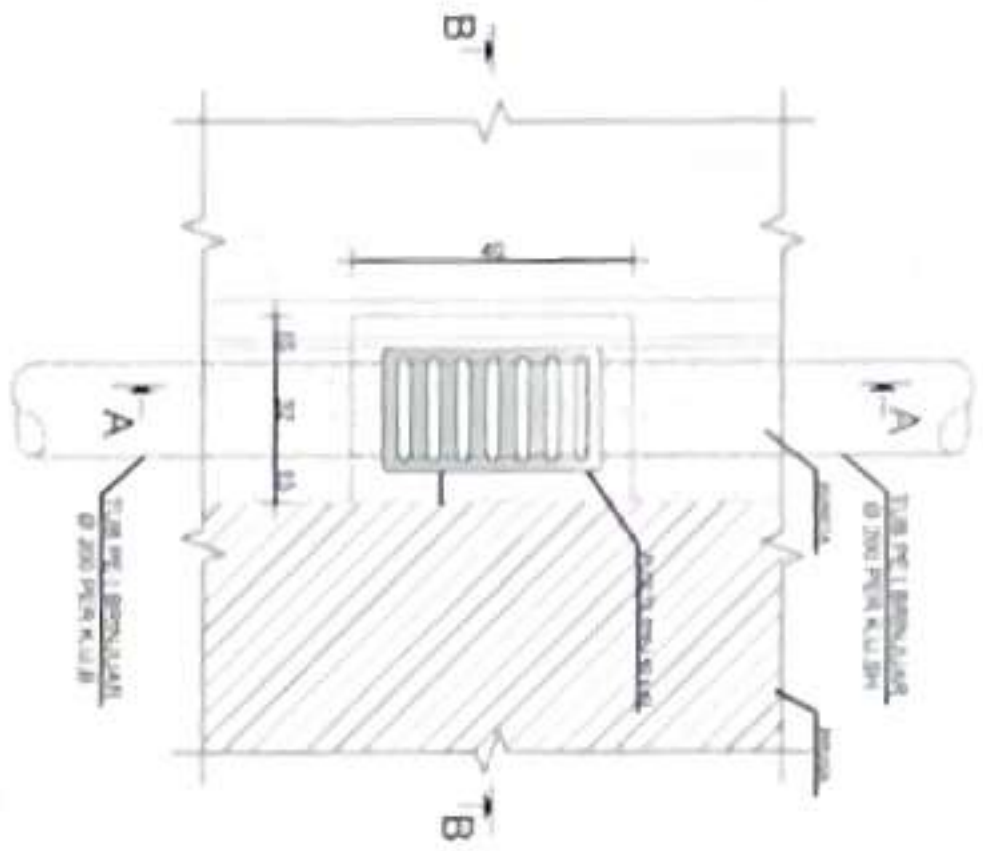

		REPUBLIKA E SHQIPËRISE BASHKIA POLICAN		Emertimi i Projektit: Blerje materialesh per rikonstrukcionin e shesheve, rrugëve dhe godinave publike te Bashkise Polican		Emertimi i Fletes: Detaje Teknike		Projektori: Ing. Ferdinand AVDIUJ		Kapitulli: Nr. Fletes: Data:		Projekti Arkitekturik A - 16 Janar 2024	
Faza:		Projekti Ide		Shkalla:		1 : 125							