



REPUBLIKA E SHQIPERISE

BASHKIA PEQIN

PROJEKT ZBATIMI: RINDERTIMI I SHKOLLES 9-VJECARE SHEZE
PROJEKTI ARKITEKTONIK



PROJEKTUES

"A. SH. ENGINEERING" sh.p.k.

MAJ, 2024

PLAN SISTEMIMI



Zonimi funksional

A. Ndertimi i shkolles	131 m ²
B. Ndertimi i kopshtit	187 m ²
C. Fushë sportive (futbolli)	233 m ²
D. Fushë sportive volejbolli+basketbolli	367 m ²
E. Vegla gjumnastikotre (paralele)	83 m ²

Legenda

Kufiri i promes	Gjelbërim i Lartë
Mur rrethues	Gjelbërim i Ulët
Këmbëllë rrethimi	Zgare për Bicikletat
Porta hyrëse	Stola
Terren sportiv (Fushë volejboli+basketbolli)	Kisha të vegjël
Terren sportiv (Fushë futbollli)	Mërmirues
Terren sportiv (Paralele)	Puz uji elektrikes
Terren i gjelbëruar (Siç natyral)	

REPUBLIKA E SHQIPERISE
 BASHKIA PEÇON
 KULENT BASHKIA PEÇON



PROJEKT ZBATIM FUNKSIONAL I SHKOLLES QIVLEÇARE SHETE

EMERTHI I PLETES
 PLAN SISTEMIMI

ARRESHI I SHKURT

PROJEKTUAR

"A. SH. ENGINEERING" sh.p.k



VERIFIKUESI I SHKURTIT PEÇON

PLAN SISTEMIMI - MATERIALET E SHESHIT



Sistim me pllaka betoni, per oborrin dhe trugicat



Bar natyral per siperfaqet e gjelberuara



Sistrese rere per paralelet



Sistim me bar artificial per fushen e futbollit dhe kamin e lojtarave te femijevs.

REPUBLIKA E SHQIPERISE



BASHKIA PEÇON

KUENT BASHKIA PEÇON

PROJEKT ZBATIM PRINDERTHI I SHKOLLËS QVLEÇARË SHESH

EMERTHI I FLETËS
PLAN SISTEMIMI - MATERIALET E SHESHIT

ARRESHI I KUVENDIT

PROJEKTUAR

"A. SH. ENGINEERING" sh.p.k



REKONSTRUKCIONE DHE SHIKIMET E PESHIMIT

ELEMENTET URBANE



Legjenda

Kufiri i pronës	Gjelbërim i Lartë
Muri rrethues	Gjelbërim i Ulët
Kengjella rrethimi	Zgare për Bicikletat
Porta kryesore	Stola
Tërren sportiv (Fushë volejboli/basketbolli)	Kisha të vegjël
Tërren sportiv (Fushë futboll)	Hidrore
Tërren sportiv (Parksiale)	
Tërren i gjelbërues (Bar natyrore)	

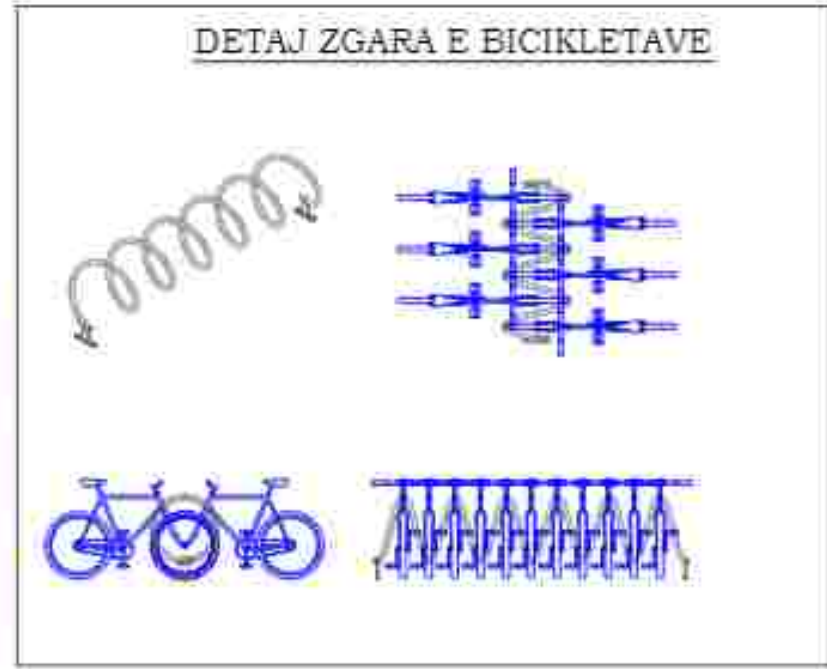
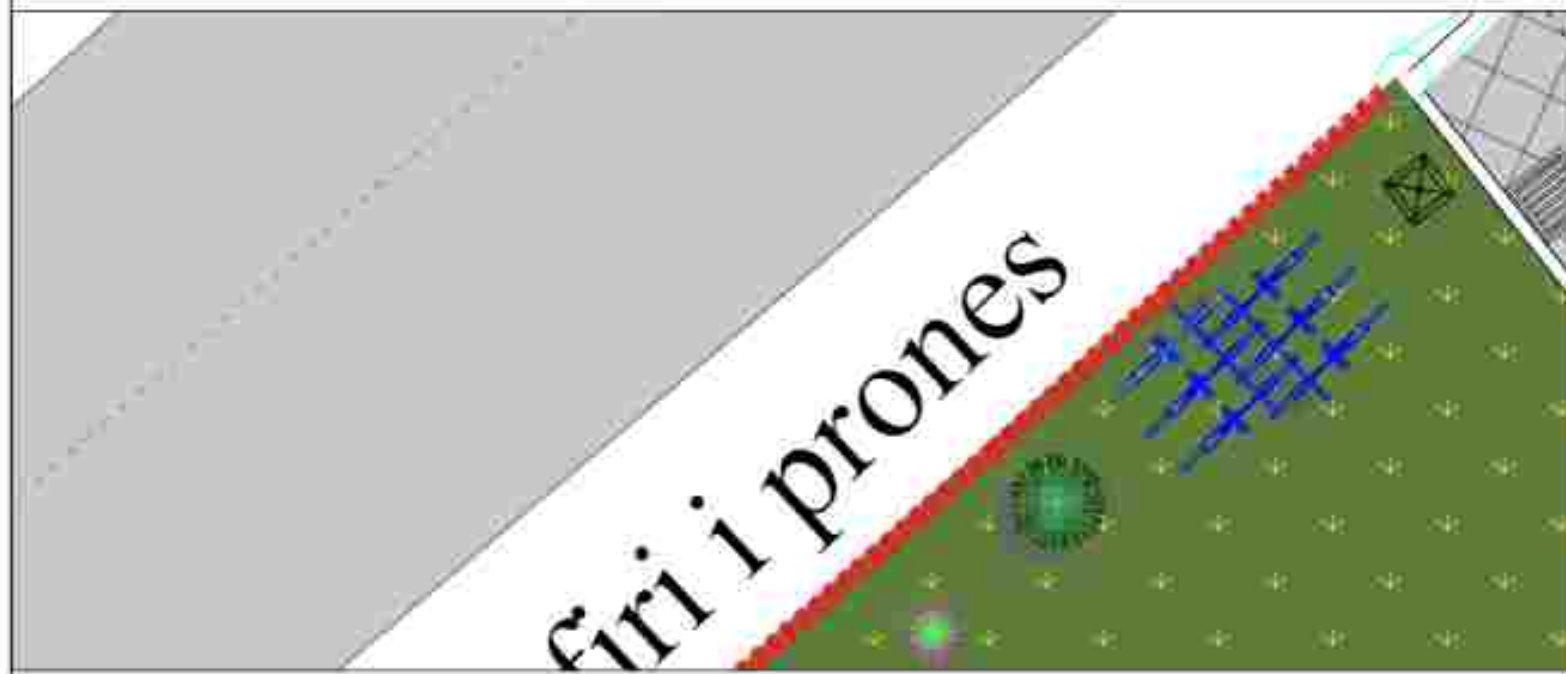

REPUBLIKA E SHQIPERISE



BASHKIA E PEÇËN

KUËNT BASHKIA PEÇËN

PROJEKT ZBATIM I RINDERTIMIT I SHKOLLËS QVLEÇARË SHËTË

SHËRTIMI (FUSTET) I ELEMENTET URBANE

ARRESHI I SHËRTIMIT

PROJEKTIMI

"A. SH. ENGINEERING" sh.p.k



REKONSTRUKCIONIMI I SHËRTIMIT

ELEMENTET URBANE



Legjenda

Kufiri / prona	Gjelbërim i Lartë
Afërsi rrethues	Gjelbërim i Ulët
Këmbëllë rrethimi	Egre për Bicikletat
Porta hyrëse	Stolë
Terren sportiv (Fushë volejboli/basketbolli)	Kisha të vegjël
Terren sportiv (Fushë futboll)	Hidrore
Terren sportiv (Parake)	
Terren i gjelbërues (Bar natyrore)	

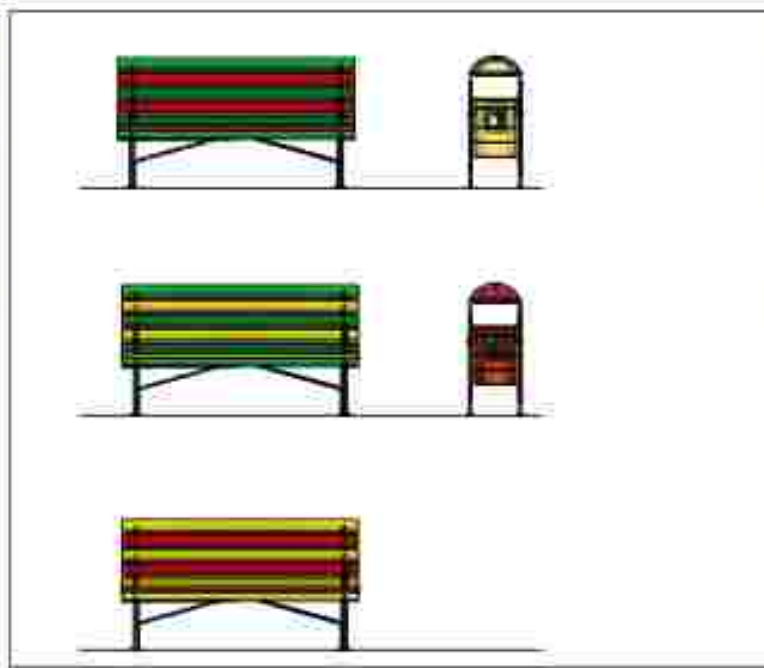
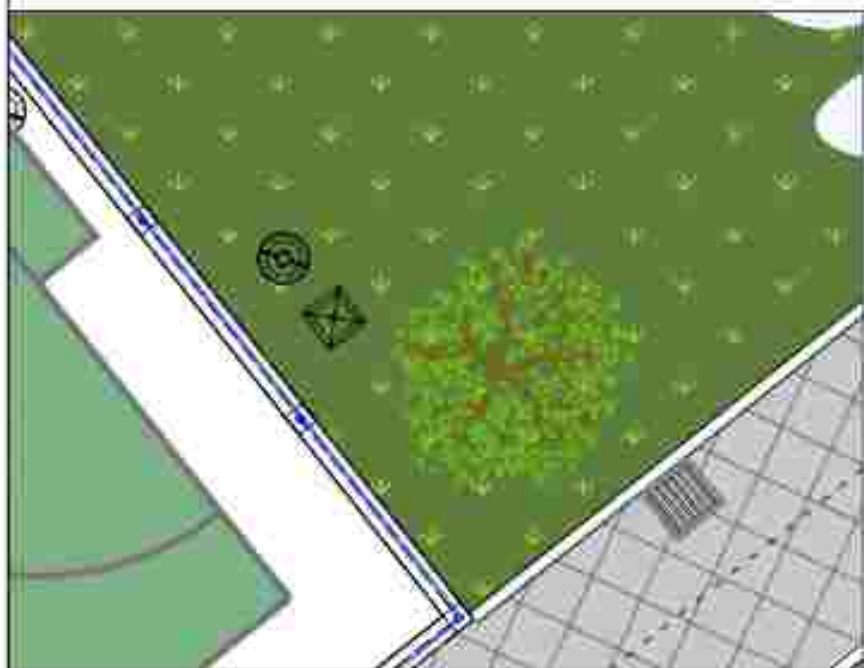

REPUBLIKA E SHQIPERISE



BASHKIA E PEÇËN

KUËNTI BASHKIA PEÇËN

PROJEKTI DENDRITIV I SHKOLLËS QIVLEÇARË SHKËR

ENJERTIMI (FUSTED) / ELEMENTET URBANE

ARRESHI / ALBETI

PROJEKTUAR

"A. SH. ENGINEERING" sh.p.k



INDICUES DENDRITIV

ELEMENTET URBANE



Legjenda

Kufiri i pronës	Gjalberim i Lartë
Muri rrethues	Gjalberim i Ulet
Këmbjella rrethimi	Zgara për Bicikletat
Porta hyrëse	Stola
Terren sportiv (Fushë voleybolli+basketbolli)	Kosha të vegjël
Terren sportiv (Fushë futbollit)	Ndricues
Terren sportiv (Paralele)	
Terren i gjelberuar (Bar natyral)	

REPUBLIKA E SHQIPERISE

BASHKIA PEÇËN

KUËNT BASHKIA PEÇËN

PROJEKT ZBATIM I RINDERTIMIT I SHKOLLËS QIVLEÇARË SHETË

DETAJE TE MEJELLJES SE GJELBERIMIT TE LARTE DHE TE ULET

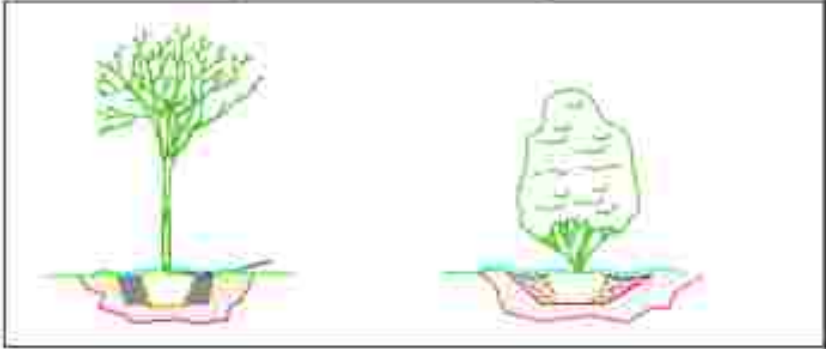

KACUBE



BAR NATYRAL



PEME DEKORATIVE



ENJERTIMI (FUSTET) / ELEMENTET URBANE

ARRAZHIMI / ALBETIT

PROJEKTUAR

"A. SH. ENGINEERING" sh.p.k

INDICIMET / SHKURTIT / PEÇËN

PLAN ORGANIZIMI I PUNIMEVE



Legjenda

1. Hyrje-Dalje kantieri
 2. Cezem kantieri (larje mjetesh)
 3. Ndhima e shpejte
 4. Zyre kantieri
 5. Garderobe
 6. Banje kantieri
 7. Depozitim hekuri
 8. Magazine
 9. Beto-pompe
- Rrethim kantieri

REPUBLIKA E SHQIPERISE



BASHKIA E PEÇËN

KLIENTI: BASHKIA E PEÇËN

PROJEKTI: DEZATI I RANDEUTHE I SHKOLLËS 9-VLESHARE SHKËRRE

ENJERTI I PLETES:
PLAN ORGANIZIMI I PUNIMEVE

ARRESHI I ALBETI

PROJEKTUAR

"A. SH. ENGINEERING" sh.p.k



REKONSTRUKCIONE DHE SHIKIMTEKTONIKE

FRAGMENT I RRETHIMIT PROVIZOR

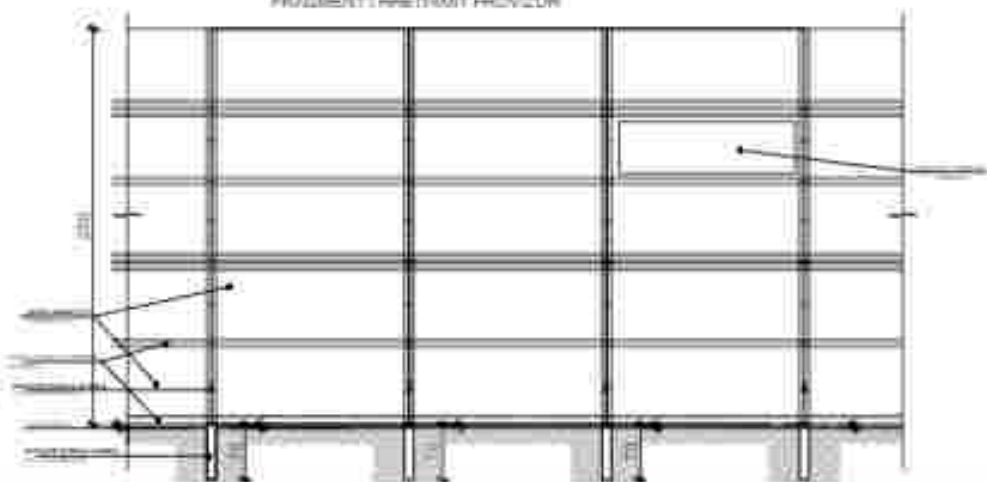

Prora A-A



Prora B-B

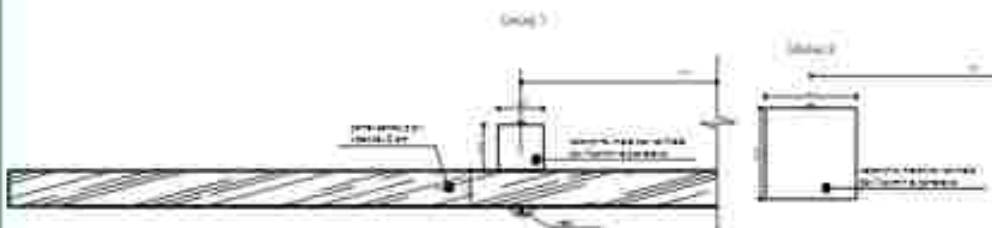
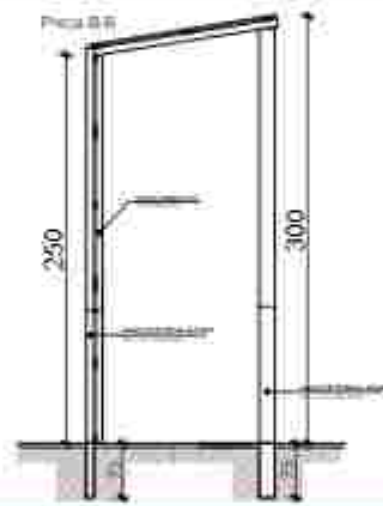

PLANI I DIMENSIONUAR KATI PERDHE

REPUBLIKA E SHQIPERISE



DASHKIA PEÇON

KLENTBASHKIA PEÇON

PROJEKT I ZBATIMSDORITHE I SHKOLLES SHKOLLOR SHKOLLE

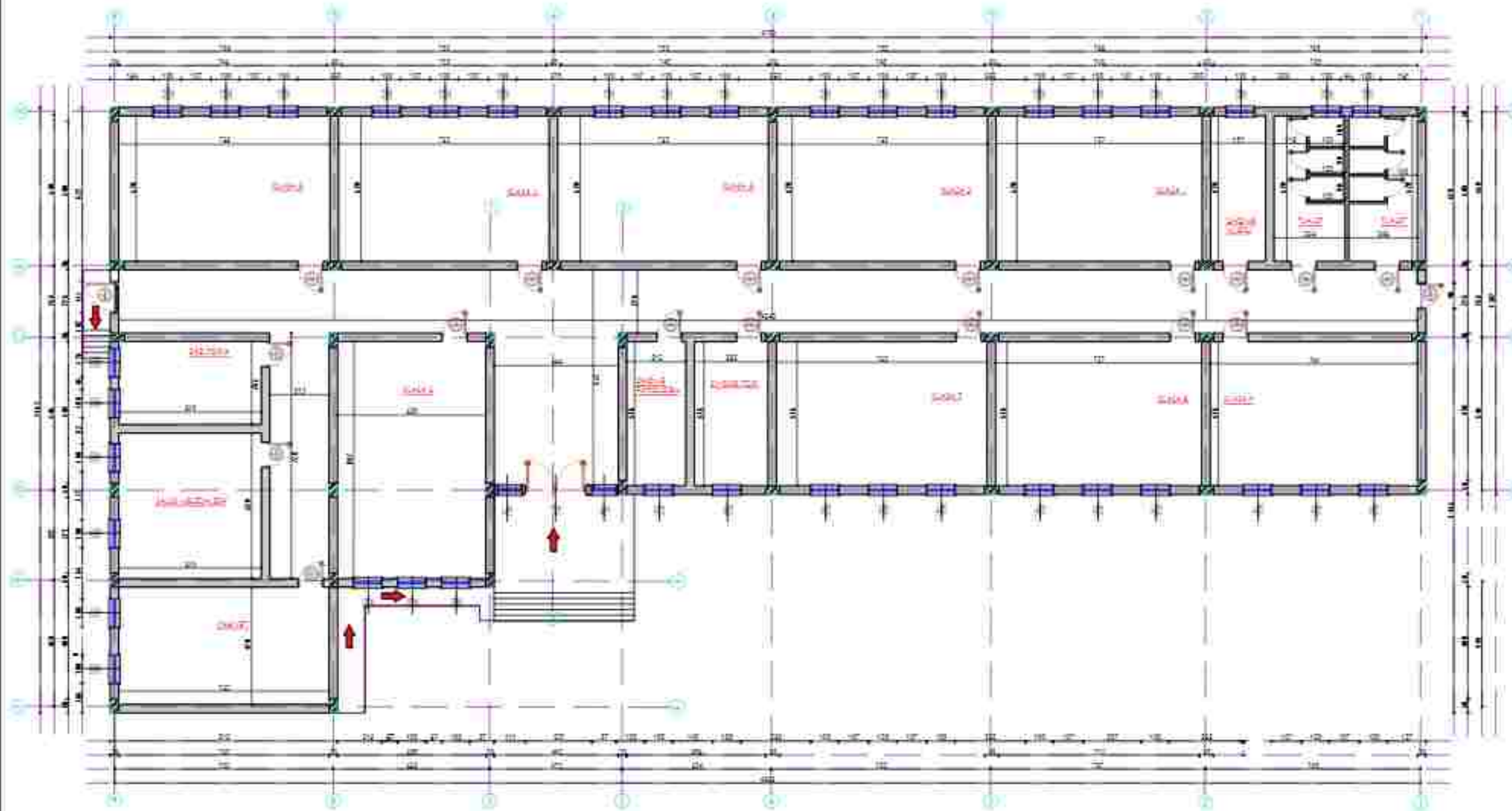

SHKURTIM I PLANIT
PLANI I DIMENSIONUAR KATI PERDHE

MBREJTI I PLANIT

REDAKTOR

"A. SH. ENGINEERING" sh.p.k



INDHOLL I SHKURTIMIT

PLANI I MOBILUAR KATI PERDHE

REPUBLIKA E SHQIPERISE



TASHKIA PËÇËN

KLUBIT BASHKË PËÇËN

PROJEKT BASHKËPUNËSHTETËR I SHKOLLËS Q-ULÇIARË 3 PËÇËN



ENERJTI I FLETËS
PLANI I MOBILUAR KATI PERDHE

ARHITEKTI I KREUTËR

PROJEKTUAR

"A.S.H. ENGINEERING" sh.p.k.

PLANI I DIMENSIONUAR KATI PERDHE (KOPSHTI)

REPUBLIKA E SHQIPERISE



BASHKIA PEQIN

KLENTI BASHKIA PEQIN

PROJEKT

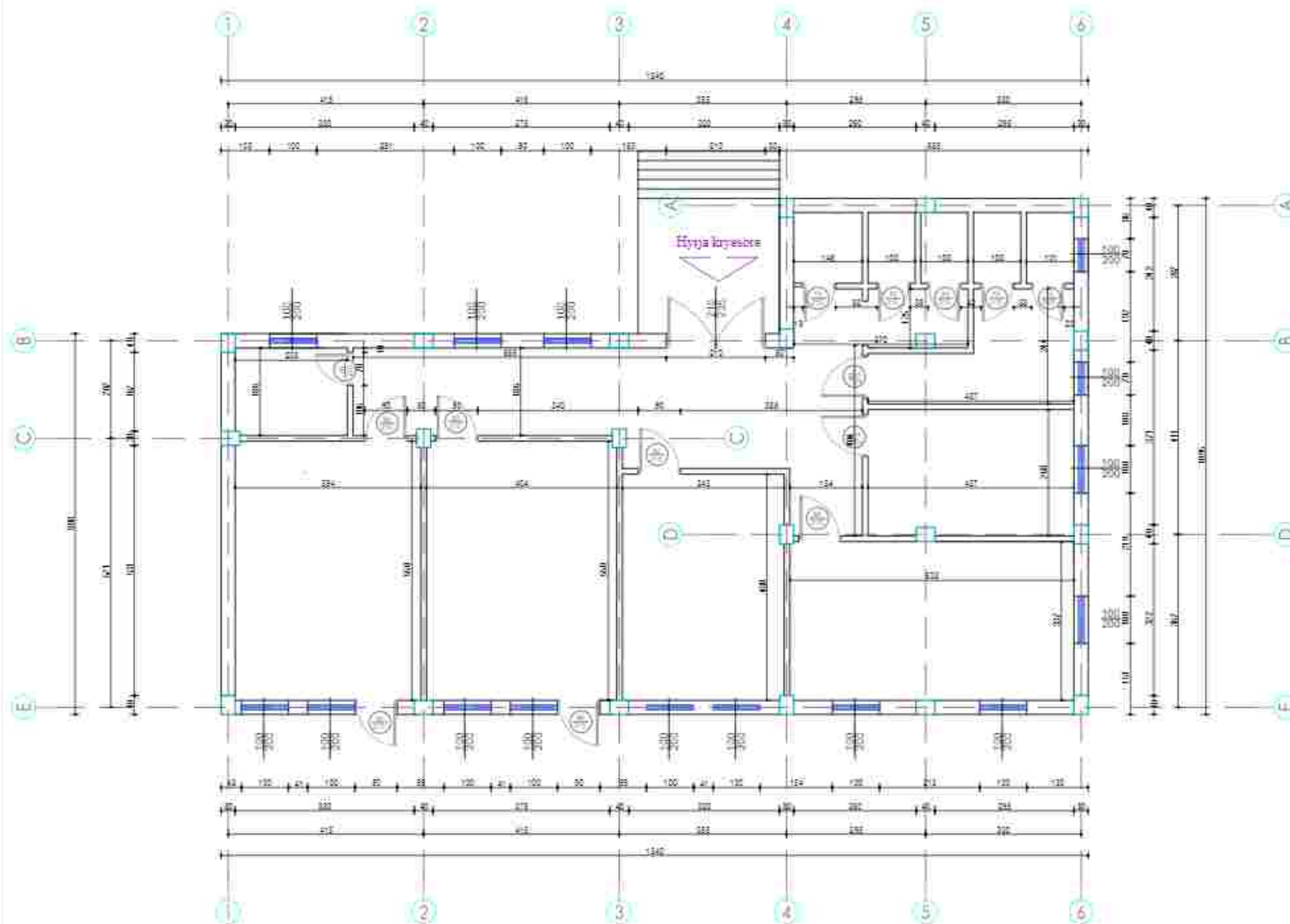

SHprehja (FLETES):
PLANI I DIMENSIONUAR KATI PERDHE (KOPSHTI)

PROJEKTI (KLENTI):

PROJEKTOR:

"A.S.H. ENGINEERING" sh.p.k



INDIVIDUALI & SHPËRITËT PËNËN

PLANI I MOBILIMIT KATI PERDHE (KOPSHTI)

REPUBLIKA E SHQIPERISE



BASHKIA E DIBRES

ALBERT BASHKIA E DIBRES

PROJEKTI

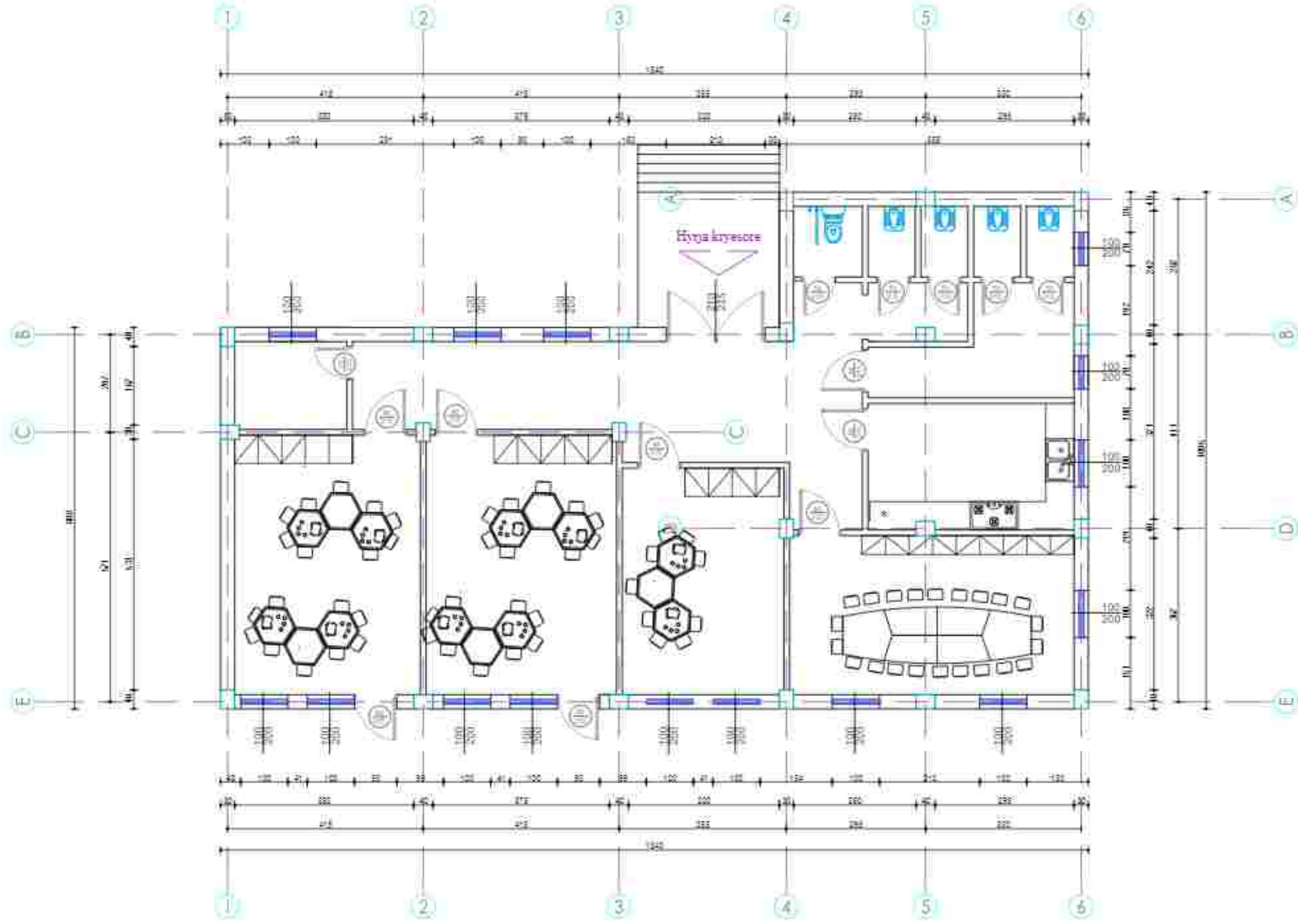

SHKURTIM / FLETES:
 PLANI I MOBILIMIT KATI PERDHE (KOPSHTI)

ARSHI / GJURIMI:

PROJEKTOR

"A.S.H. ENGINEERING" sh.p.k



REDOCTURA E PLANIT PESH

FASADA VERIORE

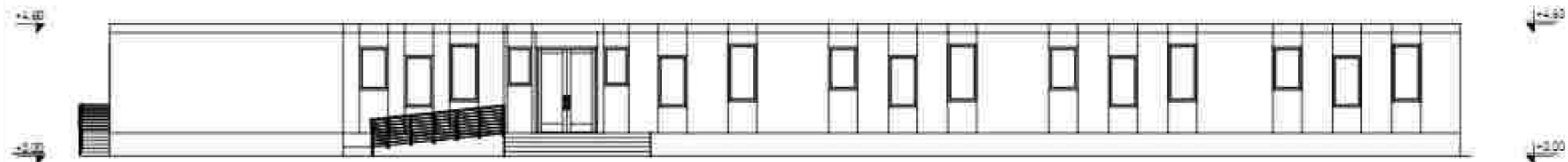

REPUBLIKA E SHQIPERISE



BASHKIA PEQIN

KU ENË BASHKIA PEQIN

PROJEKTI

SHËRTELË I FLETËS
PAGADAT

SHËRTELË I KUQIT

PROJEKTUESI

"A. SH. ENGINEERING" sh.p.k



TEKNOLOGJIA E QENDRIT PEQIN

FASADA JUGORE

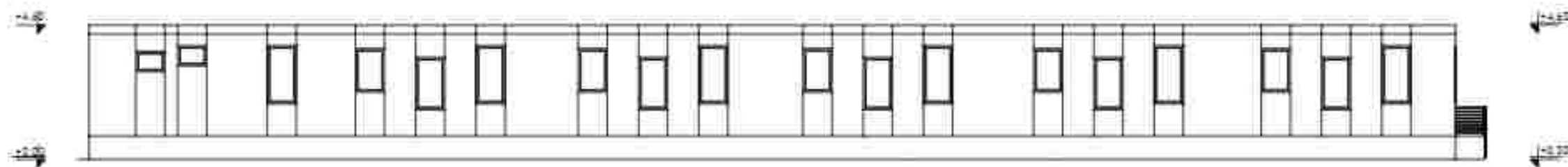

FASADA PERENDIMORE

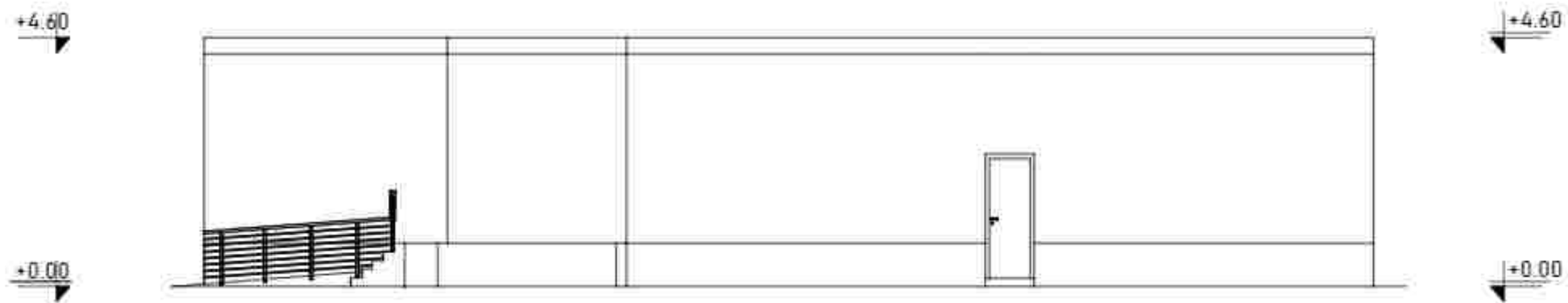

FASADA LINDORE

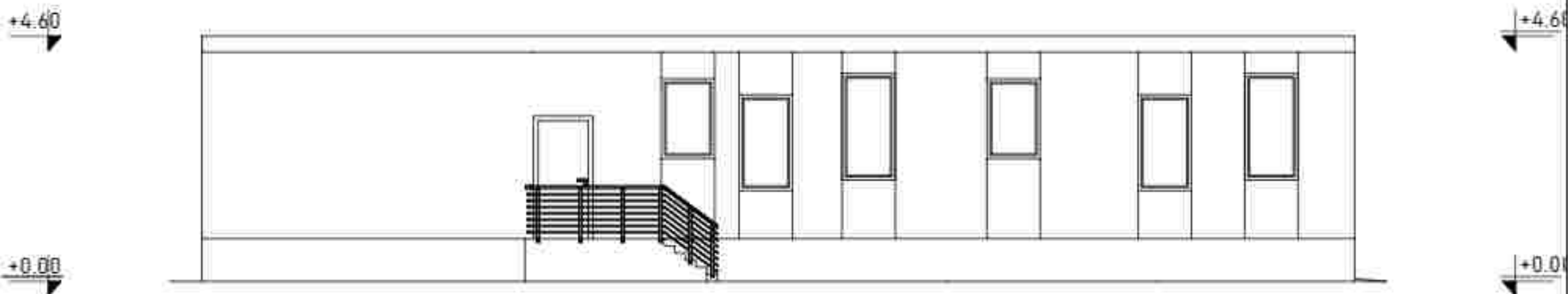

REPUBLIKA E SHQIPERISE



BASHKIA E PEQIN

PL. ENTEBASHIA E PEQIN

PROJEKT:

SHËRTHIM I PLETES
FASADAT

ARZIMI I GJERTYR

VEPËRTORE:

"A. SH. ENGINEERING" sh.p.k



VEPËRTORESI E VEPRITVE E PEQIN

PRERJET

REPUBLIKA E SHQIPERISE



BASHKIA PEQIN

KLIENTI: BASHKIA PEQIN

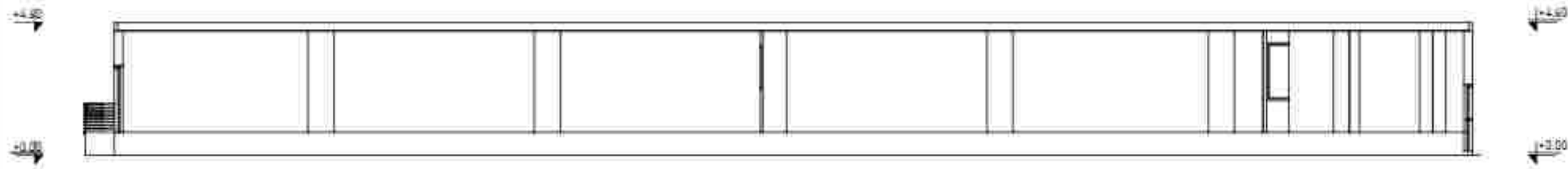

PRILEJT:

SHENJTIH (KURTES)
PRERJET

PROJEKTI (KURTES)

PROJEKTUES:

"A. SH. ENGINEERING" sh.p.k



VERIFIKUESI (KURTES) PEDIN

+4.60

+0.00

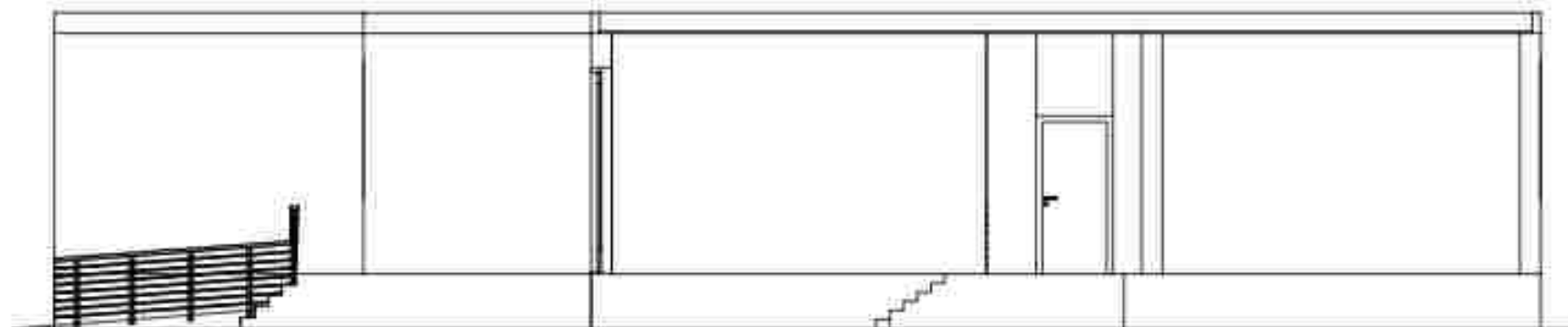

+4.60

+0.00

FASADA JUGORE

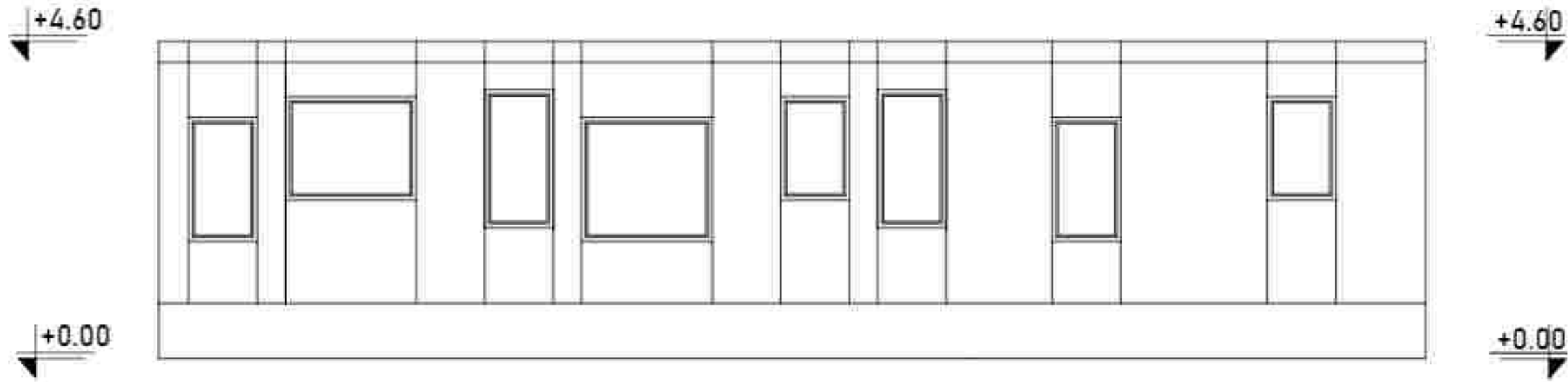

REPUBLIKA E SHQIPERISE



BASHKIA PEQIN

KU EHT BASHKIA PEQIN

PROJEKTI

EMERTIMI I PLOTESI
FASADAT

ARZIMI I KUQIT

PROJEKTUESI

"A. SH. ENGINEERING" sh.p.k



TEKNOLOGJI E QALITETI PEQIN

FASADA VERIORE

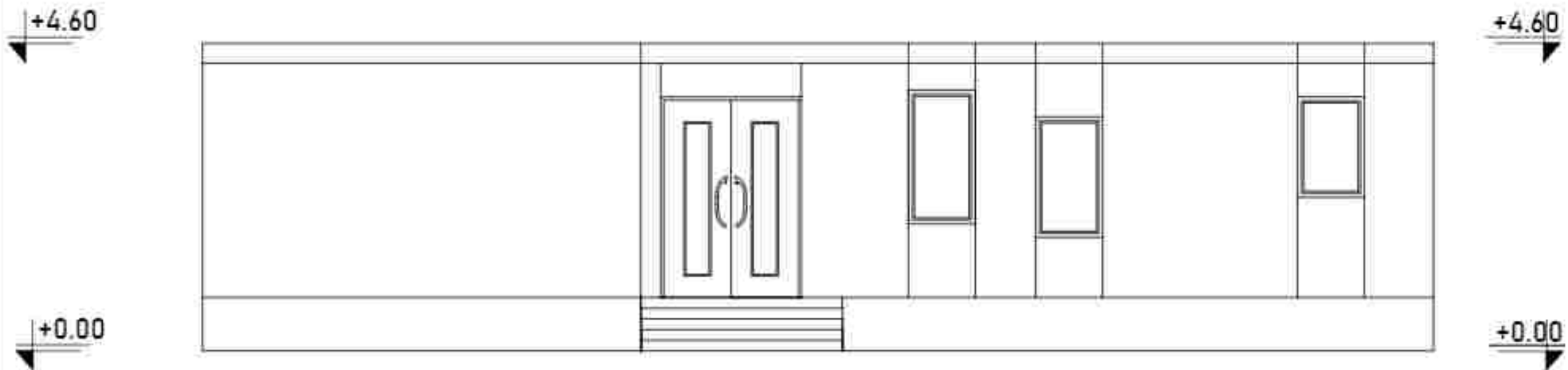

FASADA LINDORE

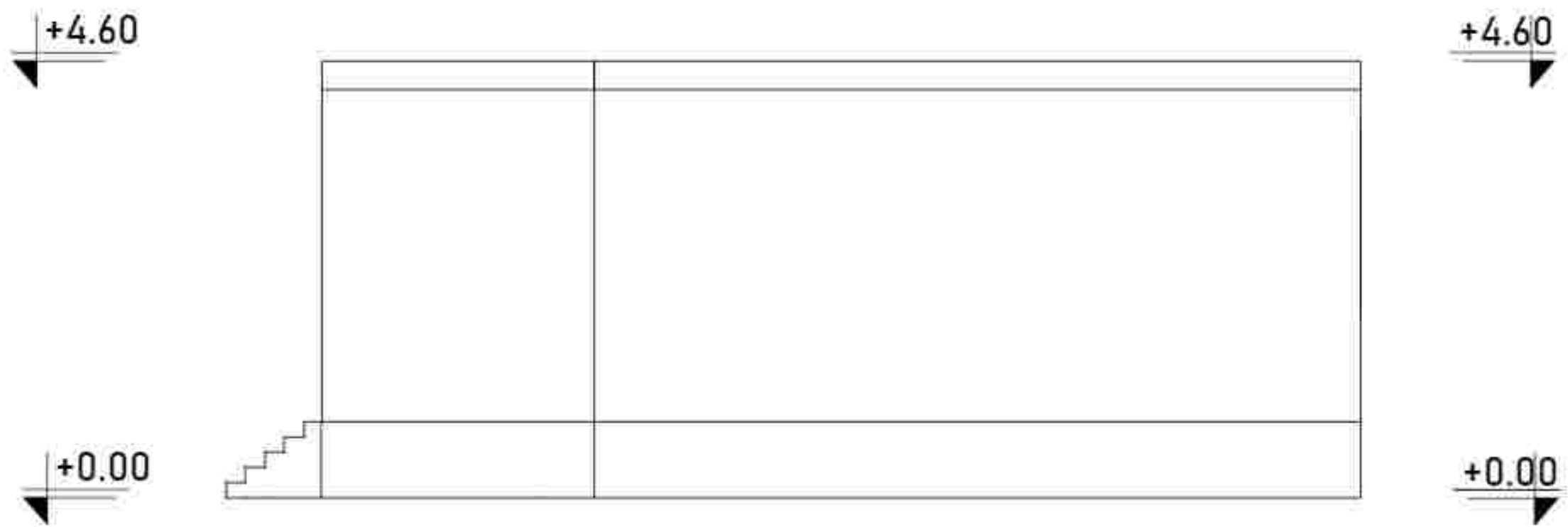

FASADA PERENDIMORE

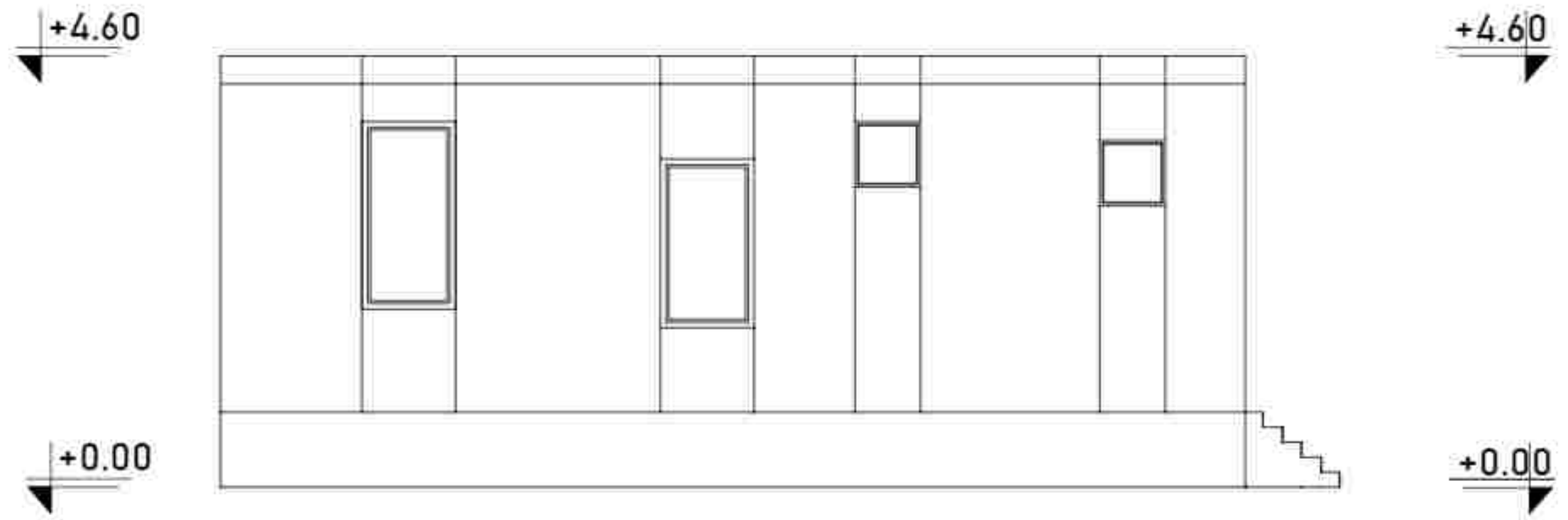

REPUBLIKA E SHQIPERISE



BASHKIA PEQIN

NUMER BASHKIA PEQIN

PROJEKT

EMERTIMI / FLETES
FASADAT

IPROJEKTOR / KREJTTOR

SHËNIMET

"A. SH. ENGINEERING" sh.p.k



VERIFIKUESI / KREJTTOR

PRERJET

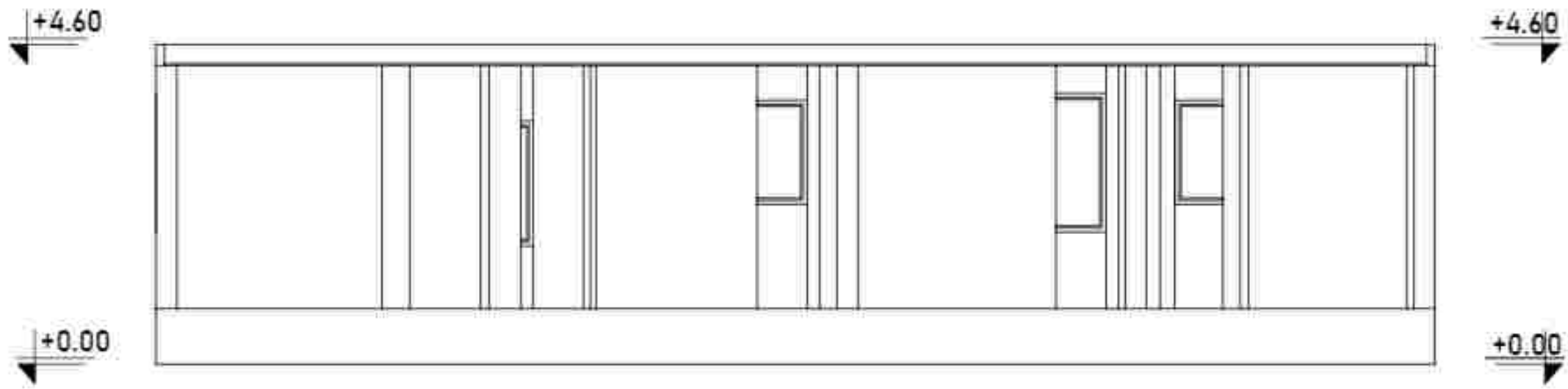

REPUBLIKA E SHQIPERISE



BASHKIA PEQIN

KLENTI BASHKIA PEQIN

PRERJET

SHËRTIMI (KURTES)
PRERJET

PROJEKTI (KURTES)

PROJEKTUESI

"A. SH. ENGINEERING" sh.p.k



VERIFIKUESI & QILIBITTA PESH

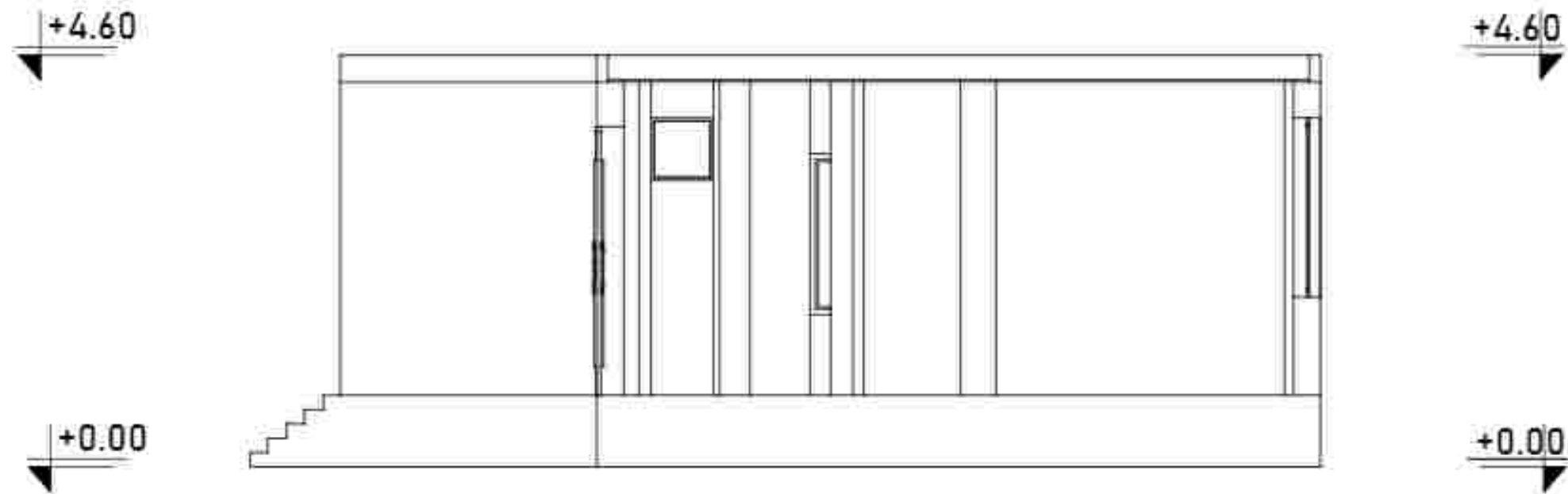



PARALELE DYSHE TOTALI 4 COPE

PARALELE

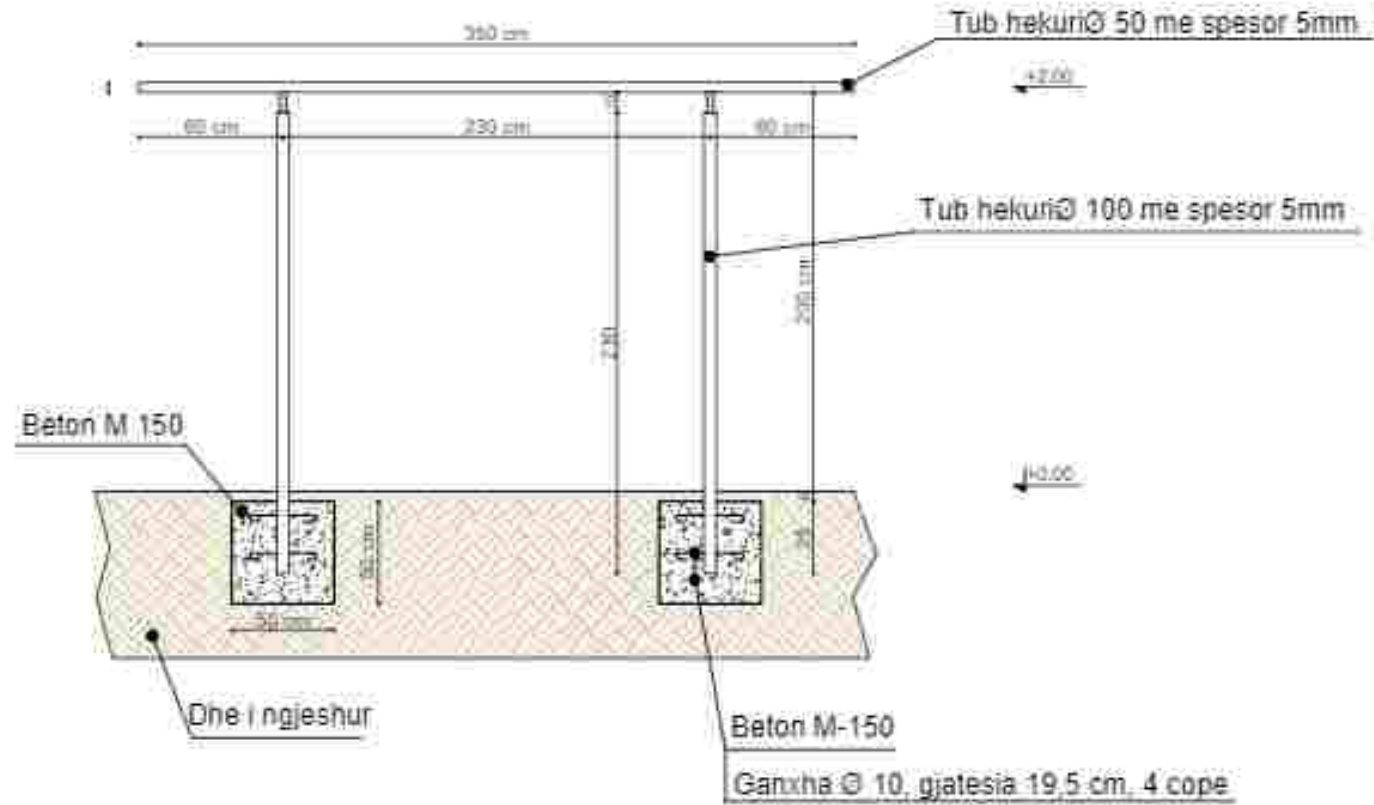

PARALELE

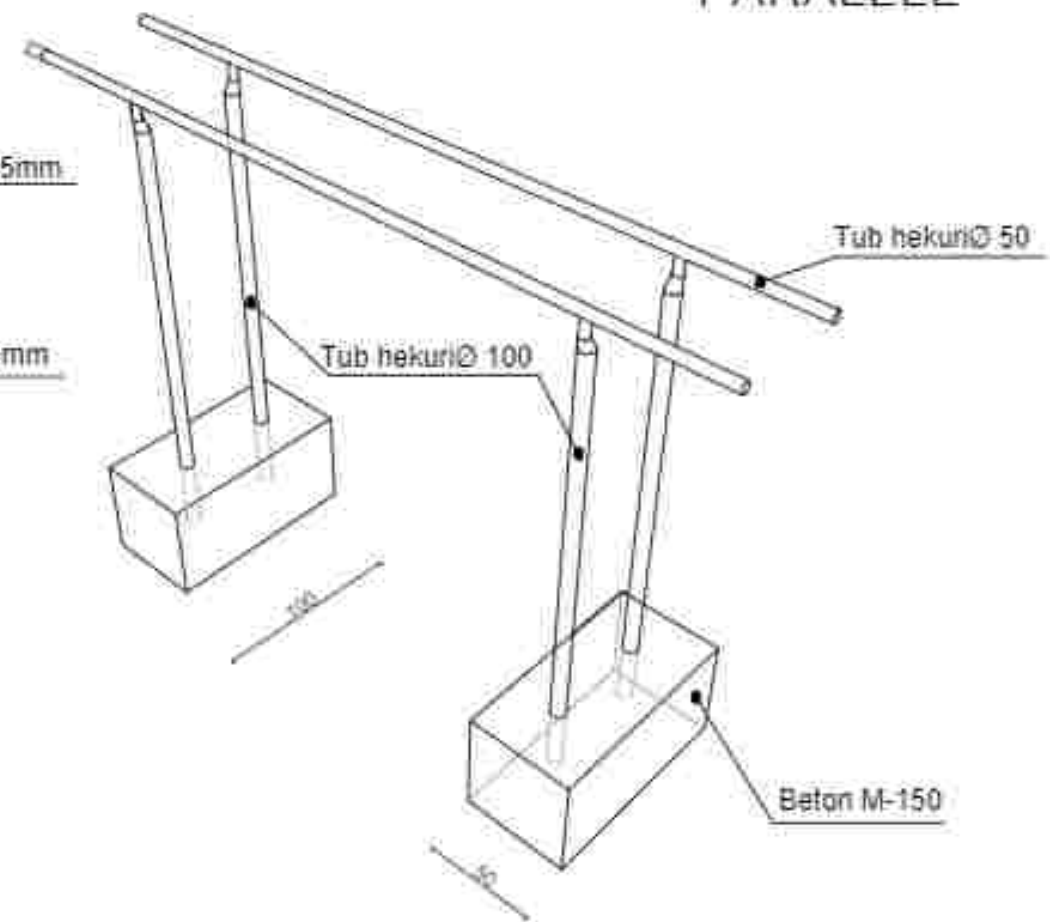

ENJERIT/MI I FLETËS
PËRRENET SPORTIVE

LABORIMI - ALBANI

PROJEKTIM

"A.S.H. ENGINEERING" sh.p.ë



SHKURTORI I BASHKIMIT



DETAJE TE VEGLAVE GJIMNASTIKORE

PARALELE E SHKALLEZUAR

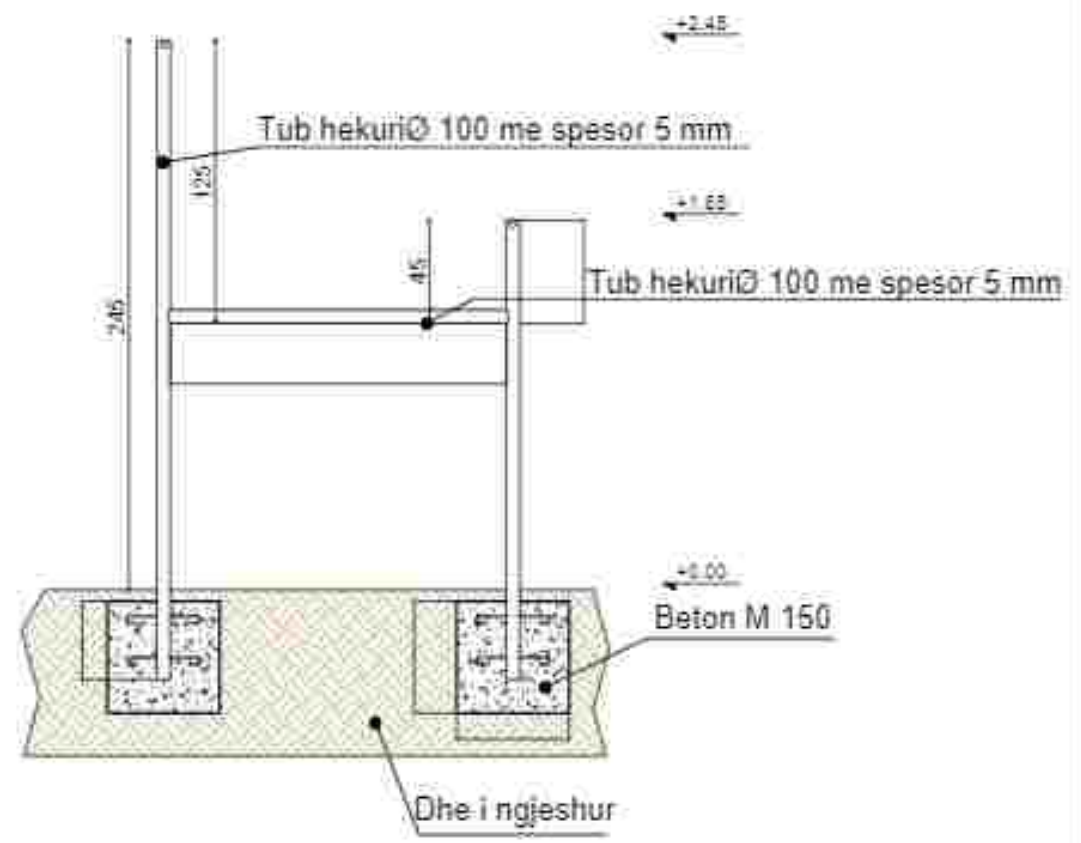
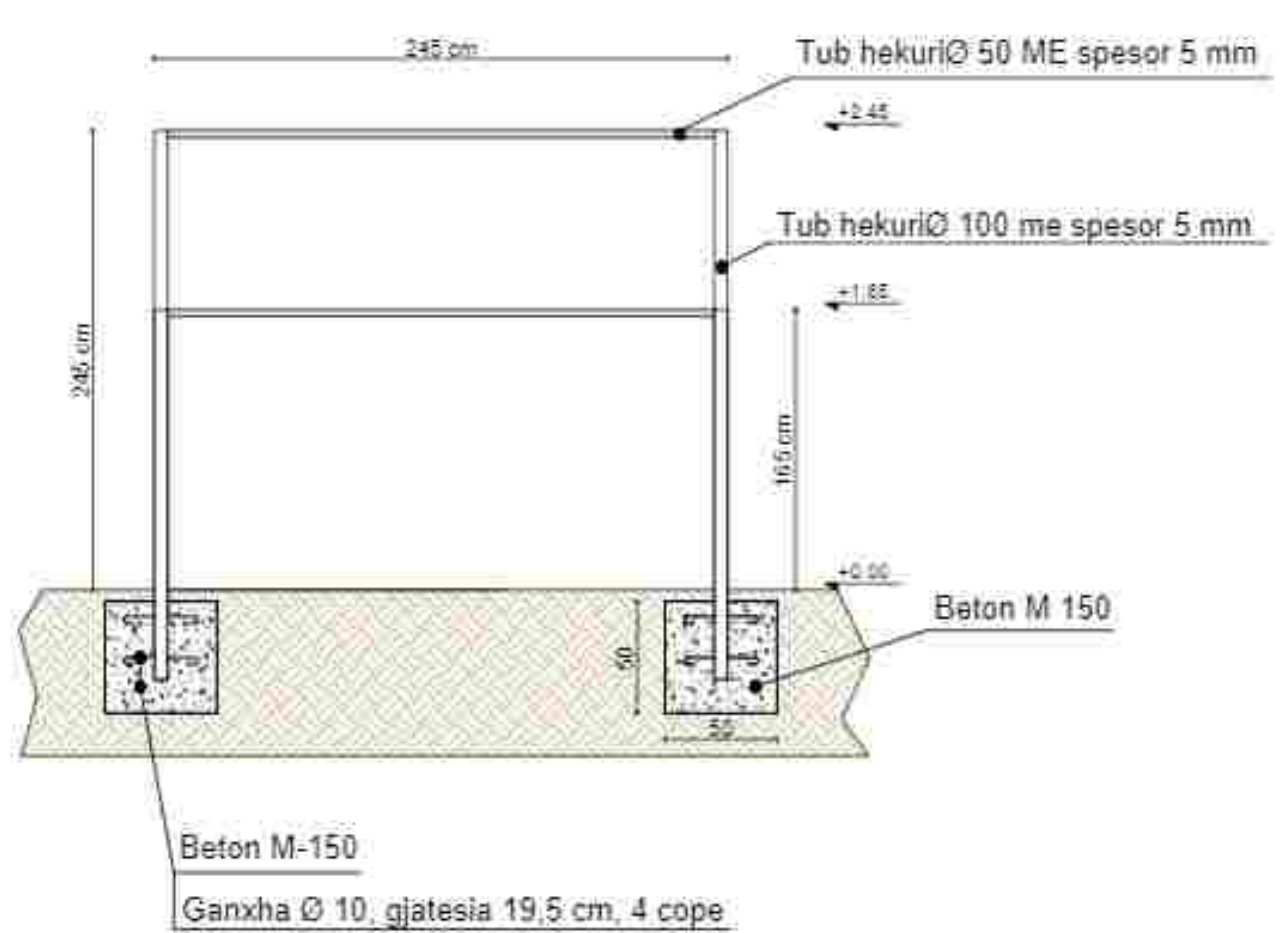

SHKURTIM: PLETES
TERRENI: SPORTIVE

ARSHITIM (SCALE):

PROJEKTOR:

"ASH. ENGINEERING" sh.p.k



VERIMORJA E SHKURTIT PLOTES



DETAJE TE VEGLAVE GJIMNASTIKORE

PARALELE

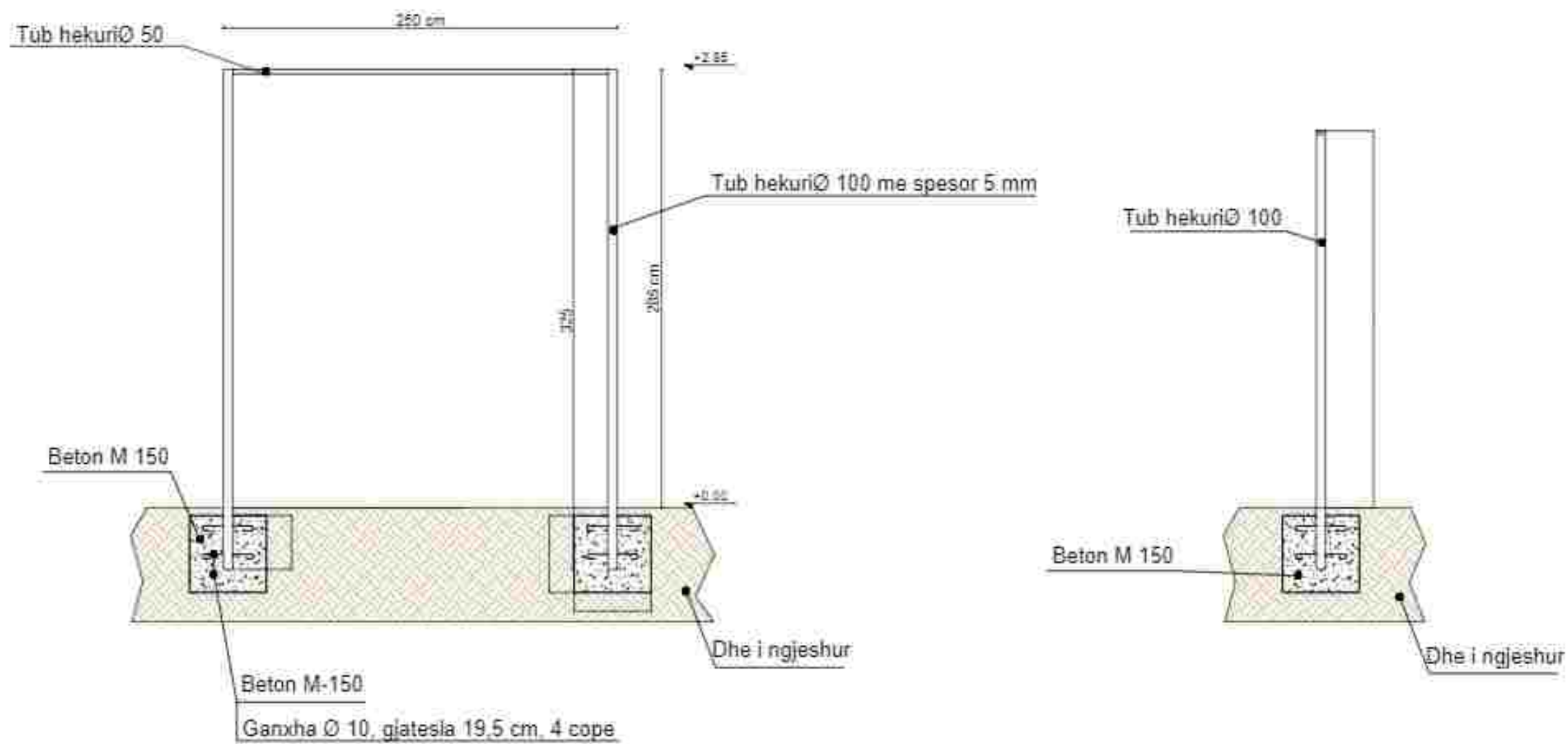

ENERJHI I PUSTES
TERRENET SPORTIVE

PROJEKTI KLINT

PROJEKTI

"A.S.H. ENGINEERING" sh.p.k



INDUSTRIAL & RESIDENTIAL



DETAJE TE VEGLAVE GJIMNASTIKORE

PARALELE NE SHKALLE SUEDEZE

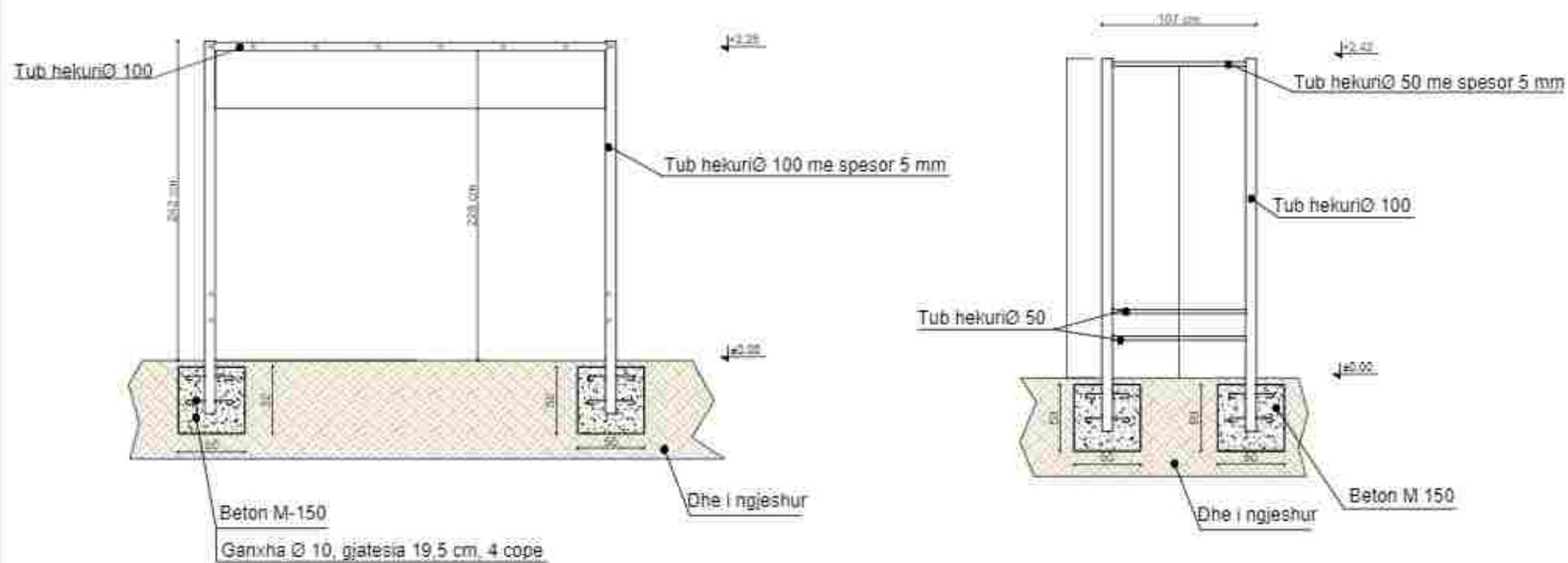

SHKURTIM I PLETES
TERRENET SPORTIVE

PROJEKTOR I ALBANTE

PROJEKTOR

"A. SH. ENGINEERING" sh.p.k



SHKURTIM I GJITHSHEJTE



DETAJE TE VEGLAVE GJIMNASTIKORE

TRAU I EKUILIBRIT

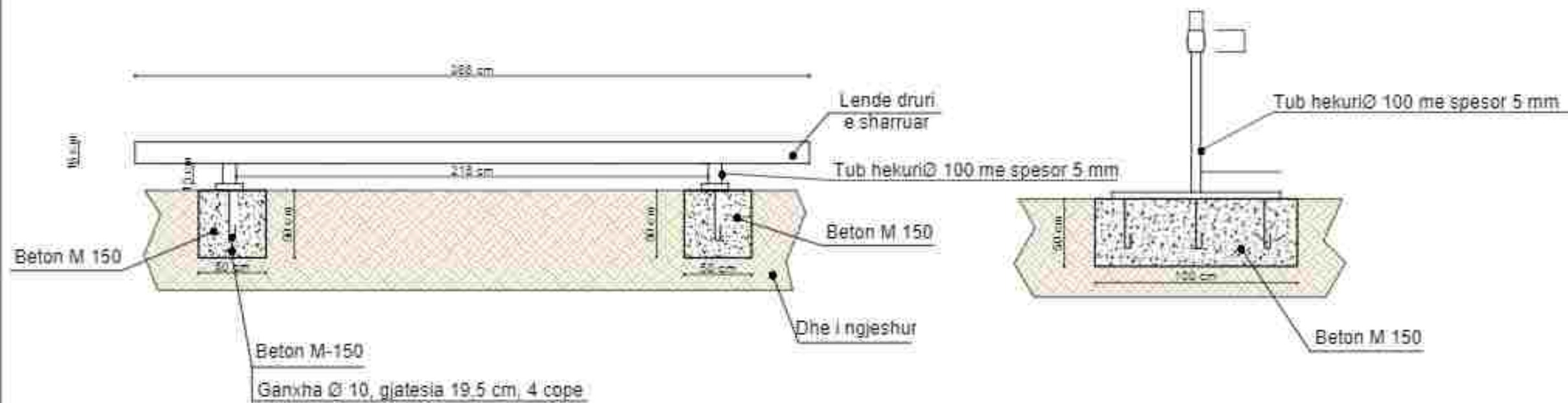

ENERJTI I FLETËS
TERRENET SPORTIVE

IPROJEKTU I KLASIFIKU

PROJEKTOR

"A. SH. ENGINEERING" sh.p.k



INDHODHJA E DOKUMENTIT



PARALELE DYSHE TOTALI 4 COPE

PARALELE

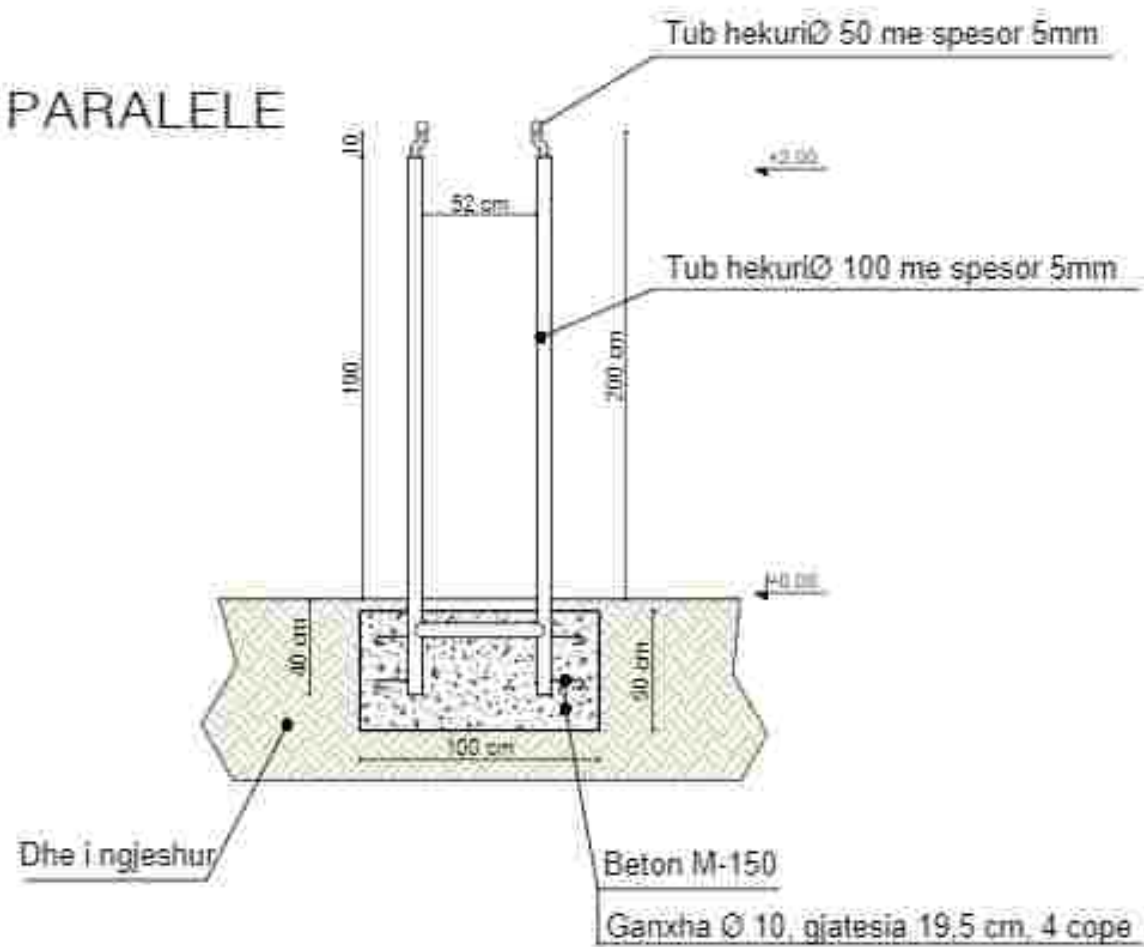

PARALELE

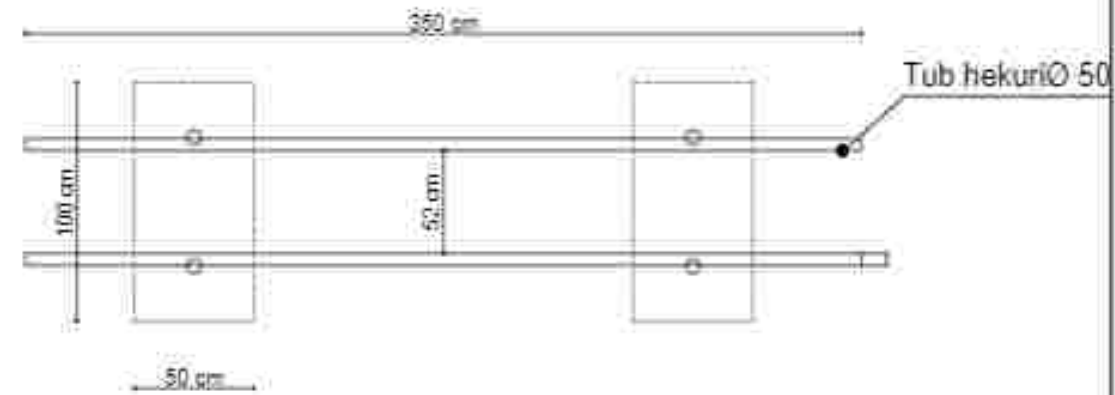

SHËRITHE (PLANET):
TERRENET SPORTIVE

ARSHI (KARTË):

POSITIMI

"A. SH. ENGINEERING" sh.p.k



INDIKIMI I KUJENTËSHKIMIT



DETAJE TE VEGLAVE GJIMNASTIKORE

PARALELE E SHKALLEZUAR

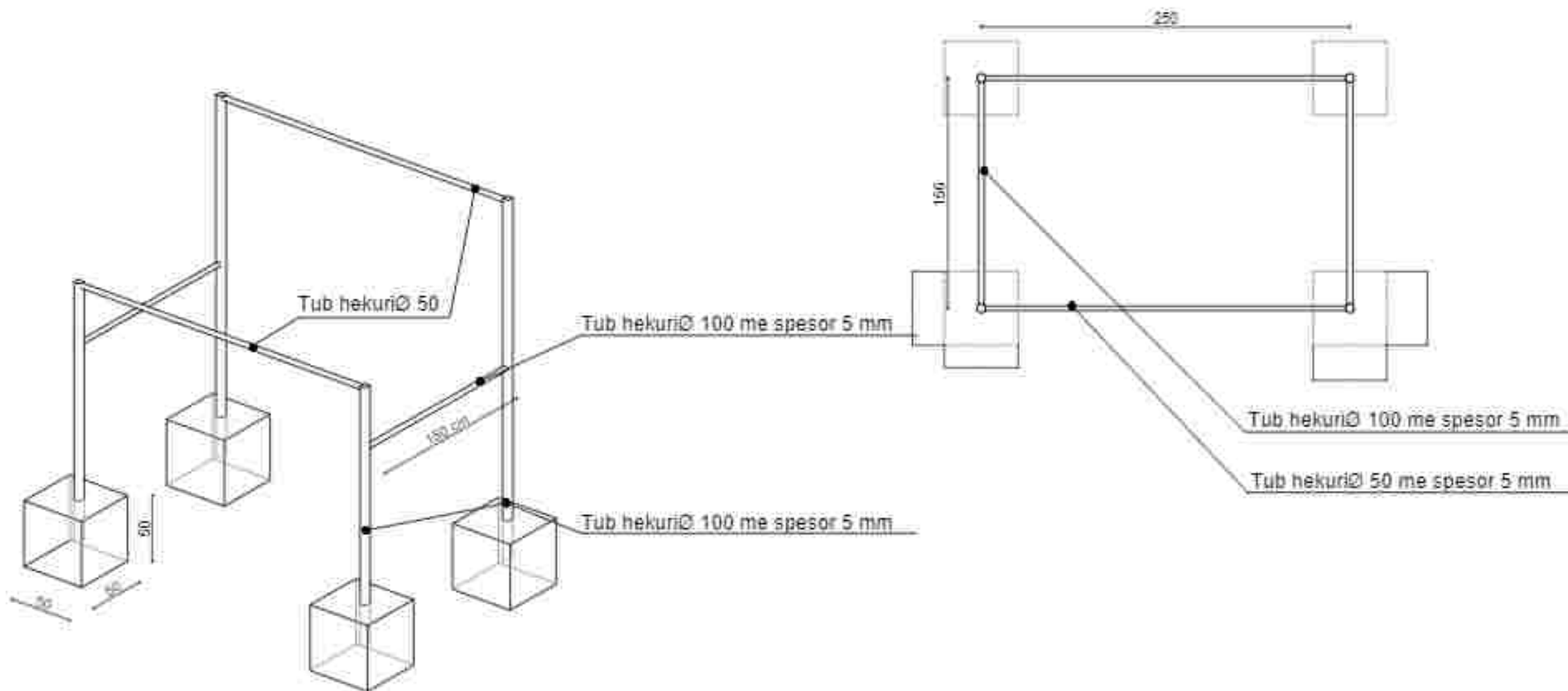

SHKURTIM / PLETESI:
TERRENET, SPORTIVE

ARBITRI / KLINT:

PROJEKTUAR:

"A.S.H. ENGINEERING" sh.p.k



SHKURORTJA E QELBETIT/PECIN



DETAJE TE VEGLAVE GJIMNASTIKORE

PARALELE

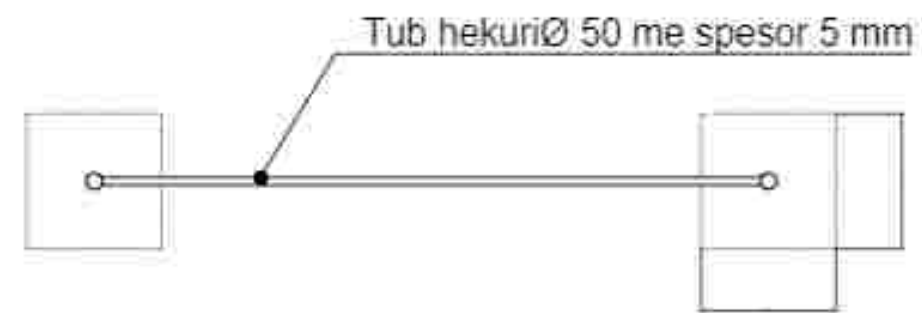
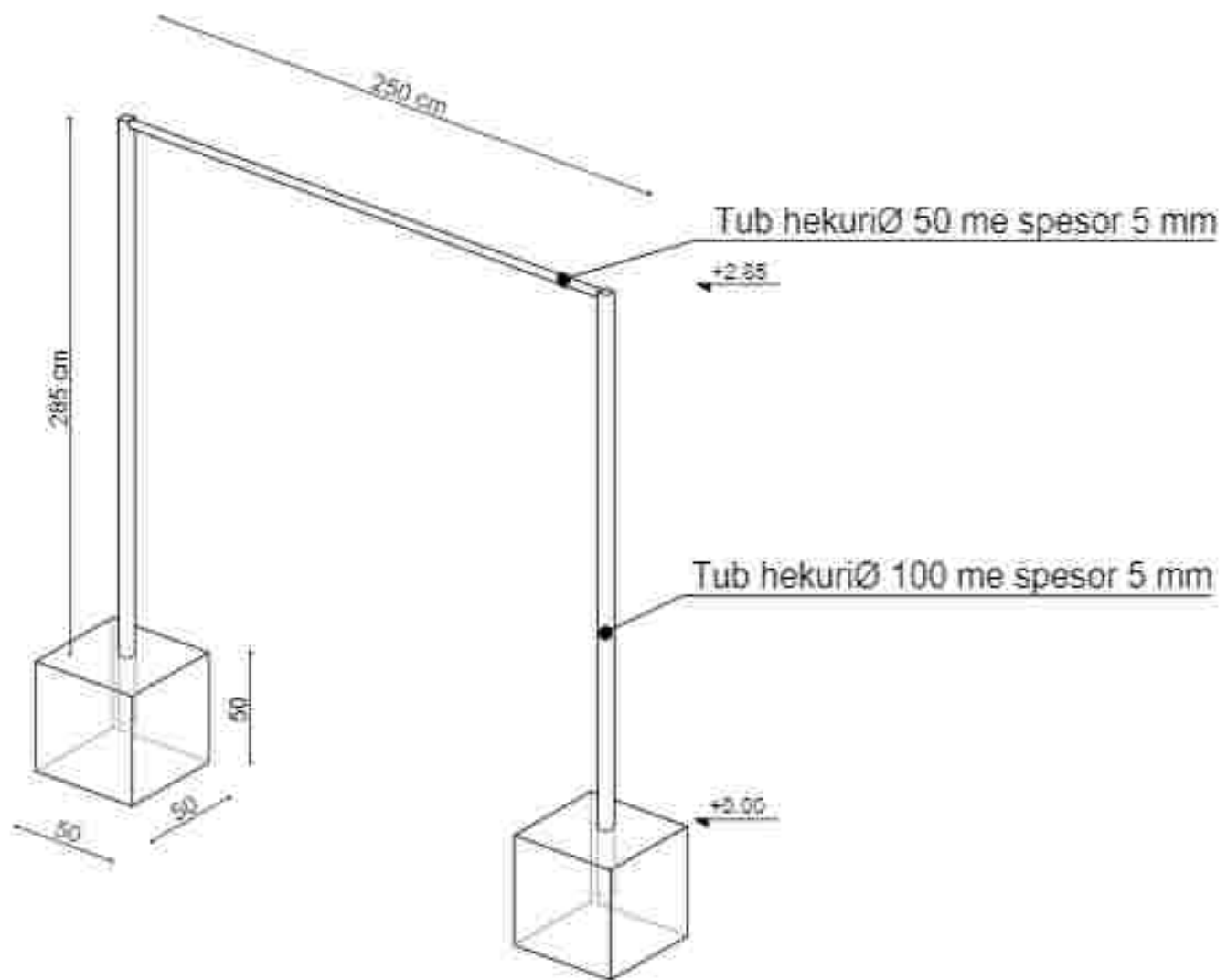

ENERJTI I PLETËS
TERRENET SPORTIVE

ARCHIT. KLINT

PROJEKTOR

"A. SH. ENGINEERING" sh.p.k



TEKNIKALIA E KLINT BASHKIA E DIBRËS



DETAJE TE VEGLAVE GJIMNASTIKORE

PARALELE NE SHKALLE SUEDEZE

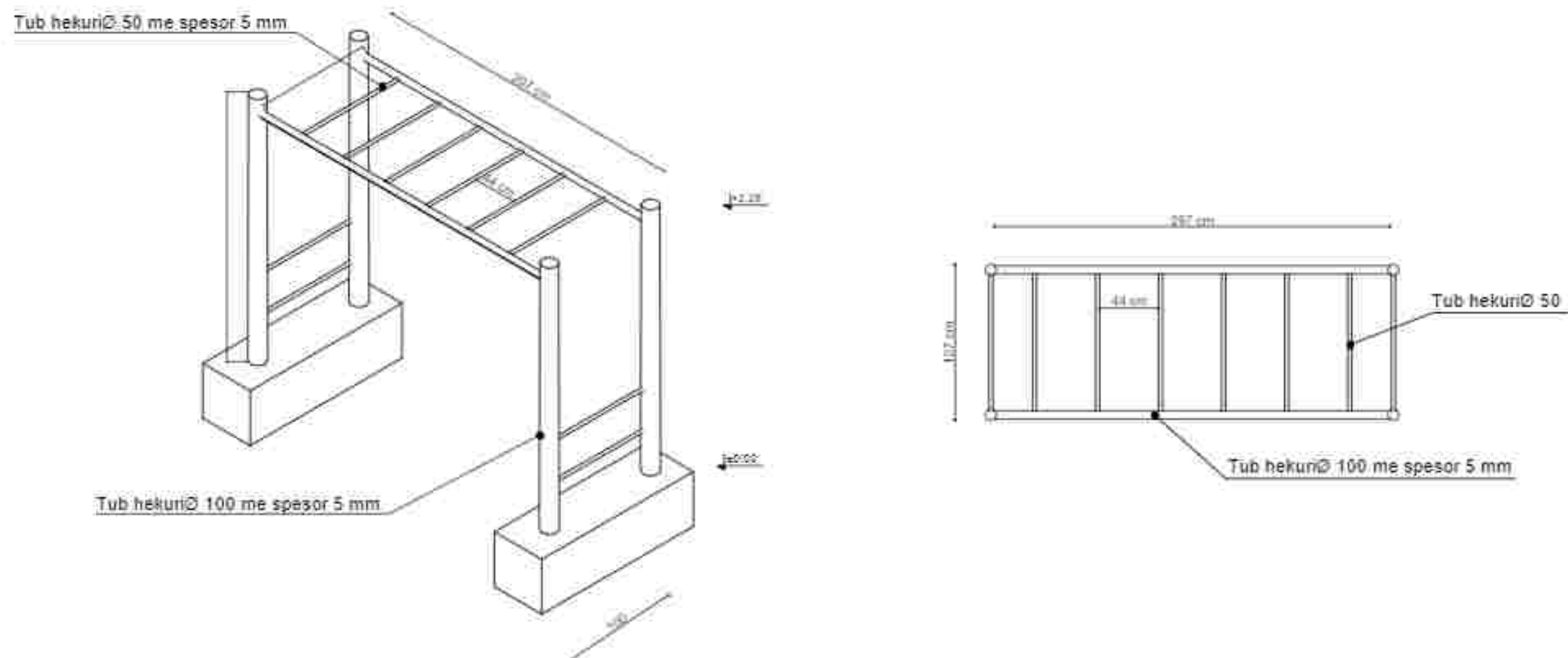

SHIPTIMI I KULETES
TERRENETI: SPORTIVE

ADRESH I LOKUTIT:

REGJITUR:

"A.SH. ENGINEERING" sh.p.k.



REMBORSA & SHIPTIMI PELA



DETAJE TE VEGLAVE GJIMNASTIKORE

TRAU I EKUILIBRIT

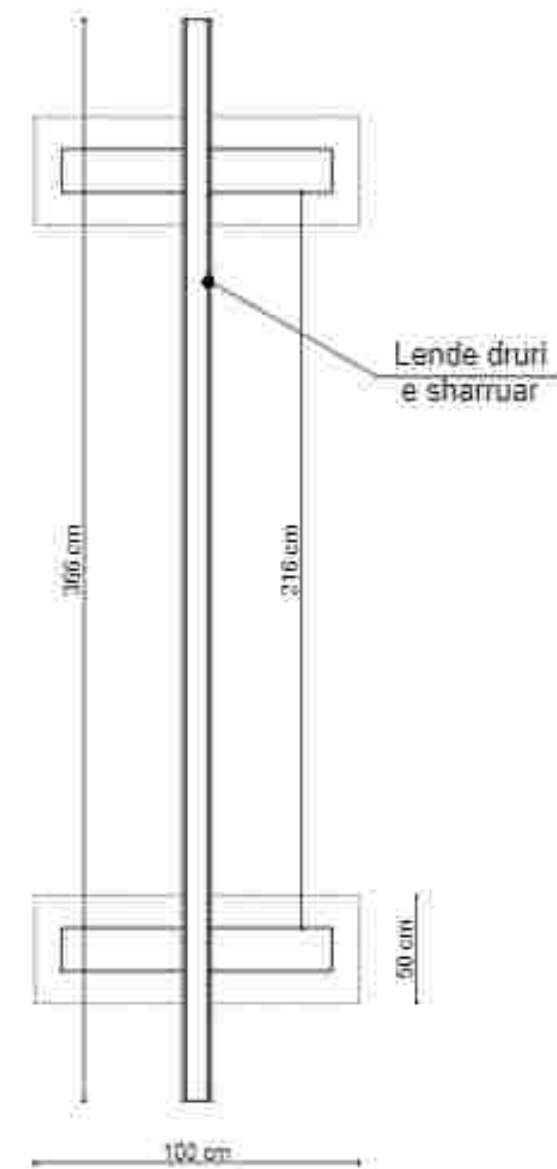
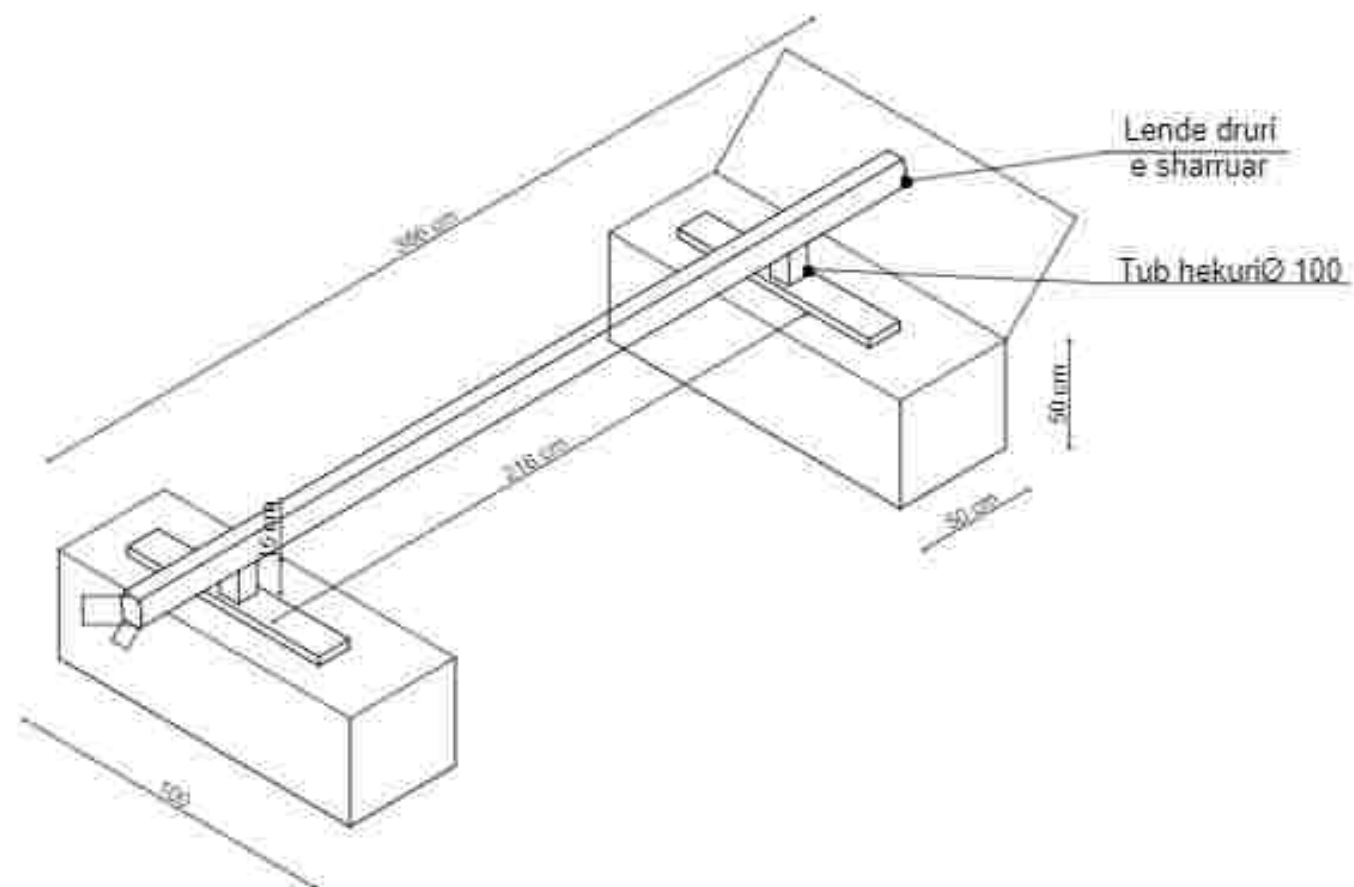

SHËRTIMI / FLETES
TERRENET SPORTIVE

ARREHI / KLIENTI

PROJEKTUAR:

"A.S.H. ENGINEERING" sh.p.k



NDORRUESI / BASHKIA PEQIN



DETAJE TE KOSHIT TE BASKETBOLLIT DHE PORTAVE TE MINIFUTBOLLIT

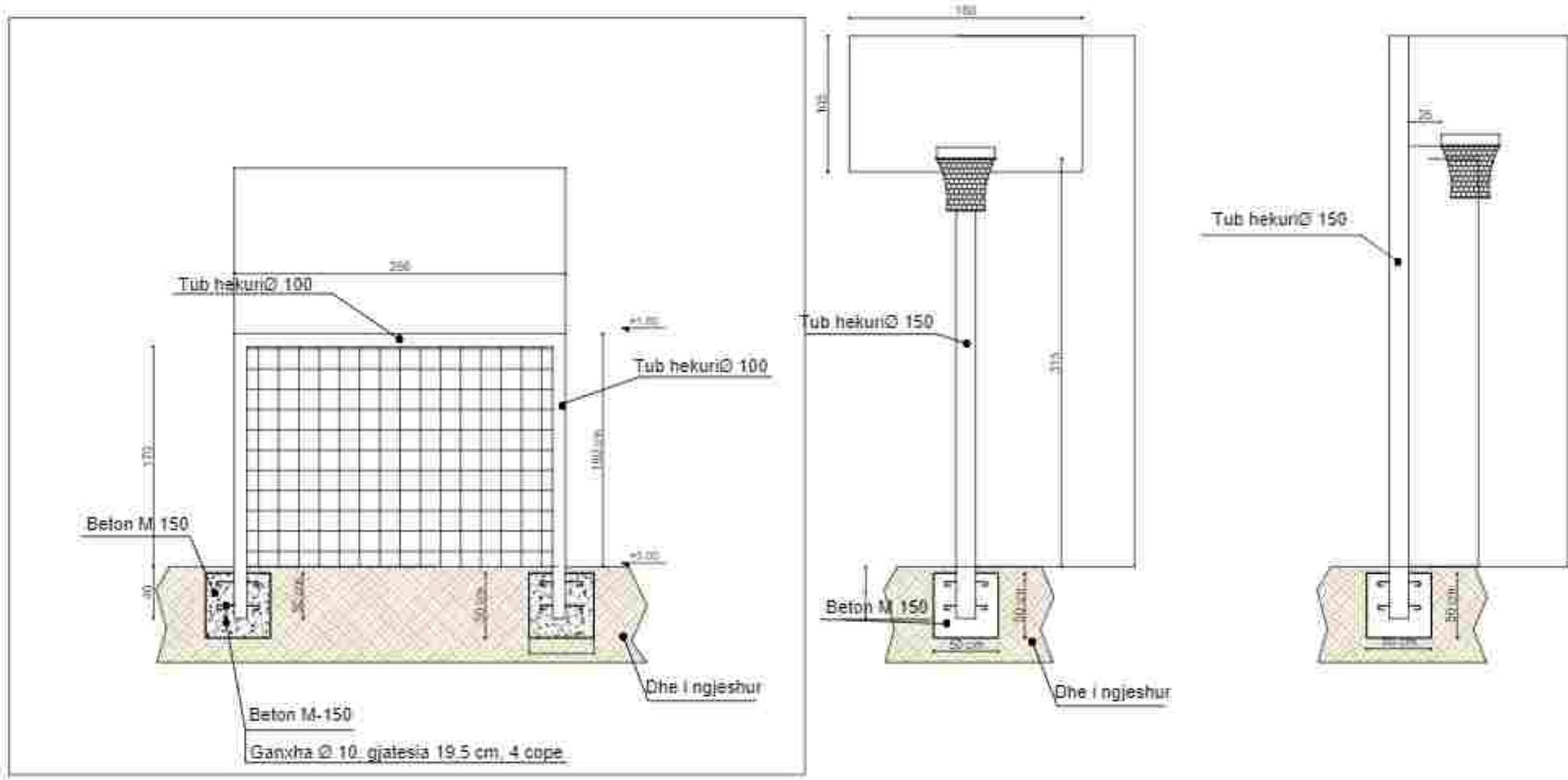

SHËRTIMI / PLETES
SPORTIVET

ARRITJE / KALITET

PROJEKTOR

"A.S.H. ENGINEERING" sh.p.k



INDIKUESI E SHËRTIMIT

PRERJET A DHE B E FUSHES TIP SE MINIFUTBOLLIT

SHKOLLA SHEZE

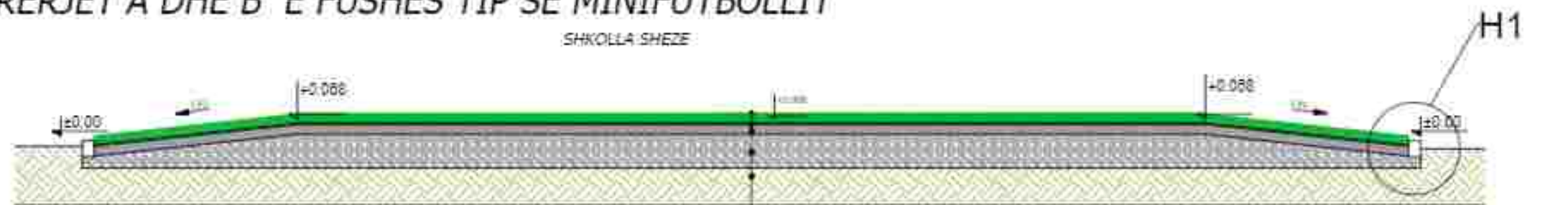

PRERJA A

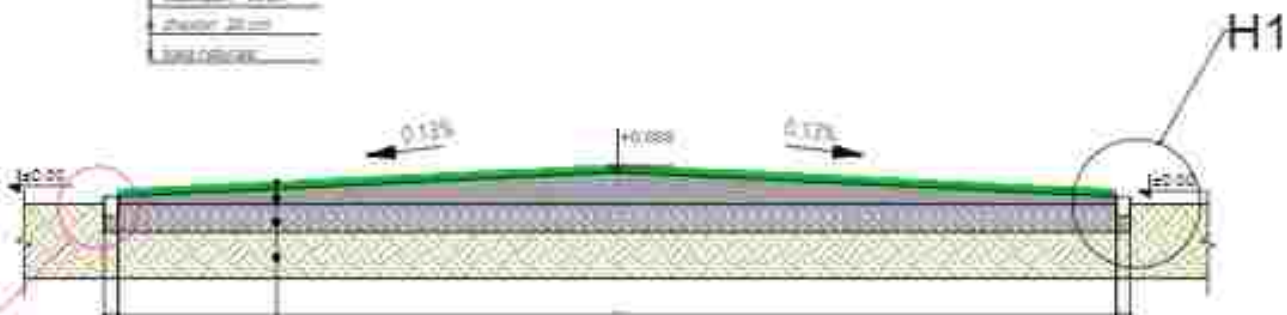

PRERJA B

RRETHIMI TERTHORE I FUSHAVE

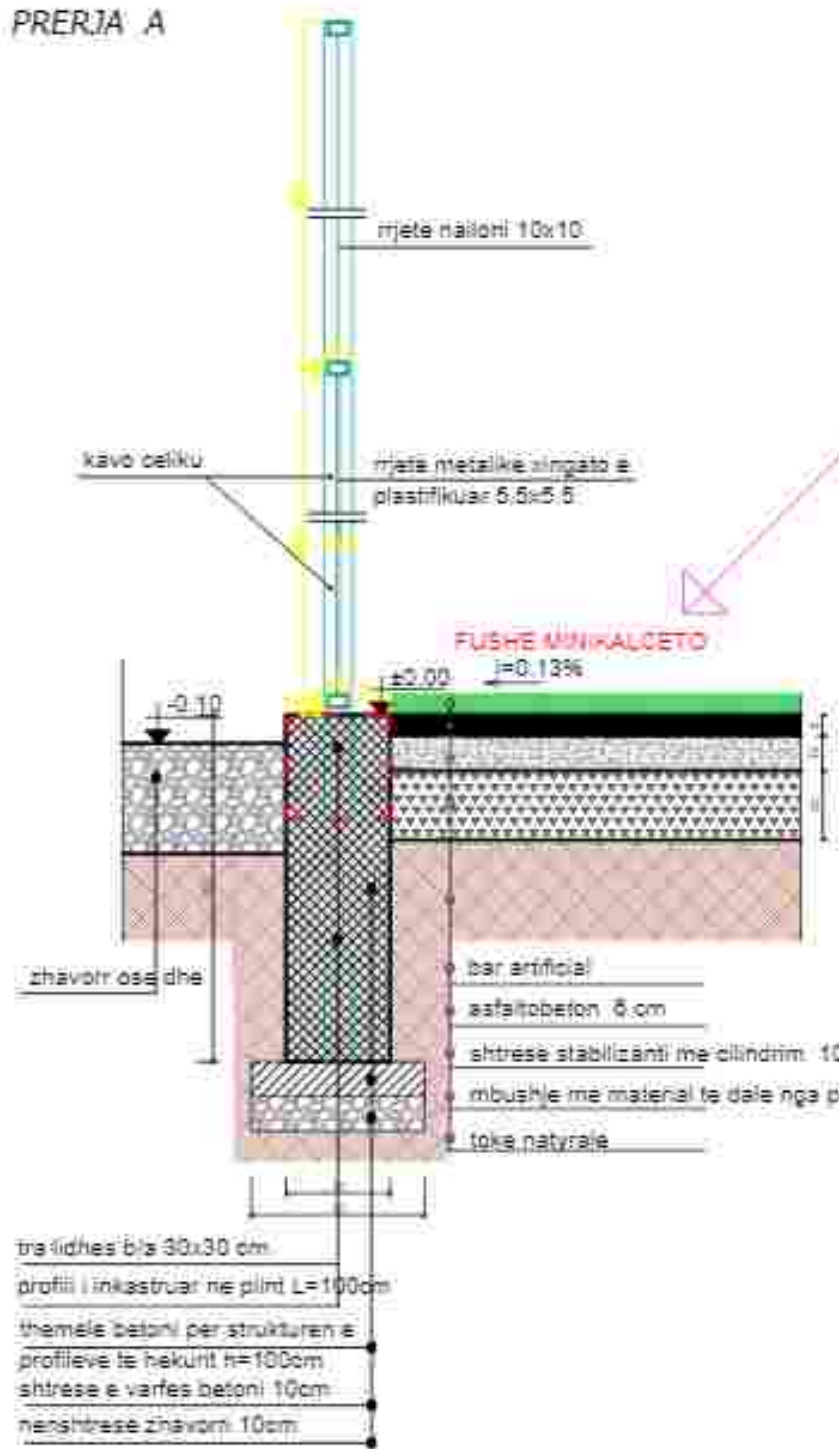
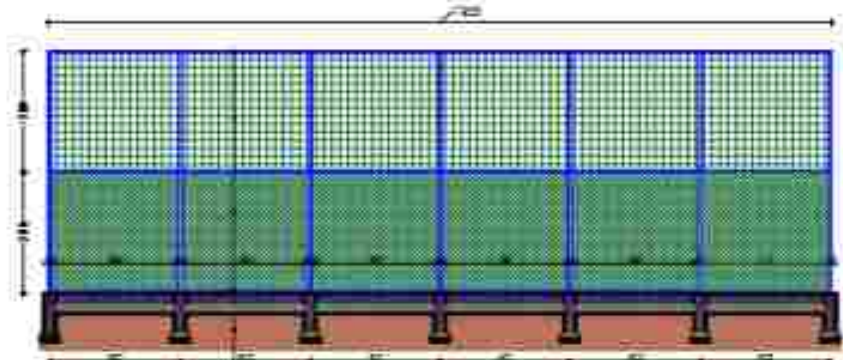

FUSHI MINIKALCETO

±0.00

±0.13%

bar artificial

asfaltobeton 8 cm

shtrase stabilizanti me cilindrim 10 cm

mbushje me material te dale nga prishjet 20 cm

toka natyrale

tra lidhes 6/6 30x30 cm

profili i inkastruar ne plini L=100cm

themele betoni per strukturen e

profileve te hekurti h=100cm

shtrase e varfes betoni 10cm

nenshtrese zhavori 10cm

REPUBLIKA E SHQIPERISE



BASHKIA PEQES

ELI ENI BASHKIA PEQES

PROJEKTIM I TERRENET SHKOLLESH MINIFUTBOLLORE SHEZE

ENERJTHI I FLETES
TERRENET SHKOLLESH

PROJEKTIM I FLETES

REKREATIVE

"A.S.H. ENGINEERING" sh.p.k



SHKOLLA E SHKOLLESH PEQES



PRERJET A DHE B E FUSHES TIP SE BASKETBOLLIT

SHKOLLA SHEZE

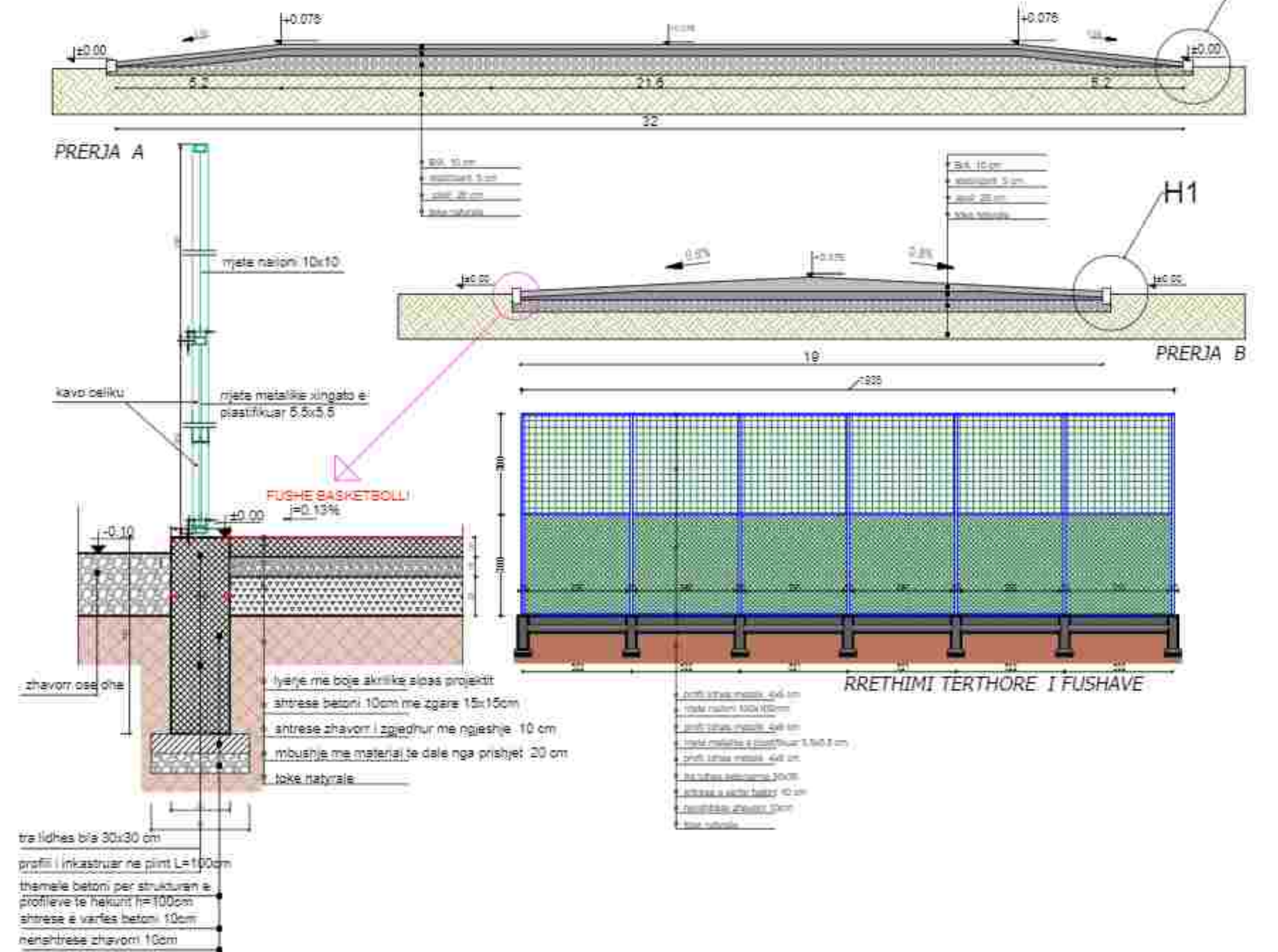



Plinti betonit 30x30x100cm per inkastrimin e profilit

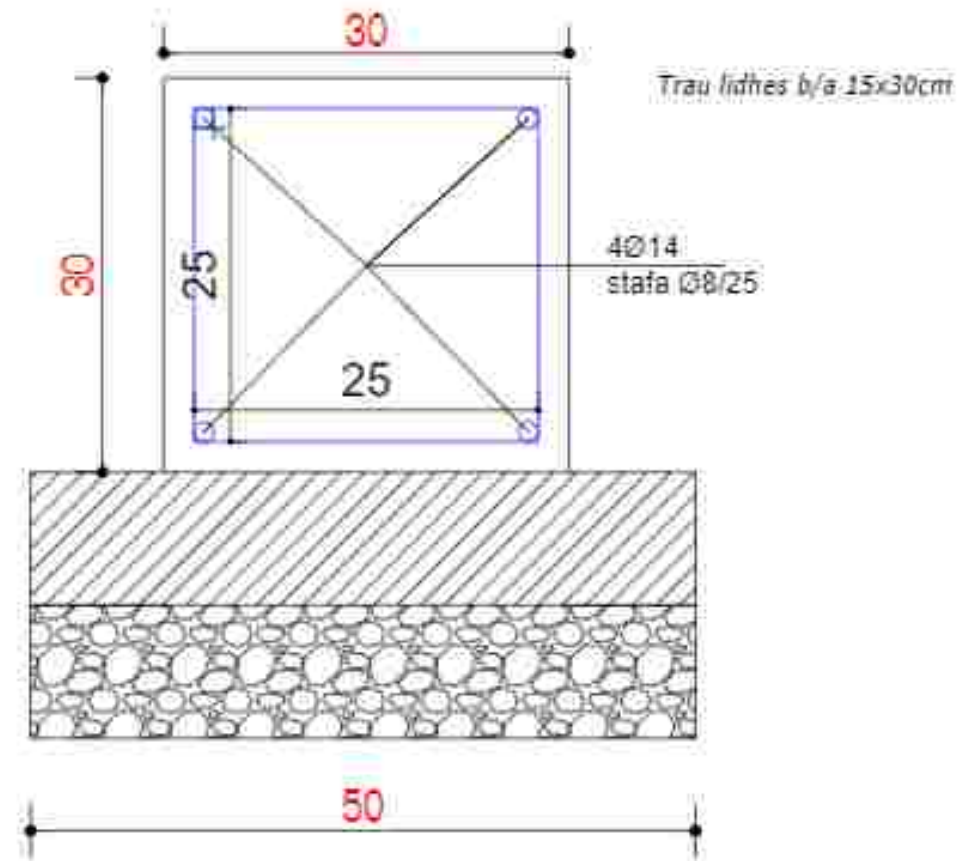
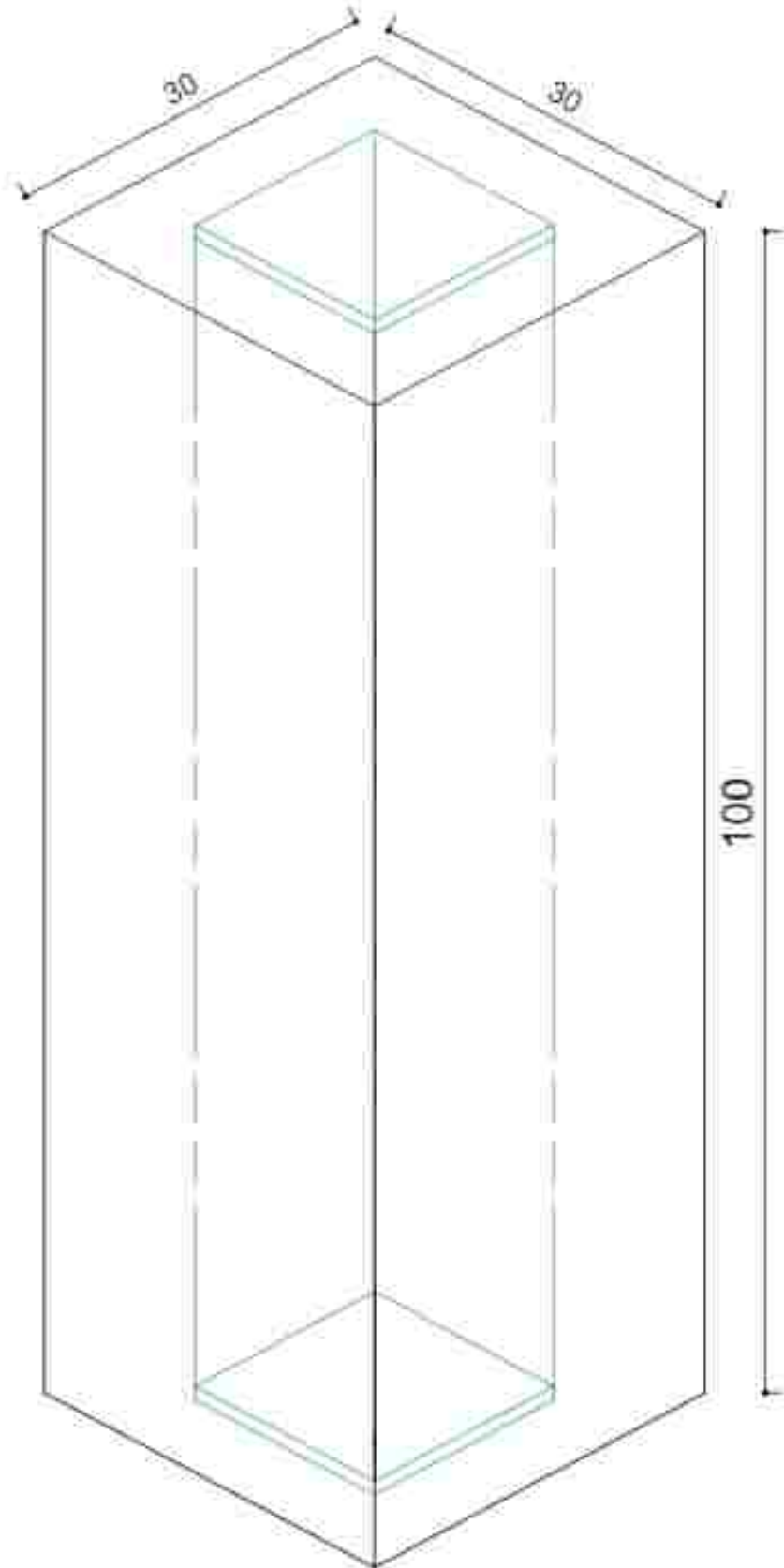

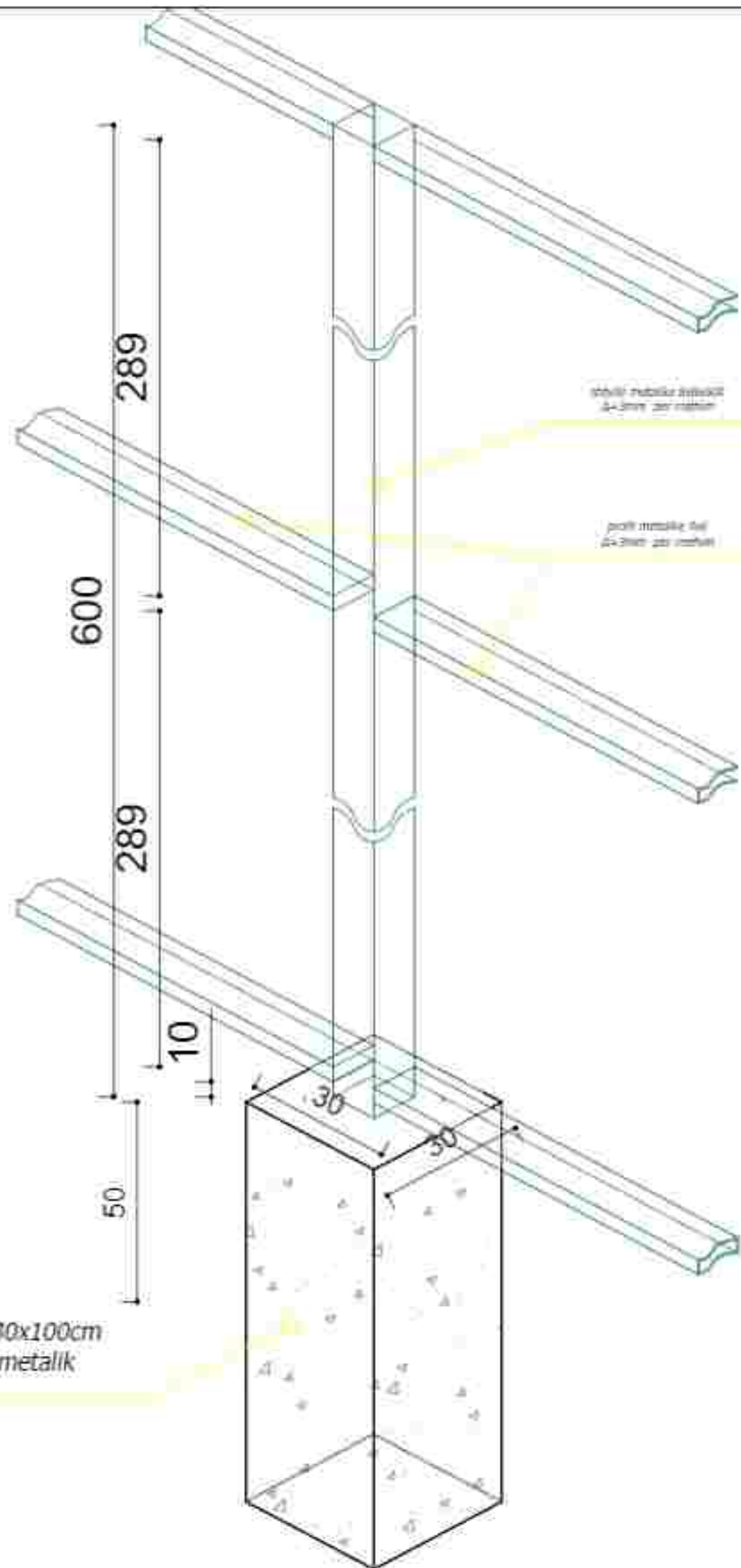

Koloncine b/a C16/20 30x30x100cm
per mantimin e profilave metalik

REPUBLIKA E SHQIPERISE



BASHKIA PEQIN

KUENT BASHKIA PEQIN

PROJEKT DEZIGNI RREGERTIMI I SHKULLS PAVJECARE SHKRE

SHKRETI (KUSHTES)
TERRENET SPORTIVE

KARTEJA (KUSHTES)

PROJEKTUES

"A.S.H. ENGINEERING" sh.p.k.

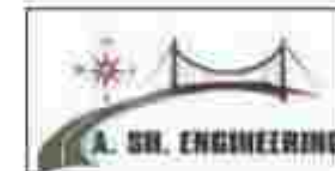

SHKURORTA E KUENT PEQIN

SHTYLL ELEKTRIKE ME Puset NE TOK ME LIDHJE EKUIPOTENCIALE DHE MORSETERIA E LINJES SE NDRIAI

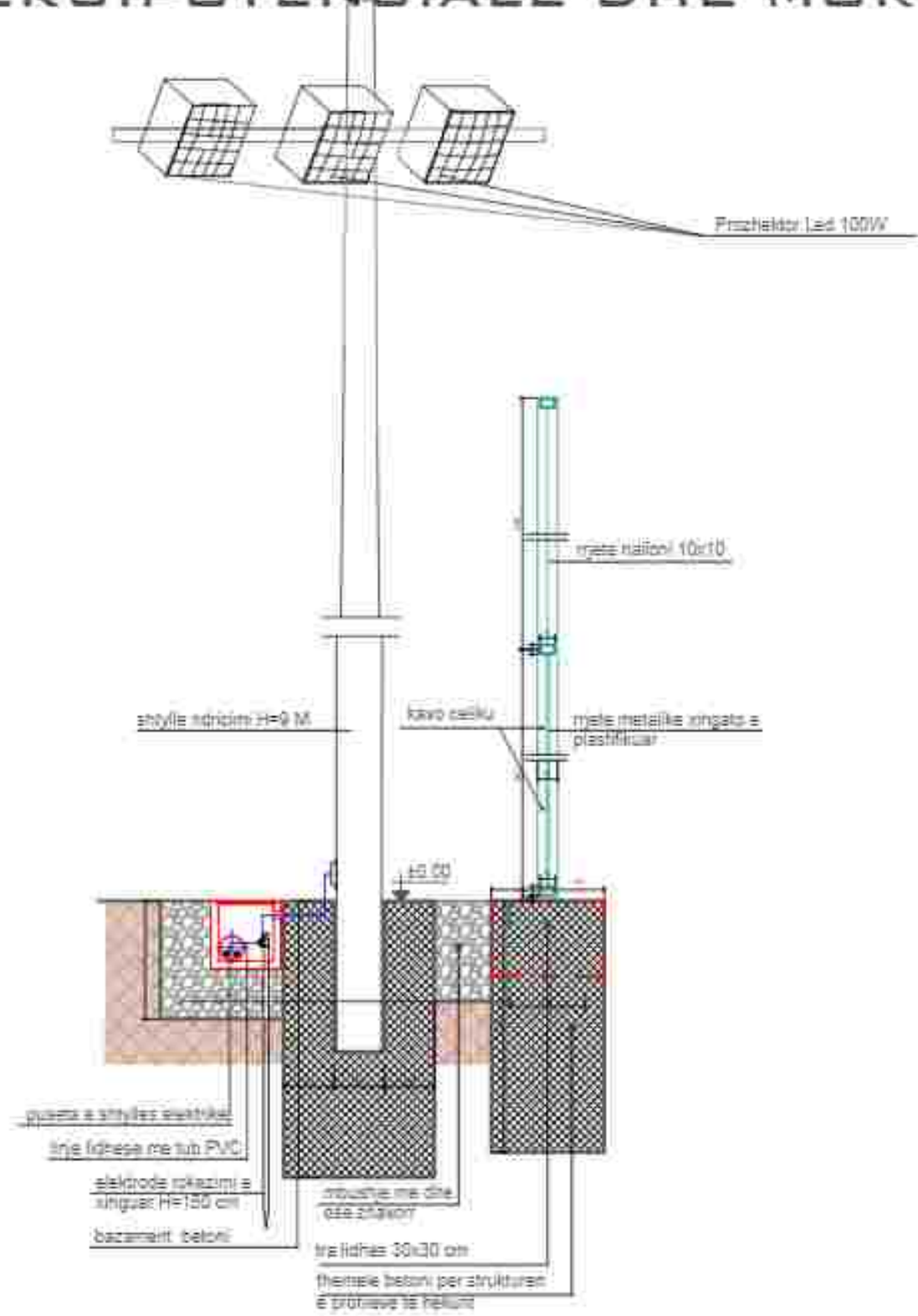

SHTYLL ELEKTRIKE ME Puset N TOK ME LIDHJE EKUIPOTENCIALE DHE MORSETERIA E LINJES S NDRIAIMIT

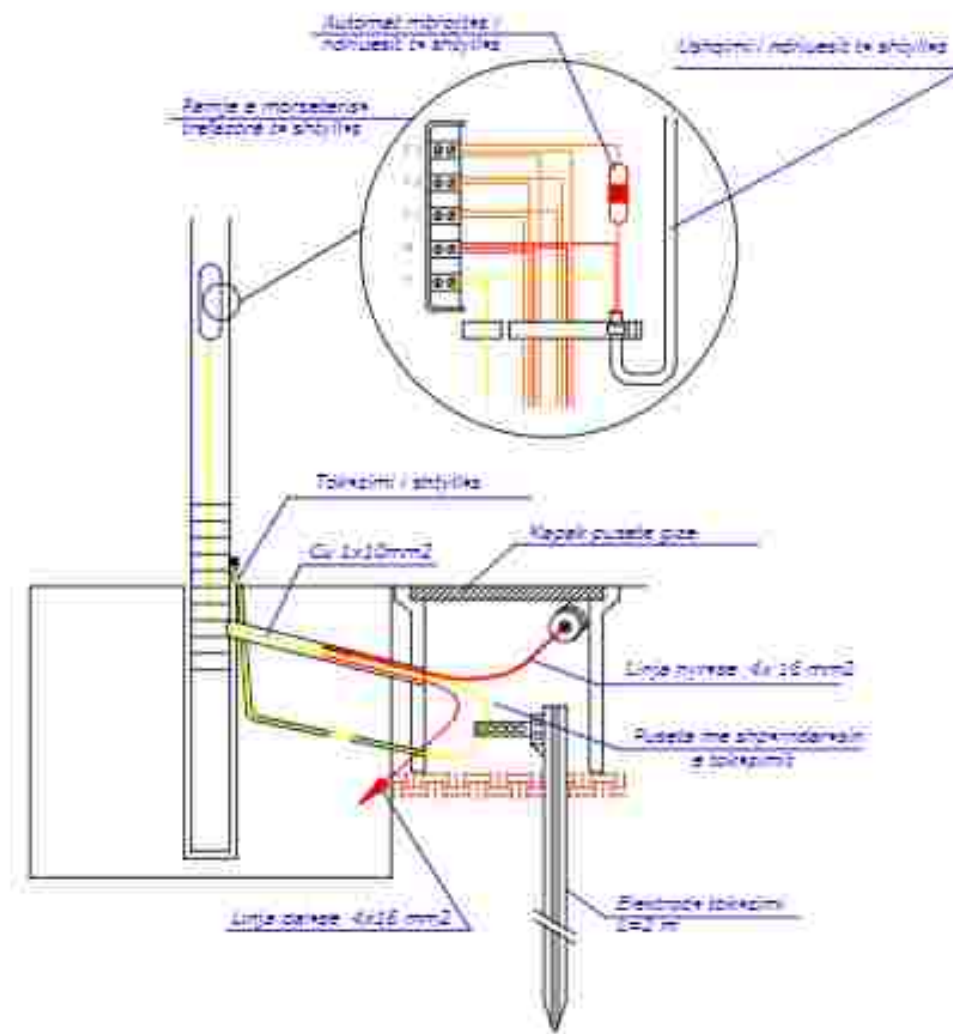

REPUBLIKA E SHQIPERISE



BASHKIA PEQINI

KUENT 242H/14 PEQIN

PROJEKT 242H/14 PEQIN (3-WOLLES 0-VUEJCAPE S HEZE

SHENTIHI / FLETES:
TERRENET SPORTIVE

ARROSHI / KULTURI

REGJISTRUAR:

"A.S.H. ENGINEERING" sh.p.k



INZHINJERIA E KUENTIT PEQIN

REPUBLIKA E SHQIPERIS



BASHKIA PEQIN

KOMUNA E PEQIN

PROJEKT

ENERJTI / FLETES
RINDOZA

ARROVIT / SLEKTT

INZHINJER

"A.S.H. ENGINEERING" sh.p.k.



INDOZA E SLEKTT PEQIN



REPUBLIKA E SHQERIS



BASHKIA PEQIN

ALBENTASHIA PEQIN

PROJEKTI

SHKURTIMI / FLETET
RENDERA

ARRITJE / KLINT

MOQITUM

"A. SH. ENGINEERING" sh.p.k



IBRODOLLAJ & SHKURTINI PEQIN



REPUBLIKA E SHQIPERISE



BASHKIA PEQIN

KUJENT BASHKIA PEQIN

PROJEKT

EVERTIMI I PLETES
RENDERA

ARRAZHJA I ALBANEZ

ARRAZHJA

"A.SH. ENGINEERING" sh.p.k

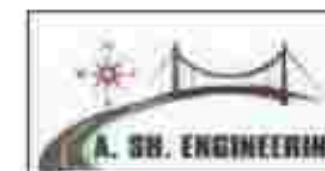

SHODHJA E NEJTYT PEQIN



REPUBLIKA E SHQIPERISE



BASHKIA E FIERIT

ALBENT BASHI & PARTI

PROJEKT:

ENERJI E FLETES
RENDERA

ARCHIT. I. BASHI

INZHINJER:

"A.S.H. ENGINEERING" sh.p.k

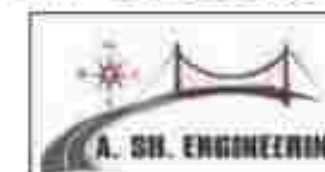

INDUSTRIAL & RESIDENTIAL



REPUBLIKA E SHQËRIKË



BASHKIA E PEQIN

KUËNT E BASHKISË PEQIN

PECQENT:

EMERTIMI I FLETËS
RINDOERA

IPROJEKTIMI I KUËNTIT:

IPROJEKTUESI:

"A. SH. ENGINEERING" sh.p.k



IPROJEKTUESI I KUËNTIT PEQIN:



REPUBLIKA E SHQIPERISE



BASHKIA PEQIN

KLIENTIASHI PEQIN

PROJEKT

EVERTIMI / PLANI
RENDERA

ARSHI / ULETIT

PROJEKTORI:

"A. SH. ENGINEERING" sh.p.k



IPROJEKTIMI I ULETIT



REPUBLIKA E SHQIPERISE



BASHKIA PEÇIN

KUENTËRIM I PEÇIN

PROJEKT

EMERTIMI I FLETES
PENCERA

NUMERI I VLEBETIT

SHENJTORES

"A.S.H. ENGINEERING" sh.p.k.



SHENJTORES E SHENJTORECH



REPUBLIKA E SHQËRIE



DASHKIA FEOU

MENTASHIA FEDA

PROJEKT

SHËRTIM / FLETË
RENDORË

ARZIM / UÇIM

ARZIMOR

"A.S.H. ENGINEERING" sh.p.k



SHËRTIM / UÇIM



REPUBLIKA E SHQIPERISE



BASHKIA PEQIN

KLENTËKISHIA PEQIN

PROJEKT:

SHËRTIM (PLANET)
PENCERA

OPRETIM I KLENTËK.

REALIZUAR

"A.SH. ENGINEERING" sh.p.k

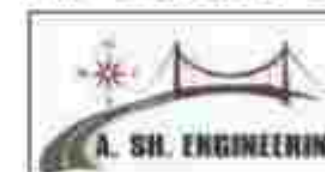

SHËRTIM I KLENTËKISHIA PEQIN



REPUBLIKA E SHQIPERISE



BASHKIA PEQIN

KLINT BASHKIA PEQIN



PROJEKTI

SHËRITHE / PLANET,
PENCERA

ADRESA / VLERËT

PROJEKTI

"A. SH. ENGINEERING" sh.p.k



KLINT BASHKIA PEQIN

REPUBLIKA E SHQIPERISE



BASHKIA PEQIN

KLINTASHI N PEQIN

PROJEKT

ENERJIM I PLETES
RINDERRA

ARCHIT. I KLINTASHI

RELIGJIOZE

"ASH ENGINEERING" sh.p.k



INDICIMIA E OBJEKTIT



REPUBLIKA E SHQIPERISE



BASHKIA PEQIN

PLENTASARI PEQIN

PROJEKT

ENERJTIH | FLETES
RENDERA

LRADHI | KLEVVIT

PROJEKTUAR

"A. SH. ENGINEERING" sh.p.k



INDIVIDUALI & QUALITY DESIGN



REPUBLIKA E SHQIPERISE



BASHKIA E FETËV

KULENT SAGHI W PESH

PROJEKT

SHËRTIMI I KULENT
PESHËRË

APRORI I KULENT

PROJEKTOR:

"A. SH. ENGINEERING" sh.p.k



INDIVIDUALI E KULENT PESHËRË



REPUBLIKA E SHQIPERISE



BASHKIA E PEÇIN

KLINT BASHKIA E PEÇIN

PROJEKT:

SHËRITHE E PLANET
RINDOZA

ARRITJE E KLINT

REGJITUR:

"A. SH. ENGINEERING" sh.p.k



VERIFIKIM E BASHKIA E PEÇIN



REPUBLIKA E SHQIPERISE

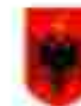

EASHKIA PEÇEN

KLINTASHTA PEËN

PROJEKT

SHËRTIM / FLETËS
PËNDRË

ADRIAN VILËPITI

SHËRTIM:

"A. SH. ENGINEERING" sh.p.k



SHËRTIM / FLETËS



REPUBLIKA E SHQIPERISE



BASHKIA E PEQIN

PLANTESHIA E PEQIN

PROJEKT

SHKURTIMI I PLANIT
RENDERA

ARRETHI I PLANIT

PROJEKTOR:

"A.SH. ENGINEERING" sh.p.k



INDICIMI I DOKUMENTIT



REPUBLIKA E SHQIPERISE



BASHKIA PEQIN

KLINT BASHKIA PEQIN

PROJEKT

SHKURTIMI I PLANIT
RENDOR

KLINTI (KLINT)

REALIZUESI

"A.S.H. ENGINEERING" sh.p.k



TEKNOLOGJIA E REZERVIT PEQIN



REPUBLIKA E SHQIPERISE



BASHKIA PEQIN

KUENI BASHKIA PEQIN

PROJEKT

SHKURTIMI I PLANET
BENEFERA

ARRSHI I PLANET

PROJEKTOR

"A. SH. ENGINEERING" sh.p.k.



ADRESA E BASHKIA PEQIN



REPUBLIKA E SHQIPERISE



BASHKIA PEQIN

ULENTSARIA PEQIN

PROJEKT

SHKURTIM I PLANIT
KONSTRUKTIV

SHKURTIM I PLANIT

RELATIV

"A. SH. ENGINEERING" sh.p.k



INDHODHJA E DOKUMENTIT



REPUBLIKA E SHQIPERISE



BASHKIA E PECUT

KL. SHIT SAGHIK PECU

PROJEKT:

EVERTI (N) FLETES
REVOCES

ARSHITIMI I EVERTI

PROJEKTOR

"A. SH. ENGINEERING" sh.pk

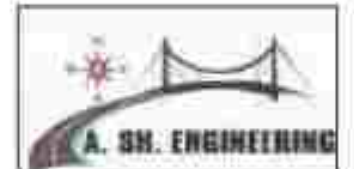

INDICIMALLA E SHIT SAGHIK PECU



REPUBLIKA E SHQIPERISE



BASHKIA PEQIN

KU ENTRADHIA PEQIN

PROJEKTI

ENERJTI I FLETES
PENSERA

ARQITECTURA

WELBYDAR

"A. SH. ENGINEERING" sh.p.k



INDUSTRIAL & CIVIL PEQIN



REPUBLIKA E SHQIPERISE



BASHKIA PEQIN

KUENT BASHKIA PEQIN

PROJEKT

SHKURTIM I FURTES
RENDERA

ARROHI I KUENTIT

PROJEKTUESI:

"A. SH. ENGINEERING" sh.p.k



INZHINIERI I KUENTIT PEQIN



REPUBLIKA E SHQIPËRIE



BASHKIA E PËQIN

FLETËBASHKIM PËQIN

PROJEKT

EMERTIMI I FLETËS
RENDORË

ARCHIT. I FLETËS

RELATUAR

"A. SH. ENGINEERING" sh.p.k



INDIKUESI I OBJEKTIT PËQIN





REPUBLIKA E SHQIPERISE



BASHKIA PEQIN

KLINTASHTI I PEQIN

PROJEKT

ENERJIM I FLETES
SHKOLLE

ARCHIT. I KLINTASHTI

RELIGJIOZE

"A.S.H. ENGINEERING" sh.p.k



INDICACIONIA E OBJEKTT FOCIN

REPUBLIKA E SHQERISE



BAJSHIA PEQIN

KL. SHTRAS - 1 A FETA

PROJEKT:

SHKURTIM / FLETES
PENDESA

ARQIT. I. H. SHTRA

PROJEKTOR

"A. SH. ENGINEERING" sh.p.k



IPROJEKTOIM & DORRITJE EFCN



REPUBLIKA E SHQIPERISE



BASHKIA PEQIN

KUENT BASHKIA PEQIN

PROJEKT

EXERTIMI (KATEGORIA):
FENDESA

ARREHE (KATEGORIA):

PROJEKTUES

"A.S.H. ENGINEERING" sh.p.k



IPROJEKTUESI E KATEGORIS SEKONDE



REPUBLIKA E SHQIPERISE



BASHKIA E PEÇIN

K. ENT BASHIA PEÇIN

PROJEKT:

ENJERTHI I FLETES-
RENDORA

ARRIBIRI-GJENDIT:

PROJEKTUAR:

"A.S.H. ENGINEERING" sh.p.k



VERHOODAKU E BASHIA PEÇIN





REPUBLIKA E SHQIPERISE



BASHKIA PEQIN

KUENT BASHKIA PEQIN

PROJEKT

ENERJHI I FLETES
REJOSKA

ARQITETI I KUENT

PROJEKTUAR

"A. SH. ENGINEERING" sh.p.k



SHKURTYMJA E TITULLIT PEQIN