

MIRATOHET:  
KRYETARI  
ALBERT MËLYSHI



# PROJEKT - ZBATIMI

**OBJEKTI : "RIKONSTRUKSION SHKARKUESI KATASTROFIK, MALAJ 1"**

**POROSITES:**

**BASHKIA MIRDITE**

**PROJEKTUES:**

**"ANGERBA" SH.P.K**



**QERSHOR 2024**



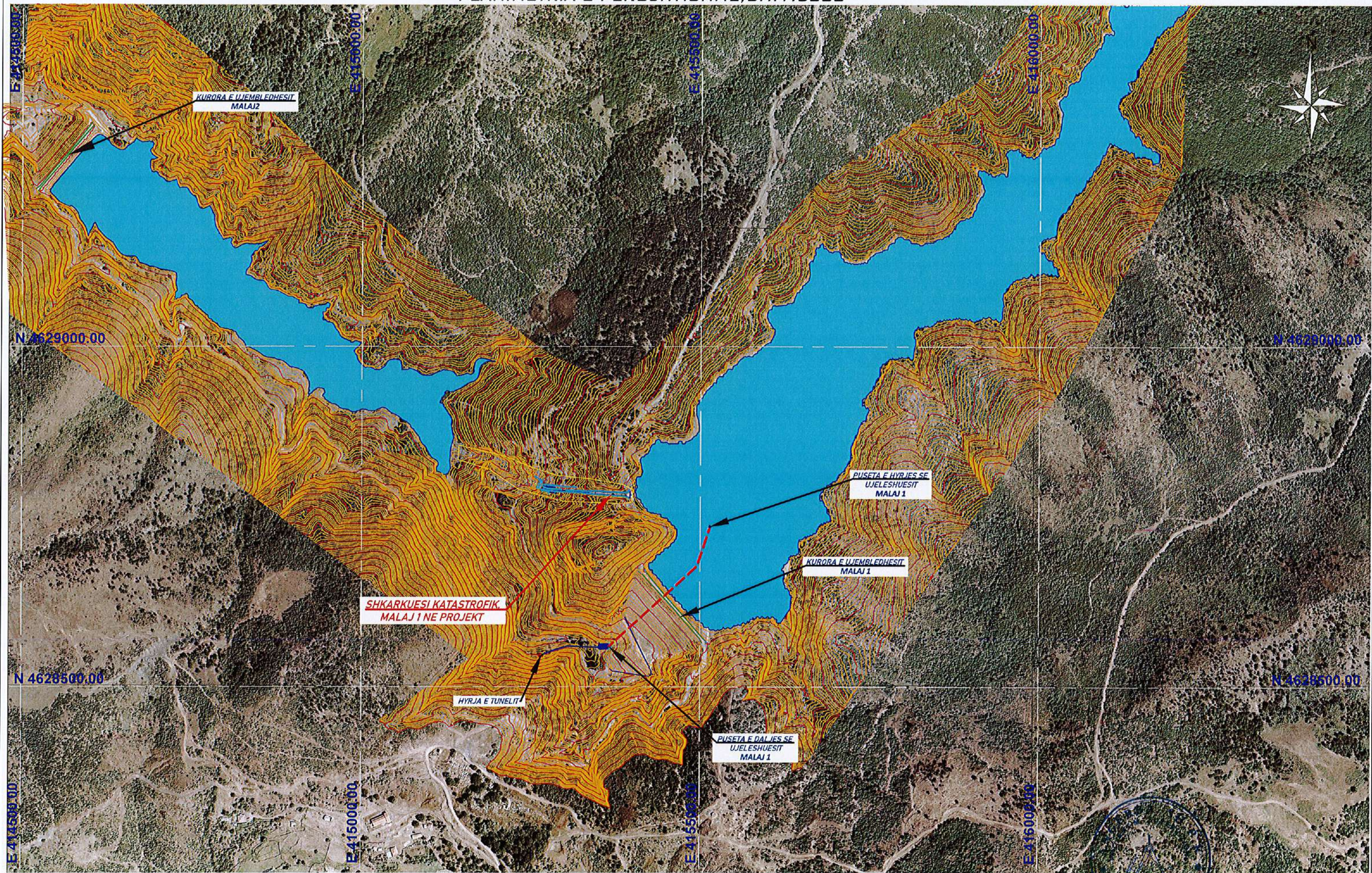

POROSITESI  
**BASHKIA MIRDITE**



**"ANGERBA" shpk**  
Adresa: Rr. "Irfan Tomini" Tirane.  
Cel: 069 20 95 862  
E-mail: burhanhafizi@gmail.com

VENDODHJA  
*Bashkia Mirdite*  
TITULLI I PROJEKTIT  
**RIKONSTRUKSION SHKARKUESI  
KATASTROFIK, MALAJ 1**

FAZA E PROJEKTIMIT :  
**PROJEKT ZBATIMI**  
TITULLI I VIZATIMIT :  
**PLANIMETRIA E PERGJITHSHME**



Grupi Projektimit :  
Ing. Burhan HAFIZI  
Ing. Servet VERÇANI  
Ing. Gerti HAFIZI



Shkalla 1:5000  
Data: Qershor 2024  
FLETA Nr.2

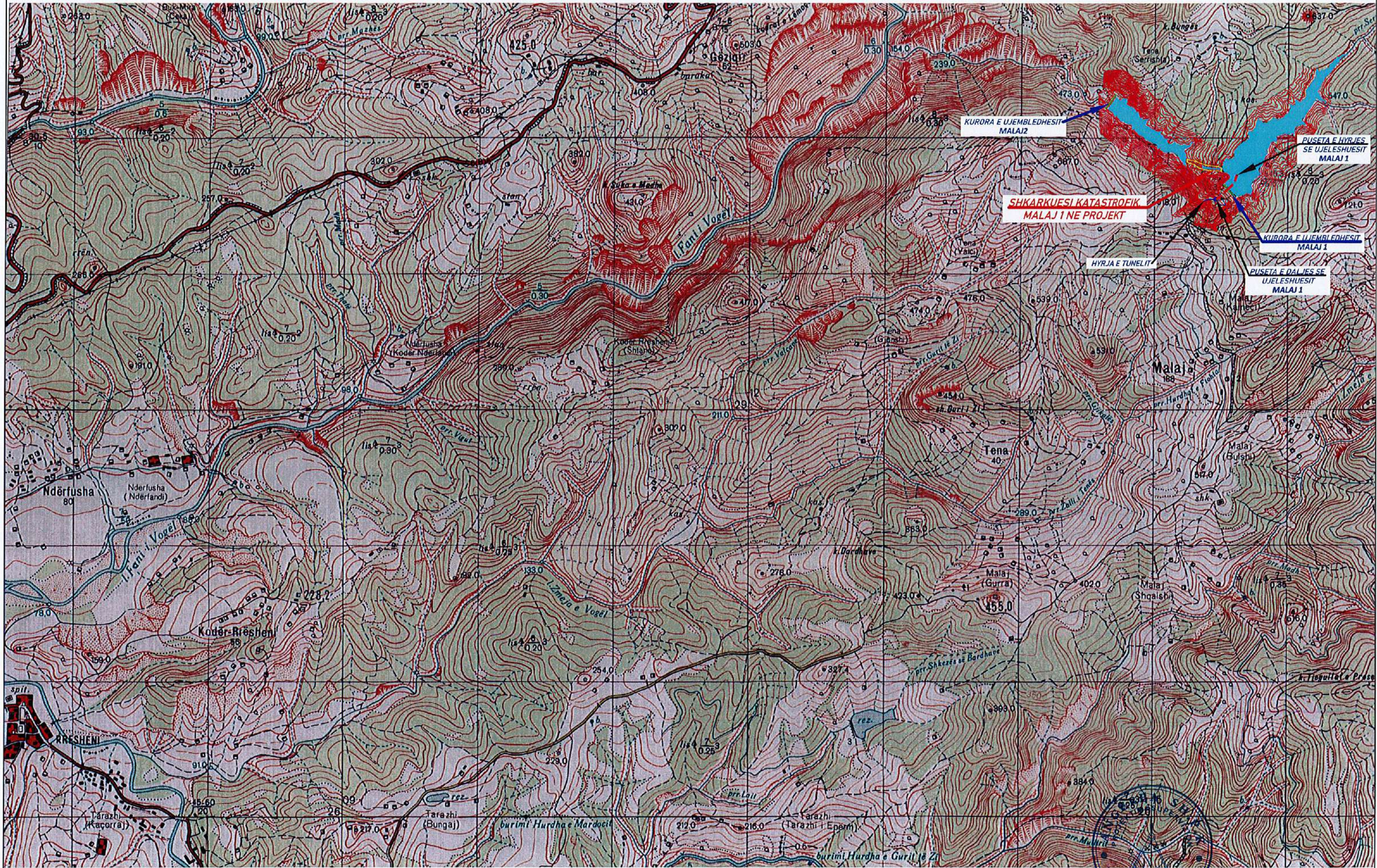



<p>POROSITESI</p>	<p><b>"ANGERBA" shpk</b></p> <p>Adresa: Rr. "Irfan Tomini" Tirane. Cel: 069 20 95 862 E-mail: burhanhafizi@gmail.com</p>	<p>VENDODHJA</p> <p>Bashkia Mirdite</p>	<p>FAZA E PROJEKTIMIT :</p> <p><b>PROJEKT ZBATIMI</b></p>	<p>Grupi i Projektimit :</p> <p>Ing. Burhan HAFIZI Ing. Servet VERÇANI Ing. Gerti HAFIZI</p>	<p>Shkalla 1:25 000</p>
<p><b>BASHKIA MIRDITE</b></p>		<p>TITULLI I PROJEKTIT</p> <p><b>RIKONSTRUKSION SHKARKUESI KATASTROFIK, MALAJ I</b></p>	<p>TITULLI I VIZATIMIT :</p> <p><b>HARTA E ZONES</b></p>		<p>Data: Qershor 2024</p> <p>FLETA Nr.1</p>



PLANIMETRIA E PERGJITHSHME, SKEMA, SH. 1:5000

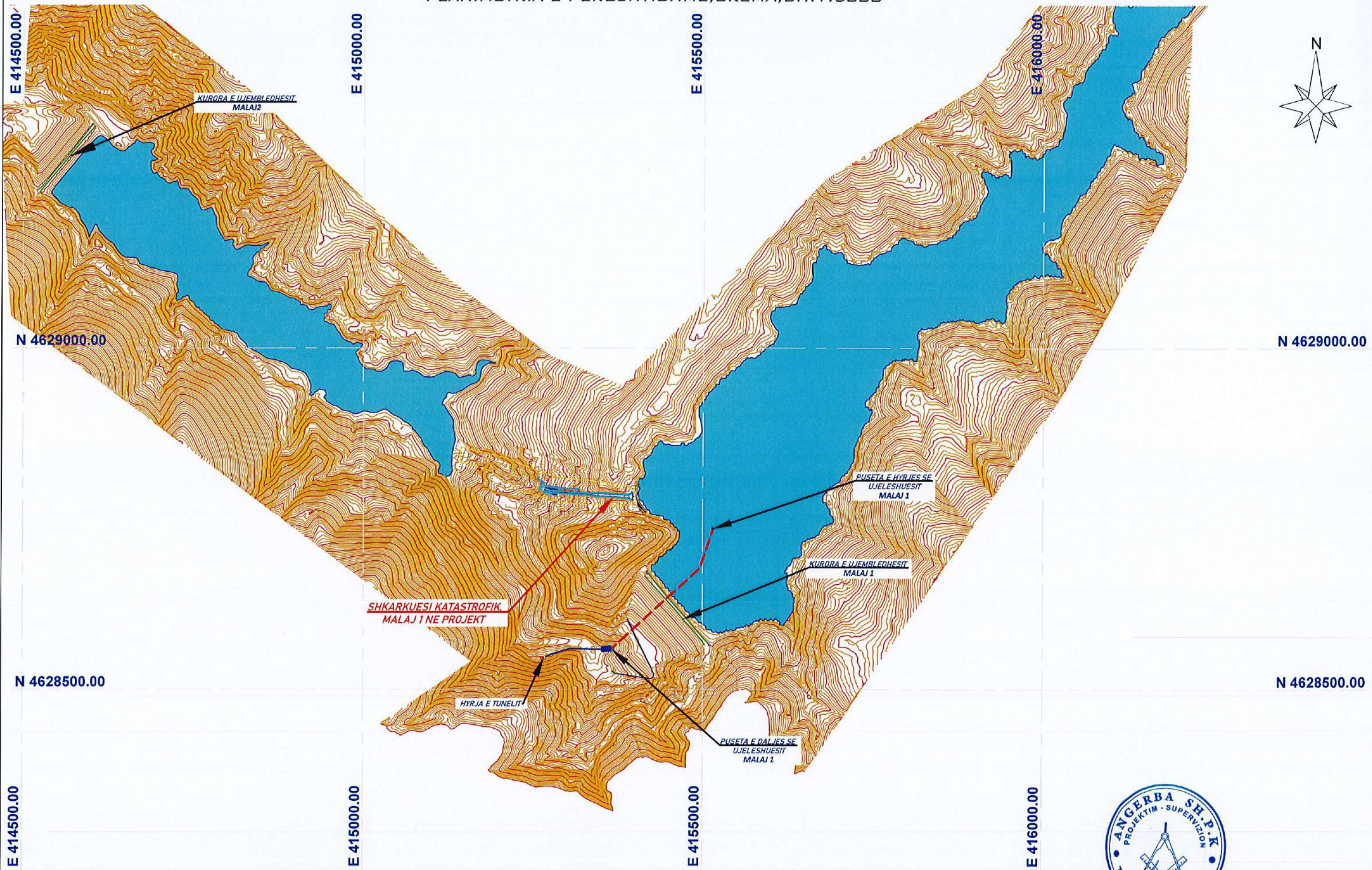

POROSITESI  
**BASHKIA MIRDITE**



**"ANGERBA" shpk**  
Adresa: Rr. "Irfan Tomini" Tirane.  
Cel: 069 20 95 862  
E-mail: burhanhafizi@gmail.com

VENDODHJA  
*Bashkia Mirdite*  
TITULLI I PROJEKTTIT  
**RIKONSTRUKSION SHKARKUESI  
KATASTROFIK, MALAJ 1**

FAZA E PROJEKTIMIT:  
**PROJEKT ZBATIMI**  
TITULLI I VIZATIMIT:  
**PLANIMETRIA E PERGJITHSHME  
SKEMA**

Grupi i Projektimit:  
Ing. Burhan HAFIZI  
Ing. Servet VERÇANI  
Ing. Gerti HAFIZI



Shkalla 1:5000  
Data: Qershor 2024  
FLETA Nr.3





POROSITESI  
BASHKIA MIRDITE



**"ANGERBA" shpk**  
Adresa: Rr. "Irfan Tomini" Tirane.  
Cel: 069 20 95 862  
E-mail: burhanhafizi@gmail.com

VENDODHJA  
Bashkia Mirdite  
TITULLI I PROJEKTI  
RIKONSTRUKSION SHKARKUESI  
KATASTROFIK, MALAJ 1

FAZA E PROJEKTIMIT:  
PROJEKT ZBATIMI  
TITULLI I VIZATIMIT:  
RILEVIMI TOPOGRAFIK

Grupi i Projektimit:  
IRANE - ALBANIA  
Ing. Burhan HAFIZI  
Ing. Servet VERÇANI  
Ing. Gerti HAFIZI

Shkalla 1:500  
Data: Qershor 2024  
FLETA Nr.4





<p>POROSITESI</p>	<p><b>"ANGERBA" shpk</b> Adresa: Rr. "Irfan Tomini" Tirane. Cel: 069 20 95 862 E-mail: burhanhafizi@gmail.com</p>	<p>VENDODHJA <b>Bashkia Mirdite</b></p>	<p>FAZA E PROJEKTIMIT: <b>PROJEKT ZBATIMI</b></p>	<p>Grupi Projektimit: <b>TIRANE - ALBANIA</b> Ing. Burhan HAFIZI Ing. Servet VERÇANI Ing. Gerti HAFIZI</p>	<p>Shkalla 1:500</p>
<p><b>BASHKIA MIRDITE</b></p>		<p>TITULLI I PROJEKTI <b>RIKONSTRUKSION SHKARKUESI KATASTROFIK, MALAJ 1</b></p>	<p>TITULLI I VIZATIMIT: <b>PLANIMETRIA E PERGJITHSHME PK.1-PK.27</b></p>	<p>Shkalla 1:500</p>	<p>Data: Qershor 2024 FLETA Nr.5</p>



PLANIMETRIA E PERGJITHSHME, SH. 1:250

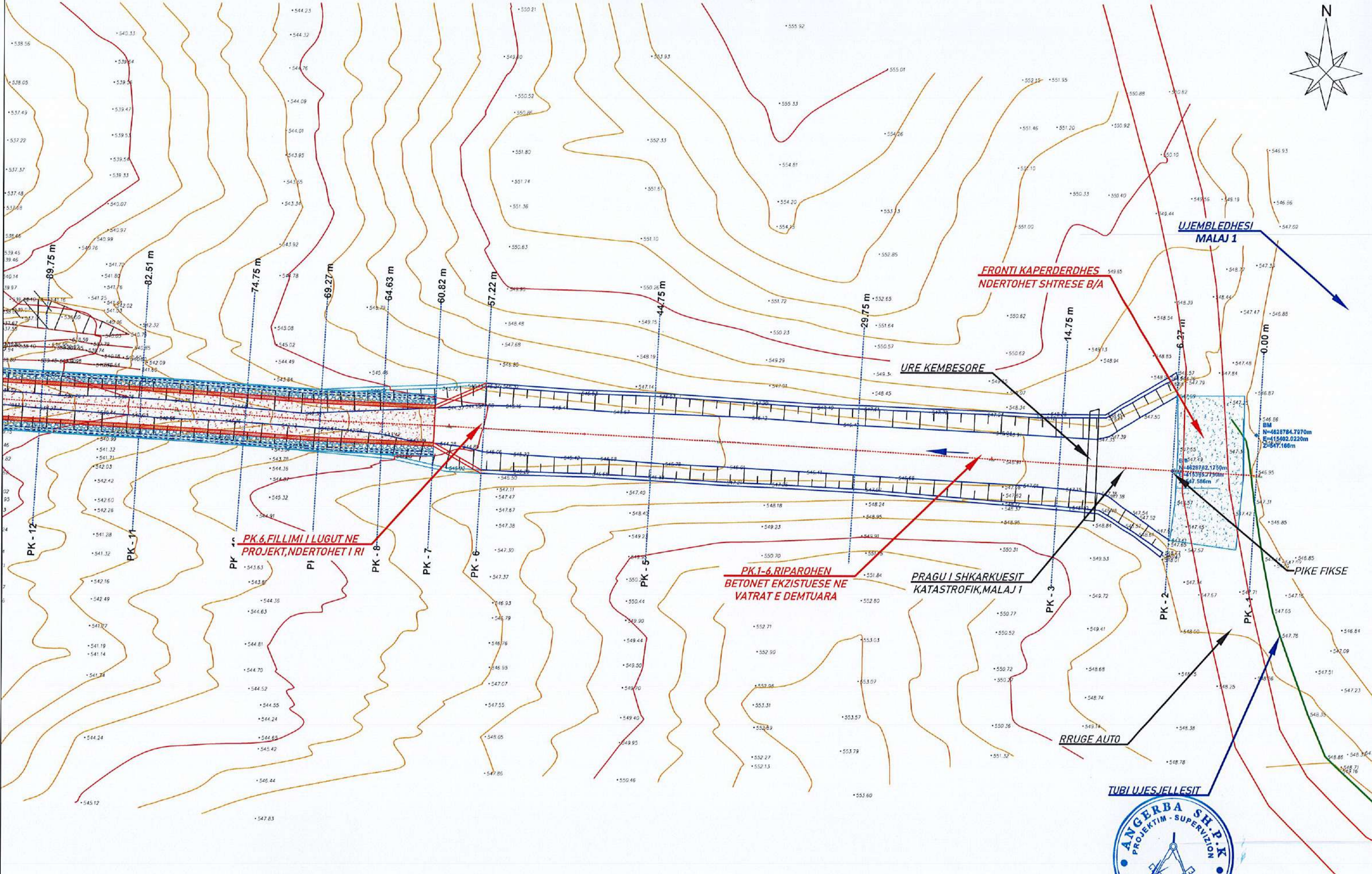

POROSITESI  
**BASHKIA MIRDITE**



**"ANGERBA" shpk**  
Adresa: Rr. "Irfan Tomini" Tirane.  
Cel: 069 20 95 862  
E-mail: burhanhafizi@gmail.com

VENDODHJA  
**Bashkia Mirdite**  
TITULLI I PROJEKTI  
**RIKONSTRUKSION SHKARKUESI  
KATASTROFIK, MALAJ 1**

FAZA E PROJEKTIMIT :  
**PROJEKT ZBATIMI**  
TITULLI I VIZATIMIT :  
**PLANIMETRIA E PERGJITHSHME  
PK.1-PK.12**

Grupi i Projektimit:  
Ing. Burhan HAFIZI  
Ing. Servet VERÇANI  
Ing. Gerti HAFIZI



Shkalla 1:250  
Data: Qershor 2024  
FLETA Nr.6



PLANIMETRIA E PERGJITHSHME, SH. 1:250

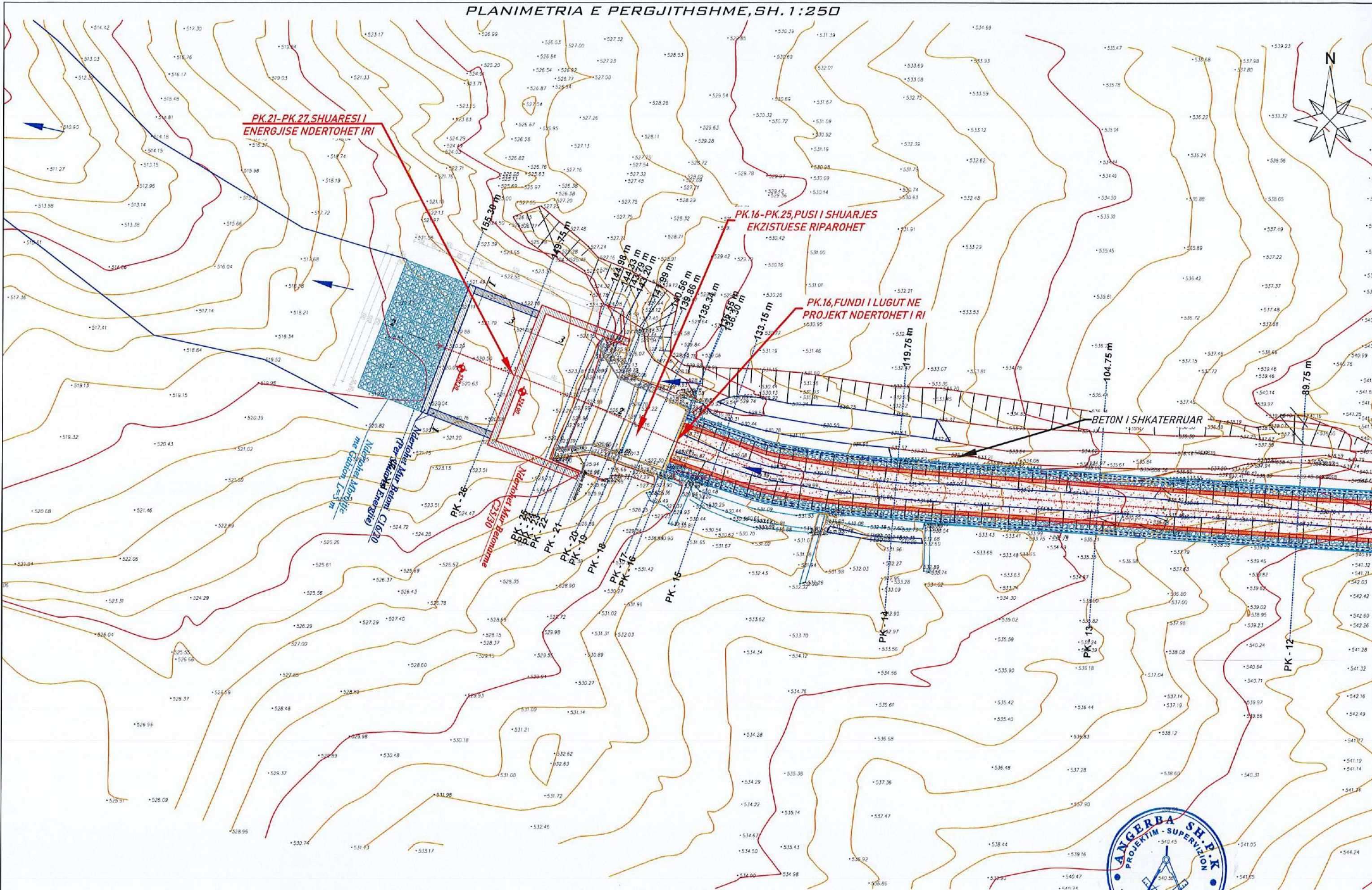

POROSITESI  
**BASHKIA MIRDITE**

**"ANGERBA" shpk**  
Adresa: Rr. "Irfan Tomini" Tirane.  
Cel: 069 20 95 862  
E-mail: burhanhafizi@gmail.com

VENDODHJA  
**Bashkia Mirdite**  
TITULLI I PROJEKTIT  
**RIKONSTRUKSION SHKARKUESI  
KATASTROFIK, MALAJ 1**

FAZA E PROJEKTIMIT:  
**PROJEKT ZBATIMI**  
TITULLI I VIZATIMIT:  
**PLANIMETRIA E PERGJITHSHME  
PK.12-PK.27**

Grupi Projektim:  
Ing. Burhan HAFIZI  
Ing. Servet VERÇANI  
Ing. Gerti HAFIZI

Shkalla 1:250  
Data: Qershor 2024  
FLETA Nr.7

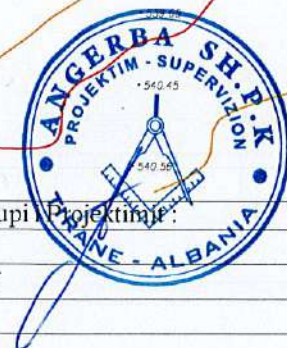



PROFILI GJATESOR I KANALIT E SHKARKUESIT KATASTROFIK, L=155 M

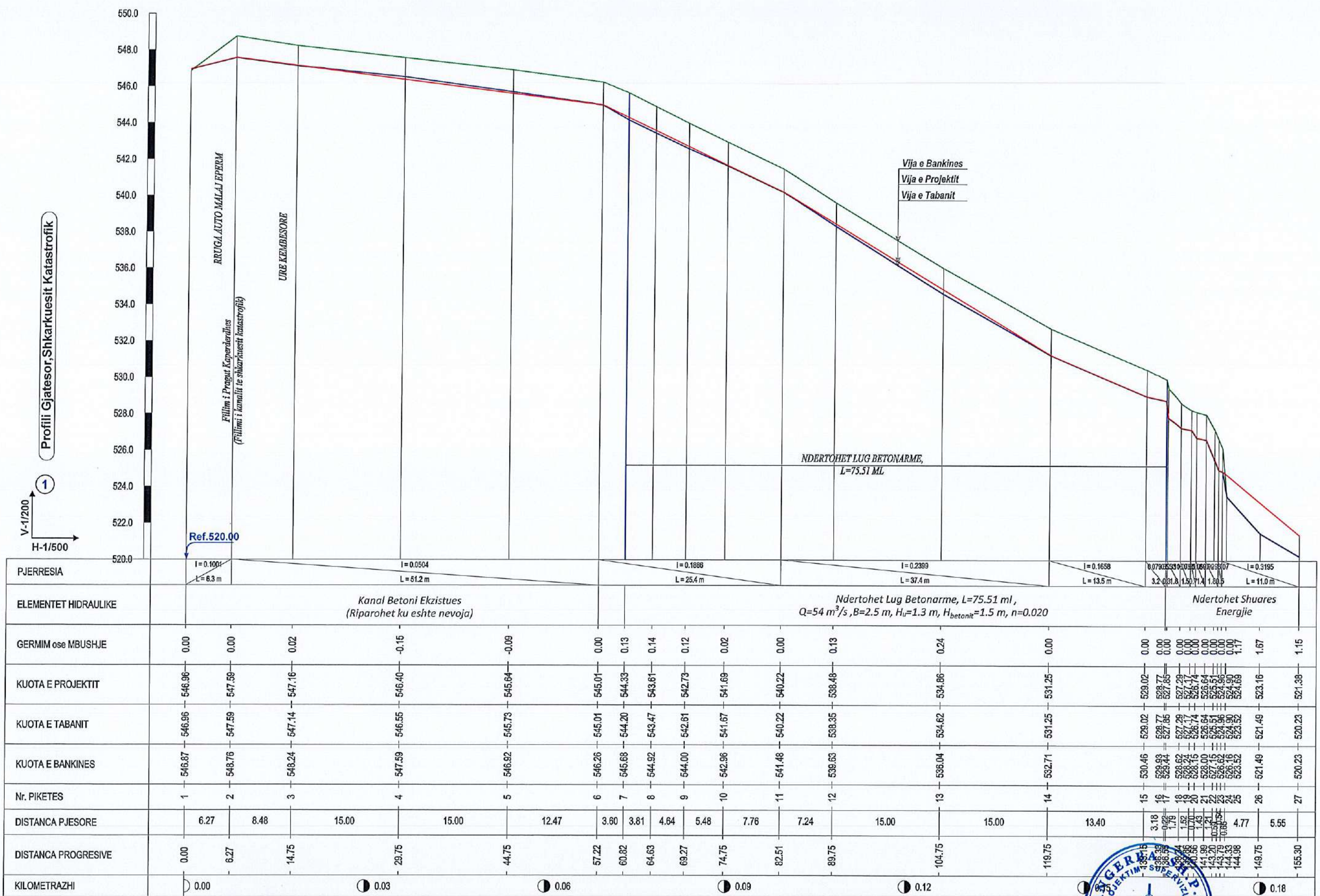

PJERRESIA	I = 0.1001 L = 6.3 m		I = 0.0504 L = 61.2 m			I = 0.1886 L = 25.4 m			I = 0.2399 L = 37.4 m			I = 0.1658 L = 13.5 m		0.0792, 0.0301, 0.0100, 0.0099, 0.0085, 0.007		I = 0.3195 L = 11.0 m											
ELEMENTET HIDRAULIKE	Kanal Betoni Ekzistues (Riparohet ku eshte nevoja)											Ndertohet Lug Betonarme, L=75.51 ml, Q=54 m³/s, B=2.5 m, H <sub>i</sub> =1.3 m, H <sub>betonik</sub> =1.5 m, n=0.020			Ndertohet Shuares Energjie												
GERMIM ose MBUSHJE	0.00	0.00	0.02	-0.15	-0.09	0.00	0.13	0.14	0.12	0.02	0.00	0.13	0.24	0.00	0.00	0.00	0.00	0.00	1.17	1.67	1.15						
KUOTA E PROJEKTTIT	546.96	547.59	547.16	546.40	545.64	545.01	544.33	543.61	542.73	541.69	540.22	538.48	534.86	531.25	529.02	528.77	527.85	527.29	527.17	526.64	524.90	523.36					
KUOTA E TABANIT	546.96	547.59	547.14	546.55	545.73	545.01	544.20	543.47	542.91	541.67	540.22	538.35	534.62	531.25	529.02	528.77	527.85	527.29	527.17	526.64	524.90	523.36					
KUOTA E BANKINES	546.87	548.76	548.24	547.59	546.92	546.26	545.68	544.92	544.00	542.96	541.48	539.63	536.04	531.25	529.46	529.93	528.44	527.17	526.21	525.00	524.62	523.52					
Nr. PIKETES	1	2	3	4	5	6	7	8	9	10	11	12	13	14	15	16	17	18	19	20	21	22	23	24	25	26	27
DISTANCA PJESORE	6.27	8.48	15.00	15.00	12.47	3.80	3.81	4.64	5.48	7.76	7.24	15.00	15.00	13.40	3.18	0.22	1.79	1.52	0.70	1.43	1.99	0.53	0.82	4.77	5.55		
DISTANCA PROGRESIVE	0.00	6.27	14.75	29.75	44.75	57.22	60.82	64.63	69.27	74.75	82.51	89.75	104.75	119.75	133.15	133.37	135.16	136.68	138.18	139.88	141.87	143.70	144.53	144.96	149.75	155.30	
KILOMETRAZHI	0.00	0.03	0.06	0.09	0.12	0.16	0.19	0.23	0.28	0.35	0.42	0.57	0.72	0.86	0.99	1.02	1.04	1.06	1.07	1.08	1.10	1.11	1.12	1.13	1.18	1.24	

POROSITESI

BASHKIA MIRDITE



**"ANGERBA" shpk**  
Adresa: Rr. "Irfan Tomini" Tirane.  
Cel: 069 20 95 862  
E-mail: burhanhafizi@gmail.com

VENDODHJA  
Bashkia Mirdite  
TITULLI I PROJEKTTIT  
RIKONSTRUKSION SHKARKUESI  
KATASTROFIK, MALAJ I

FAZA E PROJEKTIMIT:  
PROJEKT ZBATIMI  
TITULLI I VIZATIMIT:  
PROFILI GJATESOR I SHKARKUESIT  
PK.1-27



Ing. Burhan HAFIZI  
Ing. Servet VERDIPAJ  
Ing. Gerti HAFIZI

Shkalla 1:200,500  
Data: Qershor 2024  
FLETA Nr.8



PROFLET TERTHORE

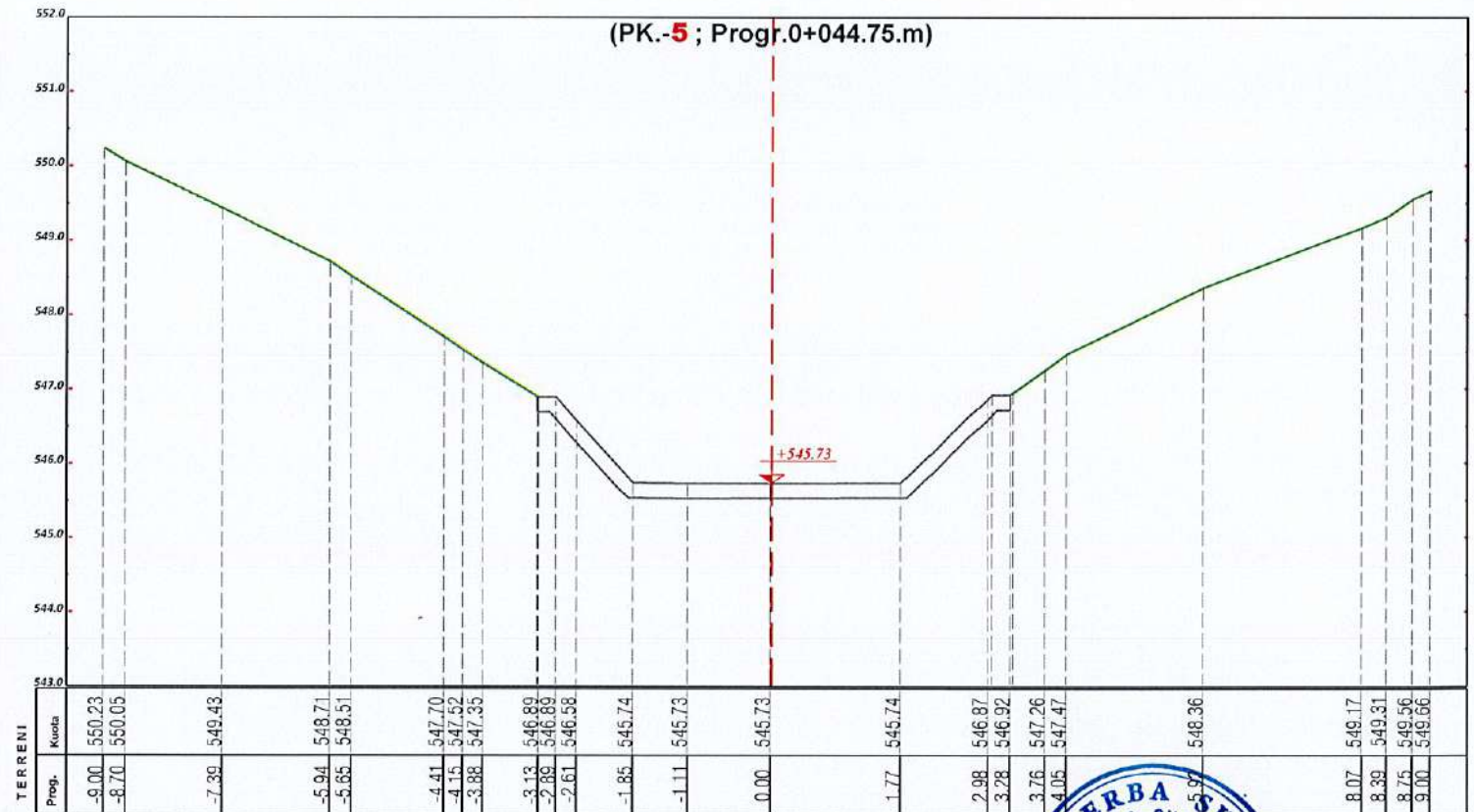
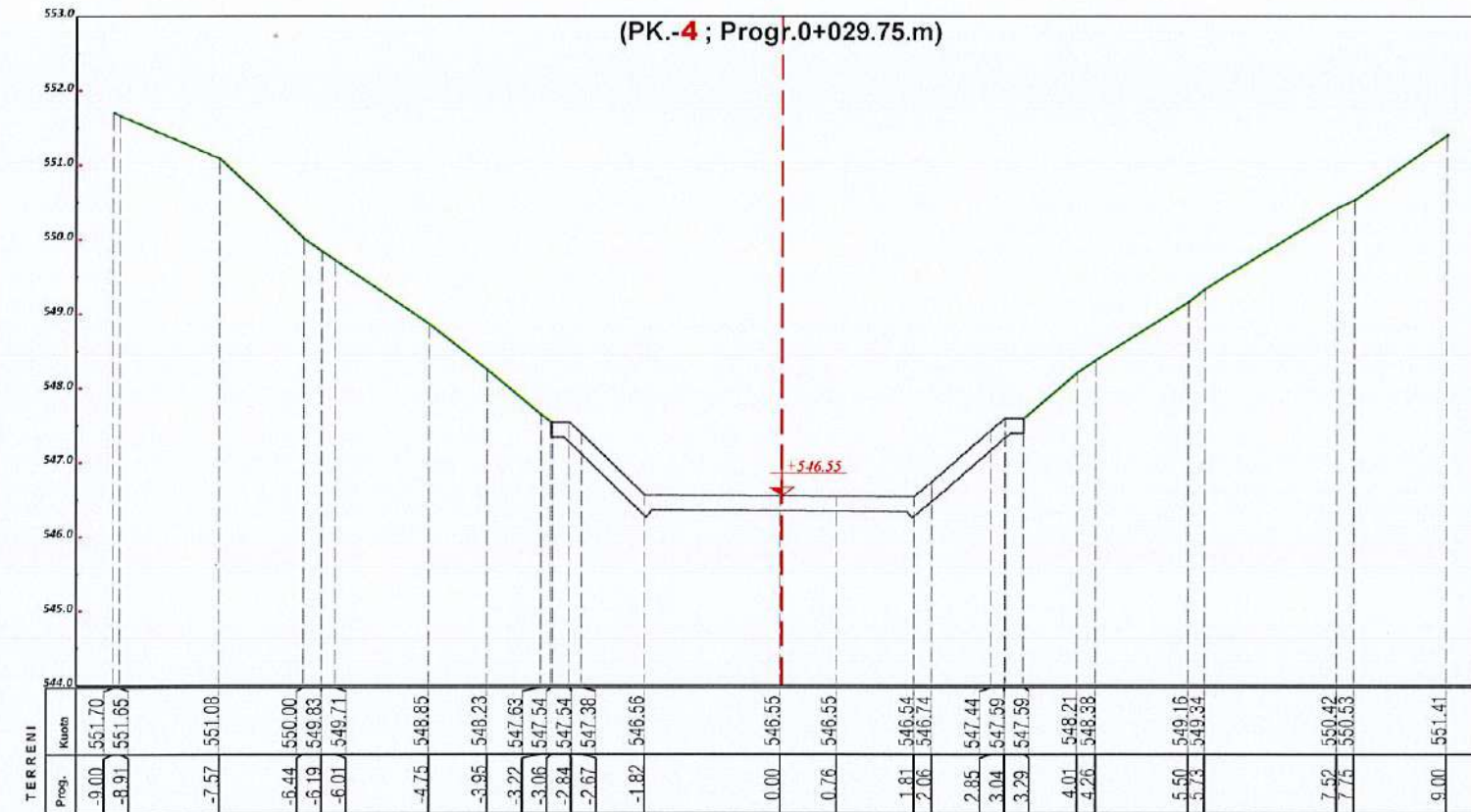
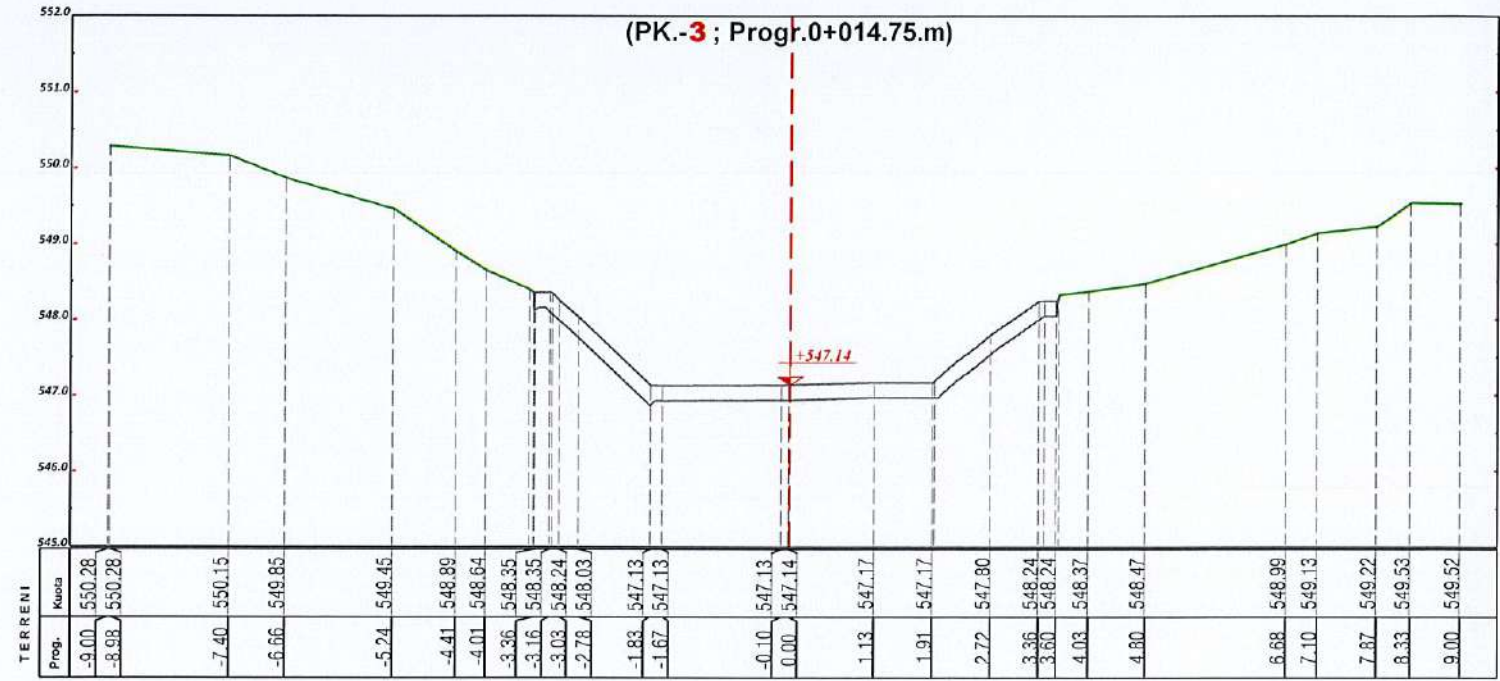
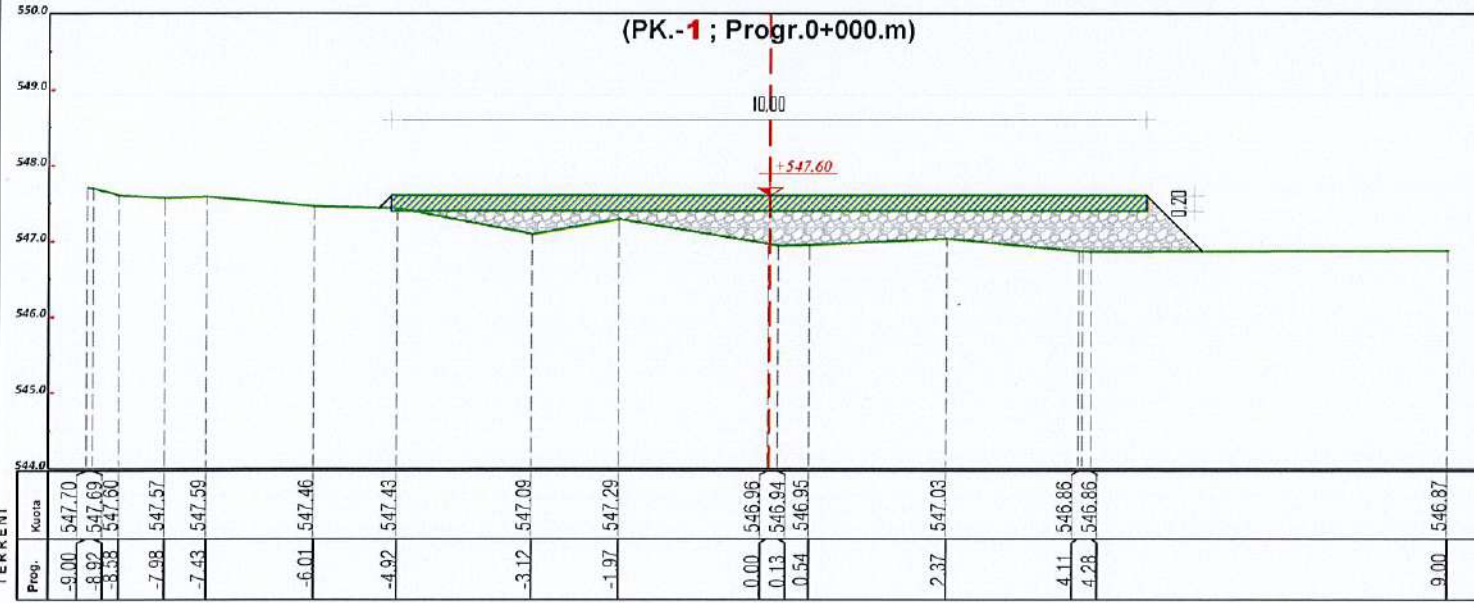

POROSITESI

BASHKIA MIRDITE



"ANGERBA" sh.p.k.  
Adresa:Rr."Irfan Tomini" Tirane.  
Cel: 069 20 95 862  
E-mail: burhanhafizi@gmail.com

VENDODHIA  
Bashkia Mirdite

TITULLI I PROJEKTIT  
RIKONSTRUKSION SHKARKUESI  
KATASTROFIK ,MALAJ I

FAZA E PROJEKTIMIT:  
PROJEKT ZBATIMI

TITULLI I VIZATIMIT:  
PROFLET TERTHORE

Grupi i Projektimit

Ing. Burhan HAFIZI  
Ing. Servet VERÇANI  
Ing. Gerti HAFIZI



Shkalla 1:100

Data: Qershor 2024

FLETA Nr. 9



PROFLET TERTHORE

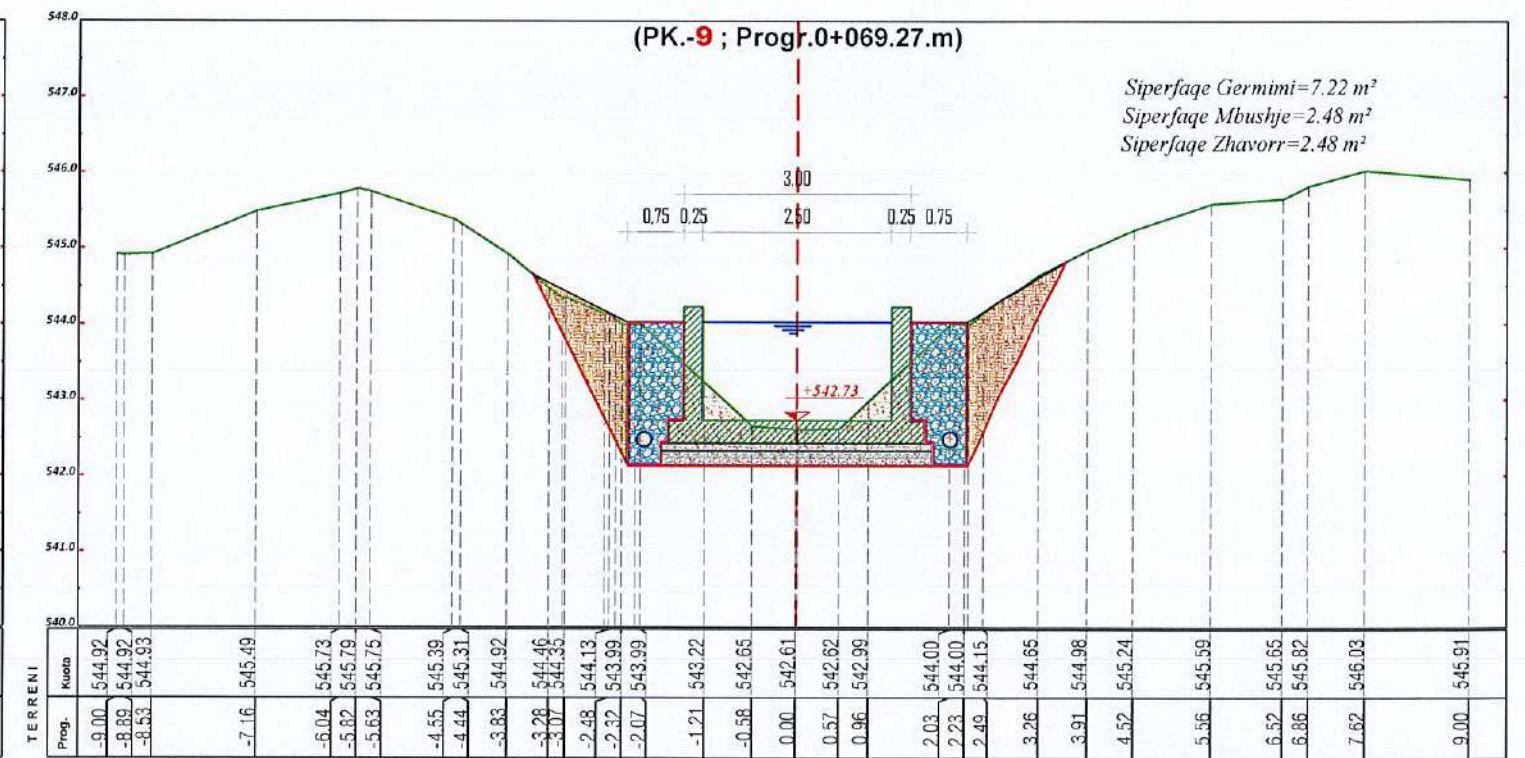
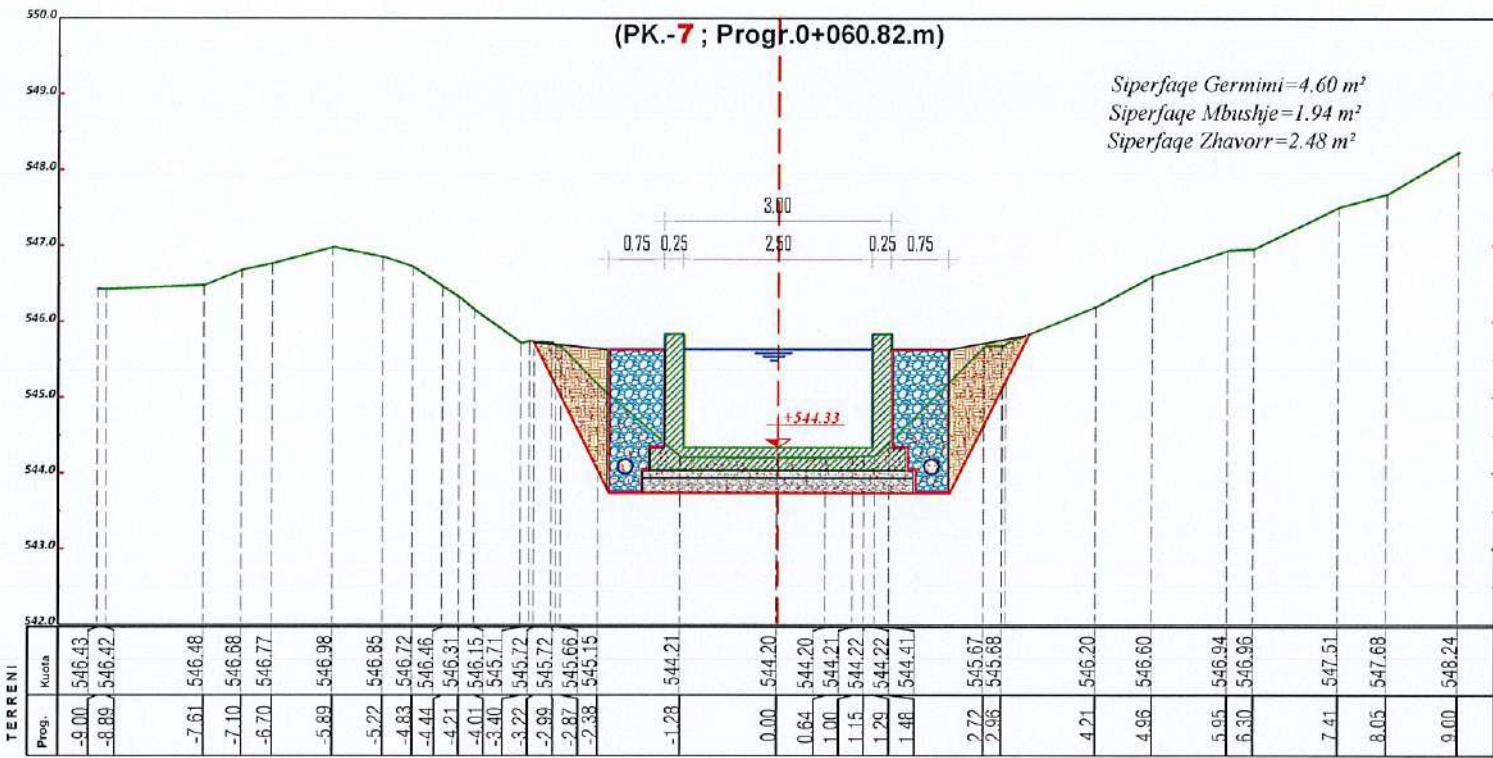
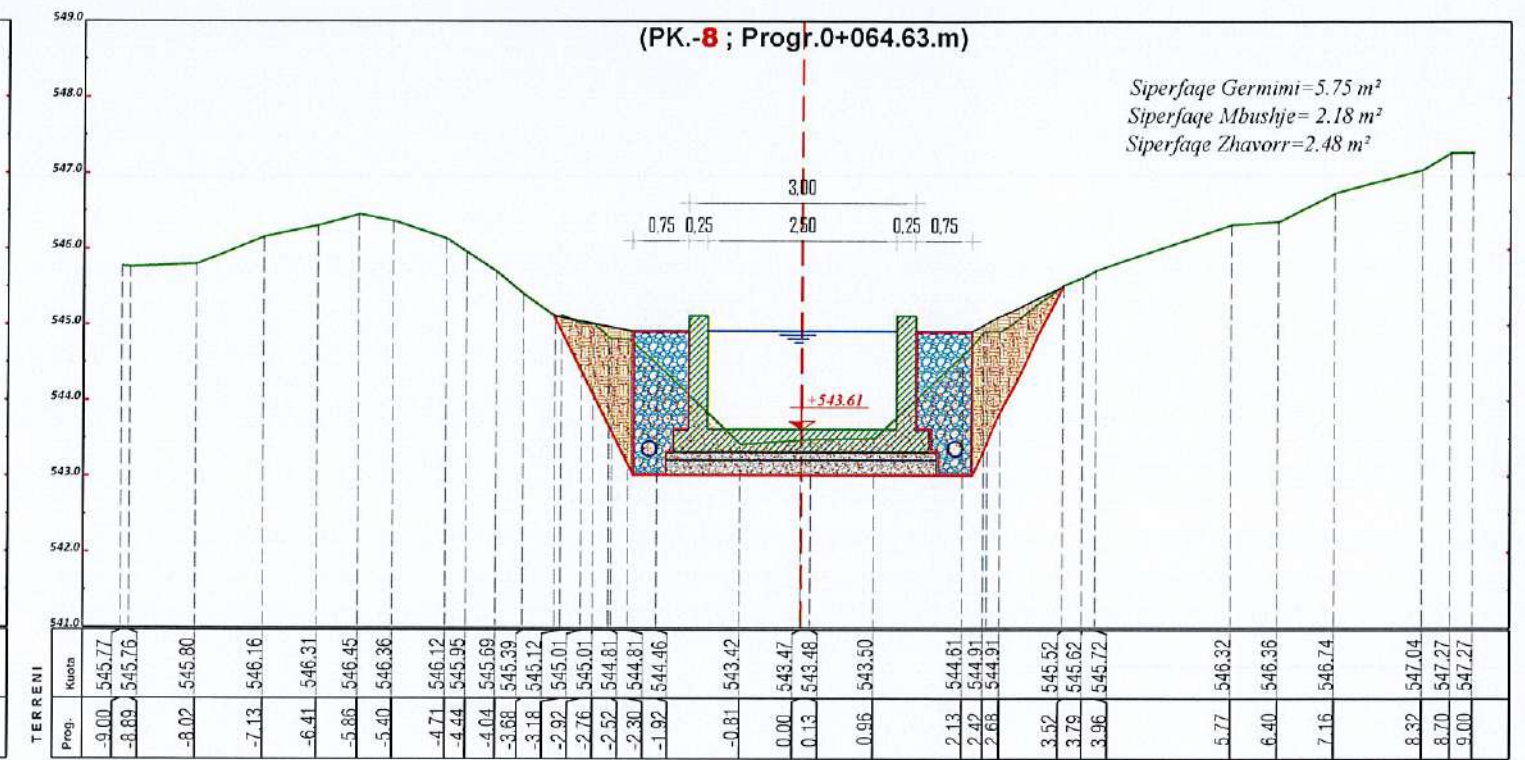
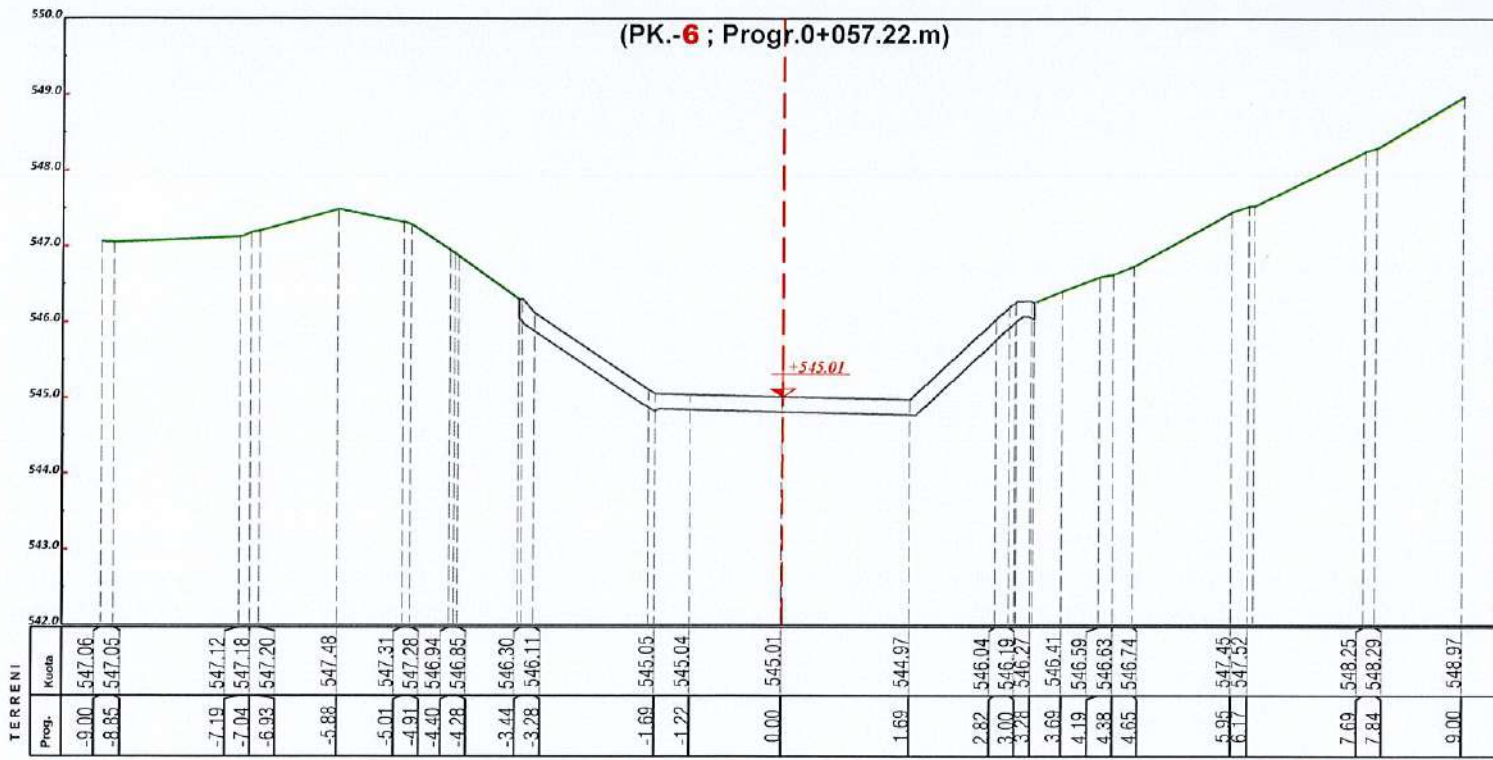

POROSITESI

BASHKIA MIRDITE



"ANGERBA" sh.p.k.  
Adresa:Rr."Irfan Tomini" Tirane.  
Cel: 069 20 95 862  
E-mail: burhanhafizi@gmail.com

VENDODHJA  
Bashkia Mirdite

TITULLI I PROJEKTIT  
RIKONSTRUKSION SHKARKUESI  
KATASTROFIK ,MALAJ 1

FAZA E PROJEKTIMIT:  
PROJEKT ZBATIMI

TITULLI I VIZATIMIT:  
PROFLET TERTHORE

Grupi i Projektimit  
Ing. Burhan HAFIZI Shkalla 1:100

Ing. Servet VERÇANI Data: Qershor 2024  
Ing. Gerti HAFIZI FLETA Nr. 10





PROFLET TERTHORE

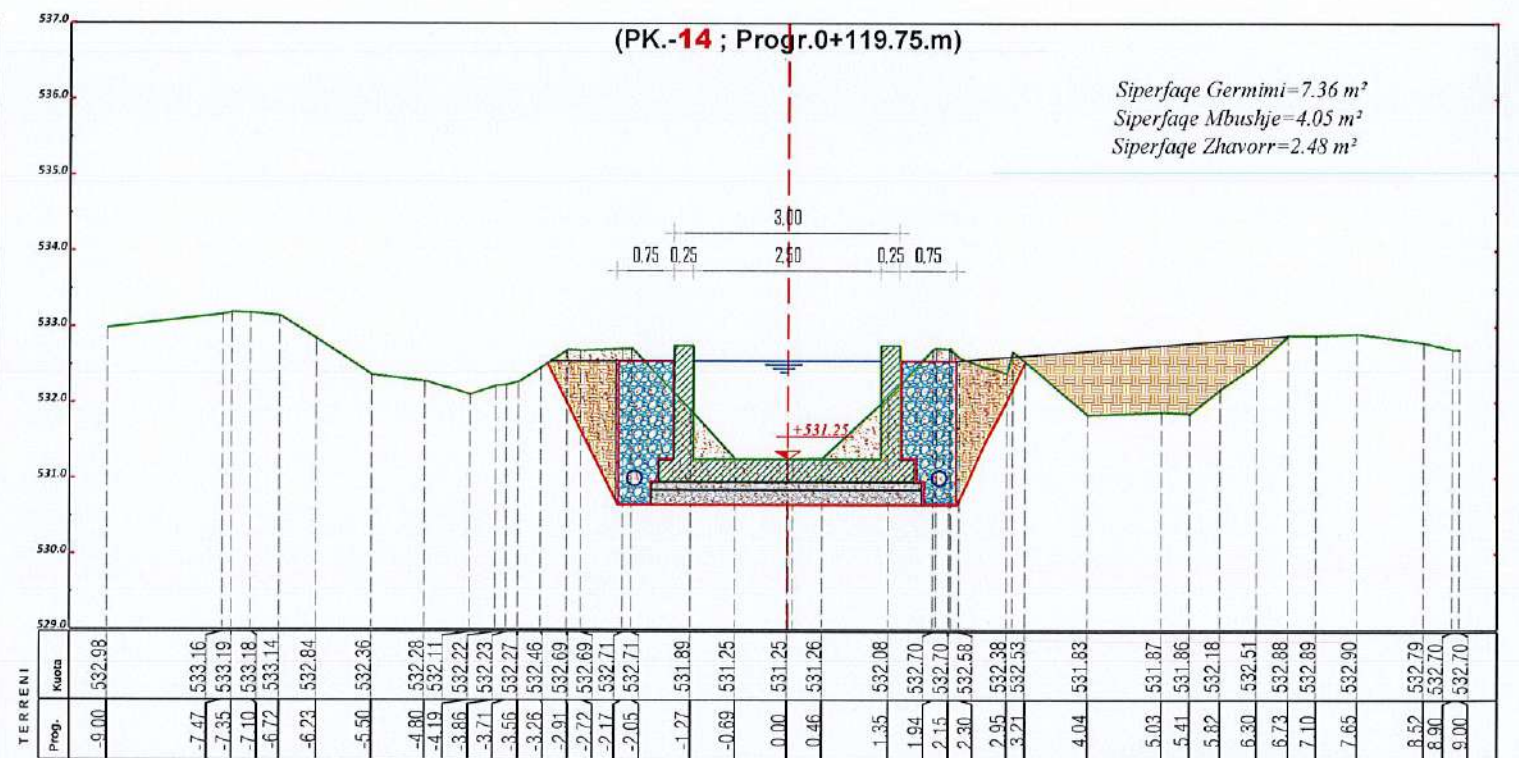
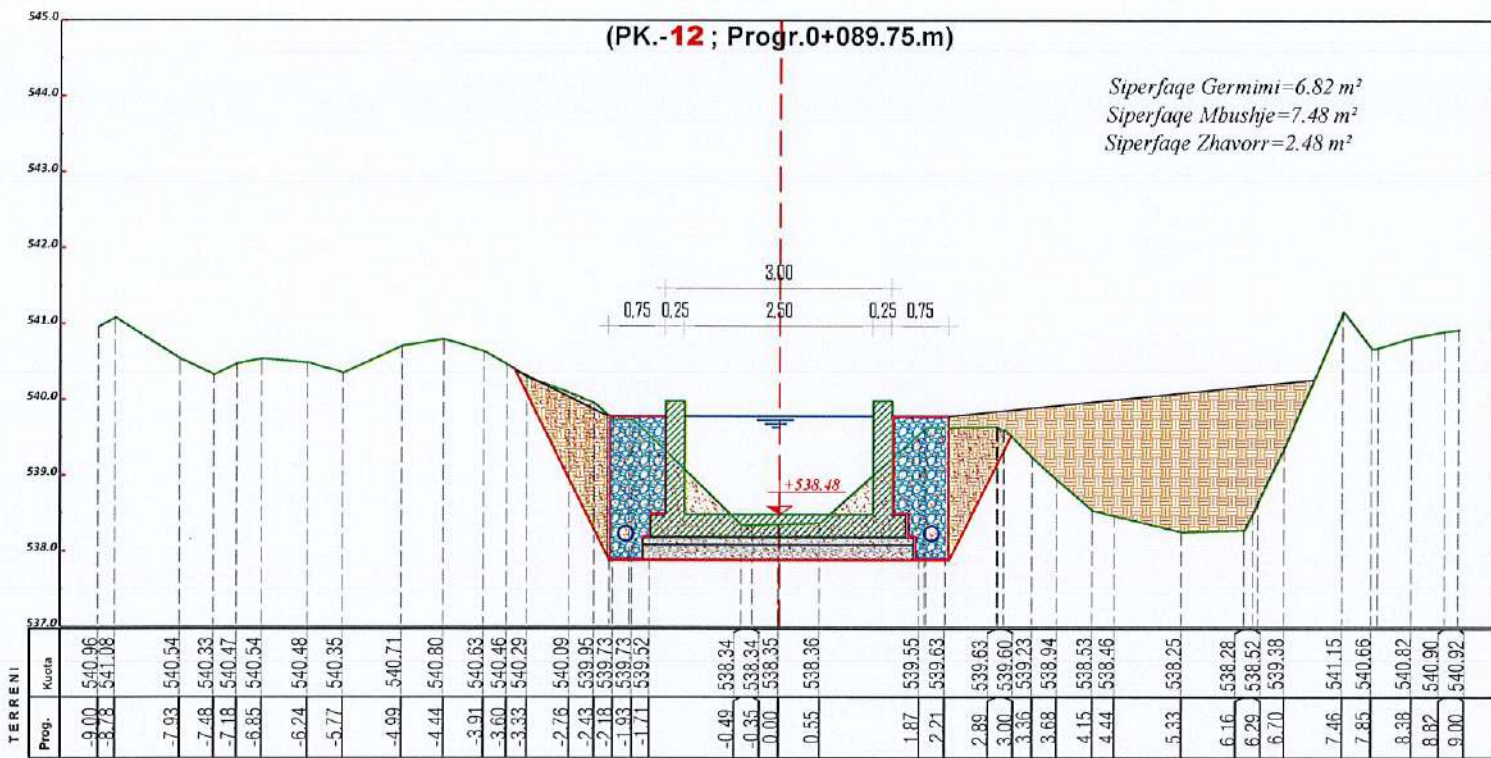
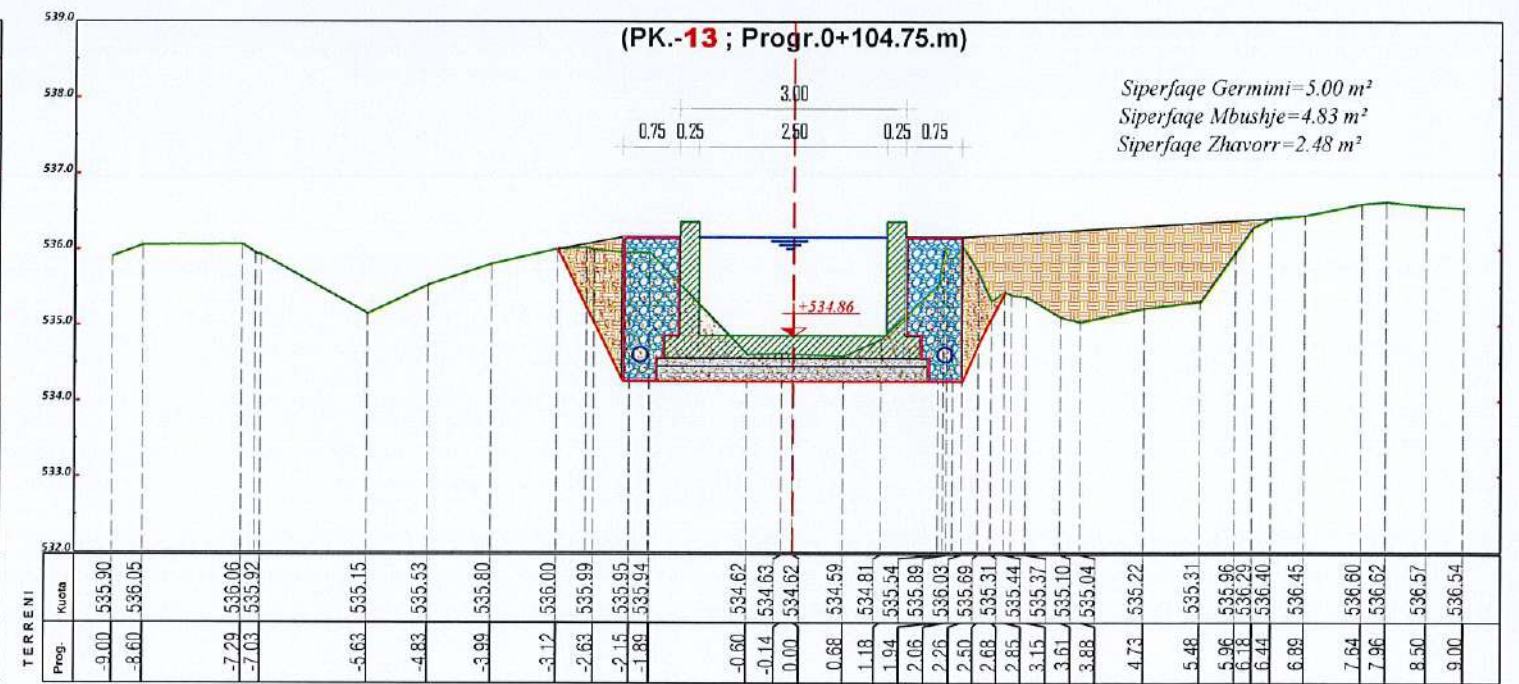
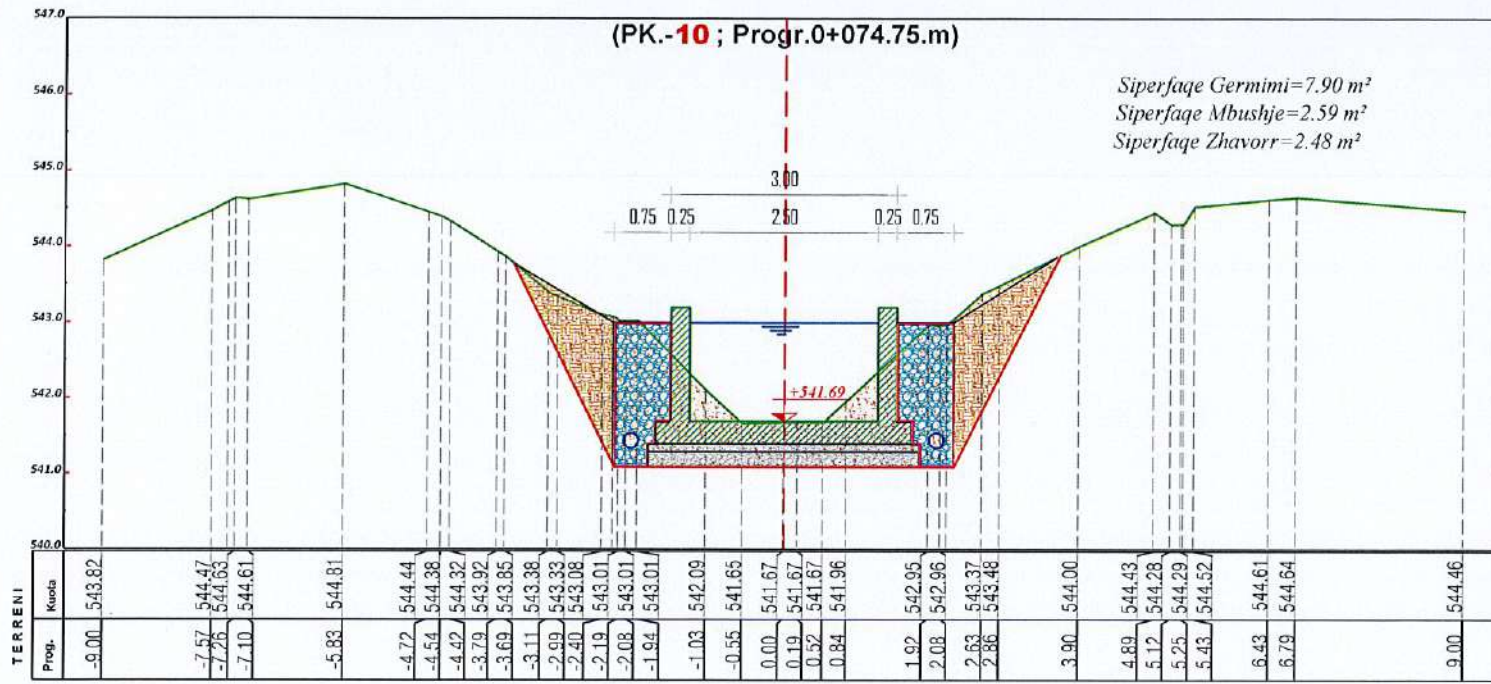

POROSITESI

BASHKIA MIRDITE



"ANGERBA" sh.p.k.

Adresa:Rr."Irfan Tomini" Tirane.  
Cel: 069 20 95 862  
E-mail: burhanhafizi@gmail.com

VENDODHJA  
Bashkia Mirdite

TITULLI I PROJEKTIIT  
RIKONSTRUKSION SHKARKUESI  
KATASTROFIK ,MALAJ I

FAZA E PROJEKTIMIT:  
PROJEKT ZBATIMI

TITULLI I VIZATIMIT:  
PROFLET TERTHORE

Grupi i Projektimit

Ing. Burhan HAFIZI  
Ing. Servet VERÇANI  
Ing. Gerti HAFIZI



Shkalla 1:100

Data: Qershor 2024

FLETA Nr. 11



PROFLET TERTHORE

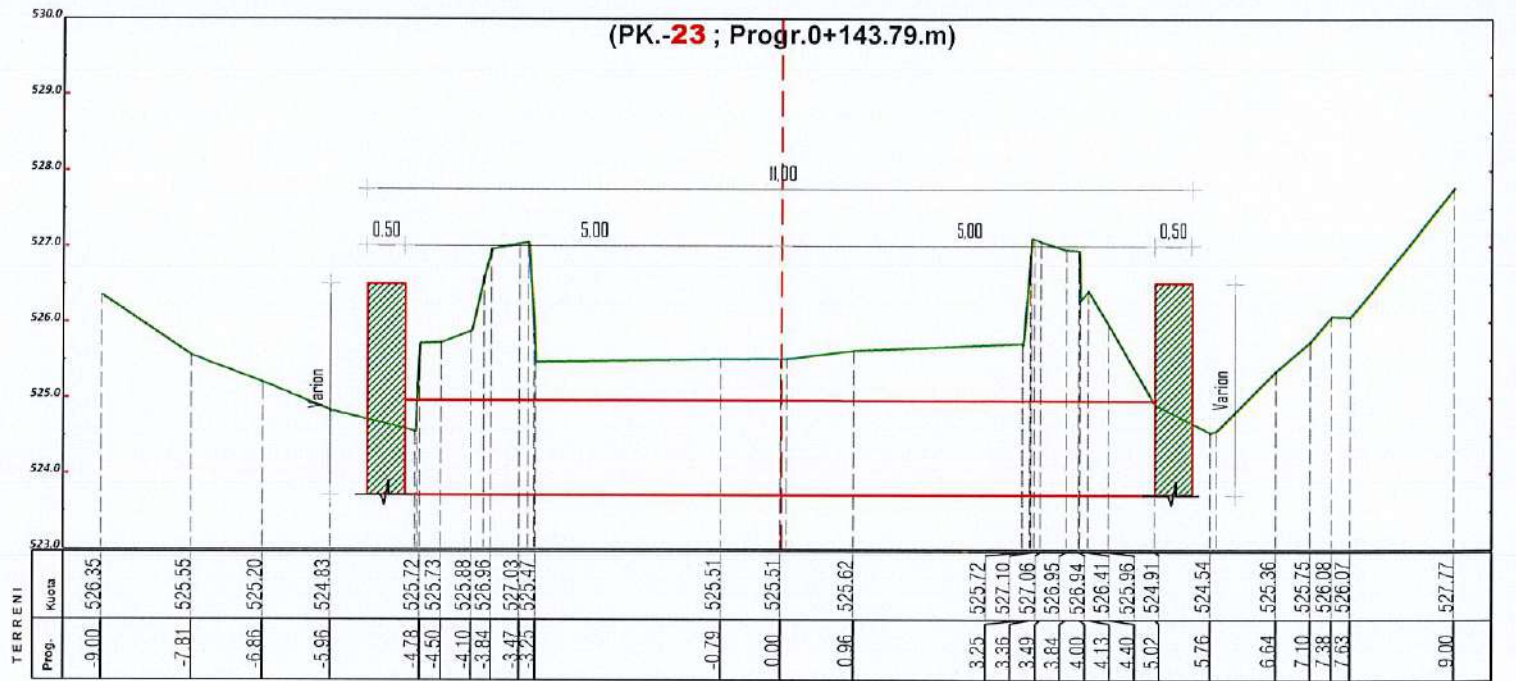
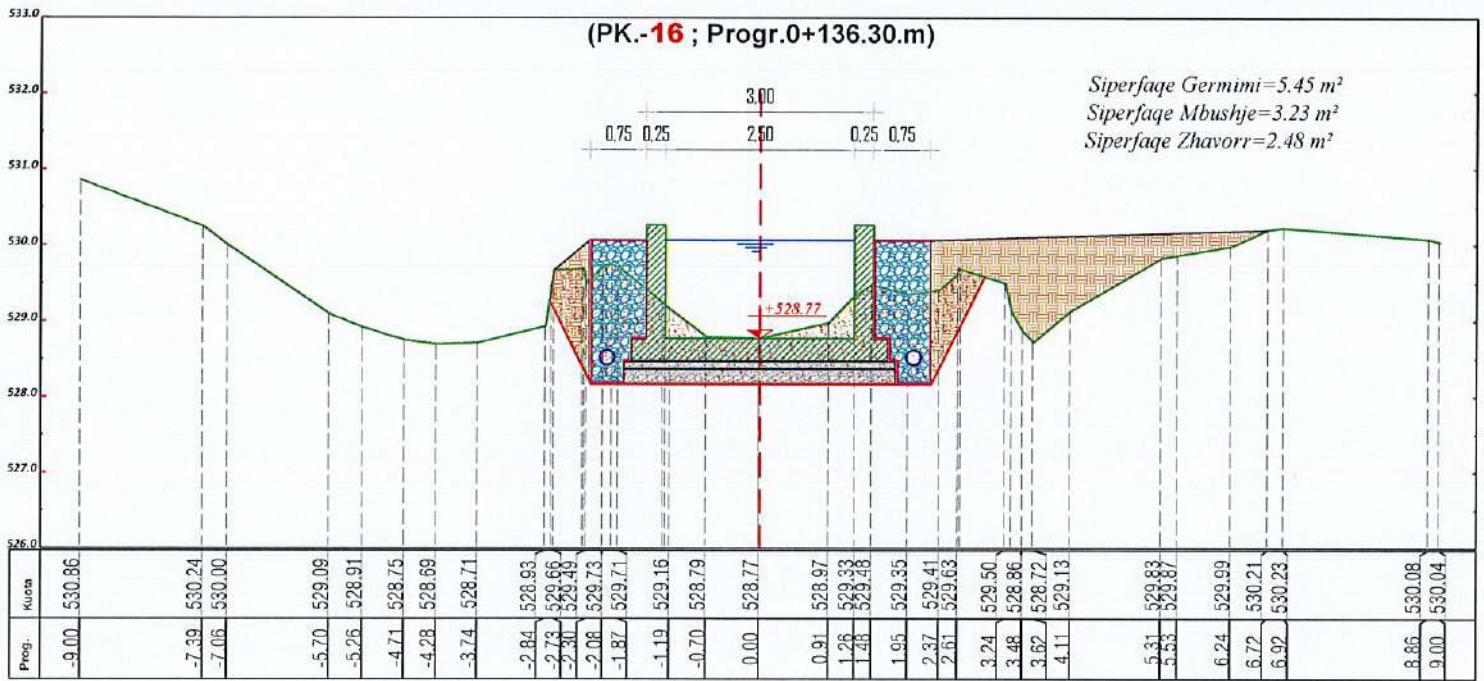
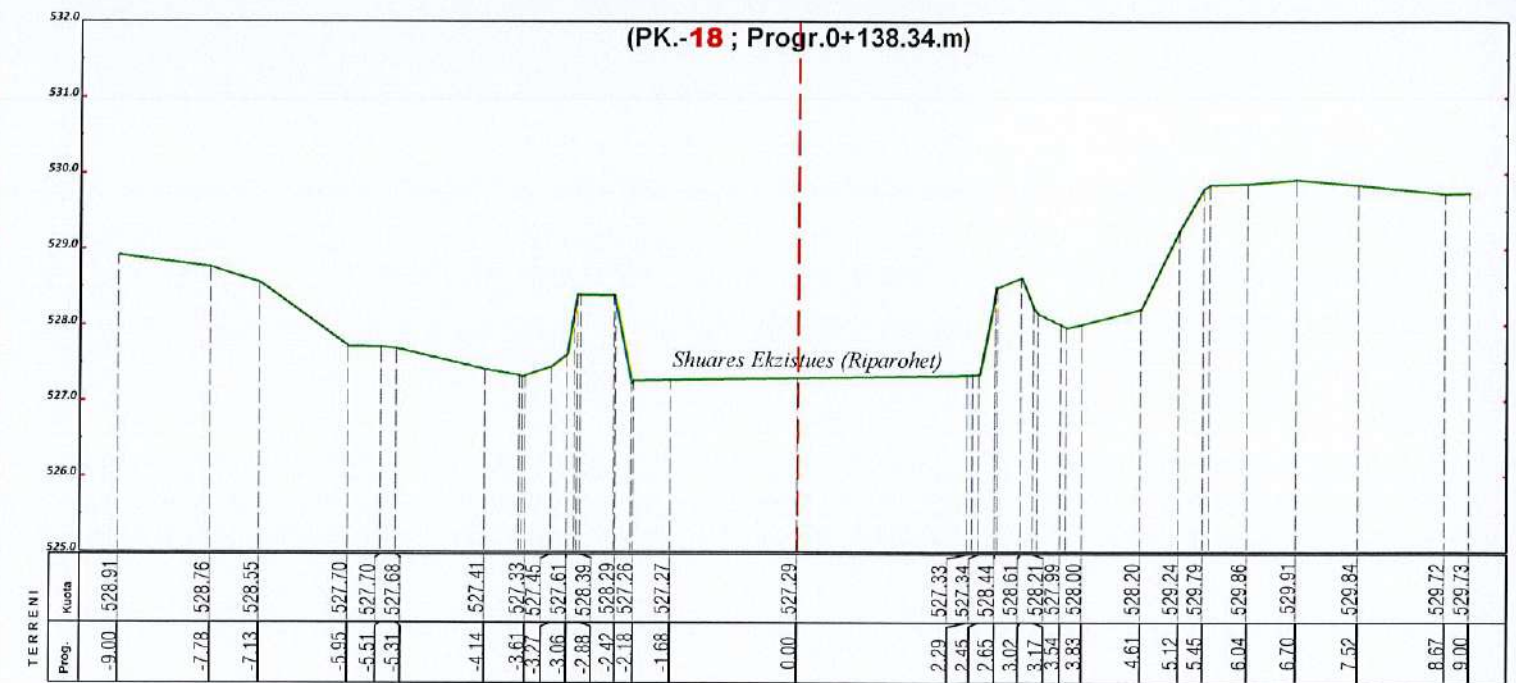
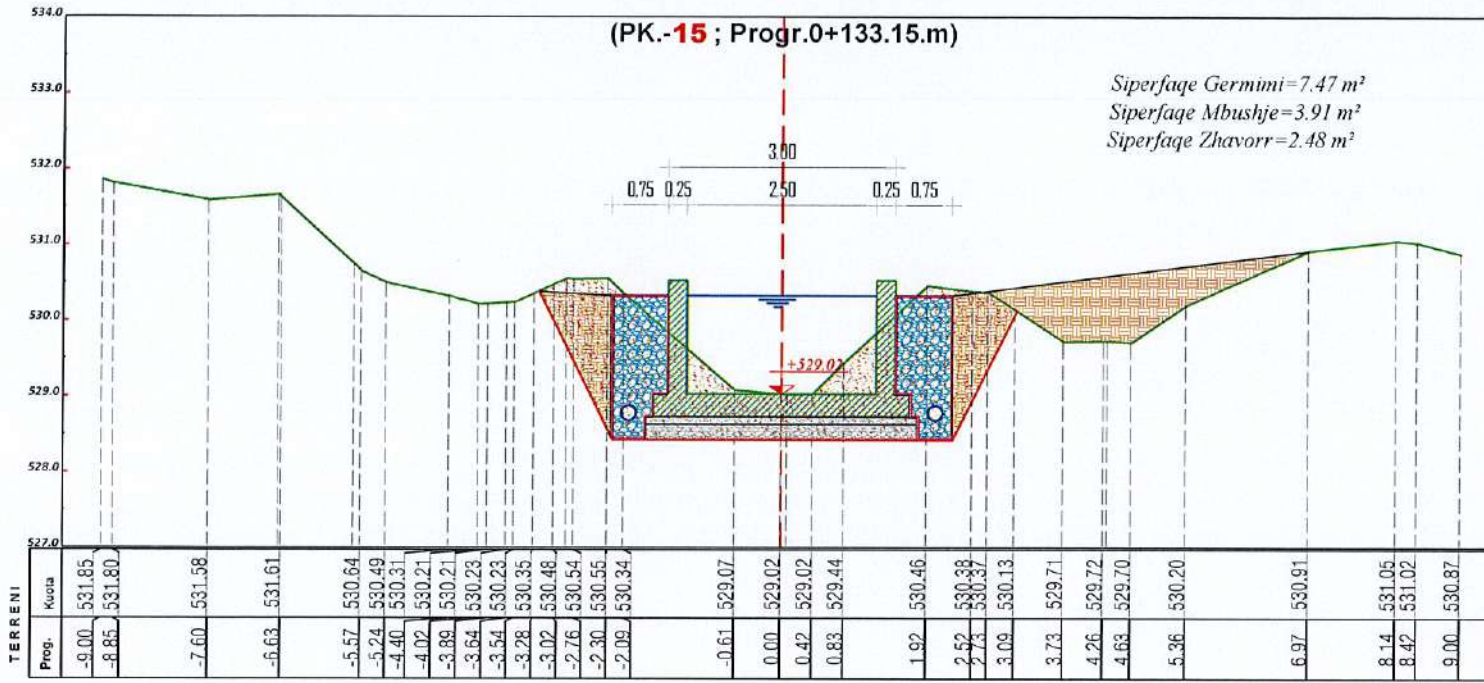

POROSITESI

BASHKIA MIRDITE



"ANGERBA" sh.p.k.

Adresa:Rr."Irfan Tomini" Tirane.  
Cel: 069 20 95 862  
E-mail: burhanhafizi@gmail.com

VENDODHIA  
Bashkia Mirdite

TITULLI I PROJEKTIT

RIKONSTRUKSION SHKARKUESI  
KATASTROFIK ,MALAJ I

FAZA E PROJEKTIMIT :

PROJEKT ZBATIMI

TITULLI I VIZATIMIT :

PROFLET TERTHORE

Grupi i Projektimit

Ing. Burhan HAFIZI

Ing. Servet VERÇANI

Ing. Gerti HAFIZI



Shkalla 1:100

Data: Qershor 2024

FLETA Nr. 12



PROFLET TERTHORE

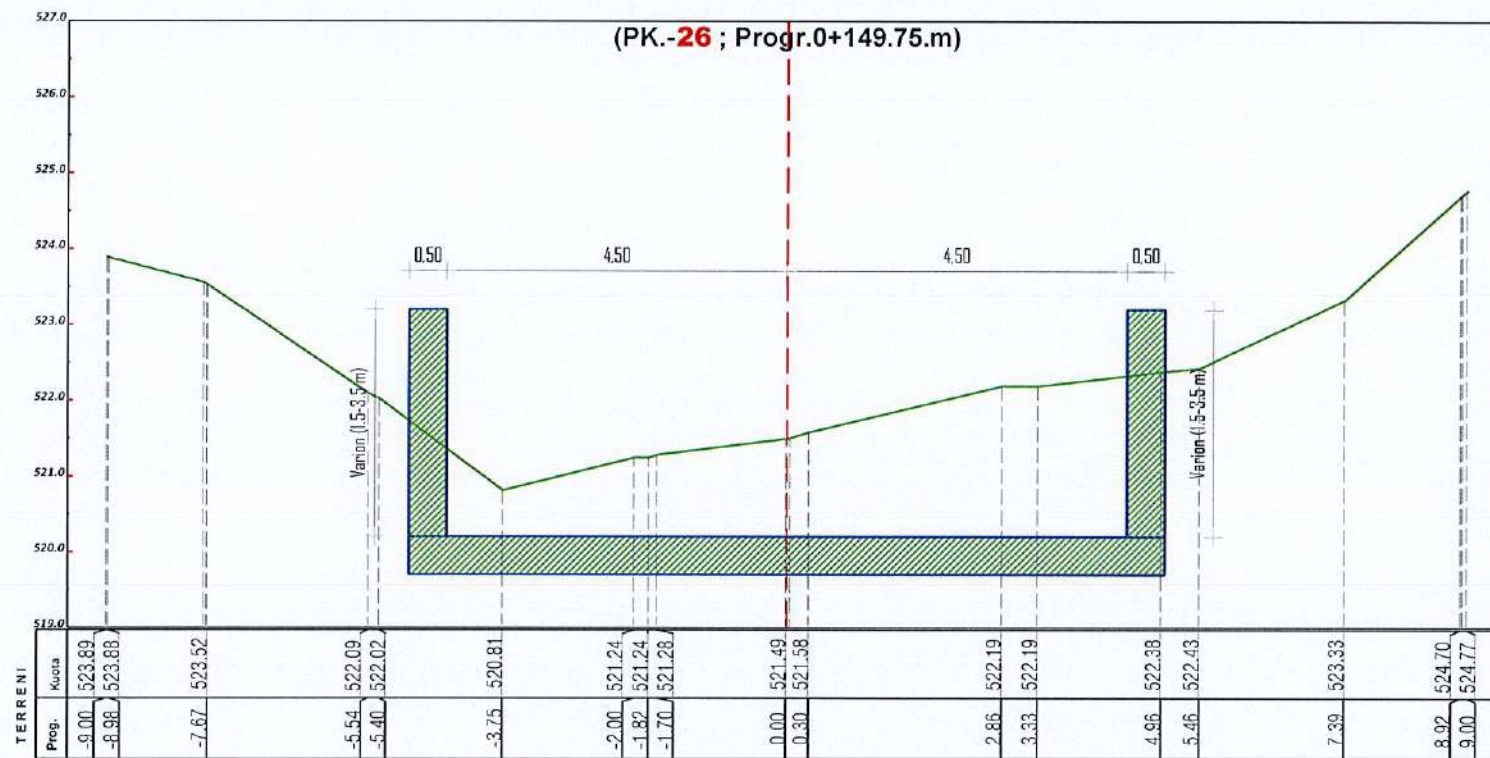
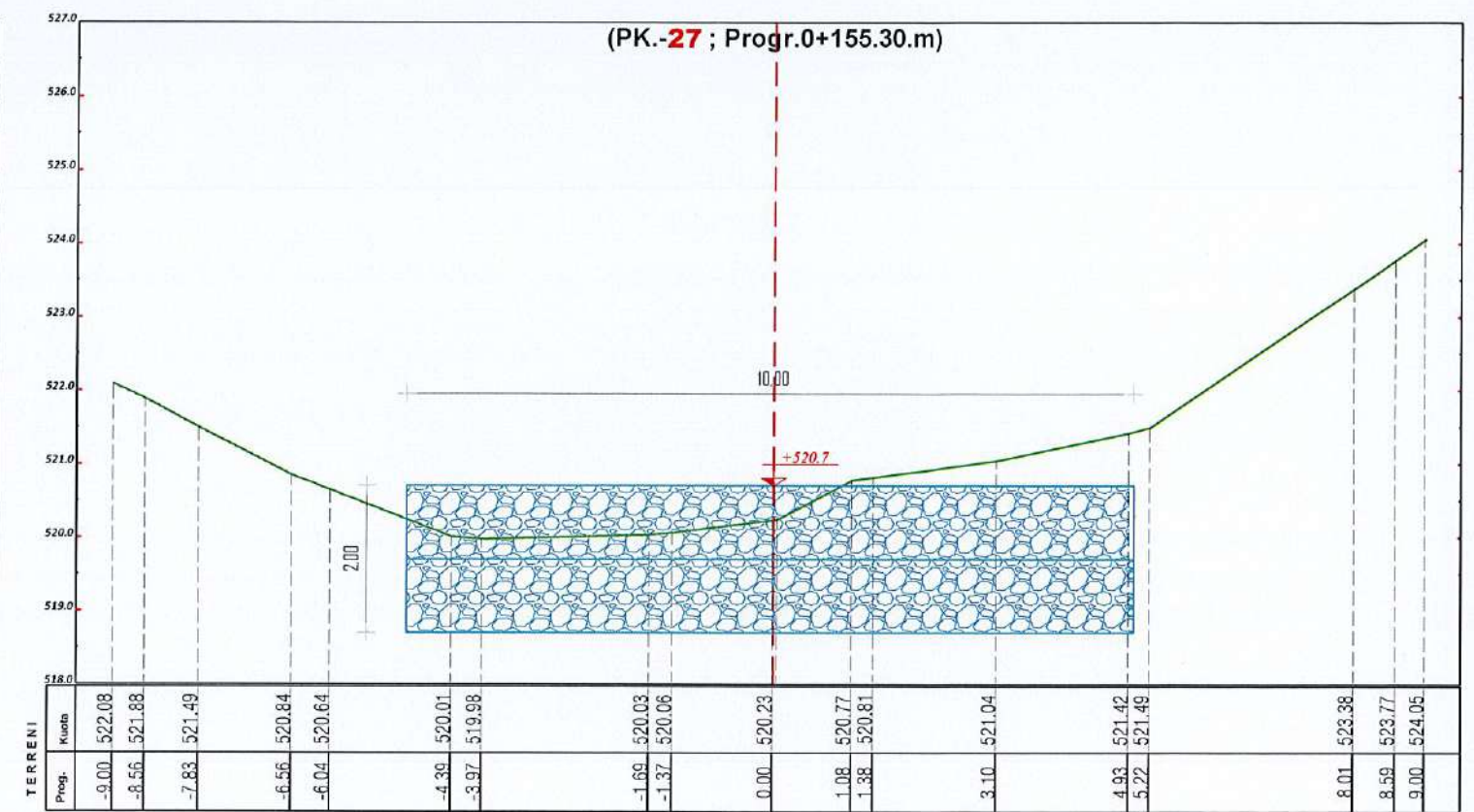
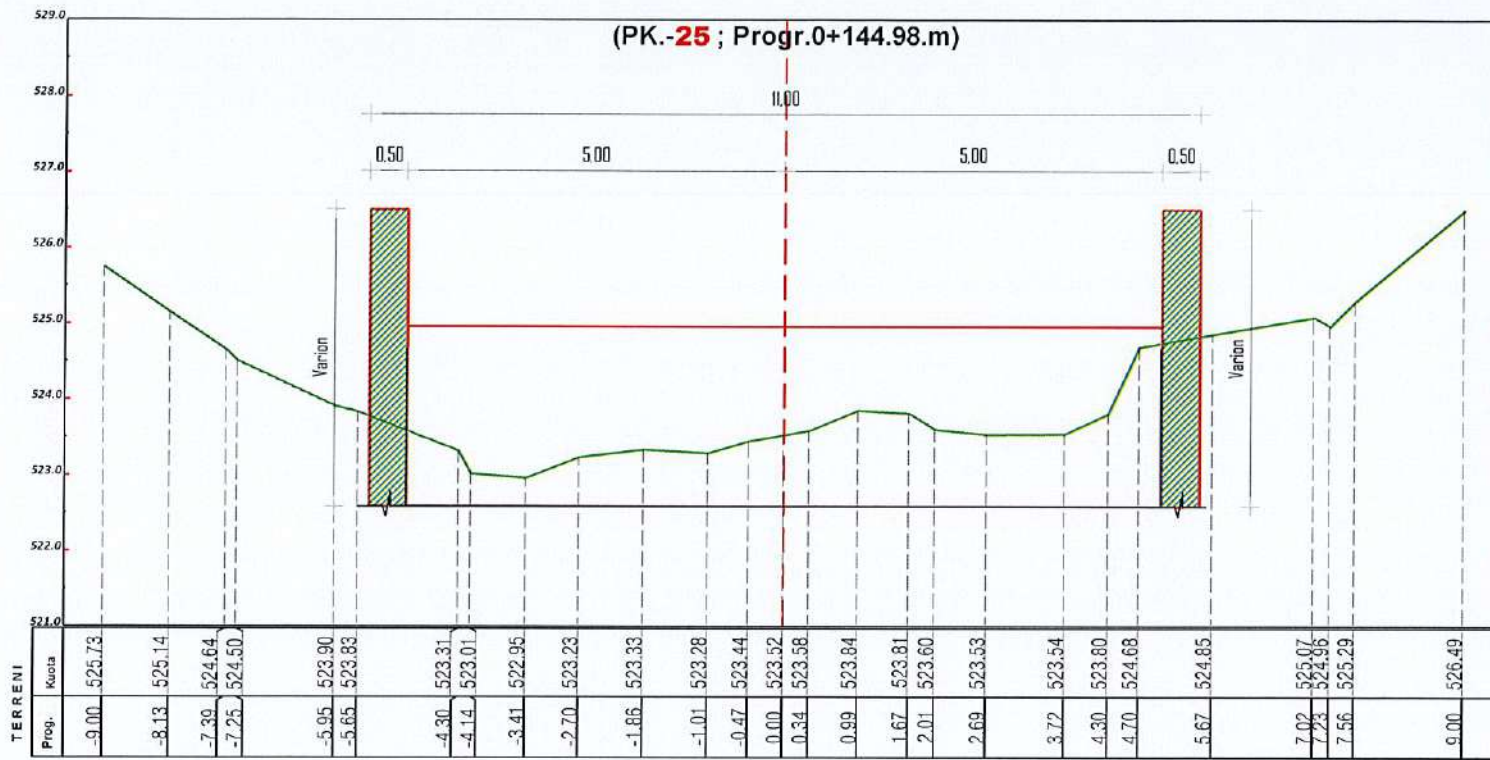

POROSITESI

BASHKIA MIRDITE



"ANGERBA" sh.p.k.  
Adresa: Rr. "Irfan Tomini" Tirane.  
Cel: 069 20 95 862  
E-mail: burhanhafizi@gmail.com

VENDODHJA  
Bashkia Mirdite

TITULLI I PROJEKTIIT  
RIKONSTRUKSION SHKARKUESI  
KATASTROFIK ,MALAJ 1

FAZA E PROJEKTIMIT:  
PROJEKT ZBATIMI

TITULLI I VIZATIMIT:  
PROFLET TERTHORE

Grupi i Projektimit

Ing. Burhan HAFIZI  
Ing. Servet VERÇANI  
Ing. Gerti HAFIZI

Shkalla 1:100

Data: Qershor 2024

FLETA Nr. 13



**PROFIL TIP LUG BETONARME SH. 1:50**

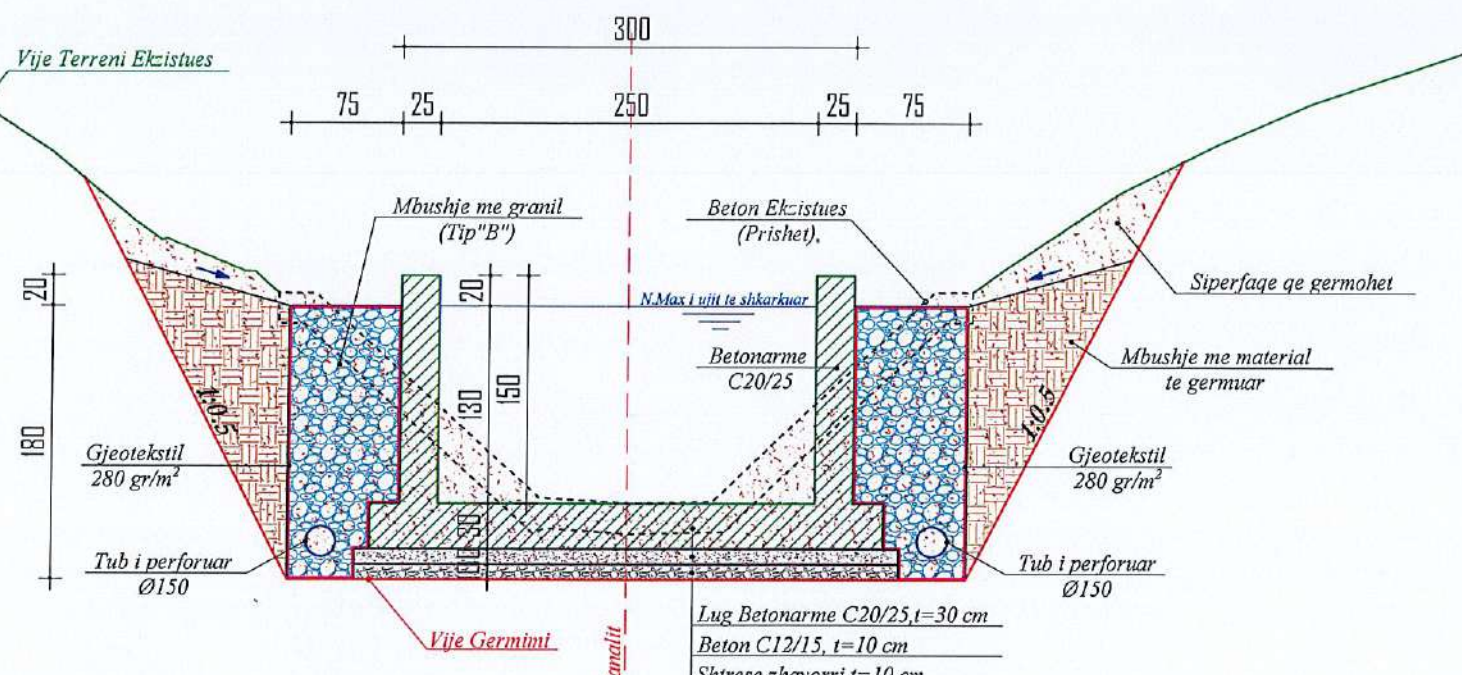

**FILTER TIPI "B"**

Materiali	% Kalimit	Sitat
	100%	63 mm
	0-50%	40 mm
	10%	20 mm

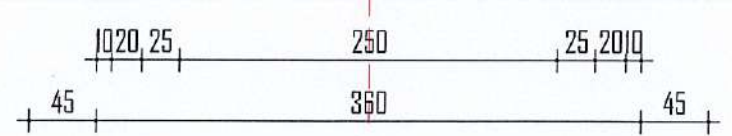

**ARMIMI I LUGUT SH. 1:50**

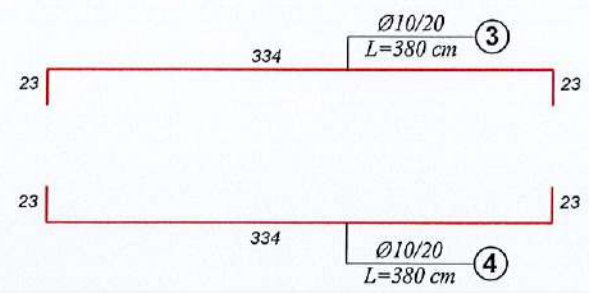
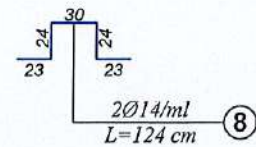
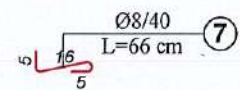
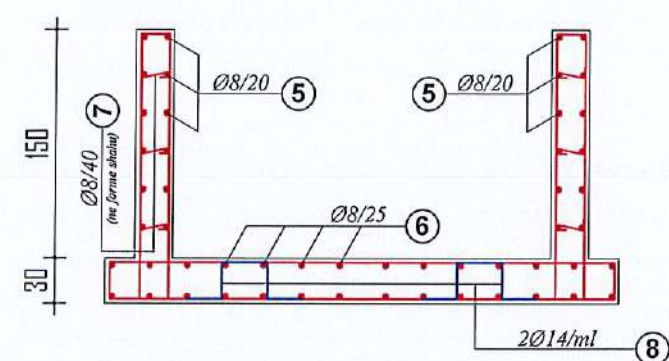
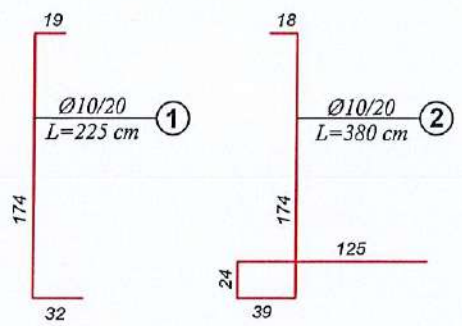

**Lugu Pk.7-16, L=75.51 ml**  
Tabela e Hekurave per 1 ml

TABELA E HEKURAVE					Permbledhese				
Nr	Ø (mm)	L (cm)	n (cope)	n x L (m)	Ø (mm)	Σn*L (m)	P (kg/m)	P (kg)	P (ton)
1	10	225	10	22.5	8	61.9	0.395	24.45	0.0245
2	10	380	10	38	10	136.5	0.617	84.22	0.0842
3	10	380	10	38	14	2.48	1.208	3.00	0.0030
4	10	380	10	38					
5	8	100	24	24					
6	8	100	28	28					
7	8	66	15	9.9					
8	14	124	2	2.48					
							φ6-10 mm (per ml)	108.67	0.1087
							φ>12 mm (per ml)	3.00	0.0030
<b>Total</b>							φ6-10 mm (per 75.51 ml)	8205.75	8.206
<b>Total</b>							φ>12 mm (per 75.51 ml)	226.22	0.226

**SHTRESE BETONARME NE PK. 1-2 SH. 1:50**

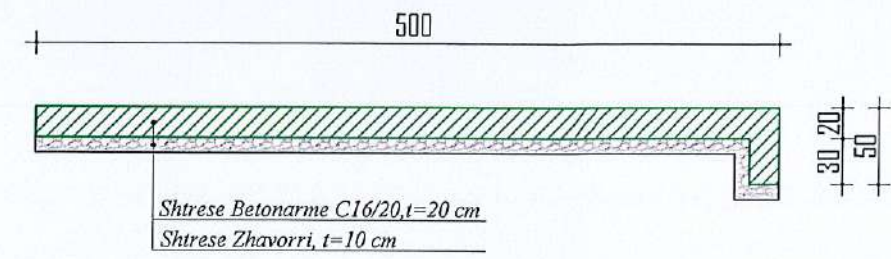

**ARMIMI I SHTRESSES NE PK. 1-2 SH. 1:50**

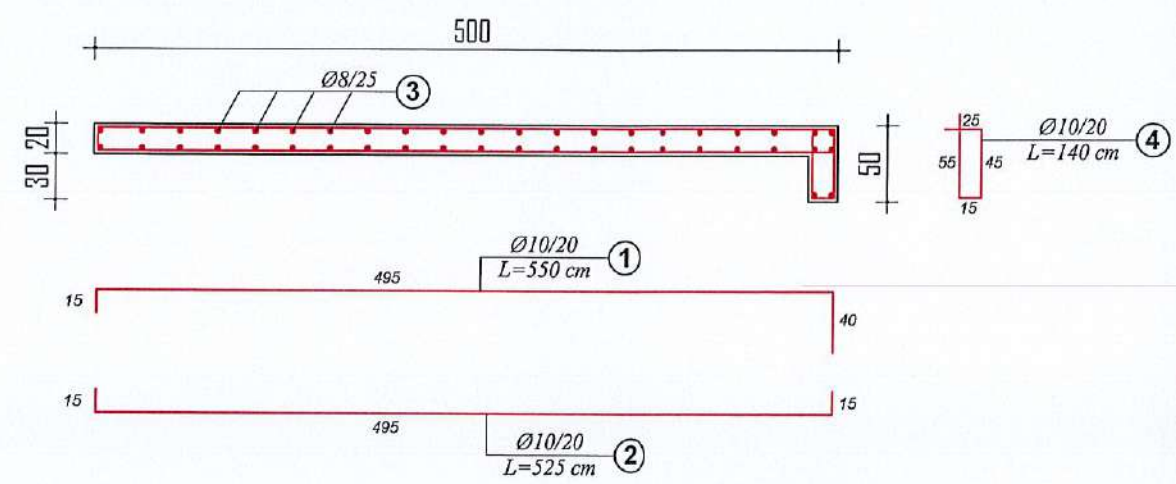

**Shtresa Betonarme**  
Tabela e Hekurave per 1 ml

TABELA E HEKURAVE					Permbledhese				
Nr	Ø (mm)	L (cm)	n (cope)	n x L (m)	Ø (mm)	Σn*L (m)	P (kg/m)	P (kg)	P (ton)
1	10	550	5	27.5	8	44	0.395	17.38	0.0174
2	10	525	5	26.25	10	60.75	0.617	37.48	0.0375
3	8	100	44	44					
4	10	140	5	7					
							φ6-10 mm (per ml)	54.86	0.0549
							φ>12 mm (per ml)	0.00	0.0000



POROSITESI

BASHKIA MIRDITE



**"ANGERBA" shpk**  
Adresa: Rr. "Irfan Tomini" Tirane.  
Cel: 069 20 95 862  
E-mail: burhanhafizi@gmail.com

VENDODHJA  
Bashkia Mirdite

TITULLI I PROJEKTIT  
RIKONSTRUKSION SHKARKUESI  
KATASTROFIK, MALAJ I

FAZA E PROJEKTIMIT:  
PROJEKT ZBATIMI

TITULLI I VIZATIMIT:  
PROFIL TIP  
ARMIMI

Grupi i Projektimit:

Ing. Burhan HAFIZI  
Ing. Servet VERÇANI  
Ing. Gerti HAFIZI

Shkalla 1:50

Data: Qershor 2024

FLETA Nr.14



PLANIMETRIA E SHUARESIT  
SH. 1:100

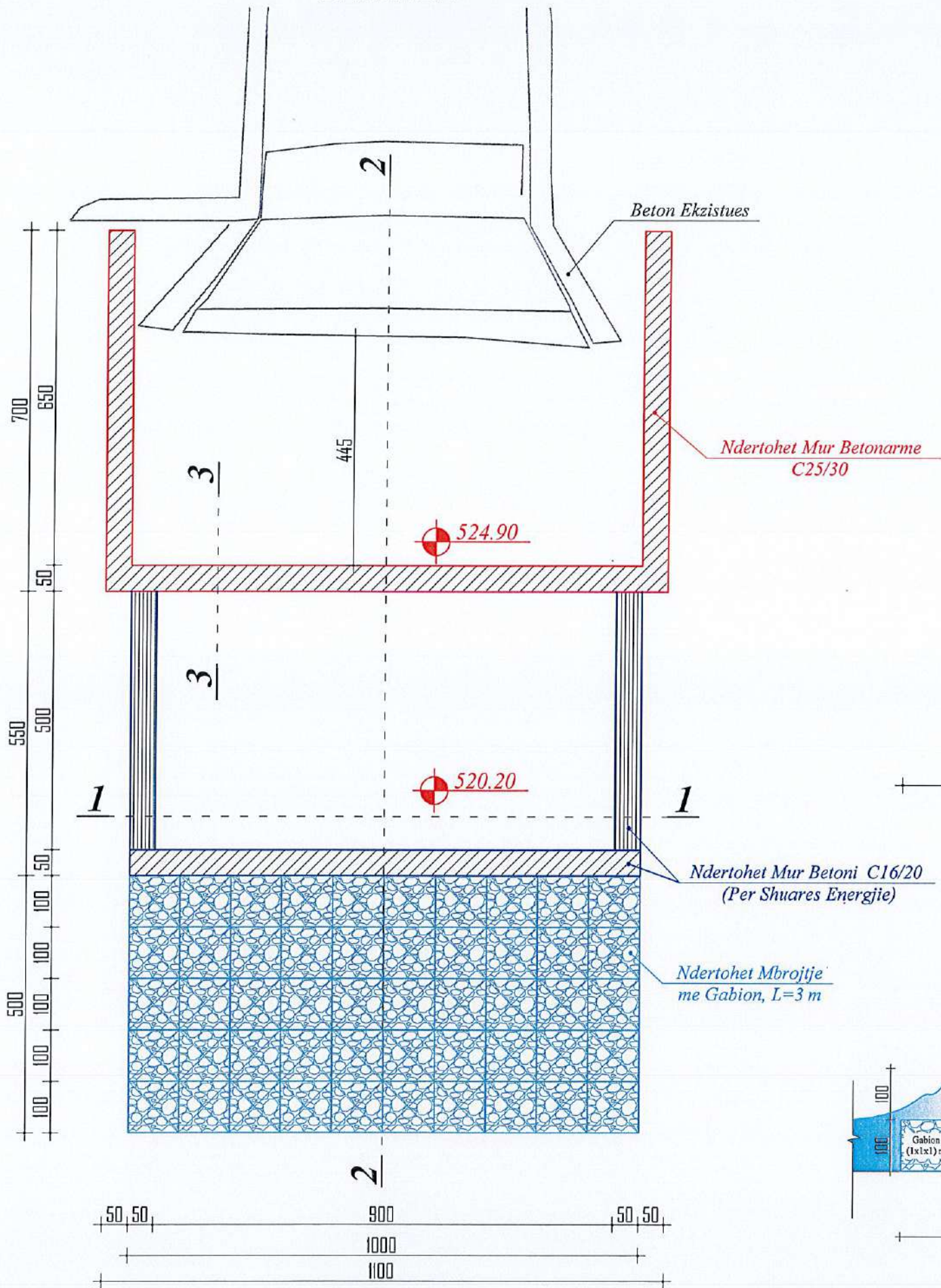

PRERJA 1-1  
SH. 1:100

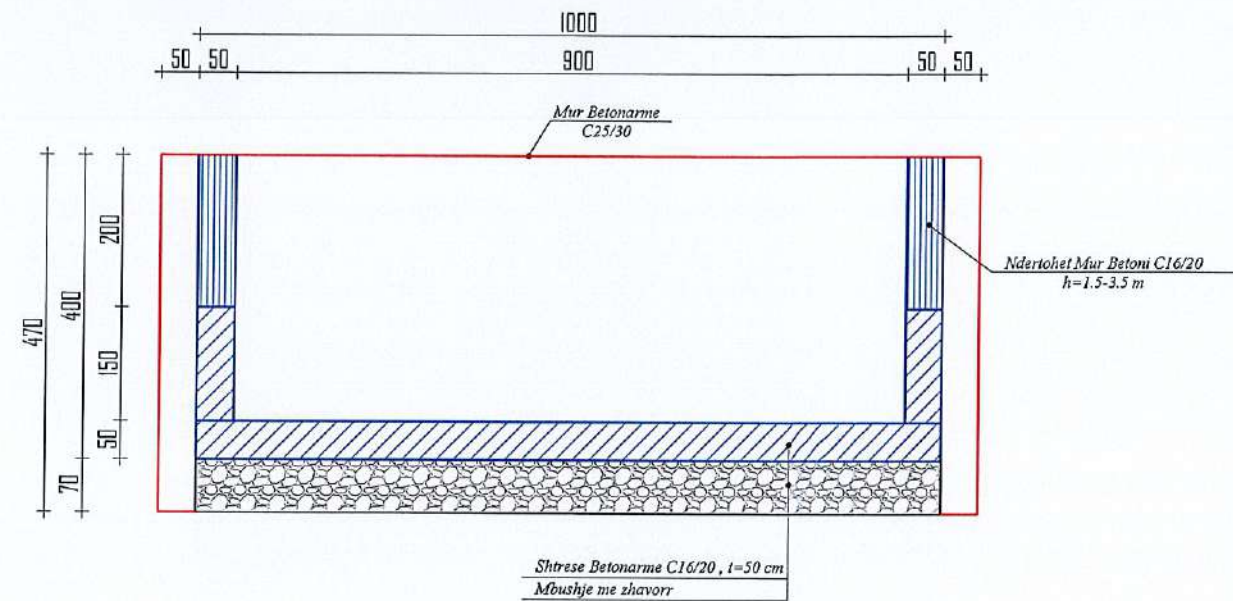

PRERJA 2-2  
SH. 1:100

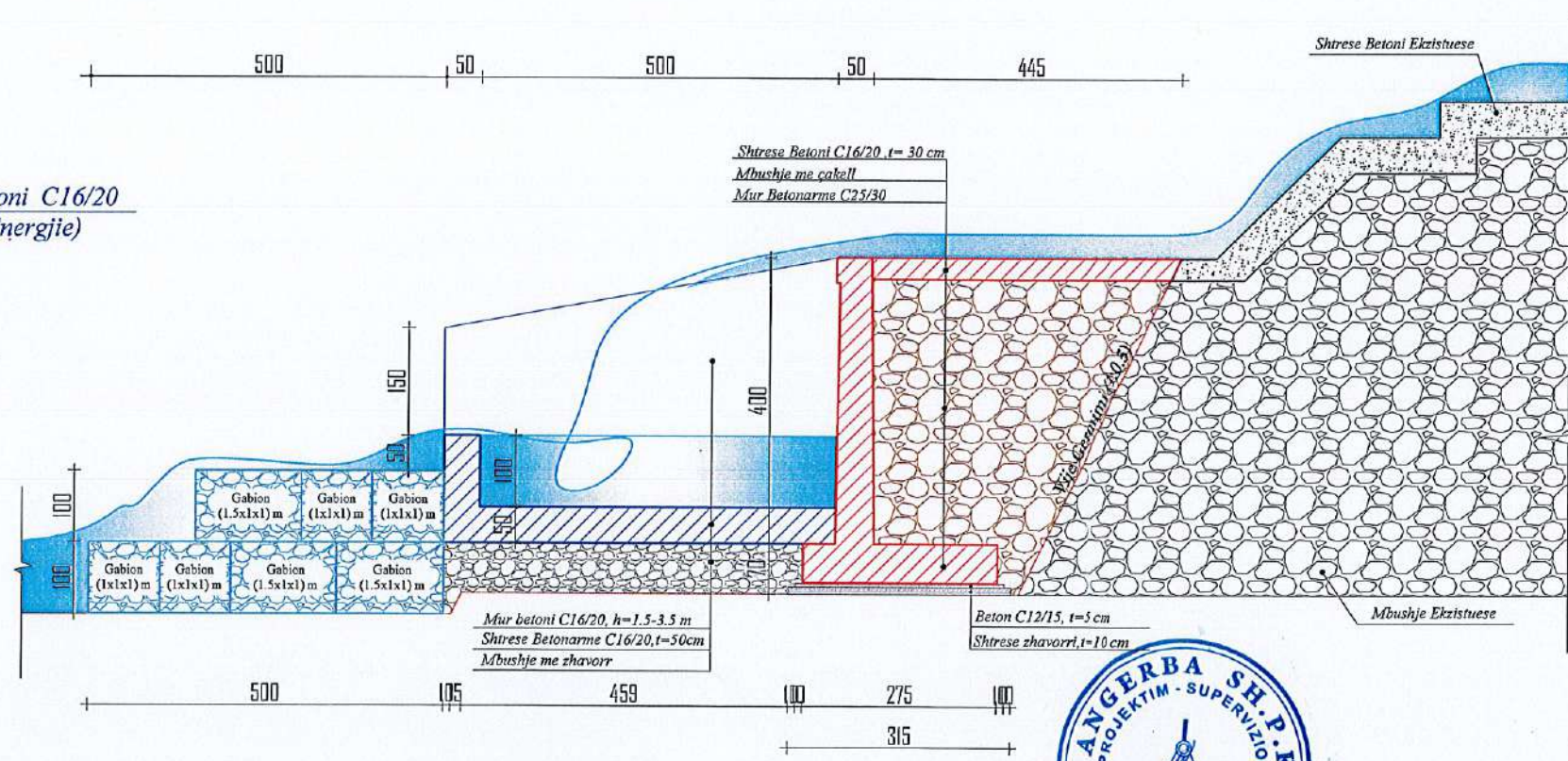

<p>POROSITESI <b>BASHKIA MIRDITE</b></p>	<p><b>"ANGERBA" shpk</b> Adresa: Rr. "Irfan Tomini" Tirane. Cel: 069 20 95 862 E-mail: burhanhafizi@gmail.com</p>	<p>VENDODHJA <i>Bashkia Mirdite</i></p> <p>TITULLI I PROJEKTIT <b>RIKONSTRUKSION SHKARKUESI KATASTROFIK, MALAJ I</b></p>	<p>FAZA E PROJEKTIMIT: <b>PROJEKT ZBATIMI</b></p> <p>TITULLI I VIZATIMIT: <b>PLANIMETRI PRERJE</b></p>	<p>Grupi Projektant: <i>Ing. Burhan HAFIZI</i> <i>Ing. Servet VERÇANI</i> <i>Ing. Gerti HAFIZI</i></p>	<p>Shkalla 1:100 Data: Qershor 2024 FLETA Nr.15</p>
--	---	--	--	--	---



PRERJA 3-3  
SH. 1:50

ARMIMI I MURIT  
SH. 1:50

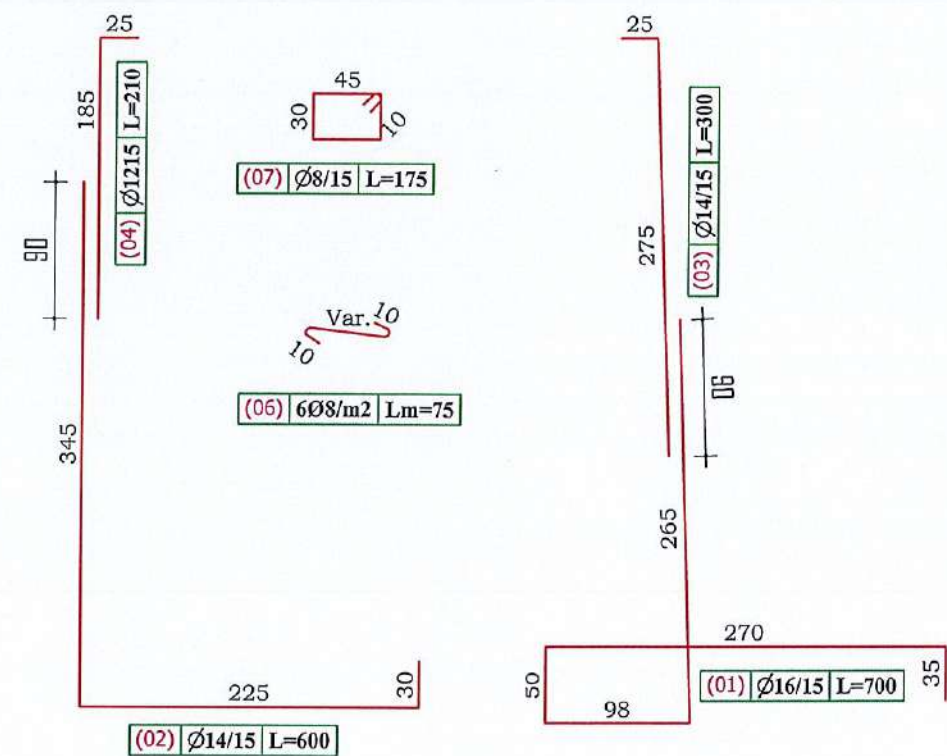
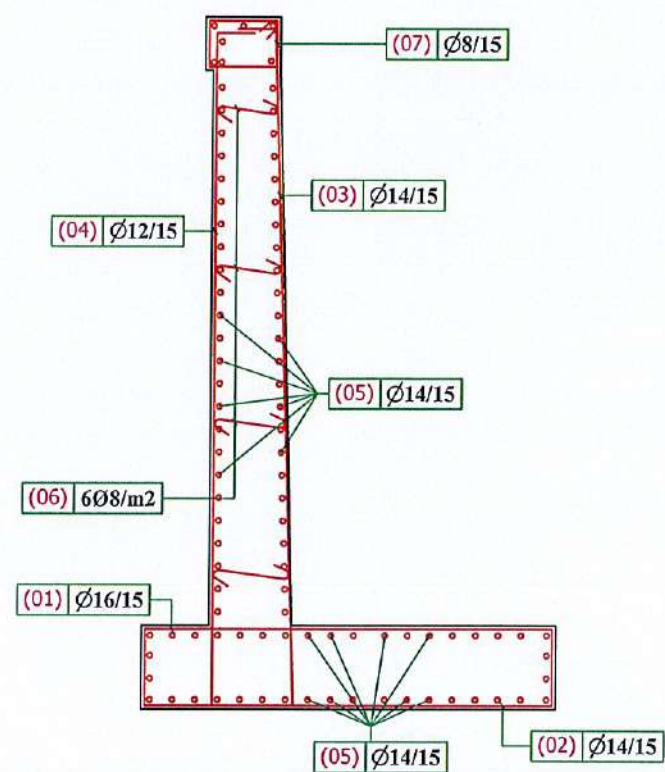
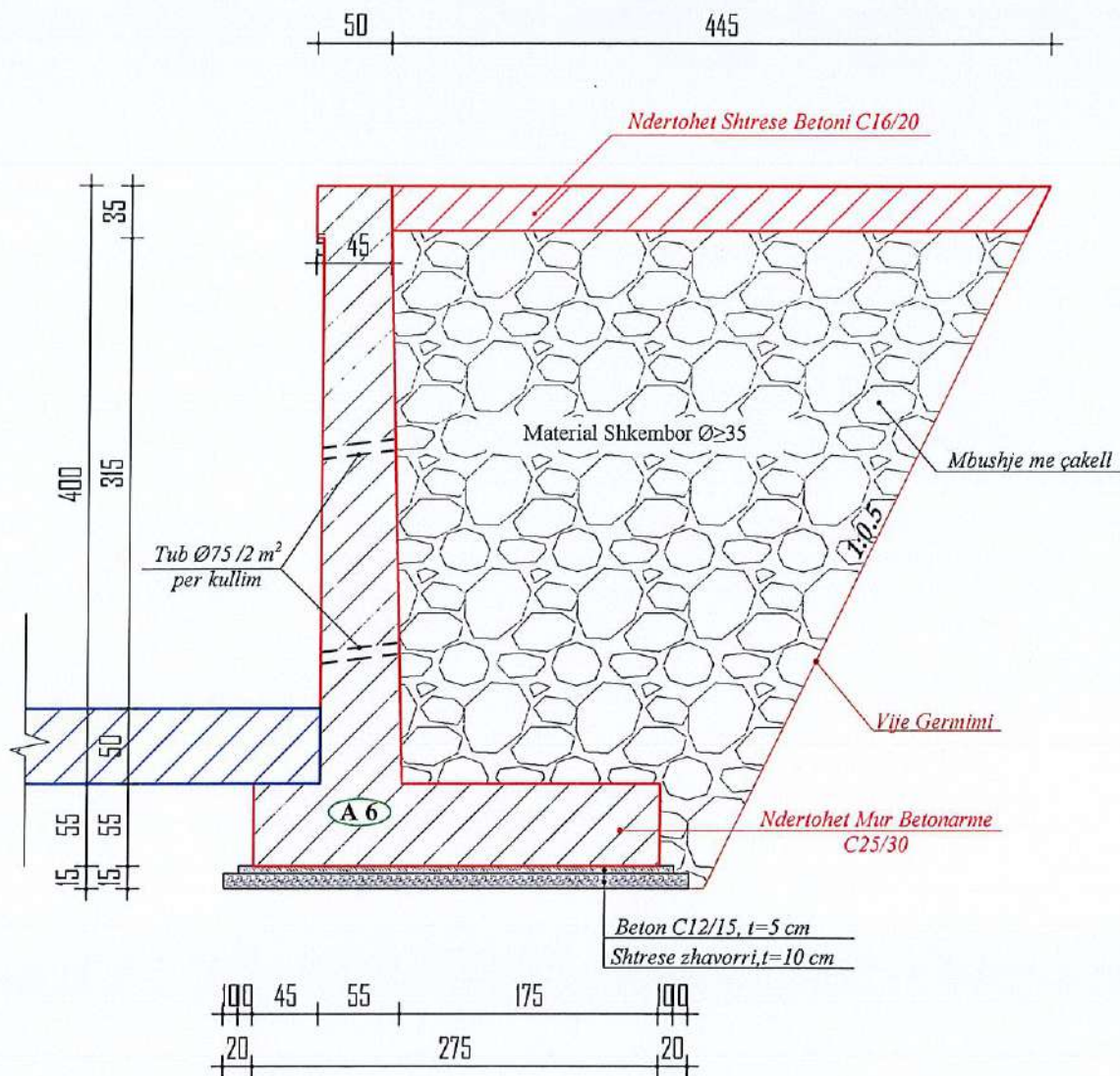

SHENIME:

- Muret janë projektuar me beton M-300 përgatitur me cimento antisulfat, armatura e hekurit e tipit Feb-44k.
- Mbushja mbrapa mureve duhet të bëhet me material me kënd të ferkimit të brendshëm  $\phi \geq 35$ .
- Ankorimi dhe xhantimi i hekurave do të bëhet me mbivendosje të tyre jo më pak se 50Ø.
- Cepat e betonit që janë të ekspozuar duhet të rumbullakosen me rreze  $r = 20$ mm.
- Ne rastet e përdorimit të lartësive ndërmjetese për permasat e betonit dhe sasine e armatures se hekurit duhet të aplikohen ato të lartësive me të modhe të afert.
- Faqet e betonit të armuar në kontakt me dheun duhet të lyhen me dy duar bitum të nxehte.
- Ne rastet e bazamenteve prej dherash shtresa e betonit të varfer 5cm, vendoset mbi një shtrese prej 10cm zhavorri të imet. Ne rastet e taboneve shkembor e gjysem shkembor shtresa e zhavorrit nuk është e nevojshme.
- Te realizohen fuga 4-5 cm cdo 12-15 ml gjatesi muri
- Themeli i murit të vendoset në një thellesi të atille që të sigurohet nga rreshqitja (Sipas rekomandimeve të Inxhinierit Rezident).

Tabela e Volumit të Betonit për Murin, H=4 m (Per 1 ml)

Nr	Elementi	Sipërfaqja	Sasia	Gjatesia	Volumi
		m <sup>2</sup>	Cope	ml	m <sup>3</sup>
1	Beton i Varfer	0.1475	1	1	0.1475
2	Beton C25/30 për murin	3.52	1	1	3.52

Tabela e Hekurave për 1 ml Mur

TABELA E HEKURAVE					Përmbledhese			
Nr	Ø (mm)	L (cm)	n (cope)	nxL (m)	Ø (mm)	Σn*L (m)	P (kg/m)	P (kg)
1	16	700	7	49	8	28.75	0.395	11.36
2	14	600	7	42	12	14.7	0.888	13.05
3	14	300	7	21	14	158	1.208	190.86
4	12	210	7	14.7	16	49	1.578	77.32
5	14	100	95	95				
6	8	75	22	16.5				
7	8	175	7	12.25				
Sasia e Hekurit për 1 ml mur					Ø6-10 mm		11.36	
					Ø>10 mm		281.24	

POROSITESI

BASHKIA MIRDITE



"ANGERBA" shpk

Adresa: Rr. "Irfan Tomini" Tirane.  
Cel: 069 20 95 862  
E-mail: burhanhafizi@gmail.com

VENDODHJA  
Bashkia Mirdite

TITULLI I PROJEKTIT  
RIKONSTRUKSION SHKARKUESI  
KATASTROFIK, MALAJ I

FAZA E PROJEKTIMIT:  
PROJEKT ZBATIMI

TITULLI I VIZATIMIT:  
PRERJA DHE ARMIMI I  
MURIT

Ing. Burhan HAFIZI  
Ing. Servet VERÇANI  
Ing. Gerti HAFIZI



Shkalla 1:50

Data: Qershor 2024

FLETA Nr.16



ARMIMI I DYSHEMESE (PRERJA A-A)  
SH.1:50

(01) (02) Ø10/20

(03) Ø10/20

Ndertohej Mur Betoni C16/20  
(Per Shuares Energie)

50 500

(04) Ø10/20 L=340

(01) Ø10/20 L=615

(04) Ø10/20

(01) Ø10/20

(05) Ø8

(03) Ø10/20

(02) Ø10/20

(05) 6Ø8/m2 Lm=65

(02) Ø10/20 L=615

Tabela e Hekurave per 1 ml te dyshemese se Pusit te Shuarjes

TABELA E HEKURAVE					Permbledhese			
Nr	Ø (mm)	L (cm)	n (cope)	nxL (m)	Ø (mm)	Σn*L (m)	P (kg/m)	P (kg)
1	10	615	5	30.75	8	3.9	0.395	1.54
2	10	615	5	30.75	10	142.5	0.617	87.92
3	10	100	64	64				
4	10	340	5	17				
5	8	65	6	3.9				
<b>Sasia e Hekurit per 1 ml</b>					<b>φ6-10 mm</b>		<b>89.46</b>	
					<b>φ&gt;10 mm</b>		<b>0.00</b>	



POROSITESI

BASHKIA MIRDITE



"ANGERBA" shpk

Adresa:Rr."Irfan Tomini" Tirane.  
Cel: 069 20 95 862  
E-mail: burhanhafizi@gmail.com

VENDODHJA  
Bashkia Mirdite

TITULLI I PROJEKTTIT  
RIKONSTRUKSION SHKARKUESI  
KATASTROFIK, MALAJ 1

FAZA E PROJEKTIMIT:  
PROJEKT ZBATIMI

TITULLI I VIZATIMIT:  
PUSI I SHUARJES  
ARMIMI

Grupi i Projektimit

Ing. Burhan HAFIZI  
Ing. Servet VERÇANI  
Ing. Gerti HAFIZI

Shkalla 1:50; 1:75

Data: Qershor 2024

FLETA Nr.17