

BASHKIA VAU DEJES

PROJEKT - ZBATIMI

*OBJEKTI : "SISTEMIM ASFALTIM I RRUGES SE
MALESOREVE, NJESIA ADMINISTRATIVE BUSHAT"*

POROSITES:

BASHKIA VAU DEJES

PROJEKTUES:

"ANGERBA" SH.P.K.



MARS 2023

"SISTEMIM ASFALTIM I RRUGES SE MALESOREVE" BASHKIA VAU DEJES

LISTA E FLETEVE

1.HARTA E ZONES (GJURMA MBI HARTEN TOPOGRAFIKE)	SH 1: 10 000	FLETA NR. 1
2.PLANIMETRIA E PERGJITHSHME (GJURMA MBI IMAZHIN ORTOFOTO)	SH 1: 1 500	FLETA NR. 2
3.RILEVIMI TOPOGRAFIK	SH 1: 1 500	FLETA NR. 3
4.PLANIMETRIA E RRUGES KRYESORE (GJURMA MBI DHE PA IMAZHIN ORTOFOTO)	SH 1: 250	FLETA NR. 4-6
5.PROFILI GJATESOR I RRUGES KRYESORE	SH. H = 1:1 000;V=1: 100	FLETA NR. 7
6.PROFILA TERTHORE TE RRUGES KRYESORE	SH 1: 100	FLETA NR. 8-12
7.TABELA E VOLUMEVE E RRUGES KRYESORE		1 FLETE
8.SEKSION TERTHORE TIP I RRUGES KRYESORE	SH 1: 25	FLETA NR.13-14
9.TOMBINO Ø 600 mm,L = 8 m	SH 1: 50	FLETA NR.15
10.TOMBINO Ø 600 mm,L = 15 m	SH 1: 50	FLETA NR.16-17

DEGA E DJATHTE

1.PLANIMETRIA E RRUGES (GJURMA MBI DHE PA IMAZHIN ORTOFOTO)	SH 1: 250	FLETA NR. 1-3
2.PROFILI GJATESOR I RRUGES	SH. H = 1:1 000;V=1: 100	FLETA NR. 4
3.PROFILA TERTHORE TE RRUGES DHE TABELA E VOLUMEVE	SH 1: 100	FLETA NR. 5-11
4.SEKSION TERTHORE TIP I RRUGES	SH 1: 25	FLETA NR.12
5.TOMBINO Ø 600 mm,L = 6 m	SH 1: 50	FLETA NR.13

DEGA E MAJTE

1.PLANIMETRIA E RRUGES (GJURMA MBI DHE PA IMAZHIN ORTOFOTO)	SH 1: 250	FLETA NR. 1-2
2.PROFILI GJATESOR I RRUGES	SH. H = 1:1 000;V=1: 100	FLETA NR. 3
3.PROFILA TERTHORE TE RRUGES	SH 1: 100	FLETA NR. 4-6
4.TABELA E VOLUMEVE E RRUGES KRYESORE		1 FLETE
5.SEKSION TERTHORE TIP I RRUGES	SH 1: 25	FLETA NR.7



HARTA E ZONES

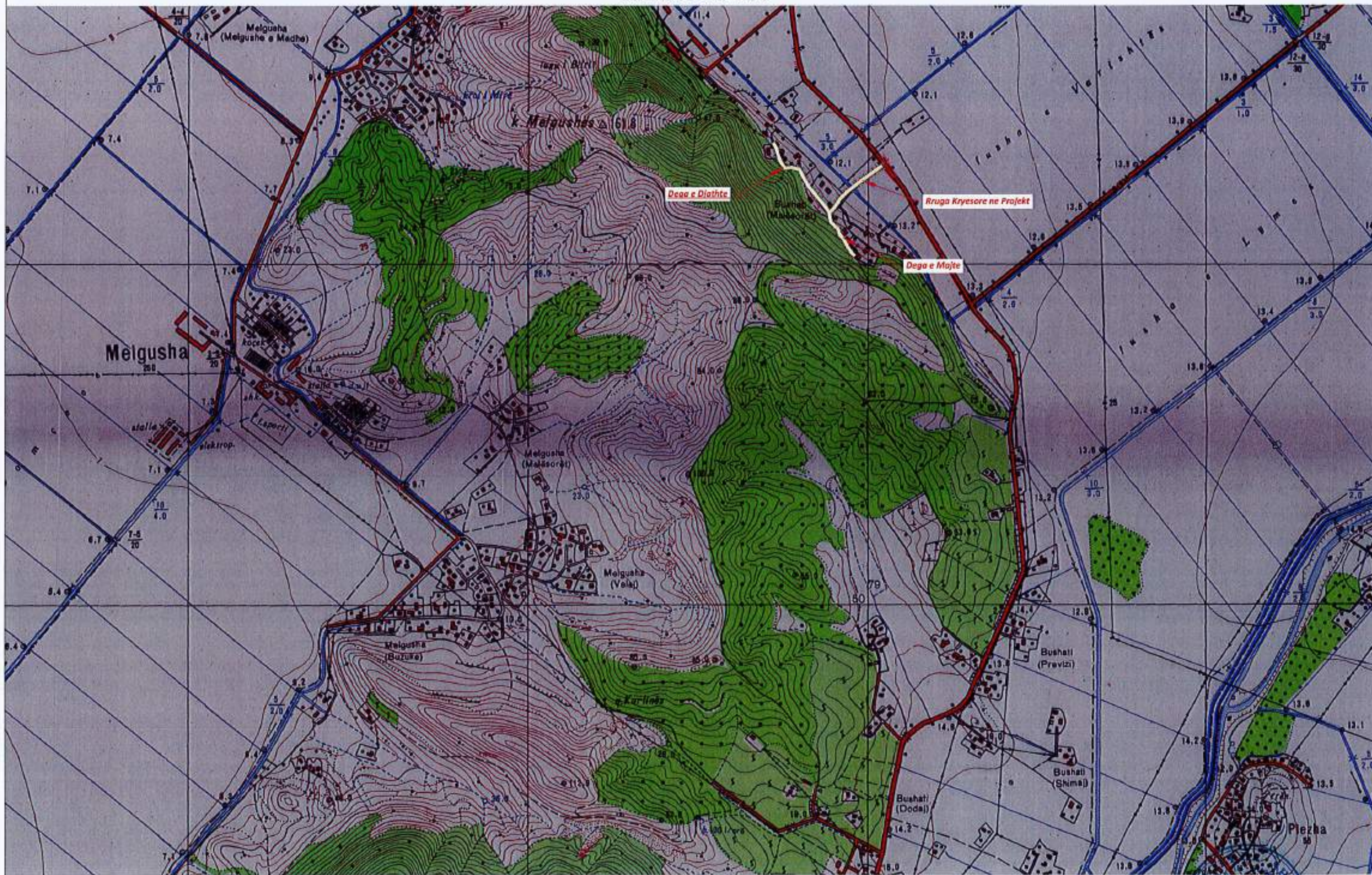

POROSITESI

BASHKIA VAU DEJES



"ANGERBA" shpk

Adresa: Rr. "Irfan Tomini" Tirane,
 Cel: 069 20 95 862
 E-mail: burhanhafizi@gmail.com

VENDODHJA
 Bashkia Vau Dejes

TITULLI I PROJEKTTIT
 SISTEMIM ASFALTIM I RRUGES SE MALESOREVE
 NJESIA ADMINISTRATIVE BUSHAT

FAZA E PROJEKTIMIT
 PROJEKT ZBATIMI

TITULLI I VIZATIMIT
 HARTA E ZONES

Grupi i Projektimit
 Ing. Burhan HAFIZI
 Ing. Servet VERÇANI
 Ing. Gerti HAFIZI

Skala: 1:10 000
 Data: Mars 2023
 FETA Nr.1



PLANIMETRIA E PERGJITHSHME



Legjende

- Asfalt Ekzistues
- Rruge Ekzistuese
- Gardhe Ekzistues
- Mure Rrethues Ekzistues
- Rruge ne Projekt
- Mure ne Projekt
- Kanal Anesor ne Projekt
- Lug Betoni ne Projekt

POROSITESI

BASHKIA VAU DEJES



"ANGERBA" shpk

Adresa: Rr. "Yfan Tomini" Tirane.
 Cel: 069 20 95 862
 E-mail: burhanhafizi@gmail.com

YENDODIDA
 Bashkia Van Dejes

TITULLI I PROJEKTI
 SISTEMI ASFALTIM I RRUGES SE MALESOREVE
 NJESIA ADMINISTRATIVE BUSHAT

FAZA E PROJEKTIMIT:
 PROJEKT ZBATIMI

TITULLI I VIZATIMIT:
 PLANIMETRIA E PERGJITHSHME
 ME ORTOFOTO

Grupi i Projektimit: 1:1500

Ing. Burhan HAFIZI
 Ing. Servet VERÇAN
 Ing. Gerti HAFIZI



05/03/2023
 Fleta Nr.2

RILEVIMI TOPOGRAFIK

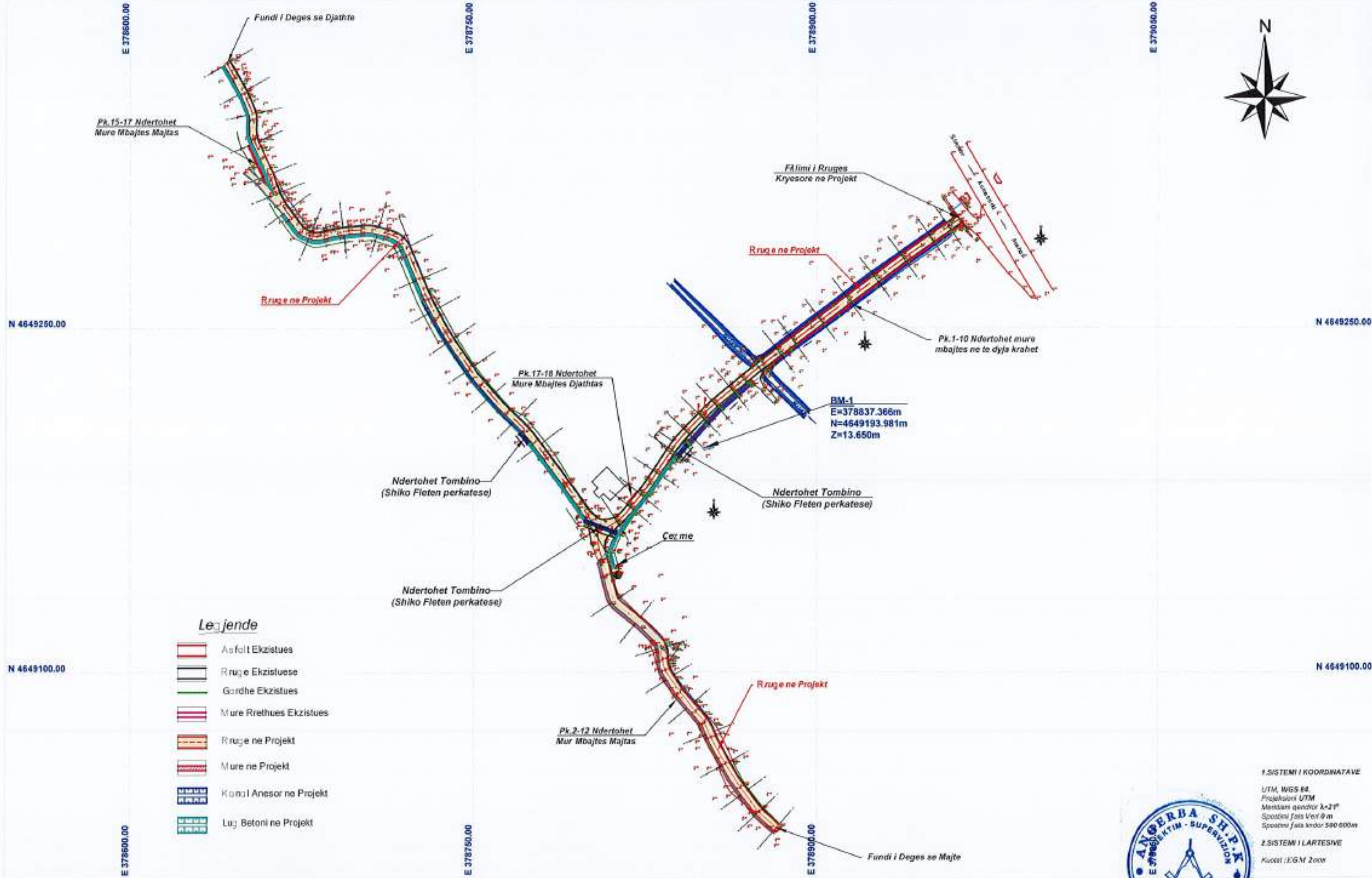

Lejende

- Asfalt Ekzistues
- Rruge Ekzistuese
- Gardhe Ekzistues
- Mure Rrethues Ekzistues
- Rruge ne Projekt
- Mure ne Projekt
- Kanal Anesor ne Projekt
- Luçj Betoni ne Projekt

1.SISTEMI I KOORDINATAVE
 UTM, WGS 84,
 Projektimi UTM
 Merkatimi qendror k=2°
 Spesimi falsi Vert 0 m
 Spesimi falsi horizontal 500 000m

2.SISTEMI I LARTESIVE
 Kucelat : EGM 2008



<p>POROSITESI</p>	<p>"ANGERBA" shpk</p> <p>Adresa: Rr. "Irfan Tomini" Tirane. Cel: 069 20 95 862 E-mail: burhanhafizi@gmail.com</p>	<p>VENDODHJA Bashkia Vau Dejes</p> <p>TITULLI I PROJEKTIT SISTEMIM ASFALTIM I RRUGES SE MALESOREVE NJESIA ADMINISTRATIVE BUSHAT</p>	<p>FAZA E PROJEKTIMIT: PROJEKT ZBATIMI</p> <p>TITULLI I VIZATIMIT: RILEVIMI TOPOGRAFIK</p>	<p>Grupi Projektimit Ing. Burhan HAFIZI Ing. Servet VERÇANI Ing. Genti HAFIZI</p>	<p>Shkalla 1:1500 Data: Mars 2023 FLETA Nr.3</p>
<p>BASHKIA VAU DEJES</p>					



Legjende

	Asfalt Ekzistues
	Rruge Ekzistuese
	Gardhe Ekzistuese
	Mure Rrethues Ekzistues
	Rruge ne Projekt
	Mure ne Projekt
	Kanal Anesor ne Projekt
	Lug Betoni ne Projekt

POROSITESI
BASHKIA VAU DEJES



"ANGERBA" shpk
Adresa: Rr. "Irfan Tomini" Tirane.
Cel: 069 20 95 862
E-mail: burhanhafizi@gmail.com

VENDODHJA
Bashkia Vau Dejes

TITULLI I PROJEKTIT
SISTEMIM ASFALTIM I RRUGES SE MALESOREVE
NJESIA ADMINISTRATIVE BUSHAT

FAZA E PROJEKTIMIT:
PROJEKT ZBATIMI

TITULLI I VIZATIMIT:
PLANIMETRIA E RRUGES KRYESORE
PK.1-6

Grupi i Projektimit
Ing. Burhan HAFIZI
Ing. Servet VERÇANI
Ing. Genti HAFIZI

Skala 1:250
Mars 2023
FLETJA Nr.4



PLANIMETRIA E RRUGES KRYESORE



Legjende

- Asfalt Ekzistues
- Rruge Ekzistuese
- Gardhe Ekzistues
- Mure Rrethues Ekzistues
- Rruge ne Projekt
- Mure ne Projekt
- Kanal Anesor ne Projekt
- Eqs. Betoni ne Projekt

POROSITESI

BASHKIA VAU DEJES



"ANGERBA" shpk

Adresa: Rr. "Irfan Tomini" Tirane.
Cel: 069 20 95 862
E-mail: burhanhafizi@gmail.com

VENDOBËRJA
Bashkia Van Dejes

TITULLI I PROJEKTIT
SISTEMIM ASFALTIM I RRUGES SE MALESOREVE
NJESIA ADMINISTRATIVE BUSHAT

FAZA E PROJEKTIMIT:
PROJEKT ZBATIMI

TITULLI I VIZATIMIT:
PLANIMETRIA E RRUGES KRYESORE
PK.6-14

Grupi i Projektimit: **ANGERBA SH.P.K.** Skala 1:250

Ing. Burhan HAFIZI
Ing. Servet VERÇANI
Ing. Gerti HAFIZI
Data: Mars 2023
FETA Nr.5



PLANIMETRIA E RRUGES KRYESORE



- Legjende**
- Asfalt Ekzistues
 - Rruge Ekzistuese
 - Gardhe Ekzistues
 - Mure Rrethues Ekzistues
 - Rruge ne Projekt
 - Mure ne Projekt
 - Kanal Anesor ne Projekt
 - Lug Betoni ne Projekt

POROSITESI
BASHKIA VAU DEJES



"ANGERBA" shpk
Adresa: Rr. "Irfan Tamini" Tirane.
Cel: 069 20 95 862
E-mail: burhanhafizi@gmail.com

VENDODHJA
Bashkia Van Dejes

TITULLI I PROJEKTTIT
**SISTEMIM ASFALTIM I RRUGES SE MALESOREVE
NJESIA ADMINISTRATIVE BUSHAT**

FAZA E PROJEKTIMIT:
PROJEKT ZBATIMI

TITULLI I VIZATIMIT:
**PLANIMETRIA E RRUGES KRYESORE
PK.14-20**

Grupi i Projektimit:
Ing. Burhan HAFIZI
Ing. Servet VERÇANI
Ing. Gerti HAFIZI

Skala 1:250
Data: Mars 2023
ETA Nr.6



PROFILI GJATESOR I DEGES KRYESORE
SH 1:100 ; 1:1000

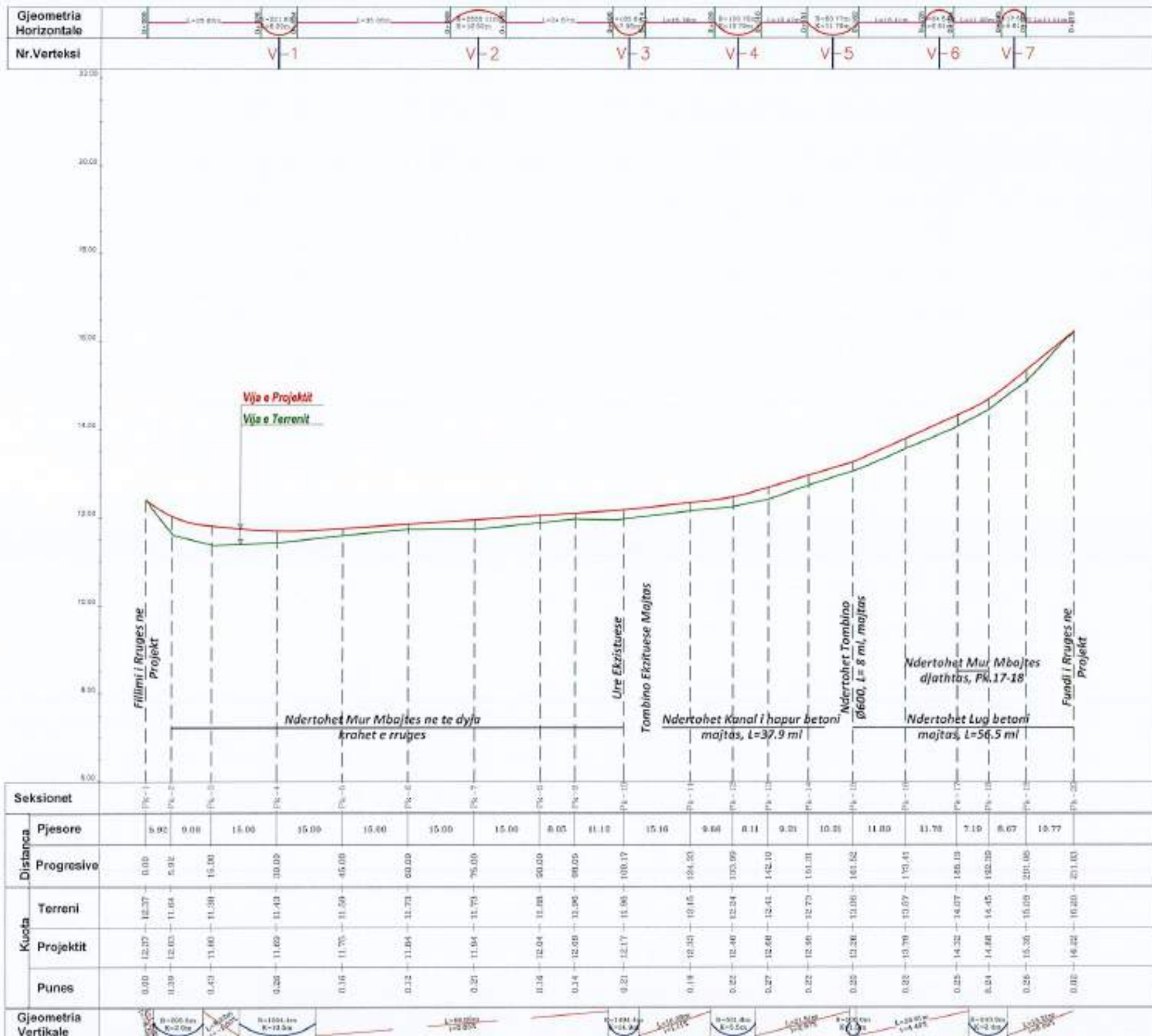

Seksionet		PK-1	PK-2	PK-3	PK-4	PK-5	PK-6	PK-7	PK-8	PK-9	PK-10	PK-11	PK-12	PK-13	PK-14	PK-15	PK-16	PK-17	PK-18	PK-19	PK-20	
Distanca	Pjesore	5.00	0.00	15.00	15.00	15.00	15.00	15.00	8.00	11.10	15.10	9.80	8.11	9.20	10.20	11.00	11.70	7.10	8.07	10.77		
	Progresive	0.00	5.92	15.00	30.00	45.00	60.00	75.00	83.00	94.10	109.20	119.00	128.80	136.91	146.11	155.31	166.31	173.41	180.51	187.61	198.38	209.15
Kucata	Terreni	12.27	11.64	11.38	11.43	11.50	11.73	11.95	12.08	12.30	12.58	12.84	13.04	13.24	13.41	13.56	13.68	13.77	13.84	13.89	13.92	13.94
	Projektit	12.27	12.03	11.80	11.69	11.75	11.84	11.94	12.04	12.08	12.17	12.24	12.30	12.34	12.41	12.46	12.50	12.53	12.55	12.56	12.57	12.58
	Punes	0.00	0.20	0.43	0.26	0.16	0.12	0.21	0.18	0.14	0.21	0.18	0.22	0.22	0.27	0.22	0.25	0.22	0.25	0.24	0.24	0.24
Gjeometria Vertikale		R=200.0m K=2.0%		R=100.0m K=13.5%		L=80.00m K=12.5%		L=100.00m K=14.8%		L=100.00m K=15.5%		L=100.00m K=15.5%		L=100.00m K=15.5%		L=100.00m K=15.5%		L=100.00m K=15.5%		L=100.00m K=15.5%		

POROSITESI
BASHKIA VAU DEJES



"ANGERBA" shpk
Adresa: Rr. "Irfan Tomini" Tiranë.
Cel: 069 20 95 862
E-mail: burhanhafizi@gmail.com

VENDODHJA
Bashkia Vau Dejës

TITULLI I PROJEKTIT
**SISTEMIM ASFALTIM I RRUGES SE MALESOREVE
NJESIA ADMINISTRATIVE BUSHAT**

FAZA E PROJEKTIMIT:
PROJEKT ZBATIMI

TITULLI I VIZATIMIT:
**PROFILI GJATESOR I DEGES
KRYESORE**

Grupi i Projektimit:
Ing. Burhan HAFIZI
Ing. Servet VERÇANI
Ing. Gerti HAFIZI

Skala: 1:100; 1:1000
Data: Mars 2023
FLETJA Nr.7



PROFLET TERTHORE TE DEGES KRYESORE

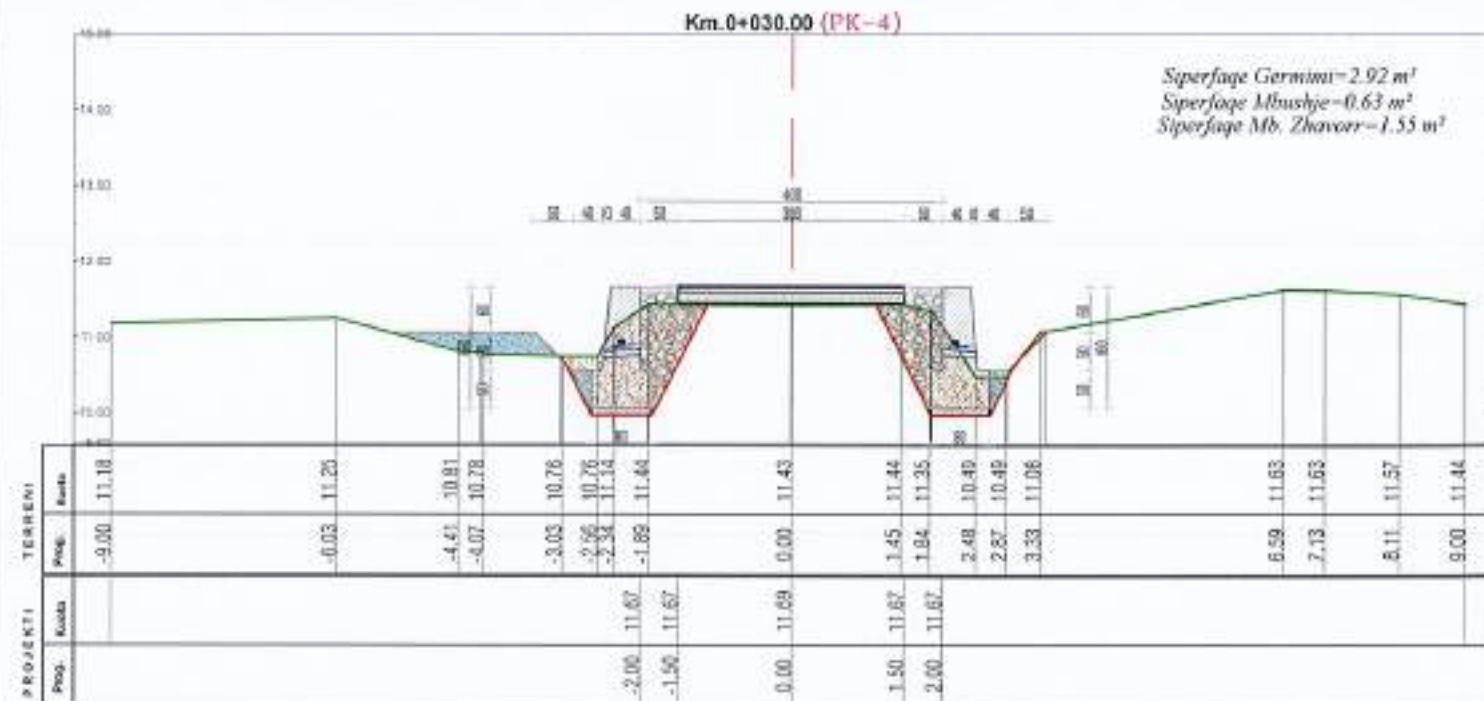
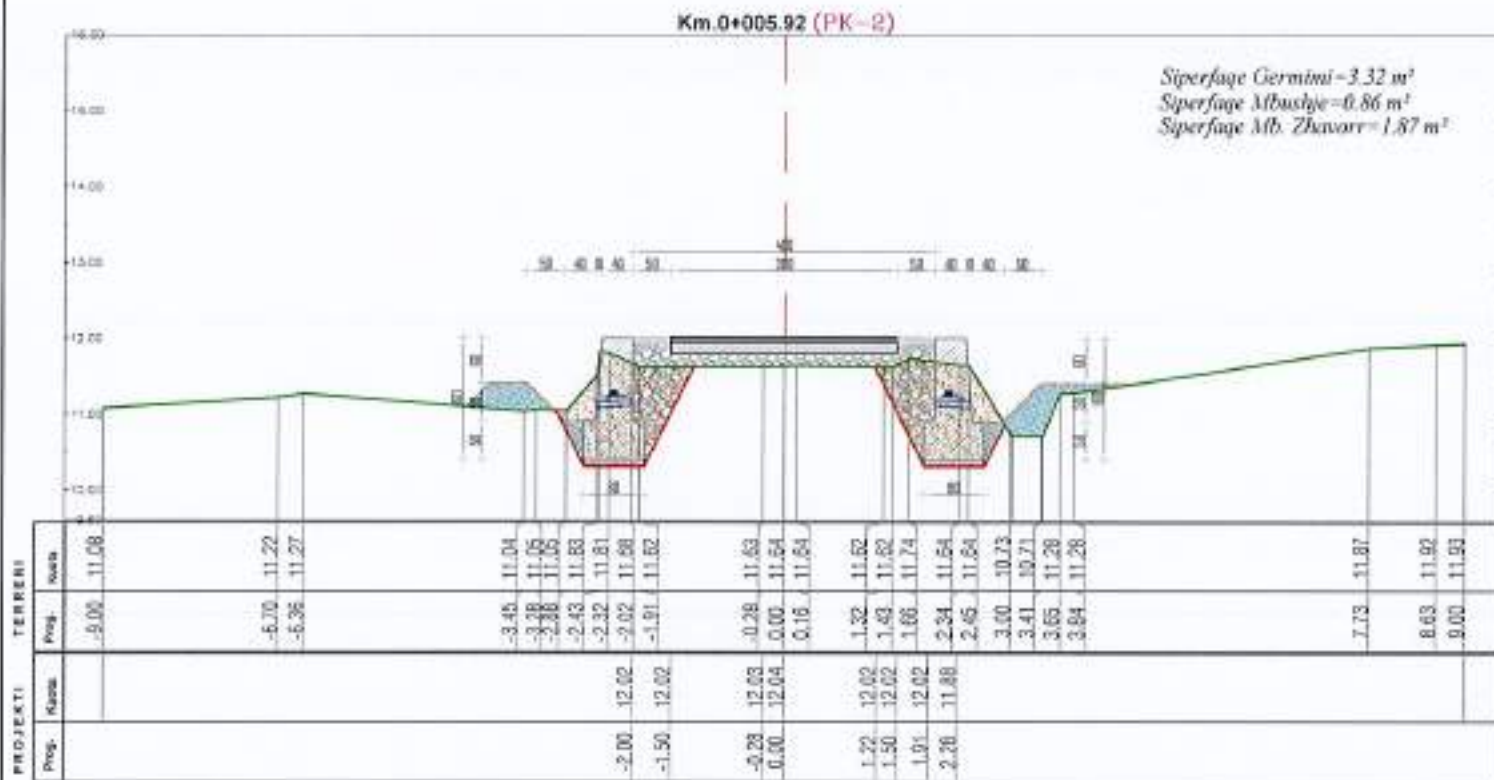
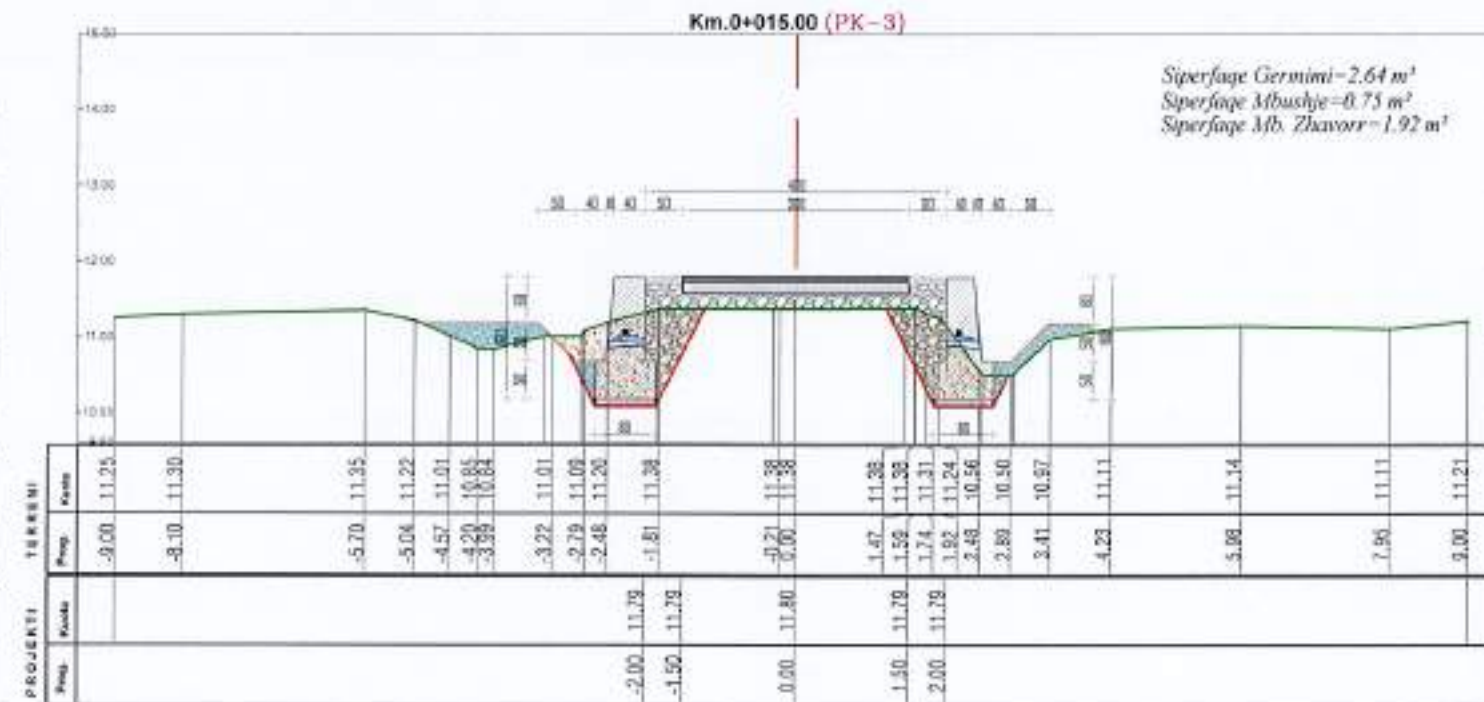
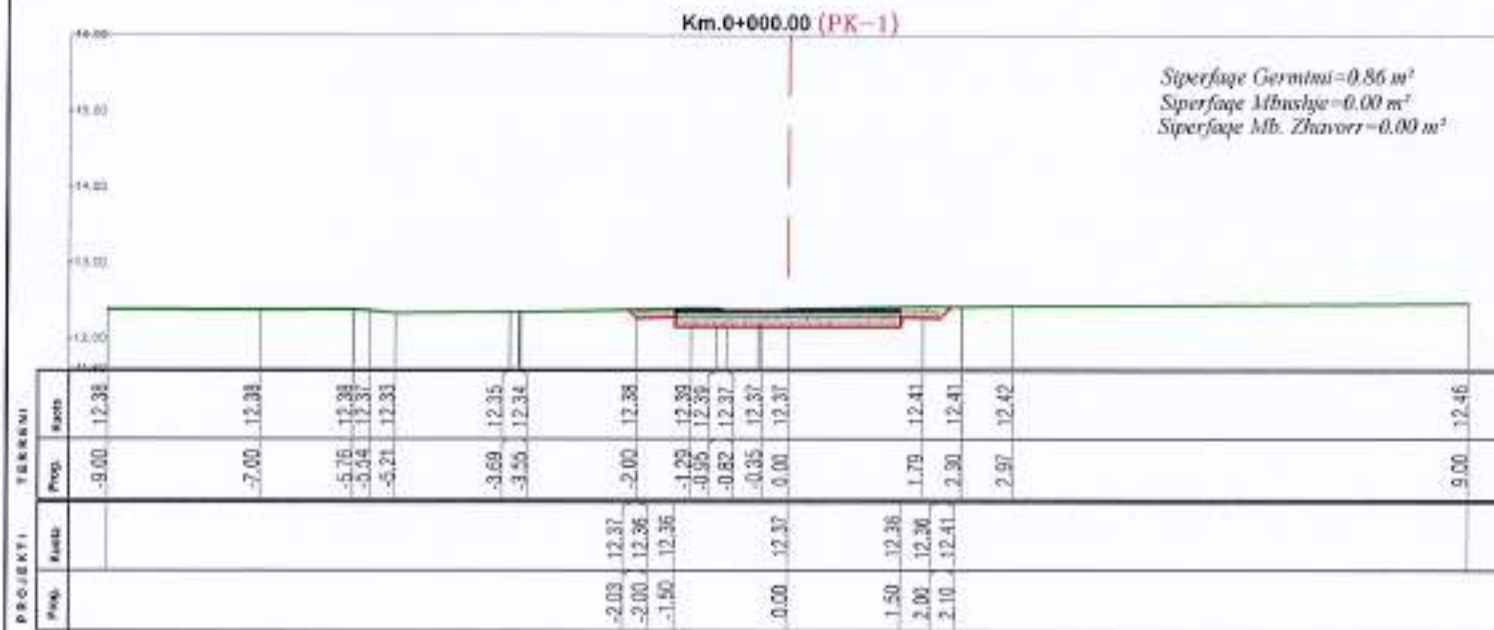

POROSITESI

BASHKIA VAU DEJES



"ANGERBA" shpk

Adresa: Rr. "Irfan Tomini" Tirane.
Cel: 069 20 95 862
E-mail: burhanhafizi@gmail.com

VENDODHJA
Bashkia Vau Dejes

TITULLI I PROJEKTI
SISTEMIM ASFALTIM I RRUGES SE MALESOREVE
NJESIA ADMINISTRATIVE BUSHAT

FAZA E PROJEKTIMIT:
PROJEKT ZBATIMI

TITULLI I VIZATIMIT:
PROFLET TERTHORE
DEGA KRYESORE

Grupi i Projektimit
Ing. Burhan HAFIZI
Ing. Servet VERÇANI
Ing. Gerti HAFIZI

Skala: 1:100
Data: Mars 2023
FETA Nr.8



PROFLET TERTHORE TE DEGES KRYESORE

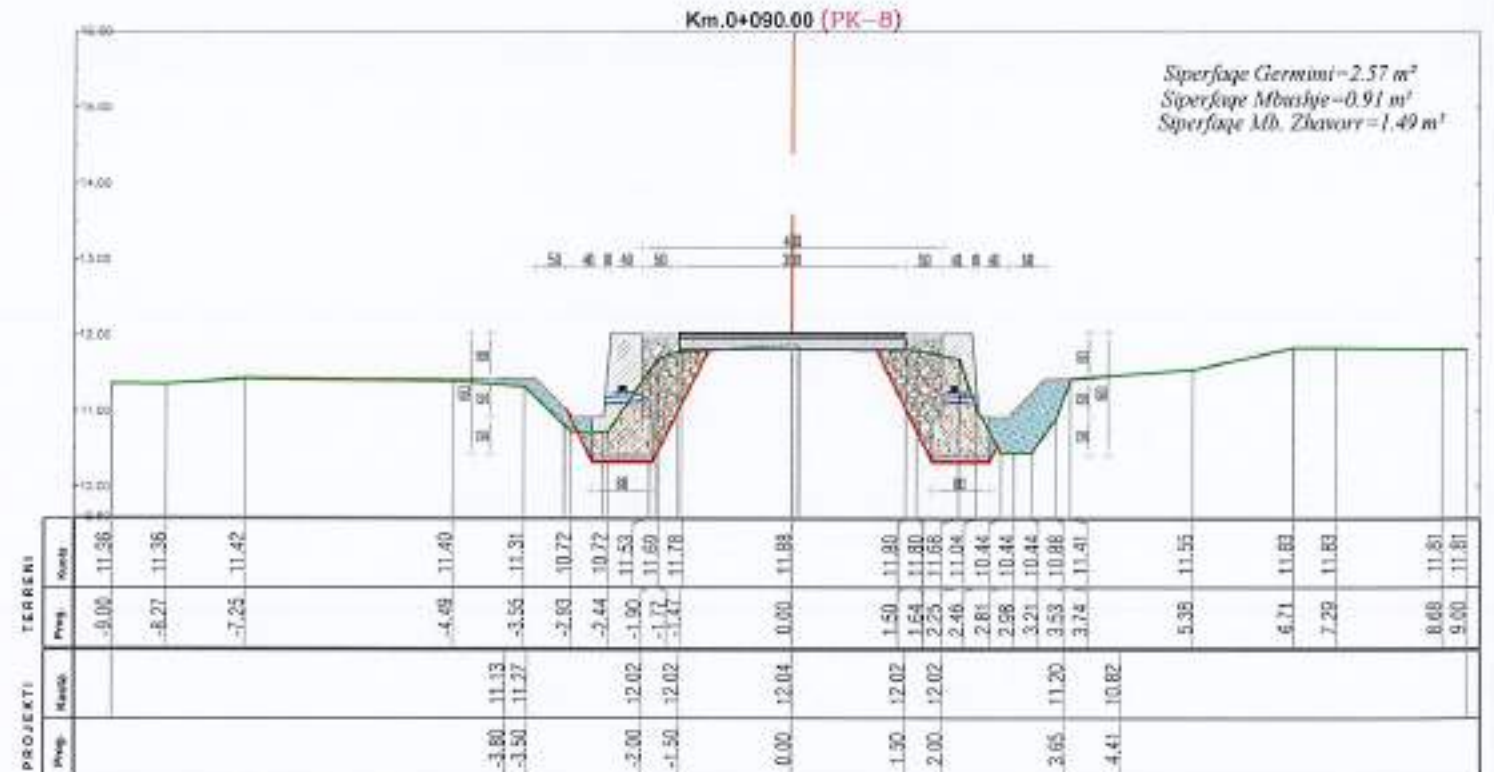
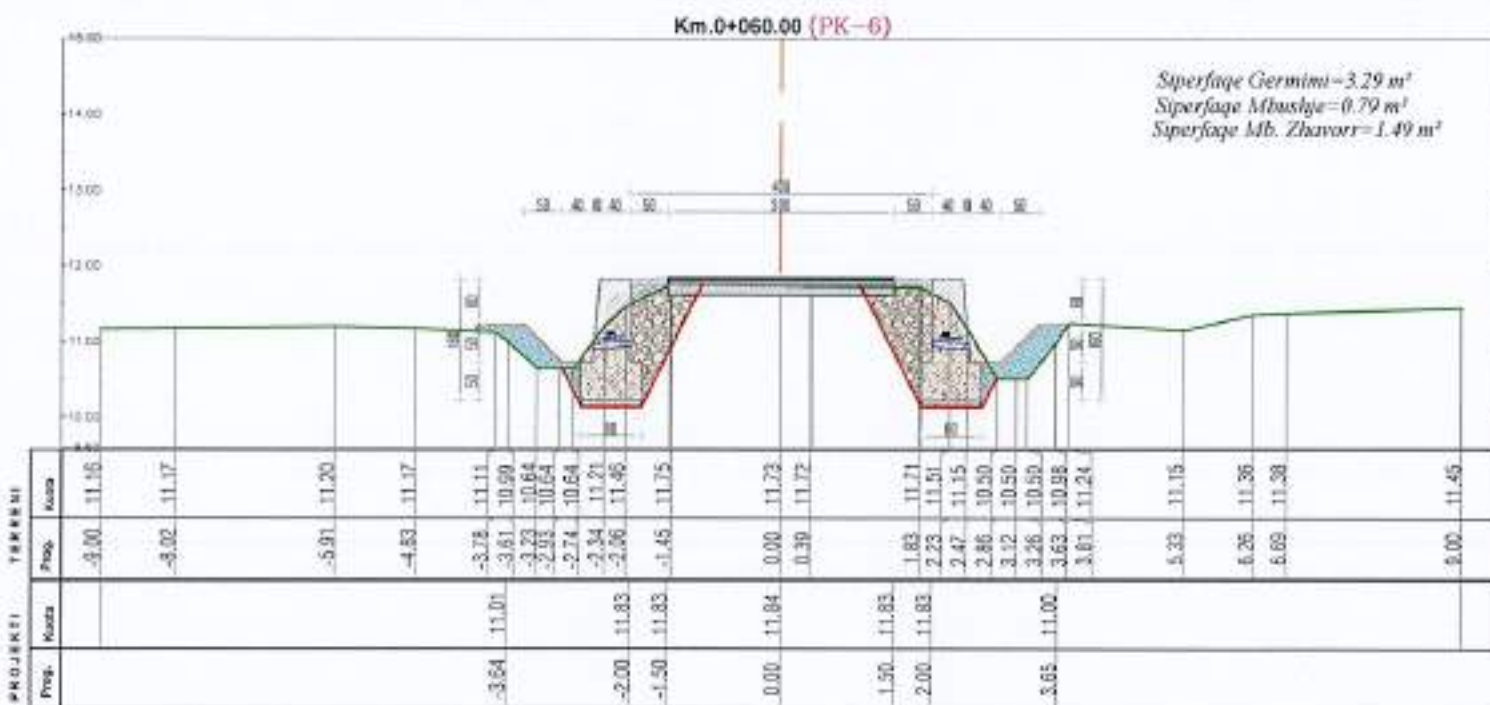
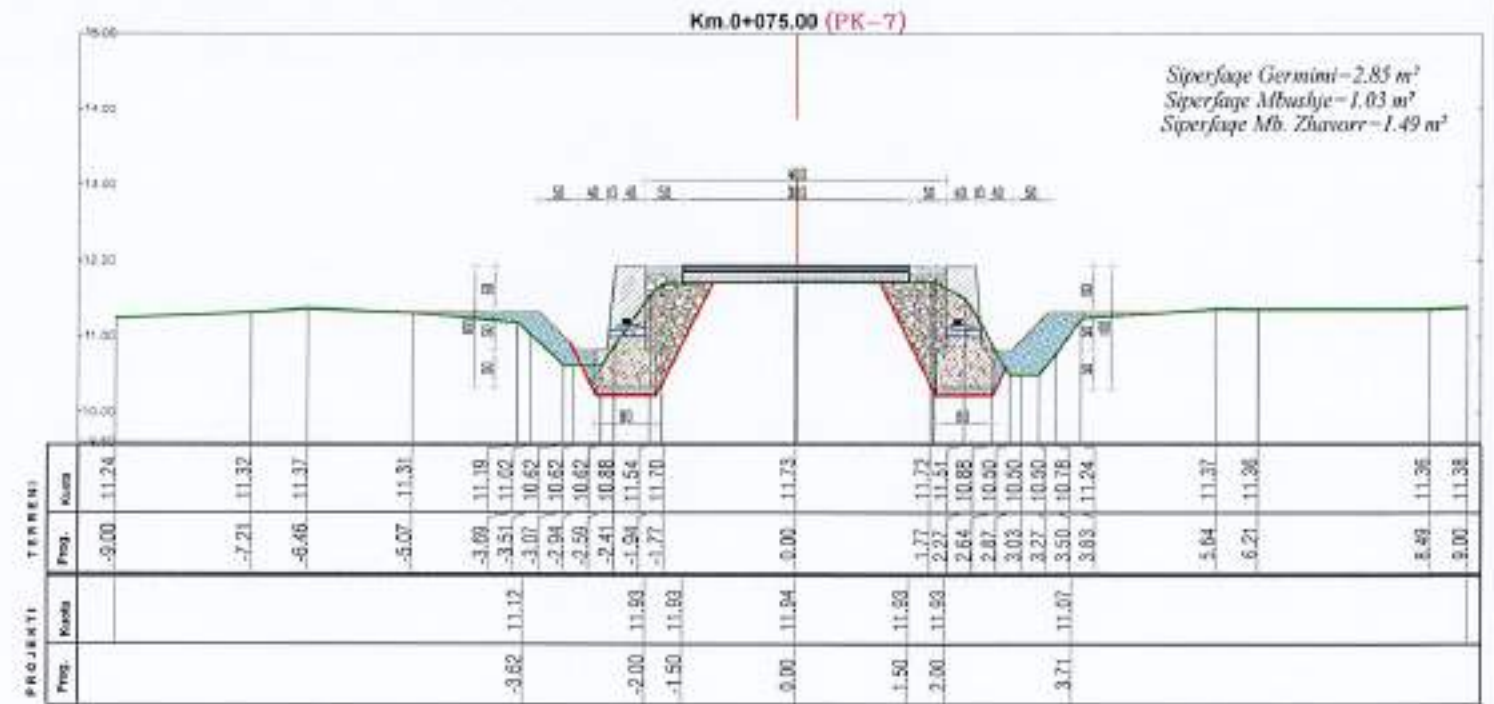
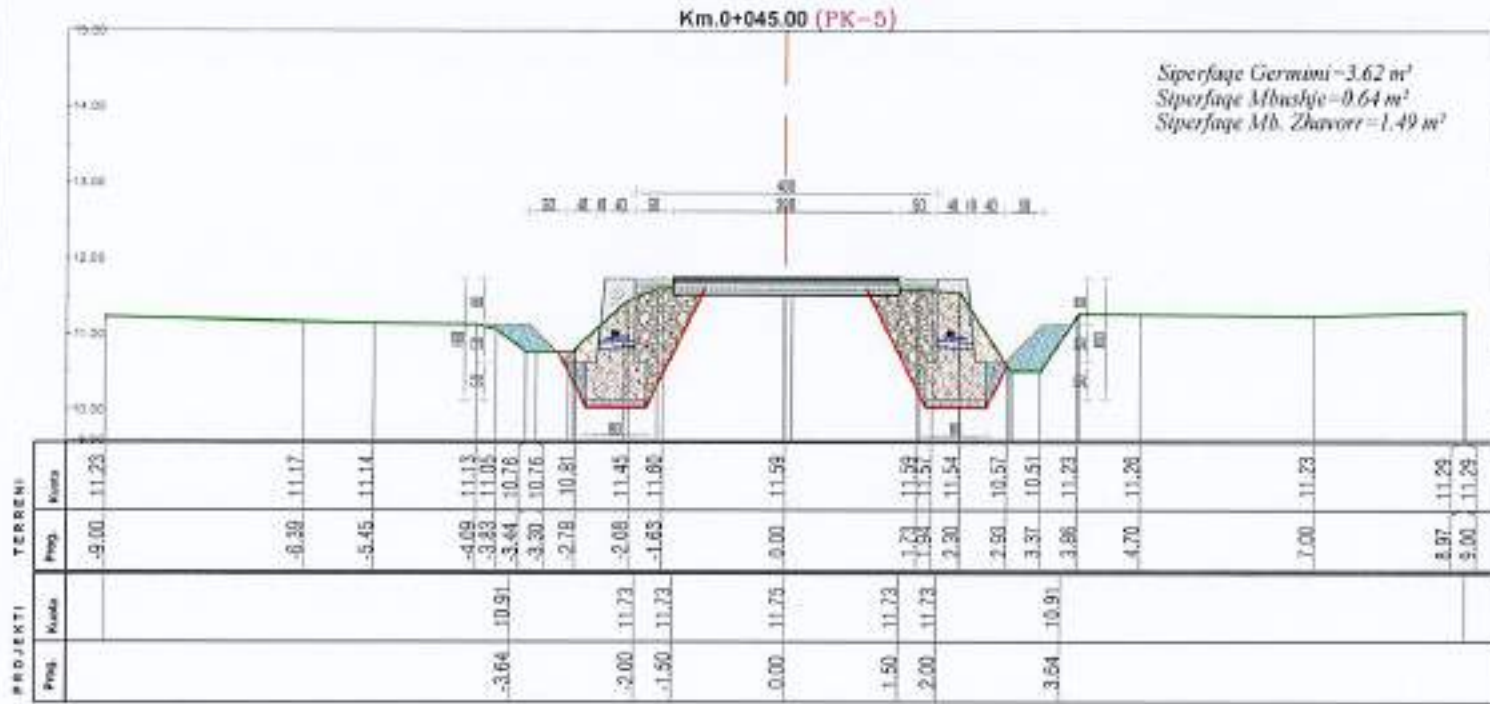

POROSITESI

BASHKIA VAU DEJES



"ANGERBA" shpk

Adresa: Rr. "Irfan Tomini" Tirane.
Cel: 069 20 95 862
E-mail: burhanhafizi@gmail.com

VENDODHJA
Bashkia Vau Dejes

ITULLI I PROJEKTI

SISTEMIM ASFALTIM I RRUGES SE MALESOREVE
NJESIA ADMINISTRATIVE BUSHAT

FAZA E PROJEKTIMIT:
PROJEKT ZBATIMI

ITULLI I VIZATIMIT:

PROFLET TERTHORE
DEGA KRYESORE

Grupi i Projektimit:
Ing. Burhan HAFIZI
Ing. Servet VERÇANI
Ing. Gerti HAFIZI

Skala: 1:100
Data: Mars 2023
FLETA Nr.9



PROFLET TERTHORE TE DEGES KRYESORE

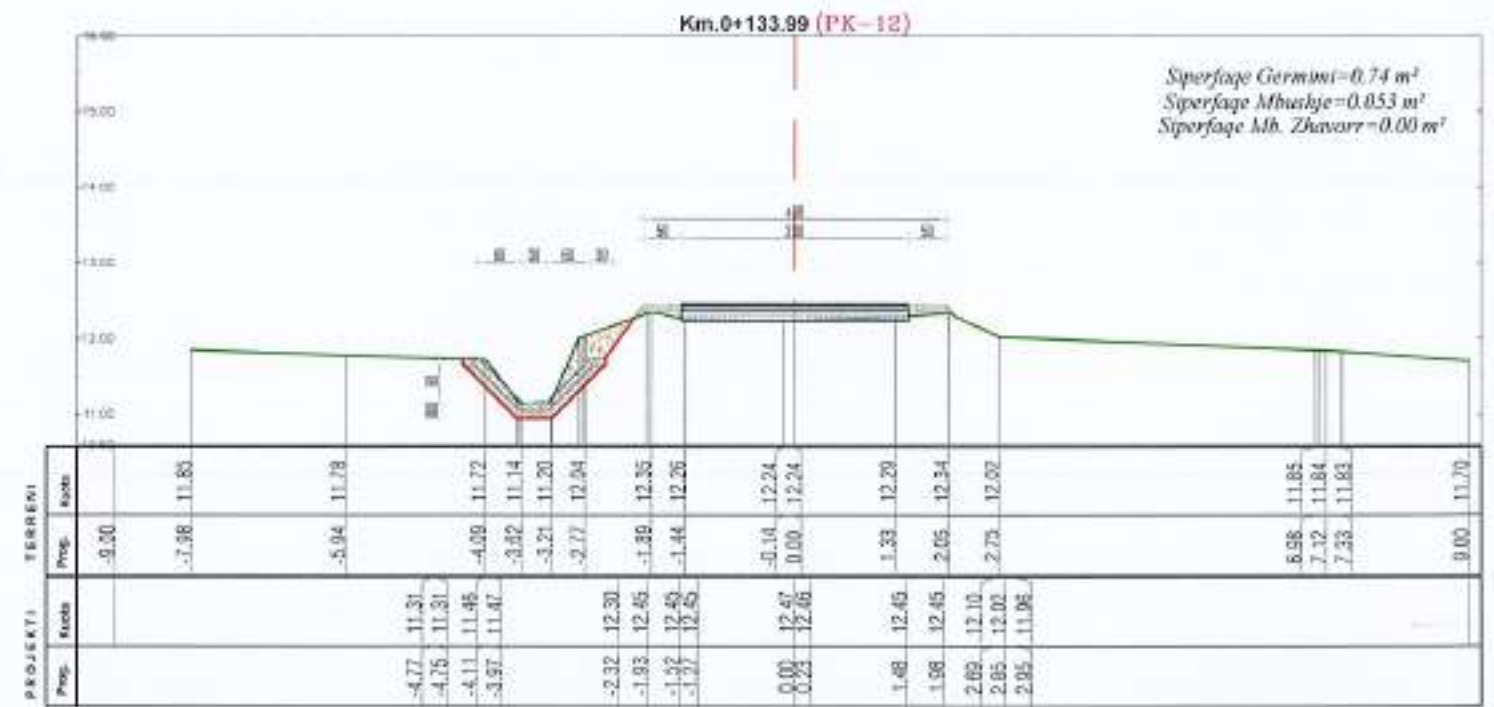
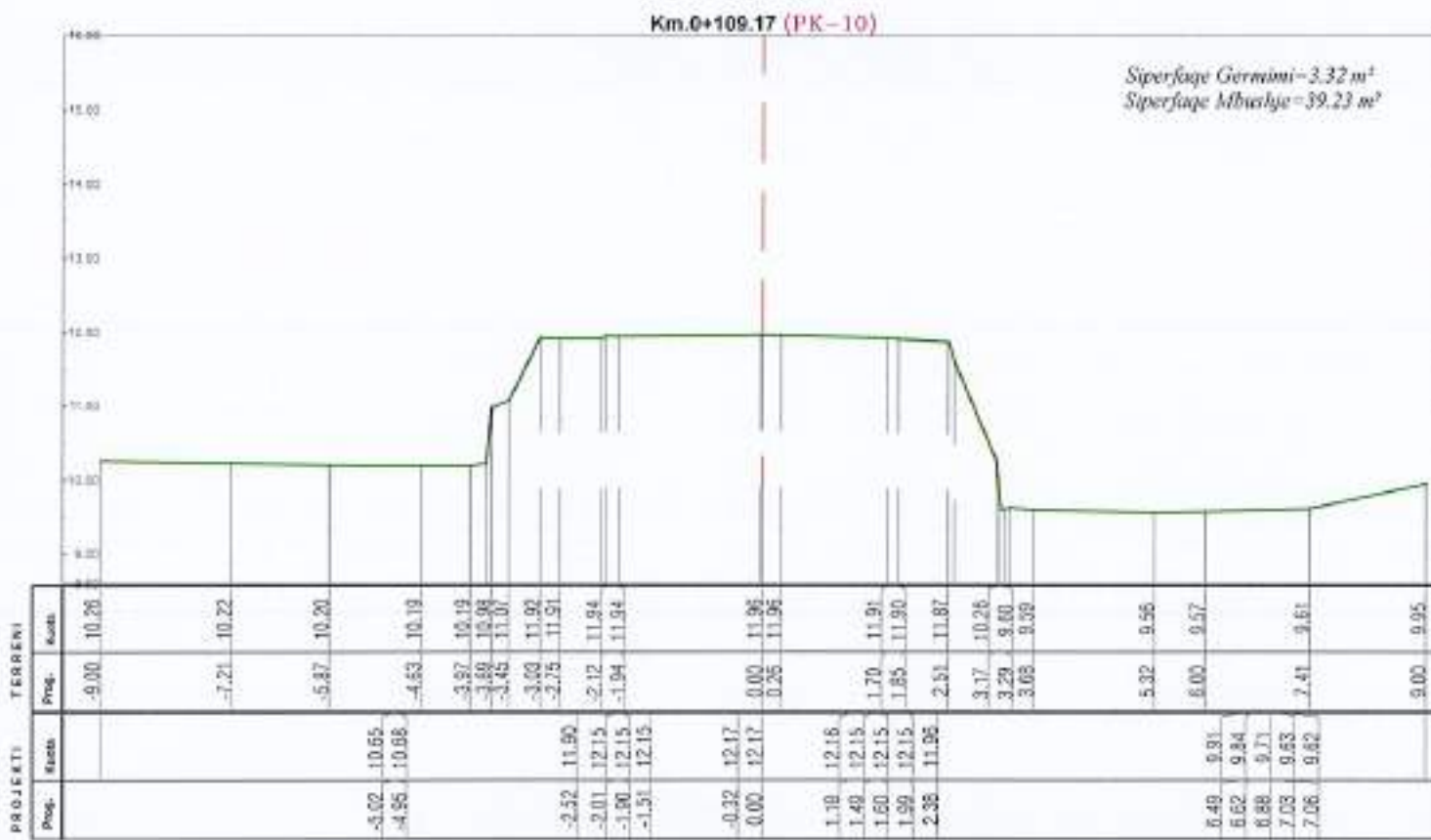
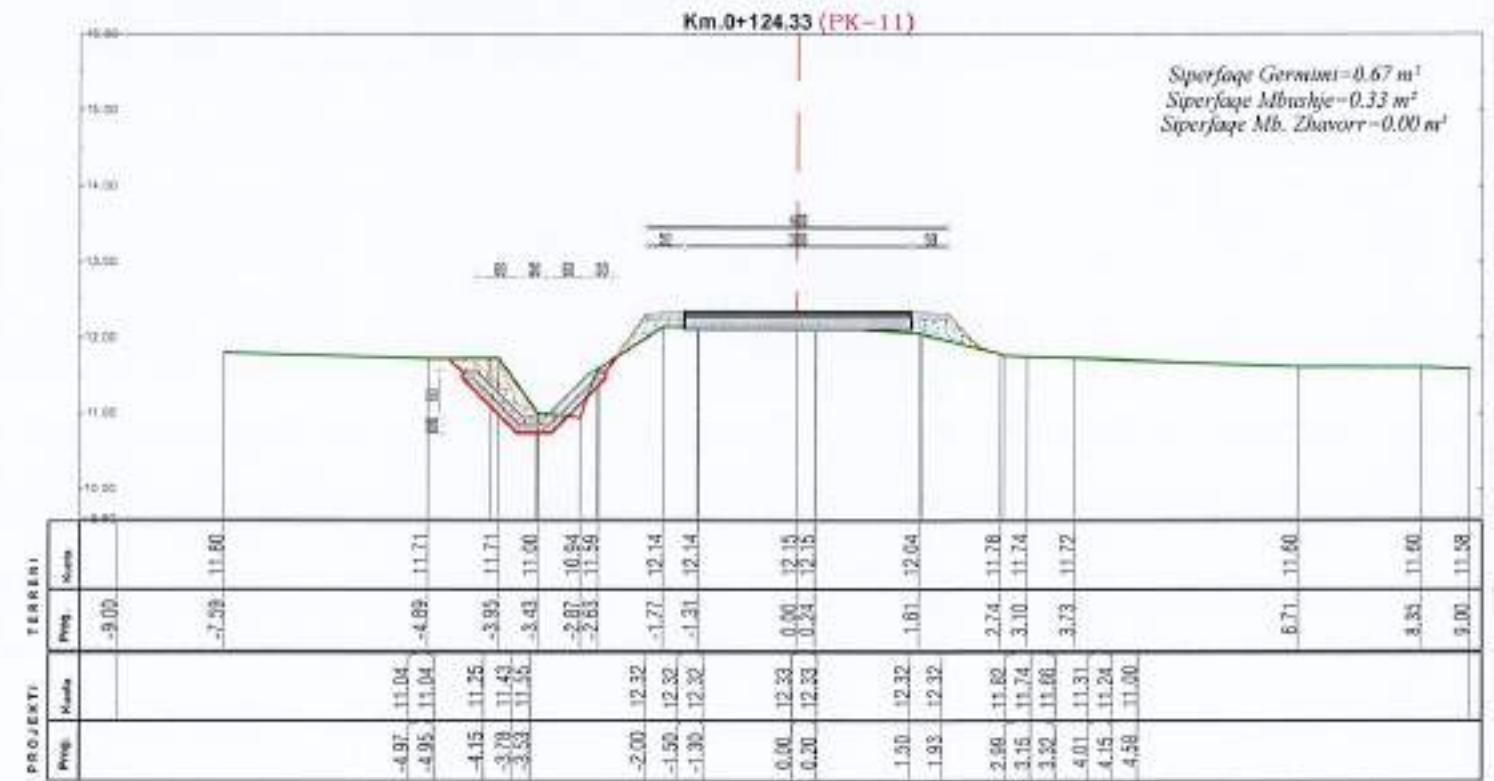
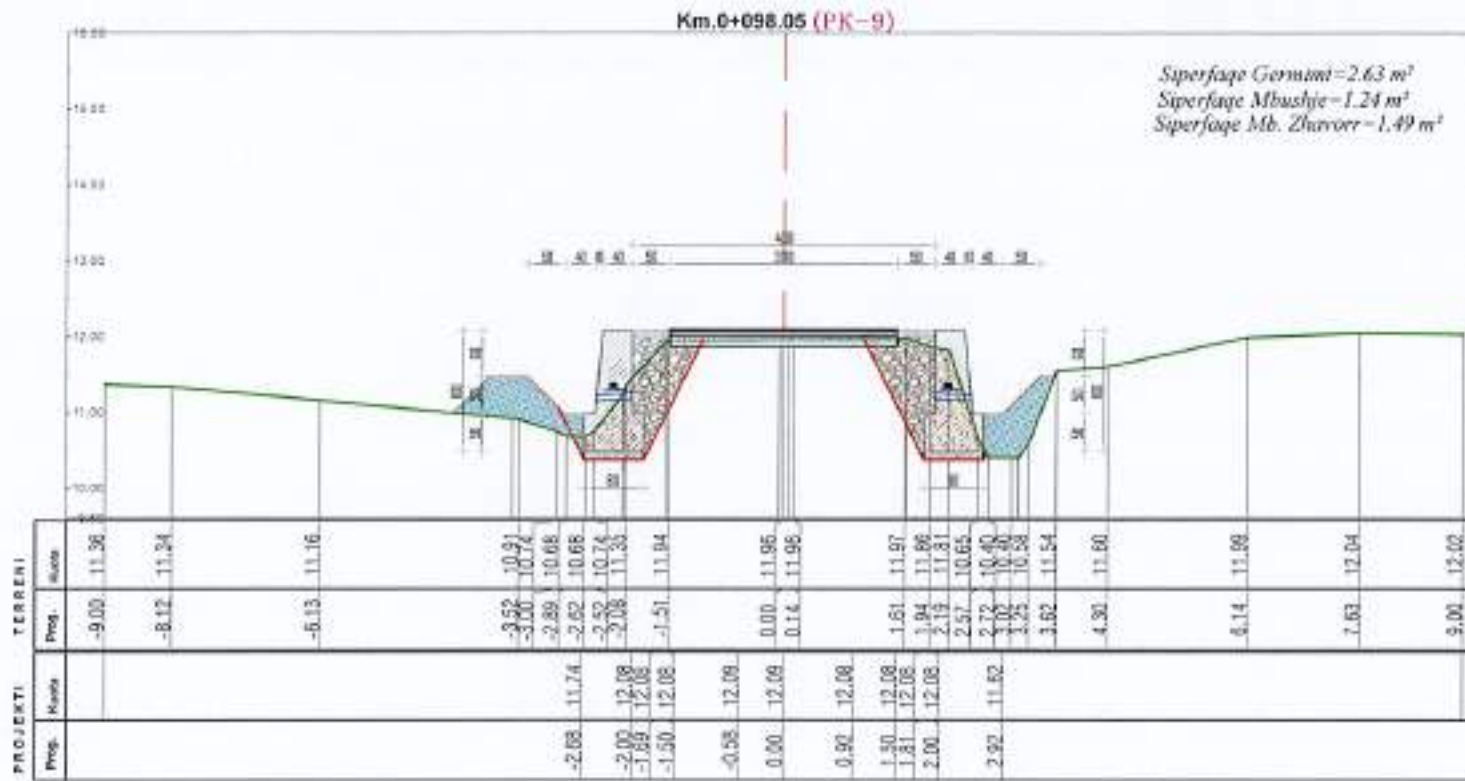

POROSITESI

BASHKIA VAU DEJES



"ANGERBA" shpk

Adresa: Rr. "Irfan Tomini" Tirane.
 Cel: 069 20 95 862
 E-mail: burhanhafizi@gmail.com

VENDODHJA
 Bashkia Vau Dejes

TITULLI I PROJEKTI

SISTEMIM ASFALTIM I RRUGES SE MALESOREVE
 NJESIA ADMINISTRATIVE BUSHAT

FAZA E PROJEKTIMIT:
 PROJEKT ZBATIMI

TITULLI I VIZATIMIT:

PROFLET TERTHORE
 DEGA KRYESORE

Grupi i Projektimit: 1:100

Ing. Burhan HAFIZI
 Ing. Servet VERÇANI
 Ing. Gerti HAFIZI



FL. A Nr.10

PROFLET TERTHORE TE DEGES KRYESORE

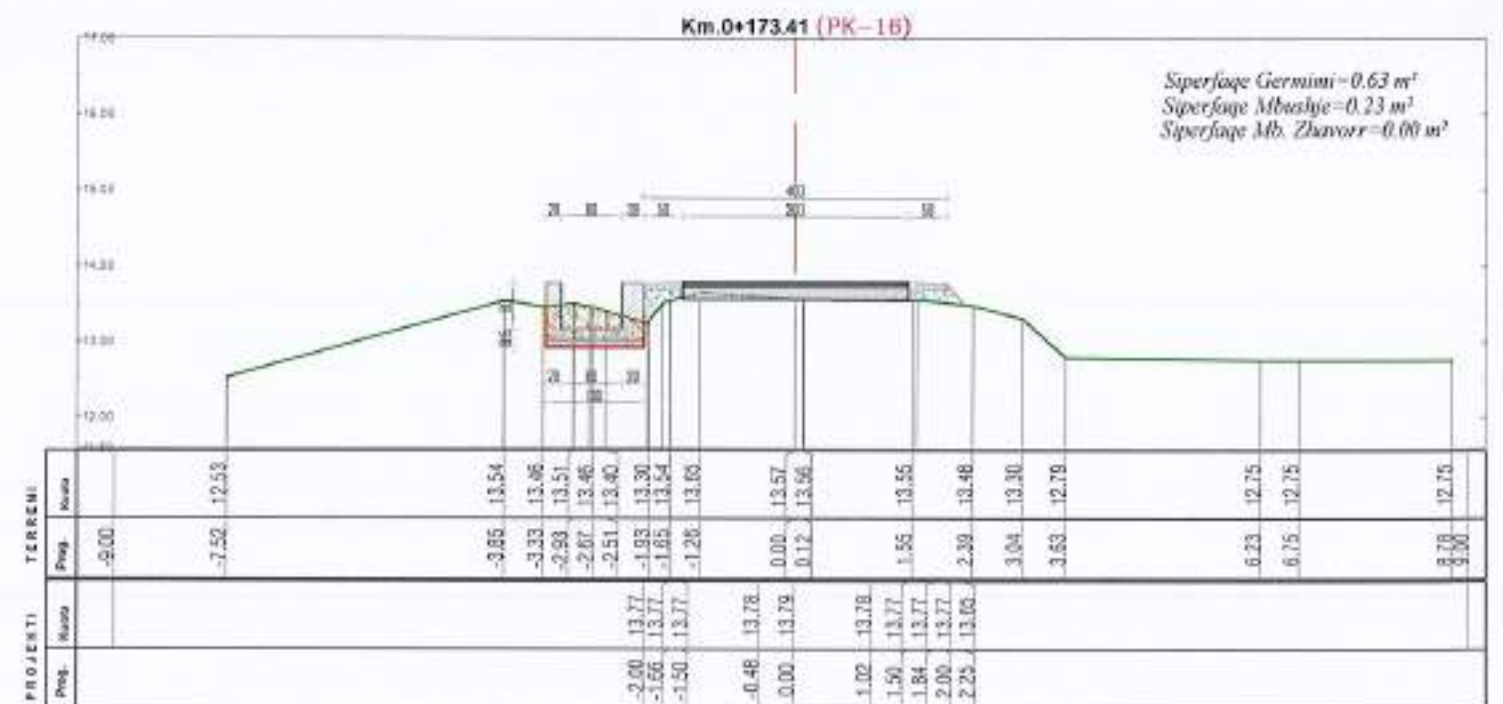
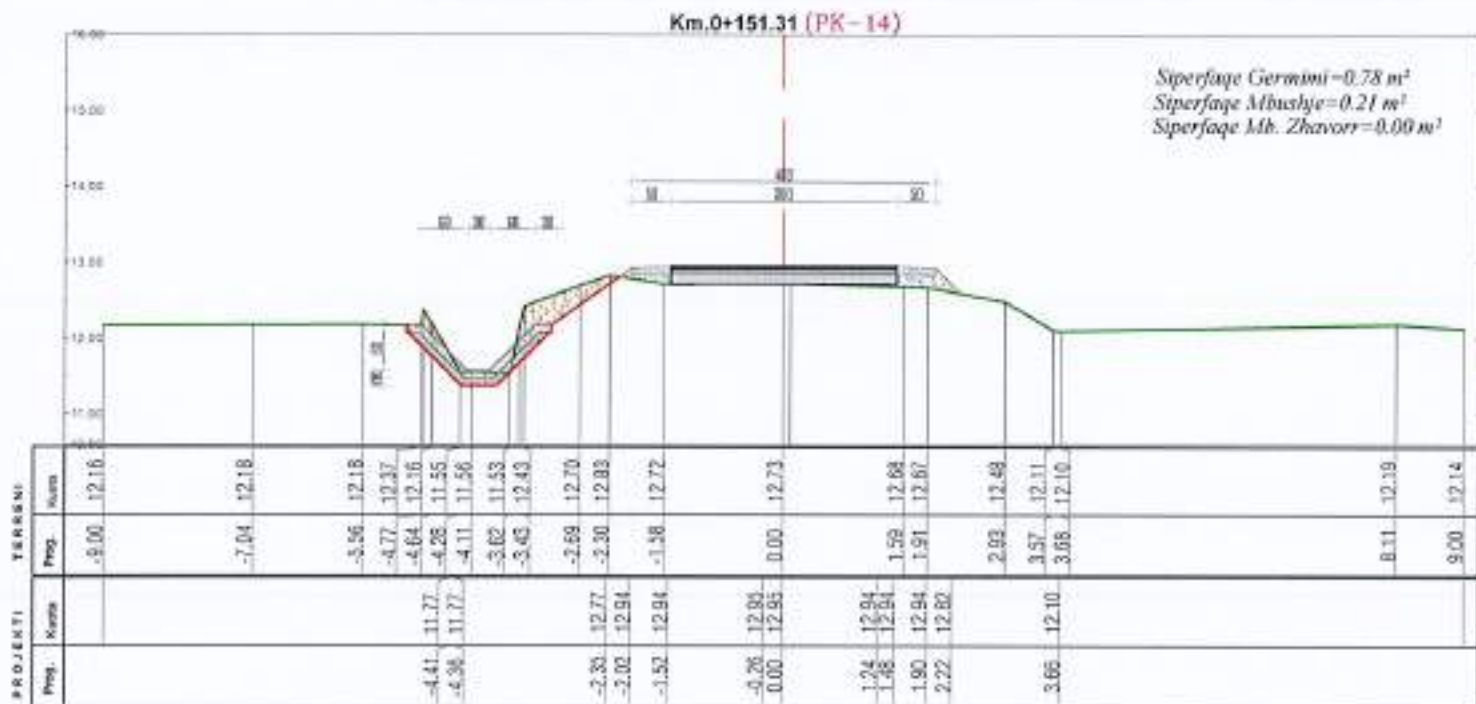
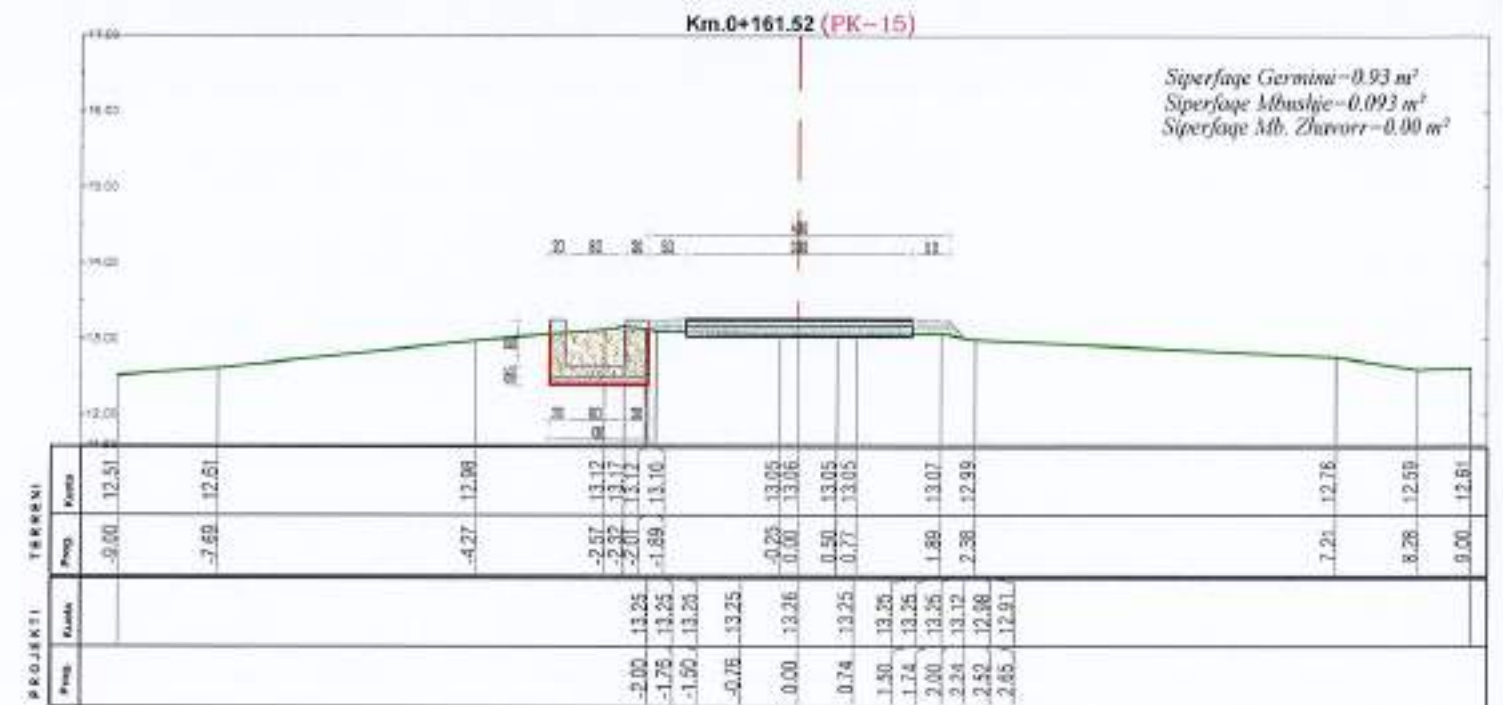
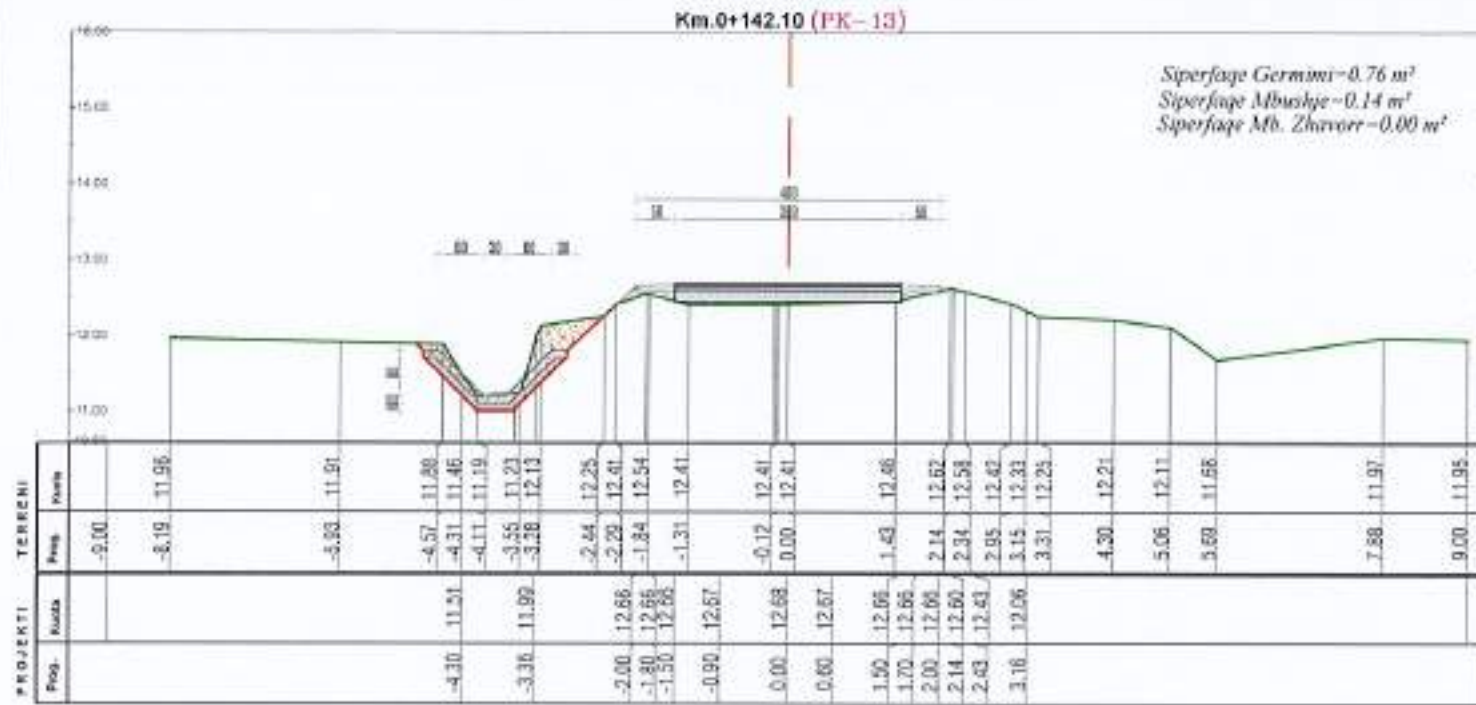

POROSITESI

BASHKIA VAU DEJES



"ANGERBA" shpk

Adresa: Rr. "Irfan Tomini" Tirane.
Cel: 069 20 95 852
E-mail: burhanhafizi@gmail.com

VENDODHIA
Bashkia Vau Dejes

TITULLI I PROJEKTI

SISTEMIM ASFALTIM I RRUGES SE MALESOREVE
NJESIA ADMINISTRATIVE BUSHAT

FAZA E PROJEKTIMIT:
PROJEKT ZBATIMI

TITULLI I VIZATIMIT:

PROFLET TERTHORE
DEGA KRYESORE

Grupi i Projektimit:
Ing. Burhan HAFIZI
Ing. Servet VERÇANI
Ing. Gerti HAFIZI
Skala 1:100
Data: Mars 2023
Fleta Nr.11



PROFILIET TERTHORE TE DEGES KRYESORE

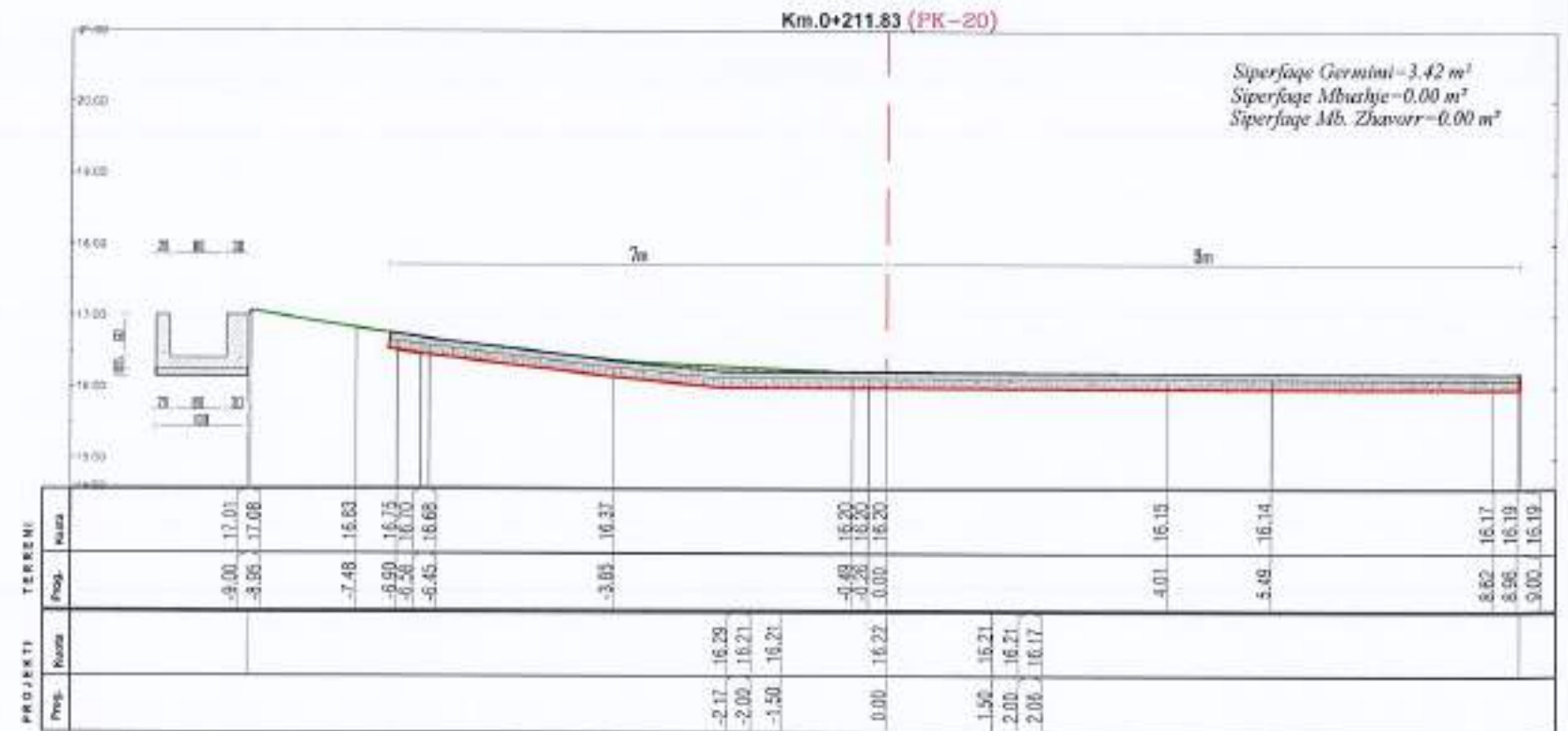
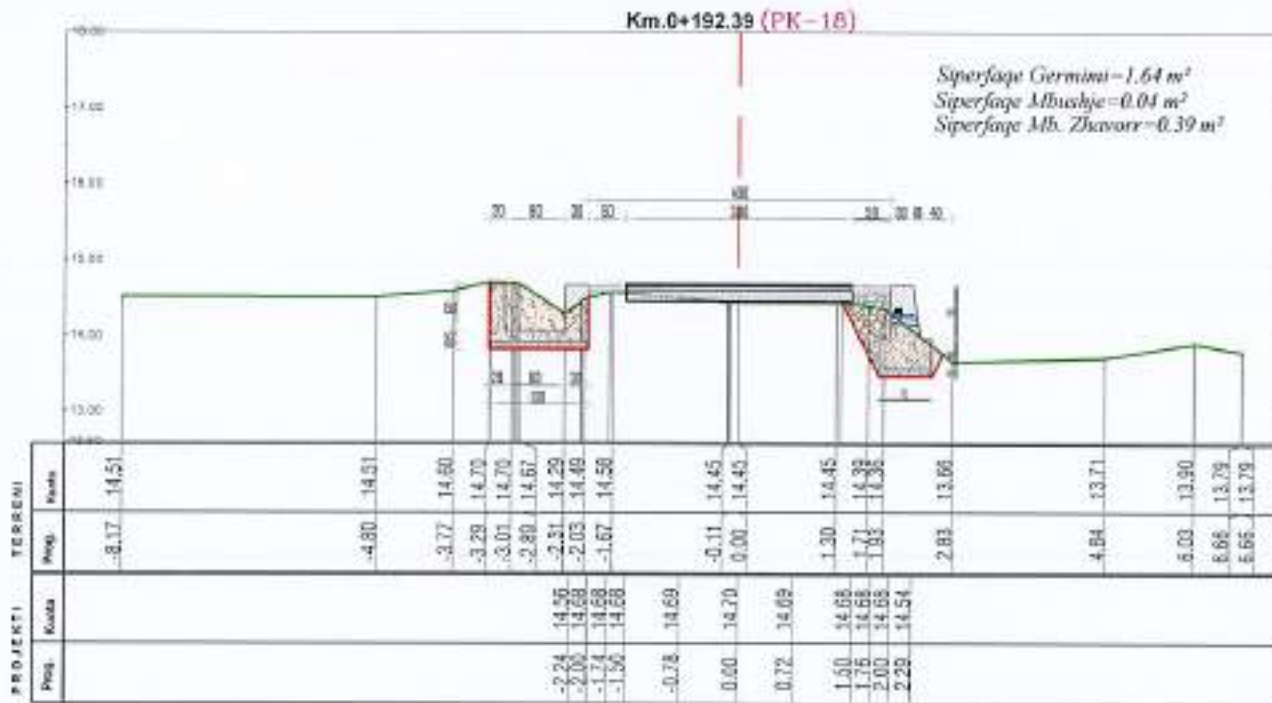
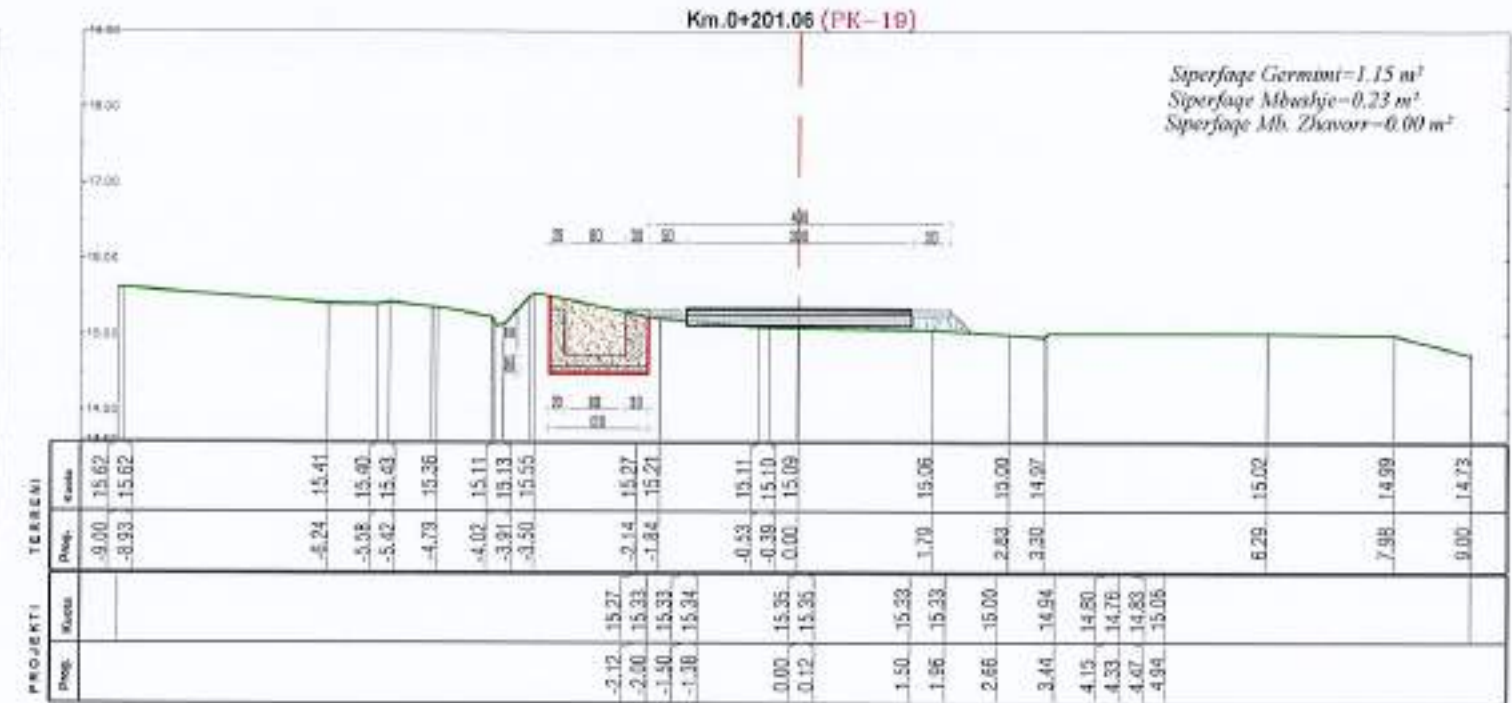
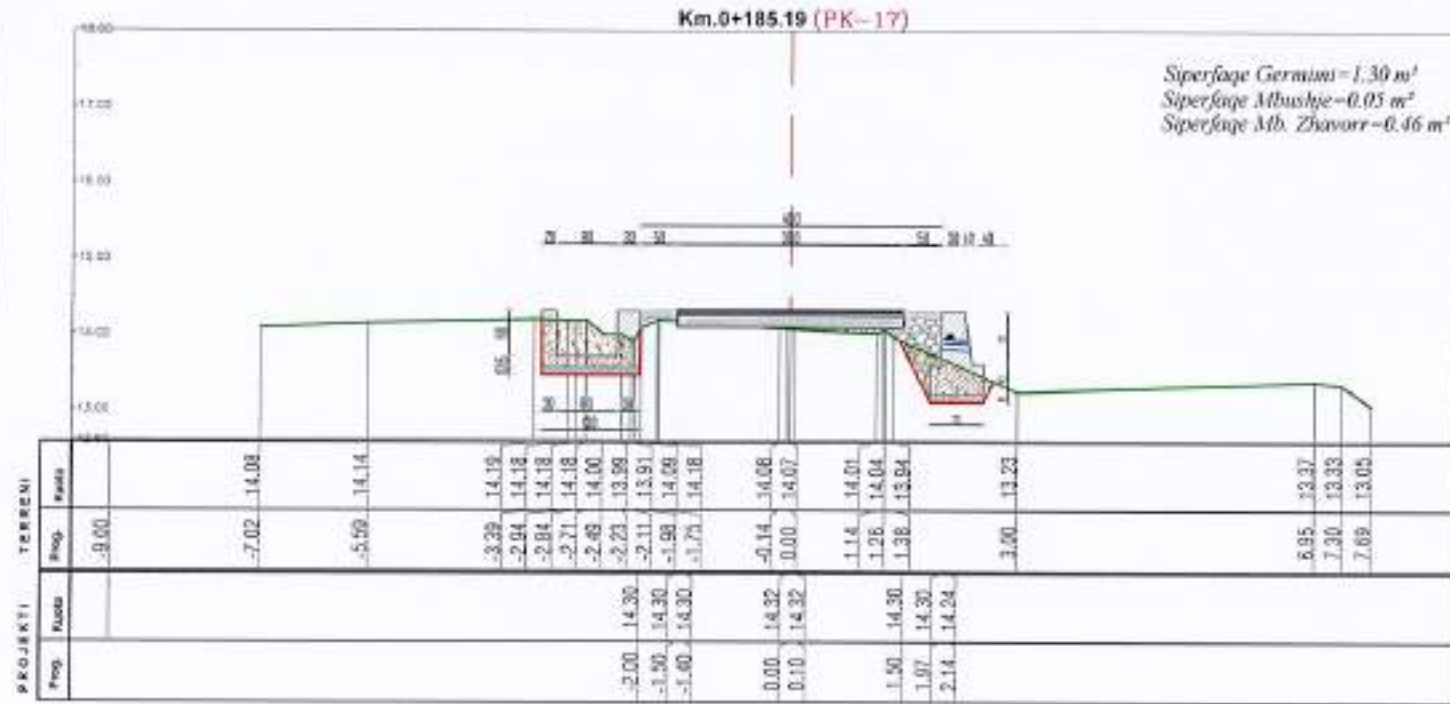

POROSITESI

BASHKIA VAU DEJES



"ANGERBA" shpk

Adresa:Rr."Irfan Tomini" Tirane.
Cel: 069 20 95 862
E-mail: burhanhafizi@gmail.com

VENDODHJA
Bashkia Vau Dejës

TITULLI I PROJEKTI

SISTEMIM ASFALTIM I RRUGES SE MALESOREVE
NJESIA ADMINISTRATIVE BUSHAT

FAZA E PROJEKTIMIT:
PROJEKT ZBATIMI

TITULLI I VIZATIMIT:

PROFILIET TERTHORE
DEGA KRYESORE

Grupi i Projektimit
Ing. Burhan HAFIZI

Ing. Servet VERÇANI

Ing. Gerti HAFIZI

Skala 1:100

Data: Mars 2023

FLETA Nr.12



TABELA E VOLUMEVE RRUGA E MALESOREVE

VOLUMET E GERMIMEVE						VOLUMET E MBUSHJEVE ME DHE					
Nr	Sip.	Sip. Mesatare	D.Pjesore	V. Pjesor	V. Prog. (m³)	Nr	Sip.	Sip. Mesatare	D.Pjesore	V. Pjesor	V. Prog. (m³)
1	0.86					1	0.00				
2	3.32	2.09	5.92	12.37	12.37	2	0.86	0.43	5.92	2.55	2.55
3	2.64	2.98	9.08	27.06	39.43	3	0.75	0.81	9.08	7.31	9.86
4	2.92	2.78	15.00	41.70	81.13	4	0.63	0.69	15.00	10.35	20.21
5	3.62	3.27	15.00	49.05	130.18	5	0.64	0.64	15.00	9.53	29.73
6	3.29	3.46	15.00	51.83	182.01	6	0.79	0.72	15.00	10.73	40.46
7	2.85	3.07	15.00	46.05	228.06	7	1.03	0.91	15.00	13.65	54.11
8	2.57	2.71	15.00	40.65	268.71	8	0.91	0.97	15.00	14.55	68.66
9	2.63	2.60	8.05	20.93	289.64	9	1.24	1.08	8.05	8.65	77.31
10	0.00	1.32	11.12	14.62	304.26	10	0.00	0.62	11.12	6.89	84.20
11	0.67	0.34	15.16	5.08	309.34	11	0.33	0.17	15.16	2.50	86.70
12	0.74	0.71	9.66	6.81	316.15	12	0.05	0.19	9.66	1.85	88.55
13	0.76	0.75	8.11	6.08	322.23	13	0.14	0.10	8.11	0.78	89.34
14	0.78	0.77	9.21	7.09	329.32	14	0.21	0.18	9.21	1.61	90.95
15	0.93	0.86	10.21	8.73	338.05	15	0.09	0.15	10.21	1.55	92.50
16	0.63	0.78	11.89	9.27	347.33	16	0.23	0.16	11.89	1.92	94.42
17	1.30	0.97	11.78	11.37	358.69	17	0.05	0.14	11.78	1.65	96.07
18	1.64	1.47	7.19	10.57	369.26	18	0.04	0.05	7.19	0.32	96.39
19	1.15	1.40	8.67	12.09	381.36	19	0.23	0.14	8.67	1.17	97.56
20	3.42	2.29	10.77	24.61	405.97	20	0.00	0.12	10.77	1.24	98.80

211.82

211.82

VOLUMET E MBUSHJEVE ME ZHAVORR					
Nr	Sip.	Sip. Mesatare	D.Pjesore	V. Pjesor	V. Prog. (m³)
1	0.00				
2	1.87	0.94	5.92	5.54	5.54
3	1.92	1.90	9.08	17.21	22.74
4	1.55	1.74	15.00	26.03	48.77
5	1.49	1.52	15.00	22.80	71.57
6	1.49	1.49	15.00	22.35	93.92
7	1.49	1.49	15.00	22.35	116.27
8	1.49	1.49	15.00	22.35	138.62
9	1.49	1.49	8.05	11.99	150.61
10	0.00	0.75	11.12	8.28	158.90
11	0.00	0.00	15.16	0.00	158.90
12	0.00	0.00	9.66	0.00	158.90
13	0.00	0.00	8.11	0.00	158.90
14	0.00	0.00	9.21	0.00	158.90
15	0.00	0.00	10.21	0.00	158.90
16	0.00	0.00	11.89	0.00	158.90
17	0.46	0.23	11.78	2.71	161.61
18	0.39	0.43	7.19	3.06	164.66
19	0.00	0.20	8.67	1.69	166.35
20	0.00	0.00	10.77	0.00	166.35

211.82

Volumi Total i Germimit V= 405.97 m3
 Volumi Total i Mbushjes me material te germuar V= 98.80 m3
 Volumi Total i Mbushjes me zhavorr V= 166.35 m3



SEKSION TIP PK.2-10
SH. 1:25

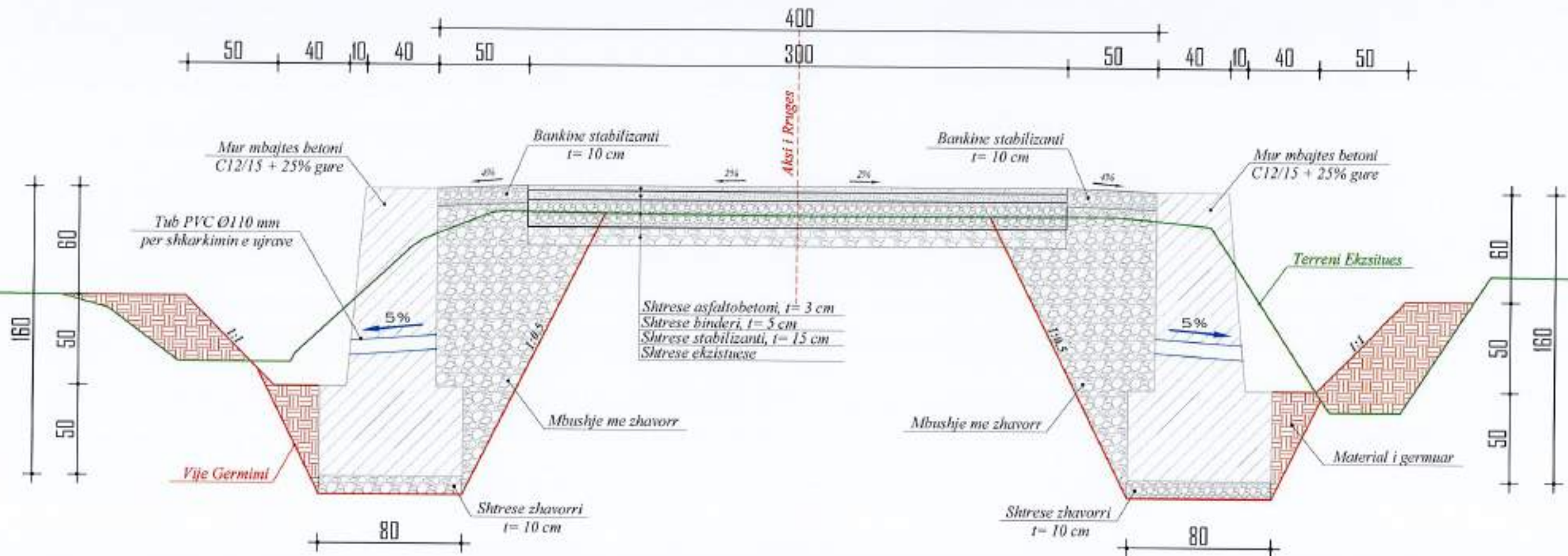

SEKSION TIP PK.10-15
SH. 1:25

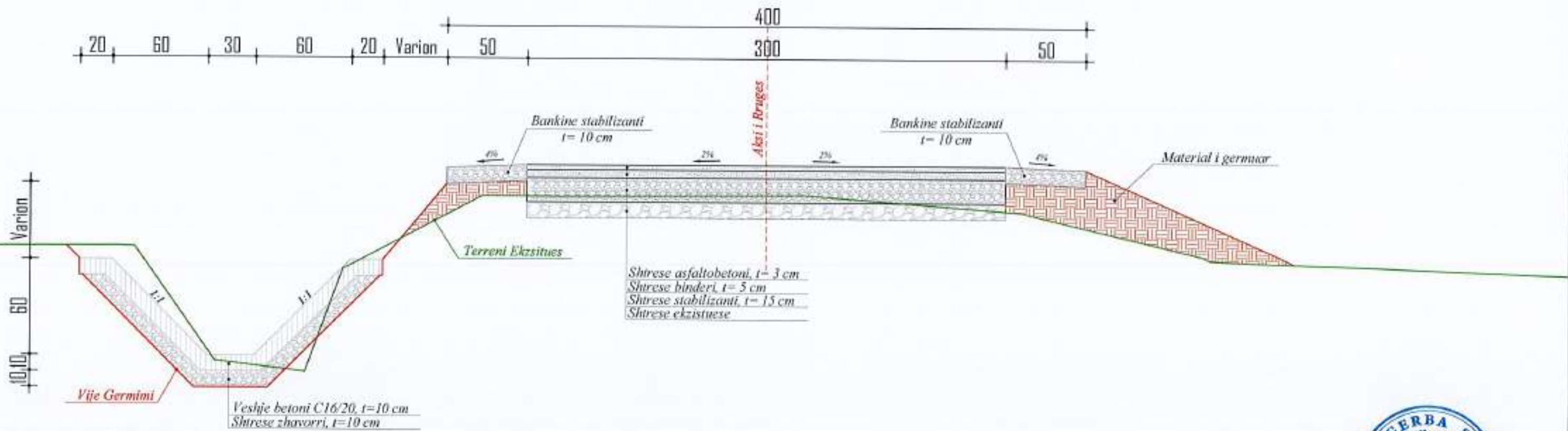

POROSITESI

BASHKIA VAU DEJES



"ANGERBA" shpk

Adresa: Rr. "Irfan Tomini" Tirane.
Cel: 069 29 95 062
E-mail: burhanhafizi@gmail.com

VENDOSJA
Bashkia Vau Dejes

TITULLI I PROJEKTTI

SISTEMIM ASFALTIM I RRUGES SE MALESOREVE
NJESIA ADMINISTRATIVE BUSHAT

FAZA E PROJEKTTIMIT:
PROJEKT ZBATIMI

TITULLI I VIZATIMIT:
SEKSIONET TIP TE RRUGES
KRYESORE

Grupa i Projektit
Ing. Burhan HAFIZI
Ing. Servet VERÇANI
Ing. Gerti HAFIZI

Shkalla 1:25
Data: Mars 2023
FETA Nr.13



PLANIMETRIA E TOMBINOS
SH. 1:50

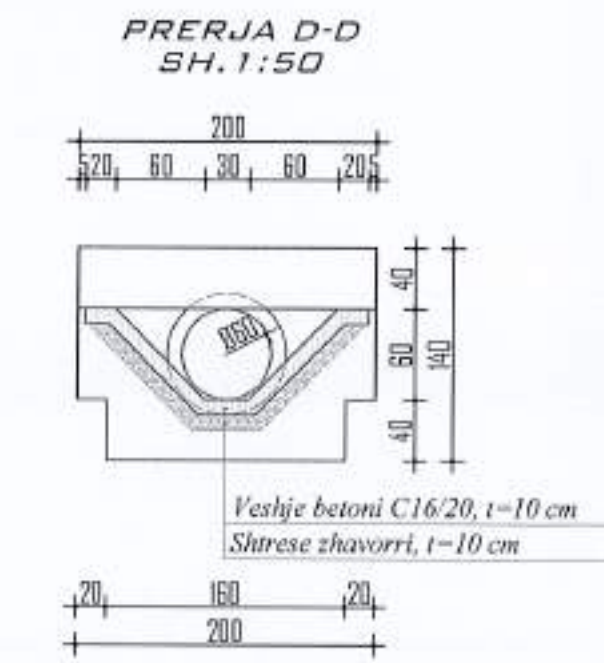
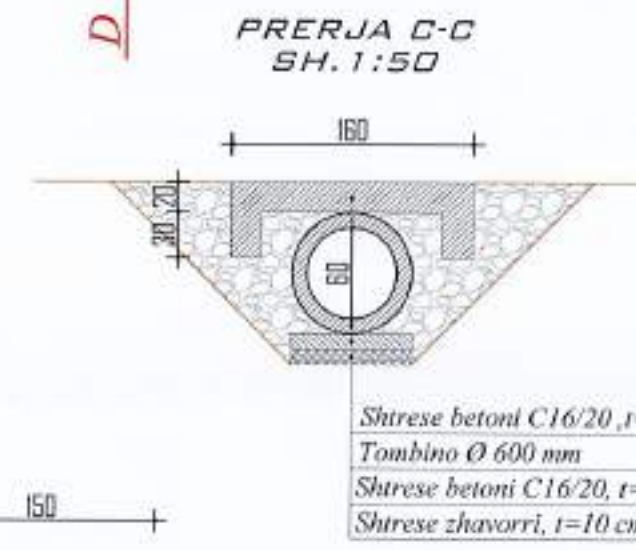
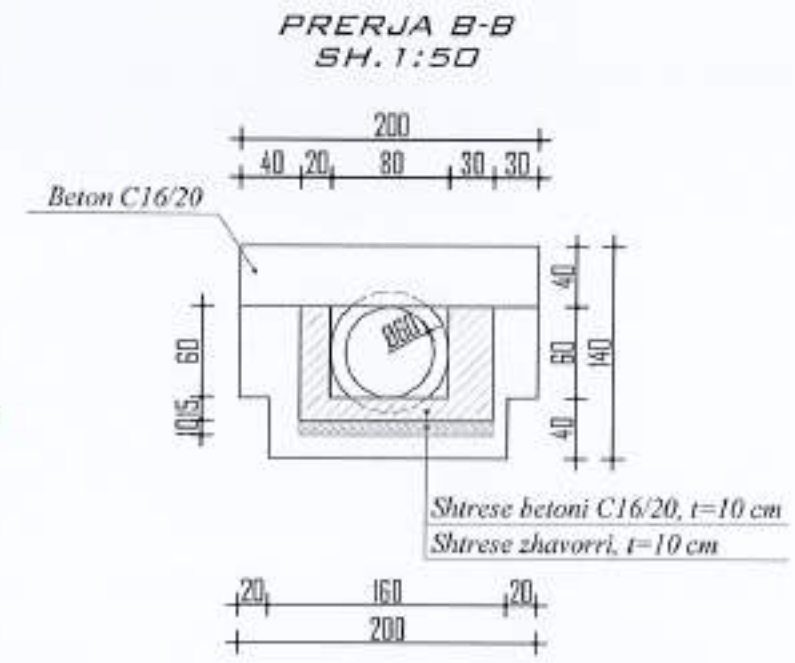
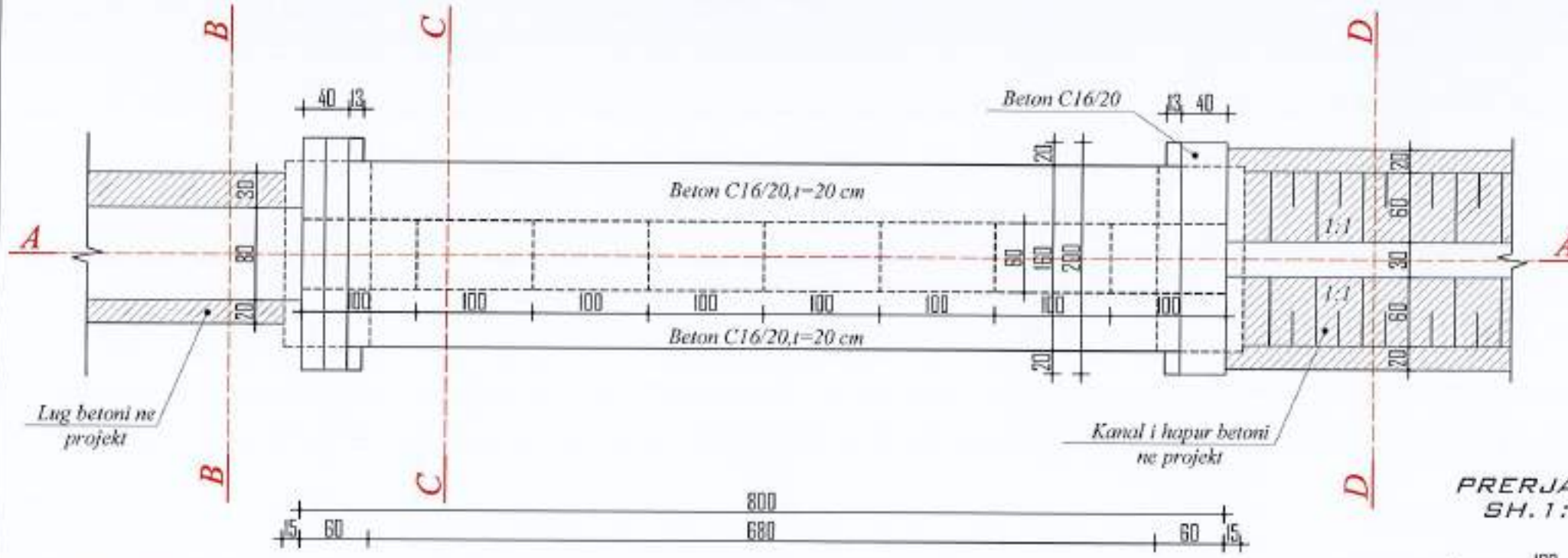

PRERJA A-A
SH. 1:50



TABELA E VOLUMEVE

Nr.	EMERTIMI I PUNIMIT	NJESIA	SASIA
1	Germim dheu ekskavator per vepren	m ³	22.0
2	Nenshtrese zhavorri t=10 cm	m ²	3.0
3	Beton C 16/20 per mure	m ³	3.3
4	Beton C 16/20 per shtrese mbi tuba	m ³	2.3
5	F.V. tub betoni Ø 600 mbi shtrese betoni	ml	8.0
6	Mbushje me zhavorr	m ³	4.0

<p>POROSITESI</p> <p>BASHKIA VAU DEJES</p>	 <p>"ANGERBA" shpk Adresa: Rr. "Irfan Tomini" Tirane. Cel: 069 20 95 862 E-mail: burhanhafizi@gmail.com</p>	<p>VENDODHJA Bashkia Vau Dejes</p> <p>TITULLI I PROJEKTIT SISTEMIM ASFALTIM I RRUGES SE MALESOREVE NJESIA ADMINISTRATIVE BUSHAT</p>	<p>FAZA E PROJEKTIMIT: PROJEKT ZBATIMI</p> <p>TITULLI I VIZATIMIT: TOMBINO Ø600 MM , L=8 M PLAN, PRERJE</p>	<p>Grupi i Projektimit: Ing. Burhan HAFIZI Ing. Servet VERÇANI Ing. Gerti HAFIZI</p> <p>Shkalla: 1:50 Data: Mars 2023 FLET Nr.15</p> 
---	---	--	---	--

PLANIMETRIA E TOMBINOS
SH. 1:50

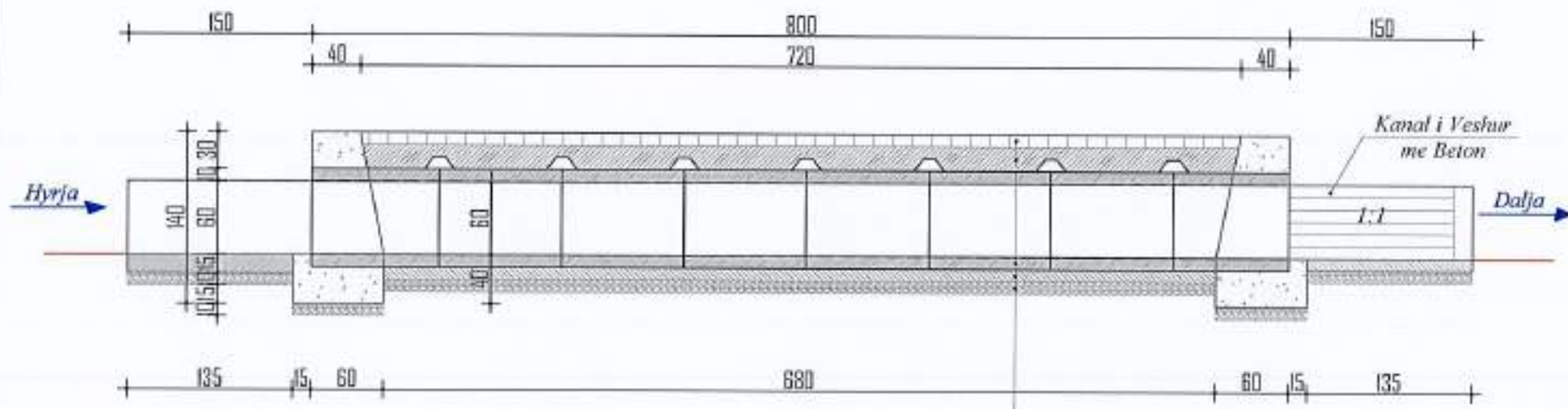
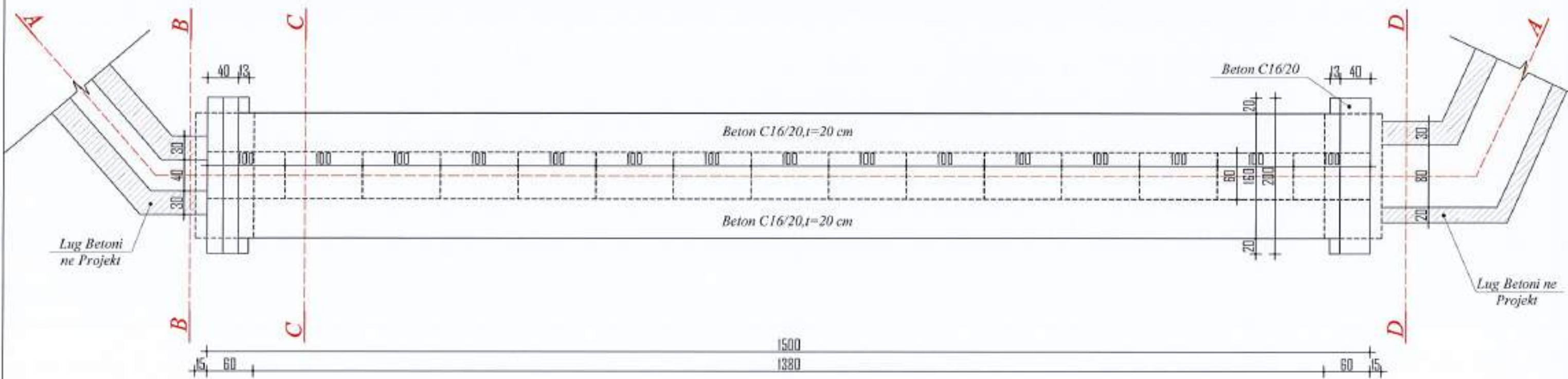

PRERJA A-A
SH. 1:50

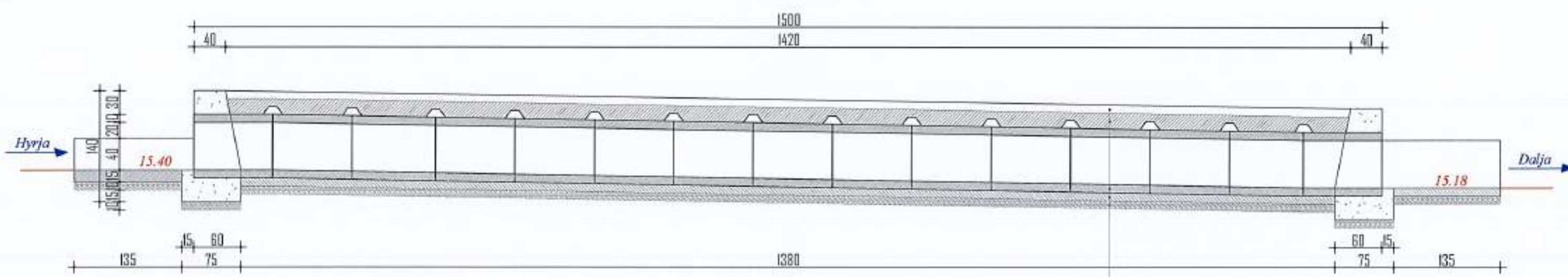

- Shtrese me pllaka, t= 10 cm
- Shtrese betoni C16/20, t=20 cm
- Tombino Ø 600 mm
- Shtrese betoni C16/20, t=10 cm
- Shtrese zhavorri, t=10 cm

<p>POROSITESI</p> <p>BASHKIA VAU DEJES</p>	 <p>"ANGERBA" shpk</p> <p>Adresa: Rr. "Irfan Tomini" Tirane, Cel: 069 20 95 862 E-mail: burhanhafizi@gmail.com</p>	<p>VENDODHJA</p> <p>Bashkia Van Dejes</p> <p>TITULLI I PROJEKTTIT</p> <p>SISTEMIM ASFALTIM I RRUGES SE MALESOREVE NJESIA ADMINISTRATIVE BUSHAT</p>	<p>FAZA E PROJEKTIMIT:</p> <p>PROJEKT ZBATIMI</p> <p>TITULLI I VIZATIMIT:</p> <p>TOMBINO Ø600 MM, L=15 M PLAN, PRERJE</p>	<p>Grupi i Projektimit</p> <p>Ing. Burhan HAFIZI</p> <p>Ing. Servet VERÇANI</p> <p>Ing. Gerti HAFIZI</p> <p>Shkalla: 1:50</p> <p>Data: Mars 2023</p> <p>ATA Nr.16</p> 
---	--	---	---	---

PRERJA B-B
SH. 1:50

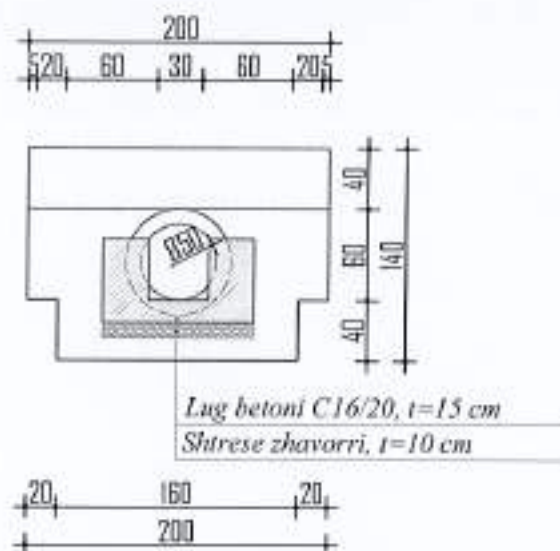

PRERJA C-C
SH. 1:50

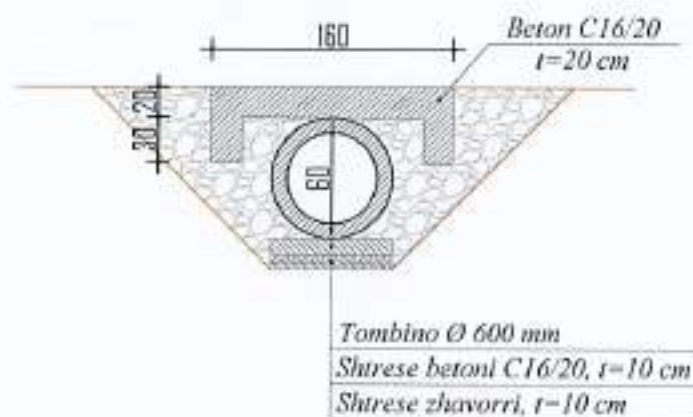

PRERJA D-D
SH. 1:50



TABELA E VOLUMEVE

Nr.	EMERTIMI I PUNIMIT	NJESIA	SASIA
1	Germim dheu ekskavator per vepren	m ³	40.0
2	Nenshtrese zhavorri t = 10 cm	m ²	3.0
3	Beton C 16/20 per mure	m ³	3.3
4	Beton C 16/20 per shtrese mbi tuba,t = 20 cm	m ³	4.5
5	F.V. tub betoni Ø 600 mbi shtrese betoni	ml	15.0
6	Mbushje me zhavorr	m ³	6.0

POROSITESI

BASHKIA VAU DEJES

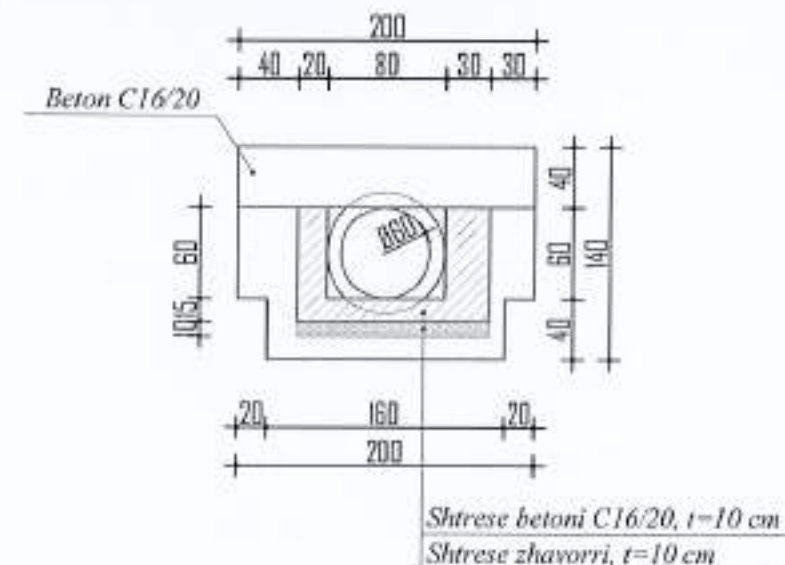

"ANGERBA" shpk

Adresa: Rr. "Irfan Tomini" Tiranë.
Cel: 069 20 95 662
E-mail: burhanhafizi@gmail.com

VENDODHJA
Bashkia Vau Dejes

TITULLI I PROJEKTT

SISTEMIM ASFALTIM I RRUGES SE MALESOREVE
NJESIA ADMINISTRATIVE BUSHAT

FAZA E PROJEKTIMIT:
PROJEKT ZBATIMI

TITULLI I VIZATIMIT:

TOMBINO Ø600 MM, L=15 M
PRERJE

Grupi i Projektimit

Ing. Burhan HAFIZI
Ing. Servet VERÇANI
Ing. Gerti HAFIZI



Shifra 1:50

Data: Mars 2023

FLETJA Nr.17

DEGA E DJATHTE



PLANIMETRIA E DEGES SE DJATHTE

Legjende

- Asfalt Ekzistues
- Rruge Ekzistuese
- Gardhe Ekzistues
- Mure Rrethues Ekzistues
- Rruge ne Projekt
- Mure ne Projekt
- Lug Betoni ne Projekt



POROSITESI
BASHKIA VAU DEJES



"ANGERBA" shpk
Adresa: Rr. "Irfan Tomini" Tirane.
Cel: 069 20 95 862
E-mail: burhanhafizi@gmail.com

VENDODHIA
Bashkia Vau Dejes

TITULLI I PROJEKTI
**SISTEMIM ASFALTIM I RRUGES SE MALESOREVE
NJESIA ADMINISTRATIVE BUSHAT**

FAZA E PROJEKTIMIT
PROJEKT ZBATIMI

TITULLI I VIZATIMIT
**PLANIMETRIA E DEGES SE DJATHTE
PK.1-6**

Grupi i Projektimit
Ing. Burhan HAFIZI
Ing. Servet VERÇANI
Ing. Gerti HAFIZI

Skala 1:250
Data Mars 2023
FLETA Nr.1

PLANIMETRIA E DEGES SE DJATHTE

Legjende

-  Asfalt Ekzistues
-  Rruge Ekzistuese
-  Gardhe Ekzistues
-  Mure Rrethues Ekzistues
-  Rruge ne Projekt
-  Mure ne Projekt
-  Lug Betoni ne Projekt



POROSITESI
BASHKIA VAU DEJES

"ANGERBA" shpk
Adresa: Rr. "Irfan Tomini" Tirane.
Cel: 069 20 95 882
E-mail: burhanhafizi@gmail.com

VENDODHJA
Bashkia Vau Dejes

TITULLI I PROJEKTIT
**SISTEMIM ASFALTIM I RRUGES SE MALESOREVE
NJESIA ADMINISTRATIVE BUSHAT**

FAZA E PROJEKTIMIT
PROJEKT ZBATIMI

TITULLI I VIZATIMIT
**PLANIMETRIA E DEGES SE DJATHTE
PK.6-13**

Grupi i Projektimit
Ing. Burhan HAFIZI
Ing. Servet VERÇANI
Ing. Gerti HAFIZI

Skala 1:250
Data: Mars 2023
FOLIA Nr.2



PLANIMETRIA E DEGES SE DJATHTE

Legjende

-  Asfalt Ekzistues
-  Rruge Ekzistuese
-  Gardhe Ekzistues
-  Mure Rrethues Ekzistues
-  Rruge ne Projekt
-  Mure ne Projekt
-  Lug Betoni ne Projekt

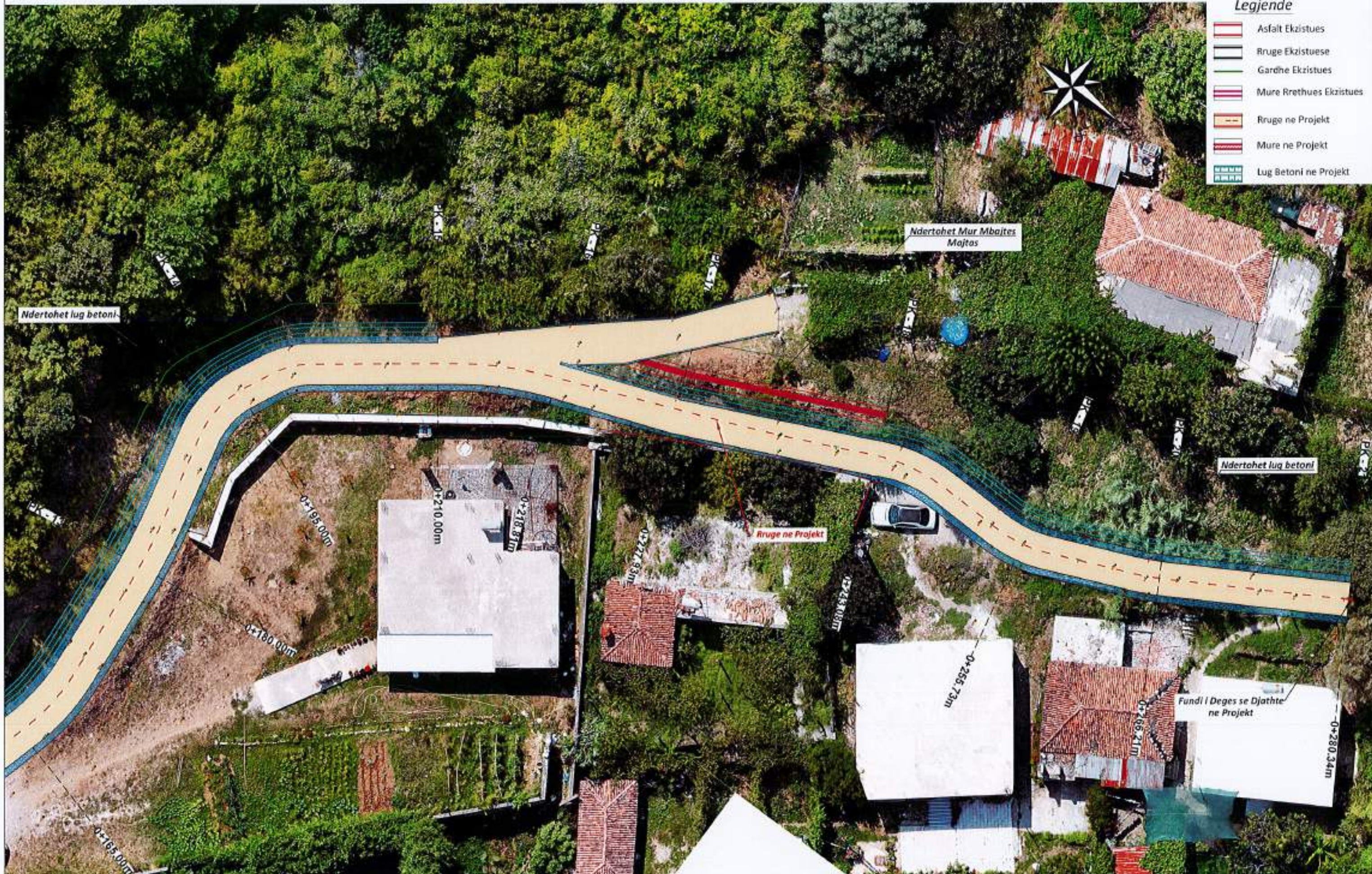

POROSITESI
BASHKIA VAU DEJES



"ANGERBA" shpk
 Adresa: Rr. "Irfan Tomini" Tirane,
 Cel: 069 20 95 862
 E-mail: burhanhafizi@gmail.com

VENDODHJA
 Bashkia Vau Dejes

TITULLI I PROJEKTTIT
**SISTEMIM ASFALTIM I RRUGES SE MALESOREVE
 NJESIA ADMINISTRATIVE BUSHAT**

FAZA E PROJEKTIMIT:
PROJEKT ZBATIMI

TITULLI I VIZATIMIT:
**PLANIMETRIA E DEGES SE DJATHTE
 PK.13-21**

Grupi i Projektimit
 Ing. Burhan HAFIZI
 Ing. Servet VERÇAN
 Ing. Gerti HAFIZI

Skala 1:250
 Mars 2023
 FLUTA Nr.3



PROFILI GJATESOR I DEGES SE DJATHTE
SH 1:100 ; 1:1000

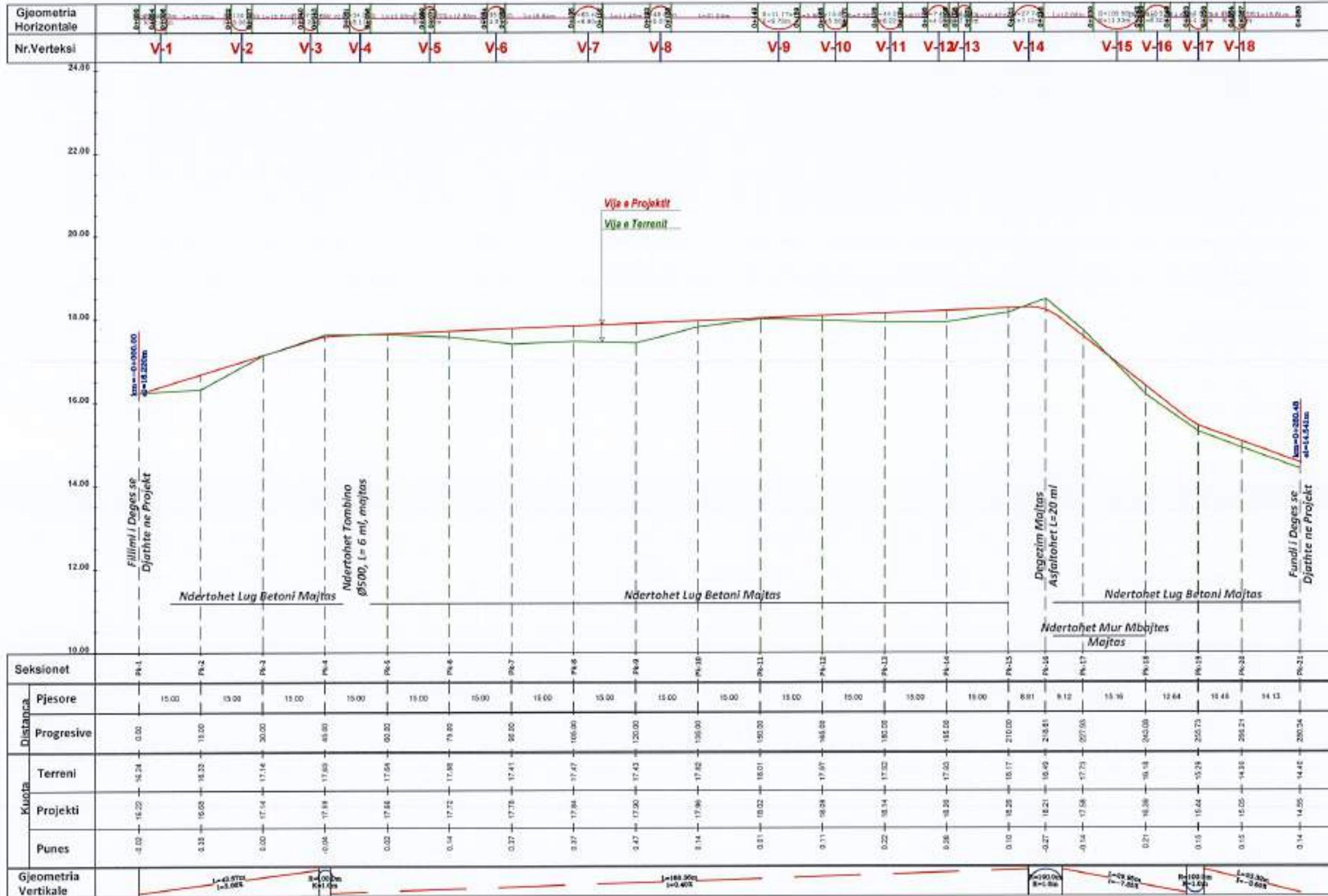

POROSITESI

BASHKIA VAU DEJES



"ANGERBA" shpk

Adresa: Rr. "Yrfan Tomini" Tirane.
Cel: 069 20 95 862
E-mail: burhanhafizi@gmail.com

VENDODHJA
Bashkia Vau Dejes

TITULLI I PROJEKTTI
SISTEMIM ASFALTIM I RRUGES SE MALESOREVE
NJESIA ADMINISTRATIVE BUSHAT

FAZA E PROJEKTIMIT:
PROJEKT ZBATIMI

TITULLI I VIZATIMIT:
PROFILI GJATESOR I DEGES SE
DJATHTE

Grupi i Projektimit
Ing. Burhan HAFIZI
Ing. Servet VERÇANI
Ing. Gerti HAFIZI
Shkallë 1:100; 1:1000
Data: Mars 2023
FLETË Nr.4



PROFILET TERTHORE TE DEGES SE DJATHE

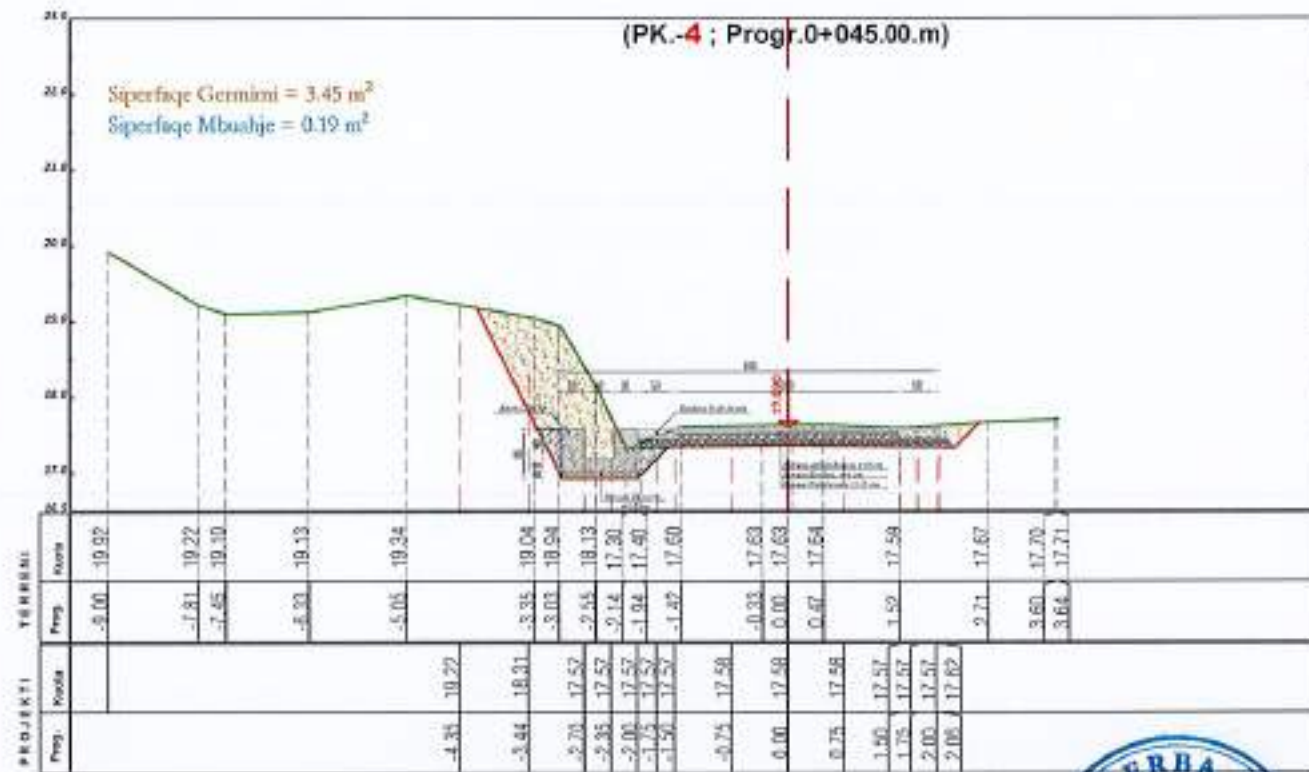
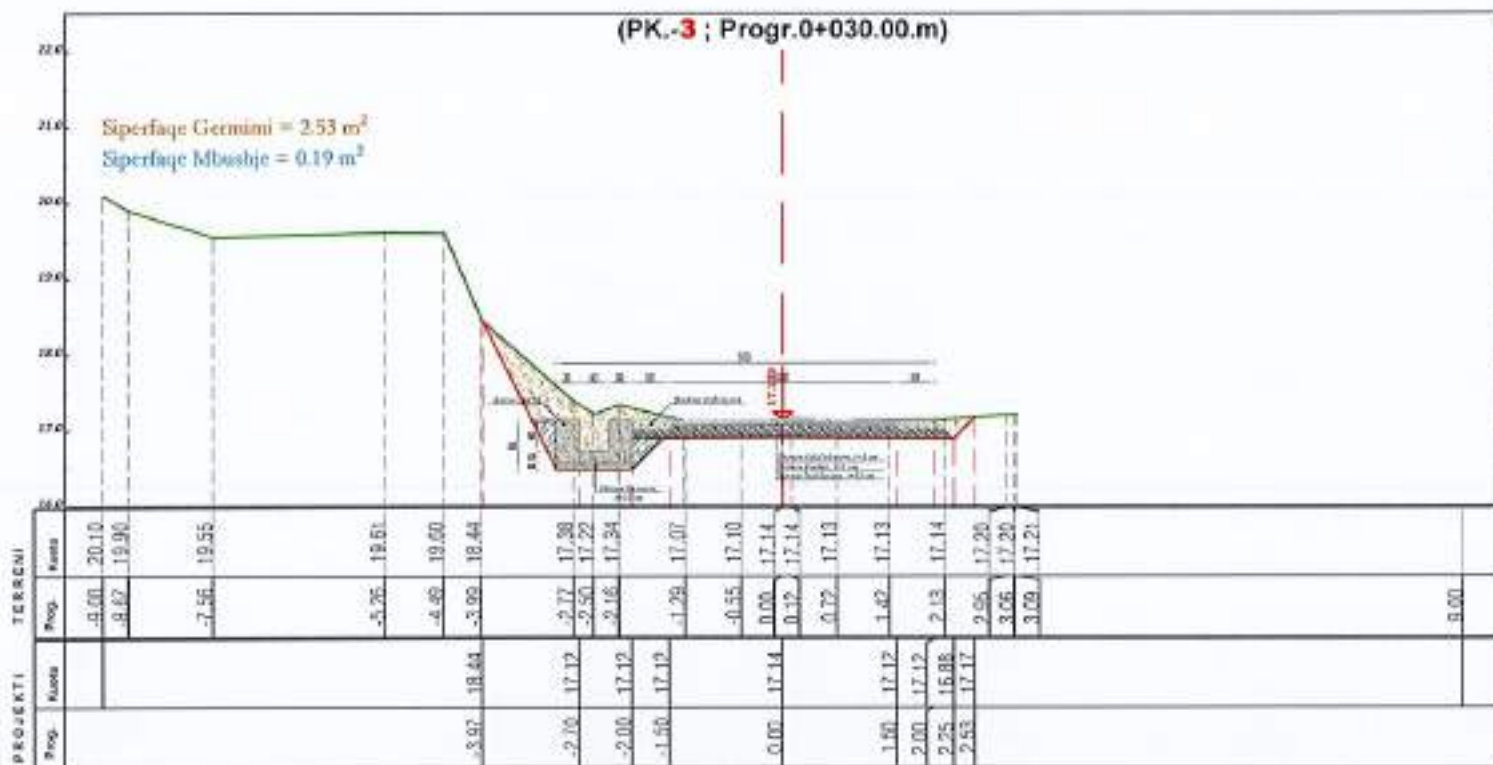
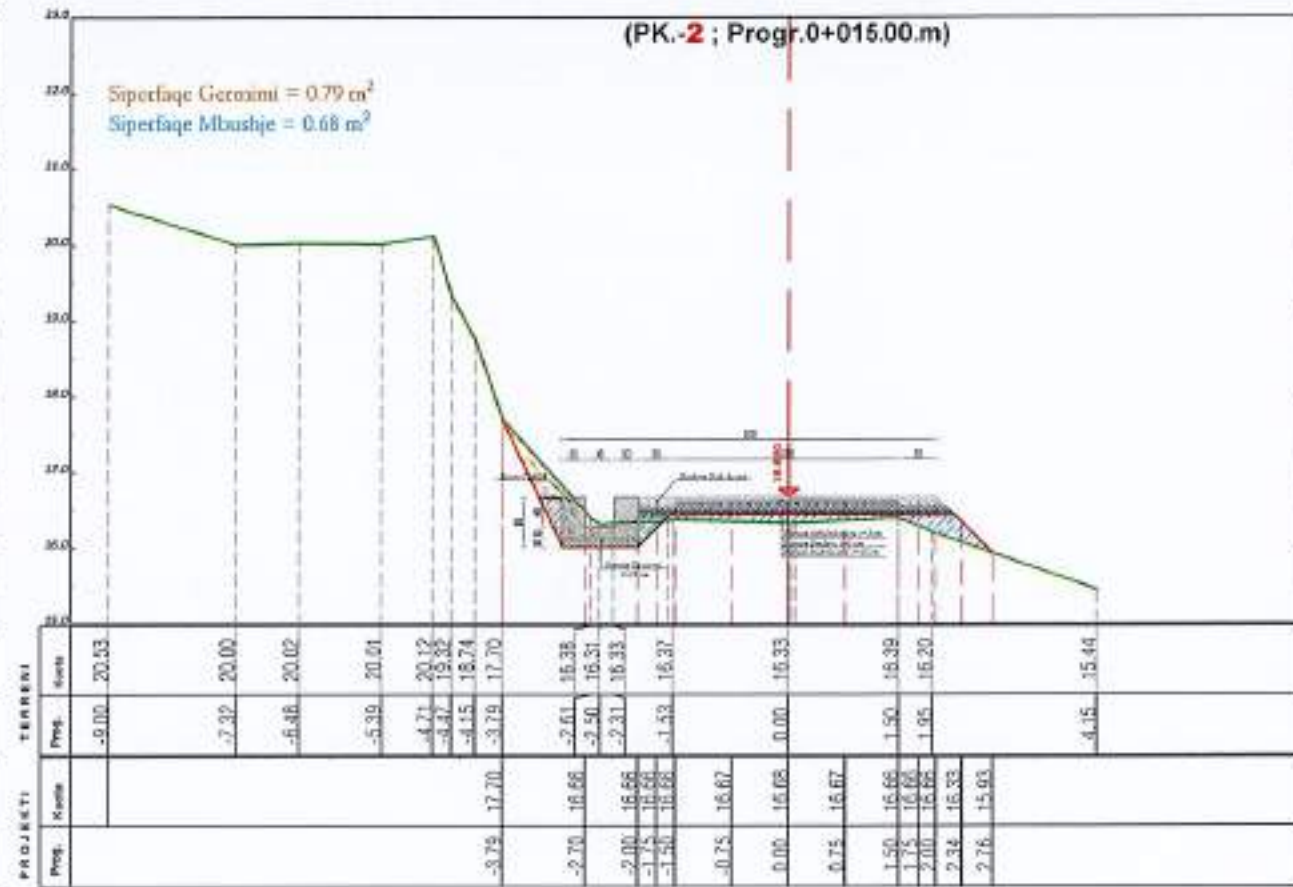
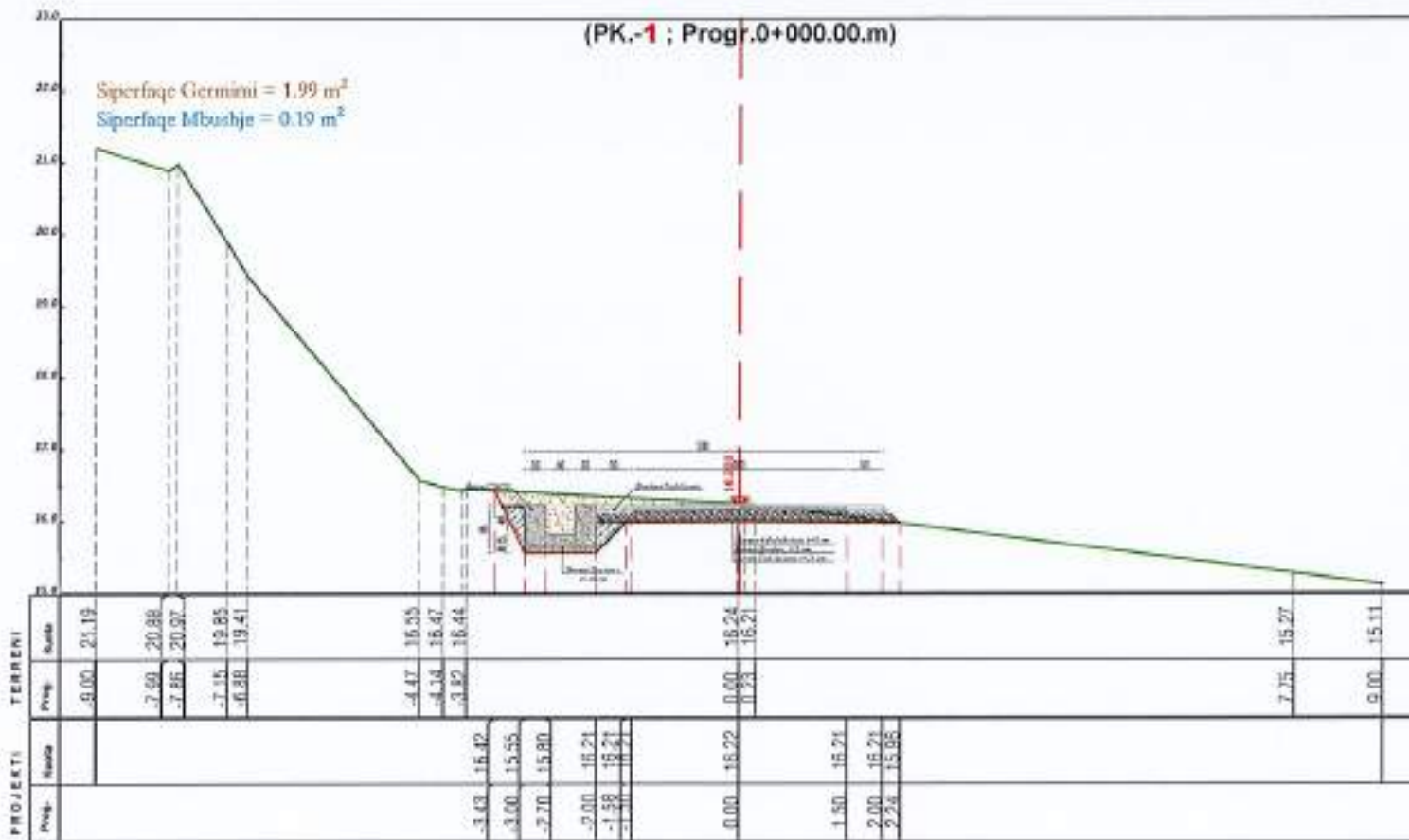

POROSITESI
BASHKIA VAU DEJES



"ANGERBA" shpk
Adresa: Rr. "Irfan Tomini" Tirane.
Cel: 089 20 95 882
E-mail: burhanhafizi@gmail.com

VENDËDHIA
Bashkia Vau Dejes
TITULLI I PROJEKTI
SISTEMIM ASFALTIM I RRUGES SE MALESOREVE
NJESIA ADMINISTRATIVE BUSHAT

FAZA E PROJEKTIMIT:
PROJEKT ZBATIMI
TITULLI I VEZATIMIT:
PROFILET TERTHORE
DEGA E DJATHITE

Grupi i Projektimit:
Ing. Burhan HAFIZI
Ing. Serret VERÇANI
Ing. Gerti HAFIZI
Shkalla 1:100
Data: Mars 2023
LET Nr.5



PROFILET TERTHORE TE DEGES SE DJATHTE

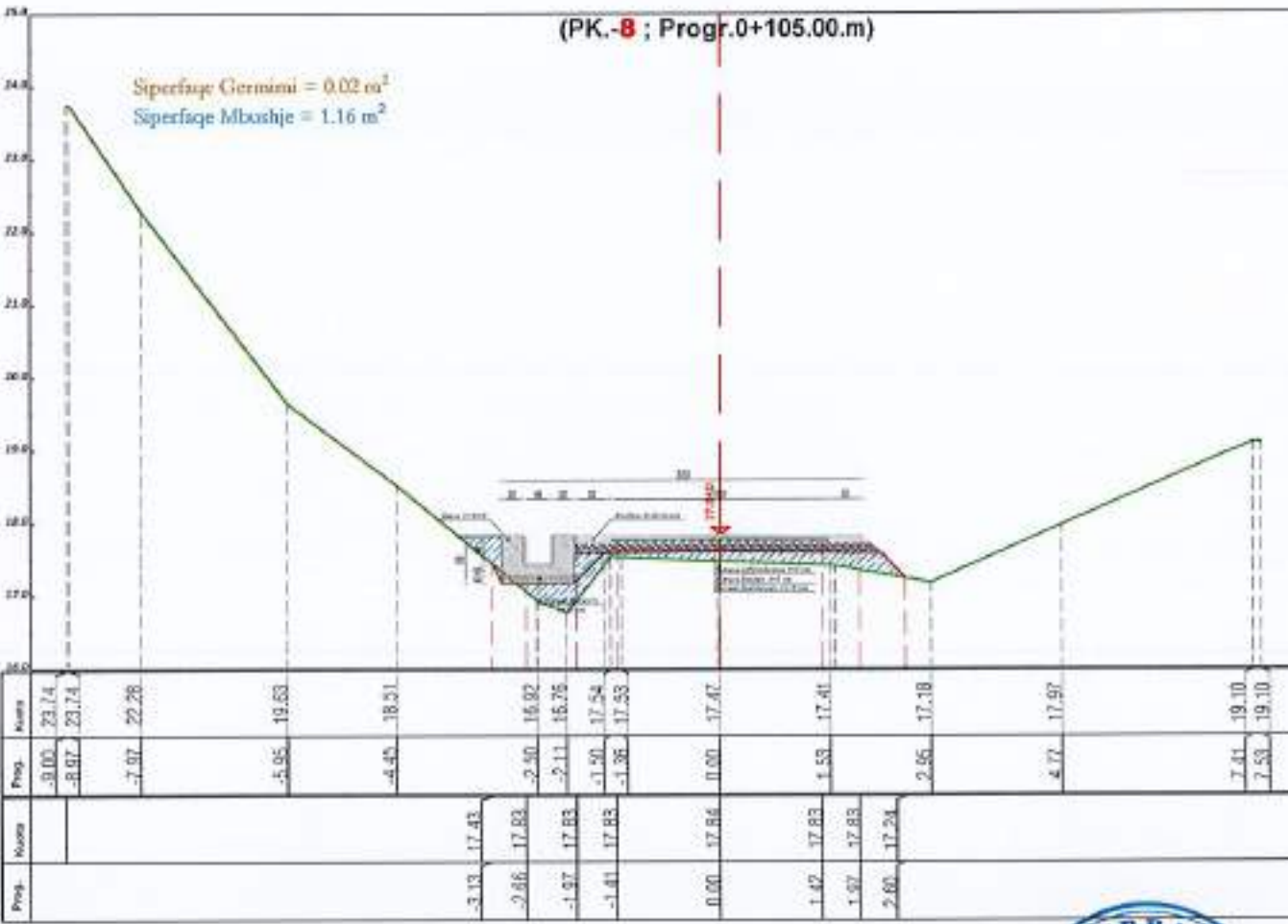
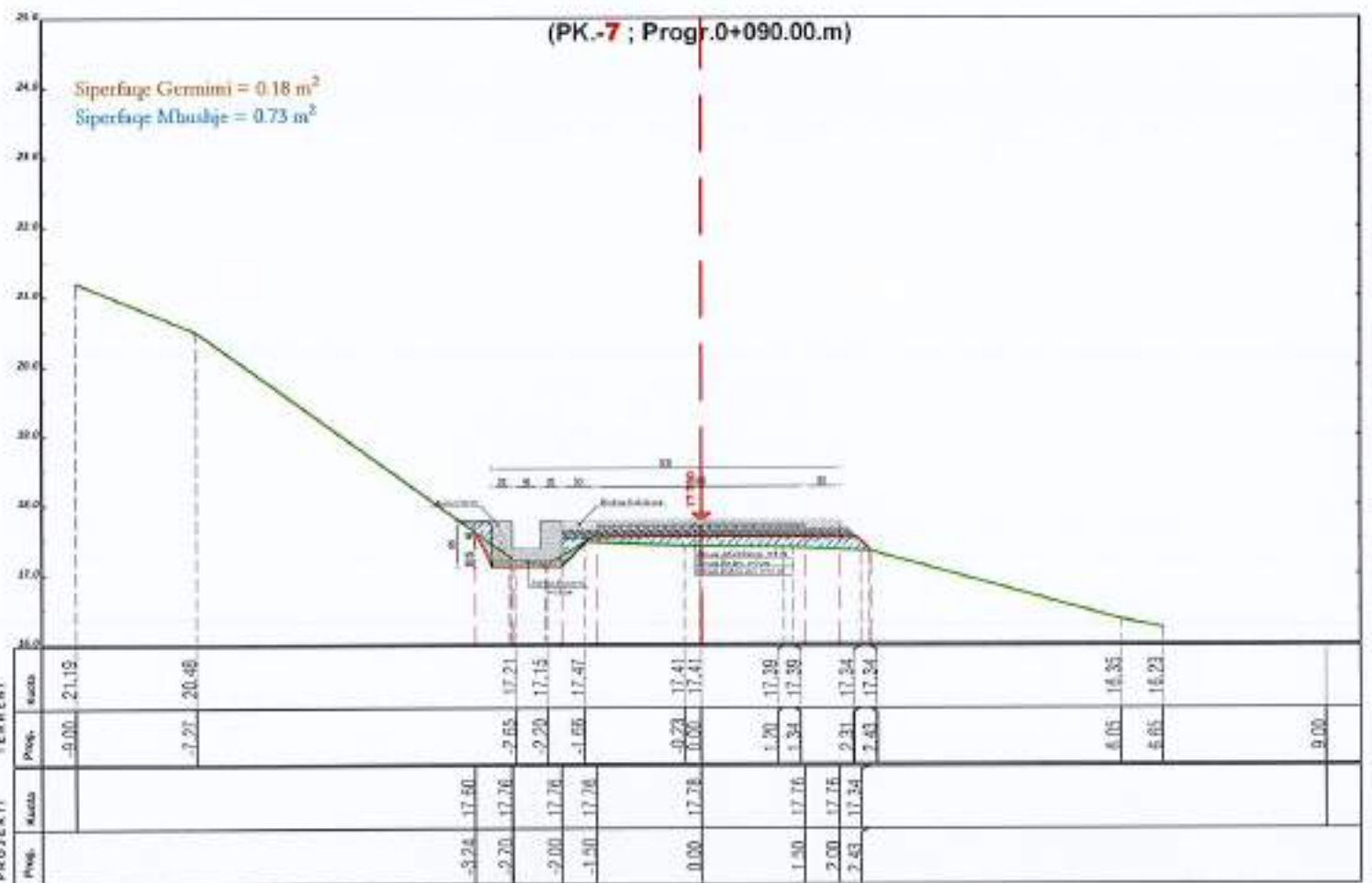
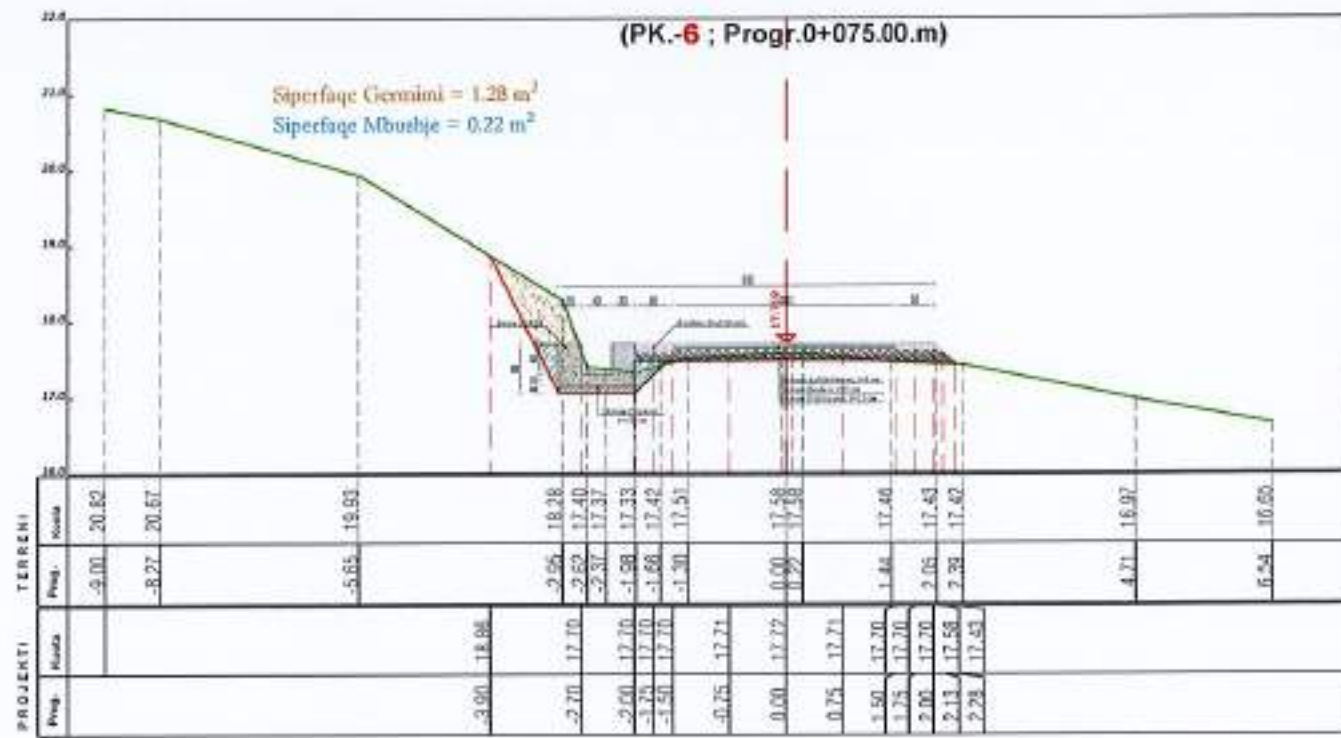
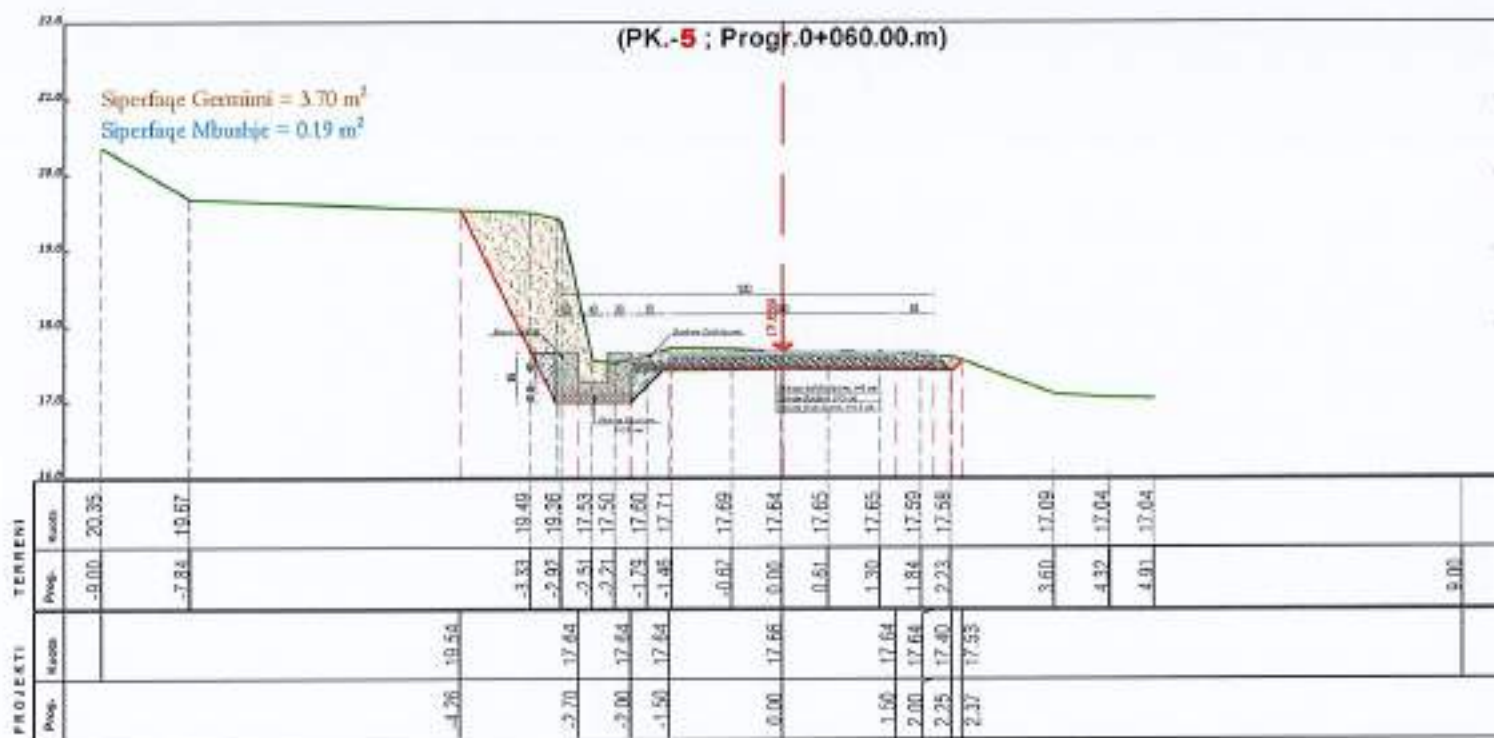

POROSITESI
BASHKIA VAU DEJES



"ANGERBA" shpk
Adresa: Rr. "Irfan Tomini" Tirano.
Cel: 069 20 95 862
E-mail: burhanhafizi@gmail.com

VENDOSJA
Bashkia Vau Dejes
TITULLI I PROJEKTIT
SISTEMIM ASFALTIM I RRUGES SE MALESOREVE
NJESIA ADMINISTRATIVE BUSHAT

FAZA E PROJEKTIMIT:
PROJEKT ZBATIMI
TITULLI I VIZATIMIT:
PROFILET TERTHORE
DEGA E DJATHTE

Grupi i Projektimit
Ing. Burhan HAFIZI
Ing. Servet VERCANI
Ing. Gerti HAFIZI
Shkalla: 1:100
Data: Mars 2023
FLEA Nr.6



PROFLET TERTHORE TE DEGES SE DJATHTE

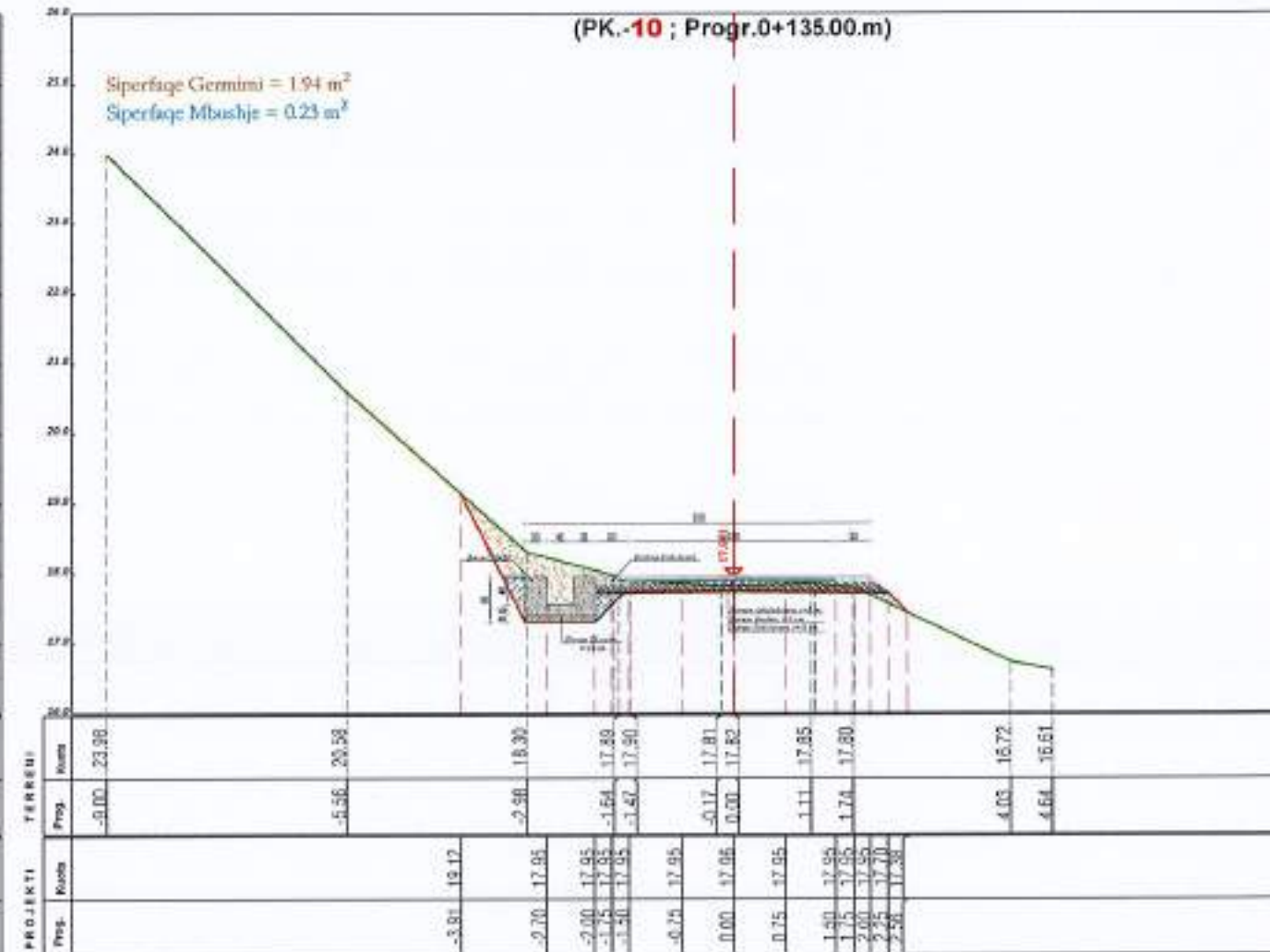
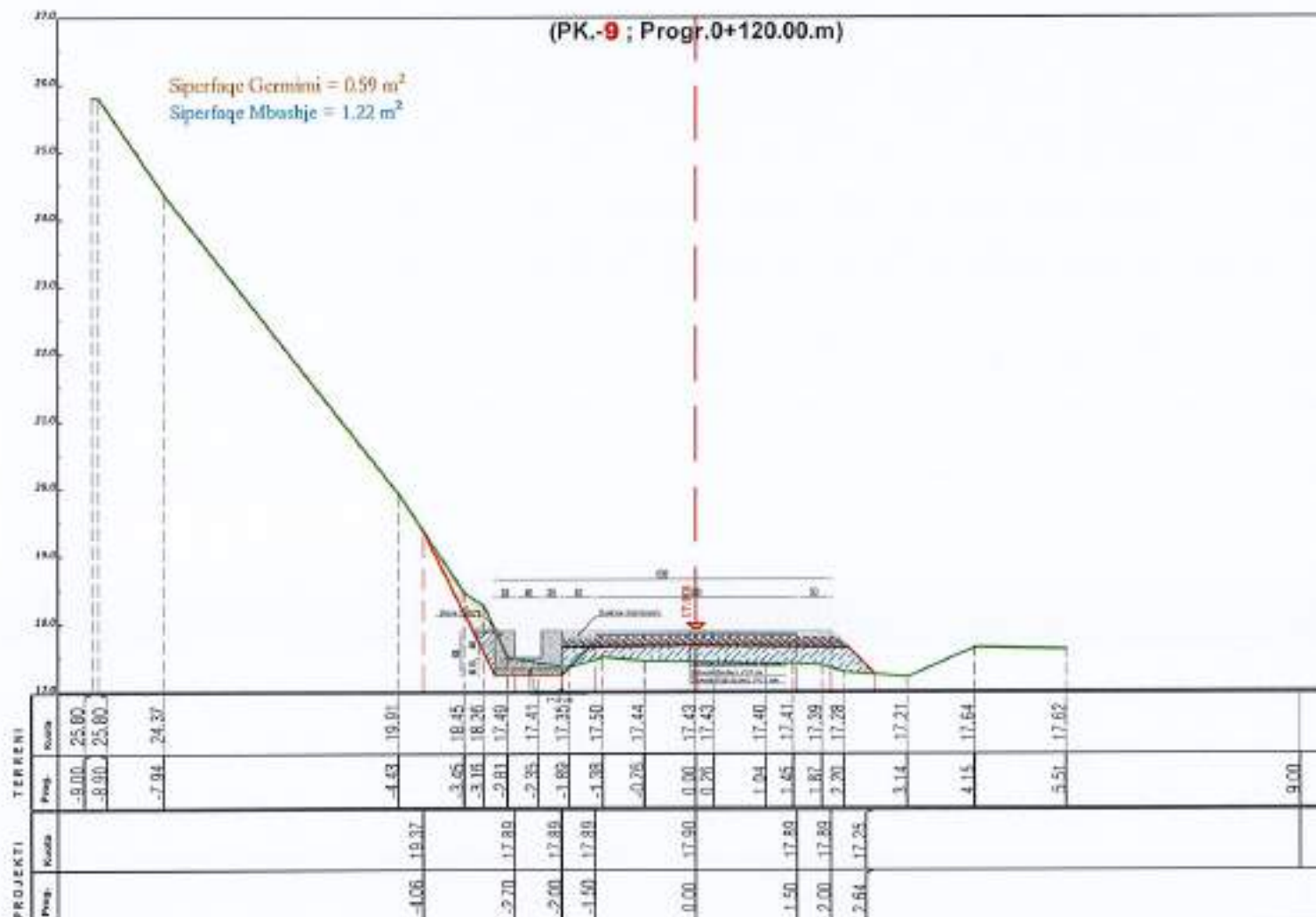

POROSITESI
BASHKIA VAU DEJES



"ANGERBA" shpk
Adresa: Rr. "Irfan Tomini" Tirane.
Cel: 069 20 95 882
E-mail: burhanhafizi@gmail.com

VENDODHJA
Bashkia Vau Dejes
TITULLI I PROJEKTTIT
**SISTEMIM ASFALTIM I RRUGES SE MALESOREVE
NJESIA ADMINISTRATIVE BUSHAT**

FAZA E PROJEKTIMIT:
PROJEKT ZBATIMI
TITULLI I VIZATIMIT:
**PROFLET TERTHORE
DEGA E DJATHTE**

Grupi i Projektimit
Ing. Burhan HAFIZI
Ing. Servet VERÇANI
Ing. Gerti HAFIZI
Shkollor: 100
Data: Mars 2023
FLET Nr.7



PROFLET TERTHORE TE DEGES SE DJATHTE

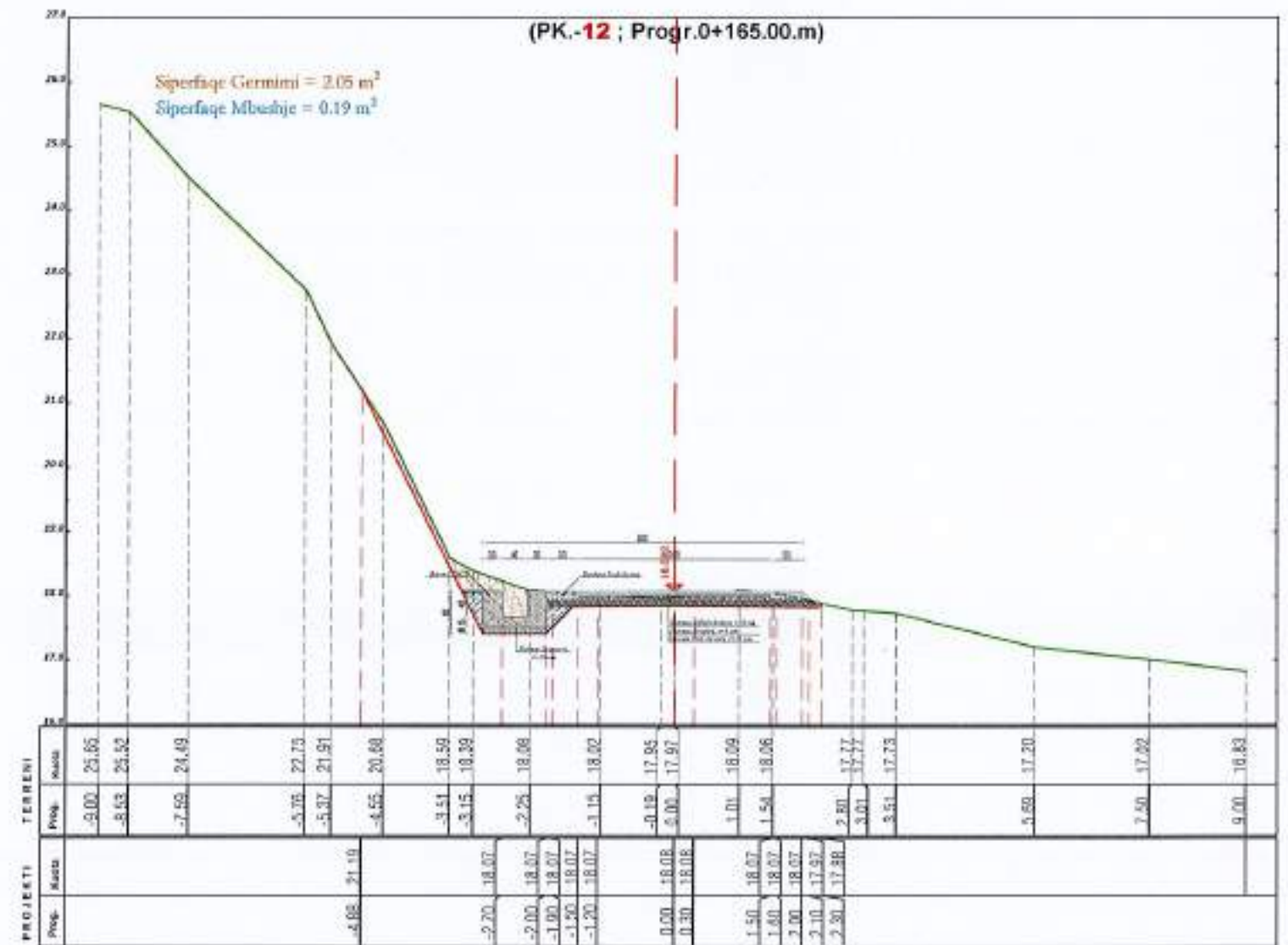
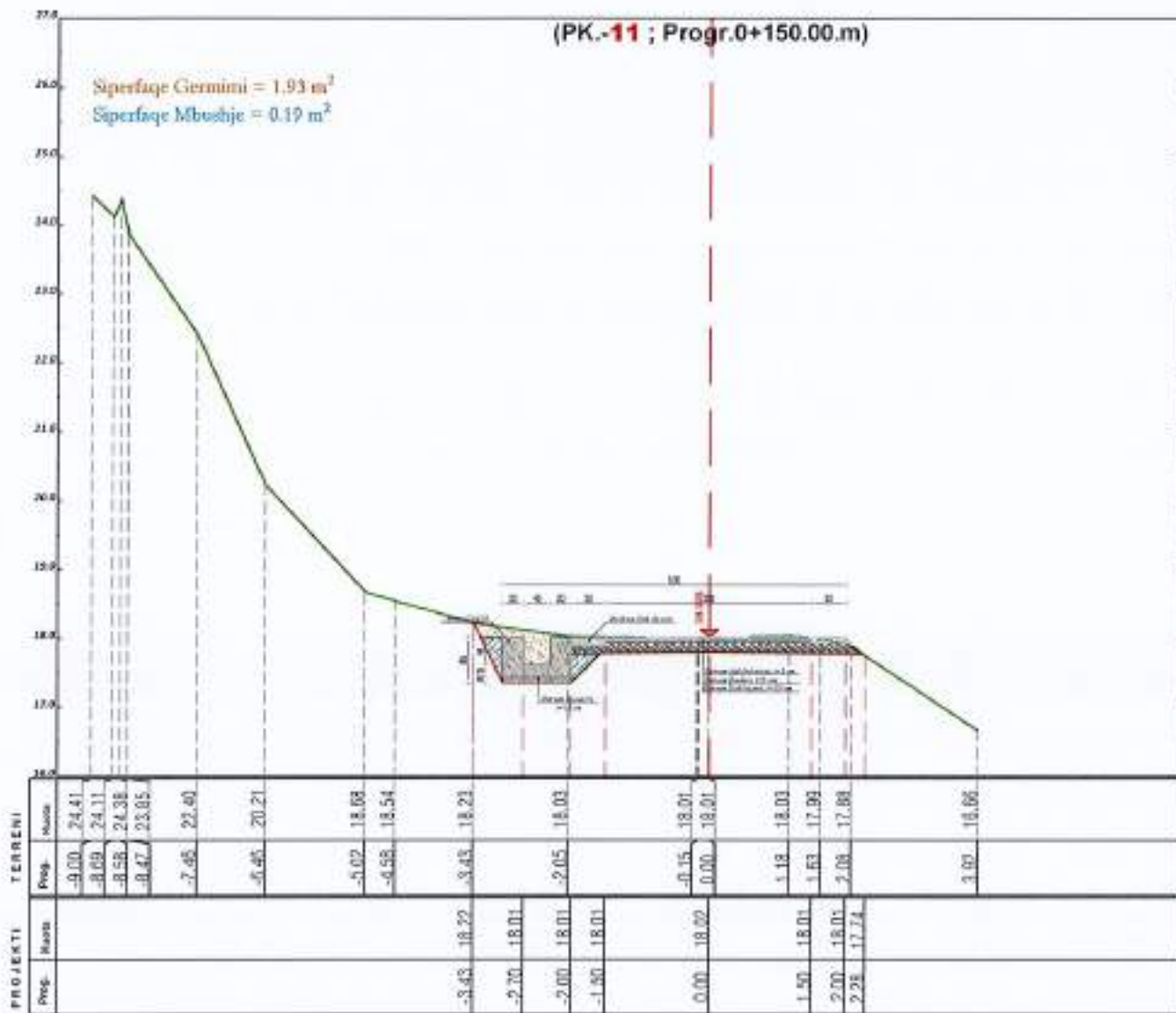

POROSITESI

BASHKIA VAU DEJES



"ANGERBA" shpk

Adresa: Rr. "Irfan Tomini" Tirane,
Cel: 069 20 95 852
E-mail: burhanhafizi@gmail.com

VENDODHJA
Bashkia Vau Dejes

TITULLI PROJEKTI

SISTEMIM ASFALTIM I RRUGES SE MALESOREVE
NJESIA ADMINISTRATIVE BUSHAT

FAZA E PROJEKTIMIT:
PROJEKT ZBATIMI

TITULLI VEZATIMIT

PROFLET TERTHORE
DEGA E DJATHTE

Grupi i Projektimit

Ing. Burhan HAFIZI

Ing. Servet VERÇANI

Ing. Gerti HAFIZI



Skala: 1:100

Data: Mars 2023

TA Nr.8

PROFLET TERTHORE TE DEGES SE DJAThte

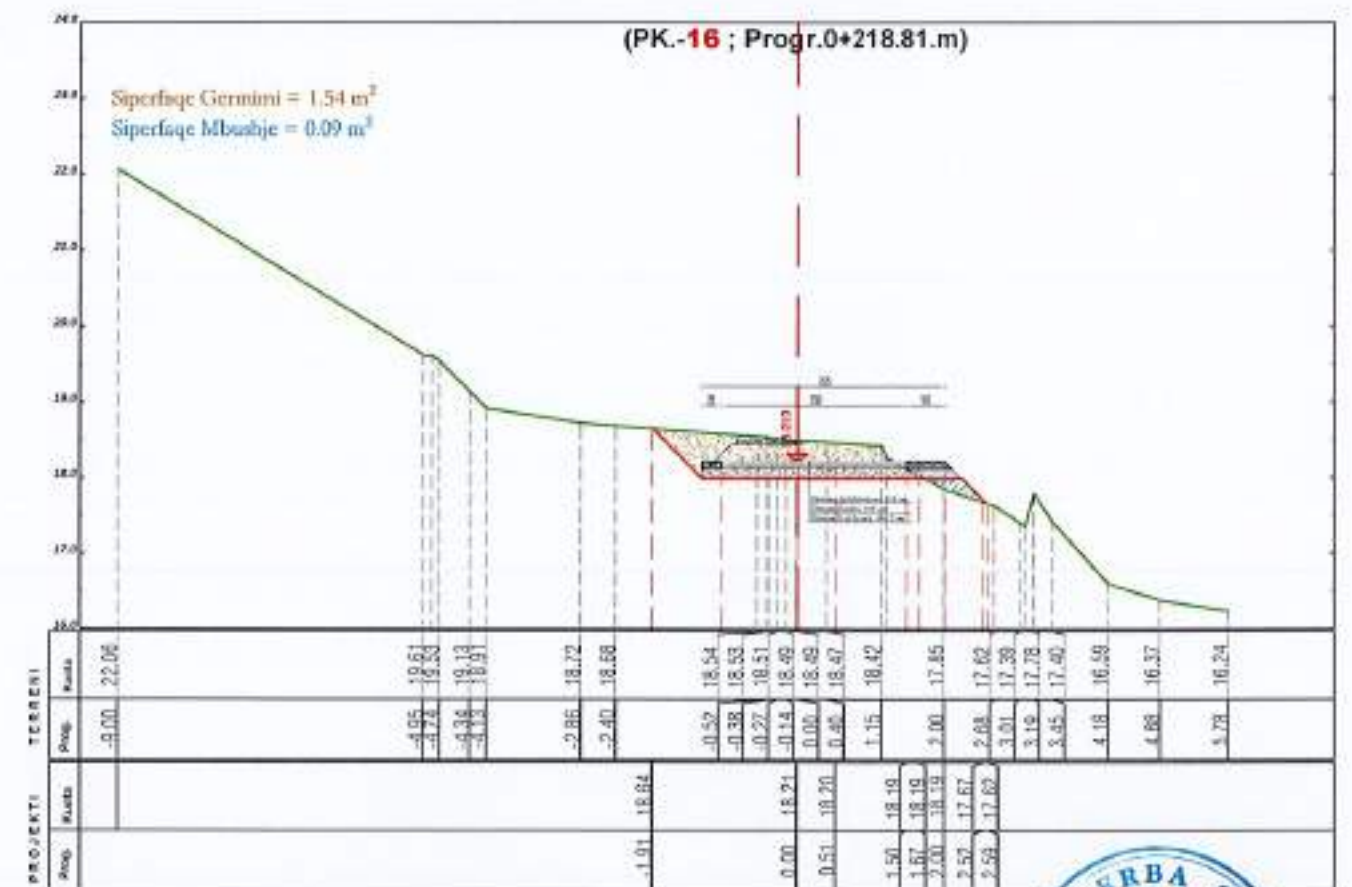
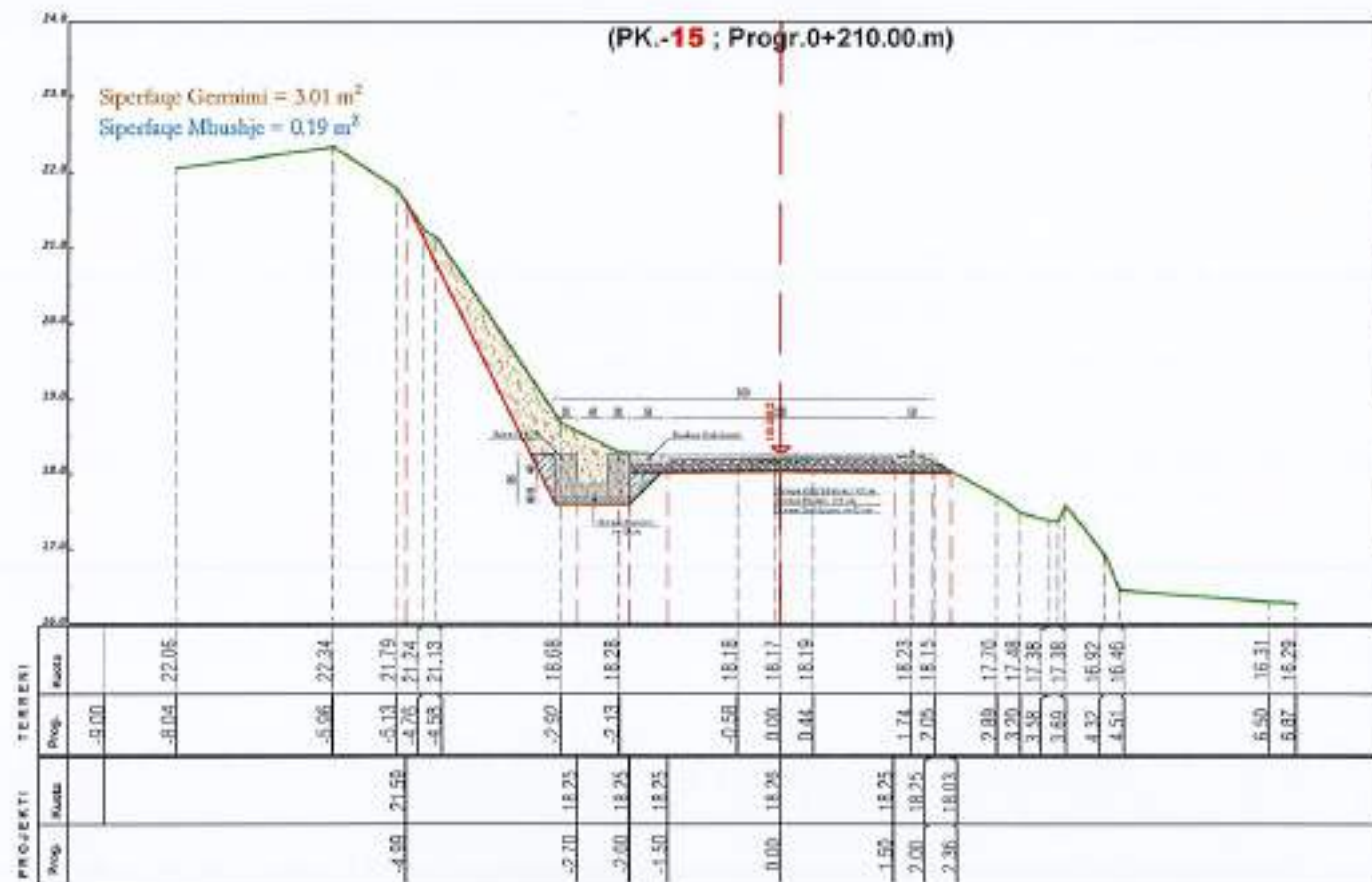
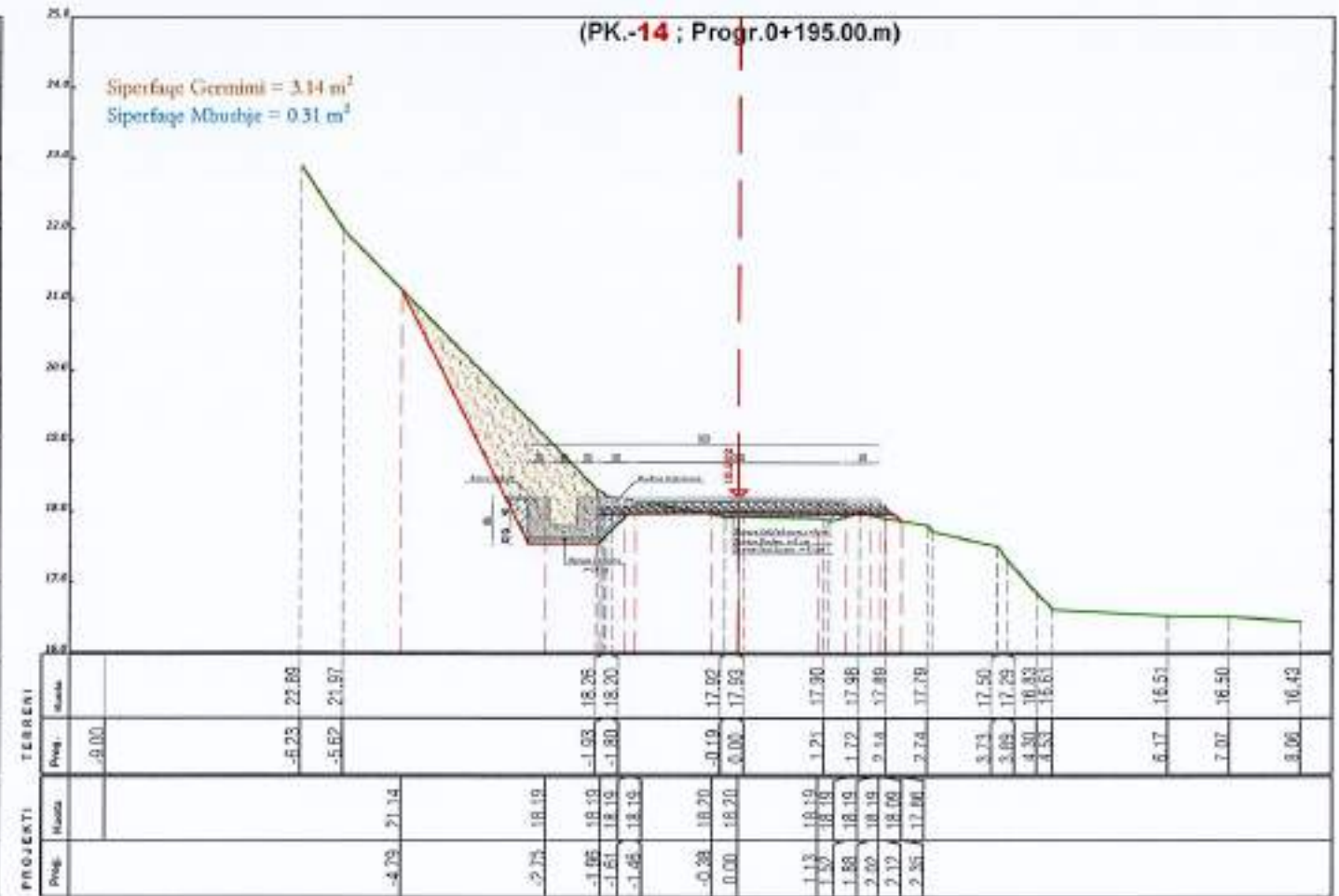
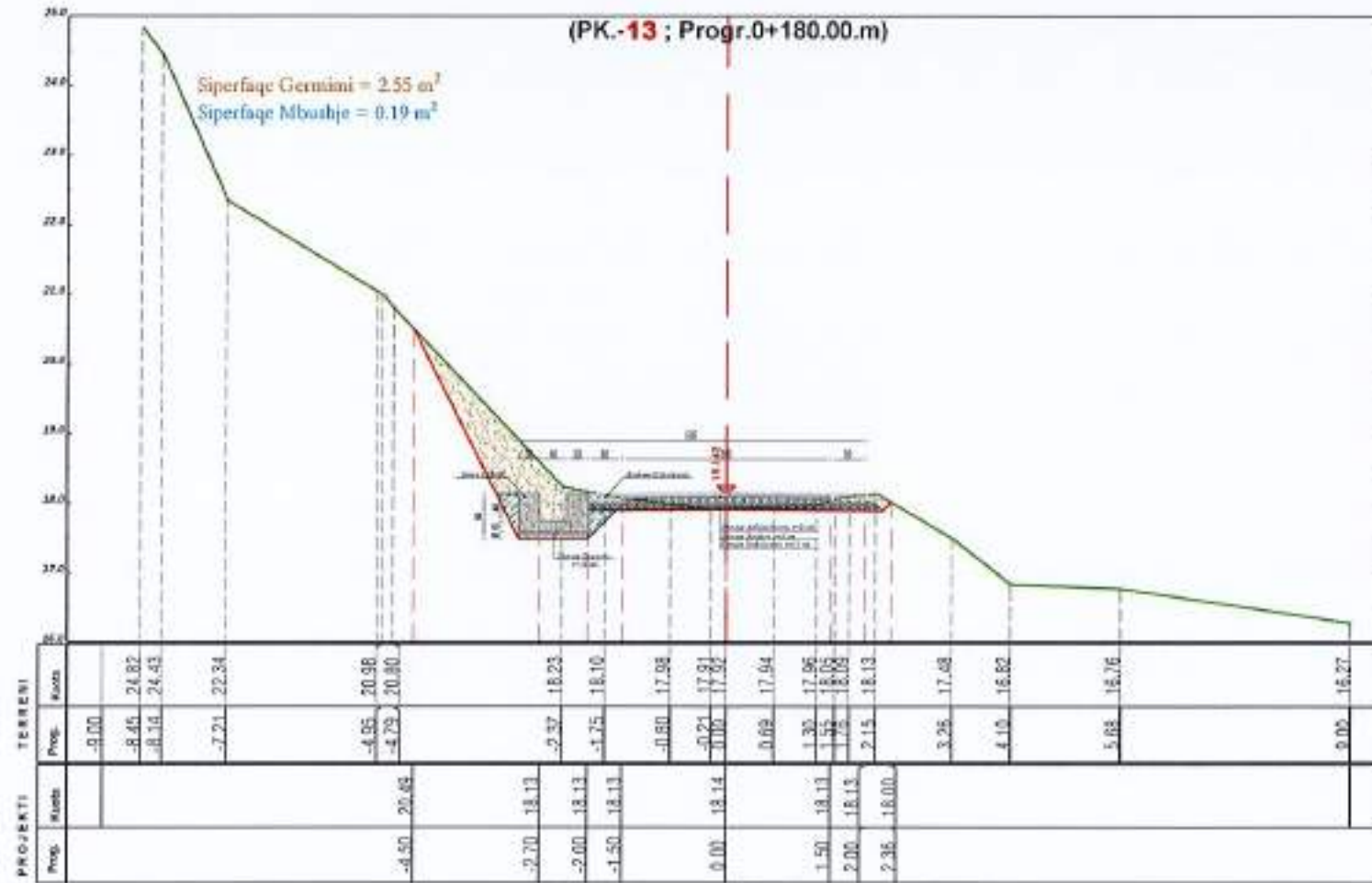

POROSITESI

BASHKIA VAU DEJES



"ANGERBA" shpk

Adresa: Rr. "Irfan Tomini" Tirane.
Cel: 069 20 95 862
E-mail: burhanhafizi@gmail.com

VENDODHJA
Bashkia Vau Dejës

TITULLI I PROJEKTI
SISTEMIM ASFALTIM I RRUGES SE MALESOREVE
NJESIA ADMINISTRATIVE BUSHAT

FAZA E PROJEKTIMIT
PROJEKT ZBATIMI

TITULLI I VEZATIMIT
PROFLET TERTHORE
DEGA E DJAThte

Grupi i Projektimit
Ing. Burhan HAFIZI
Ing. Servet VERÇANI
Ing. Genti HAFIZI

Skala: 1:100
Data: Mars 2023
Fletja Nr.9



PROFILET TERTHORE TE DEGES SE DJATHTE

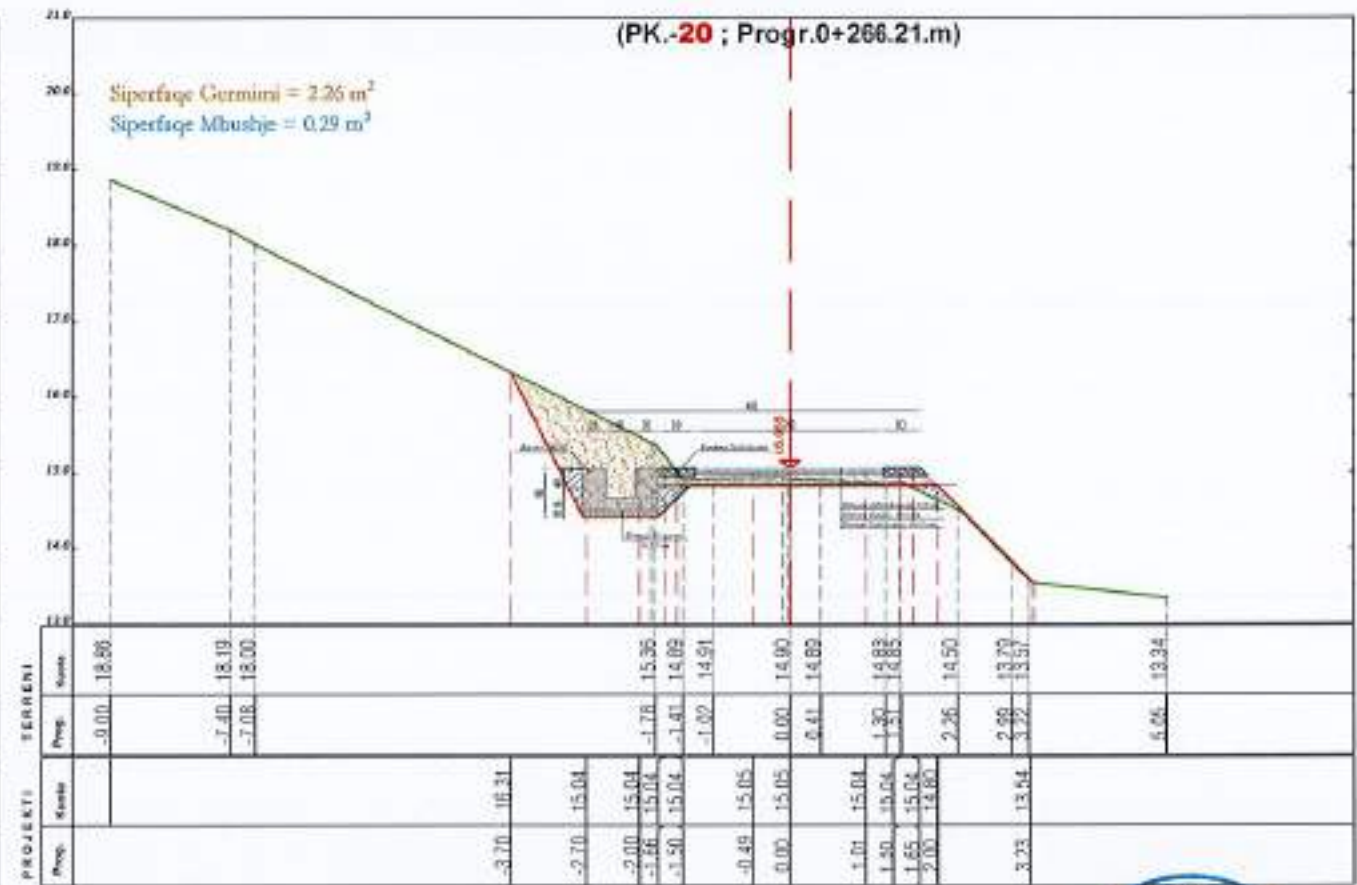
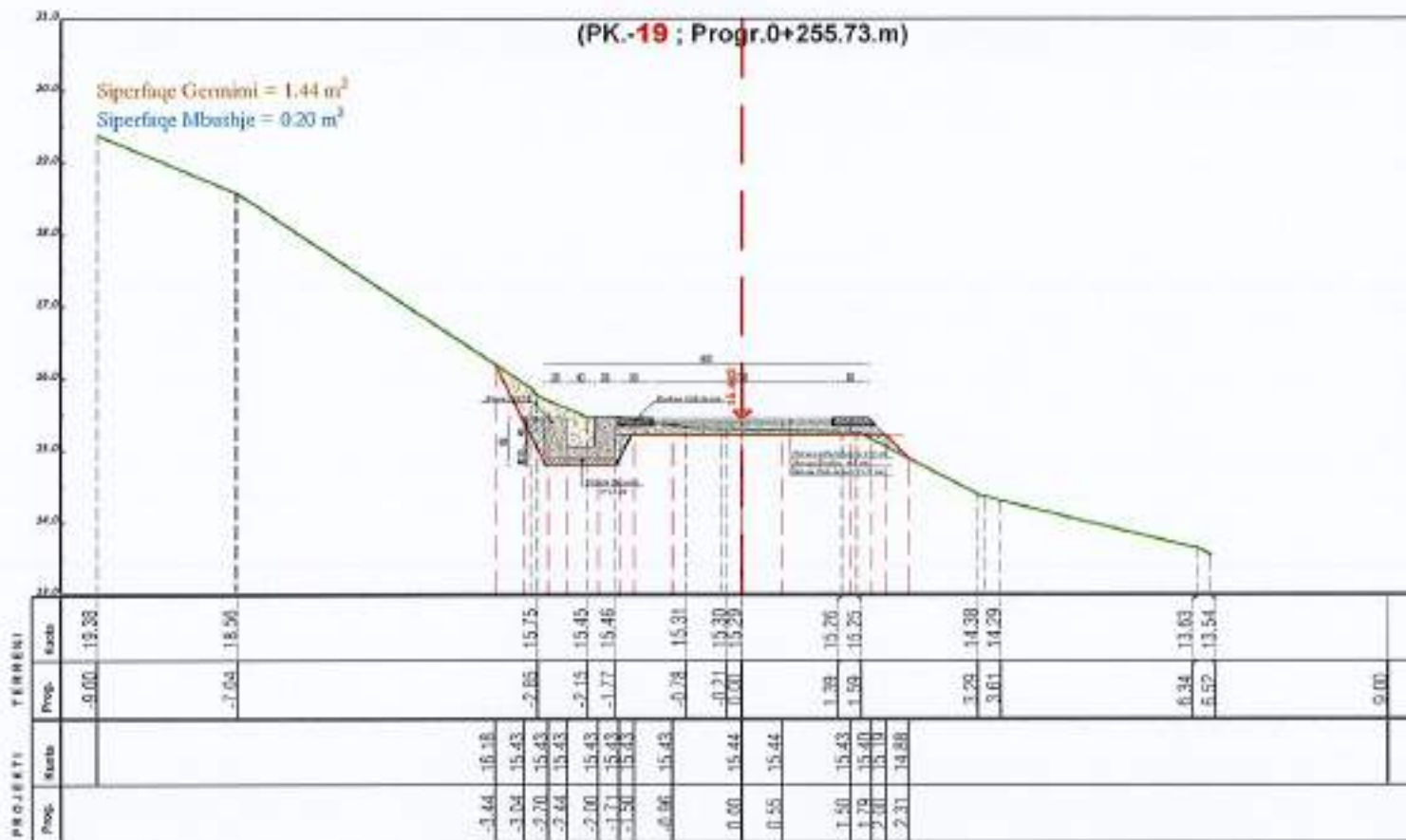
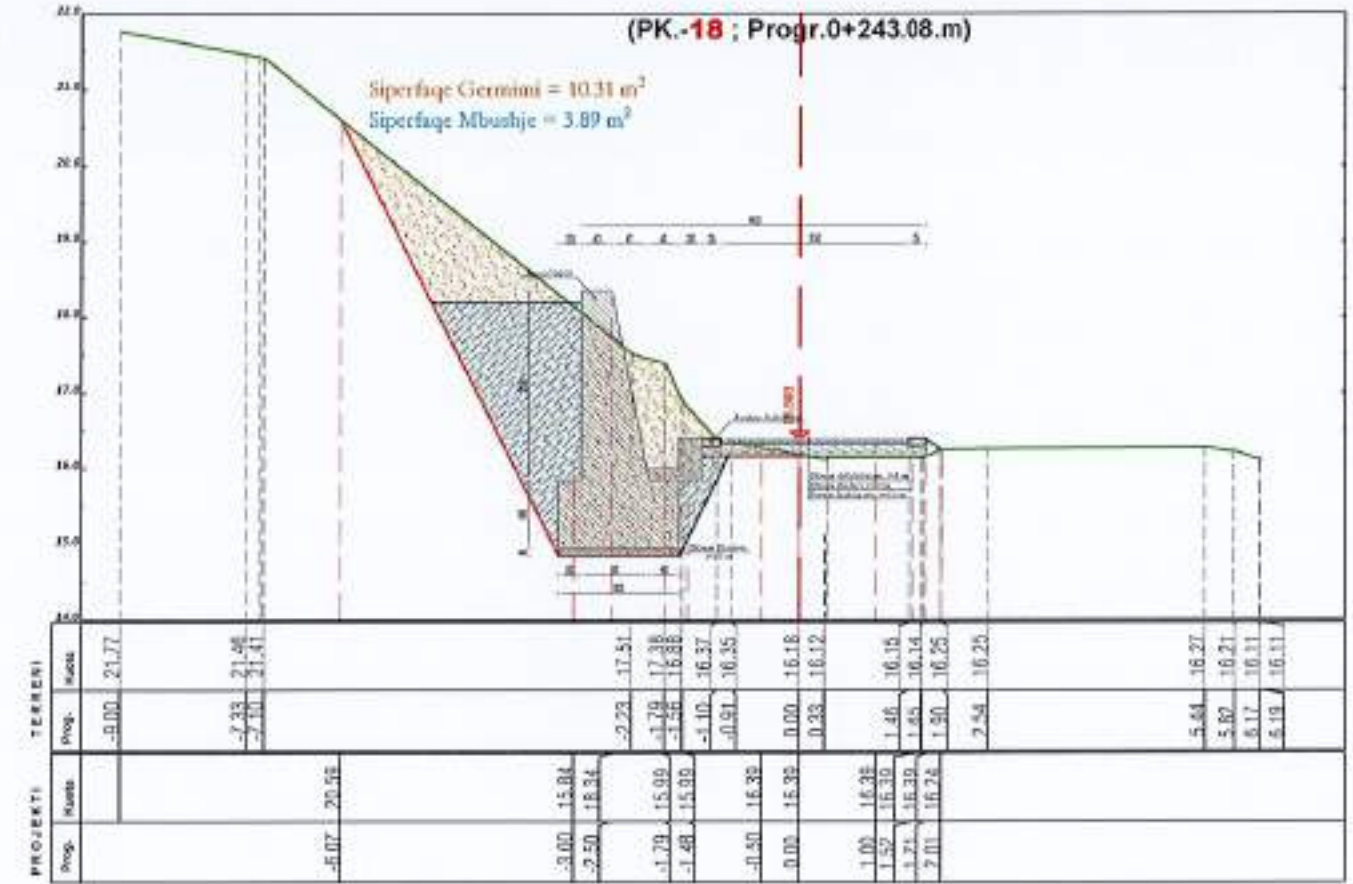
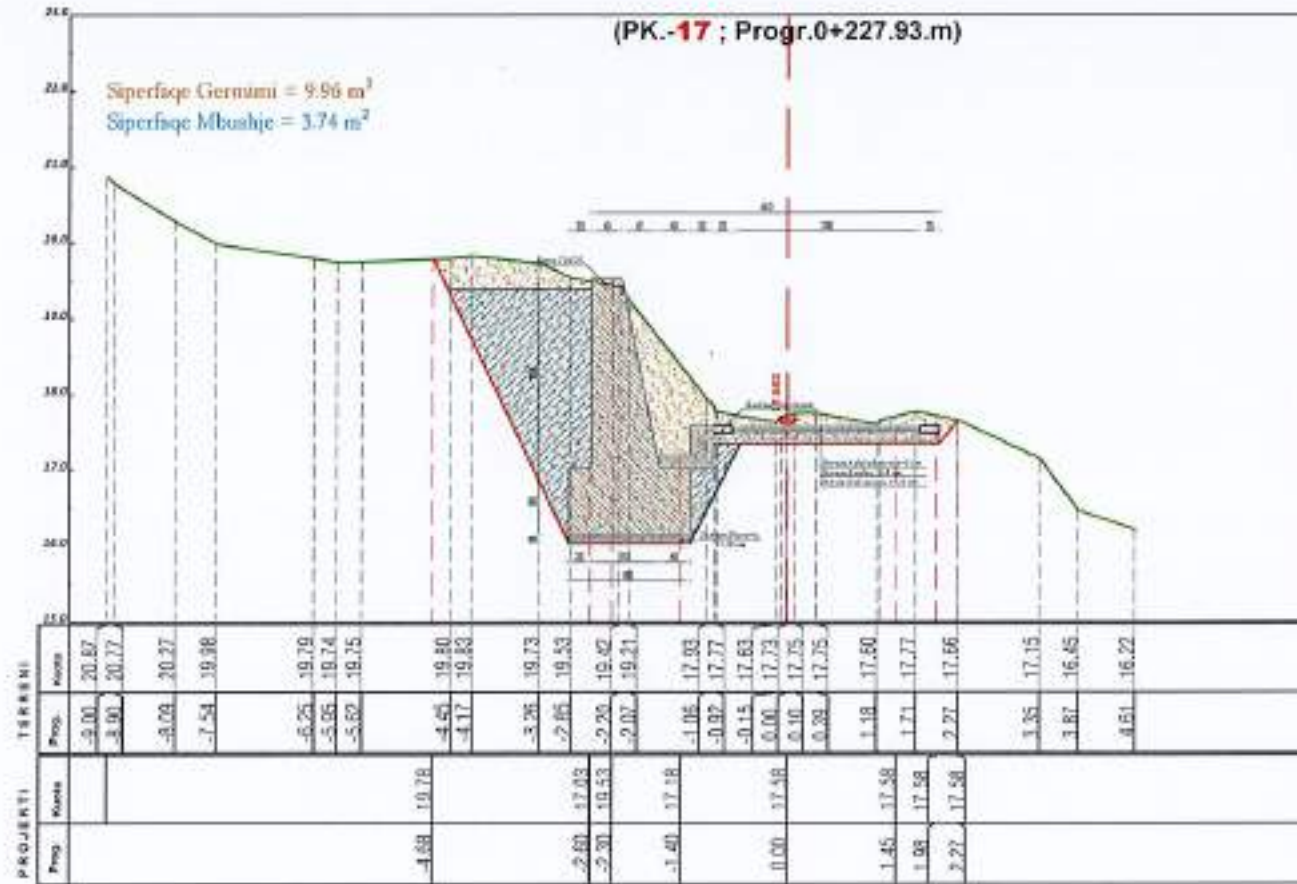

POROSITESI
BASHKIA VAU DEJES



"ANGERBA" shpk
Adresa: Rr. "Irfan Tomini" Tirane.
Cel: 089 20 95 882
E-mail: burhanhafizi@gmail.com

VENDODHESA
Bashkia Vau Dejes
TITULLI I PROJEKTI
SISTEMIM ASFALTIM I RRUGES SE MALESOREVE
NJESIA ADMINISTRATIVE BUSHAT

FAZA E PROJEKTIMIT:
PROJEKT ZBATIMI
TITULLI I VIZATIMIT:
PROFILET TERTHORE
DEGA E DJATHTE

Grupi i Projektimit: 1:100
Ing. Burhan HAFIZI
Ing. Servet VERÇANI
Ing. Gerti HAFIZI
Data: Mars 2023
Fletja Nr.10



PROFILET TERTHORE TE DEGES SE DJATHTE



TABELA E VOLUMEVE RRUGA DJATHTAS

VOLUMET E GERMIMEVE						VOLUMET E MBUSHJEVE					
Nr	Siperfaqe	Siperfaqe Mesatare	D.Pjesore	V.Pjesor	Vol.Progresiv (m³)	Nr	Siperfaqe	Siperfaqe Mesatare	D.Pjesore	V.Pjesor	Vol.Progresiv (m³)
1	1.99					1	0.19				
2	0.79	1.39	15.00	20.85	20.85	2	0.68	0.44	15.00	6.53	6.53
3	2.53	1.66	15.00	24.90	45.75	3	0.19	0.44	15.00	6.53	13.05
4	3.45	2.99	15.00	44.85	90.60	4	0.19	0.19	15.00	2.85	15.90
5	3.70	3.58	15.00	53.63	144.23	5	0.19	0.19	15.00	2.85	18.75
6	1.28	2.49	15.00	37.35	181.58	6	0.22	0.21	15.00	3.08	21.83
7	0.18	0.73	15.00	10.95	192.53	7	0.73	0.48	15.00	7.13	28.95
8	0.02	0.10	15.00	1.50	194.03	8	1.16	0.95	15.00	14.18	43.13
9	0.59	0.31	15.00	4.58	198.60	9	1.22	1.19	15.00	17.85	60.98
10	1.94	1.27	15.00	18.98	217.58	10	0.23	0.73	15.00	10.88	71.85
11	1.93	1.94	15.00	29.03	246.60	11	0.19	0.21	15.00	3.15	75.00
12	2.05	1.99	15.00	29.85	276.45	12	0.19	0.19	15.00	2.85	77.85
13	2.55	2.30	15.00	34.50	310.95	13	0.19	0.19	15.00	2.85	80.70
14	3.14	2.85	15.00	42.68	353.63	14	0.31	0.25	15.00	3.75	84.45
15	3.01	3.08	15.00	46.13	399.75	15	0.19	0.25	15.00	3.75	88.20
16	1.54	2.28	8.81	20.04	419.79	16	0.09	0.14	8.81	1.23	89.43
17	9.96	5.75	9.12	52.44	472.23	17	3.74	1.92	9.12	17.46	106.90
18	10.31	10.14	15.16	153.65	625.88	18	3.89	3.82	15.16	57.84	164.73
19	1.44	5.88	12.64	74.26	700.14	19	0.20	2.05	12.64	25.85	190.58
20	2.26	1.85	10.48	19.39	719.53	20	0.29	0.25	10.48	2.57	193.15
21	3.02	2.64	14.13	37.30	756.83	21	0.30	0.30	14.13	4.17	197.32
		280.34			756.83			280.34			197.32

Volumi Total i Germimit = 757 m³
 Volumi Total i Mbushjes = 197 m³

POROSITESI

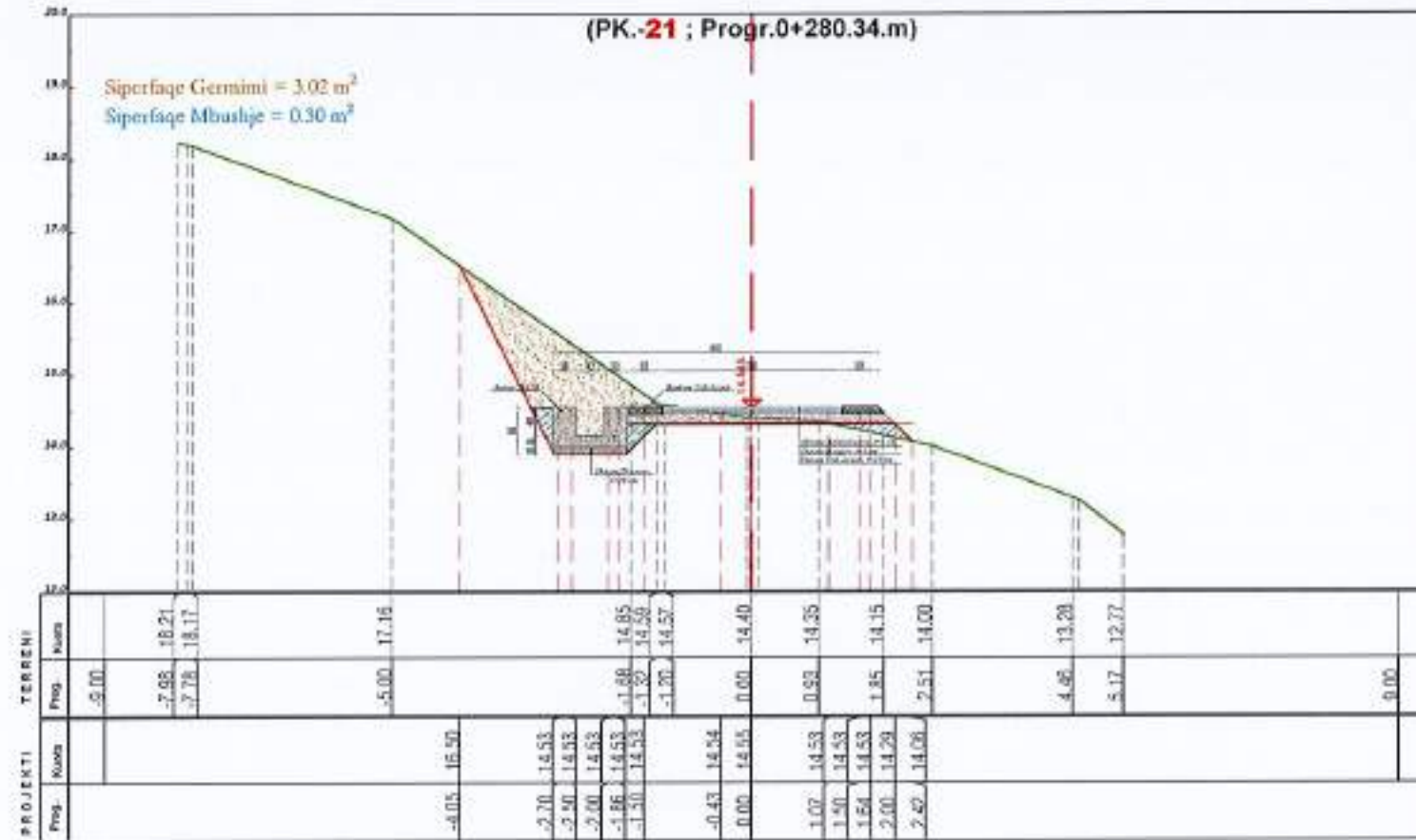
BASHKIA VAU DEJES



"ANGERBA" shpk

Adresa: Rr. "Irfan Tomini" Tirane.
 Cel: 069 20 95 862
 E-mail: burhanhafizi@gmail.com

VENDODHJA
 Bashkia Vau Dejës

TITULLI I PROJEKTI

SISTEMIM ASFALTIM I RRUGES SE MALESOREVE
 NJESIA ADMINISTRATIVE BUSHAT

FAZA E PROJEKTIMIT
 PROJEKT ZBATIMI

TITULLI I VEZATIMIT:

PROFILET TERTHORE
 DEGA E DJATHTE

Grupi i Projektimit
 Ing. Burhan HAFIZI
 Ing. Servet VERÇANI
 Ing. Gerti HAFIZI

Skema Nr. 1
 Dato: Mars 2023
 Fletja Nr. 11



SEKSION TIP , RRUGA E MALESOREVE, DEGA E DJATHTE
PK.16-18, SH. 1:25

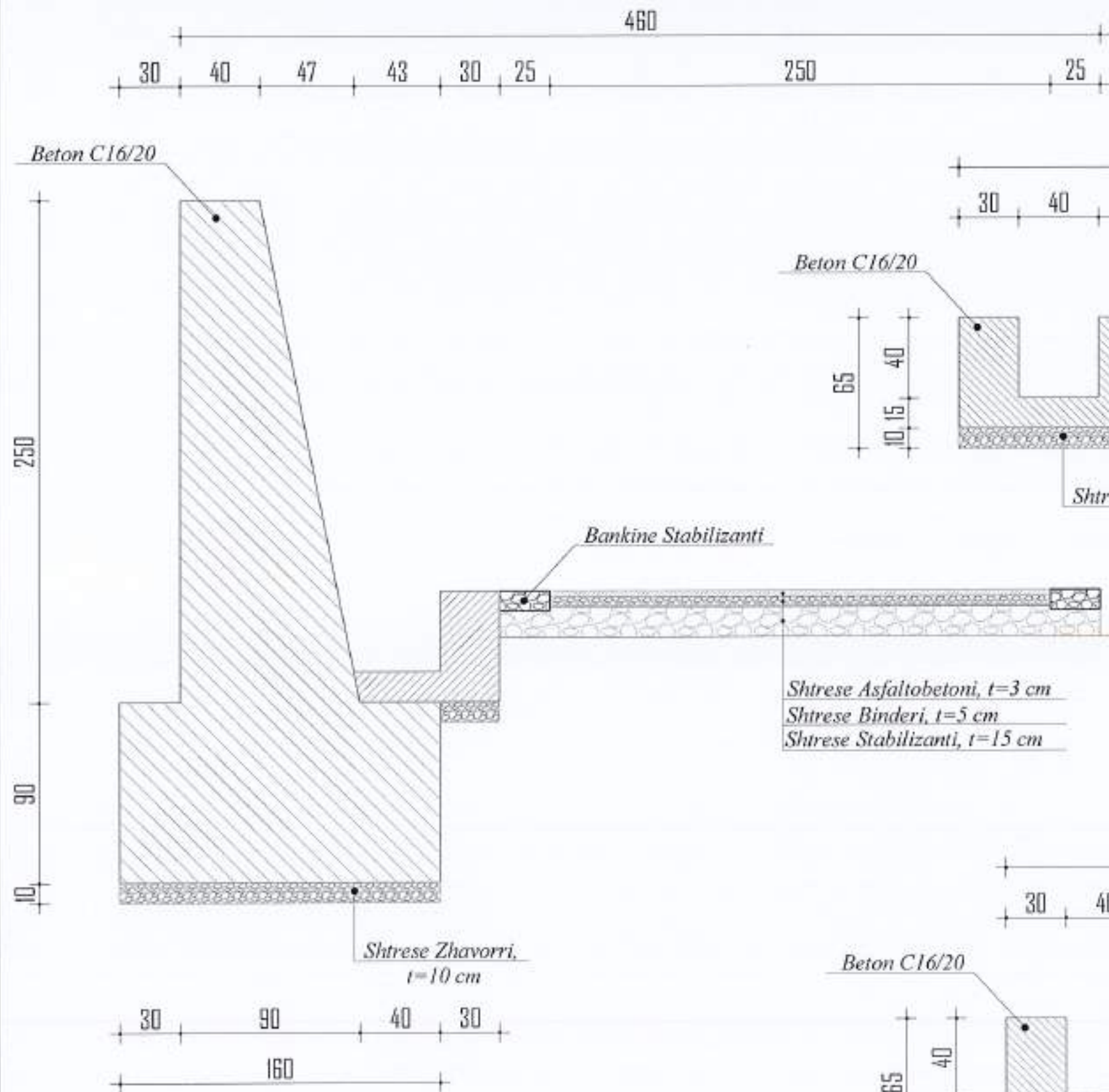

SEKSION TIP ,DEGA E DJATHTE
PK.1-16 , SH. 1:25

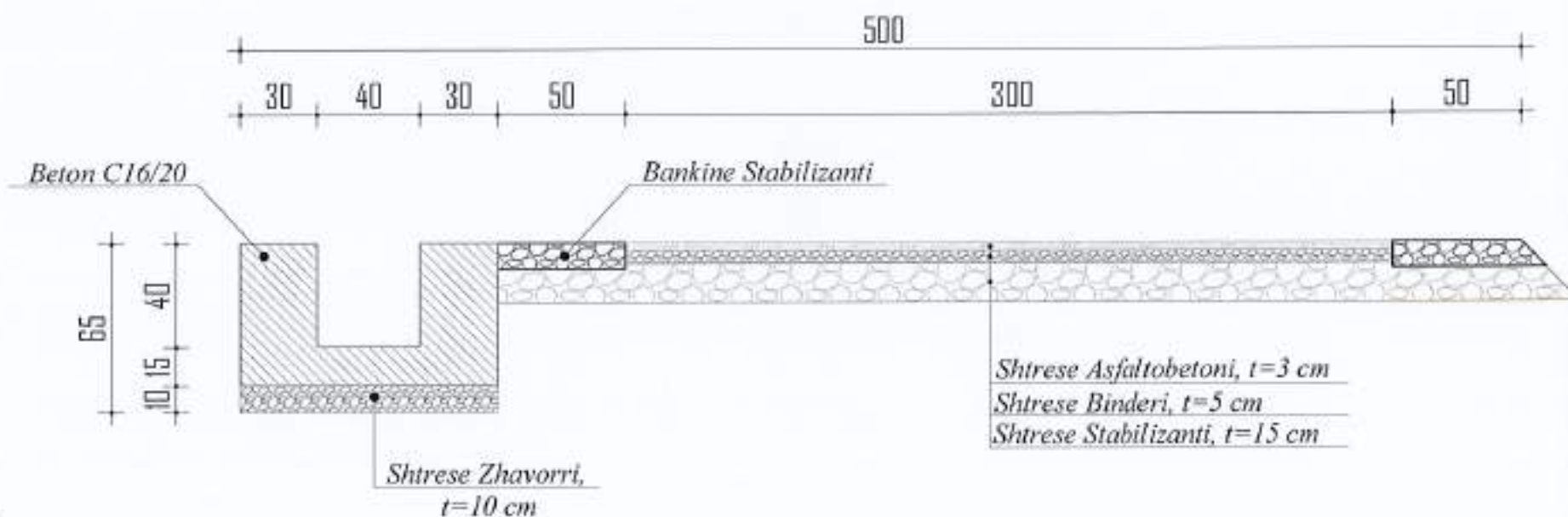

SEKSION TIP ,DEGA E DJATHTE
PK.18-21 , SH. 1:25

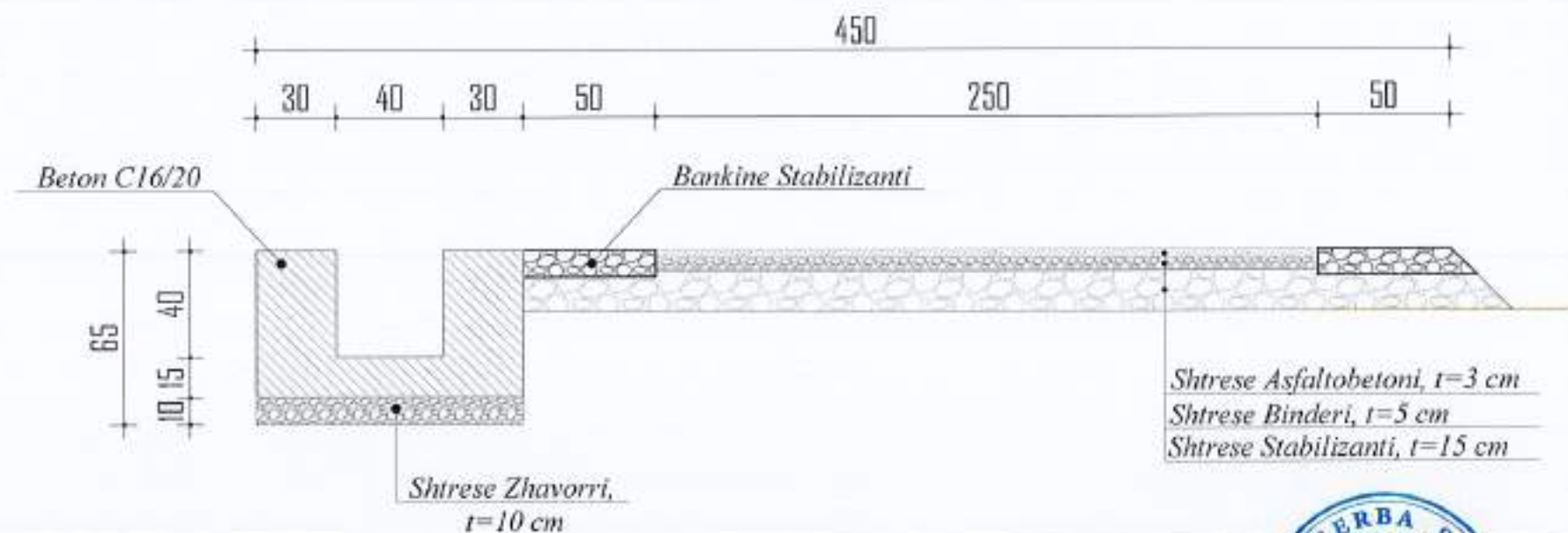

POROSITESI

BASHKIA VAU DEJES



"ANGERBA" shpk

Adresa: Rr. "Irfan Tomini" Tirane.
Cef: 069 29 95 862
E-mail: burhanhafizi@gmail.com

VENDOBRIA
Bashkia Vau Dejes

TITULLI I PROJEKTIT

SISTEMIM ASFALTIM I RRUGES SE MALESOREVE
NJESIA ADMINISTRATIVE BUSHAT

FAZA E PROJEKTIMIT:
PROJEKT ZBATIMI

TITULLI I VEZATIMIT:

SEKSIONE TIP
DEGA E DJATHTE

Grupi i Projektimit

Ing. Burhan HAFIZI
Ing. Servet VERÇANI
Ing. Gerti HAFIZI



Skala: 1:25

Data: Mars 2023

FLET Nr.12

PLANIMETRIA E TOMBINOS
SH. 1:50

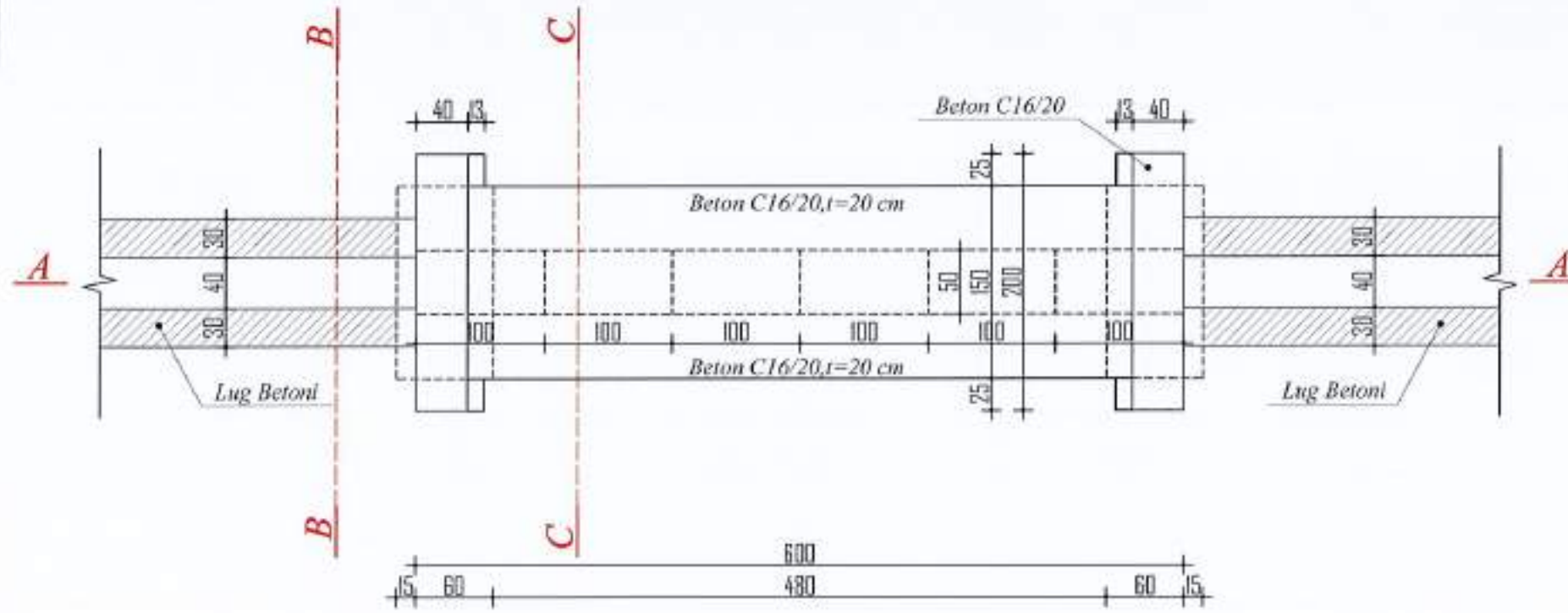

PRERJA B-B
SH. 1:50

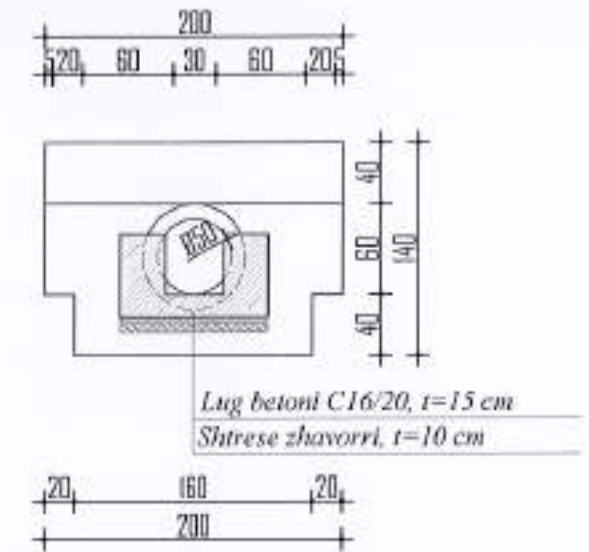

PRERJA C-C
SH. 1:50

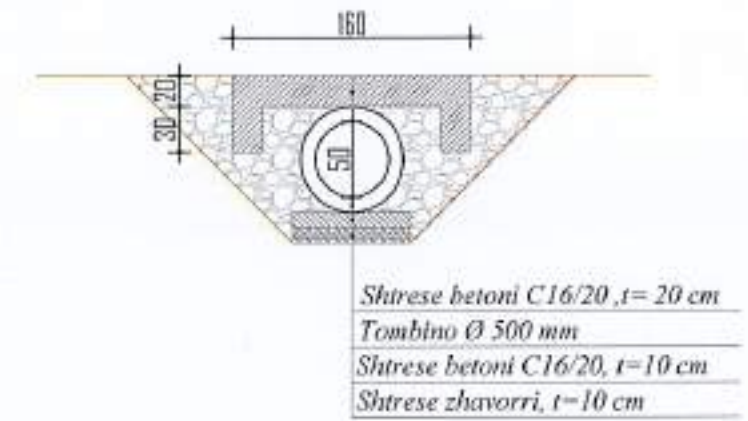

PRERJA A-A
SH. 1:50

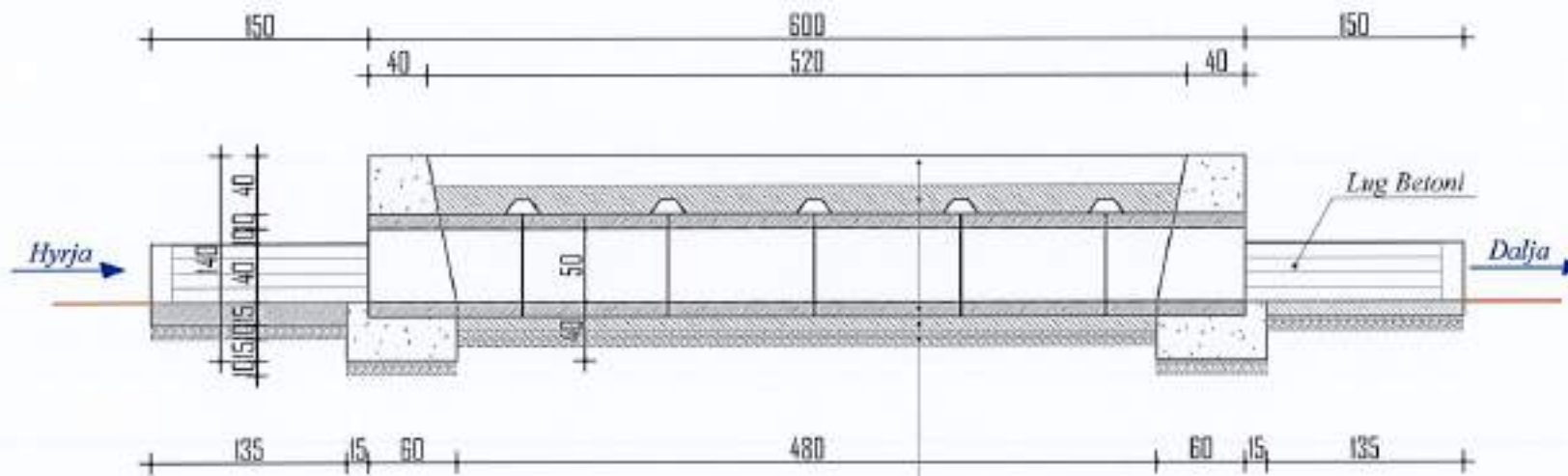

Mbushje per kuote
Shtrese betoni C16/20, t=20 cm
Tombino Ø 500 mm
Shtrese betoni C16/20, t=10 cm
Shtrese zhavorri, t=10 cm

TABELA E VOLUMEVE

Nr.	EMERTIMI I PUNIMIT	NJESIA	SASIA
1	Germim dheu ekskavalor per vepren	m ²	16.0
2	Nenshtrese zhavorri t= 10 cm	m ²	2.0
3	Beton C 16/20 per mure	m ³	2.8
4	Beton C 16/20 per shtrese mbi tuba.t= 20 cm	m ³	1.5
5	F.V. tub betoni Ø 500 mbi shtrese betoni	m	5.0
6	Mbushje me zhavorr	m ³	4.0

POROSITESI

BASHKIA VAU DEJES



"ANGERBA" shpk

Adresa: Rr. "Irfan Tomini" Tirane.
Cel: 069 20 95 862
E-mail: burhanhafizi@gmail.com

VENDODHJA
Bashkia Van Dejes

TITULLI I PROJEKTT

SISTEMIM ASFALTIM I RRUGES SE MALESOREVE
NJESIA ADMINISTRATIVE BUSHAT

FAZA E PROJEKTIMIT :

PROJEKT ZBATIMI

TITULLI VIZATIMIT :

TOMBINO Ø500 MM, L=6 M
PLAN, PRERJE

Grupi i Projektimit

Ing. Burhan HAFIZI
Ing. Servet VERÇANI
Ing. Gerti HAFIZI



Shkala: 1:50

Data: Mars 2023

FLETË Nr.13

DEGA E MAJTE



PLANIMETRIA E DEGES SE MAJTE



- Legjende**
- Asfalt Ekzistues
 - Rruge Ekzistuese
 - Gardhe Ekzistues
 - Mure Rrethues Ekzistues
 - Rruge ne Projekt
 - Mure ne Projekt
 - Kanal Anesor ne Projekt
 - Lug Betoni ne Projekt

Ndertohtet Mur Mbojtes Djathtas

Fundim i Deges se Maje

Fundi i Rruges Kryesore ne Projekt

Rruge ne Projekt

Ndertohtet Tambino Ø600, L=15ml (Shiko Fleten perkatese)

Pk.17-18 Ndertohtet Mure Mbojtes Djathtas

POROSITESI
BASHKIA VAU DEJES



"ANGERBA" shpk
Adresa: Rr. "Irfan Tomini" Tirane.
Cel: 069 20 95 662
E-mail: burhanhafizi@gmail.com

VENDODRUA
Bashkia Vau Dejes

TITULLI I PROJEKTI
**SISTEMIM ASFALTIM I RRUGES SE MALESOREVE
NJESIA ADMINISTRATIVE BUSHAT**

FAZA E PROJEKTIMIT:
PROJEKT ZBATIMI

TITULLI I VEZATIMIT:
**PLANIMETRIA E DEGES SE MAJTE
PK.1-6**

Grupi i Projektimit
Ing. Burhan HAFIZI
Ing. Servet VERÇANI
Ing. Gerti HAFIZI

Shkalla: 1:250
Data: Mars 2023
FLET Nr.1



PLANIMETRIA E DEGES SE MAJTE

Legjende

-  Asfalt Ekzistues
-  Rruge Ekzistuese
-  Gardhe Ekzistues
-  Mure Rrethues Ekzistues
-  Rruge ne Projekt
-  Mure ne Projekt
-  Kanal Anesor ne Projekt
-  Lug Betoni ne Projekt



POROSITESI
BASHKIA VAU DEJES

"ANGERBA" shpk
Adresa: Rr. "Irfan Tomini" Tirane.
Cel: 069 20 95 862
E-mail: burhanhafizi@gmail.com

VENDODHJA
Bashkia Vau Dejes
TITULLI I PROJEKTI
SISTEMIM ASFALTIM I RRUGES SE MALESOREVE
NJESIA ADMINISTRATIVE BUSHAT

FAZA E PROJEKTIMIT:
PROJEKT ZBATIMI
TITULLI I VIZATIMIT:
PLANIMETRIA E DEGES SE MAJTE
PK.6-12

Grupi i Projektimit
Ing. Burhan HAFIZI
Ing. Servet VERÇANI
Ing. Gerti HAFIZI
Shkalla: 1:250
Data: Mars 2023
FLET Nr.2



PROFILI GJATESOR I DEGES SE MAJTE
SH 1:200 ; 1:1000

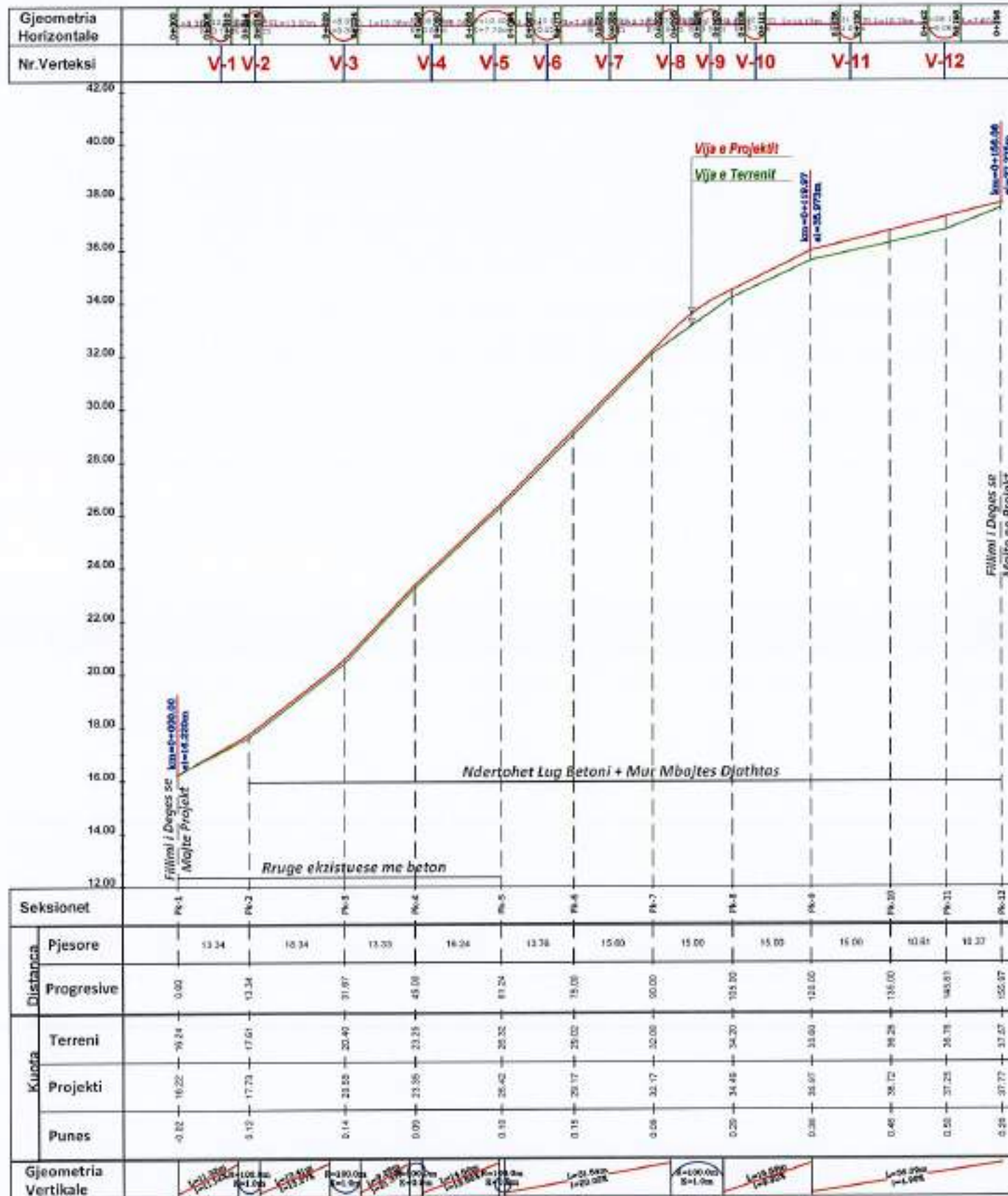

POROSITESI
BASHKIA VAU DEJES



"ANGERBA" shpk
Adresa: Rr. "Irfan Tomini" Tirane.
Cel: 069 20 95 862
E-mail: burhanhafizi@gmail.com

VENDOSHA
Bashkia Vau Dejes
TITULLI I PROJEKTIT
**SISTEMIM ASFALTIM I RRUGES SE MALESOREVE
NJESIA ADMINISTRATIVE BUSHAT**

FAZA E PROJEKTIMIT:
PROJEKT ZBATIMI
TITULLI I VIZATIMIT:
**PROFILI GJATESOR I DEGES SE
MAJTE**

Grupi i Projektimit
Ing. Burhan HAFIZI
Ing. Servet VERÇANI
Ing. Gerti HAFIZI
Shkalla: 1:200; 1:1000
Data: Mars 2023
FLETA Nr.3



PROFLET TERTHORE TE DEGES SE MAJTE

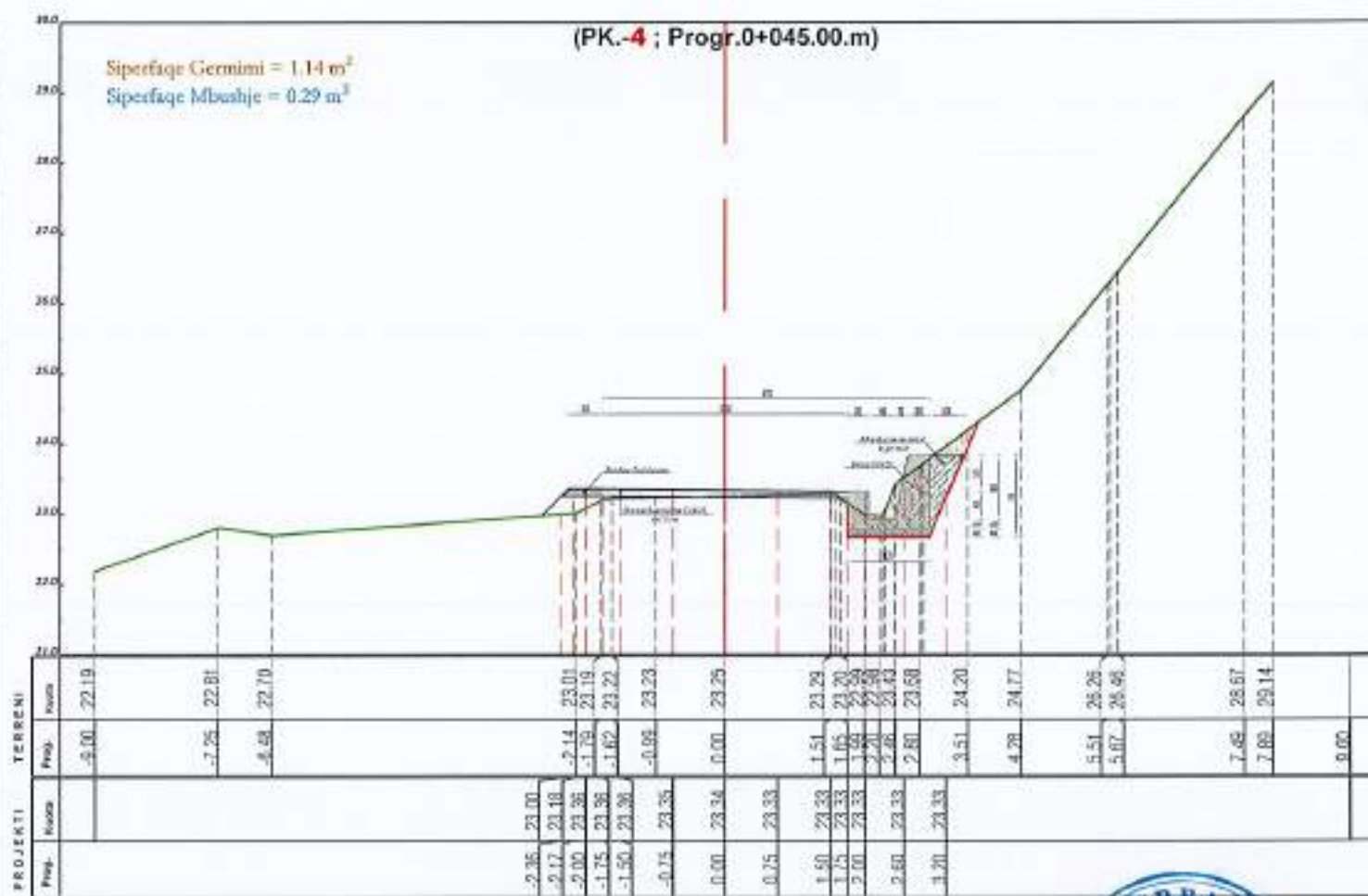
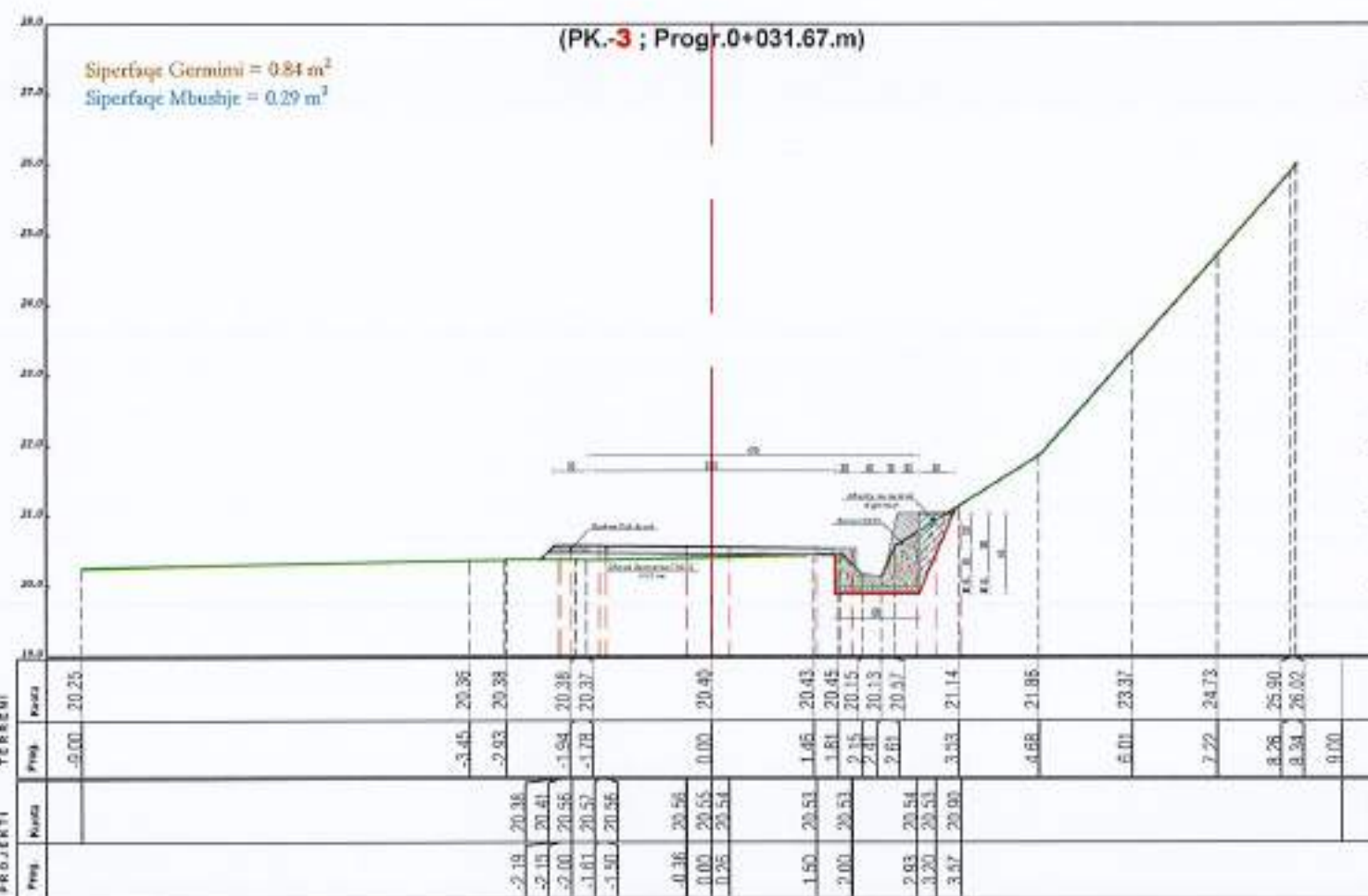
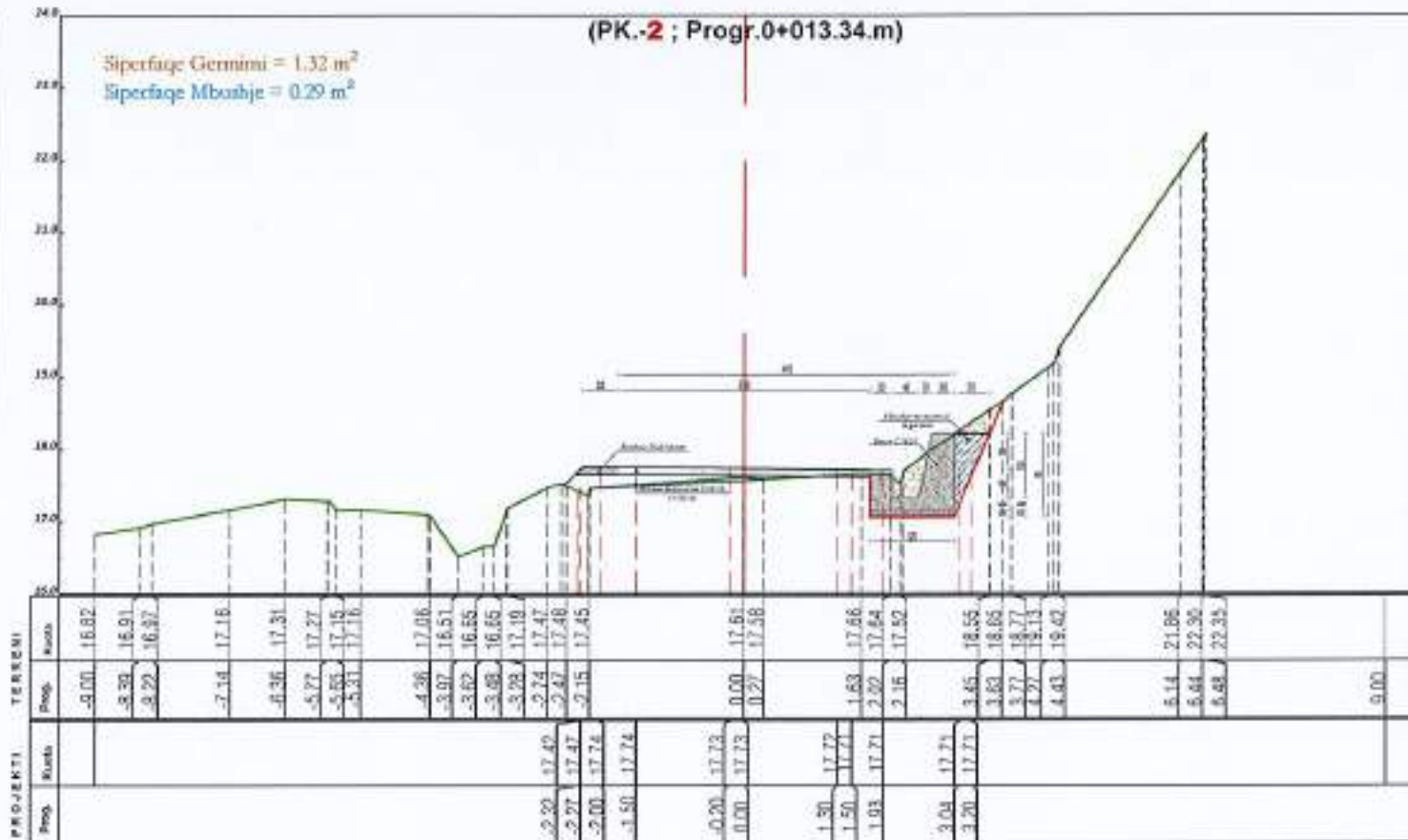
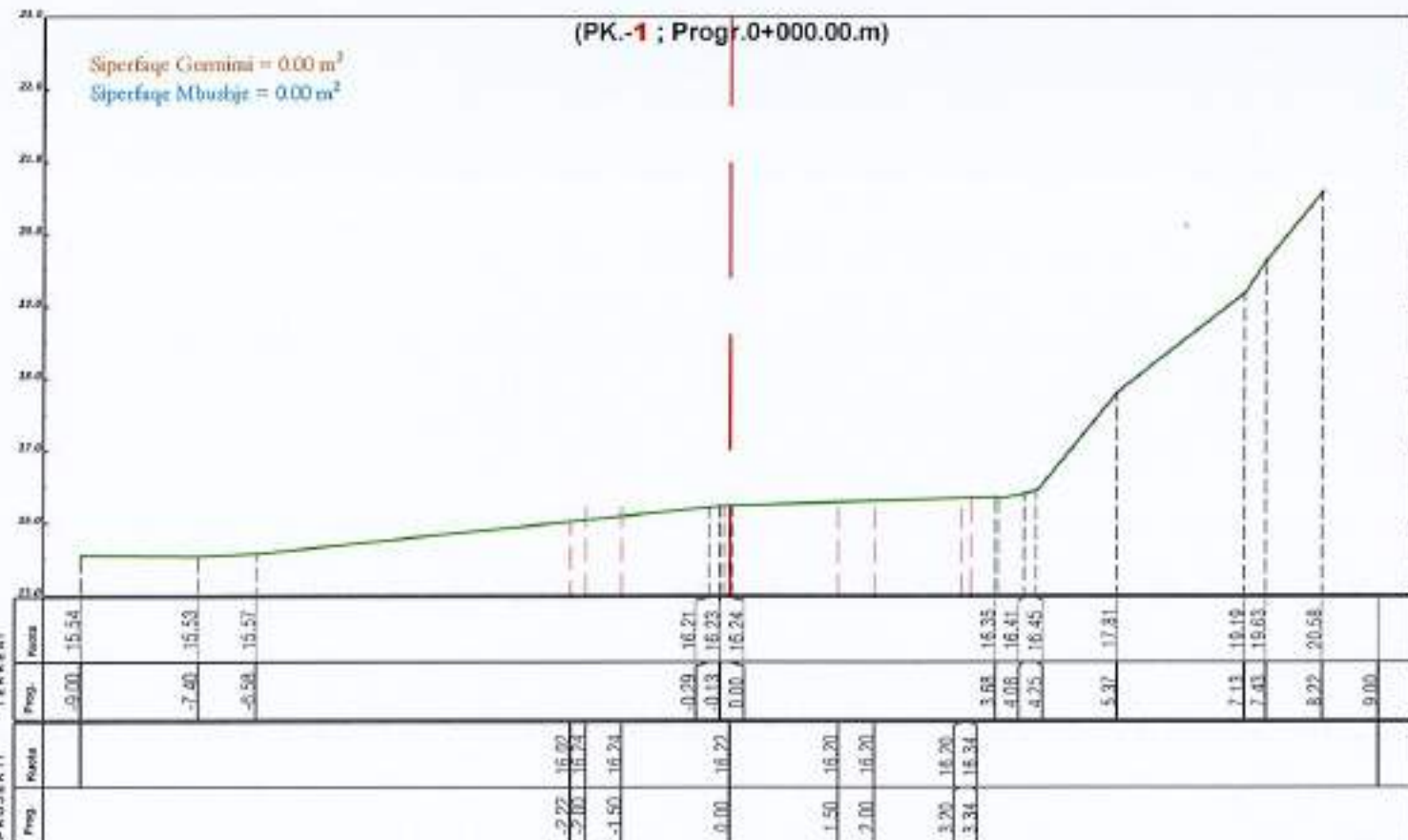

POROSITESI
BASHKIA VAU DEJES



"ANGERBA" shpk
Adresa: Rr. "Irfan Tomini" Tirane.
Cel: 069 20 95 862
E-mail: burhanhafizi@gmail.com

VENDODHJA
Bashkia Vau Dejes
TITULLI I PROJEKTIT
SISTEMIM ASFALTIM I RRUGES SE MALESOREVE
NJESIA ADMINISTRATIVE BUSHAT

FAZA E PROJEKTIMIT
PROJEKT ZBATIMI
TITULLI I VIZATIMIT
PROFLET TERTHORE
DEGA E MAJTE

Grupi i Projektimit
Ing. Burhan HAFIZI
Ing. Servet VERÇANI
Ing. Gerti HAFIZI
Shkalla 1:100
Data: Mars 2023
Fletja Nr.4



PROFLET TERTHORE TE DEGES SE MAJTE

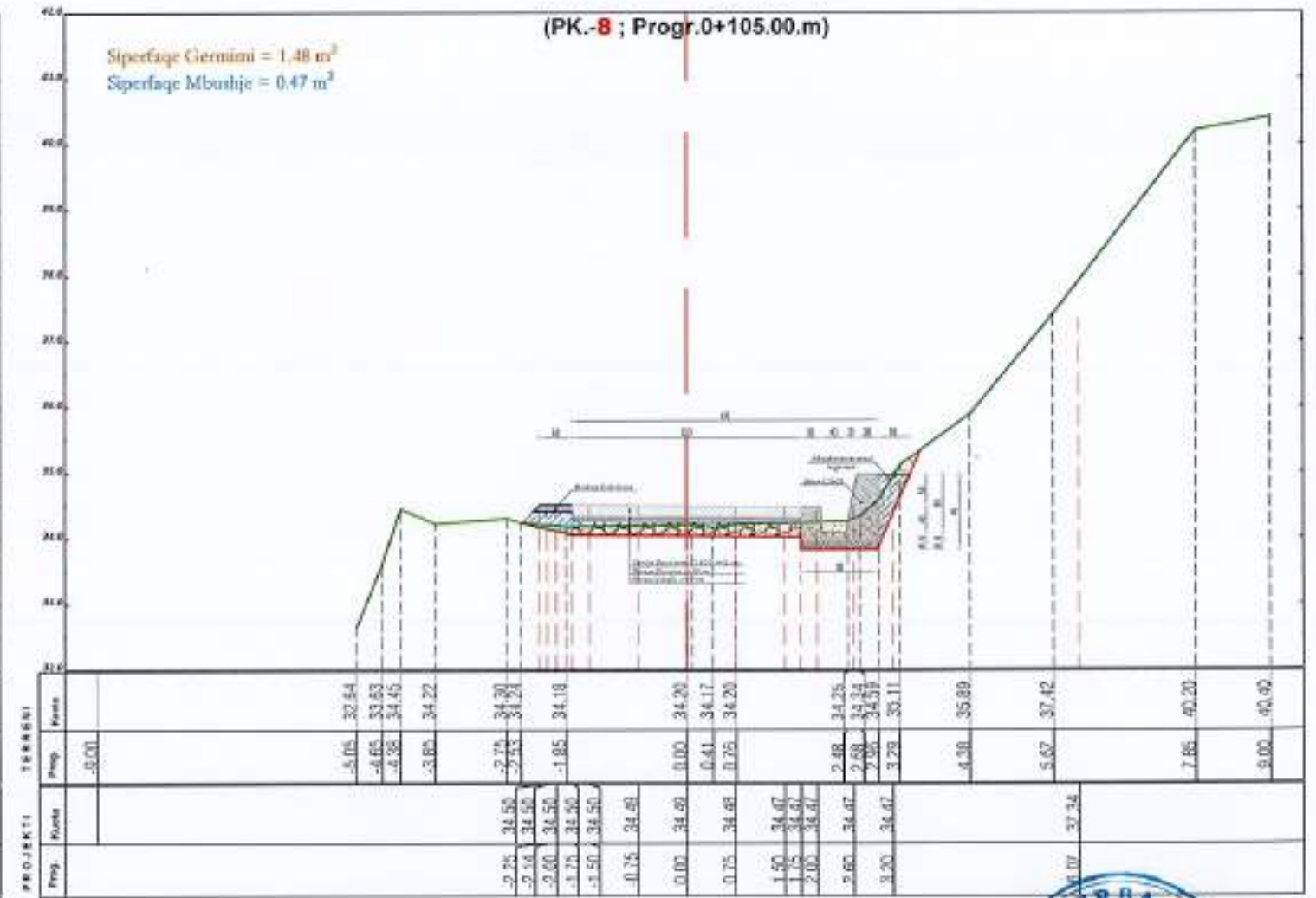
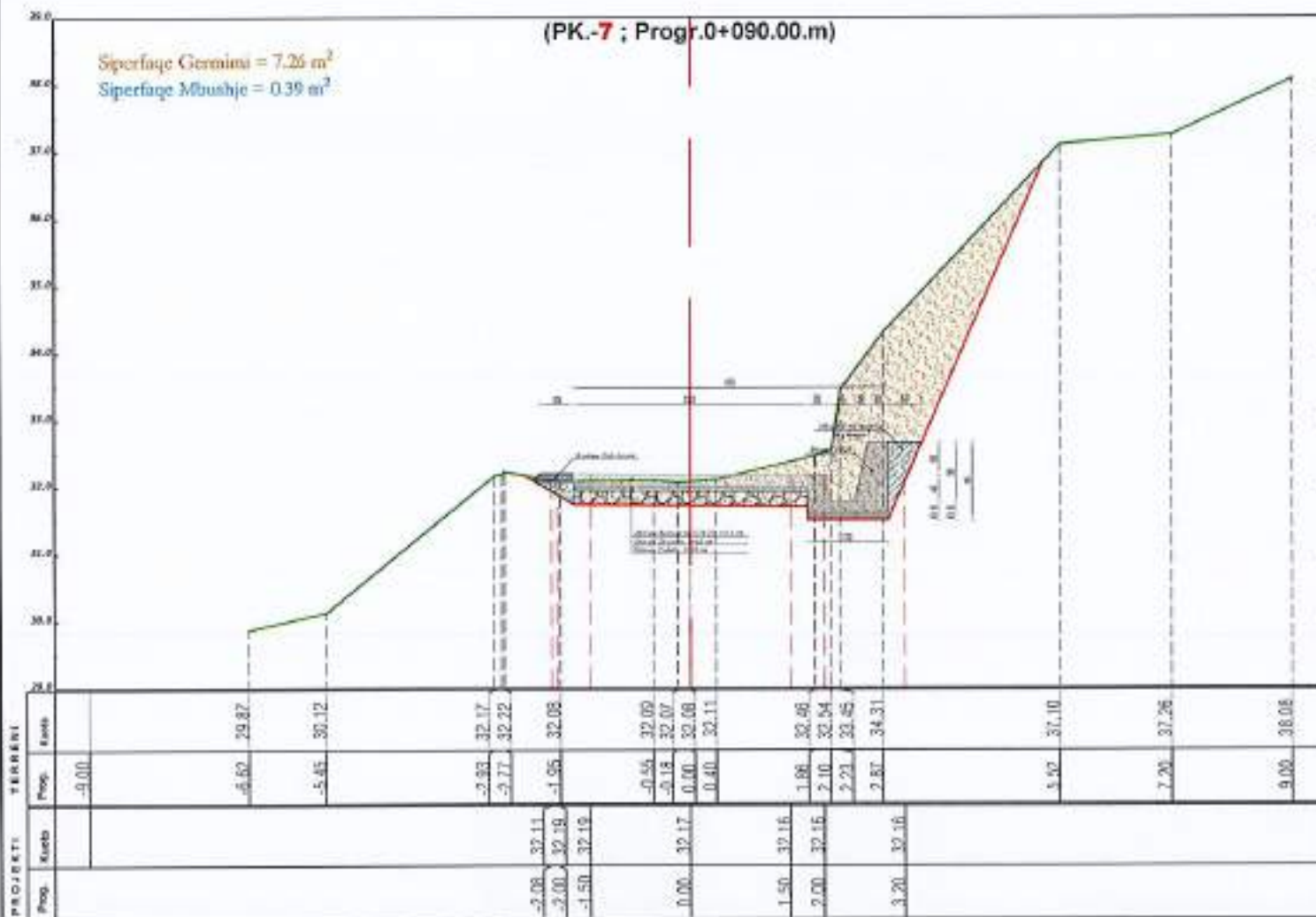
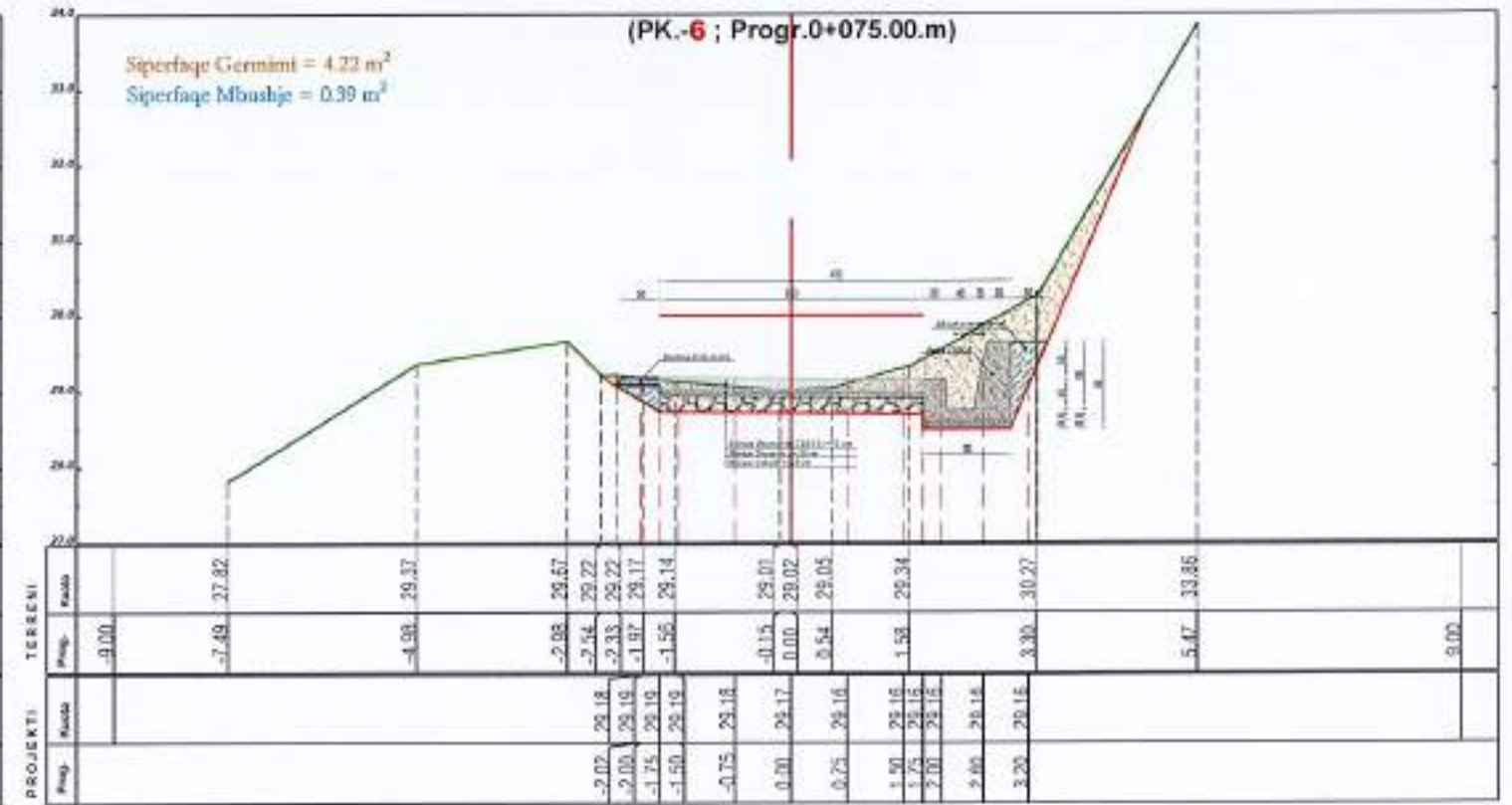
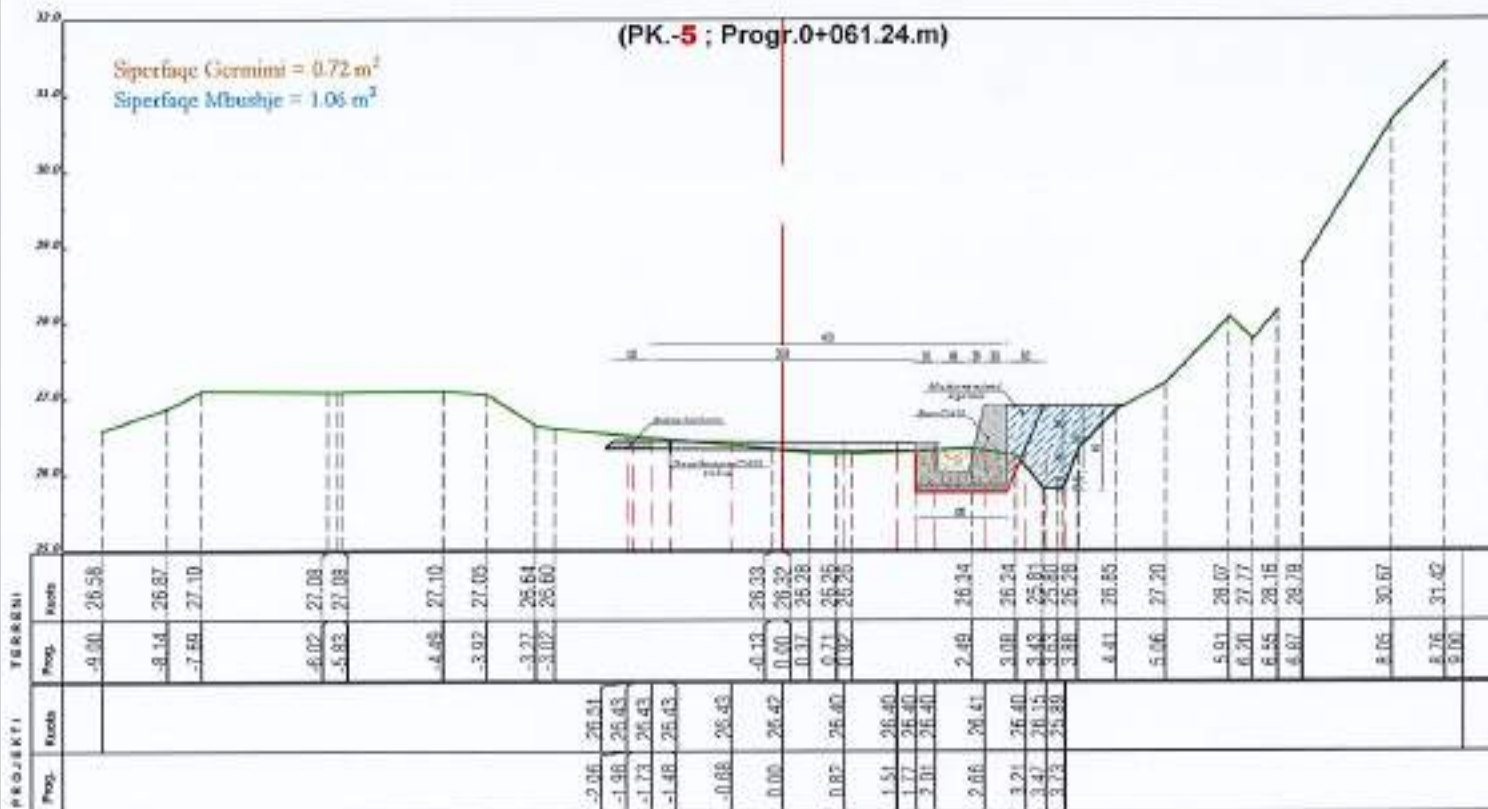

POROSITESI
BASHKIA VAU DEJES



"ANGERBA" shpk
Adresa: Rr. "Yrfan Tomini" Tirane.
Cel: 069 20 95 862
E-mail: burhanhafizi@gmail.com

VENDODHJA
Bashkia Vau Dejes
TITULLI I PROJEKTTIT
**SISTEMIM ASFALTIM I RRUGES SE MALESOREVE
NJESIA ADMINISTRATIVE BUSHAT**

FAZA E PROJEKTTIMIT:
PROJEKT ZBATIMI
TITULLI I VIZATIMIT:
**PROFLET TERTHORE
DEGA E MAJTE**

Grupi i Projektimit
Ing. Burhan HAFIZI
Ing. Servet VERÇANI
Ing. Gerti HAFIZI
1:100
Data: Mars 2023
FLET Nr.5



PROFLET TERTHORE TE DEGES SE MAJTE

(PK.-9 ; Progr.0+120.00.m)

Siperfaqe Gjermimi = 1.95 m²
Siperfaqe Mbushtje = 0.52 m²

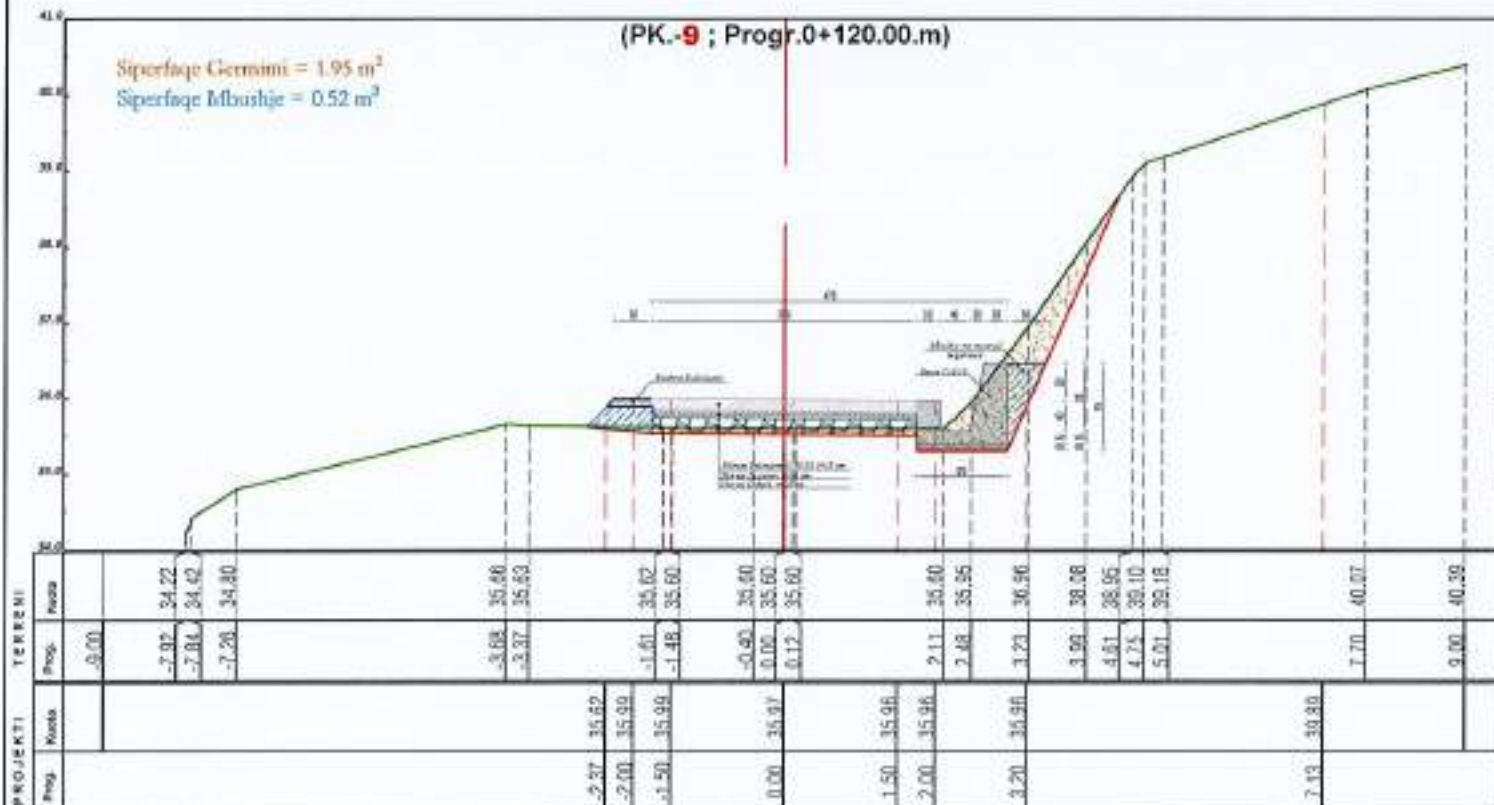

(PK.-10 ; Progr.0+135.00.m)

Siperfaqe Gjermimi = 1.55 m²
Siperfaqe Mbushtje = 0.53 m²

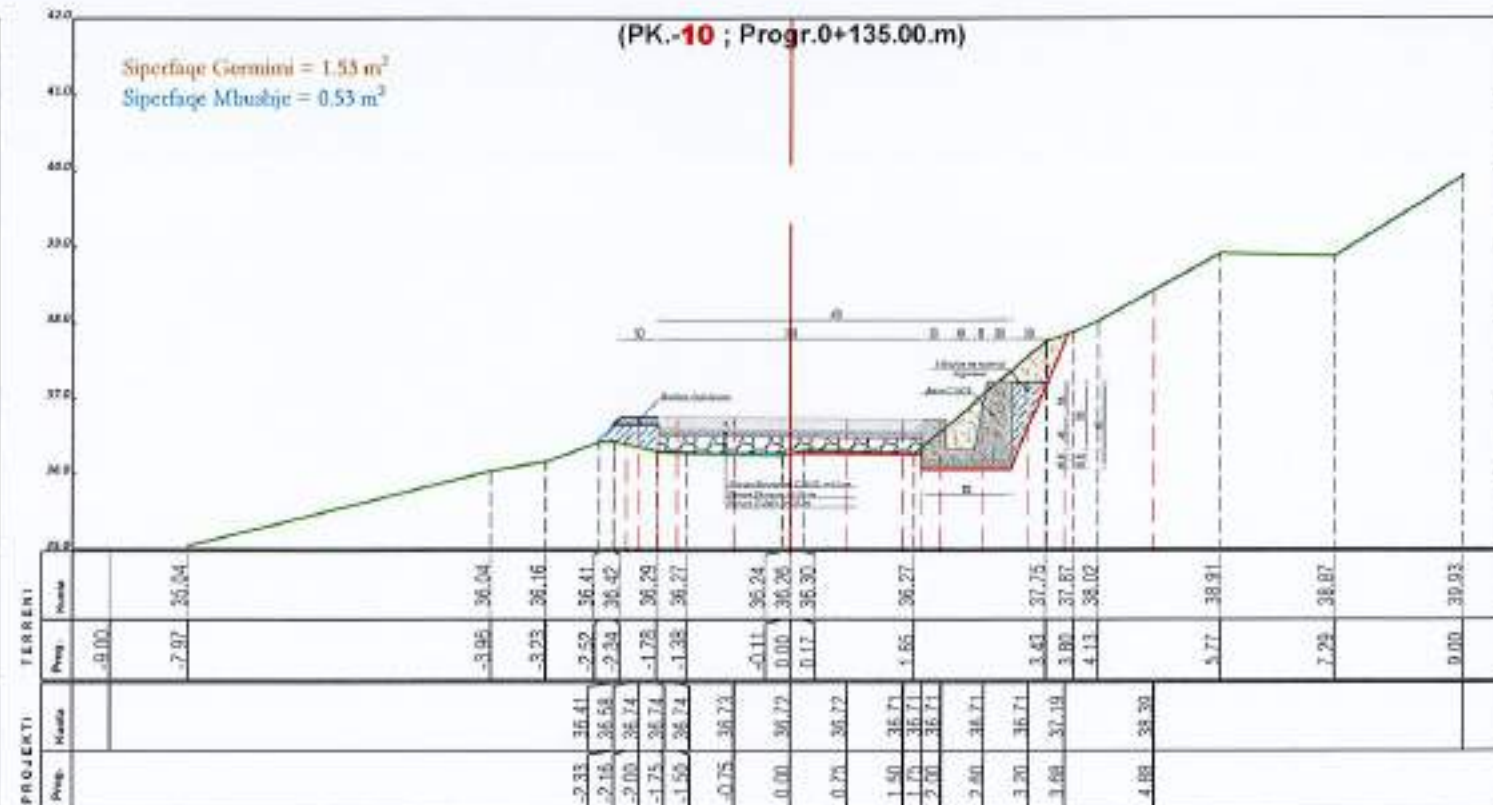

(PK.-11 ; Progr.0+145.61.m)

Siperfaqe Gjermimi = 4.02 m²
Siperfaqe Mbushtje = 0.62 m²

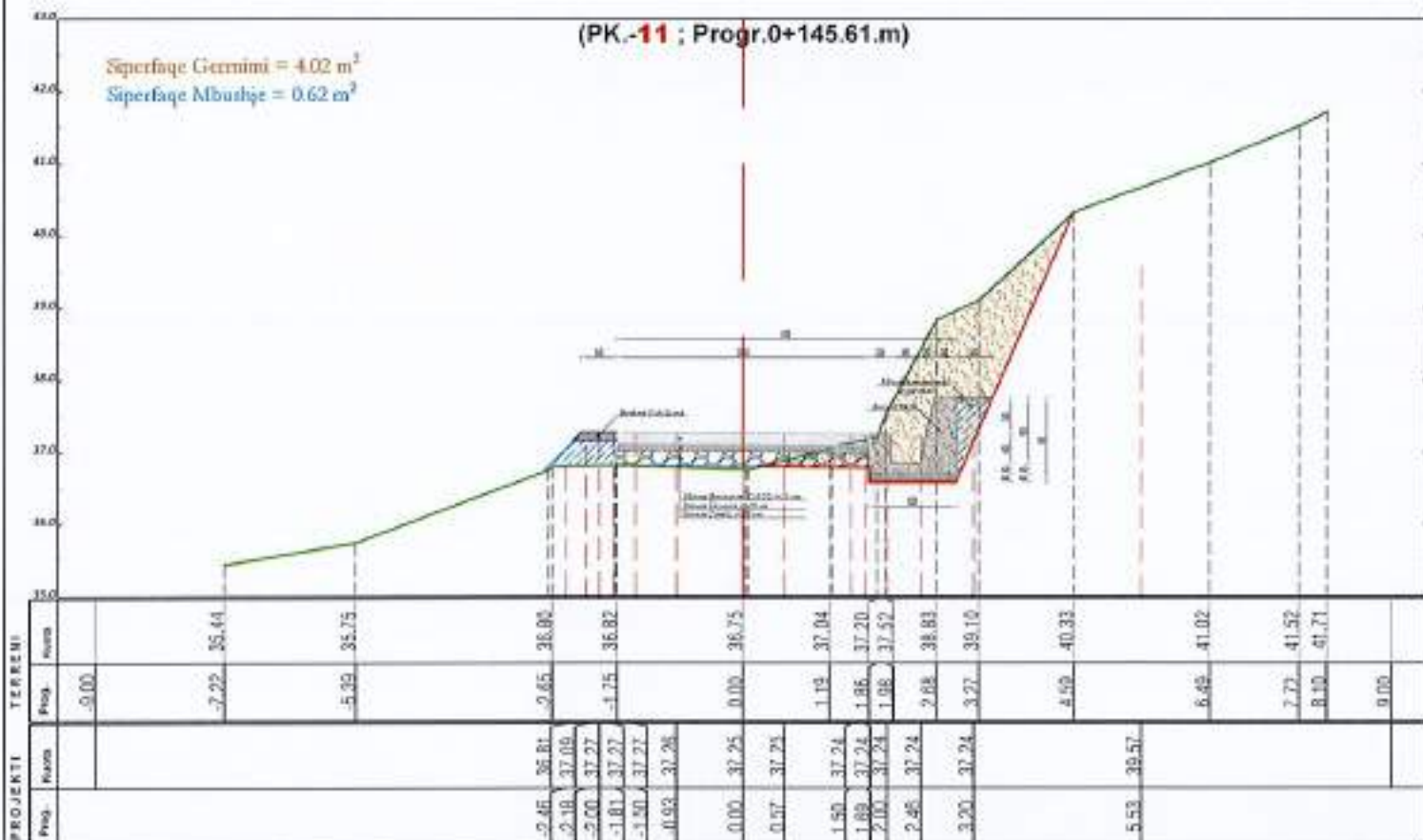

(PK.-12 ; Progr.0+155.97.m)

Siperfaqe Gjermimi = 5.45 m²
Siperfaqe Mbushtje = 0.55 m²

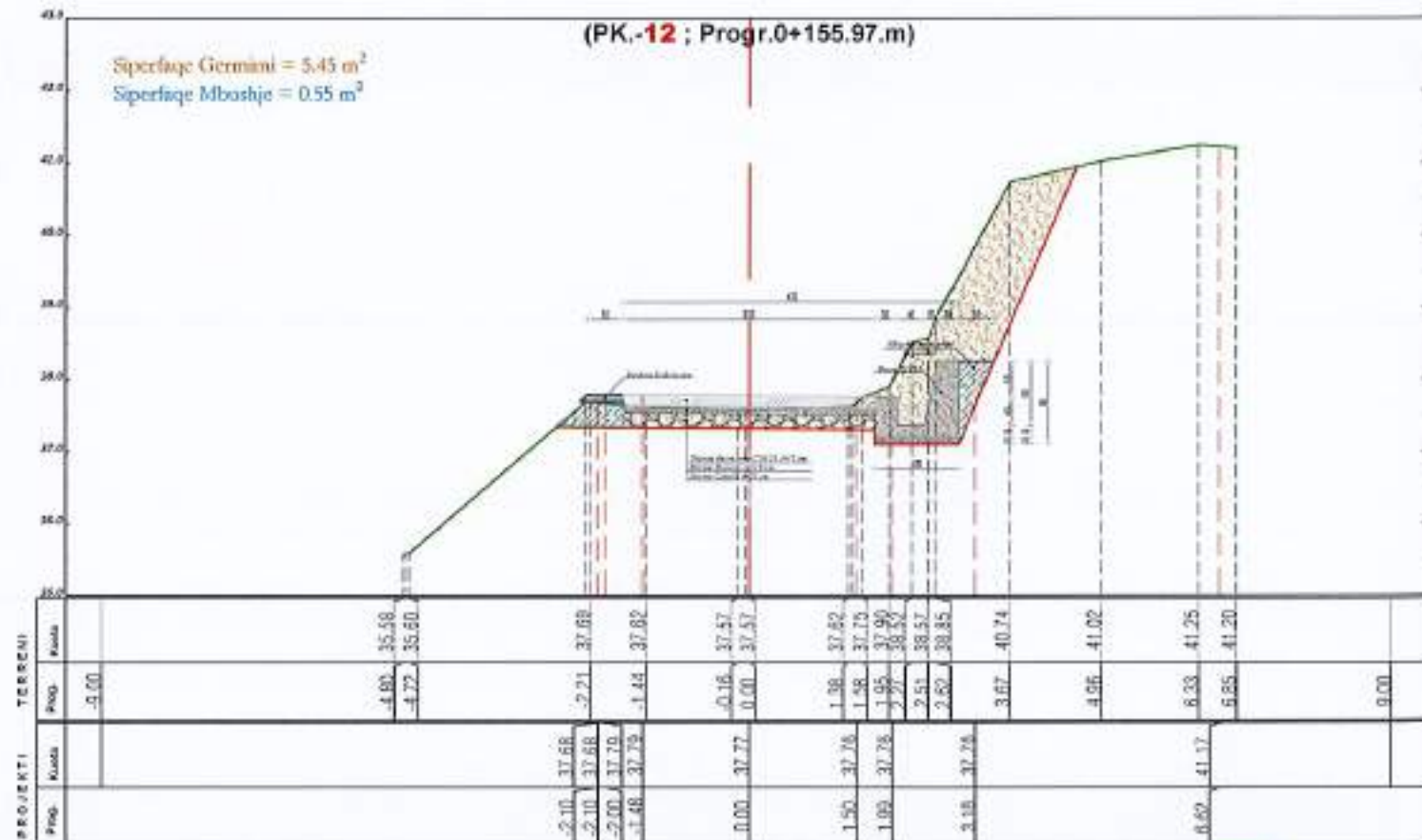

POROSITESI

BASHKIA VAU DEJES



"ANGERBA" shpk

Adresa: Rr. "Irfan Tomini" Tirane.
Cel: 069 20 95 862
E-mail: burhanhafizi@gmail.com

VENDËSDHJA
Bashkia Van Dejes

TITULLI I PROJEKTI

SISTEMI ASFALTIM I RRUGES SE MALESOREVE
NJESIA ADMINISTRATIVE BUSHAT

FAZA E PROJEKTIMIT:
PROJEKT ZBATIMI

TITULLI I VIZATIMIT:

PROFLET TERTHORE
DEGA E MAJTE

Grupi i Projektimit

Ing. Burhan HAFIZI
Ing. Servet VERÇANI
Ing. Gerti HAFIZI



Shkala: 1:100
Data: Mars 2023
Fletja Nr.6

TABELA E VOLUMEVE RRUGA MAJTAS

VOLUMET E GERMIMEVE						VOLUMET E MBUSHJEVE					
Nr	Siperfaqe	Siperfaqe Mesatare	D.Pjesore	V.Pjesor	Vol.Progresiv (m ³)	Nr	Siperfaqe	Siperfaqe Mesatare	D.Pjesore	V.Pjesor	Vol.Progresiv (m ³)
1	0.00					1	0.00				
2	1.32	0.66	13.34	8.80	8.80	2	0.29	0.15	13.34	1.93	1.93
3	0.84	1.08	18.34	19.81	28.61	3	0.29	0.29	18.34	5.32	7.25
4	1.14	0.99	13.33	13.20	41.81	4	0.29	0.29	13.33	3.87	11.12
5	0.72	0.93	16.24	15.10	56.91	5	1.06	0.68	16.24	10.96	22.08
6	4.22	2.47	13.76	33.99	90.90	6	0.39	0.73	13.76	9.98	32.06
7	7.26	5.74	15.00	86.10	177.00	7	0.39	0.39	15.00	5.85	37.91
8	1.48	4.37	15.00	65.55	242.55	8	0.47	0.43	15.00	6.45	44.36
9	1.95	1.72	15.00	25.73	268.27	9	0.52	0.50	15.00	7.43	51.78
10	1.53	1.74	15.00	26.10	294.37	10	0.53	0.53	15.00	7.88	59.66
11	4.02	2.78	10.61	29.44	323.82	11	0.62	0.58	10.61	6.10	65.76
12	5.45	4.74	10.37	49.10	372.92	12	0.55	0.59	10.37	6.07	71.82
			155.99		372.92				155.99		71.82

Volumi Total i Germimit = 373 m³

Volumi Total i Mbushjes = 72 m³



SEKSION TIP , DEGA E MAJTE
SH. 1:25

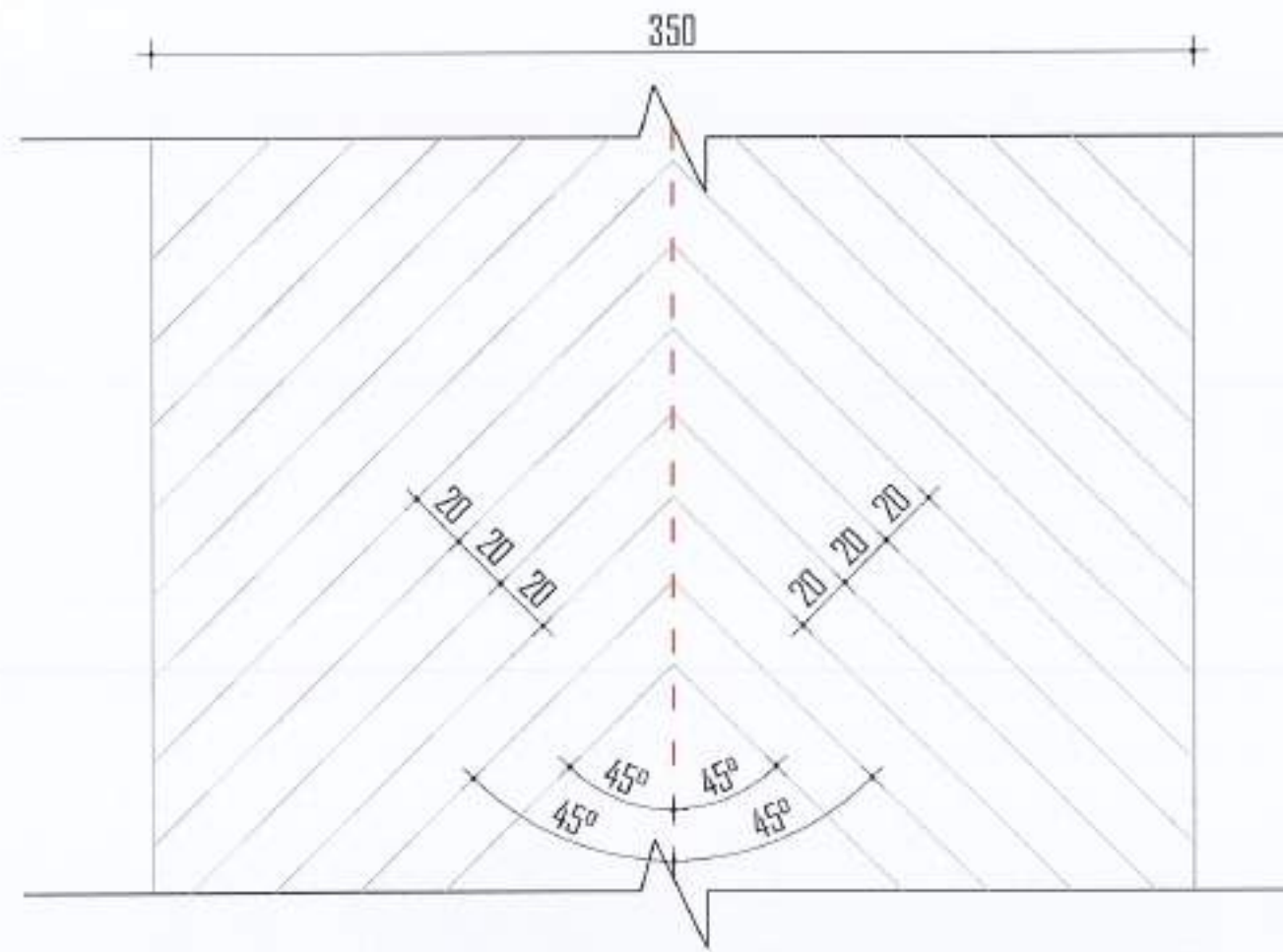
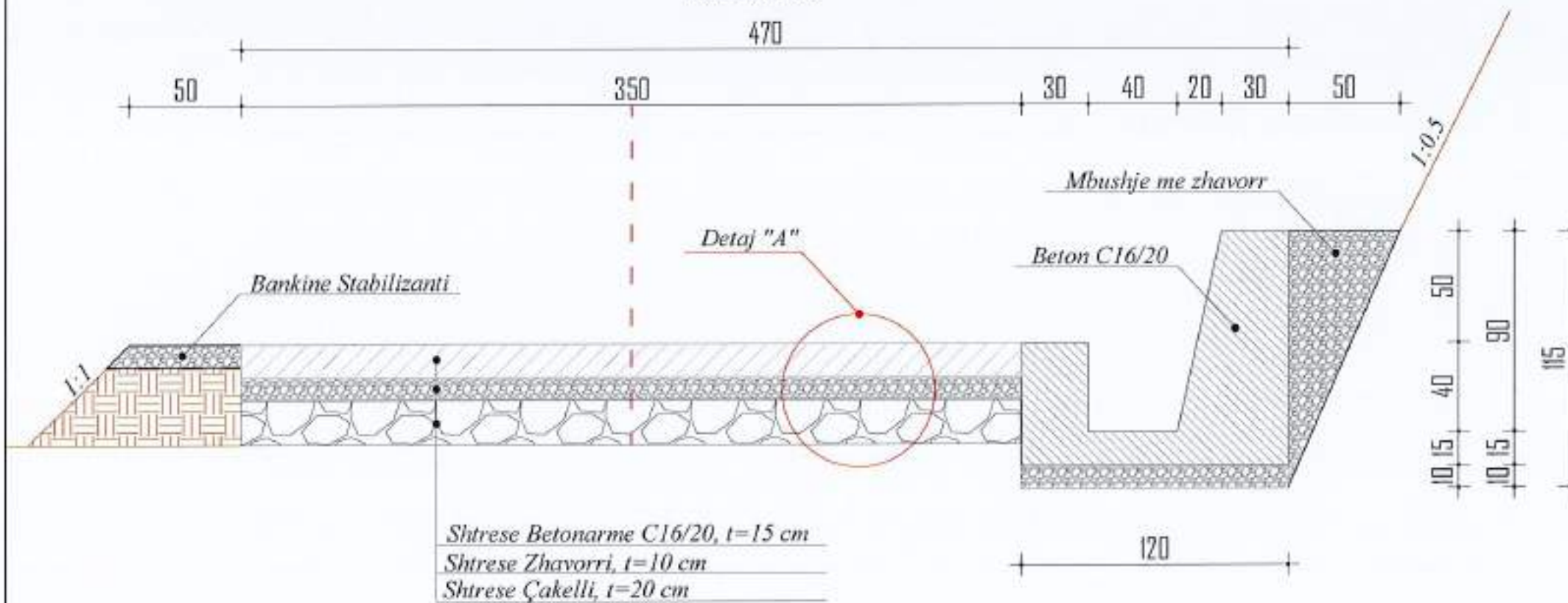

VIASKAT DO TE BEHEN ÇDO 20 CM NE KEND 45° ME AKSIN E RRUGES.

DETAJ "A"
SH. 1:10

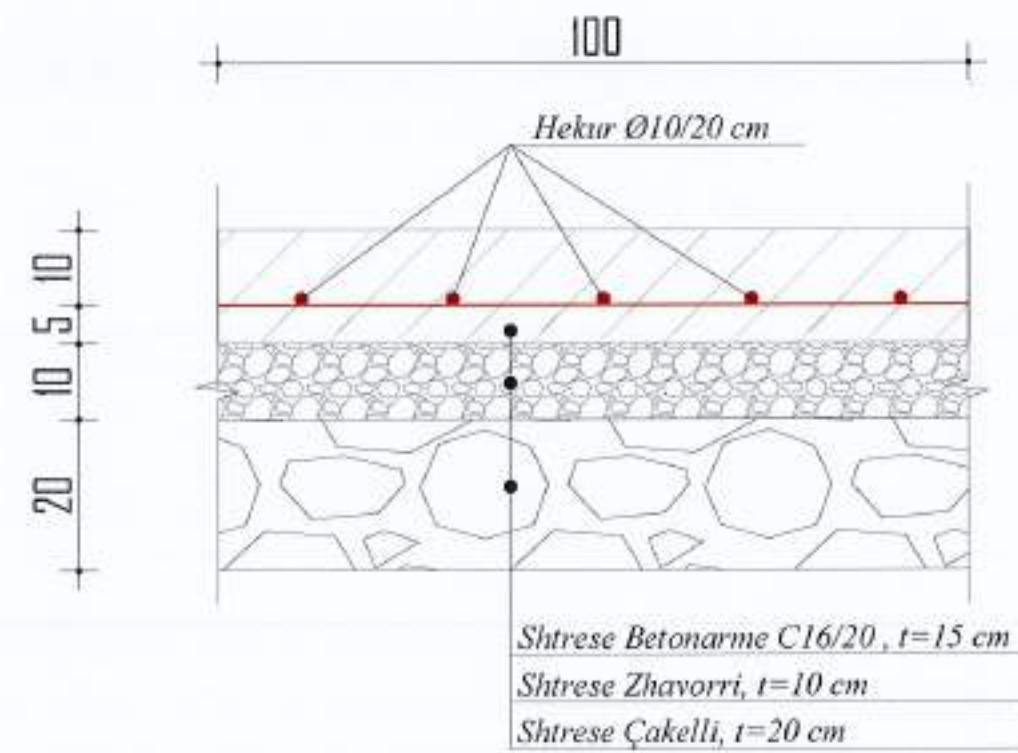

V.O. SEGMENTI KU RRUGA ESHTË E SHTRUAR (PK.1-5) , DO TE APLIKOHET VETEM HEKURI + 10 CM BETON

<p>POROSITESI</p> <p>BASHKIA VAU DEJES</p>	 <p>"ANGERBA" shpk Adresa: Rr. "Yrfan Tomini" Tirane. Cel: 069 20 95 862 E-mail: burhanhafizi@gmail.com</p>	<p>VENDOSJA</p> <p>Bashkia Vau Dejes</p> <p>TITULLI I PROJEKTIT</p> <p>SISTEMIM ASFALTIM I RRUGES SE MALESOREVE NJESIA ADMINISTRATIVE BUSHAT</p>	<p>FAZA E PROJEKTIMIT:</p> <p>PROJEKT ZBATIMI</p> <p>TITULLI I VIZATIMIT:</p> <p>SEKSIONE TIP DEGA E MAJTE</p>	<p>Grupi i Projektimit</p> <p>Ing. Burhan HAFIZI Ing. Servet VERÇANI Ing. Gerti HAFIZI</p> <p>Shkalla: 1:10; 1:25 Data: Mars 2023 Fletë Nr.7</p> 
---	---	---	--	--