

Mirato:

KRYETARE MAJLINDA BUFI



Perositës

BASHKIA ROSKOVEC



PROJEKT-ZBATIMI

"NOVATECH STUDIO "SHPK

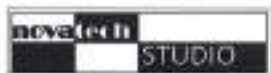

ING. EMIL NOVA

Grupi projektimit:

SHKURTIM	Blanca TOKO
SHKURTIM	Edin ERD
SHKURTIM	Klodon HODU
SHKURTIM	Ervin ROSA
ARHITEKT	Kujtim ROSA
SHKURTIM	Blanca ROSKOV
SHKURTIM	Miranda ROSKOV
SHKURTIM	Miranda ROSKOV
SHKURTIM	Miranda ROSKOV
SHKURTIM	Miranda ROSKOV
SHKURTIM	Miranda ROSKOV



Titulli i Projektit

**REHABILITIMI URBAN I NJE PJESE TE BLOKUT NR.3 NE QENDER TE QYTETIT ROSKOVEC
(FAZA NR 1)**

2- NDERTIMI I PARKUT TE RI TE QYTETIT

PROJEKTI I ZBATIMIT

PLAN I PERGJITHSHEM I NJE PJESE TE BLOKUT NR.3

SHK:1:1000



Legjende

[Symbol]	Kuote Topografike
[Symbol]	Rrethim / jashtëm / stacionit
[Symbol]	Rrethim / fushes
[Symbol]	Fijde
[Symbol]	Shkalle per publikum
[Symbol]	Shtyllë tensioni / larte
[Symbol]	Kolektor
[Symbol]	Rruge
[Symbol]	Shtyllë elektrike
[Symbol]	Ndertesë



BASHKIA ROSKOVEC
 Titulli i Projektit
**REHABILITIMI URBAN I NJE PJESE
 TE BLOKUT NR.3 NE QENDER TE
 QYTETIT ROSKOVEC (FAZA NR 1)**
 Faza
PROJEKTI I ZBATIMIT

Author
"NOVATECH STUDIO" SHPK
 ING. EMIL NOVA

Grupi projektues
 NOVATECH STUDIO SHPK
 (Stamp and signature area)

PROJEKTI ARKITEKTONIK
 Titulli i Viteve
PLAN I PERGJITHSHEM
 Poulencur
 2.08.2022
 Skalla
 1:1000
U.1 - 02

PLANVENDOSJE E PARKUT REKREATIV

SHK:1:1000

Legjende

	Kuote Topografike
	Fushim / jashtem / stadium
	Fushim / fushes
	Hyge
	Shkalle per publikum
	Shlyte tensioni / larte
	Kolektor
	Rruge
	Shlyte elektrike
	Ndertesë



 BASHKIA ROSKOVEC
 Titull / Projektimi
 REHABILITIMI URBAN I NJE DJESE
 NE BLOKUT NR. 3 NE QENDER TE
 QYTETIT ROSKOVEC (FAZA NR 1)
 Lloji
 PROJEKTI I ZBATIMIT
 Autori
 "NOVATECH STUDIO" SHPK
 ING. ERIL NOVA
 Grupi projektues
 NOVATECH STUDIO SHPK
 Mënyra TIRAGE
 Niveli KALOR
 KLASIFIKIMI
 Shteti NOVA
 KRYETARI NOVA
 ZYRTARE
 SHKËMBI DORË
 MËKËMBI SHËLLAKU
 PUNËS
 KOSKOSKI
 Vendi
 Kapitulli
PROJEKTI ARKITEKTONIK
 Titulli i Vlerësimit
 PLANVENDOSJE E PARKUT REKREATIV
 Realizuar
 2.08.2022
 Shkallë
 1:500
 Identifikues i Planit
U.1 - 03

PAMJE TREDIMENSIONIALE



Pasqitë

BASHKIA RROSKËVE
 Titulli i Projektit
**REHABILITIMI-URBAN I NJË PËRSE
 TE BLOKUT NR.3 NE QENDR TE
 QYTETIT RROSKËVE (FAZA NR 1)**
 Tipi
PROJEKTI I ZBATIMIT
 Vendi

Autor
"NOVATECH STUDIO" SHPK

ING. EMIL NOVA
 Drejtori projektant

NOVATECH STUDIO
 Sh.p.k.
 Vendi

Kapitulli
PROJEKTI ARKITEKTONIK
 Titulli i Vëstitimit
PAMJE TREDIMENSIONIALE TE STADIUMIT
 Data
2.08.2022 Shkalla 1:150
 Ecurtari i Përkth
A1 - 4

DETAJ 1

SHK. 1:100

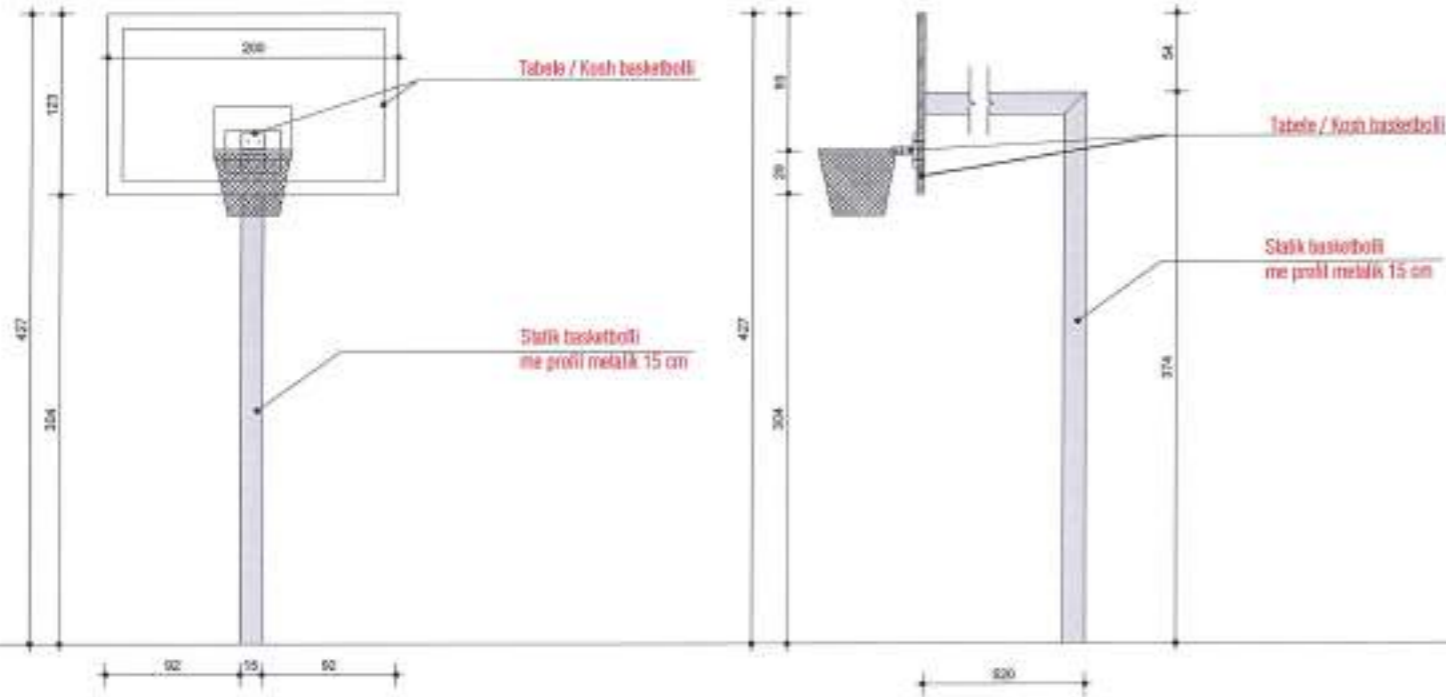

Detaji i shtrimit te fushes

Vijezim me bojë te zezë ose te bardhë
 Shtrëse tartari ose bar sintetik
 Shtrëse gome 1.2 cm + Primer
 Shtrëse beton C-16/20 l=15 me zgarë hekuri 25x25cm
 Zgarësi l=20 cm



Detaje te kullimit te ujrave



H rrjetes = 2,43m (meshkuj)
 H rrjetes = 2,24m (femra)
 H rrjetes = 0,91 ÷ 1,09 m (tenis)

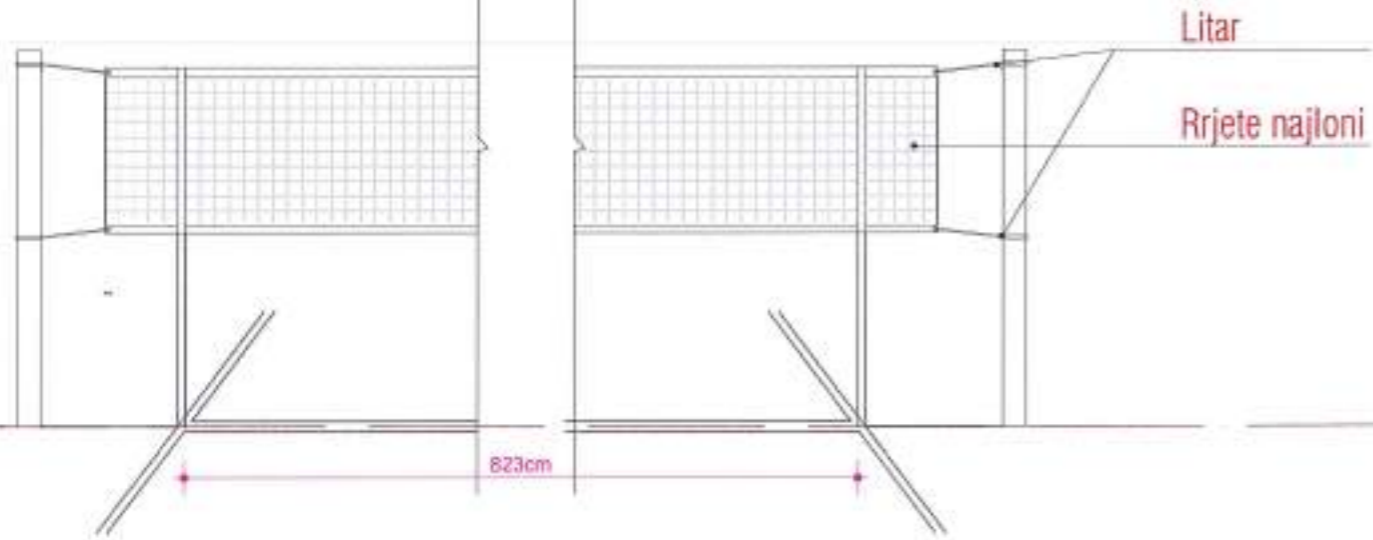

Detaj i themelit dhe rrethimit

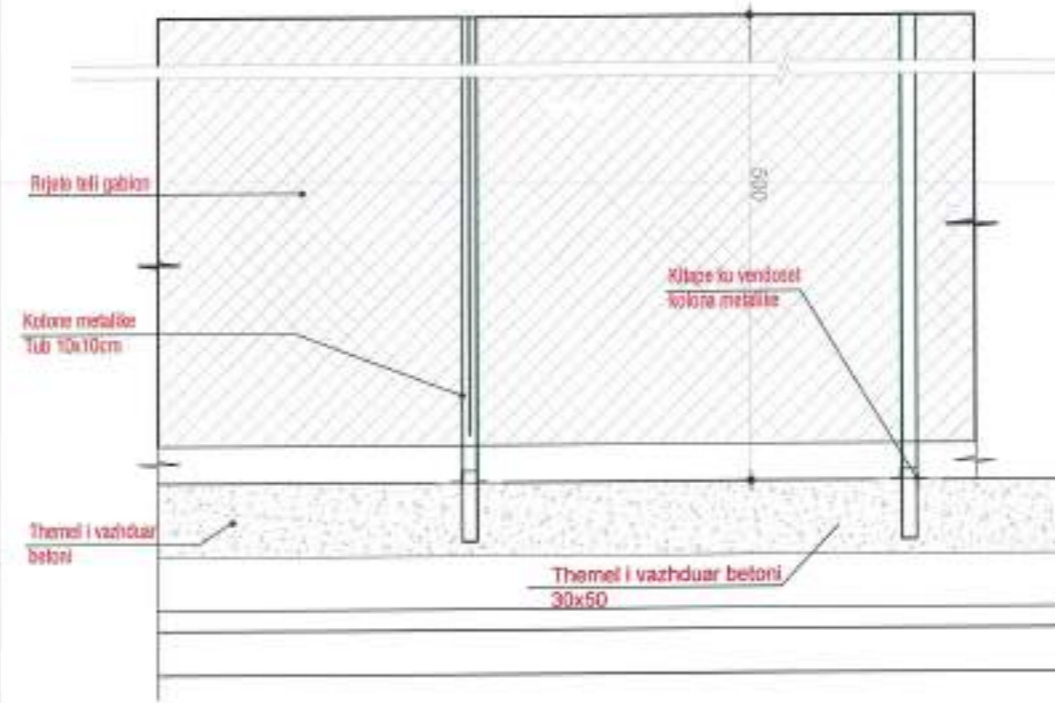

Porositë

BASHKIA ROSKOVEC

Titulli / Projekti

REHABILITIMI URBAN I NJE PJESE
 TE BLOKUT NR. 6 NE QENDER TE
 QYTETIT ROSKOVEC (FAZA NR. 1)

Faza

PROJEKTI I ZBATIMIT

Vula

Autor

"NOVATECH STUDIO" SHPK

ING. EMIL NOVA

Grupi projektimit:

ING. HENRIETA
 ING. HENRIETA
 ING. HENRIETA
 ING. HENRIETA
 ING. HENRIETA
 ING. HENRIETA

Vula

Kapitulli

PROJEKTI ARKITEKTONIK

Titulli i Vlerësimit

DETAJE TE FUSHES SE SPORTIT

Realizuar

2.08.2022

Rishikim

1.00

Emetimi i Paktit

A1 - 7

PAMJE TREDIMENSIONALE TE FUSHES SE SPORTIT



Poroçhëta



Titulli i Projektit

REHABILITIMI URBAN I NJE PJESE
TE BLOKUT NR.3 NE QENDER TE
QYTETIT ROSKOVEC (FAZA NR 1)

Vendi

PROJEKTI I ZBATIMIT

Autor

"NOVATECH STUDIO" SHPK

STUDIO
ING. EMIL NOVA

Grupi projektues

NOVATECH	MIRAZA TOMO
NOVATECH	KOLIBER BASHI
NOVATECH	EDON MEGU
NOVATECH	GERIO NOVA
NOVATECH	ERLONDE NOVA
NOVATECH	EDON BASHI
NOVATECH	EDON DORR
NOVATECH	MIRAZA BILAKU



Vendi

Kapitulli

PROJEKTI ARKITEKTONIK

Titulli i Vërtimit

PLANIMETRIA E FUSHES SE SPORTIT

Realizuar

2.08.2022

Emetuesi i Planit

A1 -8

PLANSISTEMIMI I PARKUT REKREATIV SHK 1:200



Personela	<p>BASHKIA ROSKOVEC</p>
Titulli / Projektit	
Titulli / Projektit	REHABILITIMI URBAN I NJE PJESE TE BLOKUT NR.3 NE QENDER TE QYTETIT ROSKOVEC (FAZA NR 1)
Faza	PROJEKTI I ZBATIMIT
Vula	
Autor	"NOVATECH STUDIO" SHPK
	<p>ING. EMIL NOVA</p>
Grupi projektues	<p>NOVATECH STUDIO SHPK</p>
Vula	
Kapitulli	PROJEKTI ARKITEKTONIK
Titulli i Vlerksimit	PLANSISTEMIMI I PARKUT REKREATIV
Skolluar	2.08.2022
Skalla	1:200
Konkretimi i Paktit	A1 - 9

**ARMIMI I STOLIT TIP 3
SH 1:20**

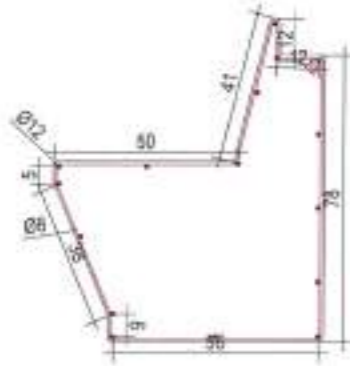

Ristelat e drurit
3x 30x ristelat me L= të ndryshme
dhe profil tërthor 18cmx3cm sipas
tabelës
Ristelat kapen me vëda dhe upa në
beton

Armimi i stolave 60x240
24xStafa me L= 305cm dhe ø 8mm, të
pozicionuara 20cm larg njëra tjetres
16xShufra me L = e ndryshme sipas
tabelës

5	ø12	475cm
1	ø12	550cm
1	ø12	550cm
1	ø12	585cm
1	ø12	615cm
1	ø12	655cm
1	ø12	770cm
2	ø12	830cm
1	ø12	885cm
2	ø12	925cm

Nr	B	H
18	16cm	3cm (52;46.5)cm
18	16cm	3cm (46;40.5)cm
18	16cm	3cm (40;35)cm

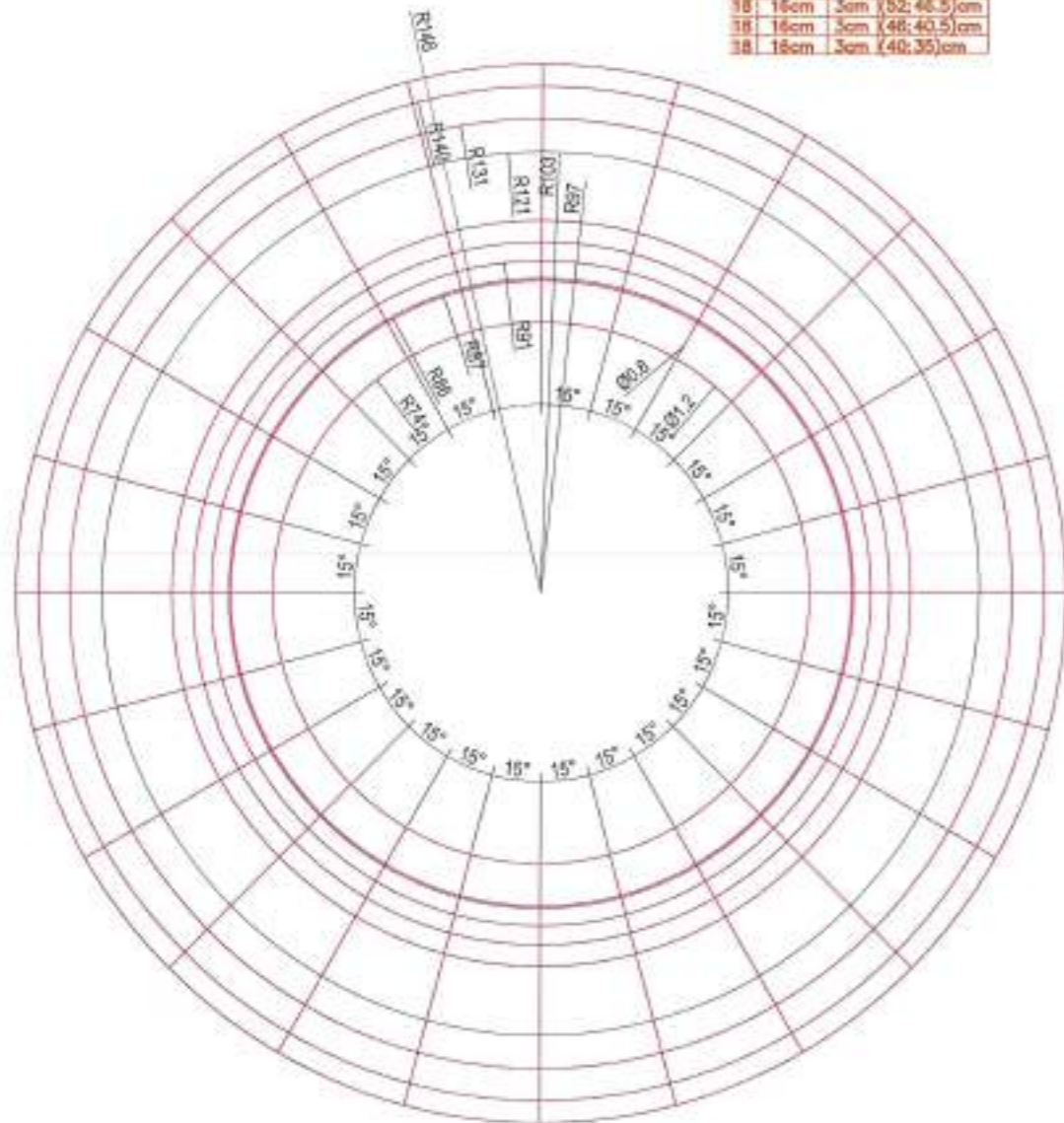

PRERJA A-A E STOLIT TIP 3 SH 1:20

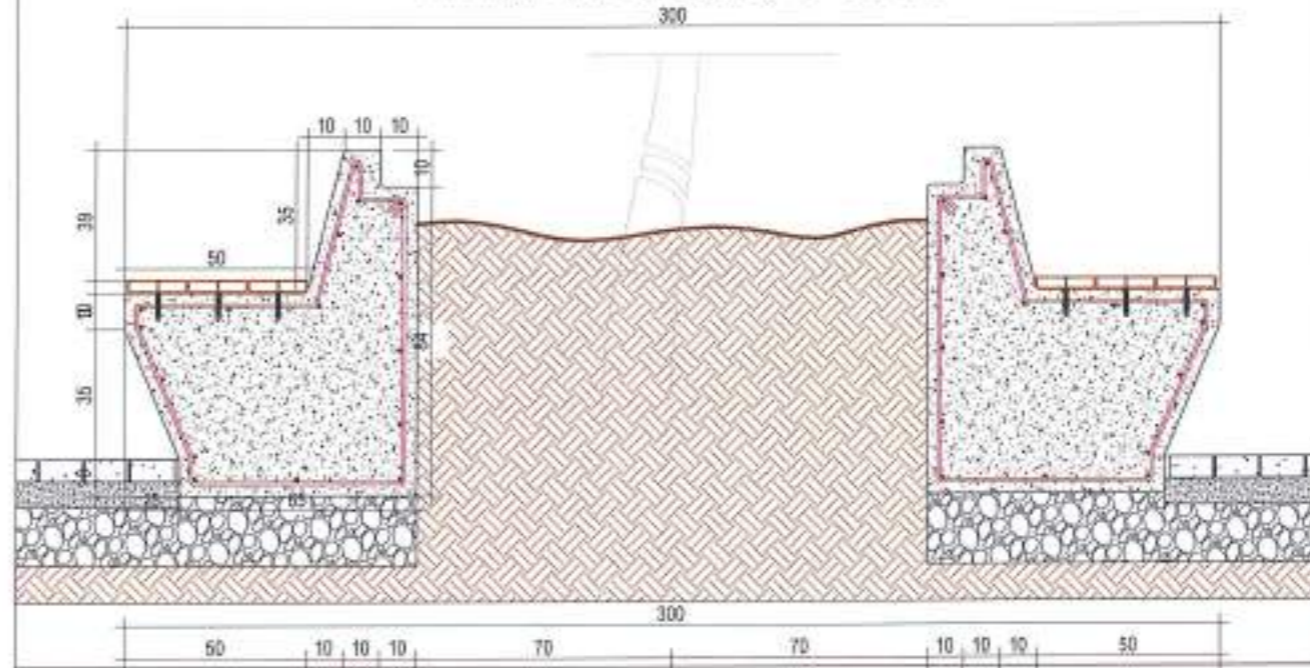

**PLANI I STOLIT TIP 3
SH 1:20**

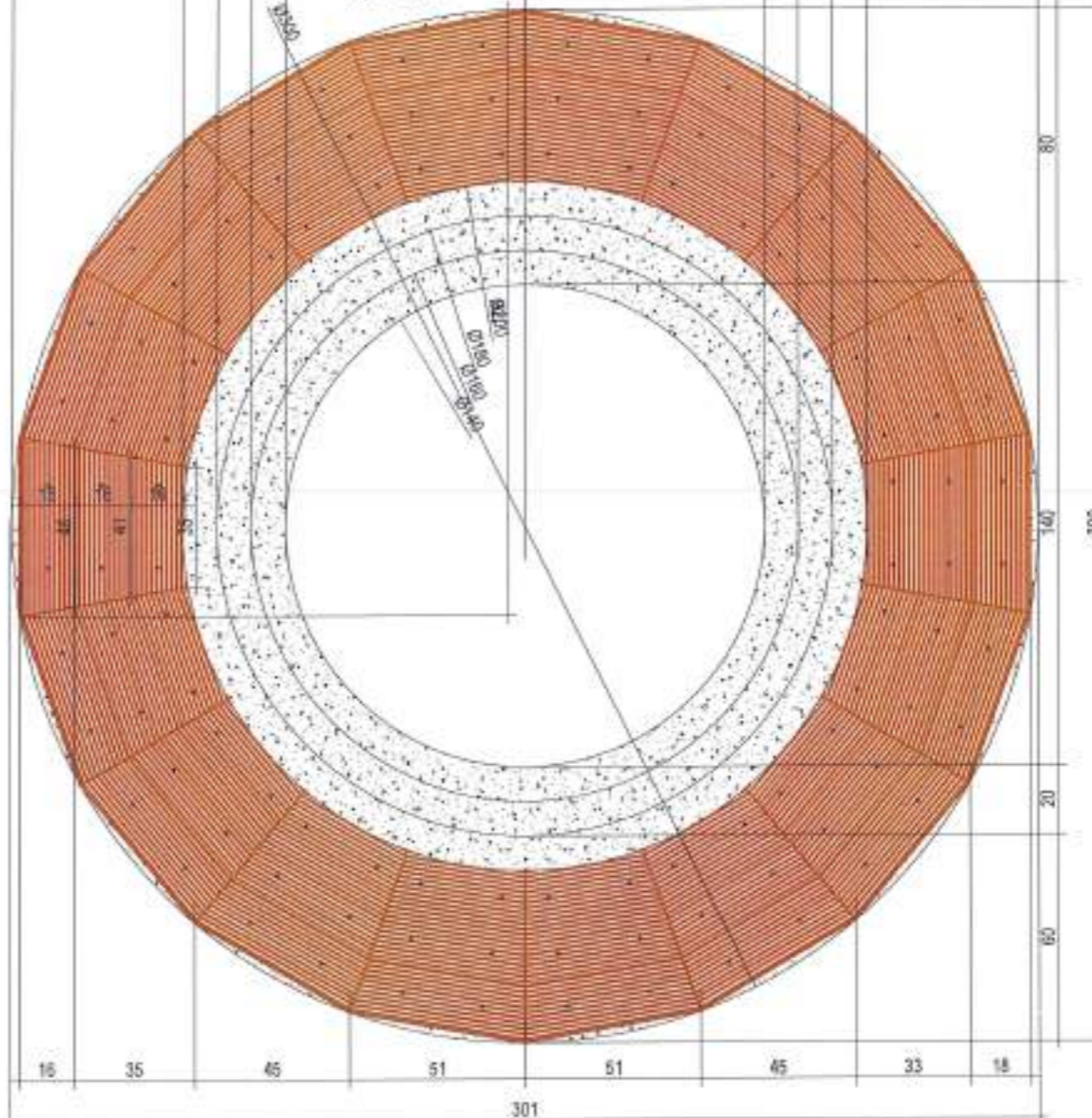

Titulli i Projektit
**REHABILITIMI URBAN I NJE PJESE
TE BLOKUT NR.5 NE QENDER TE
QYTETIT ROSKOVEC (FAZA NR 1)**

Tipi i Projektit
PROJEKTI I ZBATIMIT

Vula

Autor
"NOVATECH STUDIO" SHPK
ING. ENIL NOVA



Vula

Kapitulli
PROJEKTI ARKITEKTONIK

Titulli i Vizatimit
DETAJI I STOLIT NR.3

Prokuruar
2.08.2022 Skalla
1:20

Emërtimi i Fletës
A1 - 11

NDËRTIMI I TROTUARIT DHE SHITESAVE RRUGORE

PRERJE E TROTUARIT

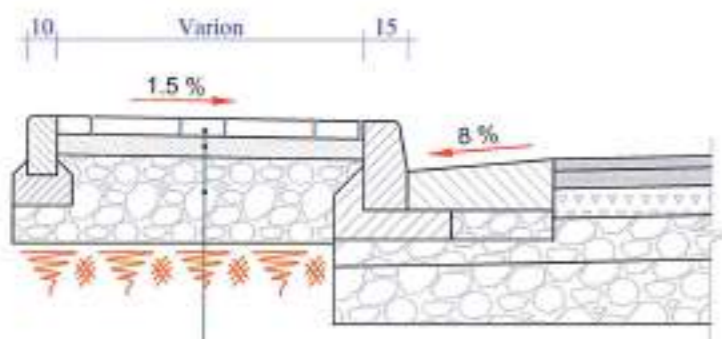

Pllaka Betoni	
Granil 6cm	7cm
Zhavorr	25cm

PLANIMETRIA



TROTUAR

BORDURE

KUNETA

TRUPI I RRUGES

Shenim :

- Hapesira midis fugave mbushet me rere.
- Ne rastet kur trotuari kufizohet me objekte ose mure rethues, bordura nga ana e jashtme nuk vendoset.

PAMJE E BORDURAVE DHE TROTUARIT DHE MËNYRA E NDËRTIMIT TË TYRE

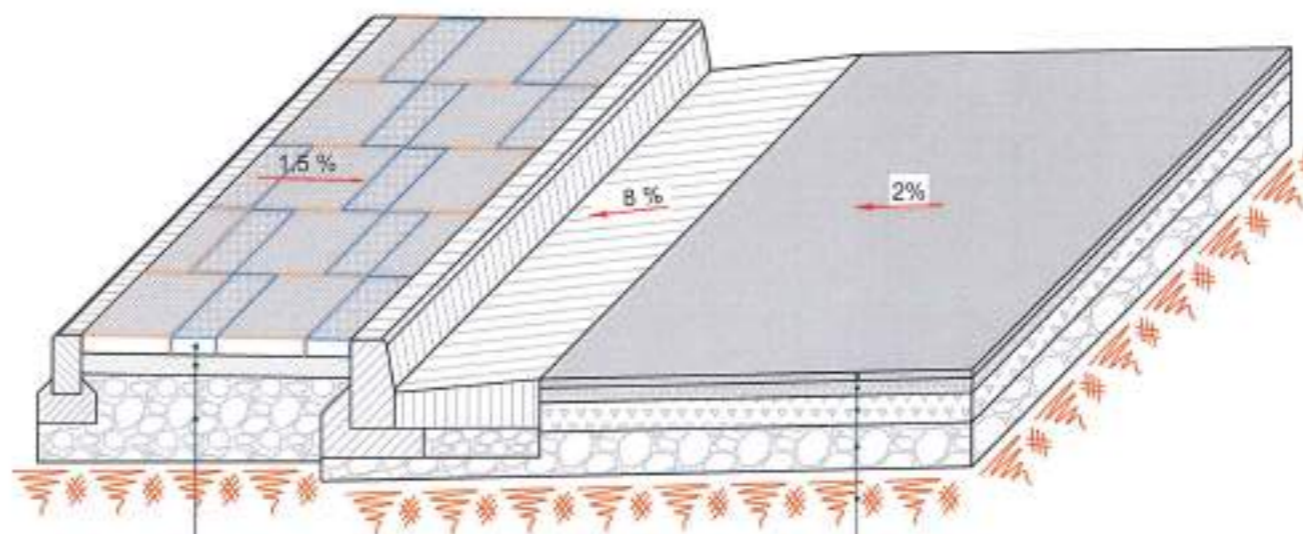

Pllaka Betoni	
Granil 6cm	7cm
Zhavorr	25cm

Asfaltobeton	3 cm
Binder	5 cm
Stabilizant	10 cm
Çakëll (Zhavorr)	20 cm

BORDURA

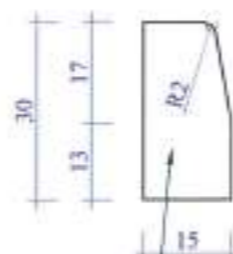

Bordure Parafabrikat Beton M-250

PLAKAT

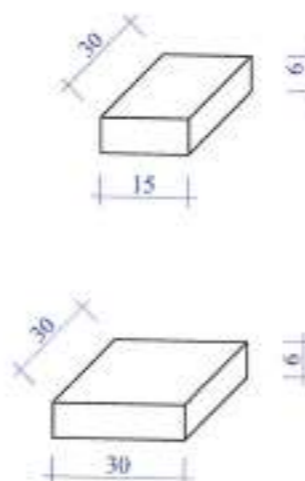

KUNETA

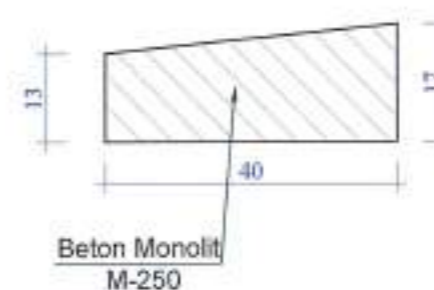

Pjesëllojë

BASHKIA ROSKOVEC

Titulli i Projektit

REHABILITIMI URBAN I NJE PJESE
TE BLOKUT NR.3 NE QENDER TE
QYTETIT ROSKOVEC (FAZA NR 1)

Faza

PROJEKTI I ZBATIMIT

Vendi

Autor

"NOVATECH STUDIO" SHPK

ING. EMIL NOVA

Grupi projektues

PROJEKTI I REHABILITIMIT URBAN I NJE PJESE
TE BLOKUT NR.3 NE QENDER TE QYTETIT
ROSKOVEC (FAZA NR 1)

Vula

Kopërtulli

PROJEKTI ARKITEKTONIK

Titulli i Viteletit

NDËRTIMI I TROTUARIT DHE SHITESAVE
RRUGORE

Rrezelimi

2.08.2022

Skallë 1:25

Eshtërtimi i Planit

A1 - 12

VENDKALIMET PËR KËMBËSORË

PLANIMETRIA

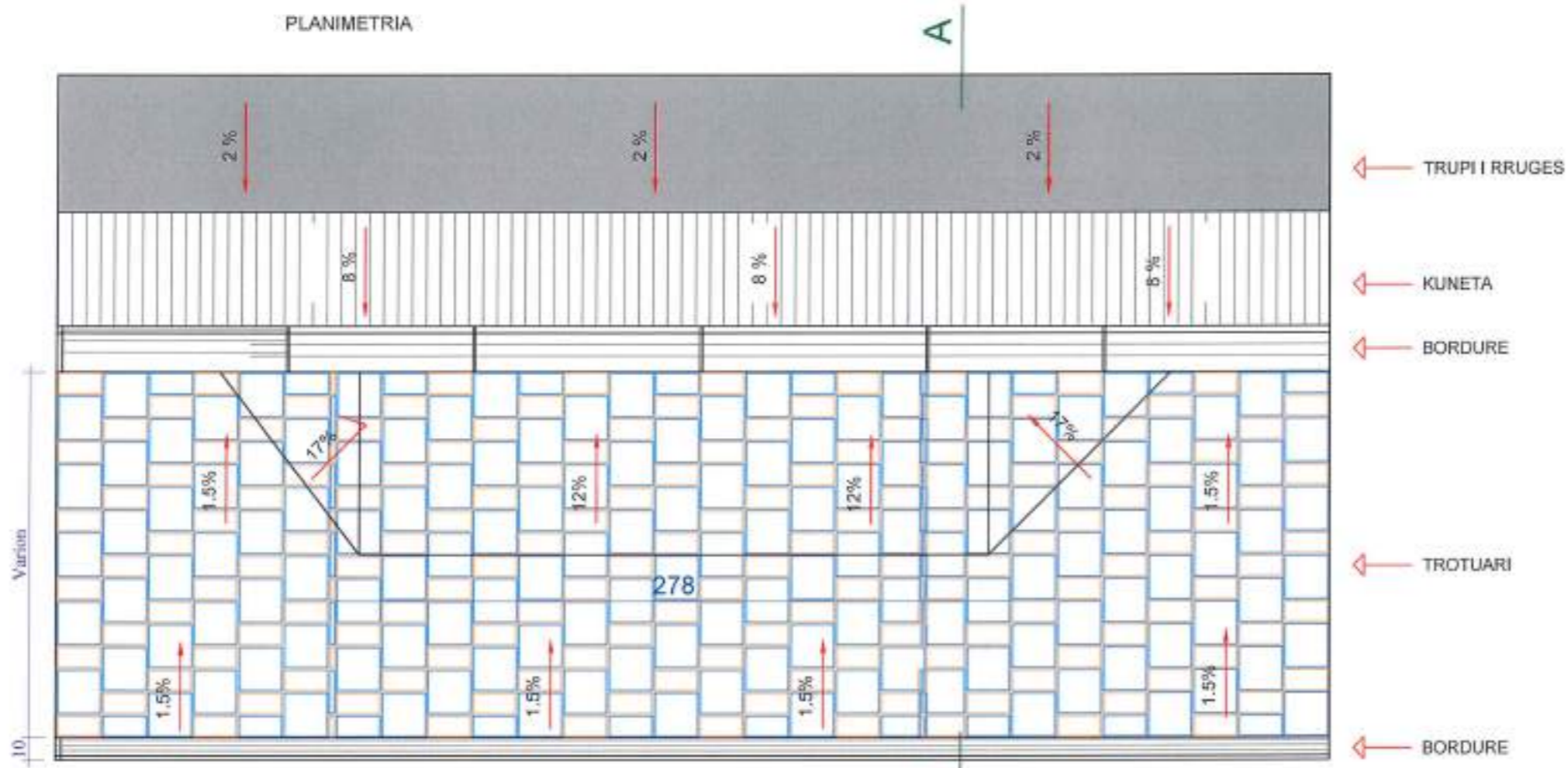

PRERJA A-A

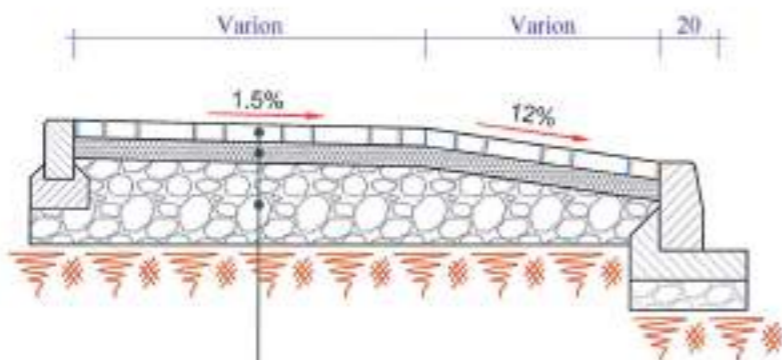

Pllaka Betoni	
Granil 6cm	7cm
Zhavorr	25cm

DIMENSIONI I PLLAKAVE TE GURIT NE SHESHIN PRANE THESARIT (40 cm X 40 cm) Fuga 5mm

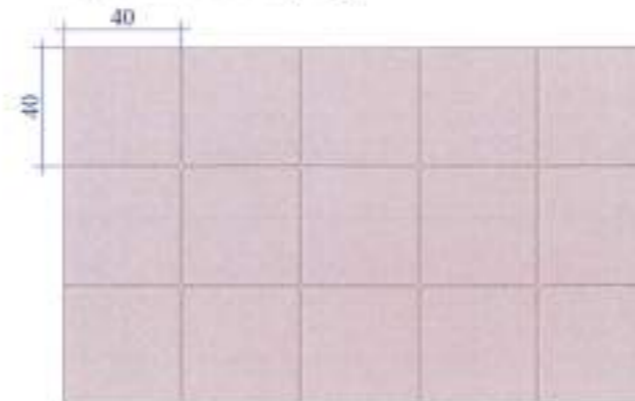

Plan shtrimi

Parashtetja

BASHKIA ROSKOVËC

Titulli i Projektit

REHABILITIMI URBAN I NJË FJESË
TE BILLOKUT NR 2 NE QENDER TE
QYTETIT ROSKOVËC (FAZA NR 1)

Emri

PROJEKTI I ZBATIMIT

Vula

Autor

"NOVATECH STUDIO" SHPK

ING. EMIL NOVA

Grupi projektues

NOVATECH STUDIO SHPK

Vula

Kapitulli

PROJEKTI ARKITEKTONIK

Titulli i Vlerësimit

VENDKALIMET PËR KËMBËSORË

Realizuar

06.08.2022

Skallë

1:25

Emërtimi i Planit

A1 - 13

PRERJA A-A SHK. 1:50

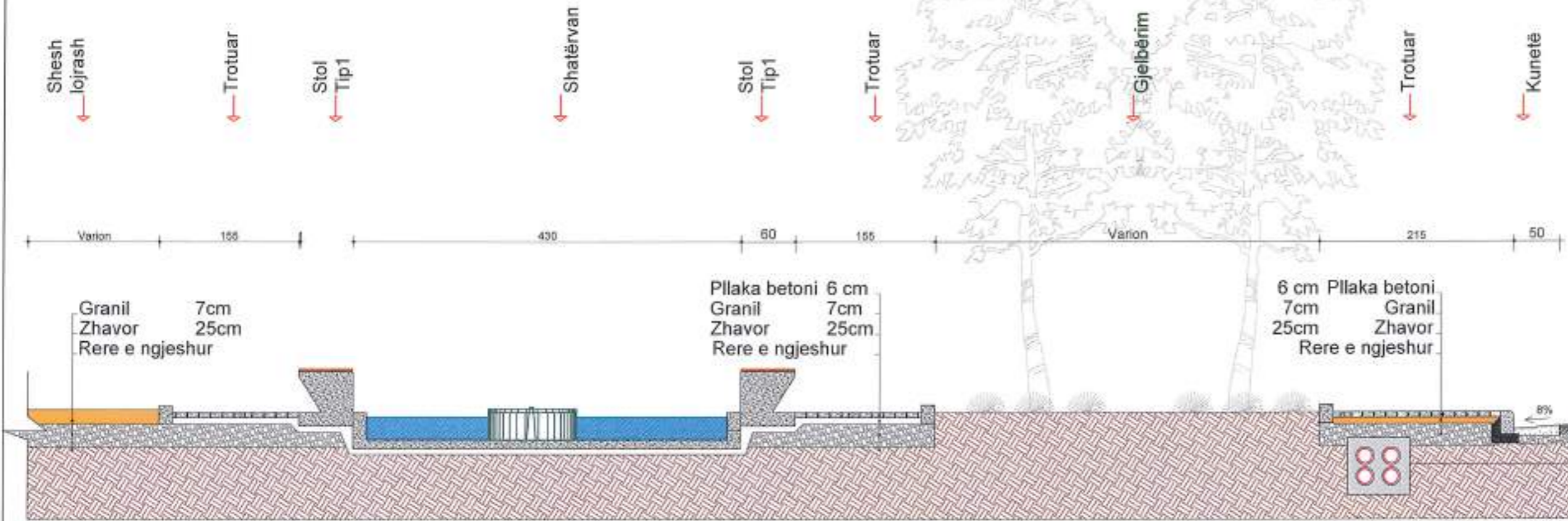

PRERJA B-B SHK. 1:50

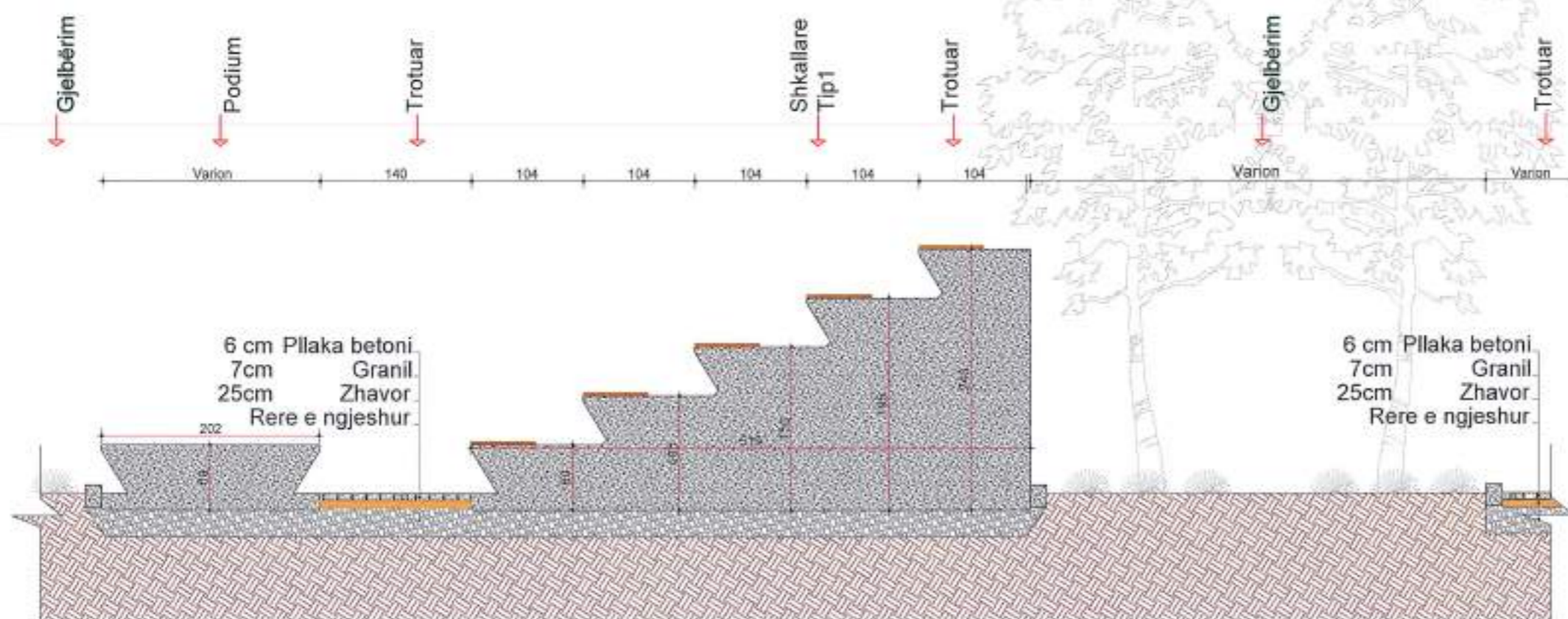

Porositës	BASHKIA ROSKOVEC
Titulli i Projektit	REHABILITIMI URBAN I AJRIT PJESE TE BILLOKUT NR.3 NE QENDER TE QYTETIT ROSKOVEC (FAZA NR 1)
Faza	PROJEKTI I ZBATIMIT
Vula	
Autor	"NOVATECH STUDIO" SHPK ING. EMIL NOVA
Grupi projektues	
Miratores	Mirator: BASHKIA ROSKOVEC Kohë: 04.08.2022 Mirator: ROSKOVEC Gjatë: ROSKOVEC Mirator: ROSKOVEC Mirator: ROSKOVEC Mirator: ROSKOVEC Mirator: ROSKOVEC
Vula	
Kapitulli	PROJEKTI ARKITEKTONIK
Titulli i Vlerimit	PRERJA A-A DHE B-B E PAKUT REKREATIV
Realizuar	2.08.2022
Shkallë	1:50
Emërtimi i Plani	A1 - 14

