

PROJEKT ZBATIMI

Asfaltim Rruga Stacioni i Trenit -Perimore Mamurraz

REPUBLIKA E SHQPERISE



BASHKIA KURBIN

KLIENT: BASHKIA KURBIN



PROJEKT: Asfaltim Rruga Stacioni i Trenit -Perimore Mamurraz

EMERTIMI I FLETES:
KAPAK

APROVIMI I KLIENTIT:



PROJEKTUAR:

"A.SH. ENGINEERING" sh.pk



VENDNDODHJA : ROSKOVEC

SH.

HOROGRAFIA



REPUBLIKA E SHQIPERISE



BASHKIA KURBIN



KLIENT: BASHKIA KURBIN

PROJEKT: Asfaltim Rruga Stacioni i Trenit - Perimore Mamurraz

EMERTIMI I FLETES:
HOROGRAFIA

APROVIMI I KLIENIT:



PROJEKTUAR:

"A.SH. ENGINEERING" sh.pk

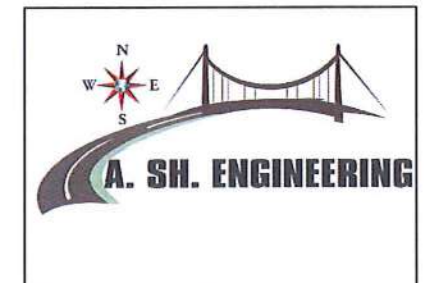

VENDNDODHJA : ROSKOVEC

SH.

PLANI TOPOGRAFIK

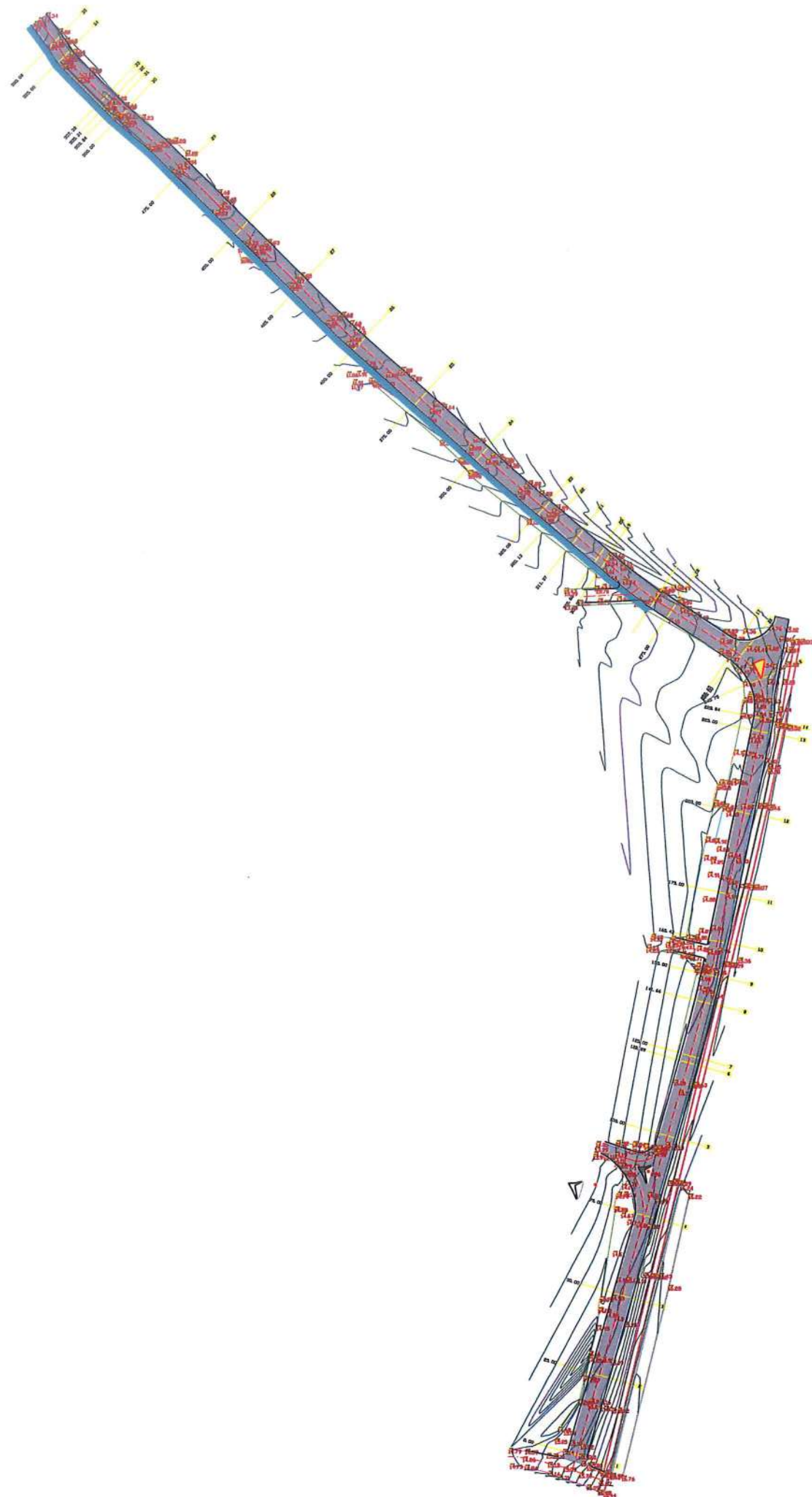

REPUBLIKA E SHQIPERISE



BASHKIA KURBIN



KLIENT: BASHKIA KURBIN

PROJEKT: Asfaltim Rruga Stacioni i Trenit - Perimore Mamurras

EMERTIMI I FLETES:

PLANIMETRIA PERGJITHSHME

APROVIMI I KLIENTIT:

PROJEKTUAR:

"A.SH. ENGINEERING" sh.pk



VENDNDODHJA : ROSKOVEC

SH.

PLANIMETRIA E PERGJITHSHME



REPUBLIKA E SHQIPERISE



BASHKIA KURBIN



KLIENT: BASHKIA KURBIN

PROJEKT: Asfaltim Rruga Stacioni i Trenit - Perimore Mamurras

EMERTIMI I FLETES:
PLANIMETRIA PERGJITHSHME

APROVIMI I KLIENTIT:

PROJEKTUAR:  
"A.SH. ENGINEERING" sh.pk

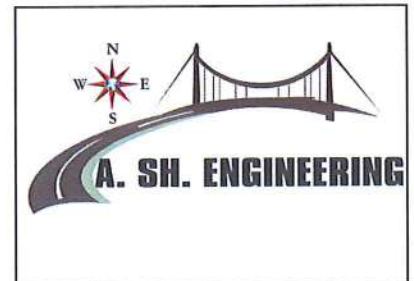

VENDNDODHJA : ROSKOVEC

SH.

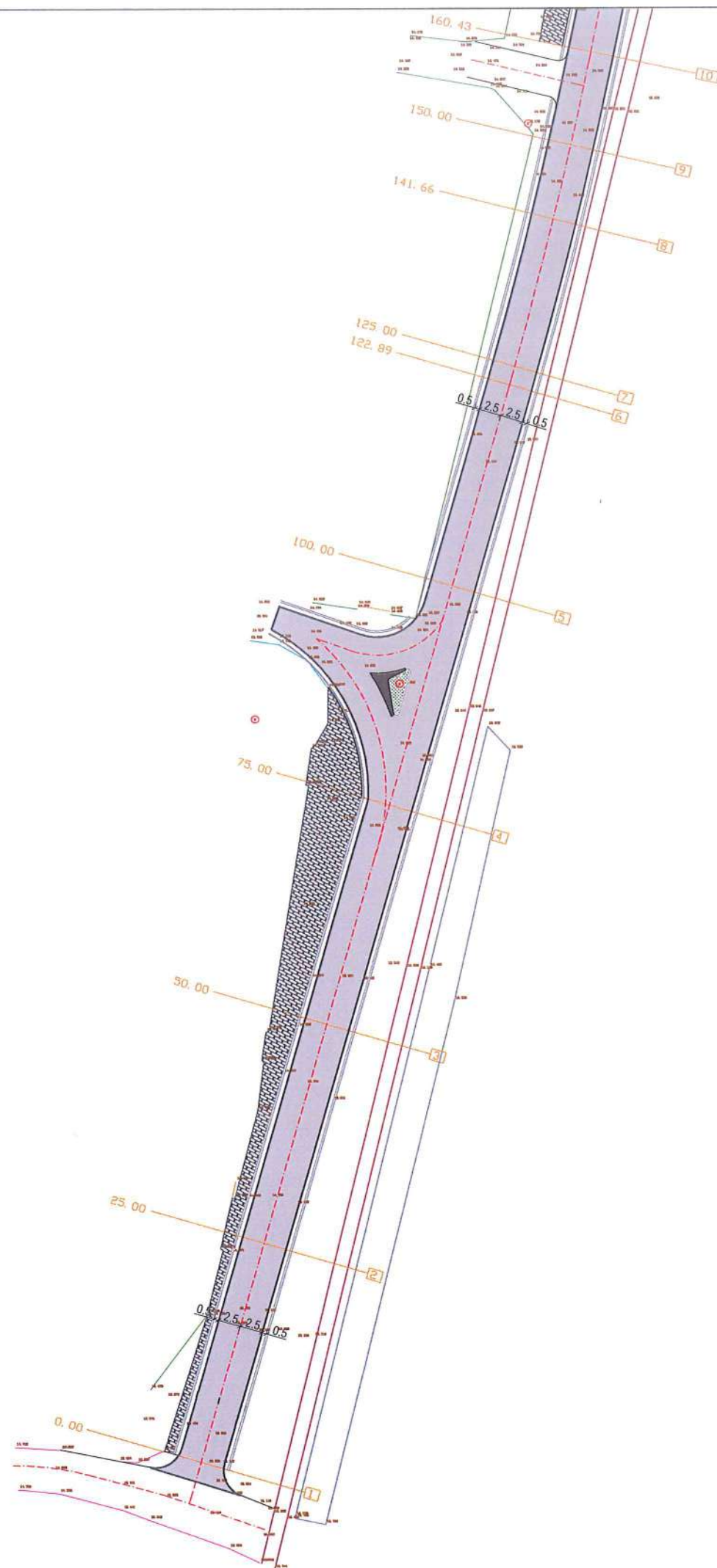

REPUBLIKA E SHQIPERISE



BASHKIA KURBIN



KLIENT: BASHKIA KURBIN

PROJEKT: Asfaltim Pruga Stacioni i Trenit - Perimore Mamurraz

EMERTIMI I FLETES:
PLANIMETRIA PERGJITHSHME

APROVIMI I KLIENIT:

PROJEKTUAR:

 "A. SH. ENGINEERING" sh.pk

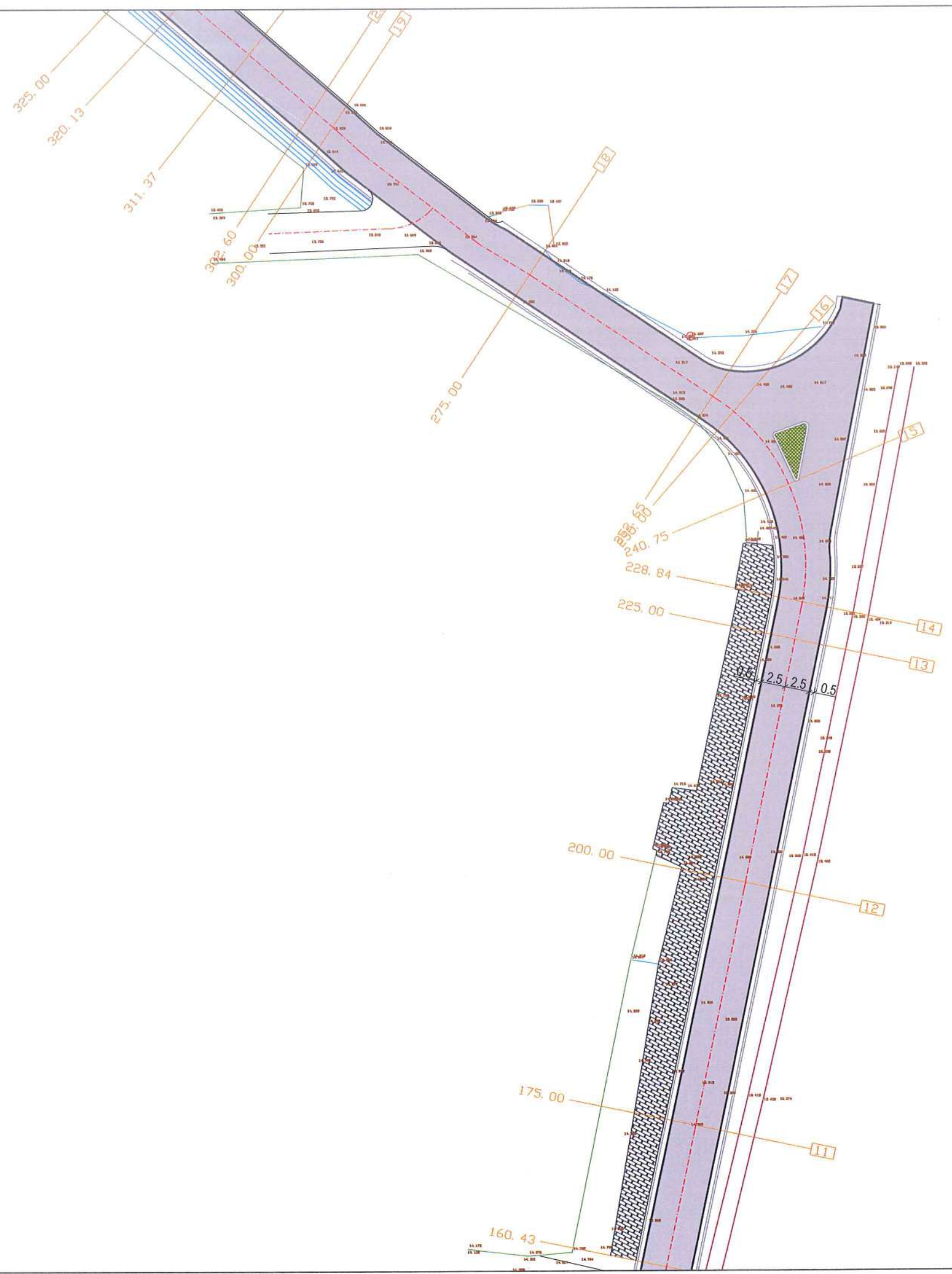

VENDNDODHJA : ROSKOVEC

SH.



REPUBLIKA E SHQIPERISE



BASHKIA KURBIN



KLIENT: BASHKIA KURBIN

PROJEKT: Asfaltim Pruga Stacioni i Trenit - Perimore Mamurras

EMERTIMI I FLETES:
PLANIMETRIA PERGJITHSHME

APROVIMI I KLIENTIT:

PROJEKTUAR:

"A.SH. ENGINEERING" sh.pk



VENDNDODHJA : ROSKOVEC

SH.

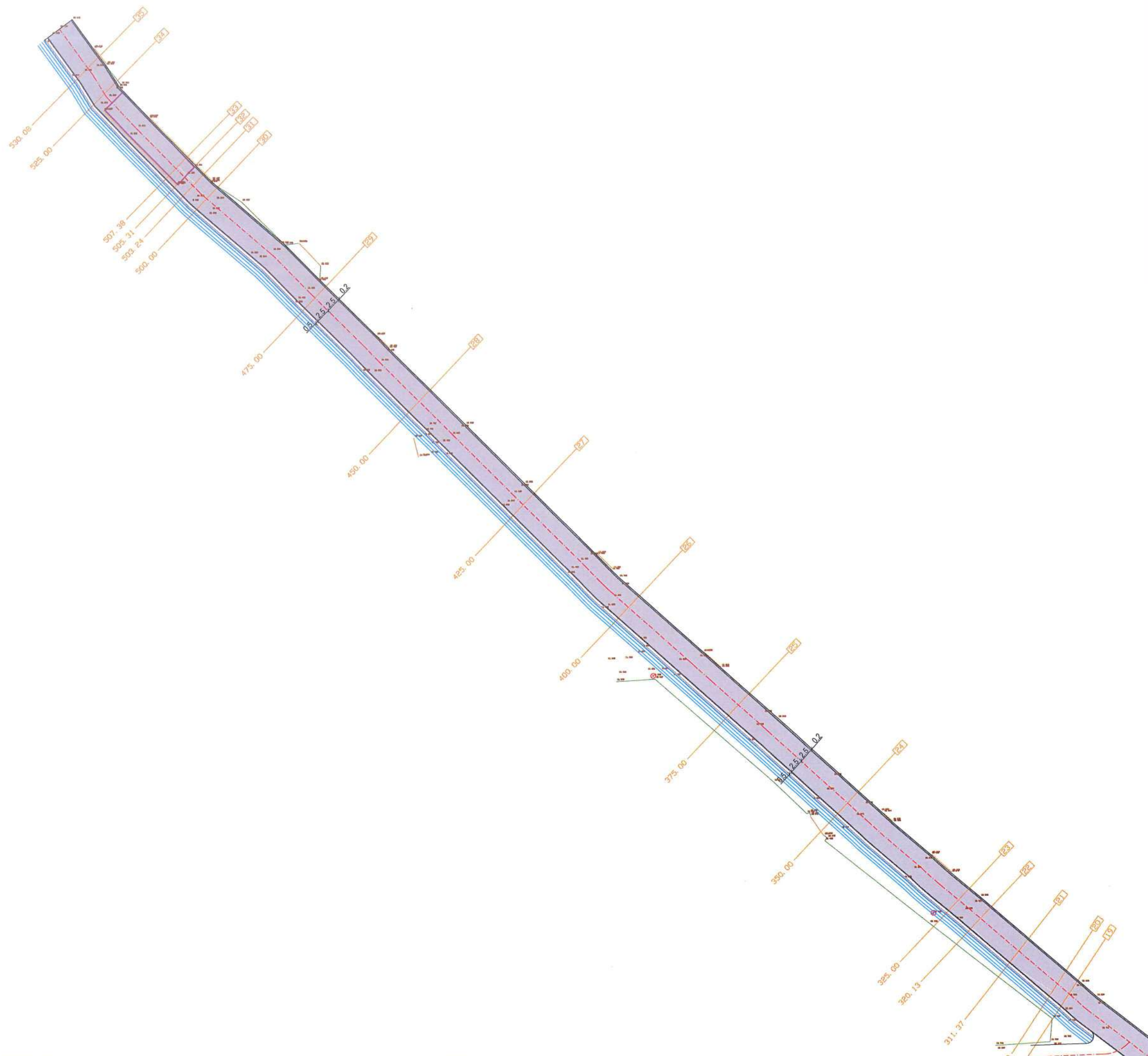

REPUBLIKA E SHQIPERISE



BASHKIA KURBIN



KLIENT: BASHKIA KURBIN

PROJEKT: Asfaltim Rruga Stacioni I Trenit - Perimore Mamurras

EMERTIMI I FLETES:
PLANIMETRIA PERGJITHSHME

APROVIMI I KLIENTIT:



PROJEKTUAR:

"A.S.H. ENGINEERING" sh.pk

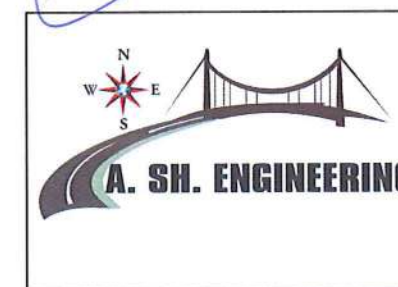

VENDNDODHJA : ROSKOVEC

SH.

PROFIL TIP

MENYRA E NDERTIMIT TE RRUGES "STACIONI I TRENIT"

SEKSIONI 1-4, 10-14

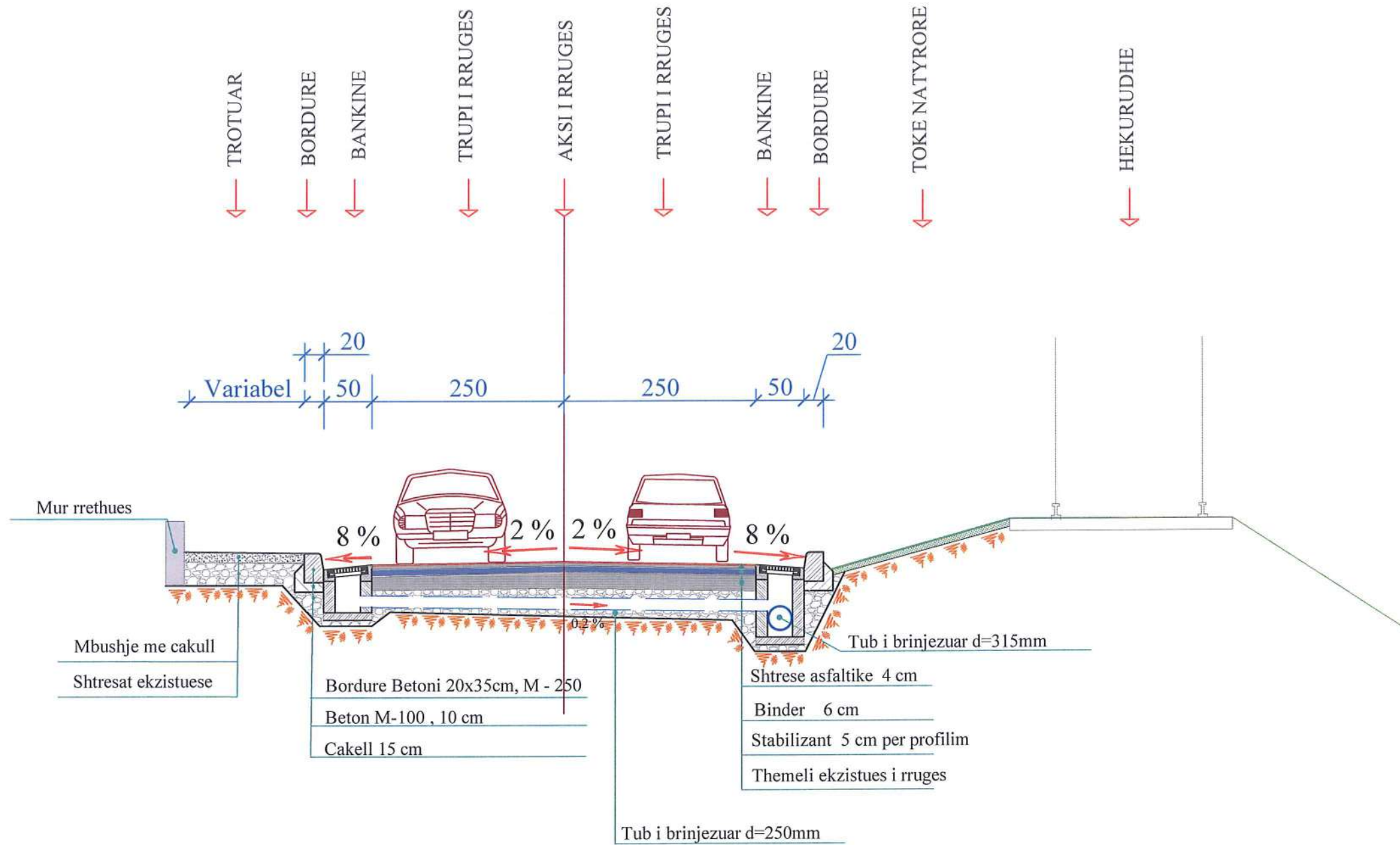

REPUBLIKA E SHQIPERISE



BASHKIA KURBIN



KLIENT: BASHKIA KURBIN

PROJEKT: Asfaltim Rruga Stacioni i Trenit -Perimore Mamurras

EMERTIMI I FLETES:

PROFIL TIP

APROVIMI I KLIENTIT:

PROJEKTUAR:

"A.SH. ENGINEERING" sh.pk



VENDNDODHJA : ROSKOVEC

SH.

PROFIL TIP

MENYRA E NDERTIMIT TE RRUGES "STACIONI I TRENIT"

SEKSIONI 5-9

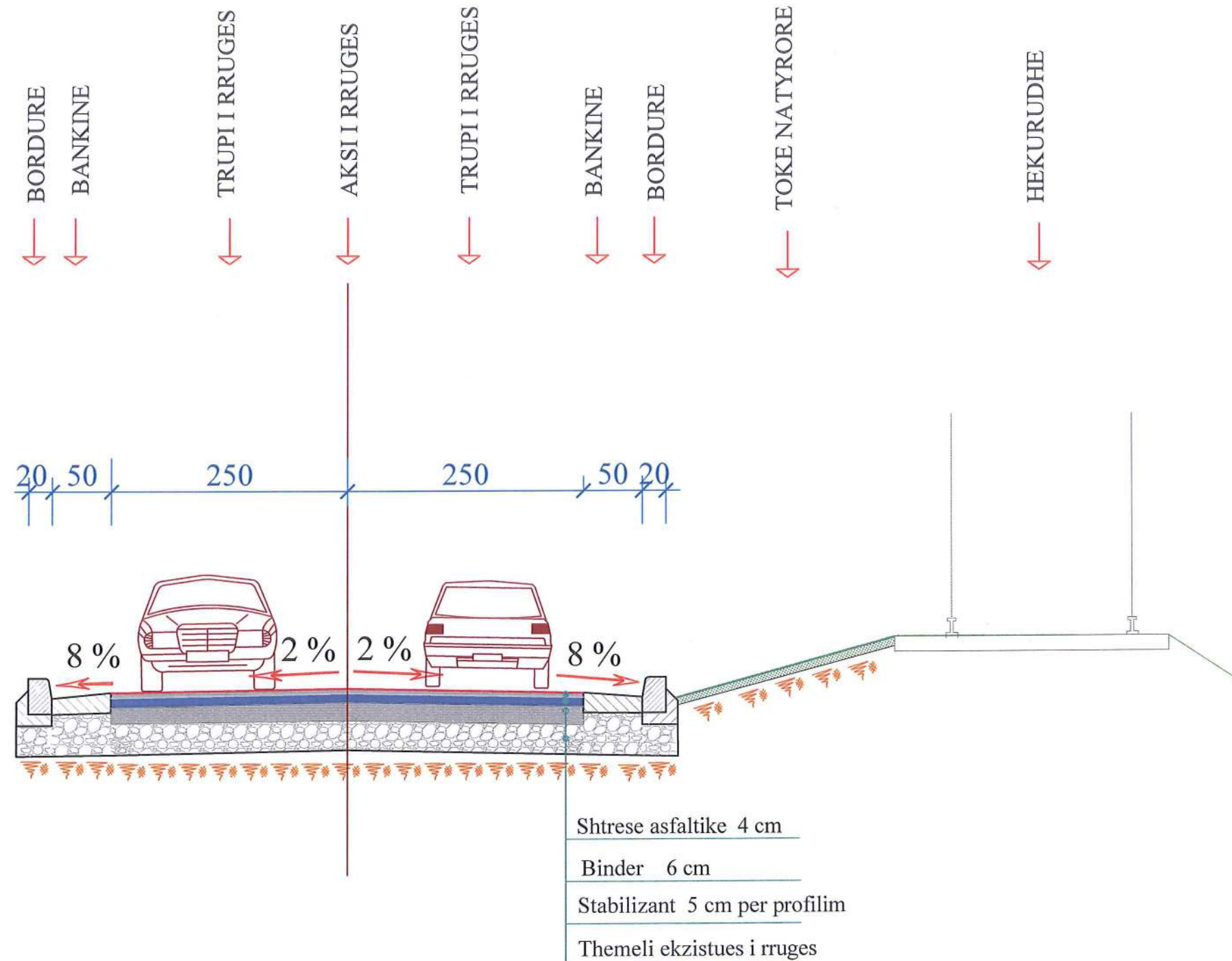

REPUBLIKA E SHQIPERISE



BASHKIA KURBIN



KLIENT: BASHKIA KURBIN

PROJEKT: Asfaltim Rruga Stacioni i Trenit - Perimore Mamurras

EMERTIMI I FLETES:

PROFIL TIP

APROVIMI I KLIENTIT:

PROJEKTUAR:

"A.SH. ENGINEERING" sh.pk

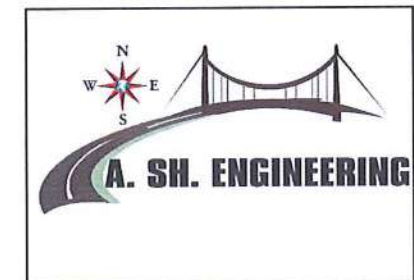

VENDNDODHJA : ROSKOVEC

SH.

PROFIL TIP

MENYRA E NDERTIMIT TE RRUGES "STACIONI I TRENIT"

SEKSIONI 16-18

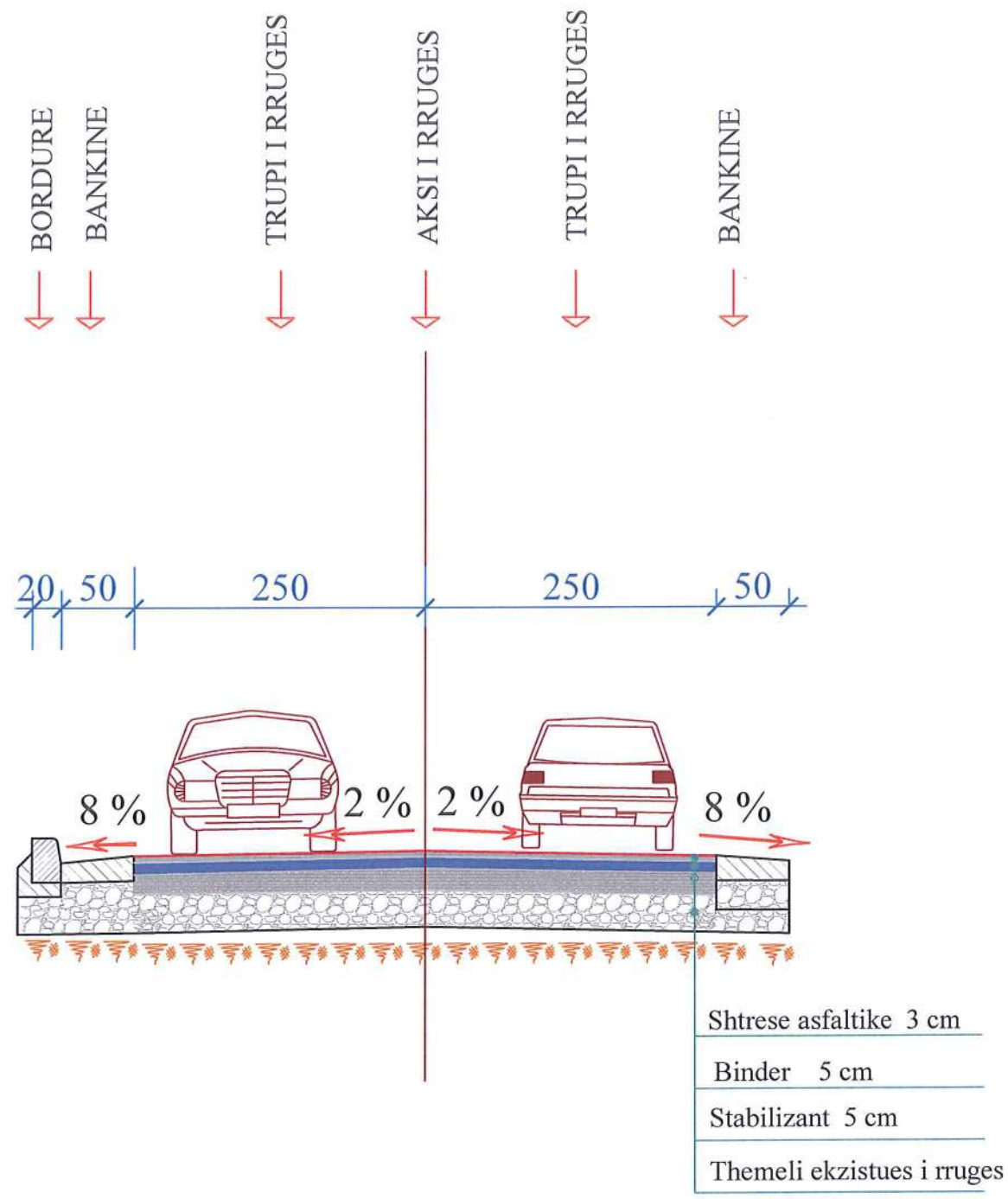

REPUBLIKA E SHQIPERISE



BASHKIA KURBIN



KLIENT: BASHKIA KURBIN

PROJEKT: Asfaltim Rruga Stacioni i Trenit - Perimore Mamurraz

EMERTIMI I FLETES:
PROFIL TIP

APROVIMI I KLIENIT:

PROJEKTUAR:

"A.SH. ENGINEERING" sh.pk



VENDNDODHJA : ROSKOVEC

SH.

PROFIL TIP

MENYRA E NDERTIMIT TE RRUGES "STACIONI I TRENIT"

SEKSIONI 19-35

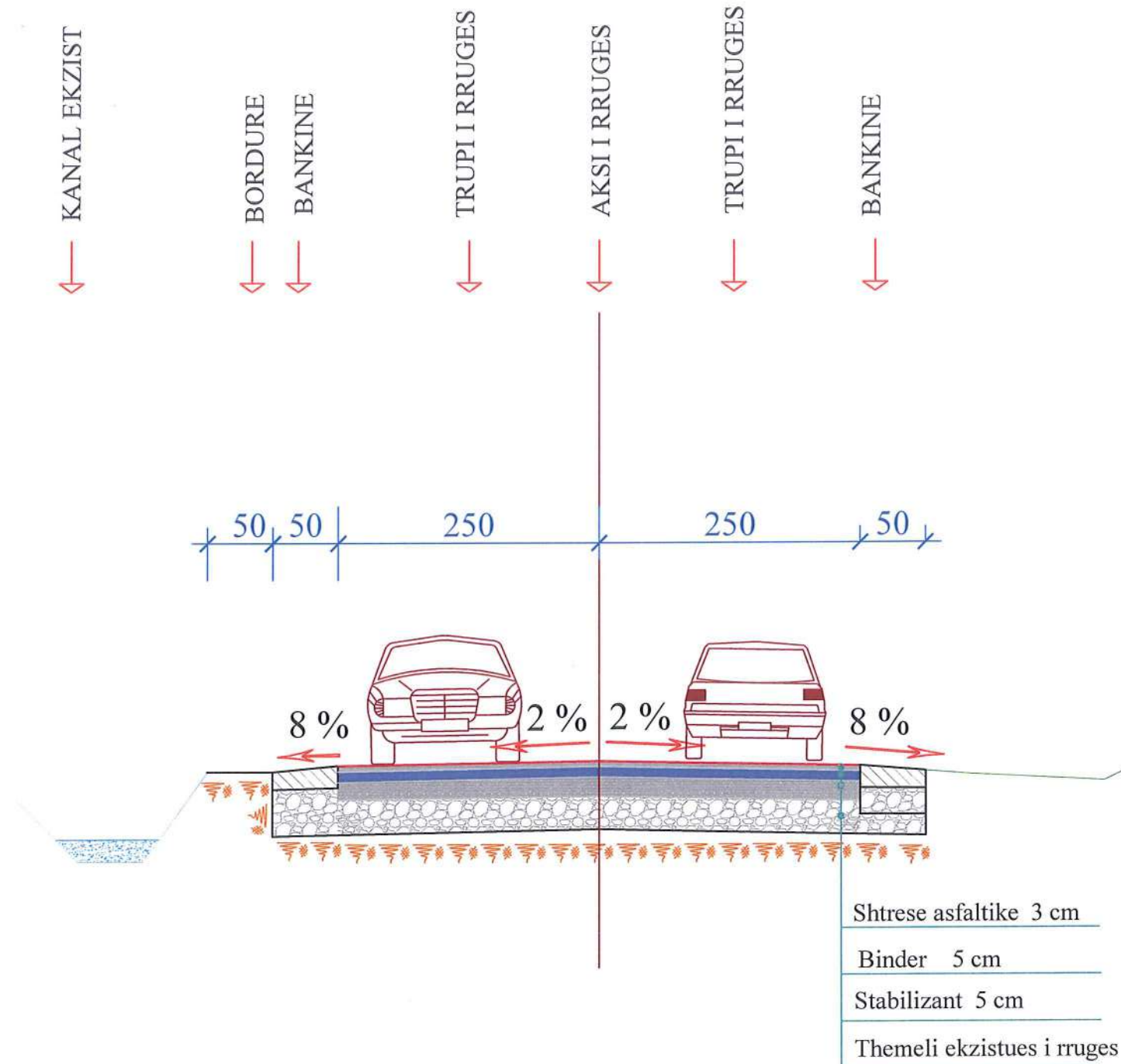

REPUBLIKA E SHQIPERISE



BASHKIA KURBIN



KLIENT: BASHKIA KURBIN

PROJEKT: Asfaltim Rruga Stacioni i Trenit - Perimore Mamuraz

EMERTIMI I FLETES:

PROFIL TIP

APROVIMI I KLIENTIT:

Signature and stamp of the engineering firm.

PROJEKTUAR:

"A.SH. ENGINEERING" sh.pk

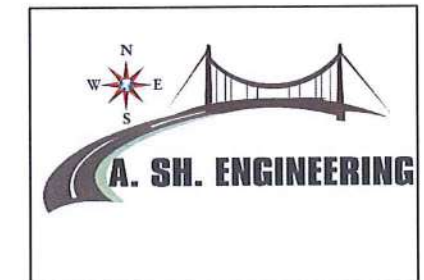

VENDNDODHJA : ROSKOVEC

SH.

PUSETE E UJRAVE TE SHIUT PER DN Ø250/Ø315 mm PE

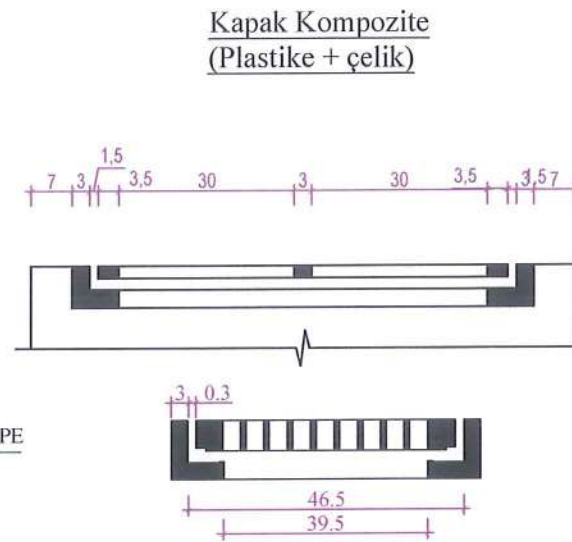
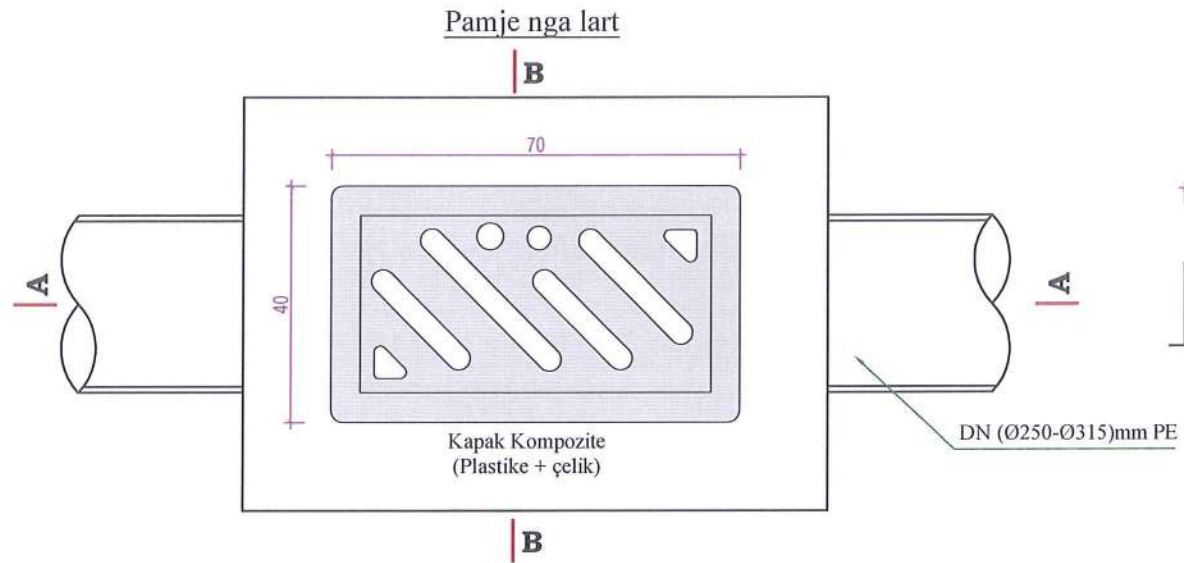

SHËNIME :

- 1.Muret e pusetes do te jene beton C16/20 dhe me trashesi 15cm.
- 2.Betoni qe do te perdoret per brezin duhet te jete C16/20, ndersa betoni i ullukut dhe shtreses do te jete C12/15.
- 3.Kapaku prej kompozite do te vendoset ne nivelin e mbaruar te rruges sipas projektit.
- 4.Fundi i tubit duhet te jete 10cm nga fundi i pusetes.
- 5.Diametri i tubit do te jete si ne planimetri.
6. Zgara metalike duhet te kete karakteristika qe te perballoje peshat e automjeteve deri 15 ton

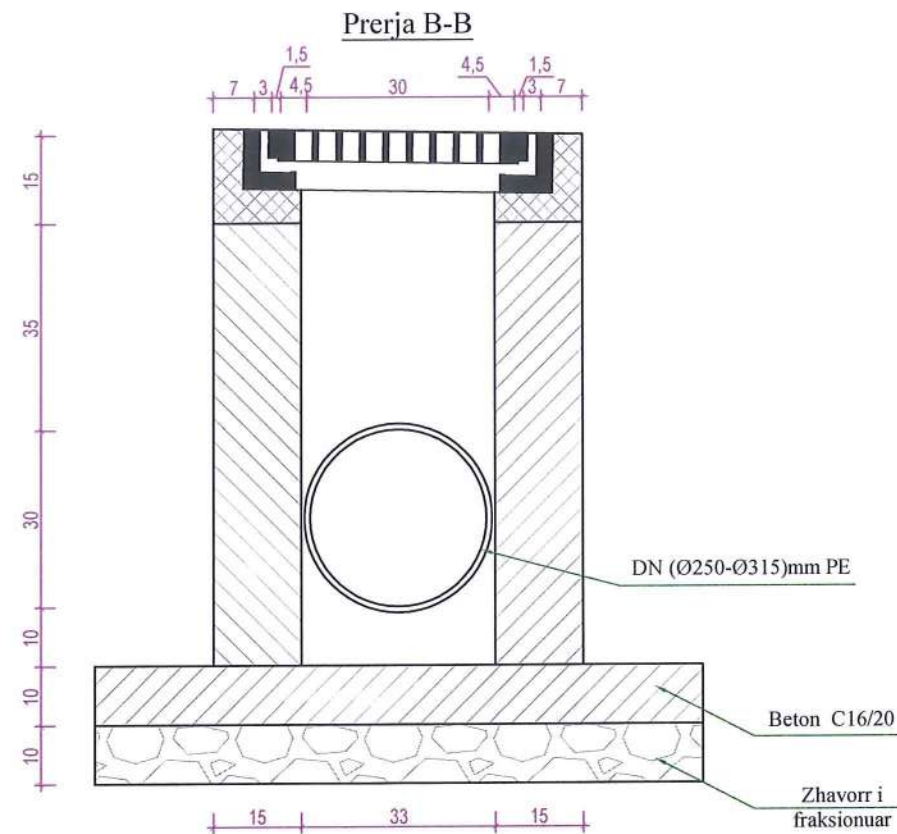
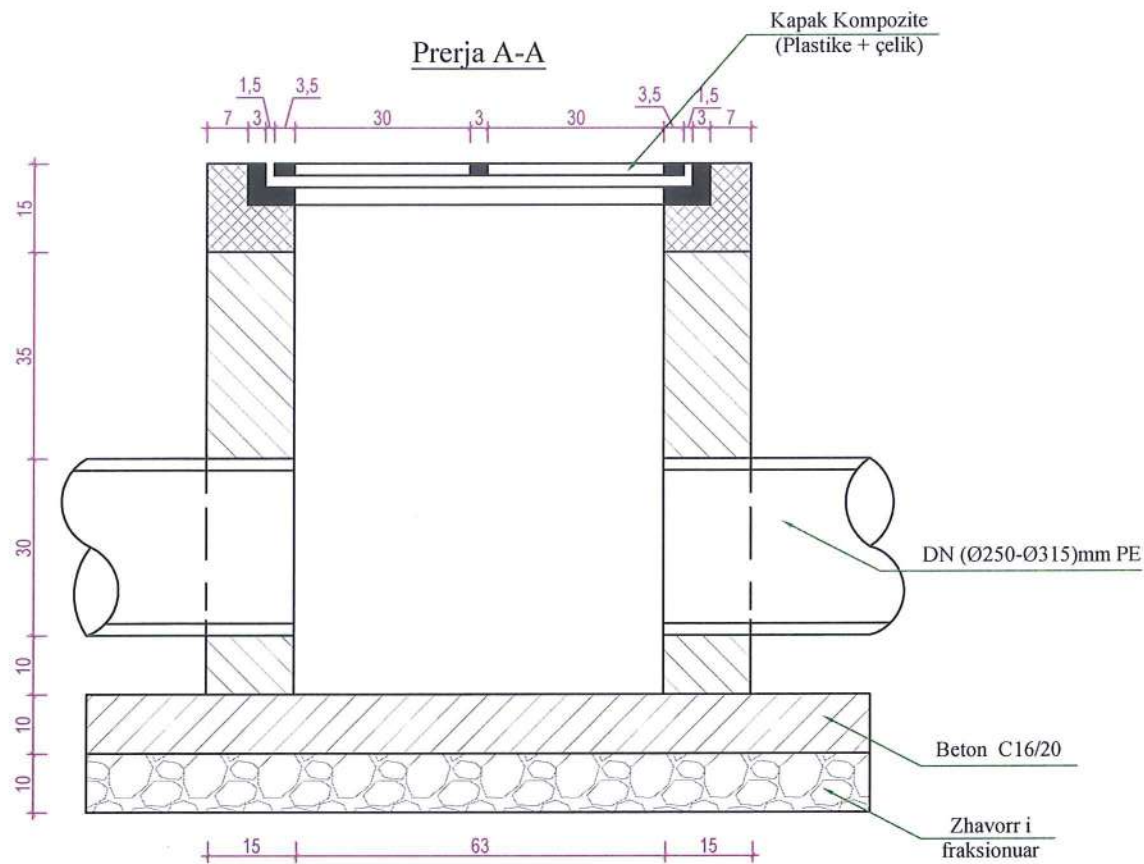

Fleta IX - 06

REPUBLIKA E SHQIPERISE



BASHKIA KURBIN



KLIENT: BASHKIA KURBIN

PROJEKT: Asfaltim Rruga Stacioni i Trenit -Perimore Mamuraz

EMERTIMI I FLETES:
 DETAJE PUSETA SHI MBLLEDHESHE

APROVIMI I KLIENTIT:

PROJEKTUAR: "A.SH. ENGINEERING" sh.pk

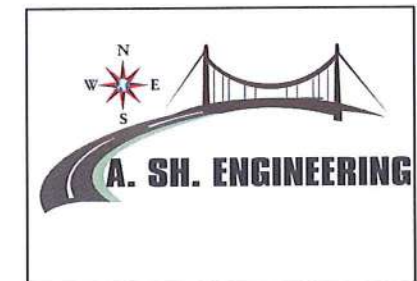

VENDNDODHJA : ROSKOVEC

SH.

PRERJE GJATESORE

REPUBLIKA E SHQIPERISE



BASHKIA KURBIN



KLIENT: BASHKIA KURBIN

PROJEKT: Asfaltim Rruga Stacioni i Trenit - Perimore Mamurras

EMERTIMI I FLETES:
PRERJE GJATESORE

APROVIMI I KLIENTIT:

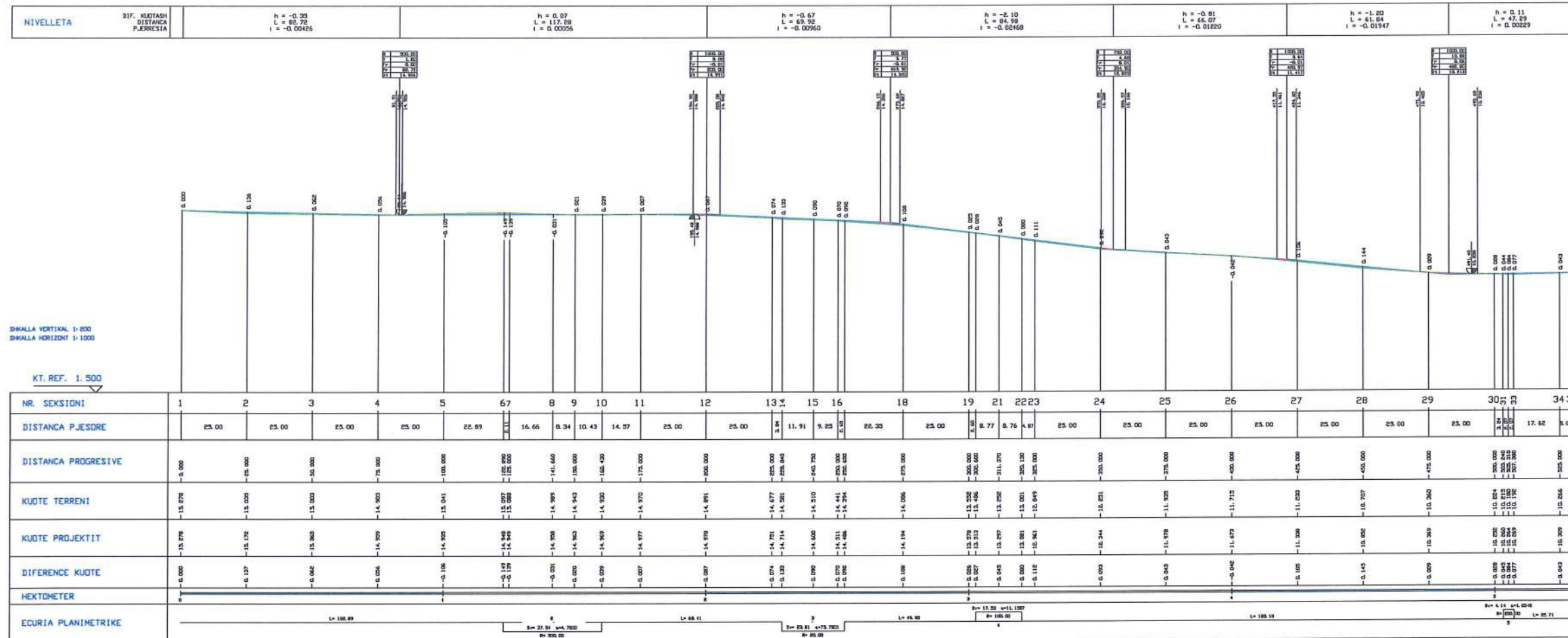

PROJEKTUAR: "A.SH. ENGINEERING" sh.pk



VENDNDODHJA : ROSKOVEC

SH.

PUNIME GERMIM-MBUSHJE	
GERMIM	2.176 mq
MBUSHJE	
MATERIAL MBUSHES	0.588 mq
PAKETA E SHTRESAVE	
SHTRESA E TAPETIT	5.000 m
SHTRESE STABILIZANTI	5.000 m
SHTRESE CAKULLI	1.286 mq
PUNIME VEPER ARTI	
BORDURA	0.239 mq

SEKSION N. : 3
 KT. PROJEKTI : 15.065
 DIST. PROG. : 50.00
 DIST. PARA. : 25.00
 DIST. PAS. : 25.00

SHKALLA 1:100

KT. REF. 11.000

KUOTE TERRENI	14.703	14.841	14.881	14.720	14.703	14.814	14.943	14.947	14.963	15.003	15.097	15.580	15.095	16.136	16.161	16.206	16.444
DIST. PJESORE TERRENI	3.412	0.962	0.317	0.248	1.087	1.942	0.612	0.390	1.381	3.260	2.143	2.177	0.211	1.341	0.695		
KUOTE PROJEKTI			14.718	15.173	15.095	15.153	15.153	15.153	15.153	14.710			15.095	15.153	15.153	15.153	15.153
DIST. PJESORE PROJEKTI			0.455	0.300	1.200	0.210	0.500	2.500	2.500				0.400	0.380	0.300		

PUNIME GERMIM-MBUSHJE	
GERMIM	2.369 mq
MBUSHJE	
MATERIAL MBUSHES	0.507 mq
PAKETA E SHTRESAVE	
SHTRESA E TAPETIT	5.000 m
SHTRESE STABILIZANTI	5.000 m
SHTRESE CAKULLI	1.286 mq
PUNIME VEPER ARTI	
BORDURA	0.239 mq

SEKSION N. : 4
 KT. PROJEKTI : 14.959
 DIST. PROG. : 75.00
 DIST. PARA. : 25.00
 DIST. PAS. : 25.00

SHKALLA 1:100

KT. REF. 11.000

KUOTE TERRENI	14.624	14.673	14.700	14.734	14.734	14.687	14.739	14.796	14.881	14.903	14.910	14.970	14.975	15.257	15.325	15.826	15.948	15.961	15.986	16.124	16.321	16.310
DIST. PJESORE TERRENI	0.704	0.265	0.292	0.167	1.962	1.277	2.562	2.023	0.749	0.235	1.898	1.270	0.163	1.973	0.906	0.665	0.883	0.408	0.525	0.927		
KUOTE PROJEKTI						14.743	15.066	15.066	15.066	15.066	14.604			14.896	14.896	14.896	14.896	14.896	14.896	14.896	14.896	14.896
DIST. PJESORE PROJEKTI						0.323	0.300	1.200	0.210	0.500	2.500	2.500		0.400	0.380	0.300	0.308					

REPUBLIKA E SHQIPERISE



BASHKIA KURBIN



KLIENT: BASHKIA KURBIN

PROJEKT: Asfaltim Rruge Stacioni i Trenit - Perimore Mamurras

EMERTIMI I FLETES:
 PRERJE TERTHORE

APROVIMI I KLIENTIT:



PROJEKTUAR:

"A. SH. ENGINEERING" sh.pk



VENDNDODHJA : ROSKOVEC

PUNIME GERMIM-MBUSHJE	
GERMIM	3.661 mq
MBUSHJE	
MATERIAL MBUSHES	0.376 mq
PAKETA E SHTRESAVE	
SHTRESA E TAPETIT	5.000 m
SHTRESE STABILIZANTI	5.000 m
SHTRESE ÇAKULLI	1.286 mq
PUNIME VEPEP ARTI	
BORDURA	0.217 mq

SEKSION N. : 5
 KT. PROJEKTI : 14.935
 DIST. PRDG. : 100.00
 DIST. PARA. : 25.00
 DIST. PAS. : 22.89

SHKALLA 1:100

KT. REF. 11.000

KUOTE TERRENI	14.518	14.561	14.672	14.998	15.014	15.029	15.041	15.044	15.050	15.180	15.192	15.253	15.755	15.792	15.829	15.831	15.791	15.986
DIST. PJESORE TERRENI	0.953	3.313	2.690	0.463	0.250	0.953	1.378	0.378	0.303	1.743	0.397	0.187	2.216	0.331	1.259	0.290	0.335	2.562
KUOTE PROJEKTI				0.300	0.210	0.500	0.300	0.300	0.300	14.580	0.400	0.380	0.300	0.447	0.300	0.300	0.300	0.300
DIST. PJESORE PROJEKTIT				0.300	0.210	0.500	0.300	0.300	0.300	2.500	0.400	0.380	0.300	0.447	0.300	0.300	0.300	0.300

PUNIME GERMIM-MBUSHJE	
GERMIM	3.908 mq
MBUSHJE	
MATERIAL MBUSHES	0.370 mq
PAKETA E SHTRESAVE	
SHTRESA E TAPETIT	5.000 m
SHTRESE STABILIZANTI	5.000 m
SHTRESE ÇAKULLI	1.286 mq
PUNIME VEPEP ARTI	
BORDURA	0.217 mq

SEKSION N. : 6
 KT. PROJEKTI : 14.948
 DIST. PRDG. : 122.89
 DIST. PARA. : 22.89
 DIST. PAS. : 2.11

SHKALLA 1:100

KT. REF. 11.000

KUOTE TERRENI	14.621	14.633	14.697	14.884	14.979	15.049	15.042	15.044	15.068	15.097	15.156	15.512	15.625	15.701	15.722	15.729	15.616	15.762
DIST. PJESORE TERRENI	0.277	1.898	1.541	2.804	0.915	0.244	0.448	0.657	1.215	2.421	1.113	0.411	0.672	0.732	0.818	0.946	1.908	
KUOTE PROJEKTI					0.300	0.210	0.500	0.300	0.300	14.593	0.400	0.380	0.300	0.411	0.300	0.300	0.300	0.300
DIST. PJESORE PROJEKTIT					0.300	0.210	0.500	0.300	0.300	2.500	0.400	0.380	0.300	0.411	0.300	0.300	0.300	0.300

REPUBLIKA E SHQIPERISE



BASHKIA KURBIN



KLIENT: BASHKIA KURBIN

PROJEKT: Asfaltim Rruga Stacioni i Trenit - Perimore Mamurras

EMERTIMI I FLETES:
 PRERJE TERTHORE

APROVIMI I KLIENIT:



PROJEKTUAR:

"A.SH. ENGINEERING" sh.pk

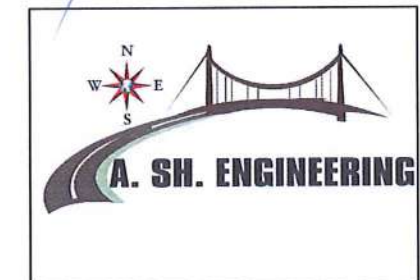

VENDNDODHJA : ROSKOVEC

PUNIME GERMIM-MBUSHJE	
GERMIM	3.509 mq
MBUSHJE	
MATERIAL MBUSHES	0.356 mq
PAKETA E SHTRESAVE	
SHTRESA E TAPETIT	5.000 m
SHTRESE STABILIZANTI	5.000 m
SHTRESE CAKULLI	1.289 mq
PUNIME VEPER ARTI	
BORDURA	0.217 mq

SEKSION N. : 7
 KT. PROJEKTI : 14.949
 DIST. PROG. : 125.00
 DIST. PARA. : 2.11
 DIST. PAS. : 16.66

SHKALLA 1:100

KT. REF. 11.000

KUOTE TERRENI	14.630	14.639	14.699	14.873	14.976	15.040	15.031	15.033	15.066	15.088	15.145	15.466	15.622	15.692	15.712	15.719	15.600	15.736
DIST. PJESORE TERRENI	0.281	1.769	1.436	3.016	0.844	0.320	0.588	0.863	0.943	2.336	1.003	0.568	0.627	0.683	0.867	1.003	1.787	
KUOTE PROJEKTI					14.976	15.040	15.031	15.033	15.066	15.088	15.145	15.466	15.622	15.692	15.712	15.719	15.600	15.736
DIST. PJESORE PROJEKTI					0.300	0.210	0.500	2.500	2.500	0.400	0.380	0.300	0.469					

PUNIME GERMIM-MBUSHJE	
GERMIM	2.936 mq
MBUSHJE	
MATERIAL MBUSHES	0.367 mq
PAKETA E SHTRESAVE	
SHTRESA E TAPETIT	5.000 m
SHTRESE STABILIZANTI	5.000 m
SHTRESE CAKULLI	1.289 mq
PUNIME VEPER ARTI	
BORDURA	0.217 mq

SEKSION N. : 8
 KT. PROJEKTI : 14.958
 DIST. PROG. : 141.66
 DIST. PARA. : 16.66
 DIST. PAS. : 8.34

SHKALLA 1:100

KT. REF. 11.000

KUOTE TERRENI	14.688	14.717	14.791	14.951	14.973	14.946	14.953	14.989	15.046	15.057	15.595	15.625	15.634	15.644	15.470	15.534
DIST. PJESORE TERRENI	0.759	0.613	4.686	0.287	0.919	1.693	0.963	1.535	0.451	1.800	0.272	0.296	1.253	1.453	0.838	
KUOTE PROJEKTI				14.946	14.953	14.953	14.989	15.046	15.057	15.595	15.625	15.634	15.644	15.470	15.534	
DIST. PJESORE PROJEKTI				0.300	0.210	0.500	2.500	2.500	0.400	0.380	0.300	0.456				

REPUBLIKA E SHQIPERISE



BASHKIA KURBIN



KLIENT: BASHKIA KURBIN

PROJEKT: Asfaltim Rruga Stacioni i Trenit - Perimore Mamurras

EMERTIMI I FLETES:
 PRERJE TERTHORE

APROVIMI I KLIENIT:



PROJEKTUAR

"A.S.H. ENGINEERING" sh.pk

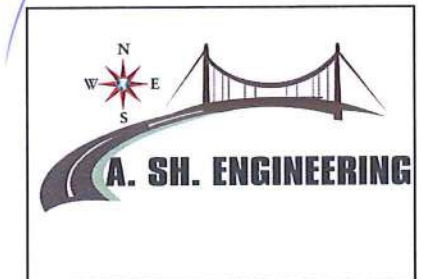

VENDNDODHJA : ROSKOVEC

PUNIME GERMIM-MBUSHJE	
GERMIM	2.979 mq
MBUSHJE	
MATERIAL MBUSHES	0.421 mq
PAKETA E SHTRESAVE	
SHTRESA E TAPETIT	5.000 m
SHTRESE STABILIZANTI	5.000 m
SHTRESE ÇAKULLI	1.286 mq
PUNIME VEPER ARTI	
BORDURA	0.239 mq

SEKSION N. : 11
 KT. PROJEKTI : 14.977
 DIST. PRDG. : 175.00
 DIST. PARA. : 14.57
 DIST. PAS. : 25.00

SHKALLA 1:100

KT. REF. 11.000

KUOTE TERRENI	14.743	14.816	14.809	14.872	14.893	14.905	14.963	14.970	15.010	15.334	15.439	15.458	15.460	15.425	15.371
DIST. PJESORE TERRENI	0.761	0.376	1.900	0.461	1.330	4.905	0.268	0.254	0.236	3.897	0.598	1.347	0.228	0.295	1.330
KUOTE PROJEKTI							14.907	14.917	14.925	14.622	14.933	14.748	14.748	14.917	15.060
DIST. PJESORE PROJEKTI							0.177	0.300	1.200	2.500	0.400	0.320	0.300	0.215	2.500

PUNIME GERMIM-MBUSHJE	
GERMIM	2.168 mq
MBUSHJE	
MATERIAL MBUSHES	0.459 mq
PAKETA E SHTRESAVE	
SHTRESA E TAPETIT	5.000 m
SHTRESE STABILIZANTI	5.000 m
SHTRESE ÇAKULLI	1.286 mq
PUNIME VEPER ARTI	
BORDURA	0.239 mq

SEKSION N. : 12
 KT. PROJEKTI : 14.978
 DIST. PRDG. : 200.00
 DIST. PARA. : 25.00
 DIST. PAS. : 25.00

SHKALLA 1:100

KT. REF. 11.000

KUOTE TERRENI	14.536	14.529	14.735	14.740	14.826	14.829	14.837	14.854	14.868	14.879	14.891	14.950	15.174	15.232	15.415	15.454	15.457	15.449	15.350
DIST. PJESORE TERRENI	0.628	0.483	2.684	0.264	0.671	2.023	2.402	0.333	0.442	2.162	1.564	0.649	1.257	1.373	0.203	0.206	0.992		
KUOTE PROJEKTI					14.838	14.838	14.838	14.838	14.838	14.623	14.838	14.916	14.766	14.766	14.916	14.916	14.916	14.916	14.916
DIST. PJESORE PROJEKTI					0.247	0.300	1.200	0.210	0.500	2.500	2.500	0.400	0.320	0.300	0.215	2.500			

REPUBLIKA E SHQIPERISE



BASHKIA KURBIN



KLIENT: BASHKIA KURBIN

PROJEKT: Asfaltim Rruge Stacioni i Trenit - Perimore Mamurrez

EMERTIMI I FLETES:
 PRERJE TERTHORE

APROVIMI I KLIENTIT:



PROJEKTUAR:

"A.SH. ENGINEERING" sh.pk

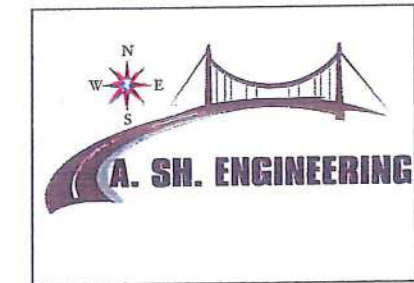

VENDNDODHJA : ROSKOVEC

PUNIME GERMIM-MBUSHJE	
GERMIM	2.150 mq
MBUSHJE	
MATERIAL MBUSHES	0.432 mq
PAKETA E SHTRESAVE	
SHTRESA E TAPETIT	5.000 m
SHTRESE STABILIZANTI	5.000 m
SHTRESE CAKULLI	1.286 mq
PUNIME VEPER ARTI	
BORDURA	0.239 mq

SEKSION N. : 13
 KT. PROJEKTI : 14.751
 DIST. PRG. : 225.00
 DIST. PARA. : 25.00
 DIST. PAS. : 3.84

SHKALLA 1:100

KT. REF. 11.000

KUOTE TERRENI	14.588	14.633	14.681	14.652	14.636	14.610	14.605	14.657	14.677	14.745	15.149	15.232	15.356	15.370	15.398	15.455	15.322
DIST. PJESORE TERRENI	3.616	0.278	1.890	0.873	1.136	0.631	0.778	0.799	2.693	1.722	0.760	0.438	0.190	0.190	1.403	1.035	0.134
KUOTE PROJEKTI			14.664	14.858	14.898	14.898	14.898	14.898	14.898	14.898	14.396	14.688	14.588	14.570	14.588	14.588	14.588
DIST. PJESORE PROJEKTIT			0.134	0.300	1.200	0.210	0.500	2.500	2.500	0.400	0.320	0.300	0.134	0.134	0.134	0.134	0.134

PUNIME GERMIM-MBUSHJE	
GERMIM	2.107 mq
MBUSHJE	
MATERIAL MBUSHES	0.439 mq
PAKETA E SHTRESAVE	
SHTRESA E TAPETIT	5.000 m
SHTRESE STABILIZANTI	5.000 m
SHTRESE CAKULLI	1.286 mq
PUNIME VEPER ARTI	
BORDURA	0.239 mq

SEKSION N. : 14
 KT. PROJEKTI : 14.714
 DIST. PRG. : 228.84
 DIST. PARA. : 3.84
 DIST. PAS. : 11.91

SHKALLA 1:100

KT. REF. 11.000

KUOTE TERRENI	14.525	14.566	14.569	14.570	14.541	14.646	14.634	14.558	14.546	14.564	14.581	14.613	14.712	14.720	14.912	15.274	15.364	15.388	15.450	15.319
DIST. PJESORE TERRENI	3.296	0.166	0.404	0.195	3.269	1.636	0.570	0.304	0.557	1.467	0.318	0.823	1.598	0.848	0.181	1.546	1.129	0.134	0.134	0.134
KUOTE PROJEKTI		14.616	14.822	14.822	14.822	14.802	14.802	14.802	14.802	14.802	14.359	14.652	14.572	14.572	14.572	14.572	14.572	14.572	14.572	14.572
DIST. PJESORE PROJEKTIT		0.205	0.300	1.200	0.210	0.500	2.500	2.500	0.400	0.320	0.300	0.247	0.400	0.320	0.300	0.247	0.400	0.320	0.300	0.247

REPUBLIKA E SHQIPERISE



BASHKIA KURBIN



KLIENT: BASHKIA KURBIN

PROJEKT: Asfaltim Rruga Stacioni i Trenit - Perimore Mamurras

EMERTIMI I FLETES:
 PRERJE TERTHORE

APROVIMI I KLIENIT:



PROJEKTUAR:
 "A.SH. ENGINEERING" sh.pk

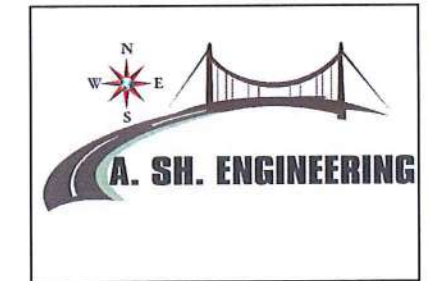

VENDNDODHJA : ROSKOVEC

PUNIME GERMIM-MBUSHJE	
GERMIM	1.910 mq
MBUSHJE	
MATERIAL MBUSHES	0.373 mq
PAKETA E SHTRESAVE	
SHTRESA E TAPETIT	5.000 m
SHTRESE STABILIZANTI	5.000 m
SHTRESE CAKULLI	1.241 mq
PUNIME VEPER ARTI	
BORDURA	0.153 mq

SEKSION N. : 15
 KT. PROJEKTI : 14.600
 DIST. PRG. : 240.75
 DIST. PARA. : 11.91
 DIST. PAS. : 9.25

SHKALLA 1:100

KT. REF. 10.000

KUOTE TERRENI	14.459	14.478	14.499	14.427	14.438	14.403	14.473	14.510	14.548	14.590	14.603	14.832	15.243	15.221	15.240
DIST. PJESORE TERRENI	1.598	1.764	1.870	0.338	2.463	1.895	1.939	0.745	1.431	2.231	2.754	0.508	0.391		
KUOTE PROJEKTI															
DIST. PJESORE PROJEKTIT															

PUNIME GERMIM-MBUSHJE	
GERMIM	2.038 mq
MBUSHJE	
MATERIAL MBUSHES	0.358 mq
PAKETA E SHTRESAVE	
SHTRESA E TAPETIT	5.000 m
SHTRESE STABILIZANTI	5.000 m
SHTRESE CAKULLI	1.241 mq
PUNIME VEPER ARTI	
BORDURA	0.153 mq

SEKSION N. : 16
 KT. PROJEKTI : 14.511
 DIST. PRG. : 250.00
 DIST. PARA. : 9.25
 DIST. PAS. : 2.65

SHKALLA 1:100

KT. REF. 10.000

KUOTE TERRENI	14.390	14.407	14.411	14.364	14.381	14.452	14.441	14.432	14.434	14.432	14.411	14.630
DIST. PJESORE TERRENI	3.359	0.966	1.135	0.604	0.427	3.509	2.807	0.348	0.127	1.867	4.852	
KUOTE PROJEKTI												
DIST. PJESORE PROJEKTIT												

REPUBLIKA E SHQIPERISE



BASHKIA KURBIN



KLIENT: BASHKIA KURBIN

PROJEKT: Asfaltim Rruga Stacioni i Trenit - Perimore Mamurras

EMERTIMI I FLETES:
 PRERJE TERTHORE

APROVIMI I KLIENTIT:



PROJEKTUAR:

"A.SH. ENGINEERING" sh.pk

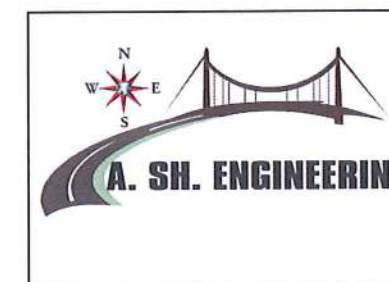

VENDNDODHJA : ROSKOVEC

PUNIME GERMIM-MBUSHJE	
GERMIM	1.898 mq
MBUSHJE	
MATERIAL MBUSHES	0.379 mq
PAKETA E SHTRESAVE	
SHTRESA E TAPETIT	5.000 m
SHTRESE STABILIZANTI	5.000 m
SHTRESE ÇAKULLI	1.241 mq
PUNIME VEPER ARTI	
BORDURA	0.153 mq

SEKSION N. : 17
 KT. PROJEKTI : 14.486
 DIST. PRG. : 252.65
 DIST. PARA. : 2.65
 DIST. PAS. : 22.35

SHKALLA 1:100

KT. REF. 10.000

KUOTE TERRENI	14.367		14.380	14.382	14.351	14.375	14.382	14.379		14.394		14.411		14.371	14.366	14.405		14.500	
DIST. PJESORE TERRENI		4.598		0.662	0.736	0.849	0.508			2.601		3.018		2.995	0.381	0.942		2.664	
KUOTE PROJEKTI							14.362	14.351	14.382	14.131		14.351	14.382	14.379					
DIST. PJESORE PROJEKTI							0.300	0.210	0.500	2.500		2.500		0.350	0.130	0.300			

PUNIME GERMIM-MBUSHJE	
GERMIM	1.641 mq
MBUSHJE	
MATERIAL MBUSHES	0.466 mq
PAKETA E SHTRESAVE	
SHTRESA E TAPETIT	5.000 m
SHTRESE STABILIZANTI	5.000 m
SHTRESE ÇAKULLI	1.240 mq
PUNIME VEPER ARTI	
BORDURA	0.153 mq

SEKSION N. : 18
 KT. PROJEKTI : 14.194
 DIST. PRG. : 275.00
 DIST. PARA. : 22.35
 DIST. PAS. : 25.00

SHKALLA 1:100

KT. REF. 10.000

KUOTE TERRENI	13.981	13.985		14.098	14.085	14.078	14.080	14.081		14.086	14.089	13.904	13.917	13.893	13.817	13.650	13.570	13.584	13.588		13.936
DIST. PJESORE TERRENI		1.328		4.626		0.741	0.290	0.346		2.567	1.456	1.269	0.193	1.266	1.548	0.989	0.386			2.750	
KUOTE PROJEKTI							14.098	14.085	14.078	13.839		14.132	13.917	13.893	13.817						
DIST. PJESORE PROJEKTI							0.190	0.300	0.210	2.500		2.500		0.350	0.130	0.300					

REPUBLIKA E SHQIPERISE



BASHKIA KURBIN



KLIENT: BASHKIA KURBIN

PROJEKT: Asfaltim Rruga Stacioni i Trenit - Perimore Mamuraz

EMERTIMI I FLETES:
 PRERJE TERTHORE

APROVIMI I KLIENTIT:

PROJEKTUAR:



"A.S.H. ENGINEERING" sh.pk



VENDNDODHJA : ROSKOVEC

PUNIME GERMIM-MBUSHJE	
GERMIM	3.080 mq
MBUSHJE	
MATERIAL MBUSHES	0.260 mq
PAKETA E SHTRESAVE	
SHTRESA E TAPETIT	5.000 m
SHTRESE STABILIZANTI	5.000 m
SHTRESE ÇAKULLI	1.198 mq
PUNIME VEPEP ARTI	
BORDURA	0.092 mq

SEKSION N. : 19
 KT. PROJEKTI : 13.578
 DIST. PRG. : 300.00
 DIST. PARA. : 25.00
 DIST. PAS. : 2.60

SHKALLA 1:100

KT. REF. 9.000

KUOTE TERRENI	13.584	13.592	13.646		13.661	13.231	13.091	13.491	13.661		13.588	13.552	13.522	13.580	13.579	13.633		13.182	13.148		13.482	13.513	
DIST. PJESORE TERRENI	0.443	0.686	3.462		1.011	0.390	0.410	0.410	2.019		1.467	0.788	1.982	1.132	2.713	0.398	2.641		0.278	0.278		0.278	0.278
KUOTE PROJEKTI					13.671	13.235	12.735	12.735	13.485	13.522	13.223		13.515	13.425	13.425	13.425	13.425		13.425	13.425		13.425	13.425
DIST. PJESORE PROJEKTI					0.436	0.500	0.500	0.500	0.500	0.440	2.500		2.500	0.350	0.300	0.300	0.300		0.300	0.300		0.300	0.300

PUNIME GERMIM-MBUSHJE	
GERMIM	2.959 mq
MBUSHJE	
MATERIAL MBUSHES	0.295 mq
PAKETA E SHTRESAVE	
SHTRESA E TAPETIT	5.000 m
SHTRESE STABILIZANTI	5.000 m
SHTRESE ÇAKULLI	1.198 mq
PUNIME VEPEP ARTI	
BORDURA	0.092 mq

SEKSION N. : 20
 KT. PROJEKTI : 13.513
 DIST. PRG. : 302.60
 DIST. PARA. : 2.60
 DIST. PAS. : 8.77

SHKALLA 1:100

KT. REF. 9.000

KUOTE TERRENI	13.556	13.561	13.561	13.281	13.515	13.486	13.465	13.458	13.461	13.503	13.497	13.544	13.147	13.109	13.412	13.466
DIST. PJESORE TERRENI	2.157	2.725	0.891	3.041	1.186	0.816	0.276	0.253	1.748	0.197	0.996	2.388	0.444	2.397	0.484	0.484
KUOTE PROJEKTI			13.592	13.171	12.671	12.671	13.421	13.421	13.421	13.421	13.421	13.421	13.421	13.421	13.421	13.421
DIST. PJESORE PROJEKTI			0.421	0.500	0.500	0.500	0.500	0.440	2.500		2.500	0.350	0.300	0.300	0.300	0.300

REPUBLIKA E SHQIPERISE



BASHKIA KURBIN



KLIENT: BASHKIA KURBIN

PROJEKT: Asfaltim Rruga Stacioni i Trenit -Perimore Mamurras

EMERTIMI I FLETES:
 PRERJE TERTHORE

APROVIMI I KLIENTIT:



PROJEKTUAR:

"A.SH. ENGINEERING" sh.pk

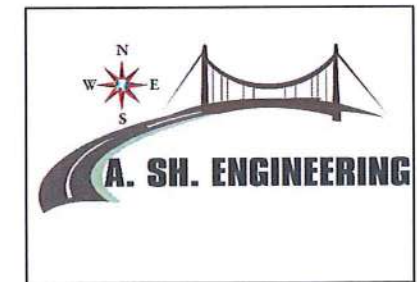

VENDNDODHJA : ROSKOVEC

PUNIME GERMIM-MBUSHJE	
GERMIM	2.617 mq
MBUSHJE	
MATERIAL MBUSHES	0.260 mq
PAKETA E SHTRESAVE	
SHTRESA E TAPETIT	5.000 m
SHTRESE STABILIZANTI	5.000 m
SHTRESE ÇAKULLI	1.198 mq
PUNIME VEPER ARTI	
BORDURA	0.092 mq

SEKSION N. : 21
 KT. PROJEKTI : 13.297
 DIST. PRG. : 311.37
 DIST. PARA. : 8.77
 DIST. PAS. : 8.76

SHKALLA 1:100

KT. REF. 9.000

KUOTE TERRENI	13.318		13.386	13.072	13.391		13.266	13.252	13.240	13.214	13.225	13.251	13.231	13.259	13.036	12.987	13.197	13.284	13.265
DIST. PJESORE TERRENI		4.830	0.891	1.034	2.624	0.620	0.528	1.114	1.006	0.976	0.757	0.556	1.353	0.589	1.648	0.772	0.702		
KUOTE PROJEKTI			13.385 13.115	12.615	12.615	13.365 13.365 13.365 13.365 13.365 13.365 13.365 13.365 13.365 13.365	12.942				13.199 13.119 13.059 13.054 13.059 13.059 13.054								
DIST. PJESORE PROJEKTIT			0.269 0.500	0.500	0.500	0.500 0.440	2.500	2.500			0.350 0.130 0.300								

PUNIME GERMIM-MBUSHJE	
GERMIM	2.459 mq
MBUSHJE	
MATERIAL MBUSHES	0.254 mq
PAKETA E SHTRESAVE	
SHTRESA E TAPETIT	5.000 m
SHTRESE STABILIZANTI	5.000 m
SHTRESE ÇAKULLI	1.198 mq
PUNIME VEPER ARTI	
BORDURA	0.092 mq

SEKSION N. : 22
 KT. PROJEKTI : 13.081
 DIST. PRG. : 320.13
 DIST. PARA. : 8.76
 DIST. PAS. : 4.87

SHKALLA 1:100

KT. REF. 8.000

KUOTE TERRENI	13.095		13.176	12.757	13.211		13.027	13.018	13.012	13.001	12.970	12.994	13.001	12.993	12.925	12.864	12.976	13.075	13.036	13.083	
DIST. PJESORE TERRENI		4.777	1.048	0.308	2.732	0.303	0.296	0.535	1.434	1.749	0.229	1.311	0.129	0.319	0.743	0.880	0.881	1.596	0.730		
KUOTE PROJEKTI			13.187 12.899	12.399	12.399	13.149 13.149 13.149 13.149 13.149 13.149 13.149 13.149 13.149 13.149	12.756				12.902 12.902 12.902 12.902 12.902 12.902 12.902 12.902 12.902 12.902										
DIST. PJESORE PROJEKTIT			0.288 0.500	0.500	0.500	0.500 0.440	2.500	2.500			0.350 0.130 0.300										

REPUBLIKA E SHQIPERISE



BASHKIA KURBIN



KLIENT: BASHKIA KURBIN

PROJEKT: Asfaltim Rruga Stacioni i Trenit - Perimore Mamurras

EMERTIMI I FLETES:
 PRERJE TERTHORE

APROVIMI I KLIENTIT:



PROJEKTUAR:
 "A. SH. ENGINEERING" sh.pk

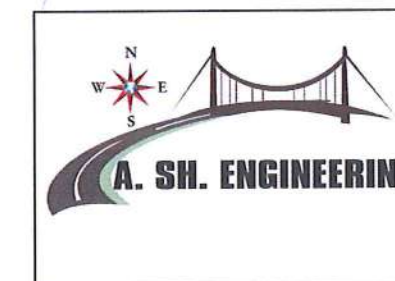

VENDNDODHJA : ROSKOVEC

PUNIME GERMIM-MBUSHJE	
GERMIM	2.845 mq
MBUSHJE	
MATERIAL MBUSHES	0.260 mq
PAKETA E SHTRESAVE	
SHTRESA E TAPETIT	5.000 m
SHTRESE STABILIZANTI	5.000 m
SHTRESE CAKULLI	1.198 mq
PUNIME VEPER ARTI	
BORDURA	0.092 mq

SEKSION N. : 25
 KT. PROJEKTI : 11.978
 DIST. PRG. : 375.00
 DIST. PARA. : 25.00
 DIST. PAS. : 25.00

SHKALLA 1:100

KT. REF. 7.000

KUOTE TERRENI	12.188	12.169	12.177	12.158	11.494	11.936	11.933	11.934	11.935	11.964	11.955	11.955	11.927	11.968
DIST. PJESORE TERRENI	0.545	1.538	2.446	0.936	0.885	1.832	1.784	1.761	0.421	0.563	0.981			
KUOTE PROJEKTI				12.158	11.635	11.135	11.135	11.885	11.635	11.748	11.685	11.685	11.685	11.685
DIST. PJESORE PROJEKTIT				0.582	0.500	0.500	0.500	0.500	0.440	2.500	2.500	0.350	0.300	0.300

PUNIME GERMIM-MBUSHJE	
GERMIM	3.193 mq
MBUSHJE	
MATERIAL MBUSHES	0.260 mq
PAKETA E SHTRESAVE	
SHTRESA E TAPETIT	5.000 m
SHTRESE STABILIZANTI	5.000 m
SHTRESE CAKULLI	1.198 mq
PUNIME VEPER ARTI	
BORDURA	0.092 mq

SEKSION N. : 26
 KT. PROJEKTI : 11.673
 DIST. PRG. : 400.00
 DIST. PARA. : 25.00
 DIST. PAS. : 25.00

SHKALLA 1:100

KT. REF. 7.000

KUOTE TERRENI	11.801	11.794	11.791	11.788	11.761	11.184	11.689	11.675	11.716	11.715	11.715	11.713	11.777	11.681	11.446
DIST. PJESORE TERRENI	0.305	0.927	0.650	3.119	1.083	0.890	1.137	1.325	0.962	0.325	0.621	0.281	0.646	0.289	2.672
KUOTE PROJEKTI					11.725	11.330	10.830	10.830	11.580	11.480	11.418	11.418	11.580	11.580	11.580
DIST. PJESORE PROJEKTIT					0.395	0.500	0.500	0.500	0.500	0.440	2.500	2.500	0.350	0.300	0.300

REPUBLIKA E SHQIPERISE



BASHKIA KURBIN



KLIENT: BASHKIA KURBIN

PROJEKT: Asfaltim Rruga Stacioni i Trenit -Perimore Mamuraz

EMERTIMI I FLETES:
 PRERJE TERTHORE

APROVIMI I KLIENTIT:



PROJEKTUAR:

"A.SH. ENGINEERING" sh.pk



VENDNDODHJA : ROSKOVEC

PUNIME GERMIM-MBUSHJE	
GERMIM	2.316 mq
MBUSHJE	
MATERIAL MBUSHES	0.264 mq
PAKETA E SHTRESAVE	
SHTRESA E TAPETIT	5.000 m
SHTRESE STABILIZANTI	5.000 m
SHTRESE ÇAKULLI	1.198 mq
PUNIME VEPEP ARTI	
BORDURA	0.092 mq

SEKSION N. : 27
 KT. PROJEKTI : 11.338
 DIST. PRG. : 425.00
 DIST. PARA. : 25.00
 DIST. PAS. : 25.00

SHKALLA 1:100

KT. REF. 7.000

KUOTE TERRENI	11.305	11.289	10.817	10.931	11.259	11.255	11.254	11.214	11.233	11.268	11.282	11.295	11.302	11.211
DIST. PJESORE TERRENI	3.429	0.717	0.577	0.571	0.940	0.315	1.651	0.482	0.902	0.265	0.750	0.124	2.203	
KUOTE PROJEKTI		11.279	10.996	10.496	10.496	11.246	11.246	11.185	11.185	11.185	11.185	11.185	11.246	11.211
DIST. PJESORE PROJEKTI		0.283	0.500	0.500	0.500	0.500	0.440	2.500	2.500	0.350	0.300	0.124	0.300	0.124

PUNIME GERMIM-MBUSHJE	
GERMIM	1.753 mq
MBUSHJE	
MATERIAL MBUSHES	0.266 mq
PAKETA E SHTRESAVE	
SHTRESA E TAPETIT	5.000 m
SHTRESE STABILIZANTI	5.000 m
SHTRESE ÇAKULLI	1.198 mq
PUNIME VEPEP ARTI	
BORDURA	0.092 mq

SEKSION N. : 28
 KT. PROJEKTI : 10.852
 DIST. PRG. : 450.00
 DIST. PARA. : 25.00
 DIST. PAS. : 25.00

SHKALLA 1:100

KT. REF. 6.000

KUOTE TERRENI	10.804	10.737	10.232	10.157	10.723	10.712	10.705	10.703	10.707	10.715	10.716	10.727	10.768	
DIST. PJESORE TERRENI	1.416	0.668	0.354	0.790	1.300	0.627	0.521	0.937	1.639	0.311	0.509	0.338	0.338	
KUOTE PROJEKTI		10.745	10.509	10.009	10.009	10.759	10.759	10.697	10.697	10.697	10.697	10.697	10.759	10.711
DIST. PJESORE PROJEKTI		0.236	0.500	0.500	0.500	0.500	0.440	2.500	2.500	0.350	0.300	0.124	0.300	0.124

REPUBLIKA E SHQIPERISE



BASHKIA KURBIN



KLIENT: BASHKIA KURBIN

PROJEKT: Asfaltim Rruga Stacioni i Trenit - Perimore Mamuraz

EMERTIMI I FLETES:
 PRERJE TERTHORE

APROVIMI I KLIENTIT:



PROJEKTUAR:

"A.S.H. ENGINEERING" sh.pk



VENDNDODHJA : ROSKOVEC

PUNIME GERMIM-MBUSHJE	
GERMIM	2.762 mq
MBUSHJE	
MATERIAL MBUSHES	0.330 mq
PAKETA E SHTRESAVE	
SHTRESA E TAPETIT	5.000 m
SHTRESE STABILIZANTI	5.000 m
SHTRESE ÇAKULLI	1.198 mq
PUNIME VEPEP ARTI	
BORDURA	0.092 mq

SEKSION N. : 29
 KT. PROJEKTI : 10.369
 DIST. PRG. : 475.00
 DIST. PARA. : 25.00
 DIST. PAS. : 25.00

SHKALLA 1:100

KT. REF. 6.000

KUOTE TERRENI	10.035	10.022	9.722	10.332	10.432	10.429	10.360	10.356	10.355	10.354	10.412	10.240	10.234	10.233
DIST. PJESORE TERRENI	1.059	0.360	1.402	0.746	0.240	1.915	0.126	2.127	0.172	0.342	1.462	0.126	0.126	0.126
KUOTE PROJEKTI	10.027	9.527	9.527	10.277	10.277	10.214	10.117	10.307	10.287	10.177	10.215	10.277	10.277	10.352
DIST. PJESORE PROJEKTI	0.500	0.500	0.500	0.500	0.440	2.500	0.130	2.500	0.350	0.300	1.462	0.130	0.130	0.130

PUNIME GERMIM-MBUSHJE	
GERMIM	2.627 mq
MBUSHJE	
MATERIAL MBUSHES	0.386 mq
PAKETA E SHTRESAVE	
SHTRESA E TAPETIT	5.000 m
SHTRESE STABILIZANTI	5.000 m
SHTRESE ÇAKULLI	1.198 mq
PUNIME VEPEP ARTI	
BORDURA	0.092 mq

SEKSION N. : 30
 KT. PROJEKTI : 10.252
 DIST. PRG. : 500.00
 DIST. PARA. : 25.00
 DIST. PAS. : 3.24

SHKALLA 1:100

KT. REF. 6.000

KUOTE TERRENI	9.974	9.871	9.585	9.982	10.236	10.235	10.214	10.224	10.243	10.282	10.406	10.373	10.386	10.286	10.266	10.216	10.235	10.236
DIST. PJESORE TERRENI	0.835	0.384	1.063	1.337	0.390	0.977	0.556	0.984	0.763	0.384	0.206	0.173	0.543	0.244	1.293	0.194	0.281	0.236
KUOTE PROJEKTI	9.910	9.410	9.410	10.160	10.060	9.937	9.787	10.060	10.190	9.897	10.110	10.060	10.022	10.060	10.060	10.270	10.270	10.270
DIST. PJESORE PROJEKTI	0.500	0.500	0.500	0.500	0.440	2.500	0.130	2.500	0.350	0.300	1.462	0.130	0.130	0.130	1.462	0.130	0.130	0.130

REPUBLIKA E SHQIPERISE



BASHKIA KURBIN



KLIENT: BASHKIA KURBIN

PROJEKT: Asfaltim Rruga Stacioni i Trenit - Perimore Mamurras

EMERTIMI I FLETES:
 PRERJE TERTHORE

APROVIMI I KLIENTIT:



PROJEKTUAR:

"A.S.H. ENGINEERING" sh.pk



VENDNDODHJA : ROSKOVEC

PUNIME GERMIM-MBUSHJE	
GERMIM	2.678 mq
MBUSHJE	
MATERIAL MBUSHES	0.327 mq
PAKETA E SHTRESAVE	
SHTRESA E TAPETIT	5.000 m
SHTRESE STABILIZANTI	5.000 m
SHTRESE ÇAKULLI	1.198 mq
PUNIME VEPER ARTI	
BORDURA	0.092 mq

SEKSION N. : 31
 KT. PROJEKTI : 10.260
 DIST. PRDG. : 503.24
 DIST. PARA. : 3.24
 DIST. PAS. : 2.07

SHKALLA 1:100

KT. REF. 6.000

KUOTE TERRENI	9.931	9.915	9.758	10.155	10.198	10.215	10.233	10.252	10.338	10.443	10.326	10.292	10.338	10.310	10.263
DIST. PJESORE TERRENI	1.054	0.454	1.312	2.054	0.885	0.900	0.864	0.355	0.207	0.640	0.412	1.144	0.232	0.395	0.263
KUOTE PROJEKTI	9.917	9.417	9.417	10.167	10.067	10.005	10.067	10.117	10.067	10.067	10.067	10.067	10.067	10.067	10.253
DIST. PJESORE PROJEKTIT	0.300	0.500	0.500	0.440	2.500	2.500	0.350	0.300	0.120	0.120	0.120	0.120	0.120	0.120	0.120

PUNIME GERMIM-MBUSHJE	
GERMIM	2.535 mq
MBUSHJE	
MATERIAL MBUSHES	0.291 mq
PAKETA E SHTRESAVE	
SHTRESA E TAPETIT	5.000 m
SHTRESE STABILIZANTI	5.000 m
SHTRESE ÇAKULLI	1.198 mq
PUNIME VEPER ARTI	
BORDURA	0.092 mq

SEKSION N. : 32
 KT. PROJEKTI : 10.264
 DIST. PRDG. : 505.31
 DIST. PARA. : 2.07
 DIST. PAS. : 2.07

SHKALLA 1:100

KT. REF. 6.000

KUOTE TERRENI	10.043	10.045	9.782	10.331	10.195	10.180	10.221	10.454	10.351	10.309	10.351	10.320	10.268
DIST. PJESORE TERRENI	1.154	0.406	1.166	2.948	1.138	1.880	0.452	0.541	0.518	1.050	0.256	0.369	0.268
KUOTE PROJEKTI	10.047	9.547	9.547	10.297	10.197	10.135	10.092	10.072	10.035	10.072	10.172	10.310	10.268
DIST. PJESORE PROJEKTIT	0.500	0.500	0.500	0.500	2.500	2.500	0.350	0.300	0.120	0.120	0.120	0.120	0.120

REPUBLIKA E SHQIPERISE



BASHKIA KURBIN



KLIENT: BASHKIA KURBIN

PROJEKT: Astalim Rruga Stacioni i Trenit -Perimore Mamurras

EMERTIMI I FLETES:
 PRERJE TERTHORE

APROVIMI I KLIENTIT:



PROJEKTUAR:

"A.S.H. ENGINEERING" sh.pk



VENDNDODHJA : ROSKOVEC

PUNIME GERMIM-MBUSHJE	
GERMIM	2.521 mq
MBUSHJE	
MATERIAL MBUSHES	0.287 mq
PAKETA E SHTRESAVE	
SHTRESA E TAPETIT	5.000 m
SHTRESE STABILIZANTI	5.000 m
SHTRESE ÇAKULLI	1.198 mq
PUNIME VEPER ARTI	
BORDURA	0.092 mq

SEKSION N. : 33
 KT. PROJEKTI : 10.269
 DIST. PRDG. : 507.38
 DIST. PARA. : 2.07
 DIST. PAS. : 17.62

SHKALLA 1:100

KT. REF. 6.000

KUOTE TERRENI	10.208	9.877	9.707	10.398	10.193	10.192	10.191	10.325	10.363	10.273
DIST. PJESORE TERRENI	1.052	0.297	1.100	2.714	0.389	0.403	1.541	0.370	0.279	0.404
KUOTE PROJEKTI	10.052	9.952	9.952	10.302	10.302	10.264	10.154	10.257	10.077	10.325
DIST. PJESORE PROJEKTI	0.500	0.500	0.500	0.440	2.500	2.500	0.350	0.350	0.350	0.350

PUNIME GERMIM-MBUSHJE	
GERMIM	2.646 mq
MBUSHJE	
MATERIAL MBUSHES	0.284 mq
PAKETA E SHTRESAVE	
SHTRESA E TAPETIT	5.000 m
SHTRESE STABILIZANTI	5.000 m
SHTRESE ÇAKULLI	1.198 mq
PUNIME VEPER ARTI	
BORDURA	0.092 mq

SEKSION N. : 34
 KT. PROJEKTI : 10.309
 DIST. PRDG. : 525.00
 DIST. PARA. : 17.62
 DIST. PAS. : 5.08

SHKALLA 1:100

KT. REF. 6.000

KUOTE TERRENI	10.226	9.726	10.223	10.265	10.220	10.268	10.258	10.355	10.531	10.413	10.315
DIST. PJESORE TERRENI	1.776	0.925	1.018	0.863	1.240	0.509	1.482	0.658	0.390	0.484	0.700
KUOTE PROJEKTI	9.967	9.457	9.457	10.217	10.217	10.154	10.054	10.257	10.077	10.471	10.325
DIST. PJESORE PROJEKTI	0.500	0.500	0.500	0.440	2.500	2.500	0.350	0.350	0.350	0.350	0.350

REPUBLIKA E SHQIPERISE



BASHKIA KURBIN



KLIENT: BASHKIA KURBIN

PROJEKT: Asfaltim Rruga Stacioni i Trenit - Perimore Mamurras

EMERTIMI I FLETES:
 PRERJE TERTHORE

APROVIMI I KLIENTIT:



PROJEKTUAR:

"A.SH. ENGINEERING" sh.pk



VENDNDODHJA : ROSKOVEC

PUNIME GERMIM-MBUSHJE	
GERMIM	3.207 mq
MBUSHJE	
MATERIAL MBUSHES	0.331 mq
PAKETA E SHTRESAVE	
SHTRESA E TAPETIT	5.000 m
SHTRESE STABILIZANTI	5.000 m
SHTRESE ÇAKULLI	1.198 mq
PUNIME VEPEP ARTI	
BORDURA	0.092 mq

SEKSION N. : 35
 KT. PROJEKTI : 10.321
 DIST. PRG. : 530.08
 DIST. PARA. : 5.08

SHKALLA 1:100

KT. REF. 6.000

KUOTE TERRENI	9.967	10.268	10.282	10.315	10.370	10.465	10.327	
DIST. P.JESORE TERRENI	3.334	2.122	1.859	0.653	1.157	0.786		
KUOTE PROJEKTI	9.978 0.500 9.478	9.478 0.500 0.500 0.500 0.440	10.228 0.500 0.500 0.500 0.440	10.249 0.500 0.500 0.500 0.440	9.966	10.321 0.350 10.241 0.921 0.300 0.300 0.132	10.370 0.300 10.370 0.300 0.300 0.132	10.437 0.296 10.437 0.296 10.437 0.296
DIST. P.JESORE PROJEKTIT		2.500	2.500					

REPUBLIKA E SHQIPERISE



BASHKIA KURBIN



KLIENT: BASHKIA KURBIN

PROJEKT: Asfaltim Rruga Stacioni i Trenit - Perimore Mamurras

EMERTIMI I FLETES:
 PRERJE TERTHORE

APROVIMI I KLIENTIT:



PROJEKTUAR:

"A.SH. ENGINEERING" sh.pk



VENDNDODHJA : ROSKOVEC

RENDER

REPUBLIKA E SHQIPERISE



BASHKIA KURBIN



KLIENT: BASHKIA KURBIN

PROJEKT: Asfaltim Rruga Stacioni i Trenit - Perimore Mamurras

EMERTIMI I FLETES:
RENDER

APROVIMI I KLIENTIT:



PROJEKTUAR:

"A.SH. ENGINEERING" sh.pk



VENDNDODHJA : ROSKOVEC

SH.



RENDER



REPUBLIKA E SHQIPERISE



BASHKIA KURBIN



KLIENT: BASHKIA KURBIN

PROJEKT: Asfaltim Rruga Stacioni i Trenit - Perimore Mamurras

EMERTIMI I FLETES:
RENDER

APROVIMI I KLIENTIT:



PROJEKTUAR

"A.S.H. ENGINEERING" sh.pk

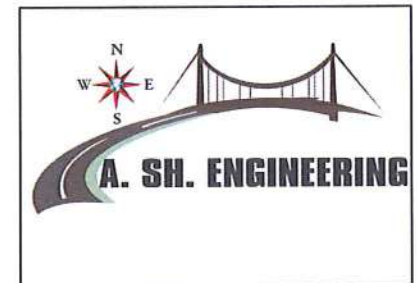

VENDNDODHJA : ROSKOVEC

SH.