

# PROJEKT ZBATIMI

Asfaltim i rruges ne Zheje (Varrezat)

REPUBLIKA E SHQIPERISE



BASHKIA KURBIN



KLIENT: BASHKIA KURBIN

PROJEKT: Asfaltim i rruges ne Zheje (Varrezat)

EMERTIMI I FLETES:

KAPAK

APROVIMI I KLIENIT:



PROJEKTUAR:

"A.S.H. ENGINEERING" sh.p.k

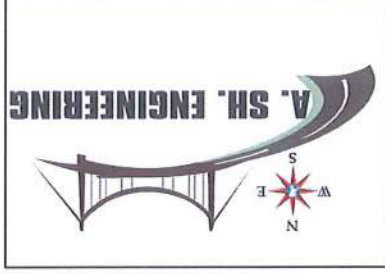

VENDOSHAJA: ROSKOVEC

SH.



HOROGRAFIA

SH.

VENDDODHJA : ROSKOVEC



A. SH. ENGINEERING" sh.p.k

PROJEKTUAR



APROVIMI I KLIENIT

HOROGRAFIA

EMERTIMI I FLETES

PROJEKT: Asfaltim i rruges ne Zheje (Varrezat)

KLIENI: BASHKIA KURBIN

BASHKIA KURBIN

REPUBLIKA E SHQIPERISE



PLANI TOPOGRAFIK

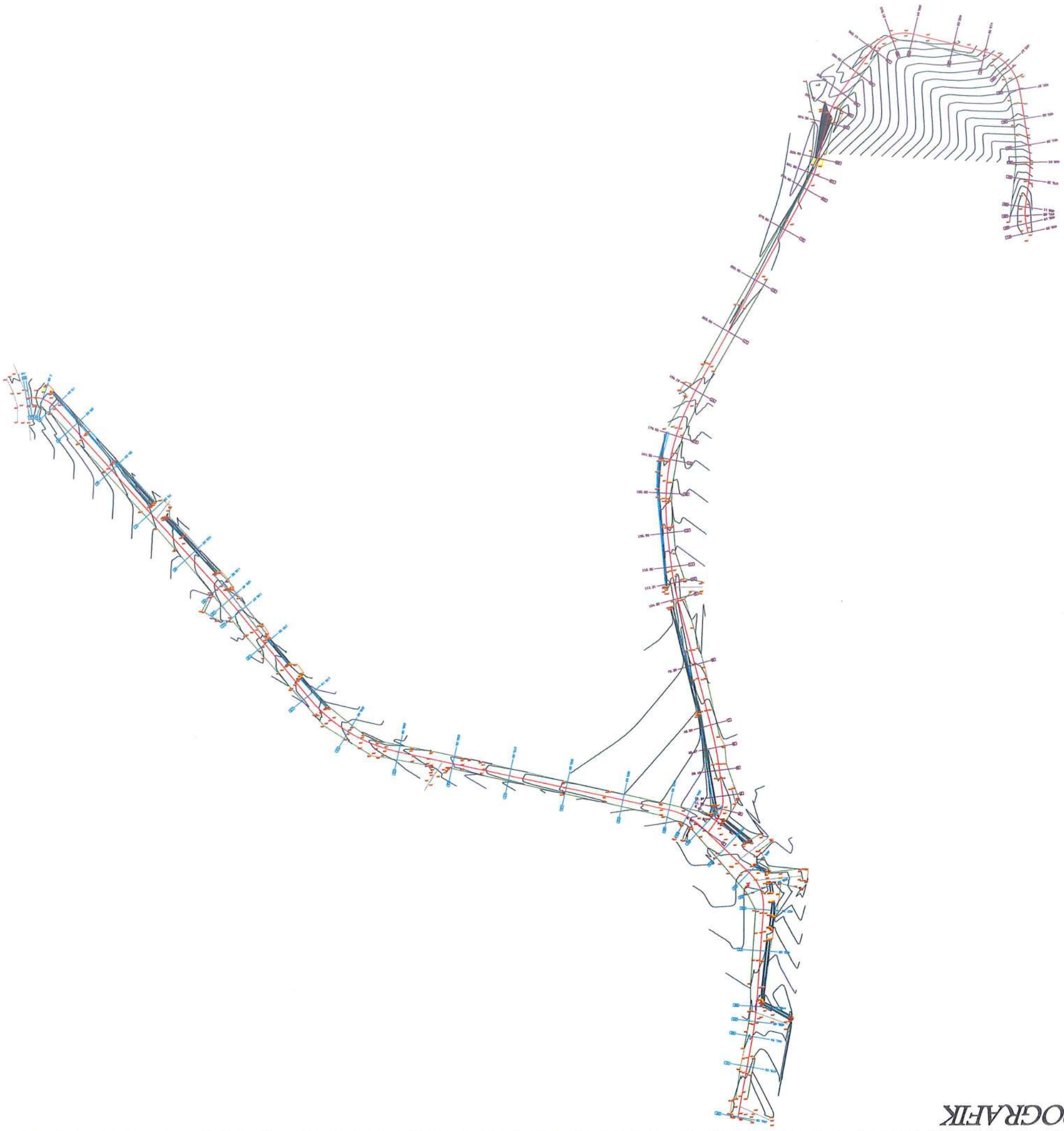

REPUBLIKA E SHQIPERISE

BASHKIA KURBIN

KLIENT: BASHKIA KURBIN

PROJEKT: Asfaltim i rruges ne Zheje (Varrezat)

EMERTIMI I FLETES:

PLANI TOPOGRAFIK

APROVIMI I KLIENIT:



PROJEKTUAR: "A.S.H. ENGINEERING" sh.p.k

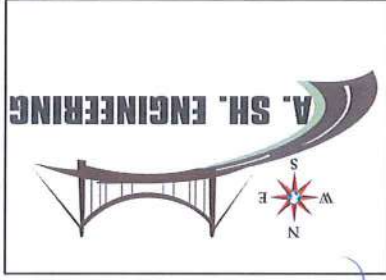

VENDNDHJA: ROSKOVEC

SH.

PLANIMETRIA E PERGJITTHSHE

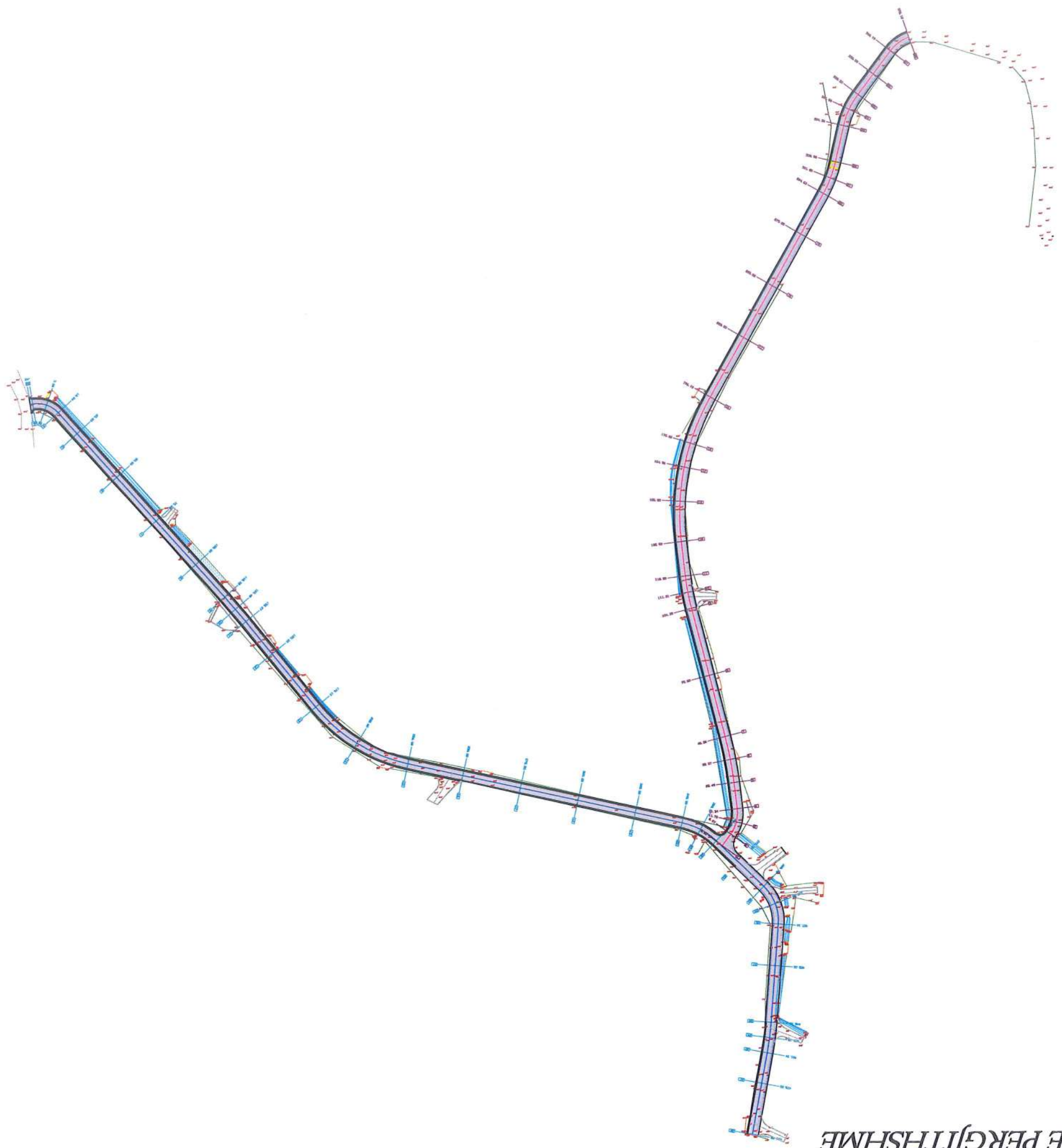

REPUBLIKA E SHQIPERISE

BASHKIA KURBIN

KLIENT: BASHKIA KURBIN

PROJEKT: Asfaltim i rruges ne Zheje (Varrezat)

EMERTIMI I FLETES:

PLANIMETRIA PERGJITSHME

APROVIMI I KLIENTIT:



PROJEKTUAR:

"A. SH. ENGINEERING" sh.p.k

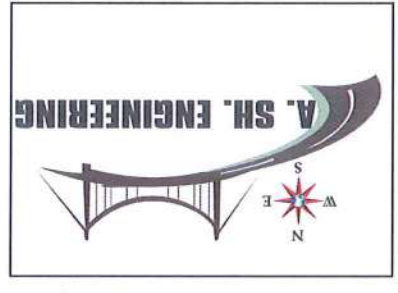

VENDOSSHIA: ROSKOVEC

SH.

SH.

VENNDODHJA: ROSKOVEC

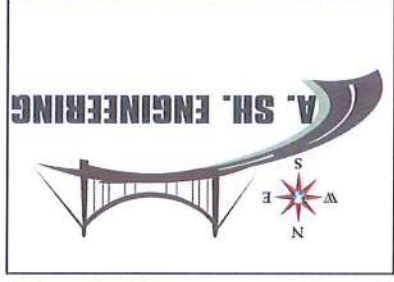

"A. SH. ENGINEERING" sh.pk

PROJEKTUAR:



APROVIMI I KLENTIT:

KAPAK

EMERTIMI I FLETES:

PROJEKT: Asfaltim i rruges ne Zheje (Varrezat)

KLENT: BASHKIA KURBIN

BASHKIA KURBIN

REPUBLIKA E SHQIPERISE



# PROJEKT ZBATIMI

Asfaltim i rruges ne Zheje (Varrezat)  
AKSI 1

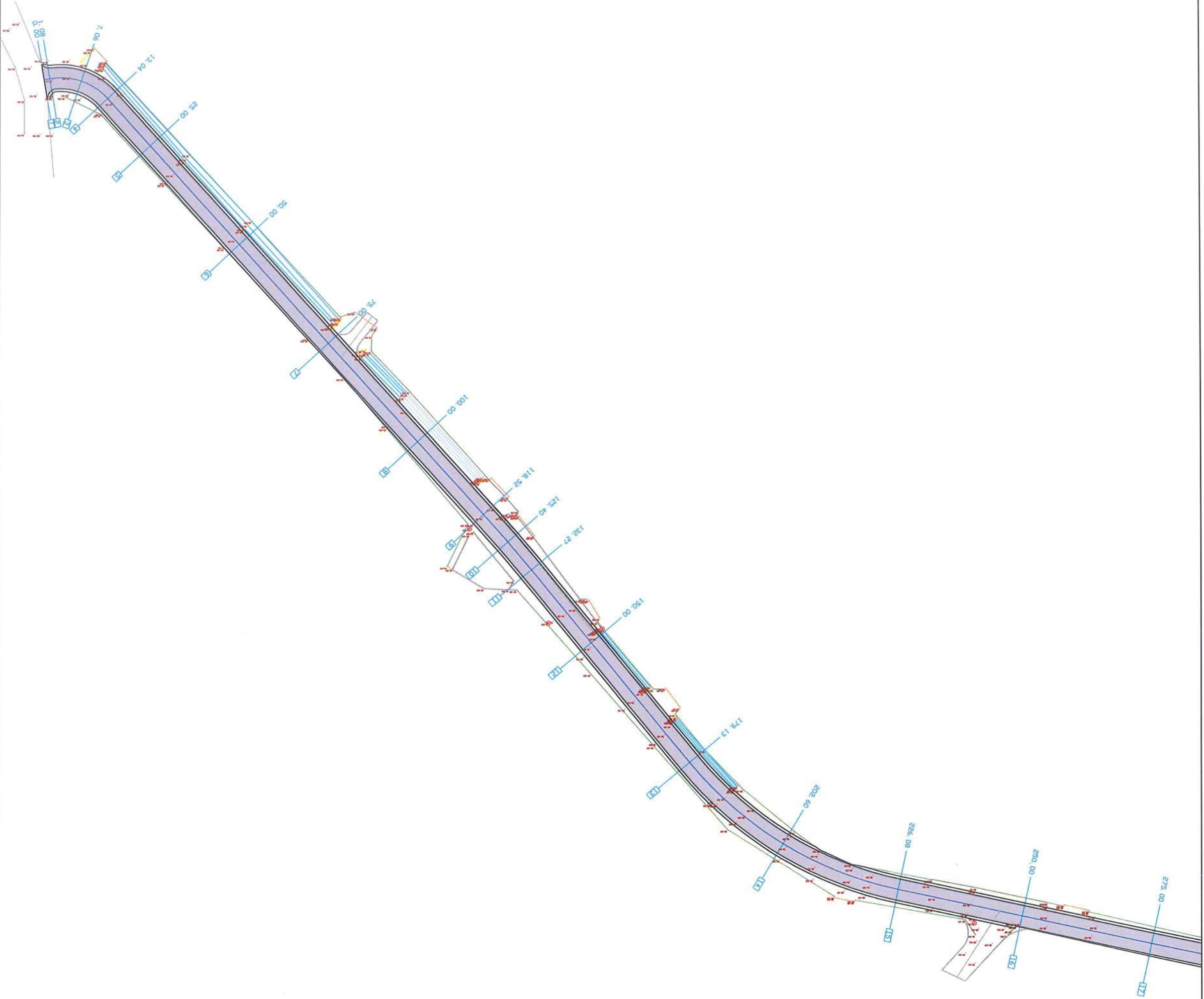

SH.

VENDDODHJA: ROSKOVEC



"A. SH. ENGINEERING" sh.pk

PROJEKTUAR:



APROVIMI I KLIENIT:

EMERTIMI I FLETES:  
PLANIMETRIA PERJITSHME

PROJEKT: Astalim Fuga Stacioni i Trenit -Perimore Mamurraz

KLIENI: BASHKIA KURBIN

BASHKIA KURBIN

REPUBLIKA E SHQIPERISE



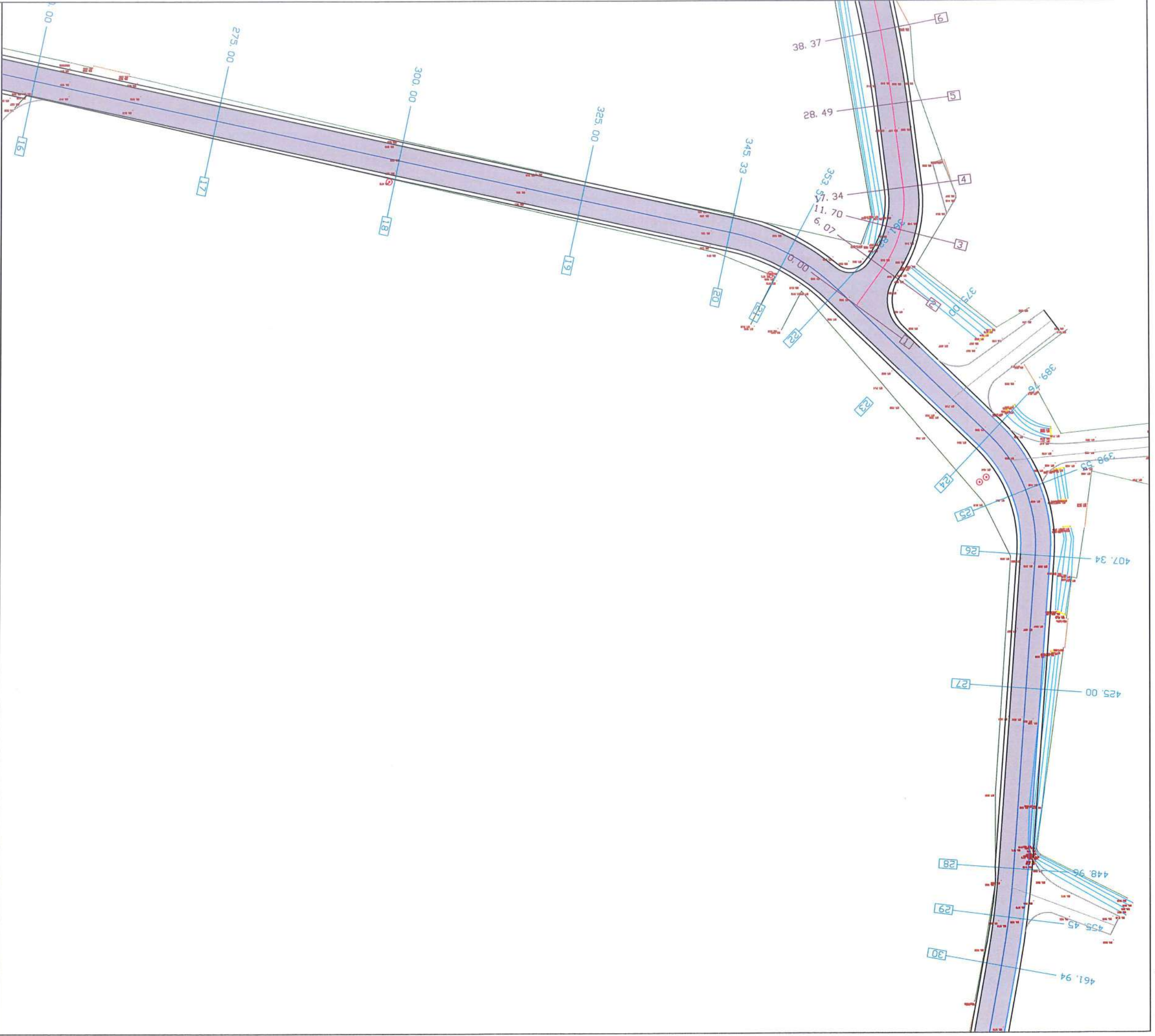

SH.

VENDODHJA: ROSKOVEC



"A.SH. ENGINEERING" sh.pk

PROJEKTUAR:



APROVIMI I KLIENIT:

EMERTIMI I FLETES:  
PLANIMETRIA PERGJITHSHME

PROJEKT: Asialim Runga Stacioni Trenit -Perimore Manurratz

KLIENI: BASHKIA KURBIN

BASHKIA KURBIN

REPUBLIKA E SHQIPERISE



# PROFIL TIP

## MENYRA E NDERTIMIT TE RRUGES ZHEJE

### AKSI "1" SEKSIONI 1-8, 12-13, 25-28

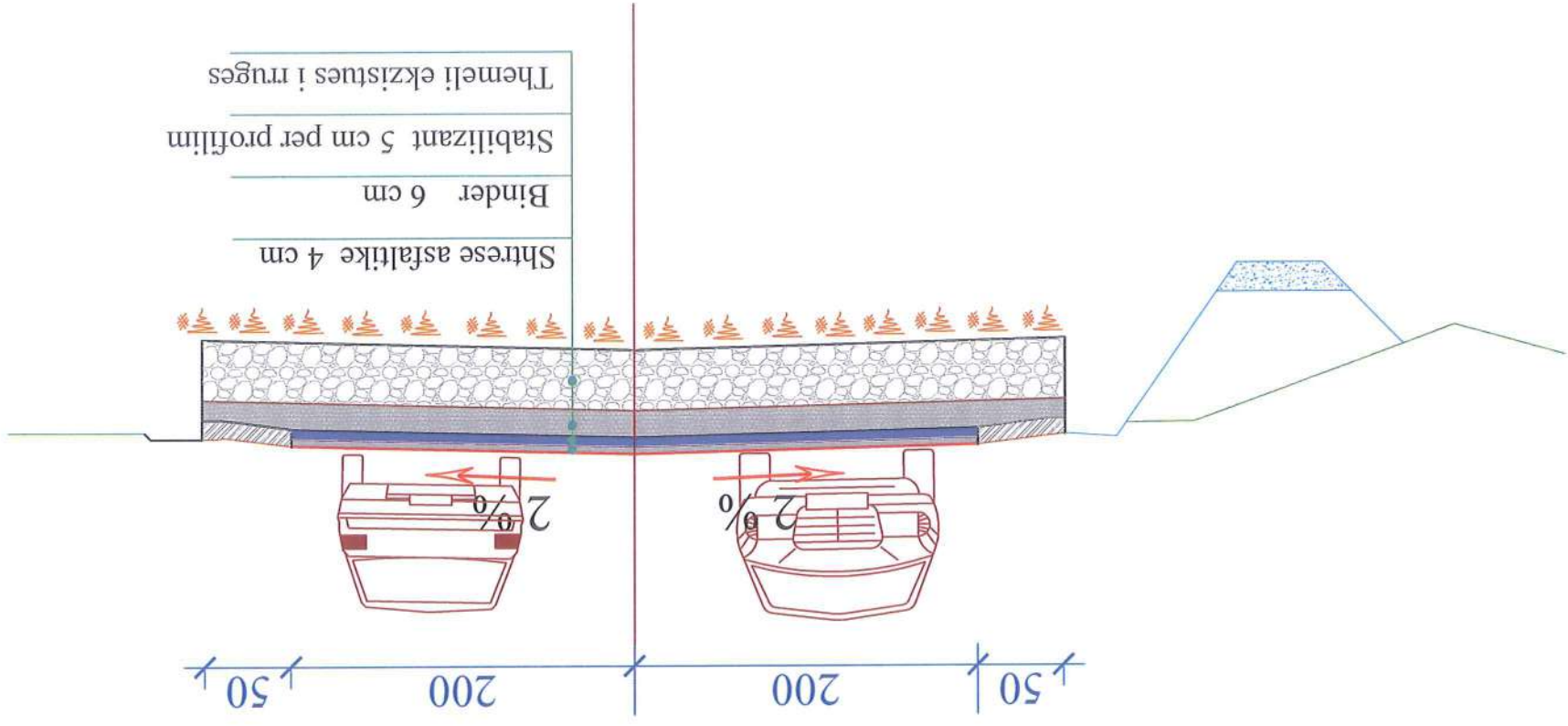
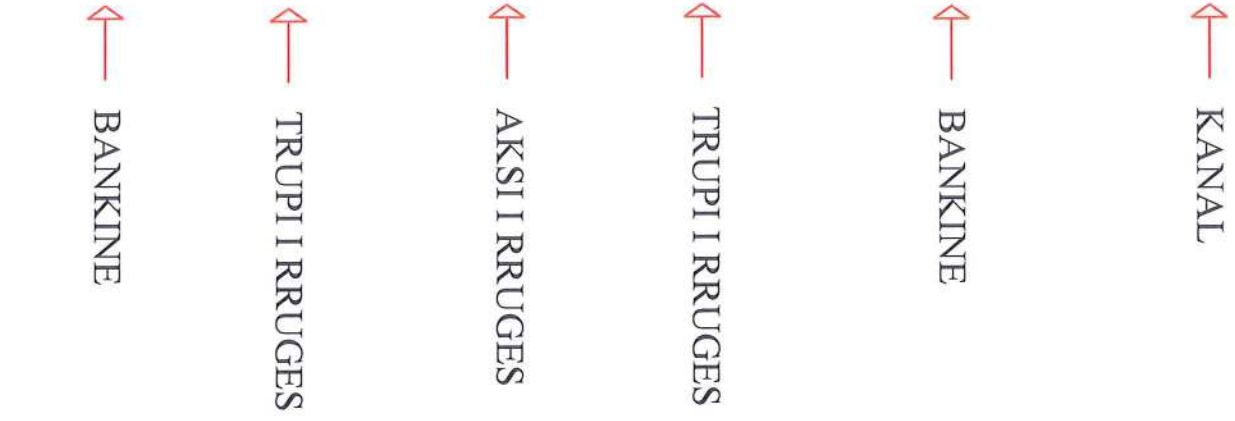

REPUBLIKA E SHQIPERISE

BASHKIA KURBIN

KLIENT: BASHKIA KURBIN

PROJEKT: Asfaltim i rruges ne Zheje (Varrezat)

EMERTIMI I FLETES:

PROFIL TIP

APROVIMI I KLENTIT:



PROJEKTUAR: "A. SH. ENGINEERING" sh.p.k



VENDOSHJA: ROSKOVEC

SH.





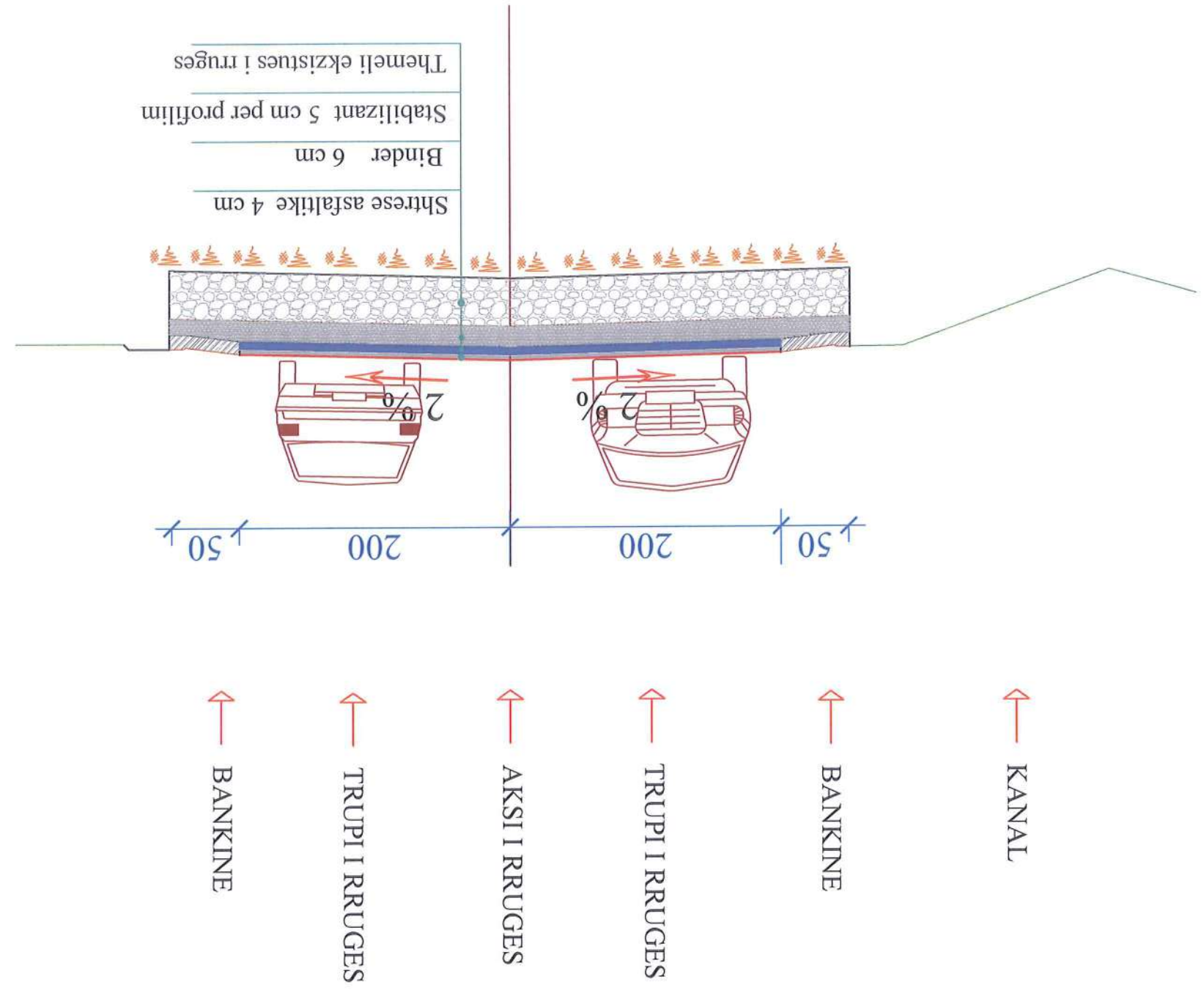

## AKSI "1" SEKSIONI 9-11, 14-24, 29-32

# PROFIL TIP MENYRA E NDERTIMIT TE RRUGES ZHEJE

SH.

VENDNDODHJA: ROSKOVEC

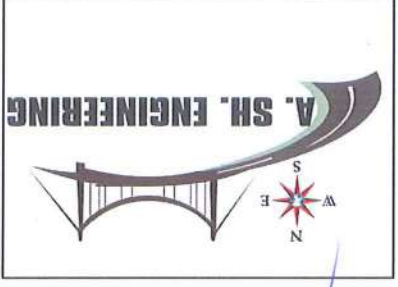

"A.S.H. ENGINEERING" sh.pk

PROJEKTUAR:



APROVIMI I KLIENIT:

PROFIL TIP

EMERTIMI I FLETES:

PROJEKT: Asfaltim i rruges ne Zheje (Vareza)

KLIENI: BASHKIA KURBIN

BASHKIA KURBIN

REPUBLIKA E SHQIPERISE



PRERJE GJATESORE

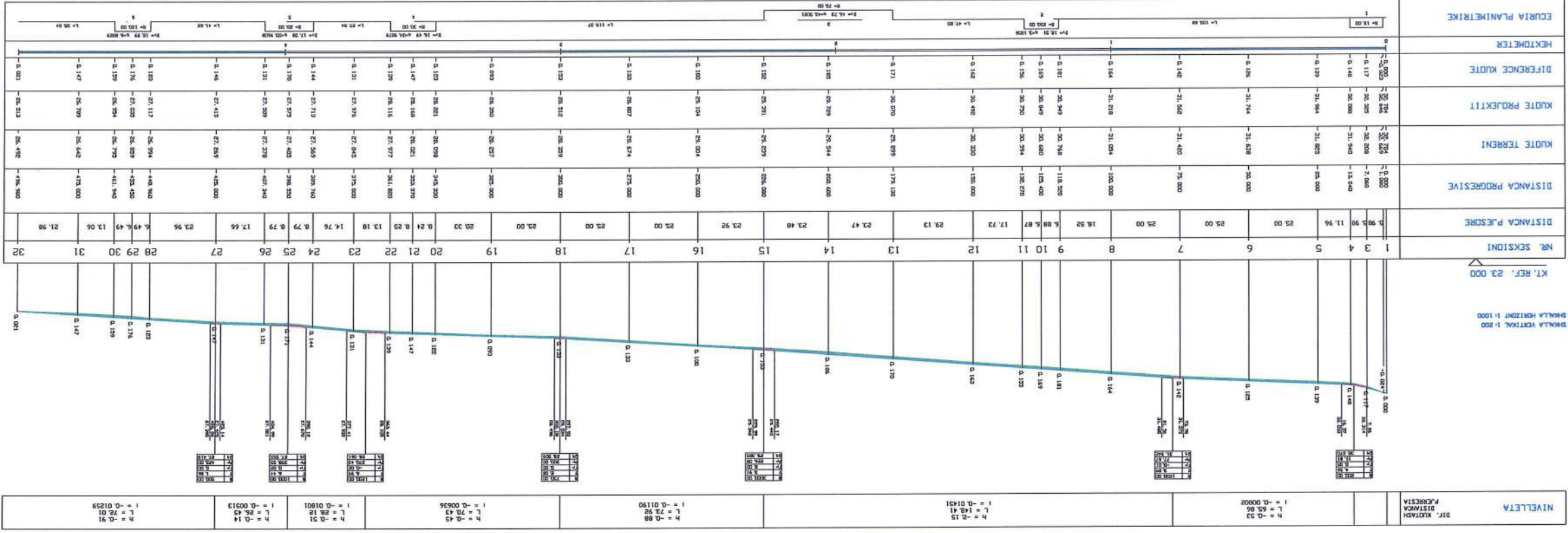

REPUBLIKA E SHQËPERISE

BASHKIA KURBIN

KLIENT: BASHKIA KURBIN

PROJEKT: Asfaltim i rruge ne Zheje (Vareza)

EMERTIMI I FLETES:

PRERJE GJATESORE AKSI I

APROVIMI I KLIENTIT:

"A.S.H. ENGINEERING" sh.p.k

PROJEKTUAR:

VENDNDORJA : ROSKOVEC

SH.

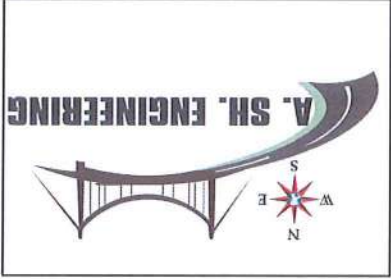

PUNIME GERMIM-MBUSHJE	2.797 mq
GERMIM	
MBUSHJE	
MATERIAL MBUSHES	0.260 mq
PAKETA E SHITRESAVE	4.000 m
SHITRESA E TAPETII	4.000 m
SHITRESA STABILIZANTI	4.000 m
SHITRESA ÇAKULLI	0.998 mq
PUNIME VEPER ARTI	
BORDURA	0.092 mq

SHKALLA 1:100

KT. REF. 28.000

KUOTE TERRENI	32.742
DIST. PUESORE TERRENI	1.431
KUOTE PROJEKTI	32.747
DIST. PUESORE PROJEKTI	0.224
32.744	0.224
32.744	0.500
32.743	0.500
32.743	0.311
32.728	1.620
32.702	2.459
32.686	3.816
32.689	1.430
32.680	1.609
32.629	2.151
32.576	4.807
32.578	1.081
32.577	1.081
32.578	1.081
32.578	0.725
32.576	0.725

SEKSION N. : 1

KT. PROJEKTI : 32.704

DIST. PRDG. : 0.00

DIST. PAS. : 1.08

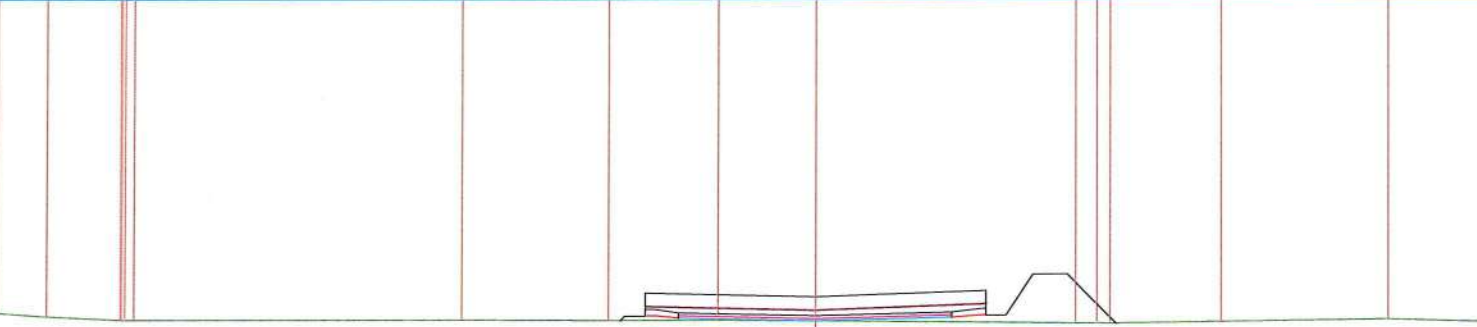

PUNIME GERMIM-MBUSHJE	2.549 mq
GERMIM	
MBUSHJE	
MATERIAL MBUSHES	0.257 mq
PAKETA E SHITRESAVE	4.000 m
SHITRESA E TAPETII	4.000 m
SHITRESA STABILIZANTI	4.000 m
SHITRESA ÇAKULLI	0.998 mq
PUNIME VEPER ARTI	
BORDURA	0.092 mq

SHKALLA 1:100

KT. REF. 28.000

KUOTE TERRENI	32.699
DIST. PUESORE TERRENI	1.966
KUOTE PROJEKTI	32.676
DIST. PUESORE PROJEKTI	0.500
32.680	0.500
32.685	0.500
32.685	0.400
32.685	0.300
32.685	0.300
32.685	0.440
32.677	2.312
32.669	1.241
32.657	1.980
32.657	1.251
32.652	0.182
32.657	4.666
32.663	1.858
32.600	0.963
32.629	1.020
32.594	1.020
32.594	1.020

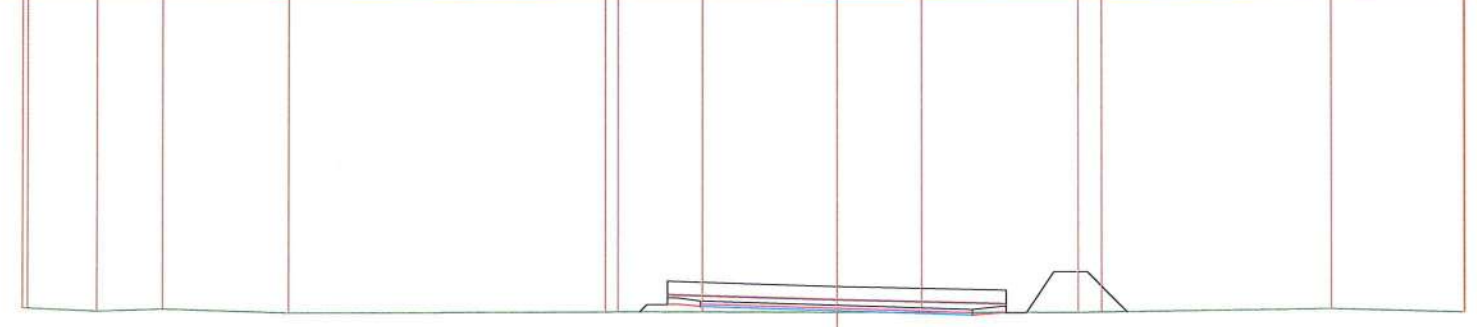

SEKSION N. : 2

KT. PROJEKTI : 32.646

DIST. PRDG. : 1.08

DIST. PAS. : 1.08

DIST. PAS. : 1.08

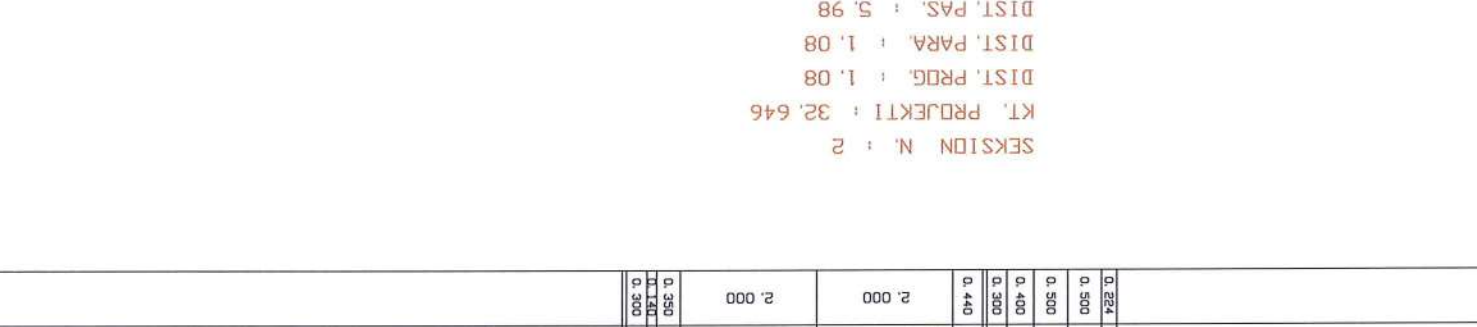

REPUBLIKA E SHQIPERISE

BASHKIA KURBIN

KLIENT: BASHKIA KURBIN



PROJEKT: Asfaltim (rruges ne Zheje (Varrezat))

EMERTIMI I FLETES:

PRERJE TERTHORE AKSI I

APROVIMI I KLIENIT:



PROJEKTUAR:

"A.S.H. ENGINEERING" sh.p.k

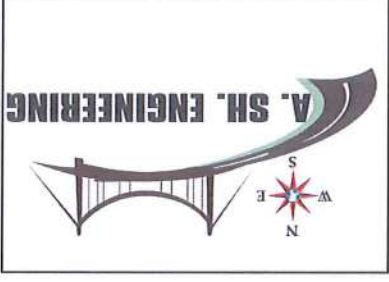

VENDNDODHJA : ROSKOVEC

SH.

PUNIME GERIM-MBUSHJE	1.670 mq
GERMIM	
MBUSHJE	0.299 mq
MATERIAL MBUSHES	
PAKETA E SHITRESAVE	4.000 m
SHITRESA E TAPETIT	4.000 m
SHTRESE STABILIZANTI	0.998 mq
SHTRESE ÇAKULLI	0.998 mq
PUNIME VEPER ARTI	0.092 mq
BORDURA	

SHKALLA 1:100

KT. REF. 28.000

KUOTE TERRENI	DIST. PUESORE TERRENI	KUOTE PROJEKTI	DIST. PUESORE PROJEKTI
32.592	0.212	32.265	0.189
32.592	0.195	32.265	0.500
32.592	0.357	31.765	0.400
32.592	0.390	31.765	0.440
32.592	3.204	2.000	2.000
32.592	2.075	31.970	0.380
32.592	0.835	32.183	0.300
32.592	0.245	32.288	0.300
32.592	0.745	32.464	0.300
32.592	5.437	2.000	0.300
32.592	1.744		
32.592	0.853		

SEKSION N. : 3  
 KT. PROJEKTI : 32.325  
 DIST. PRDG. : 7.06  
 DIST. PARA. : 5.98  
 DIST. PAS. : 5.98

PUNIME GERIM-MBUSHJE	1.414 mq
GERMIM	
MBUSHJE	0.425 mq
MATERIAL MBUSHES	
PAKETA E SHITRESAVE	4.000 m
SHITRESA E TAPETIT	4.000 m
SHTRESE STABILIZANTI	0.998 mq
SHTRESE ÇAKULLI	0.998 mq
PUNIME VEPER ARTI	0.092 mq
BORDURA	

SHKALLA 1:100

KT. REF. 28.000

KUOTE TERRENI	DIST. PUESORE TERRENI	KUOTE PROJEKTI	DIST. PUESORE PROJEKTI
32.147	0.212	31.845	0.189
32.147	0.211	32.088	0.500
32.147	0.286	31.588	0.400
32.147	0.551	31.588	0.440
32.147	0.208	31.588	0.300
32.147	0.208	31.588	0.400
32.147	0.208	31.588	0.440
32.147	2.034	2.000	2.000
32.147	0.846	31.793	0.380
32.147	0.684	31.793	0.300
32.147	2.041	32.009	0.380
32.147	0.310	32.034	0.310
32.147	2.913	32.115	0.310
32.147	4.733	32.255	0.310
32.147	0.926	32.591	0.310
32.147	0.926	32.591	0.310

SEKSION N. : 4  
 KT. PROJEKTI : 32.088  
 DIST. PRDG. : 13.04  
 DIST. PARA. : 5.98  
 DIST. PAS. : 11.96

REPUBLIKA E SHQIPERISE

BASHKIA KURBIN

KLIENT: BASHKIA KURBIN



PROJEKT: Astalim i rruges ne Zheje (Varezat)

EMERTIMI I FLETES:

PRERJE TERTHORE AKSII I

APROVIMI I KLIENIT:



"A.S.H. ENGINEERING" sh.p.k

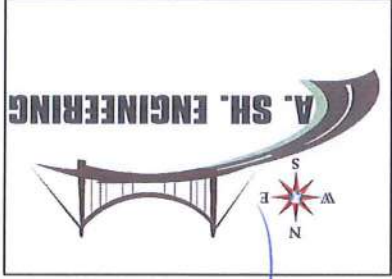

VENDODHJA : ROSKOVEC

SH.



PUNIME GERMIM-MBUSHJE	1,672 mq
GERMIM	
MBUSHJE	0,299 mq
MATERIAL MBUSHES	
PAKETA E SHTRESAVE	
SHTRESA E TAPETII	4,000 m
SHTRESE STABILIZANTI	4,000 m
SHTRESE ÇAKULLI	0,998 mq
PUNIME VEPRER ARTI	0,092 mq
BORDURA	

SHKALLA 1:100

KT. REF. 27,000

KUOTE TERRENI	31,367
DIST. P.JESORE TERRENI	0,362
KUOTE PROJEKTI	31,322
DIST. P.JESORE PROJEKTI	0,306
KUOTE TERRENI	31,289
DIST. P.JESORE TERRENI	2,678
KUOTE TERRENI	31,347
DIST. P.JESORE TERRENI	0,820
KUOTE PROJEKTI	31,356
DIST. P.JESORE PROJEKTI	0,178
KUOTE TERRENI	31,376
DIST. P.JESORE TERRENI	1,103
KUOTE TERRENI	31,362
DIST. P.JESORE TERRENI	0,451
KUOTE TERRENI	31,420
DIST. P.JESORE TERRENI	1,608
KUOTE TERRENI	31,484
DIST. P.JESORE TERRENI	1,774
KUOTE TERRENI	31,498
DIST. P.JESORE TERRENI	0,300
KUOTE TERRENI	31,477
DIST. P.JESORE TERRENI	0,623
KUOTE TERRENI	31,623
DIST. P.JESORE TERRENI	9,201
KUOTE TERRENI	31,207
DIST. P.JESORE TERRENI	2,000
KUOTE TERRENI	31,512
DIST. P.JESORE TERRENI	0,390
KUOTE TERRENI	31,526
DIST. P.JESORE TERRENI	0,120
KUOTE TERRENI	31,545
DIST. P.JESORE TERRENI	0,300
KUOTE TERRENI	31,512
DIST. P.JESORE TERRENI	0,300

SEKSION N. : 7  
 KT. PROJEKTI : 31,562  
 DIST. PRDG. : 75,00  
 DIST. PARA. : 25,00  
 DIST. PAS. : 25,00

BASHKIA KURBIN

KLIENT-BASHKIA KURBIN

REPUBLIKA E SHQIPERISE



PROJEKT "Asfaltim i rruges ne Zheje (Vareza)"

EMERTIMI I FLETES:

PREJUE TERTHORE AKSI I

APROVIMI I KLIENIT:



"A.SH. ENGINEERING" sh.p.k

PROJEKTUAR:



VENDNDODHJA : ROSKOVEC

SH

PUNIME GERMIM-MBUSHJE	1,430 mq
GERMIM	
MBUSHJE	0,629 mq
MATERIAL MBUSHES	
PAKETA E SHTRESAVE	
SHTRESA E TAPETII	4,000 m
SHTRESE STABILIZANTI	4,000 m
SHTRESE ÇAKULLI	0,998 mq
PUNIME VEPRER ARTI	0,092 mq
BORDURA	

SHKALLA 1:100

KT. REF. 26,000

KUOTE TERRENI	31,123
DIST. P.JESORE TERRENI	1,489
KUOTE PROJEKTI	31,056
DIST. P.JESORE PROJEKTI	0,173
KUOTE TERRENI	31,018
DIST. P.JESORE TERRENI	0,368
KUOTE TERRENI	30,811
DIST. P.JESORE TERRENI	0,864
KUOTE TERRENI	30,432
DIST. P.JESORE TERRENI	0,193
KUOTE TERRENI	30,630
DIST. P.JESORE TERRENI	0,392
KUOTE TERRENI	31,030
DIST. P.JESORE TERRENI	0,487
KUOTE TERRENI	31,032
DIST. P.JESORE TERRENI	0,324
KUOTE TERRENI	31,017
DIST. P.JESORE TERRENI	0,598
KUOTE TERRENI	31,019
DIST. P.JESORE TERRENI	0,440
KUOTE TERRENI	30,863
DIST. P.JESORE TERRENI	2,000
KUOTE TERRENI	31,158
DIST. P.JESORE TERRENI	0,390
KUOTE TERRENI	31,088
DIST. P.JESORE TERRENI	0,120
KUOTE TERRENI	31,075
DIST. P.JESORE TERRENI	0,300
KUOTE TERRENI	31,134
DIST. P.JESORE TERRENI	0,192
KUOTE TERRENI	31,182
DIST. P.JESORE TERRENI	0,390
KUOTE TERRENI	31,155
DIST. P.JESORE TERRENI	1,997
KUOTE TERRENI	31,153
DIST. P.JESORE TERRENI	1,054
KUOTE TERRENI	31,150
DIST. P.JESORE TERRENI	4,503
KUOTE TERRENI	31,222
DIST. P.JESORE TERRENI	



PUNIME GERMIM-MBUSHJE	1.214 mq
GERMIM	
MBUSHJE	0.281 mq
PAKETA E SHITRESAVE	
SHTRESA E TAPETIT	4.000 m
SHTRESE STABILIZANTI	4.000 m
SHTRESE ÇAKULLI	0.998 mq
BORDURA	0.092 mq

SHKALLA 1:100  
KT. REF. 26.000

CUOTE TERRENI	DIST. PËSDORE TERRENI	KUOTE PROJEKTI	DIST. PËSDORE PROJEKTI
30.741	0.364	30.666	0.300
30.773	0.248	30.670	0.440
30.782	0.194	30.607	2.000
30.755	0.524	30.570	2.000
30.721		30.520	
30.704	1.197	30.520	
30.648	0.308	30.520	
30.617	1.272	30.520	
30.600	0.697	30.520	
30.591	0.451	30.395	
30.594	1.390	30.620	
30.596	0.917	30.620	
30.597	0.411	30.620	
30.621	0.497	30.620	
30.658	0.271	30.620	
30.648	1.233	30.620	
30.680	0.348	30.620	
30.750	2.756	30.620	
30.767	0.7750.806	30.620	
30.775	0.420	30.620	
30.718		30.620	
30.728		30.620	
30.699		30.620	

SEKSION N. : 11  
KT. PROJEKTI : 30.750  
DIST. PRDG. : 132.27  
DIST. PARA. : 6.87  
DIST. PAS. : 17.73

PUNIME GERMIM-MBUSHJE	1.731 mq
GERMIM	
MBUSHJE	0.409 mq
PAKETA E SHITRESAVE	
SHTRESA E TAPETIT	4.000 m
SHTRESE STABILIZANTI	4.000 m
SHTRESE ÇAKULLI	0.998 mq
BORDURA	0.092 mq

SHKALLA 1:100  
KT. REF. 26.000

CUOTE TERRENI	DIST. PËSDORE TERRENI	KUOTE PROJEKTI	DIST. PËSDORE PROJEKTI
30.501	0.571	30.530	0.211
30.530	0.960	30.530	0.500
30.530	0.202	29.812	0.500
30.530	0.389	29.812	0.400
30.530	0.388	29.812	0.440
30.530	0.381	29.812	2.000
30.530	0.517	29.812	2.000
30.530	0.402	30.137	2.000
30.330	0.405	30.137	0.350
30.335	0.152	30.137	0.300
30.334	2.013	30.137	0.300
30.434	0.790	30.434	
30.430	0.150	30.434	
30.405	0.567	30.434	
30.483	0.154	30.434	
30.483	2.150	30.434	
30.405	1.119	30.405	

REPUBLIKA E SHQËRISË  
BASHKIA KURBIN

KLIENT: BASHKIA KURBIN



PROJEKT: Astalim i rruges ne Zheje (Varezat)

EMERTIMI I FLETES:

PRERJE TERTHORE AKSI I

APROVIMI I KLUENTIT:



"A.S.H. ENGINEERING" sh.p.k

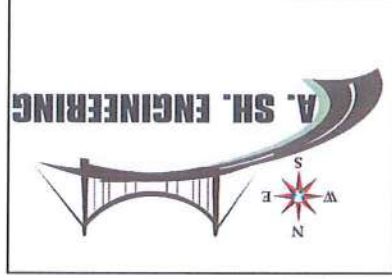

VENDNDODHJA: ROSKOVEC

SH.



PUNIME GERMIM-MBUSHJE	1.552 mq
GERMIM	
MBUSHJE	0.296 mq
PAKETA E SHITRESAVE	
SHTRESA E TAPETIT	4.000 m
SHTRESE STABILIZANTI	4.000 m
SHTRESE ÇAKULLI	0.998 mq
PUNIME VEPEER ARTI	
BORDURA	0.092 mq

SHKALLA 1: 100

KT. REF. 25.000

SHKALLA	KT. REF.	KUOTE TERRENI	DIST. PUESORE TERRENI	KUOTE PROJEKTI	DIST. PUESORE PROJEKTI
		30.113	0.585	29.528	0.585
		30.116	2.940	29.176	2.940
		30.007	1.127	28.880	1.127
		29.918	0.960	28.958	0.960
		29.918	0.808	29.110	0.808
		29.947	0.428	29.519	0.428
		30.032	0.333	29.699	0.333
		30.066	0.324	29.742	0.324
		29.923	1.368	28.555	1.368

SEKSION N : 13  
 KT. PROJEKTI : 30.070  
 DIST. PRDG. : 179.13  
 DIST. PARA. : 29.13  
 DIST. PAS. : 23.47

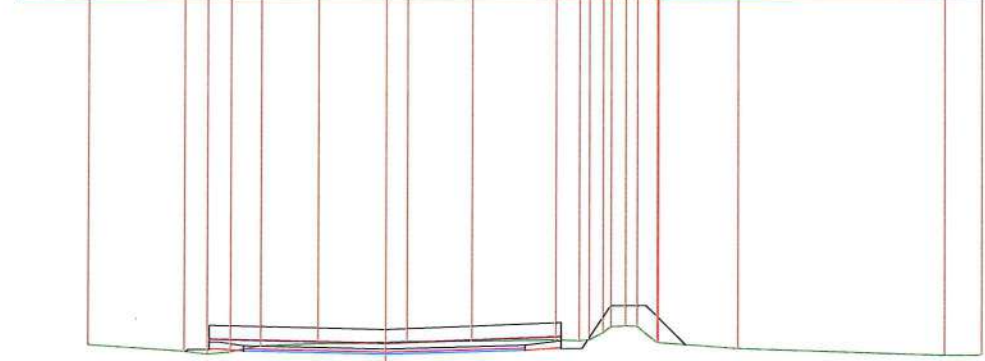

PUNIME GERMIM-MBUSHJE	0.950 mq
GERMIM	
MBUSHJE	0.336 mq
PAKETA E SHITRESAVE	
SHTRESA E TAPETIT	4.000 m
SHTRESE STABILIZANTI	4.000 m
SHTRESE ÇAKULLI	0.998 mq
PUNIME VEPEER ARTI	
BORDURA	0.092 mq

SHKALLA 1: 100

KT. REF. 25.000

SHKALLA	KT. REF.	KUOTE TERRENI	DIST. PUESORE TERRENI	KUOTE PROJEKTI	DIST. PUESORE PROJEKTI
		29.775	1.566	28.209	1.566
		29.775	4.226	25.549	4.226
		29.588	2.823	26.765	2.823
		29.572	1.279	28.293	1.279
		29.544	1.782	27.762	1.782
		29.544	2.268	27.276	2.268
		29.524	0.419	29.105	0.419
		29.524	0.206	29.318	0.206
		29.524	0.182	29.342	0.182
		29.524	0.155	29.369	0.155
		29.524	0.130	29.394	0.130
		29.524	0.105	29.419	0.105
		29.524	0.080	29.444	0.080
		29.524	0.055	29.469	0.055
		29.524	0.030	29.494	0.030
		29.524	0.005	29.519	0.005

SEKSION N : 14  
 KT. PROJEKTI : 29.729  
 DIST. PRDG. : 202.60  
 DIST. PARA. : 23.47  
 DIST. PAS. : 23.48

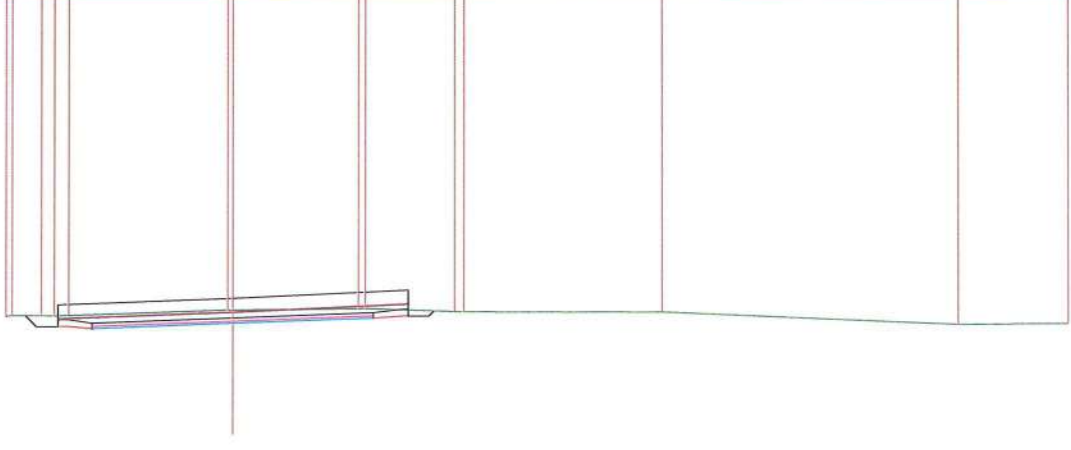

REPUBLIKA E SHQIPERISE

BASHKIA KURBIN

KLIENT-BASHKIA KURBIN

PROJEKT:Asfaltim i rruges ne Zheje (Varezat)

EMERTIMI I FLETES:

PRERJE TERTHORE AKSI I

APROVIMI I KLIENIT:



PROJEKTUAR:

"A.SH. ENGINEERING" sh.pk

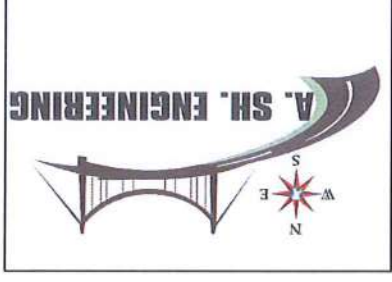

VENDNDODHJA: ROSKOVEC

SH.



PUNIME GERMI-MBUSHJE	1.339 mq
GERMIM	
MBUSHJE	
MATERIAL MBUSHES	0.260 mq
PAKETA E SHITESAVE	
SHITESA E TAPETIT	4.000 m
SHITESA STABILIZANTI	4.000 m
SHITESA ÇAKULLI	0.998 mq
PUNIME VEPER ARTI	0.092 mq
BORDURA	

SHKALLA 1:100

KT. REF. 25.000

KUOTE TERRENI	DIST. PËSDORE TERRENI	KUOTE PROJEKTI	DIST. PËSDORE PROJEKTI
29, 436	2, 832		
29, 422	0, 997		
29, 376	0, 665		
29, 370	0, 856		
29, 448	0, 693		
29, 429	0, 498		
29, 310	1, 022		
29, 245	0, 871		
29, 218	1, 070		
29, 239	1, 163		
29, 264	0, 564		
29, 327	0, 476		
29, 351	0, 182		
29, 386	2, 058		
29, 436	0, 297		
29, 452	0, 663		
29, 470			

SEKSION N. : 15

KT. PROJEKTI : 29.391

DIST. PRDG. : 226.08

DIST. PARA. : 23.48

DIST. PAS. : 23.92

PUNIME GERMI-MBUSHJE	1.610 mq
GERMIM	
MBUSHJE	
MATERIAL MBUSHES	0.273 mq
PAKETA E SHITESAVE	
SHITESA E TAPETIT	4.000 m
SHITESA STABILIZANTI	4.000 m
SHITESA ÇAKULLI	0.998 mq
PUNIME VEPER ARTI	0.092 mq
BORDURA	

SHKALLA 1:100

KT. REF. 25.000

KUOTE TERRENI	DIST. PËSDORE TERRENI	KUOTE PROJEKTI	DIST. PËSDORE PROJEKTI
29, 135	8, 487		
29, 133	0, 509		
29, 017	0, 178		
28, 963	2, 832		
29, 004	1, 143		
29, 011	0, 580		
29, 014	0, 959		
29, 017	0, 922		
29, 065	5, 557		
29, 257			

SEKSION N. : 16

KT. PROJEKTI : 29.104

DIST. PRDG. : 250.00

DIST. PARA. : 23.92

DIST. PAS. : 25.00

REPUBLIKA E SHQËPERISE

BASHKIA KURBIN

KLIENT: BASHKIA KURBIN

PROJEKT: Astalim i rruges ne Zheje (Varrozi)

EMERTIMI I FLETES:

PRERJE TERTHORE AKSI I

APROVIMI I KLIENIT:

PROJEKTUAR:

"A.S.H. ENGINEERING" sh.pk

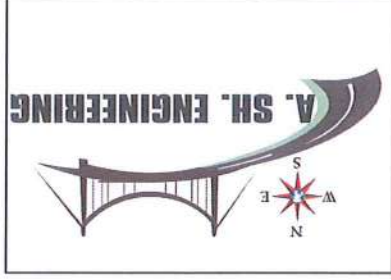

VENDODHJA: ROSKOVEC

SH.





PUNIME GERIM-MBUSHJE	1.616 mq
GERMIM	
MBUSHJE	0.260 mq
MATERIAL MBUSHES	
PAKETA E SHITESAVE	4.000 m
SHITESA E TAPETII	4.000 m
SHITESA STABILIZANTI	4.000 m
SHITESA ÇAKULLI	0.998 mq
PUNIME VEPER ARTI	0.092 mq
BORDURA	

SHKALLA 1:100  
 KT. REF. 24.000

KUOTE TERRENI	28.465	28.455	1.660	7.677	27.995	2.000	0.380	0.300
DIST. P.ESDRE TERRENI								
KUOTE PROJEKTI								
DIST. P.ESDRE PROJEKTI								

SEKSION N. : 19  
 KT. PROJEKTI : 28.350  
 DIST. PRDG. : 325.00  
 DIST. PARA. : 25.00  
 DIST. PAS. : 20.33

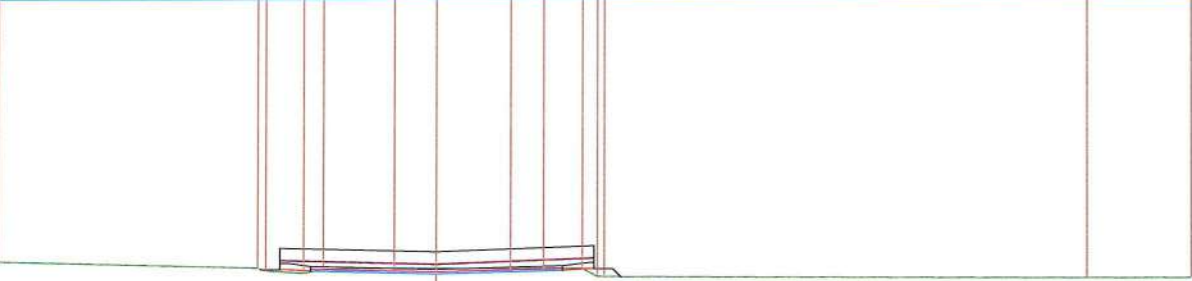

PUNIME GERIM-MBUSHJE	1.384 mq
GERMIM	
MBUSHJE	0.287 mq
MATERIAL MBUSHES	
PAKETA E SHITESAVE	4.000 m
SHITESA E TAPETII	4.000 m
SHITESA STABILIZANTI	4.000 m
SHITESA ÇAKULLI	0.998 mq
PUNIME VEPER ARTI	0.092 mq
BORDURA	

SHKALLA 1:100  
 KT. REF. 24.000

KUOTE TERRENI	28.192	28.103	28.139	28.117	1.602	28.099	28.098	28.098	1.049	1.433	0.312	1.252	28.029	27.886	5.953	2.000	0.380	0.300	
DIST. P.ESDRE TERRENI																			
KUOTE PROJEKTI																			
DIST. P.ESDRE PROJEKTI																			

SEKSION N. : 20  
 KT. PROJEKTI : 28.221  
 DIST. PRDG. : 345.33  
 DIST. PARA. : 20.33  
 DIST. PAS. : 8.24

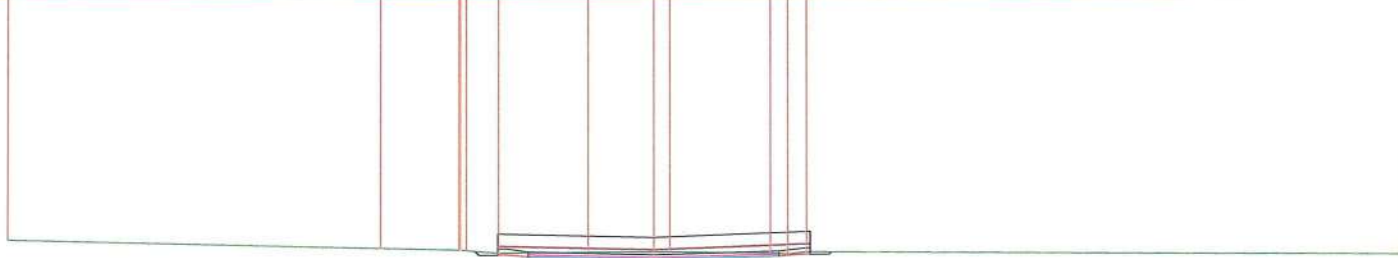

REPUBLIKA E SHQIPERISE



BASHKIA KURBIN



KLIENT: BASHKIA KURBIN

PROJEKT: Asfaltim i rruges ne Zheje (Varezat)

EMERTIMI I FLETES:

PRERJE TERTHORE AKSII I

APROVIMI I KLIENIT:



"A.S.H. ENGINEERING" sh.p.k

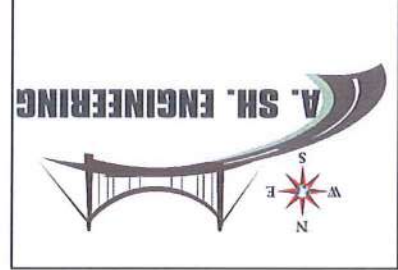

VENDDOSHJA : ROSKOVEC

SH

PUNIME GERMI-MBUSHJE	1.071 mq
GERMIM	
MBUSHJE	0.368 mq
MATERIAL MBUSHES	
PAKETA E SHITESAVE	4.000 m
SHITESA E TAFETIT	4.000 m
SHITSE STABILIZANTI	0.998 mq
SHITSE ÇAKULLI	
PUNIME VEPER ARTI	0.092 mq
BORDURA	

SHKALLA 1:100  
KT. REF. 24.000

KUOTE TERRENI	DIST. PUESORE TERRENI	KUOTE PROJEKTI	DIST. PUESORE PROJEKTI
27.900	8.417	27.943	2.265
27.880	0.732	27.808	0.300
27.969	0.585	27.827	0.440
28.027	1.477	27.813	2.000
28.019	0.788	27.913	2.000
28.021	2.547	27.918	0.350
27.963	0.833	27.921	0.300
27.826	0.362	27.926	0.350
27.822		27.922	0.300
27.818		27.923	0.300

SEKSION N. : 21  
KT. PROJEKTI : 28.168  
DIST. PROG. : 353.57  
DIST. PARA. : 8.24  
DIST. PAS. : 8.25

PUNIME GERMI-MBUSHJE	1.128 mq
GERMIM	
MBUSHJE	0.336 mq
MATERIAL MBUSHES	
PAKETA E SHITESAVE	4.000 m
SHITESA E TAFETIT	4.000 m
SHITSE STABILIZANTI	0.998 mq
SHITSE ÇAKULLI	
PUNIME VEPER ARTI	0.092 mq
BORDURA	

SHKALLA 1:100  
KT. REF. 24.000

KUOTE TERRENI	DIST. PUESORE TERRENI	KUOTE PROJEKTI	DIST. PUESORE PROJEKTI
28.085	1.374	28.056	0.410
28.048	0.326	28.048	0.300
28.082	0.502	28.082	0.440
28.033	0.521	28.033	0.350
27.772	0.955	27.772	0.300
27.999	0.377	27.999	0.350
27.998	0.624	27.998	0.300
27.854	0.750	27.854	0.440
27.993	1.287	27.993	2.000
27.986	0.381	27.986	0.350
27.977	0.139	27.977	0.300
27.981	0.912	27.981	2.000
27.996	2.156	27.996	0.440
27.974	0.340	27.974	0.350
27.977	0.794	27.977	0.300
27.986	1.783	27.986	2.000
27.964	0.432	27.964	0.350
27.948	0	27.948	0.300
27.923	0.656	27.923	0.350
27.990	1.184	27.990	0.300
27.883	0.399	27.883	0.350
27.899	1.885	27.899	2.000
27.885		27.885	0.350

SEKSION N. : 22  
KT. PROJEKTI : 28.116  
DIST. PROG. : 361.82  
DIST. PARA. : 8.25  
DIST. PAS. : 13.18



"A. SH. ENGINEERING" sh.p.k

PROJEKTUAR:



APROVIMI I KLIENIT:

PRERUE TERTHORE AKSII

EMERTIMI I FLETES:

PROJEKT: Asistim i rruges ne Zheje (Vitezai)

KLIENI: BASHKIA KURBIN

BASHKIA KURBIN

REPUBLIKA E SHQIPERISE



SH.

VENDODHJA: ROSKOVEC

PUNIME GERMIM-MBUSHJE	1.301 mq
GERMIM	
MBUSHJE	
MATERIAL MBUSHES	0.297 mq
PAKETA E SHITRESAVE	
SHITESA E TAPETIT	4.000 m
SHITESA STABILIZANTI	4.000 m
SHITRESE ÇAKULLI	0.998 mq
PUNIME VEPER ARTI	
BORDURA	0.092 mq

SHKALLA 1:100

KT. REF. 23.000

KUOTE TERRENI	DIST. PUESORE TERRENI	KUOTE PROJEKTI	DIST. PUESORE PROJEKTI
28,186	1.417		
28,144	0.353	0.300	0.300
27,869	0.323	0.440	0.440
27,711	0.417	2.000	2.000
27,561	0.417		
27,377	0.332		
27,329	0.475		
27,233	0.370		
27,511	0.530		
27,999			
27,912	1.104		
27,878			
27,845	1.243		
27,837	1.285		
27,816	0.354	0.300	0.300
27,812	0.354	0.300	0.300
27,809	1.793		
27,714	1.047		
27,778	0.242		
27,756	1.344		
27,813			
27,779	4.529		

SEKSION N. : 23  
 KT. PROJEKTI : 27.976  
 DIST. PRDG. : 375.00  
 DIST. PARA. : 13.18  
 DIST. PAS. : 14.76

PUNIME GERMIM-MBUSHJE	1.285 mq
GERMIM	
MBUSHJE	
MATERIAL MBUSHES	0.293 mq
PAKETA E SHITRESAVE	
SHITESA E TAPETIT	4.000 m
SHITESA STABILIZANTI	4.000 m
SHITRESE ÇAKULLI	0.998 mq
PUNIME VEPER ARTI	
BORDURA	0.092 mq

SHKALLA 1:100

KT. REF. 23.000

KUOTE TERRENI	DIST. PUESORE TERRENI	KUOTE PROJEKTI	DIST. PUESORE PROJEKTI
27,937	0.639		
27,930	2.052		
27,931	0.281	0.300	0.300
27,860	0.525	0.440	0.440
27,862	2.199	2.000	2.000
27,630	0.902		
27,558	0.400		
27,492	0.153		
27,306	0.799		
27,077	0.179	0.300	0.300
27,085	0.181	0.440	0.440
27,723			
27,742			
27,567	0.718		
27,581	0.503		
27,569	0.335		
27,561	2.169		
27,542	0.920		
27,522	2.897		
27,529			
27,676	3.714		
27,661	1.965		

REPUBLIKA E SHQIPERISE

BASHKIA KURBIN

KLIENT: BASHKIA KURBIN



PROJEKT: Astalim i rruge ne Zheje (Vareza)

EMERTIMI I FLETES:

PREJUE TERTHORE AKSI I

APROVIMI I KLIENTIT:



"A.S.H. ENGINEERING" sh.pk

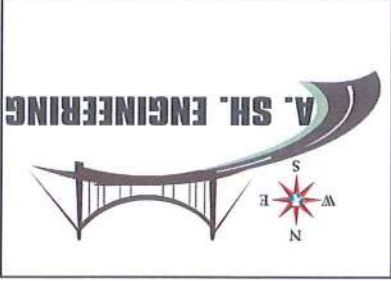

VENDNDODHJA: ROSKOVEC

SH.



PROJEKT: Astalim i rruges ne Zheje (Varrezat)

EMERTIMI I FLETES:

PRERJUE TERTHORE AKSII I

APROVIMI I KLIENTIT:



"A. SH. ENGINEERING" sh.p.k

PROJEKTUA:

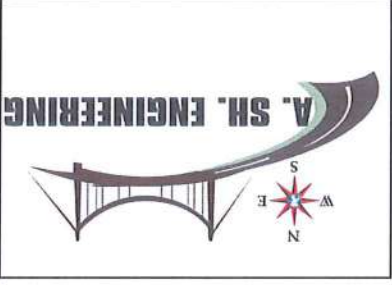

VENDNDODHJA : ROSKOVEC

SH

PUNIME GERMIM-MBUSHJE	1.253 mq
GERMIM	
MBUSHJE	0.443 mq
MATERIAL MBUSHES	
PAKETA E SHITRESAVE	4.000 m
SHITRESA E TAPETIT	4.000 m
SHITRESE STABILIZANTI	0.998 mq
SHITRESE CAKULLI	
PUNIME VEPER ARTI	0.092 mq
BORDURA	

SHKALLA 1:100

KT. REF. 23.000

KUOTE TERRENI	DIST. P.JESORE TERRENI	KUOTE PROJEKTI	DIST. P.JESORE PROJEKTI
27,558	2,039	27,515	0,536
27,481	0,869	27,515	0,500
27,463	1,608	27,015	0,500
27,459	1,357	27,015	0,400
27,395	1,319	27,436	0,440
27,359	0,427	27,280	2,000
26,959	0,364	27,154	0,380
26,857	0,296	27,154	0,300
27,358	2,048	27,154	0,300
27,405	2,047	27,154	0,300
27,318	0,317	27,154	0,300
27,361	2,904	27,154	0,300
27,629	5,848	27,154	0,300
27,628	0,254	27,154	0,300

SEKSION N. : 25  
 KT. PROJEKTI : 27,575  
 DIST. PRDG. : 398,55  
 DIST. PARA. : 8,79  
 DIST. PAS. : 8,79

PUNIME GERMIM-MBUSHJE	1.208 mq
GERMIM	
MBUSHJE	0.750 mq
MATERIAL MBUSHES	
PAKETA E SHITRESAVE	4.000 m
SHITRESA E TAPETIT	4.000 m
SHITRESE STABILIZANTI	0.998 mq
SHITRESE CAKULLI	
PUNIME VEPER ARTI	0.092 mq
BORDURA	

SHKALLA 1:100

KT. REF. 23.000

KUOTE TERRENI	DIST. P.JESORE TERRENI	KUOTE PROJEKTI	DIST. P.JESORE PROJEKTI
27,546	0,702	27,449	0,450
27,525	1,058	27,449	0,500
27,481	2,170	27,449	0,500
27,669	2,085	27,449	0,400
27,523	0,682	27,449	0,500
27,451	0,390	27,449	0,300
27,278	0,343	27,449	0,300
26,978	0,472	27,449	0,300
26,764	0,188	27,449	0,300
26,933	0,429	27,449	0,300
27,349	1,007	27,449	0,300
27,330	0,509	27,449	0,300
27,346	1,760	27,449	0,300
27,378	1,596	27,449	0,300
27,354	0,344	27,449	0,300
27,351	1,335	27,449	0,300
27,301	0,148	27,449	0,300
27,299	3,152	27,449	0,300
27,590	5,012	27,449	0,300
27,590	0,411	27,449	0,300

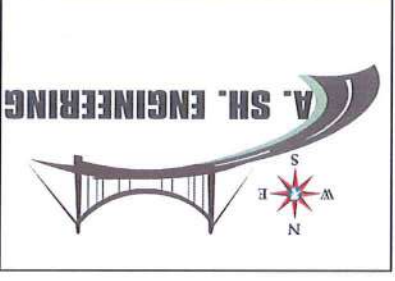

PUNIME GERMIM-MBUSHJE	1.132 mq
GERMIM	
MBUSHJE	
MATERIAL MBUSHES	0.736 mq
PAKETA E SHITRESAVE	
SHTRESA E TAPETIT	4.000 m
SHTRESA STABILIZANTI	4.000 m
SHTRESE CAKULLI	0.998 mq
PUNIME VEPER ARTI	
BORDURA	0.092 mq

SHKALLA 1:100

KT. REF. 23.000

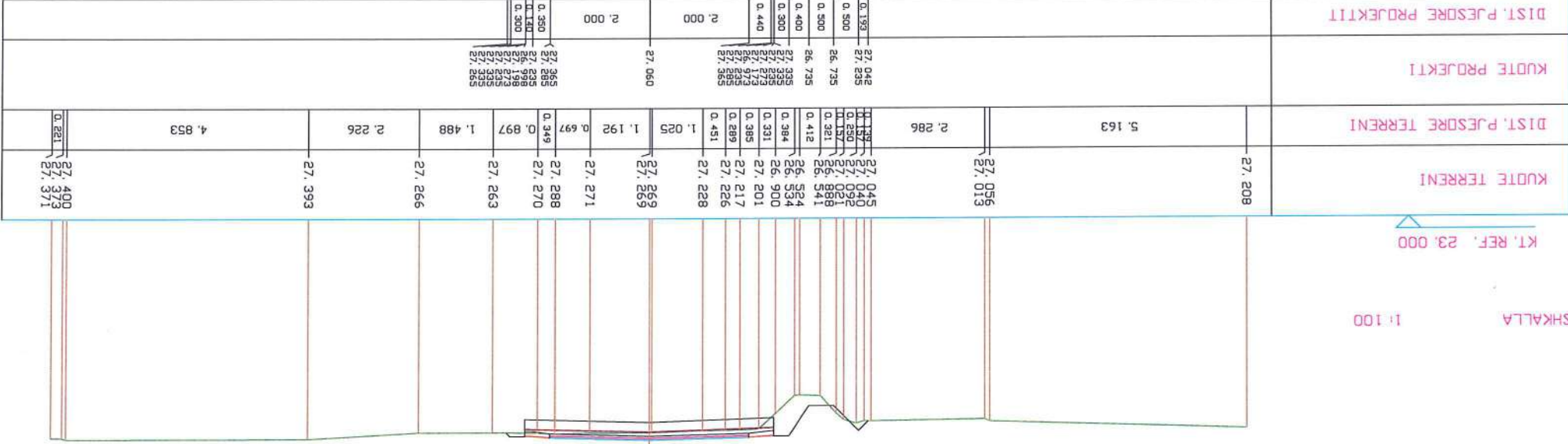

SEKSION N. : 27  
 KT. PROJEKTI : 27.415  
 DIST. PRGJ. : 425.00  
 DIST. PARA. : 17.66  
 DIST. PAS. : 23.96

KUOTE TERRENI	27,208		
DIST. P.JESORE TERRENI	5.163	2	286
KUOTE PROJEKTI	27,045	27,045	27,045
DIST. P.JESORE PROJEKTI	27,045	27,045	27,045
KUOTE TERRENI	27,266		
DIST. P.JESORE TERRENI	1.488		
KUOTE PROJEKTI	27,263	27,263	27,263
DIST. P.JESORE PROJEKTI	27,263	27,263	27,263
KUOTE TERRENI	27,271		
DIST. P.JESORE TERRENI	1.192		
KUOTE PROJEKTI	27,269	27,269	27,269
DIST. P.JESORE PROJEKTI	27,269	27,269	27,269
KUOTE TERRENI	27,271		
DIST. P.JESORE TERRENI	0.697		
KUOTE PROJEKTI	27,270	27,270	27,270
DIST. P.JESORE PROJEKTI	27,270	27,270	27,270
KUOTE TERRENI	27,271		
DIST. P.JESORE TERRENI	0.997		
KUOTE PROJEKTI	27,268	27,268	27,268
DIST. P.JESORE PROJEKTI	27,268	27,268	27,268
KUOTE TERRENI	27,266		
DIST. P.JESORE TERRENI	1.488		
KUOTE PROJEKTI	27,266	27,266	27,266
DIST. P.JESORE PROJEKTI	27,266	27,266	27,266
KUOTE TERRENI	27,393		
DIST. P.JESORE TERRENI	2.226		
KUOTE PROJEKTI	27,400	27,400	27,400
DIST. P.JESORE PROJEKTI	27,400	27,400	27,400

PUNIME GERMIM-MBUSHJE	1.650 mq
GERMIM	
MBUSHJE	
MATERIAL MBUSHES	0.296 mq
PAKETA E SHITRESAVE	
SHTRESA E TAPETIT	4.000 m
SHTRESA STABILIZANTI	4.000 m
SHTRESE CAKULLI	0.998 mq
PUNIME VEPER ARTI	
BORDURA	0.092 mq

SHKALLA 1:100

KT. REF. 22.000

KUOTE TERRENI	26,677		
DIST. P.JESORE TERRENI	3.394		
KUOTE PROJEKTI	26,903	26,903	26,903
DIST. P.JESORE PROJEKTI	26,903	26,903	26,903
KUOTE TERRENI	26,677		
DIST. P.JESORE TERRENI	1.654		
KUOTE PROJEKTI	26,949	26,949	26,949
DIST. P.JESORE PROJEKTI	26,949	26,949	26,949
KUOTE TERRENI	26,970		
DIST. P.JESORE TERRENI	1.282		
KUOTE PROJEKTI	26,970	26,970	26,970
DIST. P.JESORE PROJEKTI	26,970	26,970	26,970
KUOTE TERRENI	26,994		
DIST. P.JESORE TERRENI	0.549		
KUOTE PROJEKTI	27,003	27,003	27,003
DIST. P.JESORE PROJEKTI	27,003	27,003	27,003
KUOTE TERRENI	27,090		
DIST. P.JESORE TERRENI	0.709		
KUOTE PROJEKTI	27,097	27,097	27,097
DIST. P.JESORE PROJEKTI	27,097	27,097	27,097
KUOTE TERRENI	27,051		
DIST. P.JESORE TERRENI	4.907		



PUNIME GERMIM-MBUSHJE	0.977 mq
GERMIM	
MBUSHJE	0.342 mq
MATERIAL MBUSHES	
PAKETA E SHITESAVE	4.000 m
SHTRESA E TAPETIT	4.000 m
SHTRESA STABILIZANTI	4.000 m
SHTRESE CAKULLI	0.998 mq
PUNIME VEPPER ARTI	0.092 mq
BORDURA	

SEKSION N. : 29  
 KT. PROJEKTI : 27.035  
 DIST. PRDG. : 455.45  
 DIST. PARA. : 6.49  
 DIST. PAS. : 6.49

SHKALLA	KT. REF. 22.000	KUOTE TERRENI	DIST. PUESORE TERRENI	KUOTE PROJEKTI	DIST. PUESORE PROJEKTI
1:100	26.885	26.882	1.066	26.861	0.215
		26.884	3.185	26.856	0.300
1:100	26.879	26.875	5.432	26.853	0.440
		26.885	0.998	26.879	2.000
1:100	26.928	26.928	1.119	26.915	0.350
		26.928	0.398	26.915	0.300
1:100	26.997	26.997	2.062	26.985	0.350
		26.997	0.398	26.985	0.300

EMERTIMI I FLETES:  
 PRRUE TERTHORE AKSI I

APROVIMI I KLIENIT:

PROJEKT: Astalim i rruges ne Zheje (Varezi)

KLIENI: BASHKIA KURBIN

BASHKIA KURBIN

REPUBLIKA E SHQIPERISE



PUNIME GERMIM-MBUSHJE	1.032 mq
GERMIM	
MBUSHJE	0.342 mq
MATERIAL MBUSHES	
PAKETA E SHITESAVE	4.000 m
SHTRESA E TAPETIT	4.000 m
SHTRESA STABILIZANTI	4.000 m
SHTRESE CAKULLI	0.998 mq
PUNIME VEPPER ARTI	0.092 mq
BORDURA	

SEKSION N. : 30  
 KT. PROJEKTI : 26.954  
 DIST. PRDG. : 461.94  
 DIST. PARA. : 6.49  
 DIST. PAS. : 13.06

SHKALLA	KT. REF. 22.000	KUOTE TERRENI	DIST. PUESORE TERRENI	KUOTE PROJEKTI	DIST. PUESORE PROJEKTI
1:100	26.710	26.748	0.938	26.733	0.215
		26.733	1.454	26.716	0.300
1:100	26.787	26.710	0.640	26.787	0.440
		26.787	4.131	26.772	2.000
1:100	26.829	26.772	3.221	26.795	0.350
		26.772	0.724	26.773	0.300
1:100	26.897	26.829	0.577	26.796	0.350
		26.829	0.766	26.818	0.300
1:100	26.897	26.897	0.519	26.819	0.350
		26.897	1.807	26.898	0.300

PROJEKTUAR:

"A.S.H. ENGINEERING" sh.pk

VENDNDODHJA : ROSKOVEC

SH.

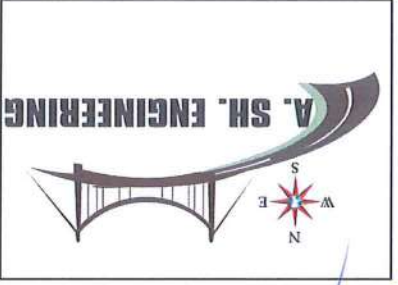

PUNIME GERMIM-MBUSHJE	1.202 mq
GERMIM	
MBUSHJE	0.378 mq
PAKETA E SHITESAVE	
SHITESA E TAPETIT	4.000 m
SHITESA STABILIZANTI	4.000 m
SHITESA CAKULLI	0.998 mq
PUNIME VEPER ARTI	
BORDURA	0.092 mq

SHKALLA 1:100

KT. REF. 22.000

26,579	26,447	7,795	1,496	0,875	0,411	0,625	0,798	0,162	0,607	0,827	0,814	0,311	0,350	0,300
26,435	26,709	26,609	26,517	26,447	26,509	26,527	26,599	26,647	26,717	26,799	26,892	26,992	27,100	27,200
0,275	0,300	0,440	2,000	2,000	2,000	2,000	2,000	2,000	2,000	2,000	2,000	2,000	2,000	2,000
DIST. PUESORE PROJEKTI														
KUOTE PROJEKTI														
DIST. PUESORE TERRENI														
KUOTE TERRENI														

SEKSION N : 31  
 KT. PROJEKTI : 26.789  
 DIST. PRDG. : 475.00  
 DIST. PARA. : 13.06  
 DIST. PAS. : 21.98

PUNIME GERMIM-MBUSHJE	1.805 mq
GERMIM	
MBUSHJE	0.260 mq
PAKETA E SHITESAVE	
SHITESA E TAPETIT	4.000 m
SHITESA STABILIZANTI	4.000 m
SHITESA CAKULLI	0.998 mq
PUNIME VEPER ARTI	
BORDURA	0.092 mq

SHKALLA 1:100

KT. REF. 22.000

26,462	26,453	5,078	3,790	0,624	0,508	0,797	1,136	0,856	0,542	0,407	0,407	0,350	0,300	0,300
26,465	26,466	26,443	26,443	26,443	26,443	26,467	26,492	26,511	26,504	26,498	26,490	26,486	26,445	26,223
0,300	0,440	2,000	2,000	2,000	2,000	2,000	2,000	2,000	2,000	2,000	2,000	2,000	2,000	2,000
DIST. PUESORE PROJEKTI														
KUOTE PROJEKTI														
DIST. PUESORE TERRENI														
KUOTE TERRENI														

"A.S.H. ENGINEERING" sh.p.k

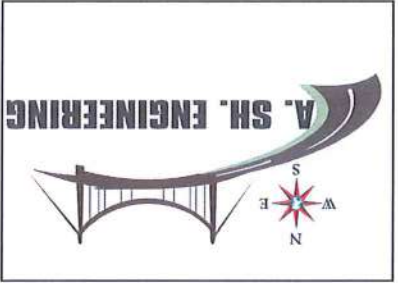

SH.

VENDODHJA : ROSKOVEC

PROJEKTUAR :



APROVIMI I KLIENIT :

PREJTE TERTHORE AKSI I

EMERTIMI I FLETES :

PROJEKT : Astalim i rruges ne Zheje (Vareza)

KLIENI : BASHKIA KURBIN

BASHKIA KURBIN

REPUBLIKA E SHQPERISE



# PROJEKT ZBATIMI

Asfaltim i rruges ne Zheje (Varrezat)  
AKSI 2

SH

VENDOSHA: ROSKOVEC

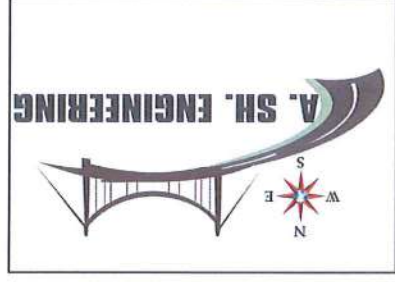

"A. SH. ENGINEERING" sh.p.k

PROJEKTUAR:



APROVIMI I KLIENIT:

KAPAK

EMERTIMI I FLETES:

PROJEKT: Asfaltim i rruges ne Zheje (Varrezat)

KLIENIT: BASHKIA KURBIN



BASHKIA KURBIN

REPUBLIKA E SHQIPERISE



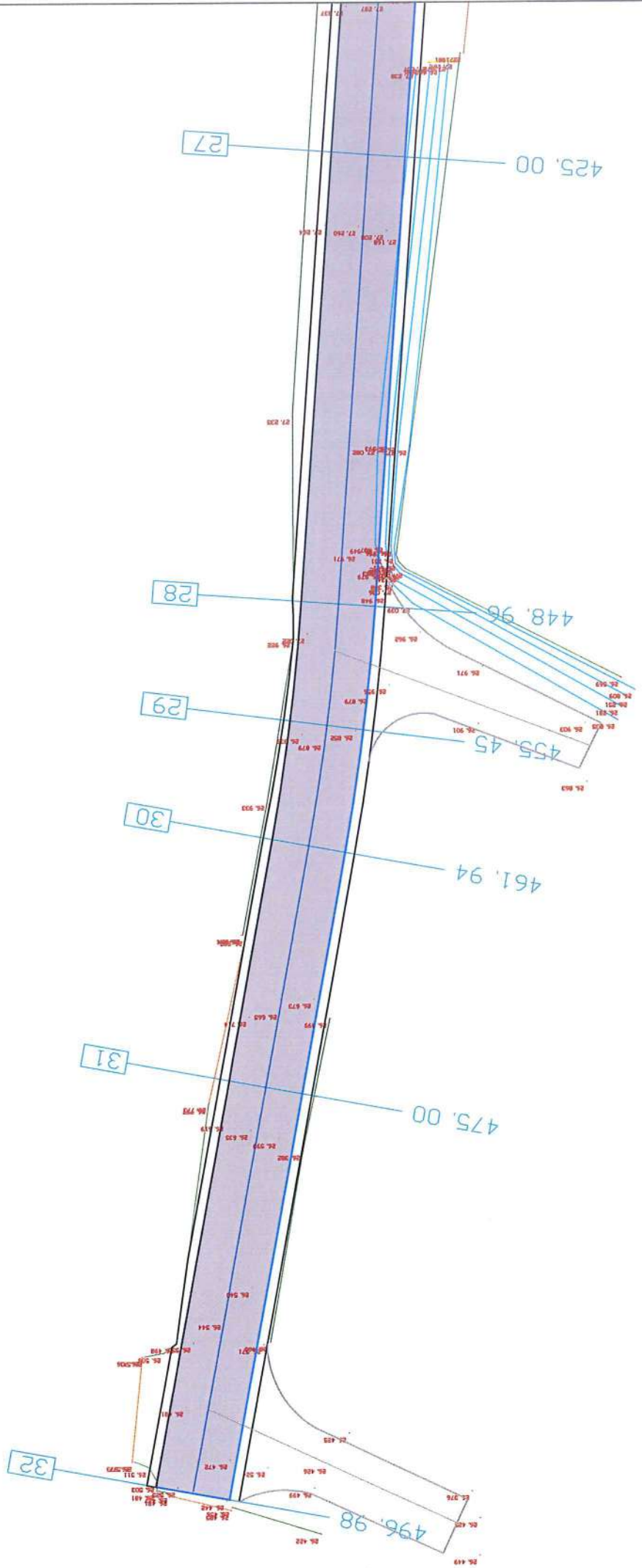

SH.

VENDOSHJA : ROSKOVEC



"A.SH. ENGINEERING" sh.pk

PROJEKTUAR:



APROVIMI I KLIENIT:

PLANIMETRIA PERGJITSHME

EMERTIMI I FLETES:

PROJEKT:Avlaim Ruga Stationi i Trent -Permore Mamuraz

KLIENI: BASHKIA KURBIN

BASHKIA KURBIN

REPUBLIKA E SHQIPERISE



SH.

VENDOSHJA : ROSKOVEC

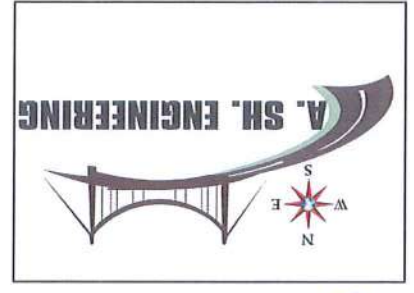

"A.S.H. ENGINEERING" sh.p.k

PROJEKTUAR:



APROVIMI I KLIENIT:

EMERTIMI I FLETES:  
PLANIMETRIA PERGJITHSHME

PROJEKT: Asajm Rrugë Stationi Treni-Perimore Murriz

KLIENI: BASHKIA KURBIN

BASHKIA KURBIN

REPUBLIKA E SHQIPERISE

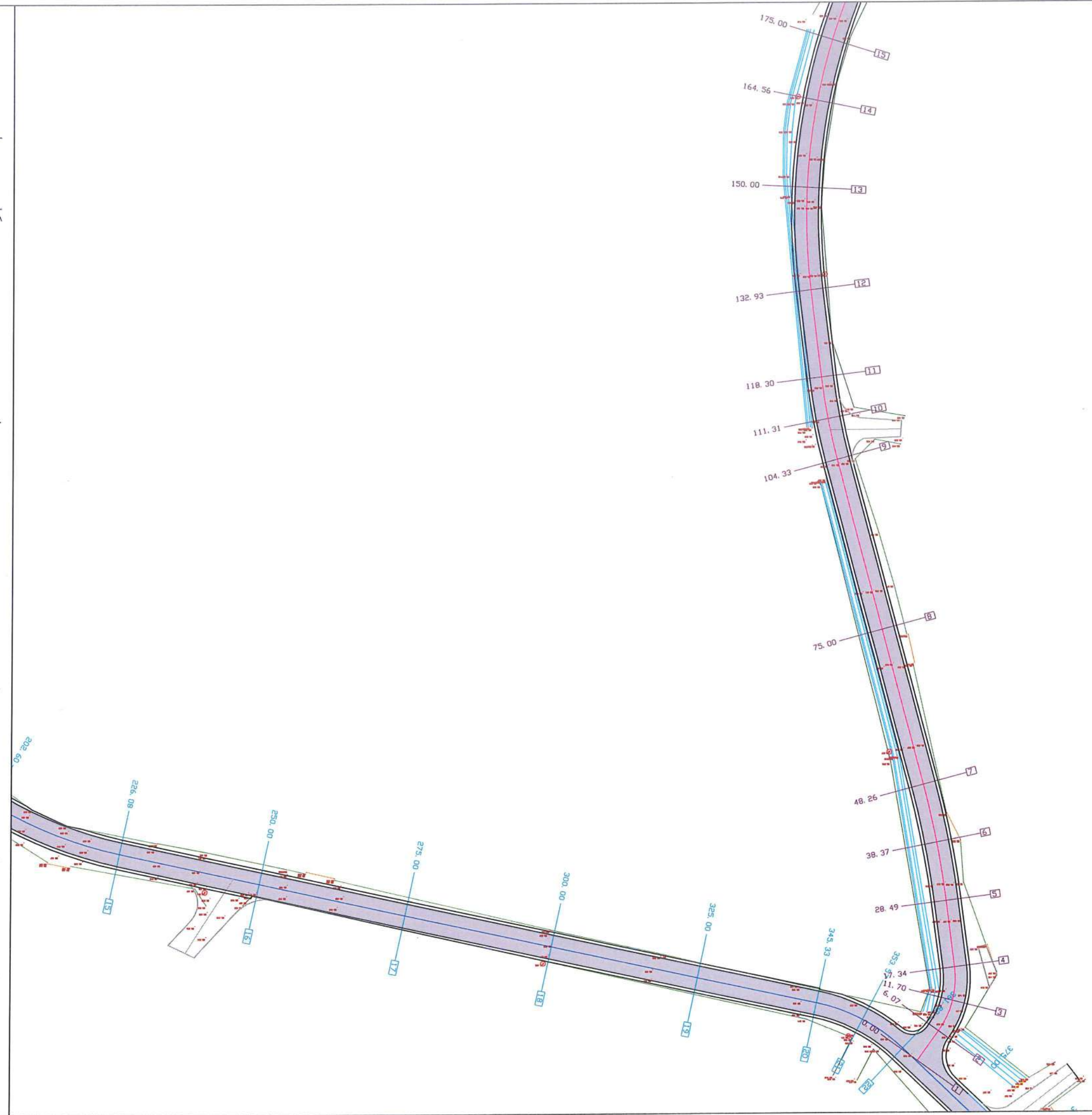

SH

VENDODHJA : ROSKOVEC

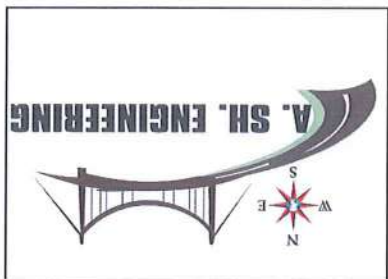

"A.S.H. ENGINEERING" sh.p.k

PROJEKTUAR:



APROVIMI I KLIENIT:

EMERTIMI I FLETES:  
PLANIMETRIA PERGJITHSHME

PROJEKT: Asfaltim Rruge Stacioni I Trent - Fermore Mamuraz

KLIENI: BASHKIA KURBIN

BASHKIA KURBIN

REPUBLIKA E SHQIPERISE

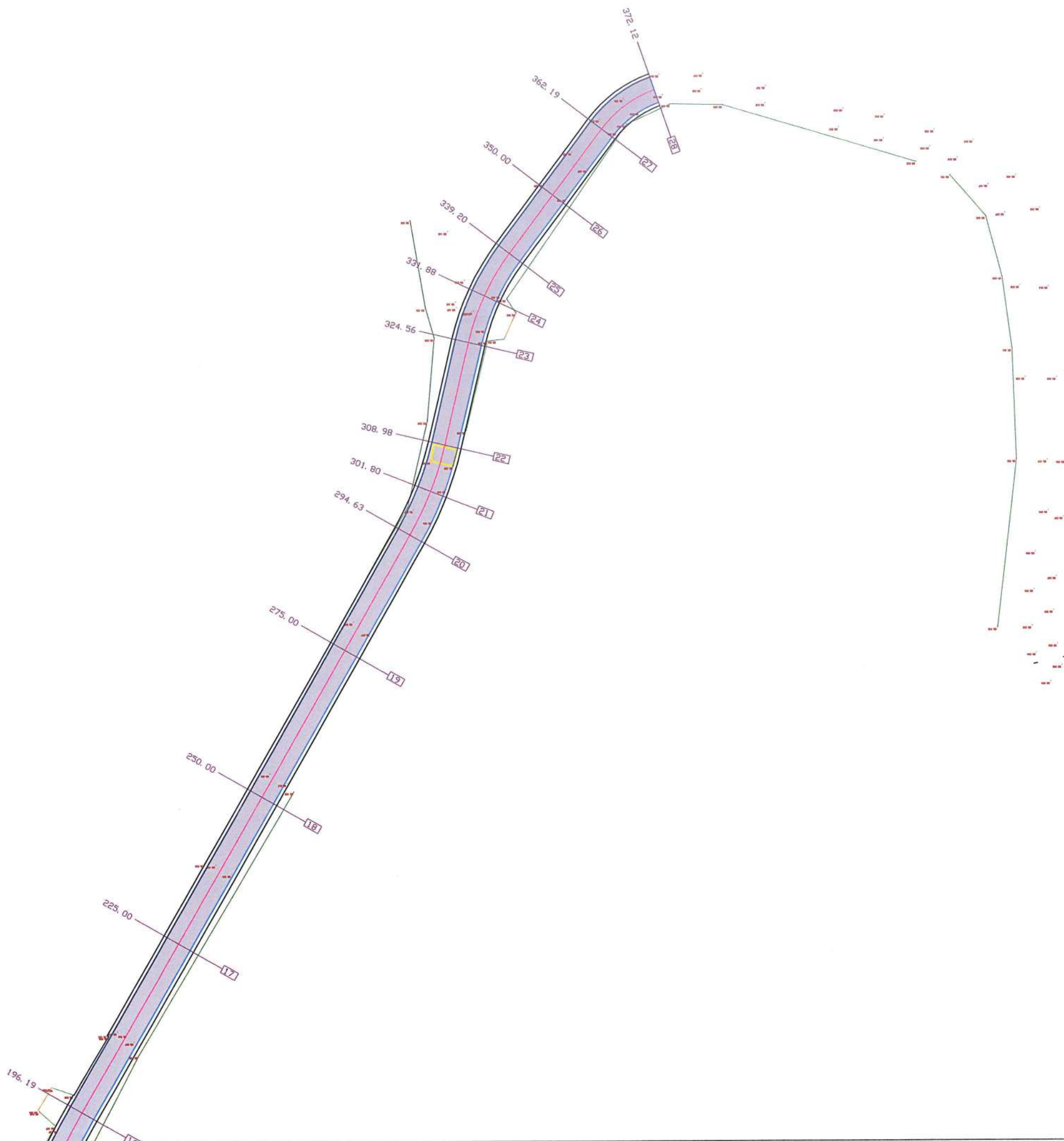

# PROFIL TIP

## MENYRA E NDERTIMIT TE RRUGES ZHEJE

### AKSI "2" SEKSIONI 1-15

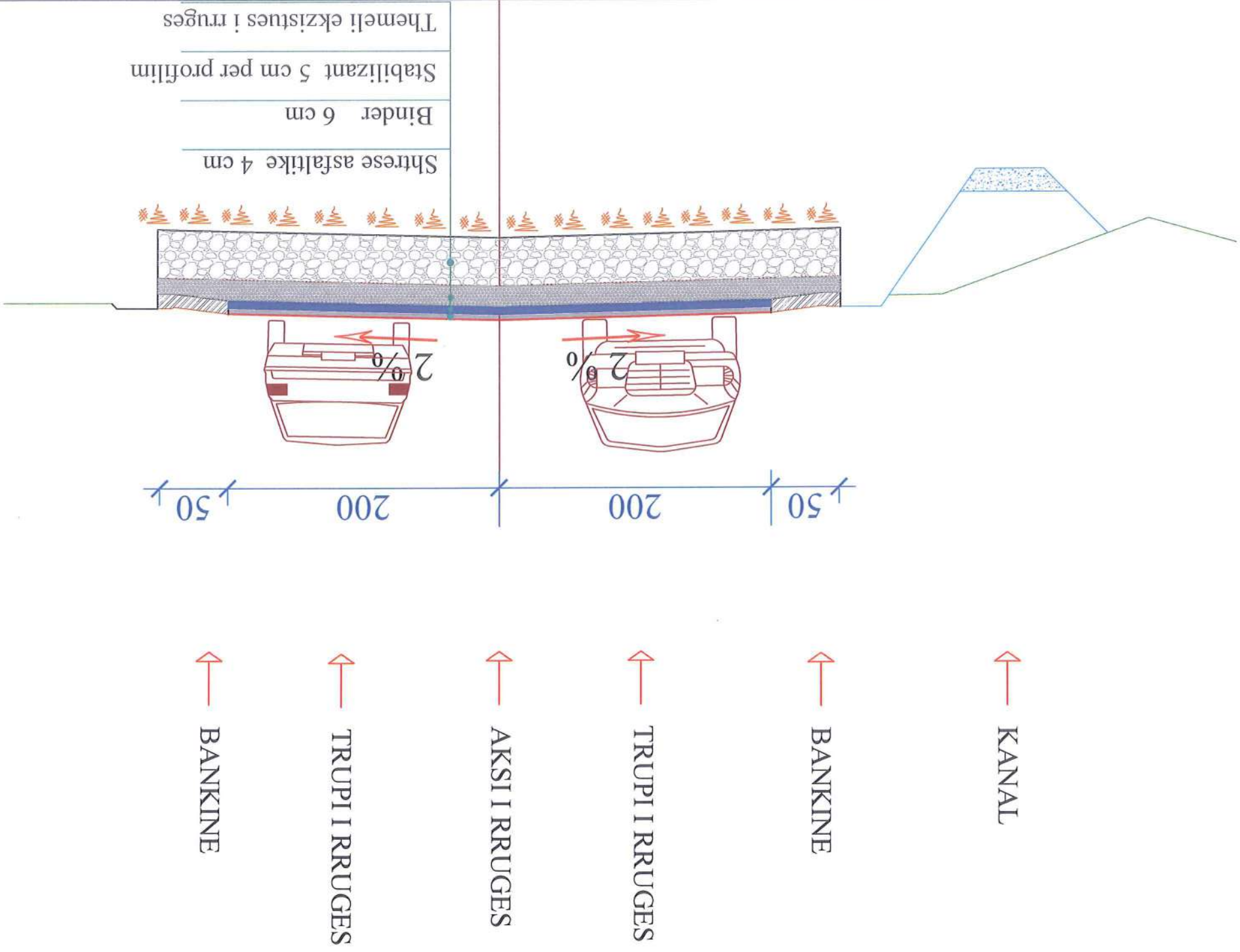

REPUBLIKA E SHQIPERISE

BASHKIA KURBIN

KLIENT: BASHKIA KURBIN

PROJEKT: Asfaltim i rruges ne Zheje (Varrez)

EMERTIMI I FLETES:

PROFIL TIP

APROVIMI I KLIENTIT:



PROJEKTUAR:

"A.S.H. ENGINEERING" sh.p.k

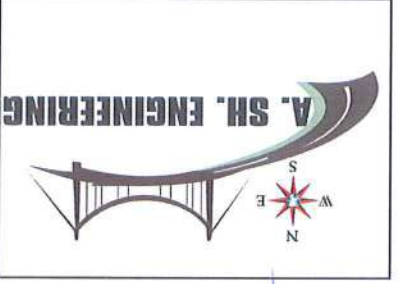

VENDNDODHJA: ROSKOVEC

SH.

# PROFIL TIP

## MENYRA E NDERTIMIT TE RRUGES ZHEJE

### AKSI "2" SEKSIONI 16-28

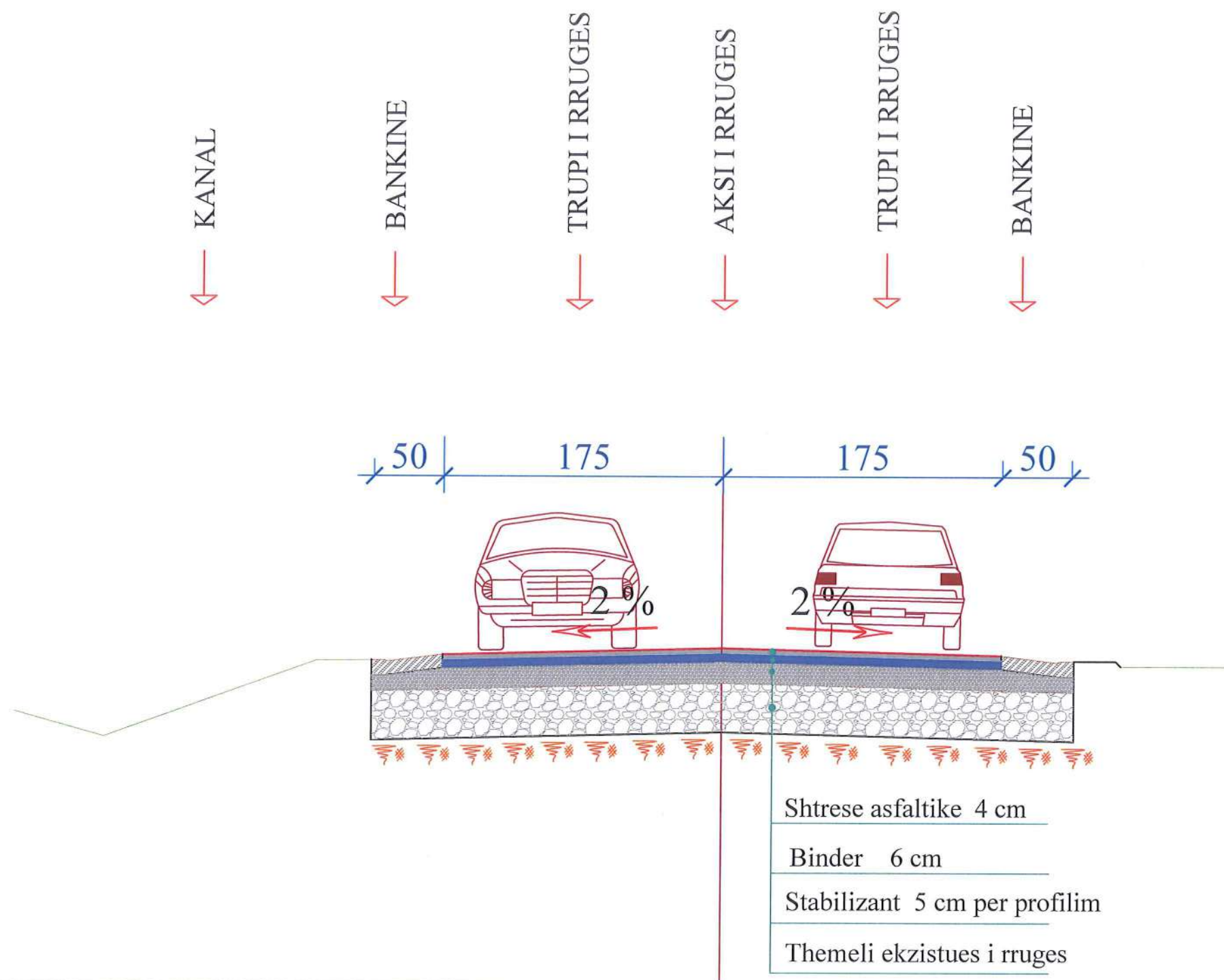

REPUBLIKA E SHQIPERISE

BASHKIA KURBIN

KLIENT: BASHKIA KURBIN

PROJEKT: Asfaltim i rruges ne Zheje (Varrezat)

EMERTIMI I FLETES:  
PROFIL TIP

APROVIMI I KLIENTIT:

PROJEKTUAR:

"A.SH. ENGINEERING" sh.pk

E:\sidorela\1. Rr Stac Treni\A.sh logo.jpg

VENDNDODHJA : ROSKOVEC

SH.



PRRUE GJATESORE

REPUBLIKA E SHQIPERISE

BASHKIA KURBIN

KLIENT: BASHKIA KURBIN



PROJEKT: Asthim i rruges ne Zhele (Varrezat)

EMERTIMI I FLETES:

PRRUE GJATESORE AKSI 2

APROVIMI I KLIENTIT:



"A.SH. ENGINEERING" sh.p.k

PROJEKTUAR:

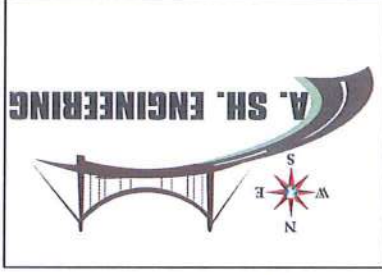

VENDNDODHJA: ROSKOVEC

SH

NR. SEKSIONI	DISTANCA PUESORE	DISTANCA PROGRESIVE	KUOTE TERRENI	KUOTE PROJEKTI	DIFERENCA KUOTE	HEKTOMETER	ECURIA PLANIMETRIKE
1	0.07	0.000	27.949	28.069	0.120	0	1
2	5.62	4.970	27.955	28.113	0.158	1	2
3	6.25	11.700	28.086	28.134	0.048	2	3
4	6.83	17.340	28.159	28.196	0.037	3	4
5	9.88	28.490	28.223	28.278	0.055	4	5
6	9.89	38.370	28.271	28.350	0.079	5	6
7	26.74	48.840	28.303	28.423	0.120	6	7
8	29.33	75.000	28.593	28.636	0.043	7	8
9	6.98	104.300	28.793	28.874	0.080	8	9
10	6.99	111.310	28.753	28.934	0.180	9	10
11	14.63	118.300	28.883	29.029	0.146	10	11
12	17.07	132.930	29.158	29.330	0.172	11	12
13	14.56	150.000	29.531	29.632	0.101	12	13
14	10.44	164.360	29.600	29.811	0.211	13	14
15	21.19	175.000	29.645	29.936	0.291	14	15
16	28.81	196.190	30.097	30.140	0.043	15	16
17	25.00	225.000	30.407	30.477	0.070	16	17
18	25.00	250.000	30.524	30.738	0.214	17	18
19	19.63	275.000	30.328	30.594	0.266	18	19
20	7.17	294.000	30.123	30.302	0.179	19	20
21	7.18	301.800	30.108	30.256	0.148	20	21
22	15.58	308.980	30.240	30.232	-0.008	21	22
23	7.32	324.360	30.144	30.241	0.097	22	23
24	7.32	331.880	30.162	30.243	0.081	23	24
25	10.80	339.800	30.262	30.179	-0.083	24	25
26	12.19	350.000	30.208	30.231	0.023	25	26
27	9.93	362.190	30.291	30.636	0.345	26	27
28		372.180	29.615	29.673	0.058	27	28

SHKALLA VERTIKAL 1:200  
SHKALLA HORIZONT 1:1000  
KT. REF. 21.000

NIVELLETA	DIF. KURASH	DISTANCA	PJERRESIA
h = 0.50	L = 48.26	i = 0.00734	
h = 0.50	L = 63.24	i = 0.00798	
h = 0.72	L = 38.50	i = 0.01878	
h = 1.11	L = 100.39	i = 0.01102	
h = -0.53	L = 51.41	i = -0.01029	
h = 0.02	L = 34.37	i = 0.00058	
h = -0.64	L = 17.78	i = -0.03615	
h = 0.46	L = 0	i = 0	

PUNIME GERMIM-MBUSHJE	1.941 mq
GERMIM	
MBUSHJE	0.293 mq
MATERIAL MBUSHJES	
PAKETA E SHITRESAVE	
SHITRESA E TAPETIT	4.000 m
SHITRESA STABILIZANTI	4.000 m
SHITRESA ÇAKULLI	0.998 mq
PUNIME VEPER ARTI	0.092 mq
BORDURA	

SHKALLA 1:100

KT. REF. 23.000

KUOTE TERRENI	DIST. P.JESORE TERRENI	KUOTE PROJEKTI	DIST. P.JESORE PROJEKTI
28.006	3.234	27.973	0.418
27.971	0.204	27.969	0.204
27.975	4.128	27.975	0.500
27.982	0.660	27.982	0.400
27.949	1.356	27.949	0.440
27.913	1.819	27.913	2.000
27.858	5.120	27.858	0.380
27.848	1.630	27.848	0.120
27.857	1.431	27.857	0.300

SEKSION N. : 1  
 KT. PROJEKTI : 28.069  
 DIST. PRG. : 0.00  
 DIST. PAS. : 6.07

PUNIME GERMIM-MBUSHJE	1.507 mq
GERMIM	
MBUSHJE	0.354 mq
MATERIAL MBUSHJES	
PAKETA E SHITRESAVE	
SHITRESA E TAPETIT	4.000 m
SHITRESA STABILIZANTI	4.000 m
SHITRESA ÇAKULLI	0.998 mq
PUNIME VEPER ARTI	0.092 mq
BORDURA	

SHKALLA 1:100

KT. REF. 23.000

KUOTE TERRENI	DIST. P.JESORE TERRENI	KUOTE PROJEKTI	DIST. P.JESORE PROJEKTI
27.826	3.771	27.728	0.388
27.737	1.117	27.737	0.485
27.751	0.485	27.751	0.775
27.777	2.398	27.777	0.500
27.852	0.433	27.852	0.500
27.825	0.400	27.825	0.400
27.828	0.203	27.828	0.300
27.986	0.523	27.986	0.440
27.989	1.967	27.989	2.000
27.958	0.178	27.958	0.380
27.935	2.398	27.935	0.380
27.922	0.848	27.922	0.380
27.936	0.300	27.936	0.380
27.946	0.310	27.946	0.380
27.945	0.737	27.945	0.380
27.949	5.406	27.949	0.380
27.991		27.991	0.380

REPUBLIKA E SHQIPERISE

BASHKIA KURBIN

KLIENT: BASHKIA KURBIN



PROJEKT: Aftahim i rruges ne Zheje (Varrezat)

EMERTIMI I FLETES:

PRERJE TERTHORE AKSI 2

APROVIMI I KLIENTIT:



PROJEKTUAR:

"A.S.H. ENGINEERING" sh.p.k

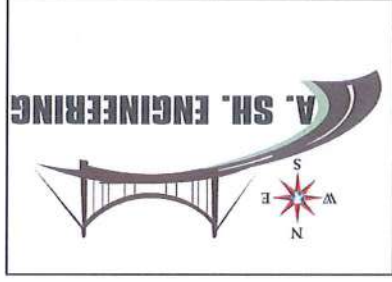

VENDNDODHJA : ROSKOVEC

SH.

PUNIME GERMIM-MBUSHJE	1.440 mq
GERMIM	
MBUSHJE	
MATERIAL MBUSHES	0.582 mq
PAKETA E SHITRESAVE	4.000 m
SHTRESA E TAPETIT	4.000 m
SHTRESE STABILIZANTI	4.000 m
SHTRESE ÇAKULLI	0.999 mq
BORDURA	0.092 mq

SHKALLA 1:100

KT. REF. 24.000

KUOTE TERRENI	DIST. PËSDORE TERRENI	KUOTE PROJEKTI	DIST. PËSDORE PROJEKTI
27.833	4.100		
27.726	0.345	27.587	0.298
27.646	1.245	27.884	0.500
27.526		27.384	0.500
27.428		27.384	0.400
27.649		27.984	0.300
27.592		27.599	0.440
27.428		27.884	2.000
27.592		27.799	
28.086	1.290		
28.086	0.232		
28.144	0.701		
28.166	1.413		
28.206			
28.266			
28.327	5.425		
28.328	0.232		

SEKSION N. : 3  
 KT. PROJEKTI : 28.154  
 DIST. PRDG. : 11.70  
 DIST. PARA. : 5.63  
 DIST. PAS. : 5.64

PUNIME GERMIM-MBUSHJE	2.020 mq
GERMIM	
MBUSHJE	
MATERIAL MBUSHES	0.522 mq
PAKETA E SHITRESAVE	4.000 m
SHTRESA E TAPETIT	4.000 m
SHTRESE STABILIZANTI	4.000 m
SHTRESE ÇAKULLI	0.999 mq
BORDURA	0.092 mq

SHKALLA 1:100

KT. REF. 24.000

KUOTE TERRENI	DIST. PËSDORE TERRENI	KUOTE PROJEKTI	DIST. PËSDORE PROJEKTI
27.857	3.486		
27.798	0.295	27.508	0.418
27.708	1.386	27.926	0.500
27.649		27.426	0.500
27.526		27.426	0.400
27.428		27.948	0.300
27.649		27.599	0.440
27.592		27.884	2.000
27.428		27.799	
28.112	1.740		
28.112	0.422		
28.159	0.402		
28.170	0.641		
28.166	1.586		
28.181	1.624		
28.213	1.472		
28.256	1.167		
28.341	0.530		
28.388	1.010		
28.339	2.478		
28.263			

SH.

VENDOBHJA : ROSKOVEC



"A.SH. ENGINEERING" sh.p.k

PROJEKTUAR:

*[Handwritten signature]*

APROVIMI I KLIENIT:

PREJUE TERTHORE AKSI 2

EMERTIMI I FLETES:

PROJEKT: Astalim i rruges ne Zhele (Varrezat)

KLIENI: BASHKIA KURBIN

BASHKIA KURBIN

REPUBLIKA E SHQIPERISE



PUNIME GERMIM-MBUSHJE	2.283	mq
GERMIM		
MBUSHJE	0.456	mq
MATERIAL MBUSHES		
PAKETË E SHITESAVE	4.000	m
SHITESA E TAPETIT	4.000	m
SHITESË STABILIZANTI	0.998	mq
SHITESË ÇAKULLI		
PUNIME VEPRËR ARTI	0.092	mq
BORDURA		

SHKALLA 1:100

KT. REF. 24.000

KUOTE TERRENI	DIST. PËSDORË TERRENI	KUOTE PROJEKTI	DIST. PËSDORË PROJEKTI
28.045	3.562		
27.974	0.182	27.501	0.597
27.971	0.182	28.098	0.500
27.562	0.957	27.598	0.500
27.537	0.406	27.598	0.400
27.488	0.293	27.598	0.400
27.537	0.144	27.598	0.300
27.537	0.144	27.598	0.440
27.537	1.253	27.598	2.000
28.214	0.173	27.923	2.000
28.209	0.958		
28.227	0.597		
28.225	0.385		
28.223	0.809		
28.235	0.764		
28.253	0.874		
28.302	1.061		
28.364	0.956		
28.364	2.385		
28.391	1.397		
28.298	1.286		
28.299			

SEKSION N. : 5

KT. PROJEKTI : 28.278

DIST. PROG. : 28.49

DIST. PARA. : 11.15

DIST. PAS. : 9.88

KUOTE TERRENI	DIST. PËSDORË TERRENI	KUOTE PROJEKTI	DIST. PËSDORË PROJEKTI
28.207	3.939		
28.133	0.384	28.294	0.121
28.005	0.124	28.294	0.380
27.672	0.591	28.294	0.300
27.635	0.126	28.294	0.400
27.595	0.180	28.294	0.400
27.799	0.271	28.294	0.300
27.744	0.221	28.294	0.440
27.595	0.458	28.294	2.000
28.195	0.764	28.294	2.000
28.237	0.636	28.294	2.000
28.229	0.311	28.294	2.000
28.254	0.590	28.294	2.000
28.244	1.355	28.294	2.000
28.271	0.434	28.294	2.000
28.273	1.046	28.294	2.000
28.288	0.713	28.294	2.000
28.288	1.709	28.294	2.000
28.290	6.028	28.294	2.000
28.371		28.294	2.000

SHKALLA 1:100

KT. REF. 24.000

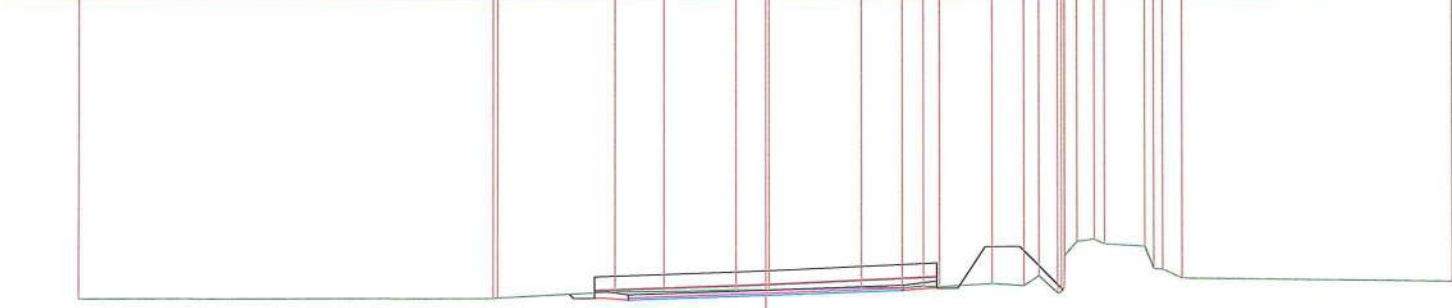

SEKSION N. : 6

KT. PROJEKTI : 28.350

DIST. PROG. : 38.37

DIST. PARA. : 9.88

DIST. PAS. : 9.89

PUNIME GERMIM-MBUSHJE	1.915	mq
GERMIM		
MBUSHJE	0.285	mq
MATERIAL MBUSHES		
PAKETË E SHITESAVE	4.000	m
SHITESA E TAPETIT	4.000	m
SHITESË STABILIZANTI	0.998	mq
SHITESË ÇAKULLI		
PUNIME VEPRËR ARTI	0.092	mq
BORDURA		

SHKALLA 1:100

KT. REF. 24.000

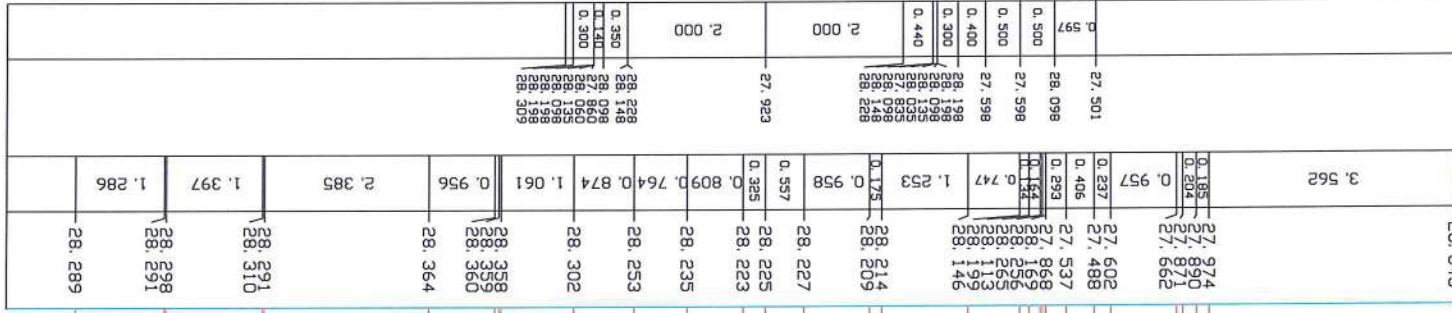

REPUBLIKA E SHQIPËRISE

BASHKIA KURBIN

KLIENT: BASHKIA KURBIN

PROJEKT: Astalim i rruges ne Zheje (Varrezat)

EMERTIMI I FLETES:

PREJE TERTHORE AKSI 2

APROVIMI I KLIENIT:

PROJEKTUAR:

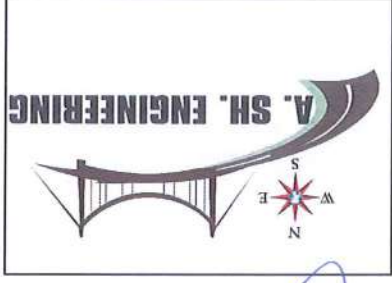

"A. SH. ENGINEERING" sh.p.k.

VENDODHJA : ROSKOVEC

SH.



PUNIME GERMI-MBUSHJE	1.658 mq
GERMIM	
MBUSHJE	
MATERIAL MBUSHES	0.521 mq
PAKETA E SHITRESAVE	
SHITRESA E TAPETIT	4.000 m
SHITRESA STABILIZANTI	4.000 m
SHITRESA ÇAKULLI	0.998 mq
PUNIME VEPER ARTI	
BORDURA	0.092 mq

SHKALLA 1:100

KT. REF. 24.000

KUOTE TERRENI	28.363	28.348	1.791	3.158		
DIST. PJESORE TERRENI					4.778	1.532
KUOTE PROJEKTI						
DIST. PJESORE PROJEKTI						

SEKSION N. : 7  
 KT. PROJEKTI : 28.423  
 DIST. PRDG. : 48.26  
 DIST. PARA. : 9.89  
 DIST. PAS. : 26.74

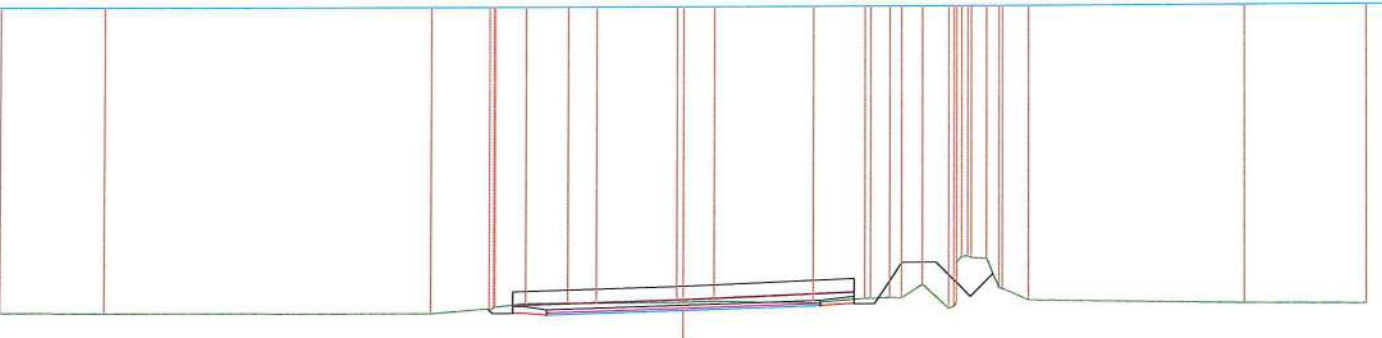

28.363	28.348	1.791	3.158						
26.903	26.903	26.903	26.903	26.903	26.903	26.903	26.903	26.903	26.903
0.387	0.182	0.282	0.282	0.282	0.282	0.282	0.282	0.282	0.282
27.904	28.232	27.732	27.732	27.732	27.732	27.732	27.732	27.732	27.732
0.388	0.500	0.500	0.500	0.500	0.500	0.500	0.500	0.500	0.500
2.000	2.000	2.000	2.000	2.000	2.000	2.000	2.000	2.000	2.000
28.068	28.068	28.068	28.068	28.068	28.068	28.068	28.068	28.068	28.068
0.390	0.390	0.390	0.390	0.390	0.390	0.390	0.390	0.390	0.390
28.484	28.484	28.484	28.484	28.484	28.484	28.484	28.484	28.484	28.484
0.300	0.300	0.300	0.300	0.300	0.300	0.300	0.300	0.300	0.300
28.617	28.617	28.617	28.617	28.617	28.617	28.617	28.617	28.617	28.617
0.446	0.446	0.446	0.446	0.446	0.446	0.446	0.446	0.446	0.446
28.316	28.316	28.316	28.316	28.316	28.316	28.316	28.316	28.316	28.316
0.415	0.415	0.415	0.415	0.415	0.415	0.415	0.415	0.415	0.415
28.309	28.309	28.309	28.309	28.309	28.309	28.309	28.309	28.309	28.309
1.177	1.177	1.177	1.177	1.177	1.177	1.177	1.177	1.177	1.177
0.453	0.453	0.453	0.453	0.453	0.453	0.453	0.453	0.453	0.453
28.294	28.294	28.294	28.294	28.294	28.294	28.294	28.294	28.294	28.294
2.000	2.000	2.000	2.000	2.000	2.000	2.000	2.000	2.000	2.000
28.068	28.068	28.068	28.068	28.068	28.068	28.068	28.068	28.068	28.068
0.437	0.437	0.437	0.437	0.437	0.437	0.437	0.437	0.437	0.437
28.518	28.518	28.518	28.518	28.518	28.518	28.518	28.518	28.518	28.518
0.346	0.346	0.346	0.346	0.346	0.346	0.346	0.346	0.346	0.346
28.590	28.590	28.590	28.590	28.590	28.590	28.590	28.590	28.590	28.590
0.918	0.918	0.918	0.918	0.918	0.918	0.918	0.918	0.918	0.918
28.605	28.605	28.605	28.605	28.605	28.605	28.605	28.605	28.605	28.605
0.824	0.824	0.824	0.824	0.824	0.824	0.824	0.824	0.824	0.824
28.609	28.609	28.609	28.609	28.609	28.609	28.609	28.609	28.609	28.609
1.262	1.262	1.262	1.262	1.262	1.262	1.262	1.262	1.262	1.262
0.423	0.423	0.423	0.423	0.423	0.423	0.423	0.423	0.423	0.423
28.657	28.657	28.657	28.657	28.657	28.657	28.657	28.657	28.657	28.657
0.496	0.496	0.496	0.496	0.496	0.496	0.496	0.496	0.496	0.496
28.664	28.664	28.664	28.664	28.664	28.664	28.664	28.664	28.664	28.664
0.789	0.789	0.789	0.789	0.789	0.789	0.789	0.789	0.789	0.789
28.659	28.659	28.659	28.659	28.659	28.659	28.659	28.659	28.659	28.659
28.657	28.657	28.657	28.657	28.657	28.657	28.657	28.657	28.657	28.657

SHKALLA 1:100

KT. REF. 24.000

KUOTE TERRENI	28.639					
DIST. PJESORE TERRENI			5.725			
KUOTE PROJEKTI						
DIST. PJESORE PROJEKTI						

SEKSION N. : 8  
 KT. PROJEKTI : 28.636  
 DIST. PRDG. : 75.00  
 DIST. PARA. : 26.74  
 DIST. PAS. : 29.33

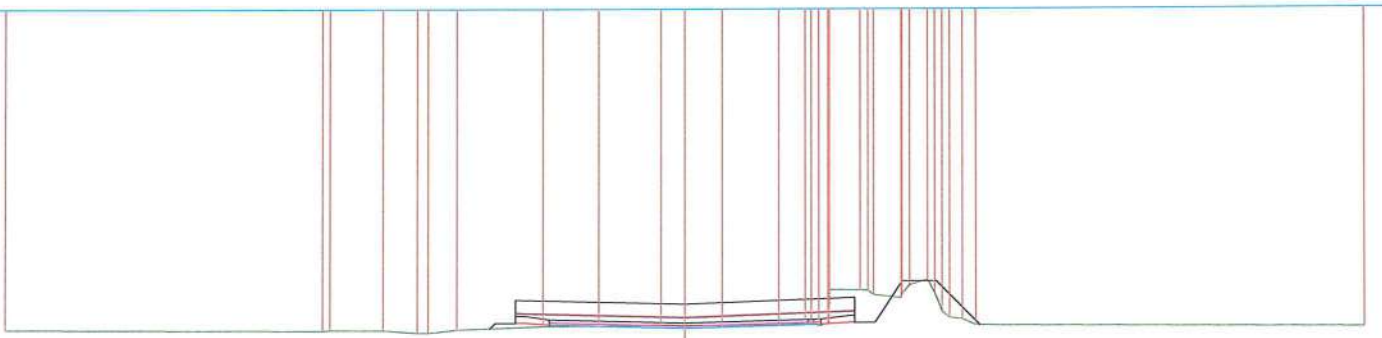

PUNIME GERMI-MBUSHJE	1.813 mq
GERMIM	
MBUSHJE	
MATERIAL MBUSHES	0.490 mq
PAKETA E SHITRESAVE	
SHITRESA E TAPETIT	4.000 m
SHITRESA STABILIZANTI	4.000 m
SHITRESA ÇAKULLI	0.998 mq
PUNIME VEPER ARTI	
BORDURA	0.092 mq

BASHKIA KURBIN

KLIENT BASHKIA KURBIN



PROJEKT: Asfaltim i rruges ne Zheje (Varrezat)

EMERTIMI I FLETES:

PREREJ TERTHORE AKSI 2

APROVIMI I KLIENIT:

"A. SH. ENGINEERING" sh.pk

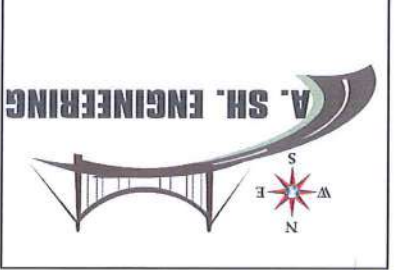

VENDODHJA : ROSKOVEC

SH.

PUNIME GERMI-MBUSHJE	2.171 mq
GERMIM	
MBUSHJE	
MATERIAL MBUSHES	0.260 mq
PAKETA E SHITESAVE	4.000 m
SHITESA E TAPETIT	4.000 m
SHITESA STABILIZANTI	4.000 m
SHITESA CAKULLI	0.998 mq
PUNIME VEPER ARTI	0.092 mq
BORDURA	

SHKALLA 1:100

KT. REF. 24.000

CUOTE TERRENI	DIST. PUESORE TERRENI	KUOTE PROJEKTI	DIST. PUESORE PROJEKTI
28.914	5.790	28.914	2.000
28.896	0.348	28.897	0.134
28.900	1.131	28.694	0.500
28.909	1.131	28.194	0.500
28.914	1.868	28.194	0.400
28.914	0.300	28.694	0.300
28.914	0.440	28.731	0.440
28.914	0.192	28.914	0.192
28.914	0.256	28.914	0.256
28.914	1.084	28.519	2.000
28.914	0.609	28.914	0.380
28.914	0.134	28.914	0.134
28.914	0.300	28.914	0.300
28.914	0.380	28.914	0.380

SEKSION N. : 9

KT. PROJEKTI : 28.874

DIST. PROG. : 104.33

DIST. PARA. : 29.33

DIST. PAS. : 6.98

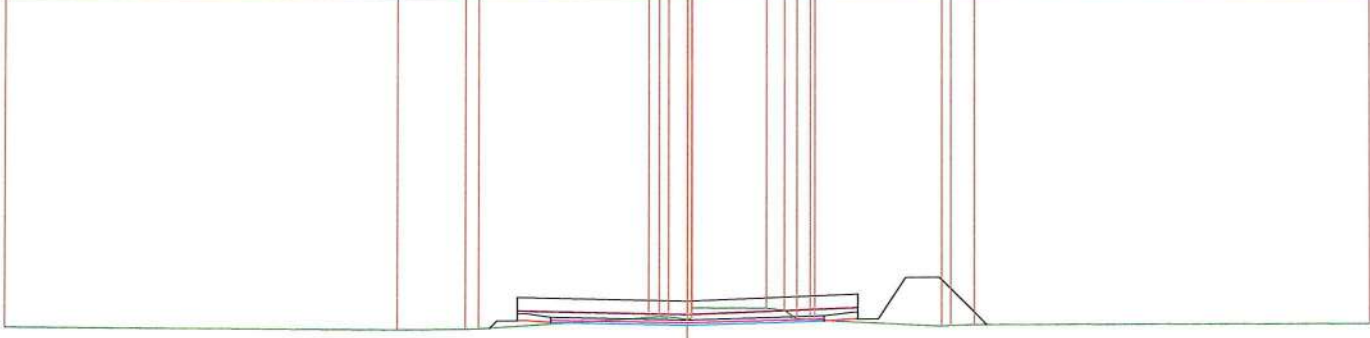

PUNIME GERMI-MBUSHJE	1.149 mq
GERMIM	
MBUSHJE	
MATERIAL MBUSHES	0.377 mq
PAKETA E SHITESAVE	4.000 m
SHITESA E TAPETIT	4.000 m
SHITESA STABILIZANTI	4.000 m
SHITESA CAKULLI	0.998 mq
PUNIME VEPER ARTI	0.092 mq
BORDURA	

SHKALLA 1:100

KT. REF. 24.000

CUOTE TERRENI	DIST. PUESORE TERRENI	KUOTE PROJEKTI	DIST. PUESORE PROJEKTI
28.833	6.144	28.833	2.000
28.789	0.594	28.791	0.500
28.798	0.594	28.403	0.500
28.798	0.289	28.403	0.400
28.772	0.139	28.003	0.300
28.769	0.440	28.914	0.440
28.771	1.256	28.914	0.440
28.801	0.303	28.914	0.303
28.801	1.060	28.599	2.000
28.801	0.174	28.914	0.174
28.810	1.463	28.914	0.174
28.810	1.575	28.914	0.380
28.810	0.277	28.914	0.277
28.855	1.468	28.914	0.380
28.872	0.212	28.929	0.212
28.929	1.536	28.938	0.430
28.938	0.430	28.948	0.430
28.922	2.716	28.922	0.380
28.922	0.300	28.922	0.300

SEKSION N. : 10

KT. PROJEKTI : 28.954

DIST. PROG. : 111.31

DIST. PARA. : 6.98

DIST. PAS. : 6.99

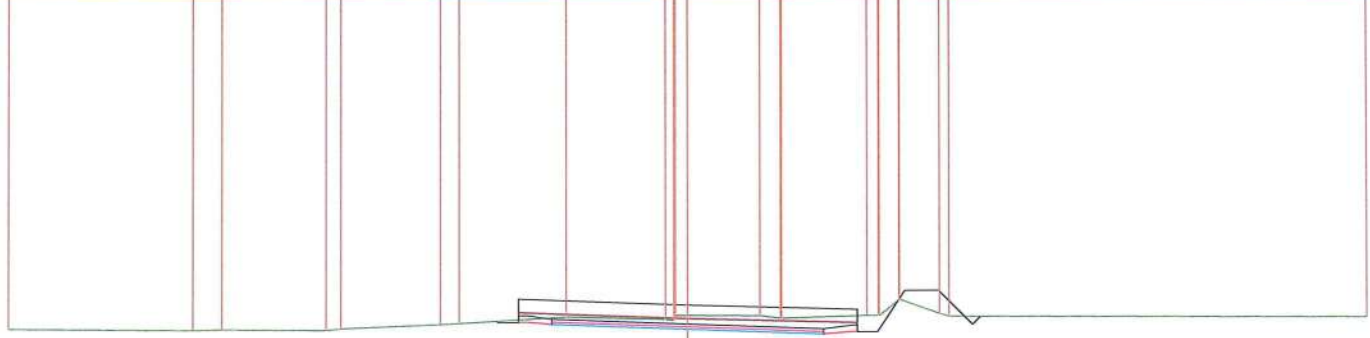

REPUBLIKA E SHQIPERISE

BASHKIA KURBIN

KLIENT: BASHKIA KURBIN

PROJEKT: Asistim i rreges ne Zhiqje (Varrezat)

EMERTIMI I FLETES:

PRERJE TERTHORE AKSI 2

APROYIMI I KLIENIT:

PROJEKTUAR:

"A.S.H. ENGINEERING" sh.pk

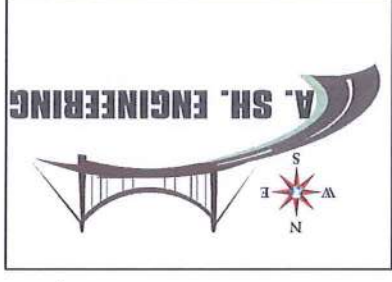

VENDODHJA : ROSKOVEC

SH.



PUNIME GERMI-MBUSHJE	1.185 mq
GERMIM	
MBUSHJE	
MATERIAL MBUSHES	0.461 mq
PAKETIA E SHITRESAVE	
SHTRESA E TAPETIT	4.000 m
SHTRESE STABILIZANTI	4.000 m
SHTRESE ÇAKULLI	0.998 mq
PUNIME VEPER ARTI	0.092 mq
BORDURA	

SHKALLA 1:100

KT. REF. 24.000

KUOTE TERRENI	28.897				
DIST. PUESORE TERRENI	6.731				
KUOTE PROJEKTI					
DIST. PUESORE PROJEKTI					
28.967	28.930	28.951	28.886	28.915	28.892
0.478	0.233	0.922	1.228	1.436	1.678
26.813	26.740	26.892	26.892	26.892	26.892
0.400	0.400	0.400	0.400	0.400	0.400
28.508	28.508	28.508	28.508	28.508	28.508
0.137	0.500	0.500	0.500	0.500	0.500
28.892	28.892	28.892	28.892	28.892	28.892
2.000	2.000	2.000	2.000	2.000	2.000
28.704	28.704	28.704	28.704	28.704	28.704
0.390	0.390	0.390	0.390	0.390	0.390
28.901	28.901	28.901	28.901	28.901	28.901
0.130	0.130	0.130	0.130	0.130	0.130
28.901	28.901	28.901	28.901	28.901	28.901
0.300	0.300	0.300	0.300	0.300	0.300
28.901	28.901	28.901	28.901	28.901	28.901

SEKSION N. 11

KT. PROJEKTI : 29.059

DIST. PRDG. : 118.30

DIST. PARA. : 6.99

DIST. PAS. : 14.63

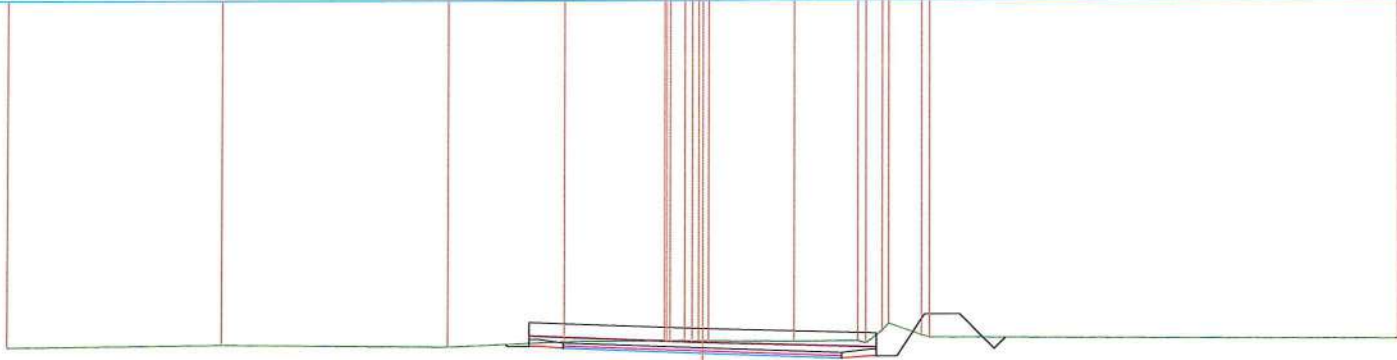

SHKALLA 1:100

KT. REF. 25.000

KUOTE TERRENI	29.014				
DIST. PUESORE TERRENI	7.404				
KUOTE PROJEKTI					
DIST. PUESORE PROJEKTI					
29.154	29.131	29.105	29.101	29.116	29.165
0.270	0.501	2.243	1.154	0.984	1.223
29.158	29.158	29.158	29.158	29.158	29.158
0.400	0.400	0.400	0.400	0.400	0.400
28.650	28.650	28.650	28.650	28.650	28.650
0.500	0.500	0.500	0.500	0.500	0.500
28.950	28.950	28.950	28.950	28.950	28.950
0.181	0.181	0.181	0.181	0.181	0.181
28.950	28.950	28.950	28.950	28.950	28.950
2.000	2.000	2.000	2.000	2.000	2.000
28.975	28.975	28.975	28.975	28.975	28.975
0.390	0.390	0.390	0.390	0.390	0.390
28.980	28.980	28.980	28.980	28.980	28.980
0.130	0.130	0.130	0.130	0.130	0.130
28.980	28.980	28.980	28.980	28.980	28.980
0.300	0.300	0.300	0.300	0.300	0.300
28.980	28.980	28.980	28.980	28.980	28.980

SEKSION N. 12

KT. PROJEKTI : 29.330

DIST. PRDG. : 132.93

DIST. PARA. : 14.63

DIST. PAS. : 17.07

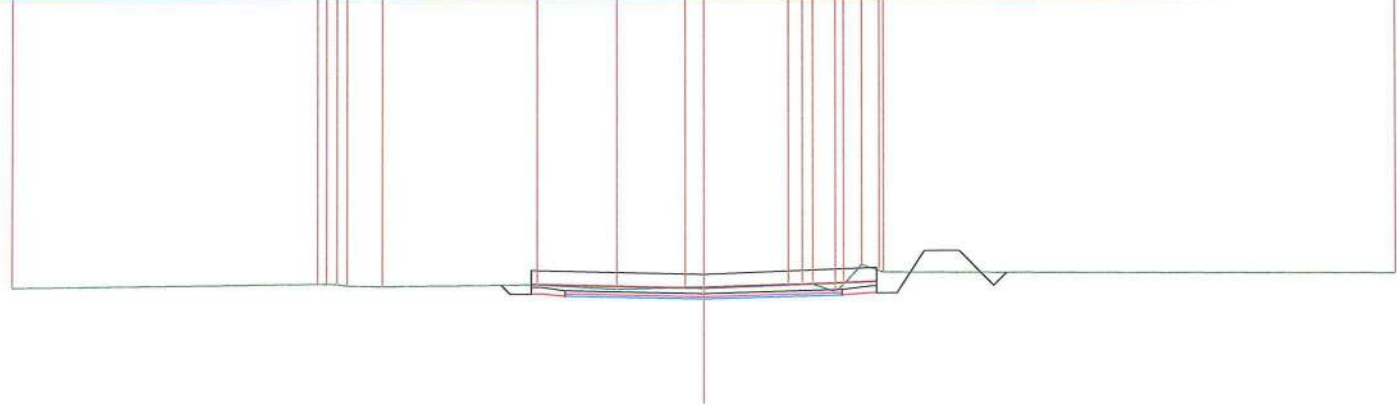

REPUBLIKA E SHQIPERISE

BASHKIA KURBIN

KLIENT: BASHKIA KURBIN

PROJEKT: Astalim i rruges ne Zheje (Varezat)

EMERTIMI I FLETES:

PRERJE TERTHORE AKSI 2

APROVIMI I KLIENTIT:

PROJEKTUAR:

"A.SH. ENGINEERING" sh.p.k



VENDNDORHJA : ROSKOVEC

SH.



PUNIME GERIM-MBUSHJE	1.178 mq
GERMIM	
MBUSHJE	
MATERIAL MBUSHES	0.440 mq
PAKETA E SHTRRESAVE	4.000 m
SHTRESA E TAPETIT	4.000 m
SHTRESA STABILIZANTI	4.000 m
SHTRESE ÇAKULLI	0.998 mq
PUNIME VEPRER ARTI	0.092 mq
BORDURA	

SHKALLA 1:100

KT. REF. 25.000

KT. REF. 25.000	SHKALLA 1:100	KUOTE TERRENI	DIST. PUESORE TERRENI	KUOTE PROJEKTI	DIST. PUESORE PROJEKTI
29,581		28,913	0,258	29,081	0,500
29,081		29,207	0,234	29,081	0,500
29,081		29,377	0,232	29,081	0,400
29,081		29,367	0,232	29,081	0,300
29,081		29,551	0,729	29,081	0,440
29,081		29,531	1,202	29,081	2,000
29,081		29,526	0,325	29,081	0,300
29,081		29,531	0,320	29,081	0,300
29,081		29,534	0,187	29,081	2,000
29,081		29,448	0,379	29,081	0,300
29,081		29,495	0,379	29,081	0,300
29,081		29,276	0,837	29,081	0,300
29,081		29,270	0,574	29,081	0,291
29,081		29,401	1,828	29,081	2,000
29,081		29,416	0,951	29,081	0,300
29,081		29,397	0,394	29,081	0,300
29,081		29,377	0,344	29,081	0,300
29,081		29,360	0,413	29,081	0,300
29,081		29,364	0,413	29,081	0,300

SEKSIDN N. : 13  
 KT. PROJEKTI : 29.632  
 DIST. PRDG. : 150.00  
 DIST. PARA. : 17.07  
 DIST. PAS. : 14.56

PUNIME GERIM-MBUSHJE	0.935 mq
GERMIM	
MBUSHJE	
MATERIAL MBUSHES	0.550 mq
PAKETA E SHTRRESAVE	4.000 m
SHTRESA E TAPETIT	4.000 m
SHTRESA STABILIZANTI	4.000 m
SHTRESE ÇAKULLI	0.998 mq
PUNIME VEPRER ARTI	0.092 mq
BORDURA	

SHKALLA 1:100

KT. REF. 25.000

KT. REF. 25.000	SHKALLA 1:100	KUOTE TERRENI	DIST. PUESORE TERRENI	KUOTE PROJEKTI	DIST. PUESORE PROJEKTI
29,095		29,608	1,007	29,760	0,500
29,095		29,643	0,200	29,260	0,500
29,095		29,652	1,019	29,260	0,400
29,095		29,634	0,300	29,260	0,300
29,095		29,634	0,440	29,260	0,440
29,095		29,606	1,383	29,456	2,000
29,095		29,602	0,371	29,456	0,300
29,095		29,600	0,349	29,456	0,300
29,095		29,588	1,594	29,456	2,000
29,095		29,588	0,816	29,456	0,350
29,095		29,481	0,364	29,456	0,130
29,095		29,435	1,375	29,456	0,300
29,095		29,572	1,149	29,456	0,242
29,095		29,556	1,767	29,456	0,300
29,095		29,637	1,193	29,456	0,300
29,095		29,644	1,323	29,456	0,300
29,095		29,613	0,336	29,456	0,300
29,095		29,593	0,336	29,456	0,300

REPUBLIKA E SHQIPERISE

BASHKIA KURBIN

KLIENT: BASHKIA KURBIN

PROJEKT: Asfaltim i rruges ne Zheje (Vareza)

EMERTIMI I FLETES:

PRERJE TERTHORE AKSI 2

AFROJIMI I KLENTIT:



"A. SH. ENGINEERING" sh.pk



VENDNDODHJA : ROSKOVEC

SH.



PUNIME GERMIM-MBUSHJE	0.710 mq
GERMIM	0.445 mq
MBUSHJE	0.445 mq
MATERIAL MBUSHES	0.445 mq
PAKETA E SHITESAVE	4.000 m
SHITESA E TAPETII	4.000 m
SHITESA STABILIZANTI	4.000 m
SHITESA ÇAKULLI	0.998 mq
PUNIME VEPRER ARTI	0.092 mq
BORDURA	0.092 mq

SHKALLA 1: 100

KT. REF. 25.000

DI. TERRENI	DI. PUESORE TERRENI	KUOTE TERRENI	KUOTE PROJEKTI	DIST. PUESORE PROJEKTI
29, 676	2, 710	29, 676	29, 710	2, 000
29, 670		29, 670	29, 675	
29, 663		29, 663	29, 375	
29, 653		29, 653	29, 375	
29, 645		29, 645	29, 975	0.300
29, 642		29, 642	29, 005	0.440
29, 650	1, 190	29, 650	29, 571	2, 000
29, 708	1, 084	29, 708	29, 967	0.390
29, 682	0, 673	29, 682	29, 717	0.430
29, 635	1, 350	29, 635	29, 717	0.390
29, 768	0, 709	29, 768	29, 717	0.390
29, 756	1, 104	29, 756	29, 717	0.390
29, 805	0, 755	29, 805	29, 717	0.390
29, 808	1, 608	29, 808	29, 717	0.390
29, 768	0, 740	29, 768	29, 736	0.390
29, 756		29, 756		0.390
29, 745		29, 745		0.390
29, 736		29, 736		0.390

SEKSION N. : 15  
 KT. PROJEKTI : 29.926  
 DIST. PRDG. : 175.00  
 DIST. PARA. : 10.44  
 DIST. PAS. : 21.19

DI. TERRENI	DI. PUESORE TERRENI	KUOTE TERRENI	KUOTE PROJEKTI	DIST. PUESORE PROJEKTI
30, 179	2, 374	30, 179	30, 179	2, 000
30, 162		30, 162	30, 126	
30, 139		30, 139	30, 126	
30, 126		30, 126	29, 805	2, 000
30, 097	1, 440	30, 097	30, 065	2, 000
30, 065	1, 577	30, 065	30, 065	2, 000
30, 143	1, 320	30, 143	30, 143	0.390
30, 092	1, 671	30, 092	30, 092	0.390
30, 073	1, 097	30, 073	30, 073	0.390
30, 033	0, 945	30, 033	30, 033	0.390
30, 037	2, 177	30, 037	30, 037	0.390

SHKALLA 1: 100

KT. REF. 26.000

SEKSION N. : 16  
 KT. PROJEKTI : 30.160  
 DIST. PRDG. : 196.19  
 DIST. PARA. : 21.19  
 DIST. PAS. : 28.81

PUNIME GERMIM-MBUSHJE	1.563 mq
GERMIM	0.260 mq
MBUSHJE	0.260 mq
MATERIAL MBUSHES	0.260 mq
PAKETA E SHITESAVE	4.000 m
SHITESA E TAPETII	4.000 m
SHITESA STABILIZANTI	4.000 m
SHITESA ÇAKULLI	0.998 mq
PUNIME VEPRER ARTI	0.092 mq
BORDURA	0.092 mq

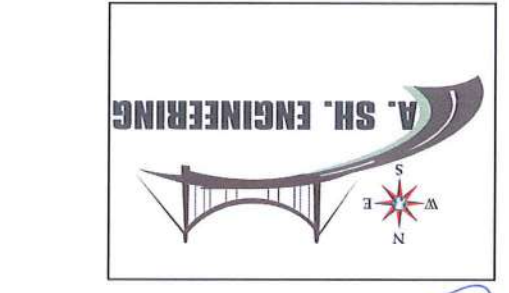
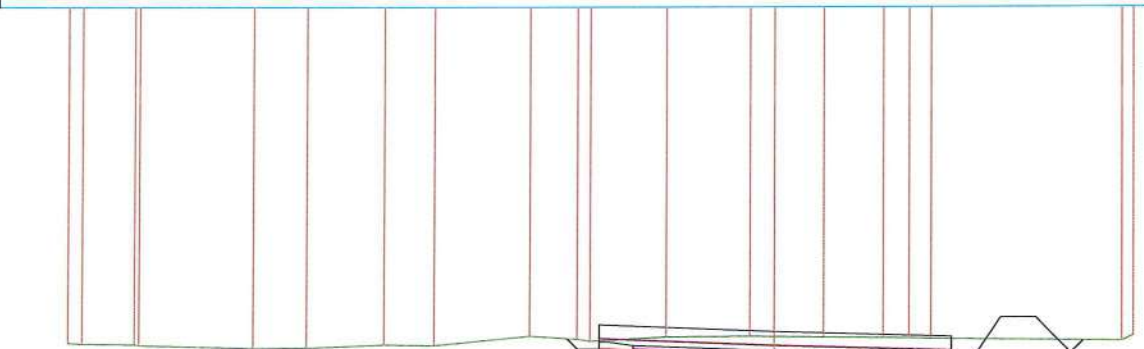
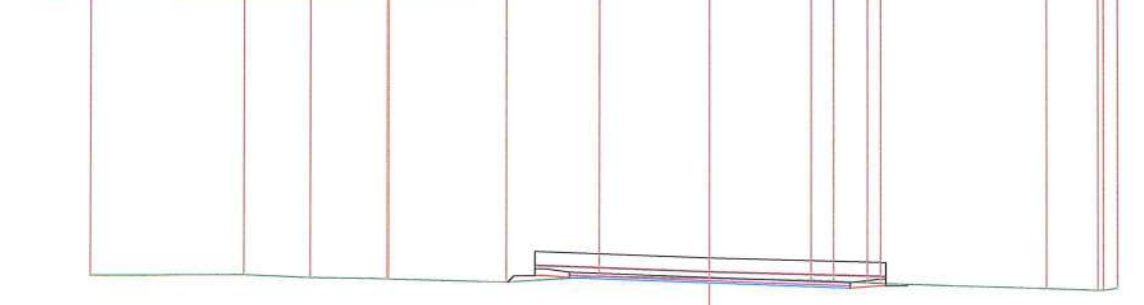

"A.S.H. ENGINEERING" sh.pk

PROJEKTUAR:

EMERTIMI I FLETES:  
 PRERJE TERTHORE AKSI 2

AFROJIMI I KLIENTIT:

PROJEKT: Astalim i rruges ne Zheje (Vareza)

KLIENT: BASHKIA KURBIN

BASHKIA KURBIN

REPUBLIKA E SHQPERISE



VENDNDORJA: ROSKOVEC

SH.

PUNIME GERIM-MBUSHJE	1.405 mq
GERMIM	
MBUSHJE	0.302 mq
MATERIAL MBUSHES	
PAKETA E SHTRRESAVE	4.000 m
SHITRESA E TAPETIT	4.000 m
SHITRESE STABILIZANTI	0.998 mq
SHITRESE ÇAKULLI	
PUNIME VEPER ARTI	0.092 mq
BORDURA	

PUNIME GERIM-MBUSHJE	0.592 mq
GERMIM	
MBUSHJE	0.531 mq
MATERIAL MBUSHES	
PAKETA E SHTRRESAVE	4.000 m
SHITRESA E TAPETIT	4.000 m
SHITRESE STABILIZANTI	0.998 mq
SHITRESE ÇAKULLI	
PUNIME VEPER ARTI	0.092 mq
BORDURA	

SHKALLA 1:100

KT. REF. 26.000

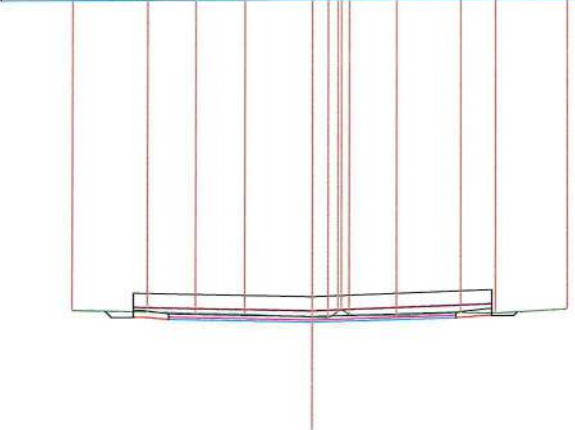

SEKSION N. : 17  
 KT. PROJEKTI : 30.477  
 DIST. PRDG. : 225.00  
 DIST. PARA. : 28.81  
 DIST. PAS. : 25.00

KUOTE TERRENI	DIST. PUESORE TERRENI	KUOTE PROJEKTI	DIST. PUESORE PROJEKTI
30.311	1.002	30.377	0.300
30.363	0.484	30.397	0.440
30.353	0.891	30.427	0.440
30.397	0.656	30.427	2.000
30.374	0.139	30.397	2.000
30.332	0.223	30.417	2.000
30.407	0.943	30.374	2.000
30.362	0.678	30.362	2.000
30.348	0.677	30.348	2.000
30.320	1.042	30.348	0.390
30.300		30.320	0.390
		30.320	0.390
		30.320	0.300
		30.320	0.213

SHKALLA 1:100

KT. REF. 26.000

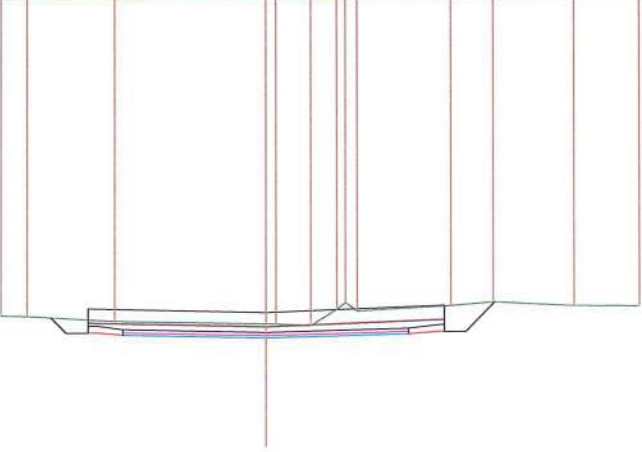

SEKSION N. : 18  
 KT. PROJEKTI : 30.728  
 DIST. PRDG. : 250.00  
 DIST. PARA. : 25.00  
 DIST. PAS. : 25.00

KUOTE TERRENI	DIST. PUESORE TERRENI	KUOTE PROJEKTI	DIST. PUESORE PROJEKTI
30.310	0.913	30.246	0.402
30.300	1.130	30.246	0.300
30.245	0.593	30.246	0.440
30.295	1.310	30.246	0.440
30.261	0.185	30.246	2.000
30.244	0.366	30.246	2.000
30.337	0.487	30.246	2.000
30.361	0.134	30.246	2.000
30.539		30.246	2.000
30.534		30.246	0.390
30.498	2.116	30.246	0.390
30.488	1.222	30.246	0.300
30.416	0.367	30.246	0.213
30.409		30.246	0.213

REPUBLIKA E SHQPERISE

BASHKIA KURBIN

KLIENT: BASHKIA KURBIN

PROJEKT: Asfaltim i rruges ne Zheje (Varezi)

EMERTIMI I FLETES:

PREJUE TERTHORE AKSI 2

APROVIMI I KLIENTIT:

PROJEKTUAR:

"A.SH. ENGINEERING" sh.pk

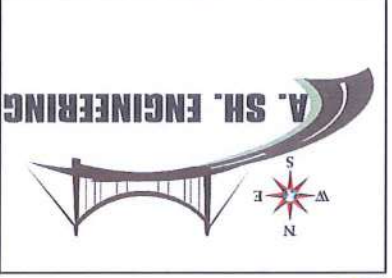

VENDNDORJA : ROSKOVEC

SH

PUNIME GERMI-MBUSHJE	1.044 mq
GERMIM	
MBUSHJE	
MATERIAL MBUSHES	0.301 mq
PAKETA E SHITRESAVE	
SHTRESA E TAPETIT	4.000 m
SHTRESE STABILIZANTI	4.000 m
SHTRESE ÇAKULLI	0.998 mq
PUNIME VEPPER ARTI	
BORDURA	0.092 mq

PUNIME GERMI-MBUSHJE	1.127 mq
GERMIM	
MBUSHJE	
MATERIAL MBUSHES	0.159 mq
PAKETA E SHITRESAVE	
SHTRESA E TAPETIT	4.000 m
SHTRESE STABILIZANTI	4.000 m
SHTRESE ÇAKULLI	0.998 mq
PUNIME VEPPER ARTI	
BORDURA	0.092 mq

SHKALLA 1:100

KT. REF. 26.000

30.261	30.235	30.073	30.219	30.196	30.149	30.116	30.074	30.044	30.000	0.238	0.300	0.440	2.000	2.000	0.350	0.130	0.300
30.261	30.235	30.073	30.219	30.196	30.149	30.116	30.074	30.044	30.000	0.238	0.300	0.440	2.000	2.000	0.350	0.130	0.300
30.261	30.235	30.073	30.219	30.196	30.149	30.116	30.074	30.044	30.000	0.238	0.300	0.440	2.000	2.000	0.350	0.130	0.300
30.261	30.235	30.073	30.219	30.196	30.149	30.116	30.074	30.044	30.000	0.238	0.300	0.440	2.000	2.000	0.350	0.130	0.300
30.261	30.235	30.073	30.219	30.196	30.149	30.116	30.074	30.044	30.000	0.238	0.300	0.440	2.000	2.000	0.350	0.130	0.300
30.261	30.235	30.073	30.219	30.196	30.149	30.116	30.074	30.044	30.000	0.238	0.300	0.440	2.000	2.000	0.350	0.130	0.300

SEKSION N. : 19  
 KT. PROJEKTI : 30.504  
 DIST. PRG. : 275.00  
 DIST. PARA. : 25.00  
 DIST. PAS. : 19.63

SHKALLA 1:100

KT. REF. 26.000

30.164	29.939	29.947	30.123	30.115	30.111	30.160	30.174	30.150	30.174	30.174	30.174	30.174	30.174	30.174	30.174	30.174	30.174
30.164	29.939	29.947	30.123	30.115	30.111	30.160	30.174	30.150	30.174	30.174	30.174	30.174	30.174	30.174	30.174	30.174	30.174
30.164	29.939	29.947	30.123	30.115	30.111	30.160	30.174	30.150	30.174	30.174	30.174	30.174	30.174	30.174	30.174	30.174	30.174
30.164	29.939	29.947	30.123	30.115	30.111	30.160	30.174	30.150	30.174	30.174	30.174	30.174	30.174	30.174	30.174	30.174	30.174
30.164	29.939	29.947	30.123	30.115	30.111	30.160	30.174	30.150	30.174	30.174	30.174	30.174	30.174	30.174	30.174	30.174	30.174
30.164	29.939	29.947	30.123	30.115	30.111	30.160	30.174	30.150	30.174	30.174	30.174	30.174	30.174	30.174	30.174	30.174	30.174

SEKSION N. : 20  
 KT. PROJEKTI : 30.302  
 DIST. PRG. : 294.63  
 DIST. PARA. : 19.63  
 DIST. PAS. : 7.17

REPUBLIKA E SHQIPERISE

BASHKIA KURBIN

KLIENT: BASHKIA KURBIN



PROJEKT: Asfaltim i rruges ne Zhele (Vnrezat)

EMERTIMI I FLETES:

PRERJE TERTHORE AKSI 2

APROVIMI I KLIENIT:



"A. SH. ENGINEERING" sh.p.k

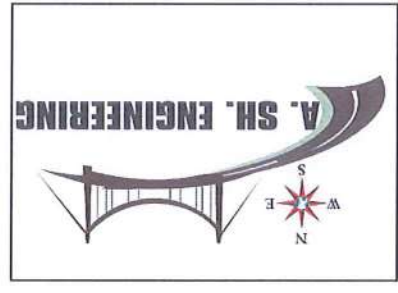

VENDDORHJA: ROSKOVEC

SH.

PUNIME GERMI-MBUSHJE	1.274 mq
GERMIM	
MBUSHJE	0.152 mq
MATERIAL MBUSHES	
PAKETA E SHITESAVE	4.000 m
SHTRESA E TAPETIT	4.000 m
SHTRESE STABILIZANTI	4.000 m
SHTRESE ÇAKULLI	0.998 mq
PUNIME VEPRER ARTI	0.092 mq
BORDURA	

SHKALLA 1:100  
KT. REF. 26.000

KUOTE TERRENI	30.131
DIST. PUESORE TERRENI	4.809
KUOTE PROJEKTI	29.895
DIST. PUESORE PROJEKTI	2.995
0.300 0.440 2.000 2.000	
0.350 0.490 0.300 0.300	

SEKSION N. : 21  
KT. PROJEKTI : 30.236  
DIST. PRDG. : 301.80  
DIST. PARA. : 7.17  
DIST. PAS. : 7.18

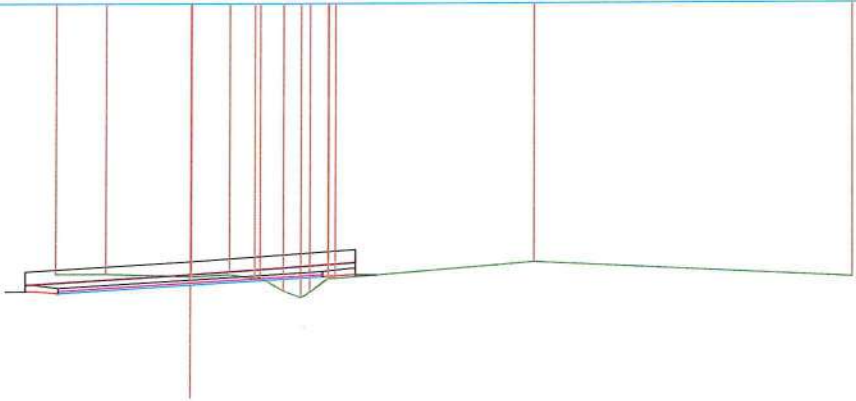

PUNIME GERMI-MBUSHJE	1.363 mq
GERMIM	
MBUSHJE	0.409 mq
MATERIAL MBUSHES	
PAKETA E SHITESAVE	4.000 m
SHTRESA E TAPETIT	4.000 m
SHTRESE STABILIZANTI	4.000 m
SHTRESE ÇAKULLI	0.998 mq
PUNIME VEPRER ARTI	0.092 mq
BORDURA	

SHKALLA 1:100  
KT. REF. 26.000

KUOTE TERRENI	30.139
DIST. PUESORE TERRENI	5.909
KUOTE PROJEKTI	29.849
DIST. PUESORE PROJEKTI	1.663
0.300 0.440 2.000 2.000	
0.350 0.490 0.300 0.300	

SEKSION N. : 22  
KT. PROJEKTI : 30.232  
DIST. PRDG. : 308.98  
DIST. PARA. : 7.18  
DIST. PAS. : 15.58

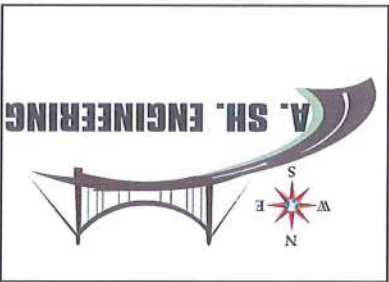
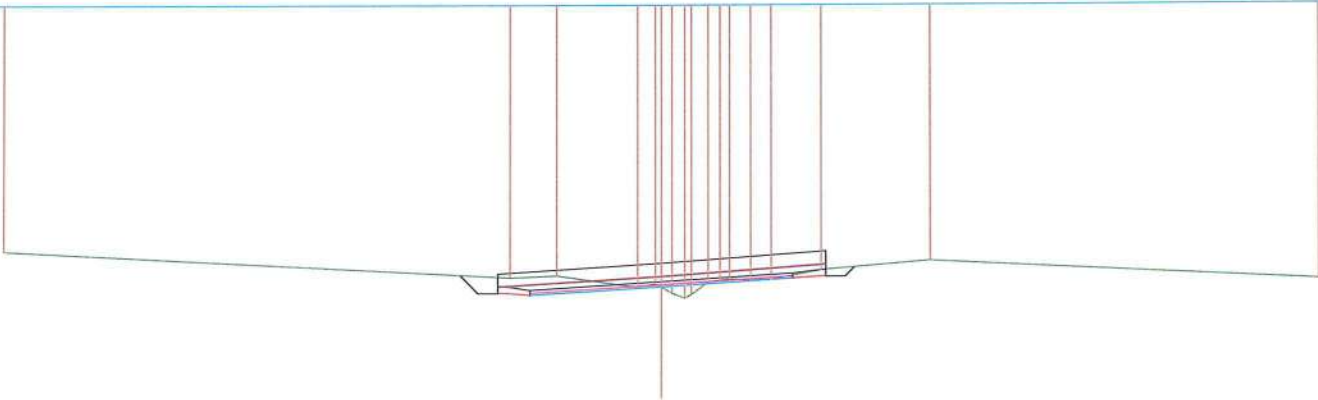



PUNIME GERMIM-MBUSHJE	1.050 mq
GERMIM	
MBUSHJE	0.441 mq
MATERIAL MBUSHES	
PAKETA E SHITESAVE	4.000 m
SHITESA E TAPETIT	4.000 m
SHITRASE STABILIZANTI	4.000 m
SHITRASE ÇAKULLI	0.998 mq
PUNIME VEPRER ARTI	0.092 mq
BORDURA	

SHKALLA 1:100  
KT. REF. 26.000

KUOTE TERRENI	DIST. PUESORE TERRENI	KUOTE PROJEKTI	DIST. PUESORE PROJEKTI
30.065	2.119	29.899	0.339
30.244	5.198	29.889	0.300
29.866	2.683	29.889	0.440
29.962	1.037	29.774	2.000
29.999	1.374	29.909	0.380
30.065	0.720	29.909	0.300
30.157	1.156	29.899	0.300
30.180		29.899	0.300
30.191		29.899	0.178
30.332	1.878	29.899	
30.626	4.626	29.899	

SEKSION N. : 25  
KT. PROJEKTI : 30.129  
DIST. PRGJ. : 339.20  
DIST. PARA : 7.32  
DIST. PAS. : 10.80

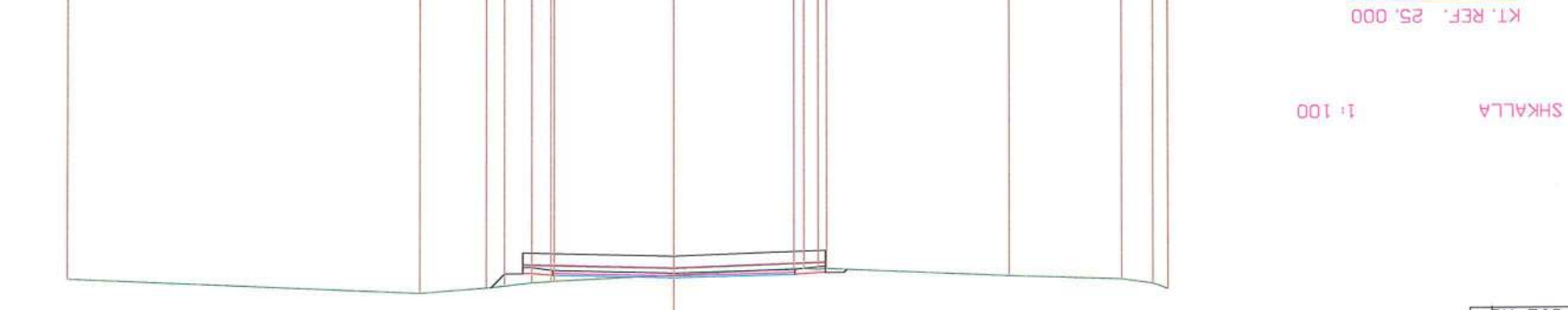

SEKSION N. : 26  
KT. PROJEKTI : 29.751  
DIST. PRGJ. : 350.00  
DIST. PARA : 10.80  
DIST. PAS. : 12.19

KUOTE TERRENI	DIST. PUESORE TERRENI	KUOTE PROJEKTI	DIST. PUESORE PROJEKTI
29.806	0.519	29.899	0.300
29.740	1.843	29.899	0.440
29.806	3.014	29.899	0.300
29.706	1.979	29.396	2.000
29.907	0.301	29.899	0.380
29.907	1.092	29.899	0.300
29.989		29.899	0.300
29.989		29.899	0.300
29.989		29.899	0.298
29.742	5.812	29.899	

PUNIME GERMIM-MBUSHJE	1.822 mq
GERMIM	
MBUSHJE	0.277 mq
MATERIAL MBUSHES	
PAKETA E SHITESAVE	4.000 m
SHITESA E TAPETIT	4.000 m
SHITRASE STABILIZANTI	4.000 m
SHITRASE ÇAKULLI	0.998 mq
PUNIME VEPRER ARTI	0.092 mq
BORDURA	

SHKALLA 1:100  
KT. REF. 25.000

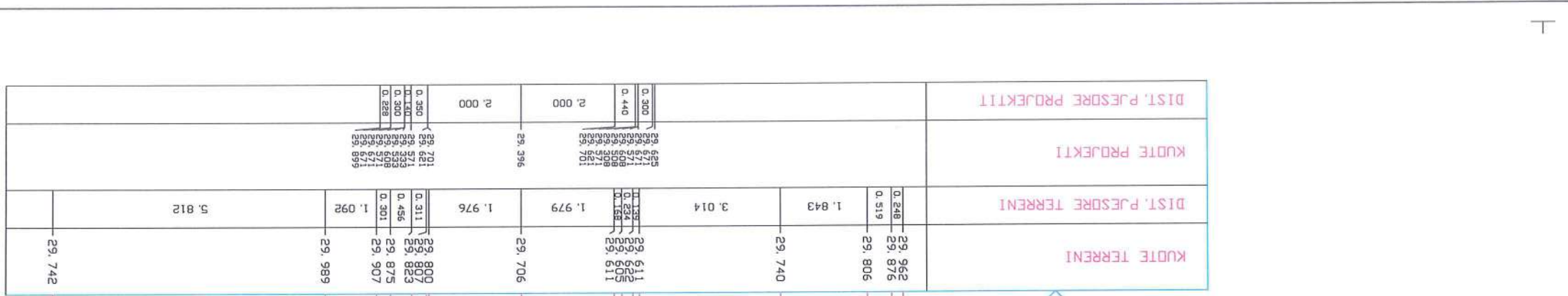

PROJEKT: Asialim i rruges me Zheje (Varrezat)

KLIENT: BASHKIA KURBIN

BASHKIA KURBIN

REPUBLIKA E SHQIPERISE



EMERTIMI I FLETES:

PREJUE TERTHORE AKSI 2

APROVIMI I KLIENTIT:

PROJEKTUAR:

"A.S.H. ENGINEERING" sh.p.k

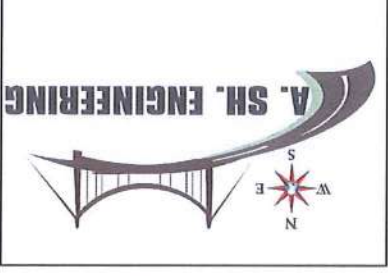

VENDNDODHJA : ROSKOVEC

SH.

PUNIME GERMI-MBUSHJE	1.672 mq
GERMIM	
MBUSHJE	0.260 mq
PAKETA E SHITRESAVE	4.000 m
SHTRESA E TAPETIT	4.000 m
SHTRESE STABILIZANTI	4.000 m
SHTRESE ÇAKULLI	0.998 mq
PUNIME VEPER ARTI	0.092 mq
BORDURA	

PUNIME GERMI-MBUSHJE	1.563 mq
GERMIM	
MBUSHJE	0.272 mq
PAKETA E SHITRESAVE	4.000 m
SHTRESA E TAPETIT	4.000 m
SHTRESE STABILIZANTI	4.000 m
SHTRESE ÇAKULLI	0.998 mq
PUNIME VEPER ARTI	0.092 mq
BORDURA	

SHKALLA 1:100

KT. REF. 25.000

KUOTE TERRENI	29.810
DIST. PUESORE TERRENI	0.439
KUOTE PROJEKTI	29.657
DIST. PUESORE PROJEKTI	0.919
KUOTE TERRENI	29.533
DIST. PUESORE TERRENI	0.412
KUOTE PROJEKTI	29.518
DIST. PUESORE PROJEKTI	0.305
KUOTE TERRENI	29.591
DIST. PUESORE TERRENI	0.884
KUOTE PROJEKTI	29.631
DIST. PUESORE PROJEKTI	0.249
KUOTE TERRENI	29.520
DIST. PUESORE TERRENI	0.523
KUOTE PROJEKTI	29.787
DIST. PUESORE PROJEKTI	0.204
KUOTE TERRENI	29.298
DIST. PUESORE TERRENI	7.150

SEKSION N. : 27  
 KT. PROJEKTI : 29.636  
 DIST. PRDG. : 362.19  
 DIST. PARA. : 12.19  
 DIST. PAS. : 9.93

SHKALLA 1:100

KT. REF. 25.000

KUOTE TERRENI	29.852
DIST. PUESORE TERRENI	2.692
KUOTE PROJEKTI	29.639
DIST. PUESORE PROJEKTI	1.561
KUOTE TERRENI	29.615
DIST. PUESORE TERRENI	0.884
KUOTE PROJEKTI	29.601
DIST. PUESORE PROJEKTI	1.121
KUOTE TERRENI	29.582
DIST. PUESORE TERRENI	0.622
KUOTE PROJEKTI	29.576
DIST. PUESORE PROJEKTI	0.291
KUOTE TERRENI	29.219
DIST. PUESORE TERRENI	7.081

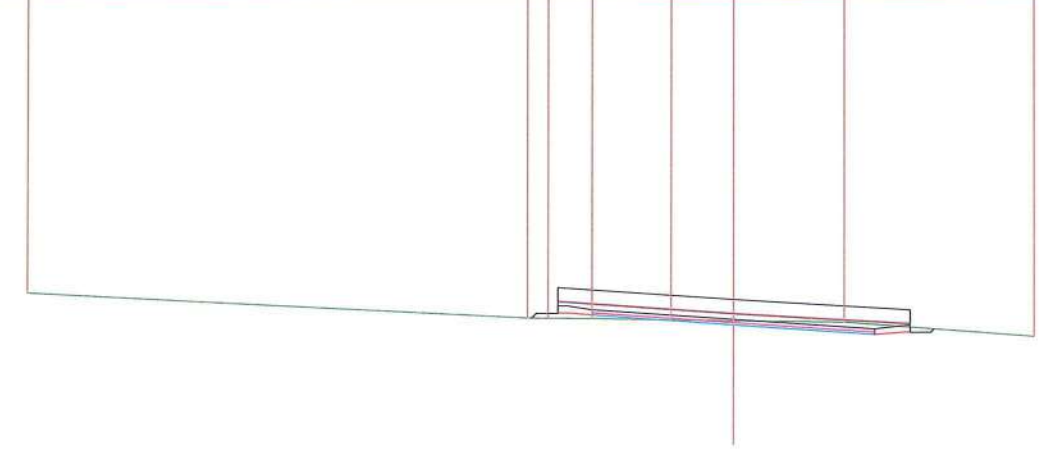

SEKSION N. : 28  
 KT. PROJEKTI : 29.673  
 DIST. PRDG. : 372.12  
 DIST. PARA. : 9.93  
 DIST. PAS. : 9.92

REPUBLIKA E SHQIPERISE

BASHKIA KURBIN

KLIENT: BASHKIA KURBIN

PROJEKT: Astalim i rruges ne Zheje (Varrezat)

EMERTIMI I FLETES:

PRERJE TERTHORE AKSI 2

APROVIMI I KLIENTIT:

PROJEKTUAR:

"A.SH. ENGINEERING" sh.pk

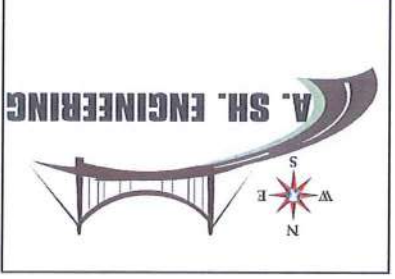

VENNDODHJA : ROSKOVEC

SH.



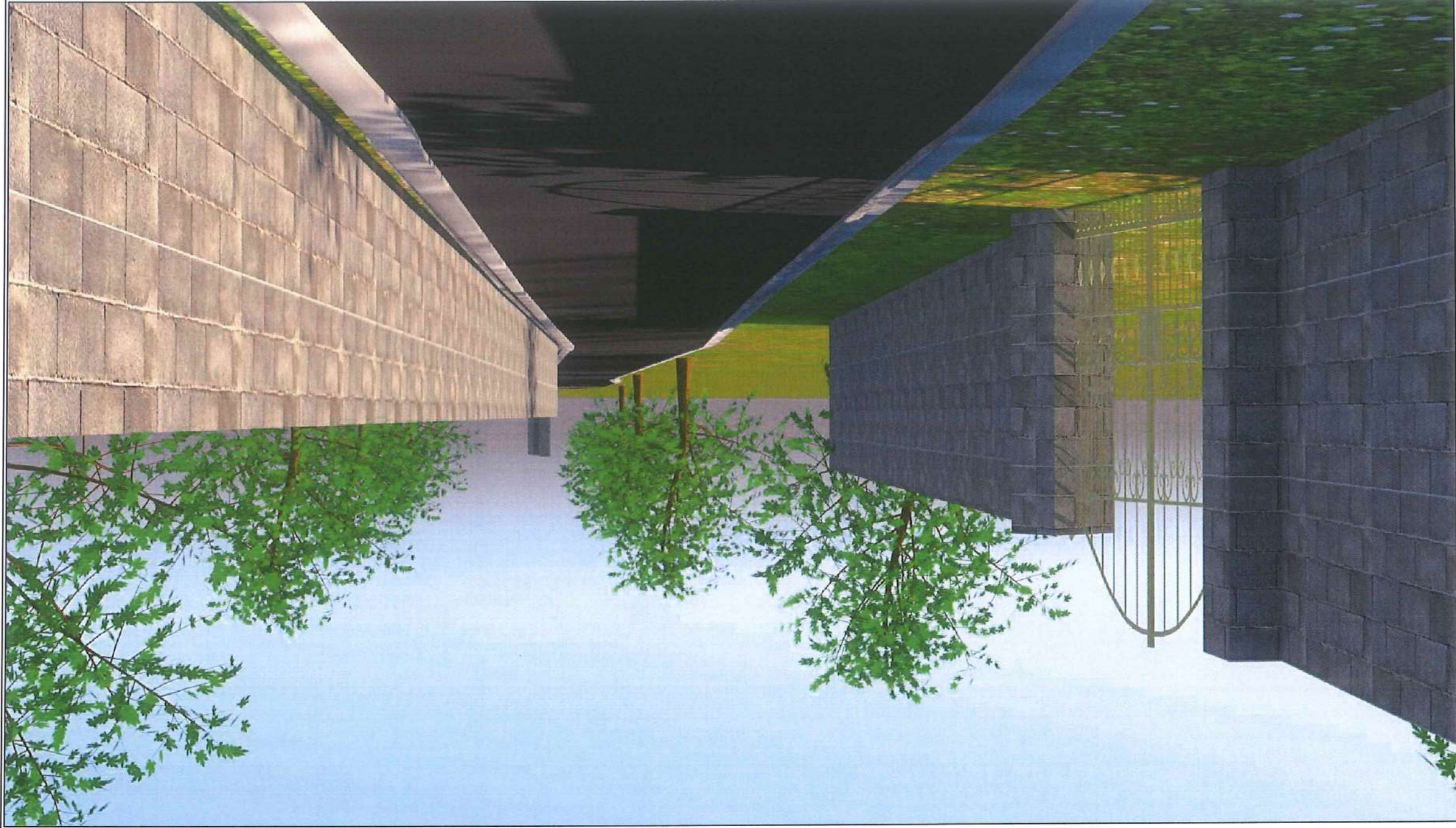

SH.

VENDOSHJA - ROSKOVEC

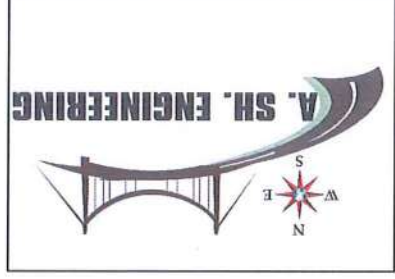

"A. SH. ENGINEERING" sh.p.k

PROJEKTUAR:



APROVIMI I KLUENTIT:

RENDER

EMERTIMI I FLETES:

PROJEKT: Asfaltim i rruges ne Zheje (Varrezat)

KLIENT: BASHKIA KURBIN



BASHKIA KURBIN

REPUBLIKA E SHQIPERISE





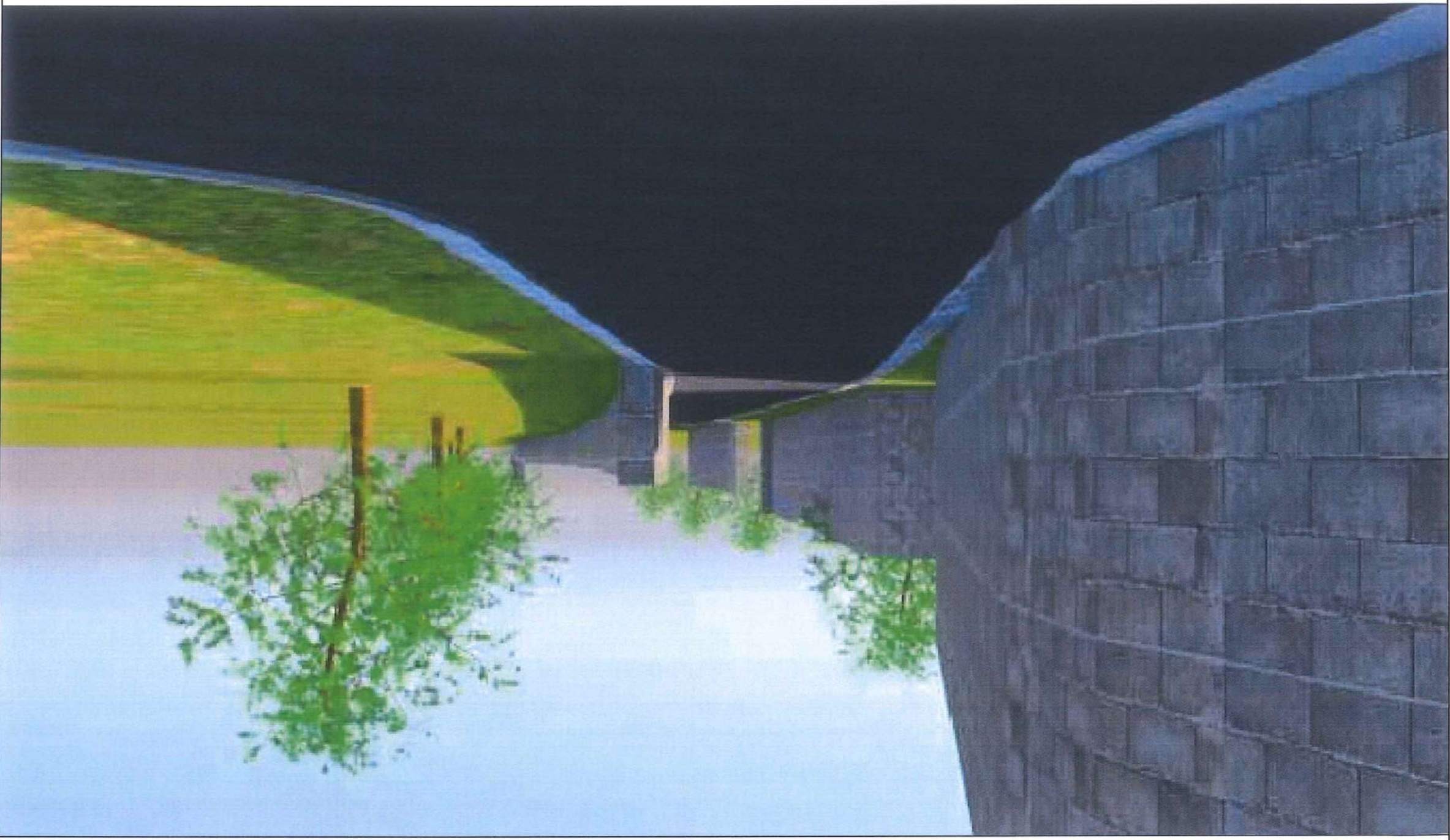

SH.

VENDODHJA : ROSKOVEC

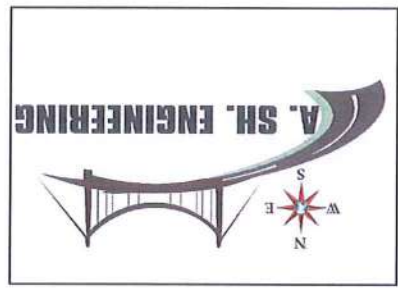

"A.SH. ENGINEERING" sh.p.k

PROJEKTUAR:



APROVIMI I KLIENIT:

RENDER

EMERTIMI I FLETES:

PROJEKT: Astalim i rruges ne Zheje (Varza)

KLIENI: BASHKIA KURBIN

BASHKIA KURBIN

REPUBLIKA E SHQIPERISE

