

**MIRATOHET
BASHKIA DIBËR
KRYETARI**

Z. RAHIM SPAHIU

PROJEKT

Z B A T I M I

OBJEKTI

**SISTEMIM ASFALTIM I RRUGËS SË FSHATIT MAJTARE E POSHTME,
NJ.A MAQELLARE, BASHKIA DIBËR**

**AUTORITETI
KONTRAKTOR**

BASHKIA DIBËR

KONSULENTI

“ERALD-G” Shpk

VITI 2022



printo_20220809_1114

<https://geoportal.asig.gov.al>

Data e Printimit: 09.08.2022

539237.088
4604469.572

540602.084
4604469.572

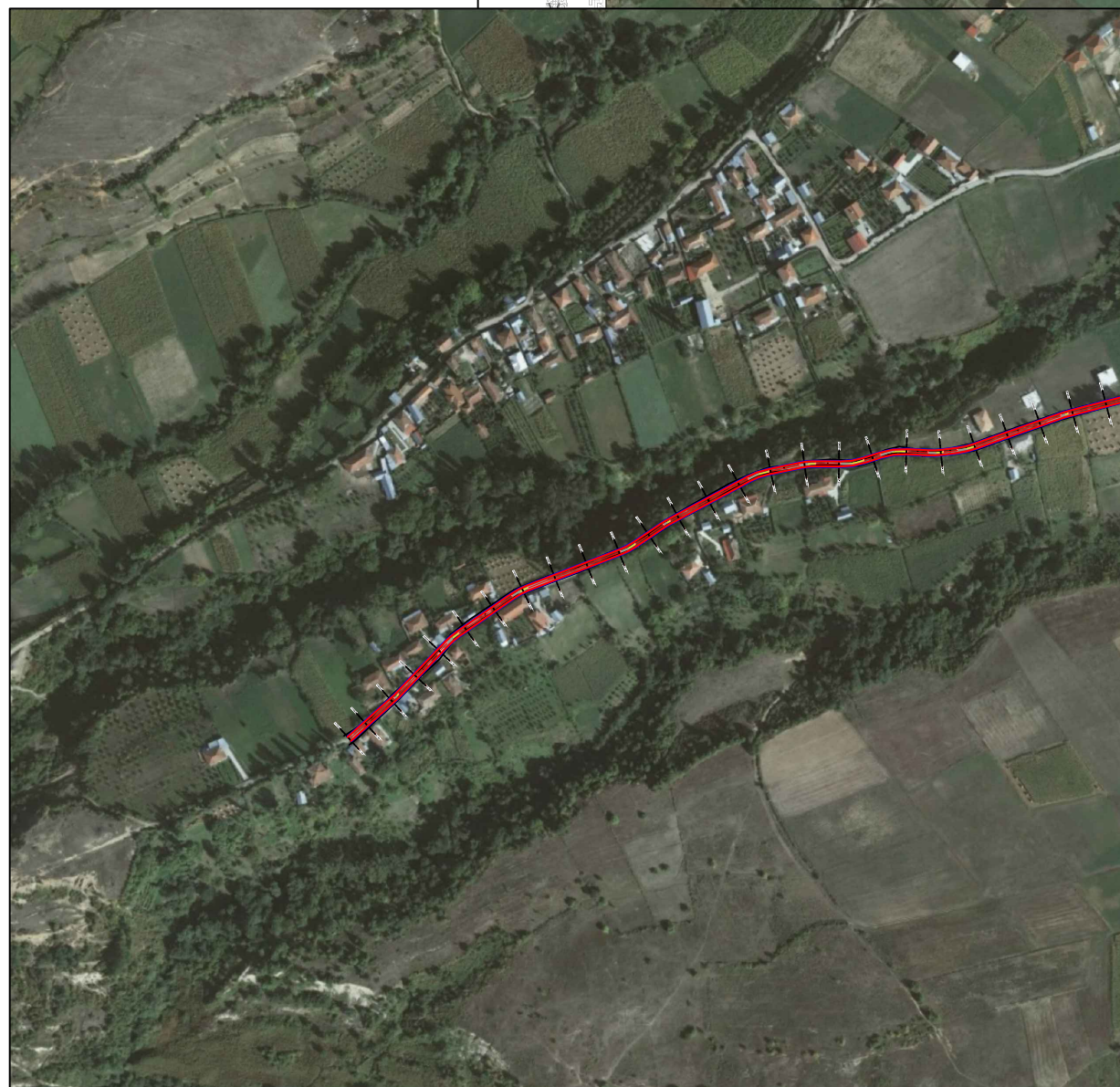

Legjenda

- Shprehje Baze
- Rendi 4 (Kufinjesh administrative)
- Rendi 3 (Kufi Bashki)
- Rendi 2 (Kufi Qarku)
- Rendi 1 (Kufi Tokesor)

540602.084
4603568.653

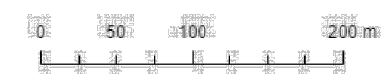

Sistemi koordinativ: KRGJSH
Projektimi: KRGJSH

POROSITES : BASHKIA DIBER

RIKONSTRUKSION DHE SISTEMIM ASFALTIM I RRUGES SE FSHATIT MAJTARE E POSHTME , NJ.A MAQELLARE

EMERTIMI : HOROGRAFIA



"ERALD-G" sh.p.k
Rruga "Kongresi i Lushnjes"
Tirane

DREJTUES PROJEKTI

Ing.Gezim ISLAMI

PROJEKTUES

Ing.Erindi GJOKA
Top.Alfred NDREGJONI
Top.Kujtim CANAMETI

Hidr.Anisa ZAKA
Mek.Arben MUHA
Ing.Eraldo ISLAMI

SHKALLA

1 : 5000

TIRANE 2022

FLETA

1 : 01

FORMAT A3

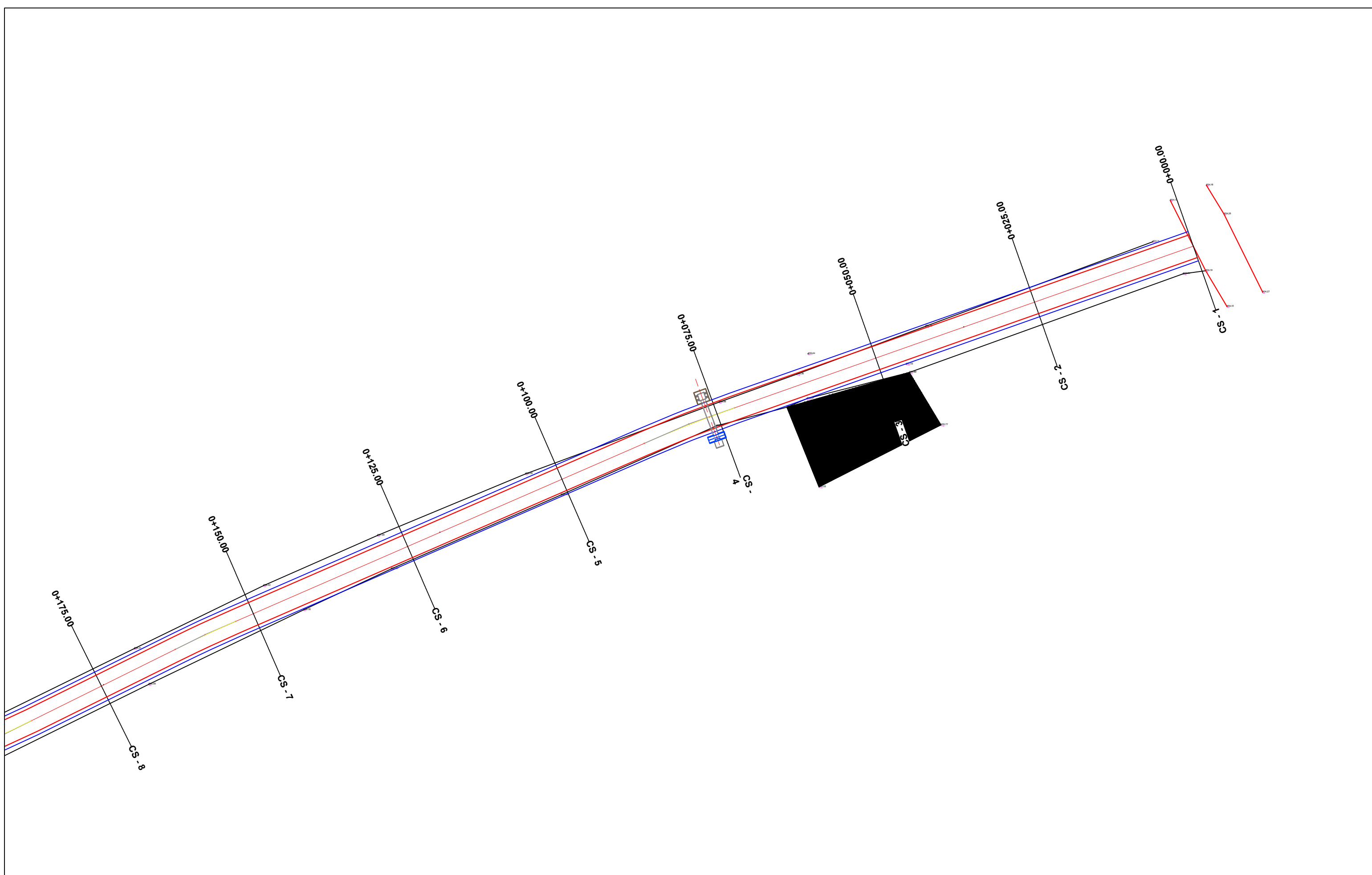

POROSITES : BASHKIA DIBER
 RIKONSTRUKSION DHE SISTEMIM ASFALTIM I RRUGES SE FSHATIT MAJTARE E POSHTME , NJ.A MAQELLARE

EMERTIMI : PLANIMETRIA E PËRGJITHSHME

	"ERALD-G" sh.p.k
	Rruga "Kongresi i Lushnjes" Tirane

DREJTUES PROJEKTI
 Ing.Gezim ISLAMI

PROJEKTUES

Ing.Erindi GJOKA	Hidr.Anisa ZAKA
Top.Alfred NDREGJONI	Mek.Arben MUHA
Top.Kujtim CANAMETI	Ing.Eraldo ISLAMI

SHKALLA	FLETA
SHK - 1:500	2 - 01
TIRANE 2022	FORMAT A3

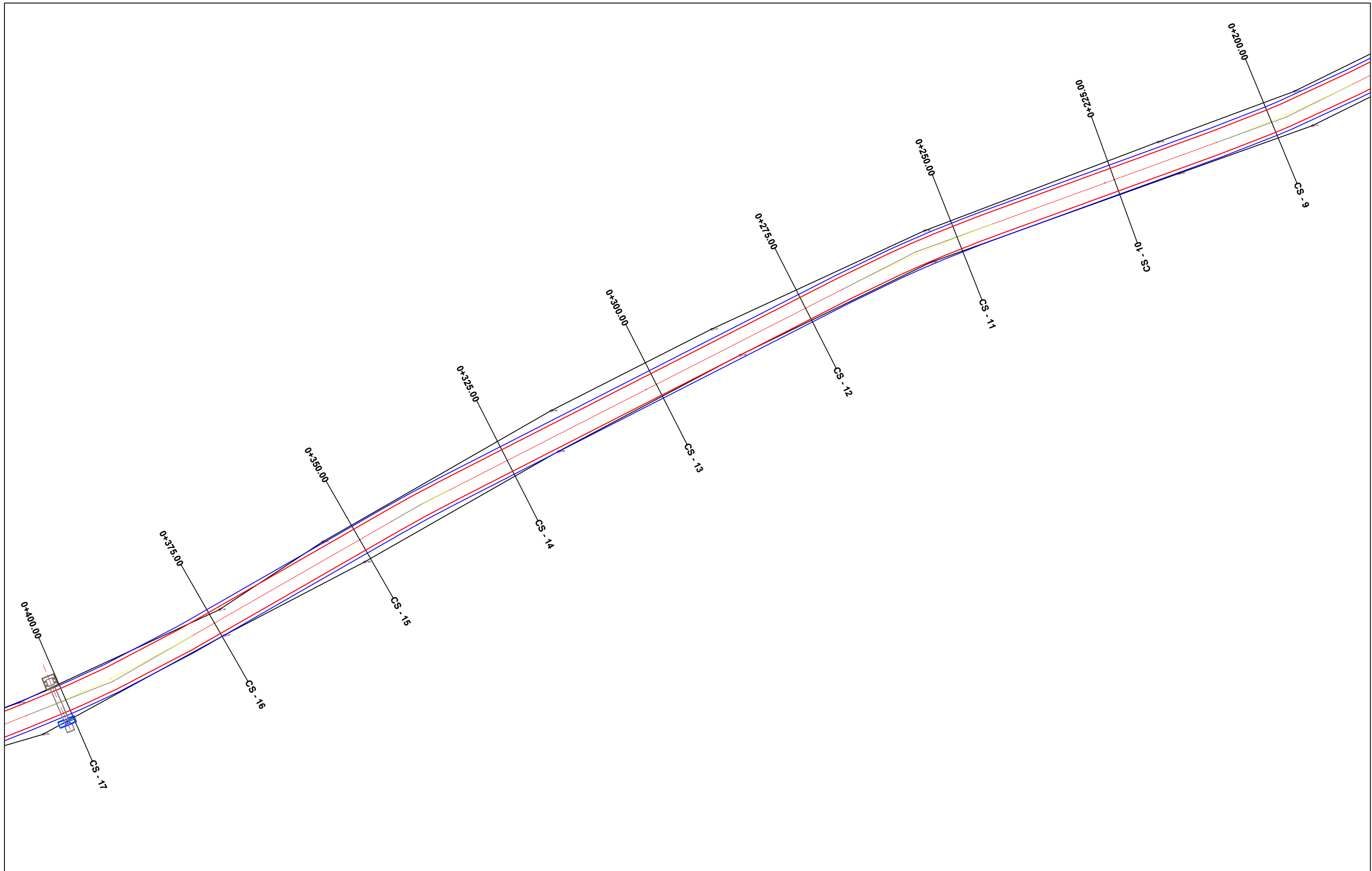

POROSITES : BASHKIA DIBER
 RIKONSTRUKSION DHE SISTEMIM ASFALTIM I RRUGES SE FSHATIT MAJTARE E POSHTME , NJ.A MAQELLARE

EMERTIMI : PLANIMETRIA E PËRGJITHSHME



"ERALD-G" sh.p.k
 Rruga "Kongresi i Lushnjes"
 Tirane

DREJTUES PROJEKTI

Ing.Gezim ISLAMI

PROJEKTUES

Ing.Erindi GJOKA	Hidr.Anisa ZAKA
Top.Alfred NDREGJONI	Mek.Arben MUHA
Top.Kujtim CANAMETI	Ing.Eraldo ISLAMI

SHKALLA

SHK - 1:500

TIRANE 2022

FLETA

2 - 02

FORMAT A3

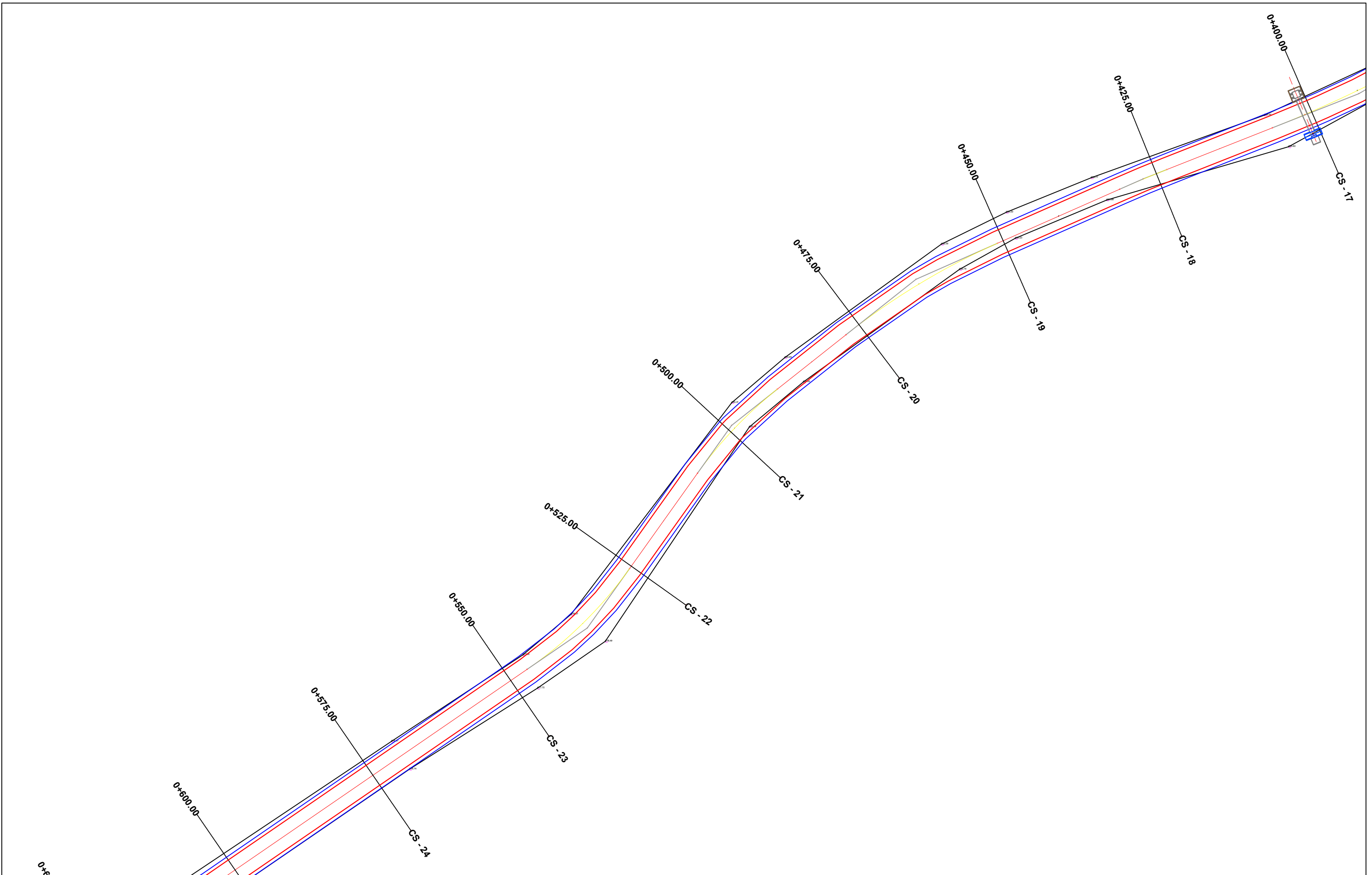

POROSITES : BASHKIA DIBER
 RIKONSTRUKSION DHE SISTEMIM ASFALTIM I RRUGES
 SE FSHATIT MAJTARE E POSHTME , NJ.A MAQELLARE

EMERTIMI : PLANIMETRIA E PËRGJITHSHME

	"ERALD-G" sh.p.k
	Rruga "Kongresi i Lushnjes" Tirane

DREJTUES PROJEKTI	PROJEKTUES		
Ing.Gezim ISLAMI	Ing.Erindi GJOKA	Hidr.Anisa ZAKA	
	Top.Alfred NDREGJONI	Mek.Arben MUHA	
	Top.Kujtim CANAMETI	Ing.Eraldo ISLAMI	

SHKALLA	FLETA
SHK - 1:500	2 - 03
TIRANE 2022	FORMAT A3

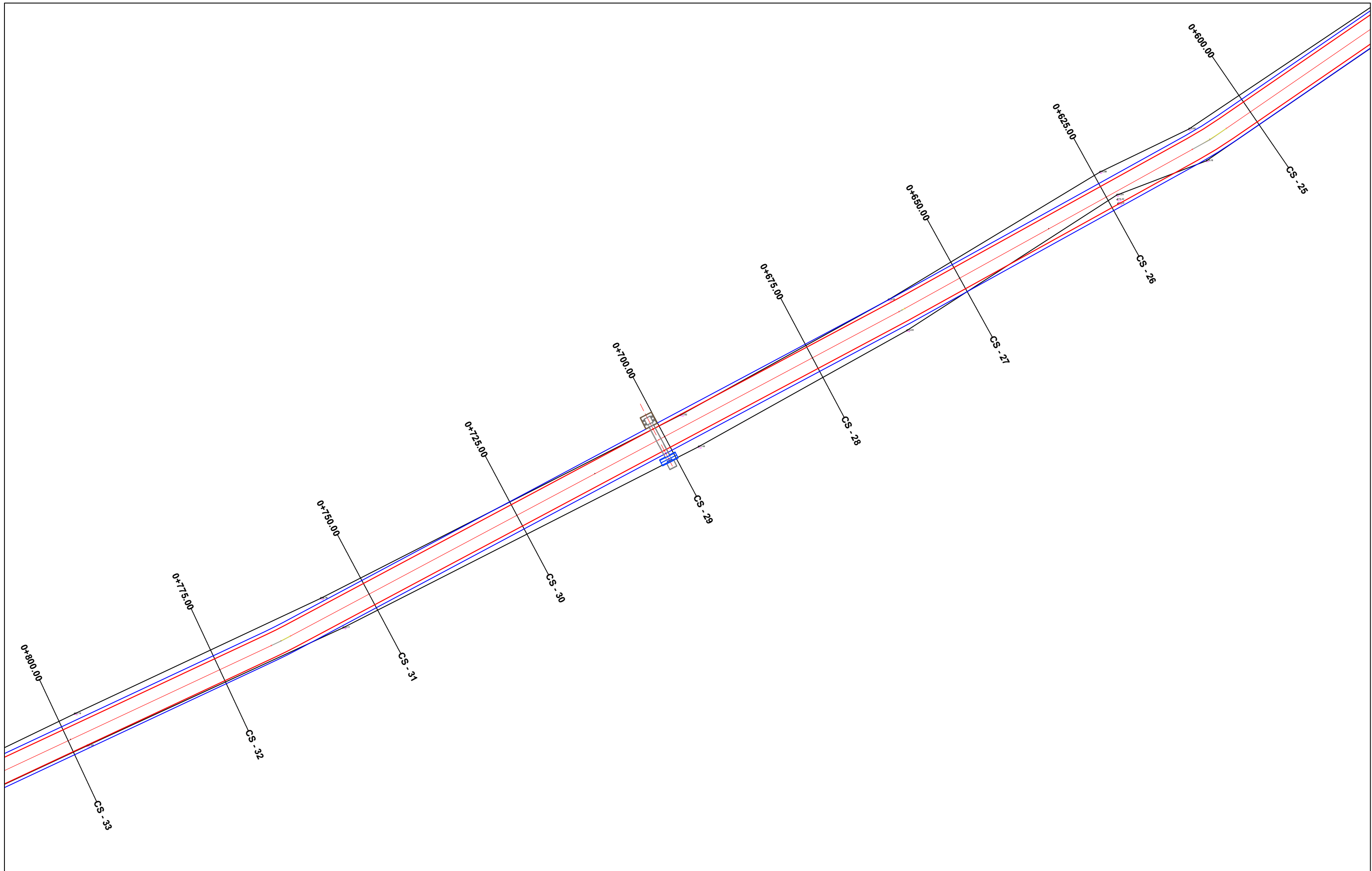

POROSITES : BASHKIA DIBER
 RIKONSTRUKSION DHE SISTEMIM ASFALTIM I RRUGES
 SE FSHATIT MAJTARE E POSHTME , NJ.A MAQELLARE

EMERTIMI : PLANIMETRIA E PËRGJITHSHME



"ERALD-G" sh.p.k
 Rruga "Kongresi i Lushnjes"
 Tirane

DREJTUES PROJEKTI

Ing.Gezim ISLAMI

PROJEKTUES

Ing.Erindi GJOKA	Hidr.Anisa ZAKA
Top.Alfred NDREGJONI	Mek.Arben MUHA
Top.Kujtim CANAMETI	Ing.Eraldo ISLAMI

SHKALLA

SHK - 1:500

TIRANE 2022

FLETA

2 - 04

FORMAT A3

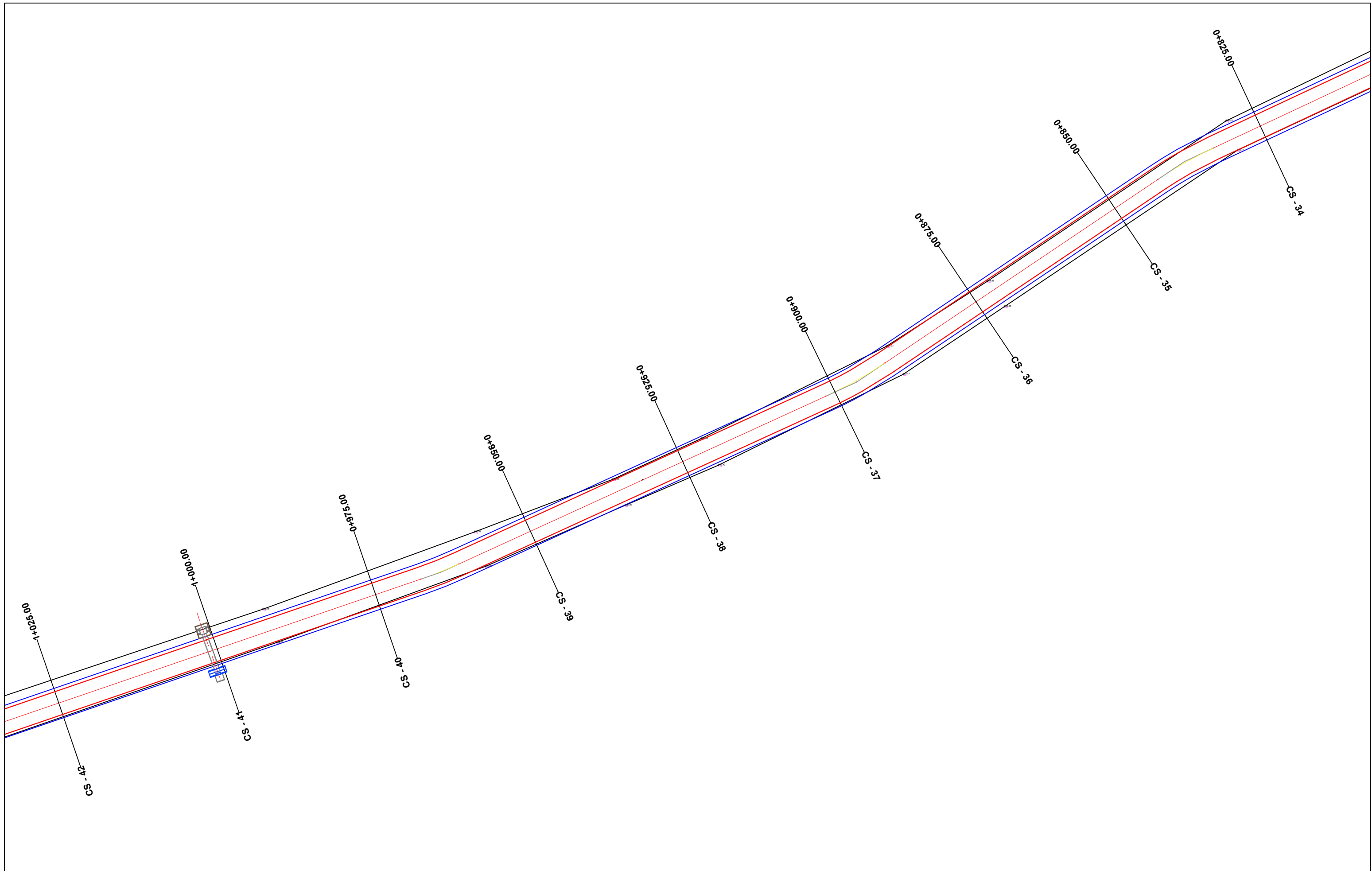

POROSITES : BASHKIA DIBER
 RIKONSTRUKSION DHE SISTEMIM ASFALTIM I RRUGES
 SE FSHATIT MAJTARE E POSHTME , NJ.A MAQELLARE

EMERTIMI : PLANIMETRIA E PËRGJITHSHME



"ERALD-G" sh.p.k
 Rruga "Kongresi i Lushnjes"
 Tirane

DREJTUES PROJEKTI

Ing.Gezim ISLAMI

PROJEKTUES

Ing.Erindi GJOKA	Hidr.Anisa ZAKA
Top.Alfred NDREGJONI	Mek.Arben MUHA
Top.Kujtim CANAMETI	Ing.Eraldo ISLAMI

SHKALLA

SHK - 1:500

TIRANE 2022

FLETA

2 - 05

FORMAT A3

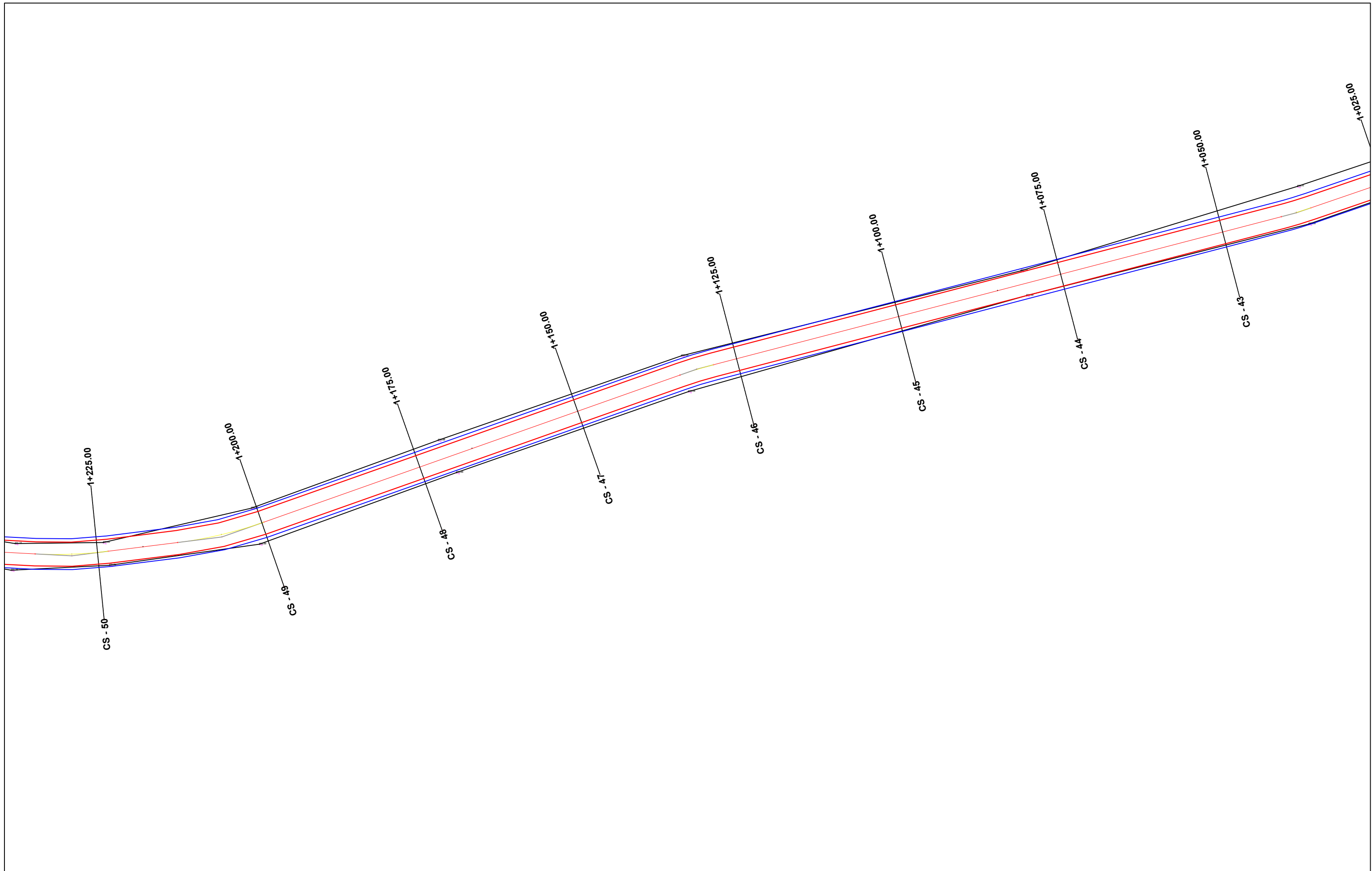

POROSITES : BASHKIA DIBER
 RIKONSTRUKSION DHE SISTEMIM ASFALTIM I RRUGES
 SE FSHATIT MAJTARE E POSHTME , NJ.A MAQELLARE

EMERTIMI : PLANIMETRIA E PËRGJITHSHME
 "ERALD-G" sh.p.k
 Rruga "Kongresi i Lushnjes"
 Tirane

DREJTUES PROJEKTI
 Ing.Gezim ISLAMI

PROJEKTUES
 Ing.Erindi GJOKA
 Hidr.Anisa ZAKA
 Top.Alfred NDREGJONI
 Mek.Arben MUHA
 Top.Kujtim CANAMETI
 Ing.Eraldo ISLAMI

SHKALLA	FLETA
SHK - 1:500	2 - 06
TIRANE 2022	FORMAT A3

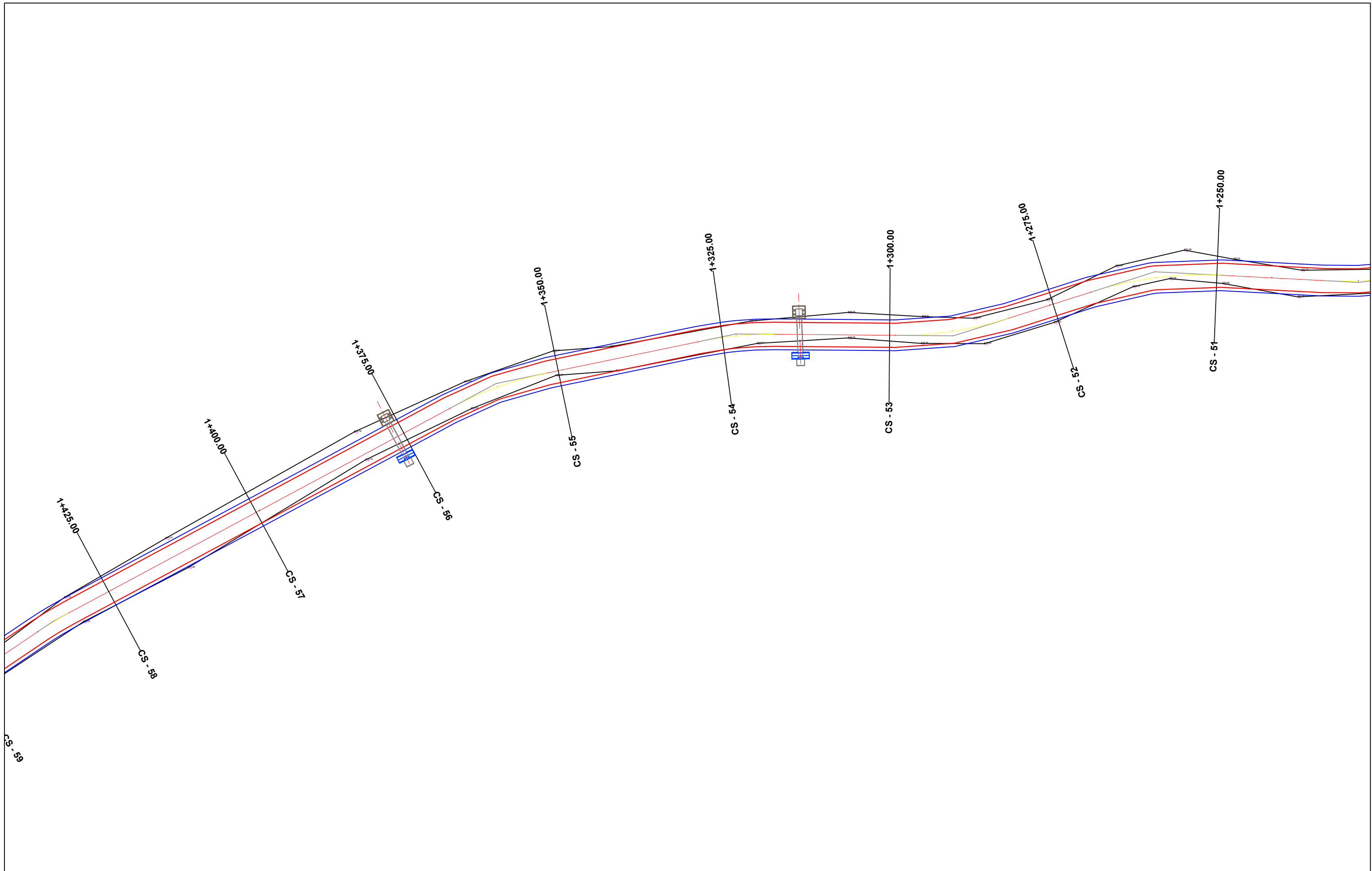

POROSITES : BASHKIA DIBER
 RIKONSTRUKSION DHE SISTEMIM ASFALTIM I RRUGES SE FSHATIT MAJTARE E POSHTME , NJ.A MAQELLARE

EMERTIMI : PLANIMETRIA E PËRGJITHSHME



"ERALD-G" sh.p.k
 Rruga "Kongresi i Lushnjes"
 Tirane

DREJTUES PROJEKTI

Ing.Gezim ISLAMI

PROJEKTUES

Ing.Erindi GJOKA	Hidr.Anisa ZAKA
Top.Alfred NDREGJONI	Mek.Arben MUHA
Top.Kujtim CANAMETI	Ing.Eraldo ISLAMI

SHKALLA

SHK - 1:500

TIRANE 2022

FLETA

2 - 07

FORMAT A3

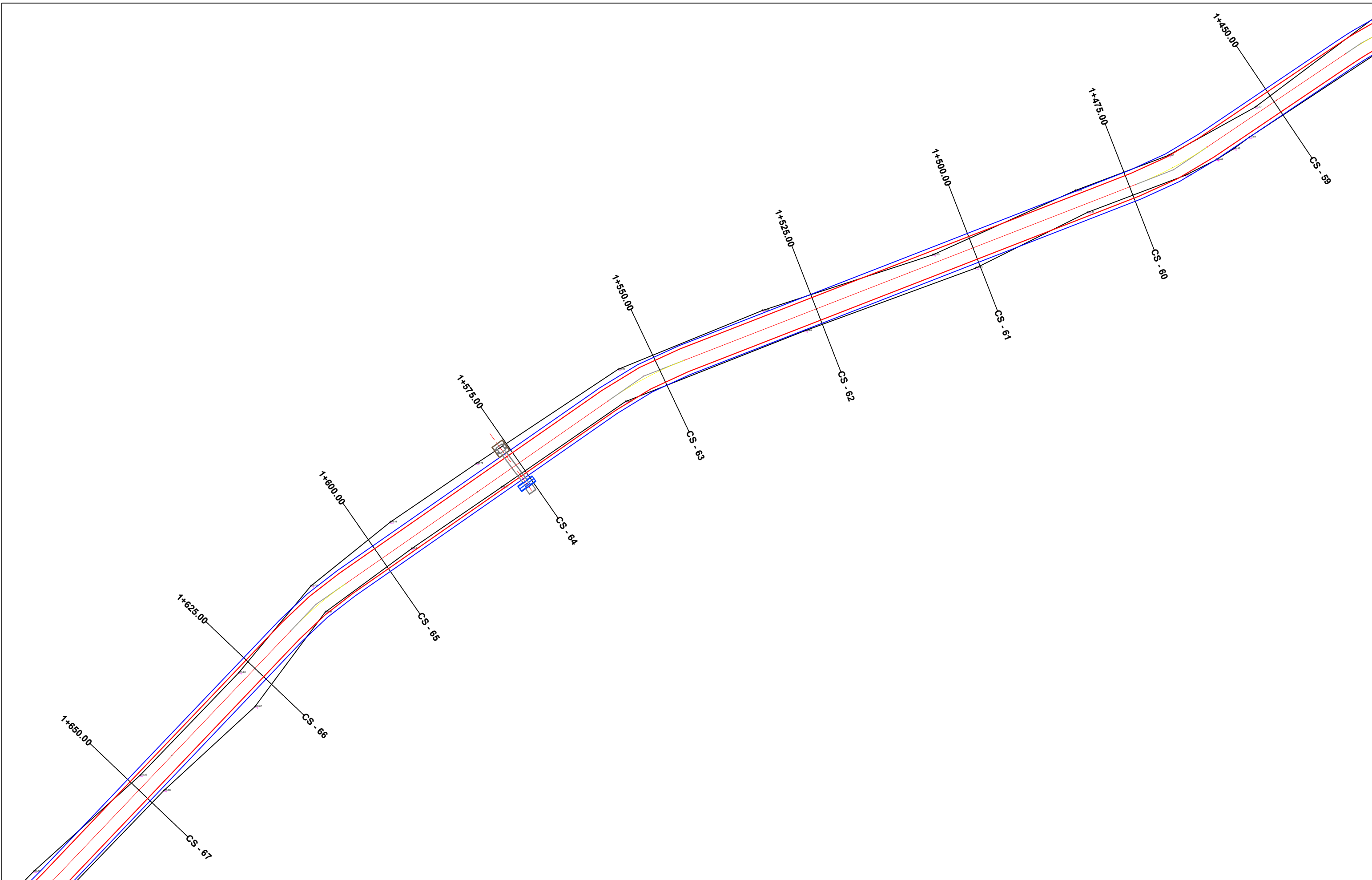

POROSITES : BASHKIA DIBER
 RIKONSTRUKSION DHE SISTEMIM ASFALTIM I RRUGES SE FSHATIT MAJTARE E POSHTME , NJ.A MAQELLARE

EMERTIMI : PLANIMETRIA E PËRGJITHSHME

	"ERALD-G" sh.p.k
	Rruga "Kongresi i Lushnjes" Tirane

DREJTUES PROJEKTI	PROJEKTUES		
Ing.Gezim ISLAMI	Ing.Erindi GJOKA	Hidr.Anisa ZAKA	
	Top.Alfred NDREGJONI	Mek.Arben MUHA	
	Top.Kujtim CANAMETI	Ing.Eraldo ISLAMI	

SHKALLA	FLETA
SHK - 1:500	2 - 08
TIRANE 2022	FORMAT A3

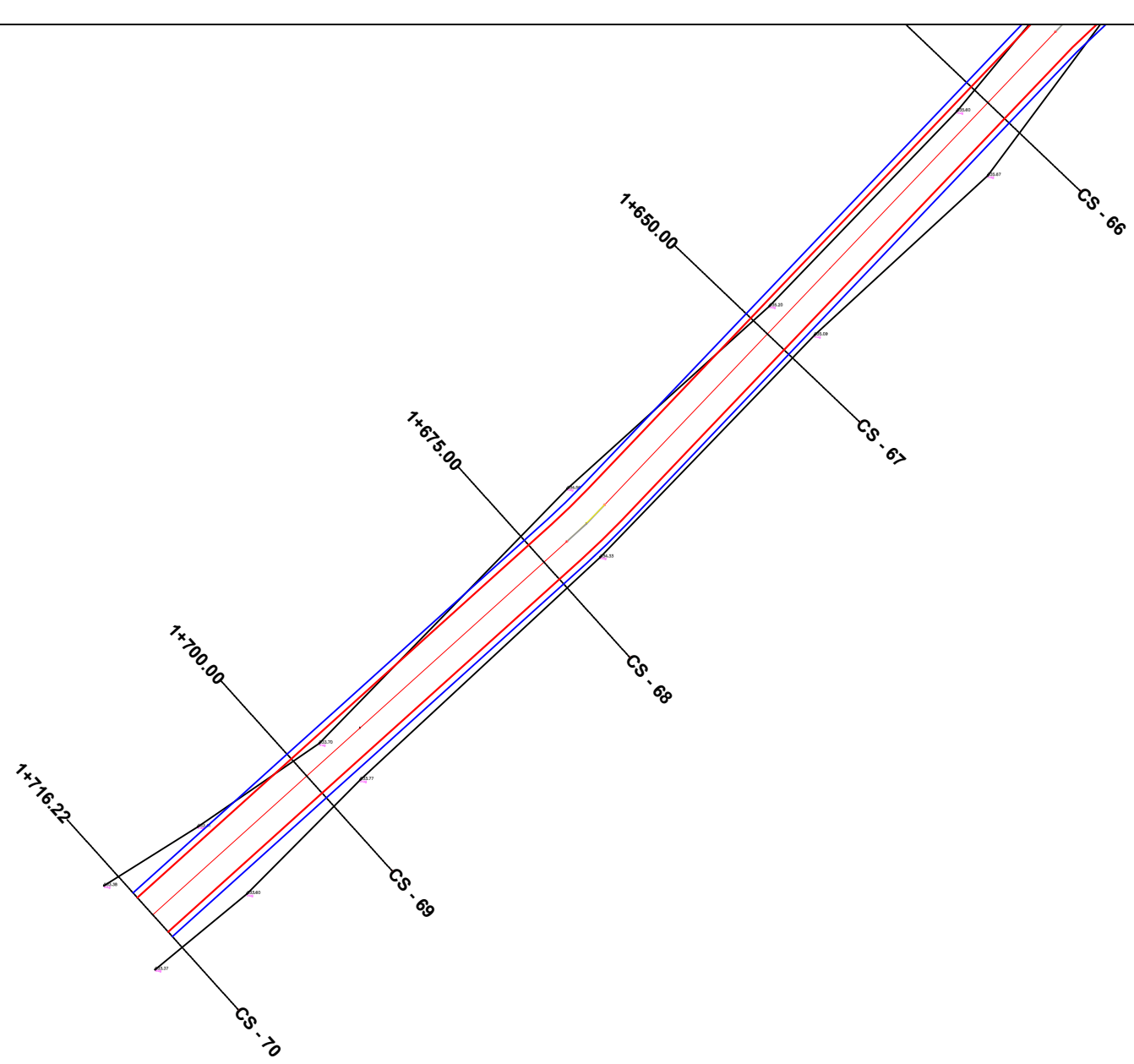

POROSITES : BASHKIA DIBER
 RIKONSTRUKSION DHE SISTEMIM ASFALTIM I RRUGES
 SE FSHATIT MAJTARE E POSHTME , NJ.A MAQELLARE

EMERTIMI : PLANIMETRIA E PËRGJITHSHME



"ERALD-G" sh.p.k
 Rruga "Kongresi i Lushnjes"
 Tirane

DREJTUES PROJEKTI

Ing.Gezim ISLAMI

PROJEKTUES

Ing.Erindi GJOKA	Hidr.Anisa ZAKA
Top.Alfred NDREGJONI	Mek.Arben MUHA
Top.Kujtim CANAMETI	Ing.Eraldo ISLAMI

SHKALLA

SHK - 1:500
 TIRANE 2022

FLETA

2 - 09
 FORMAT A3

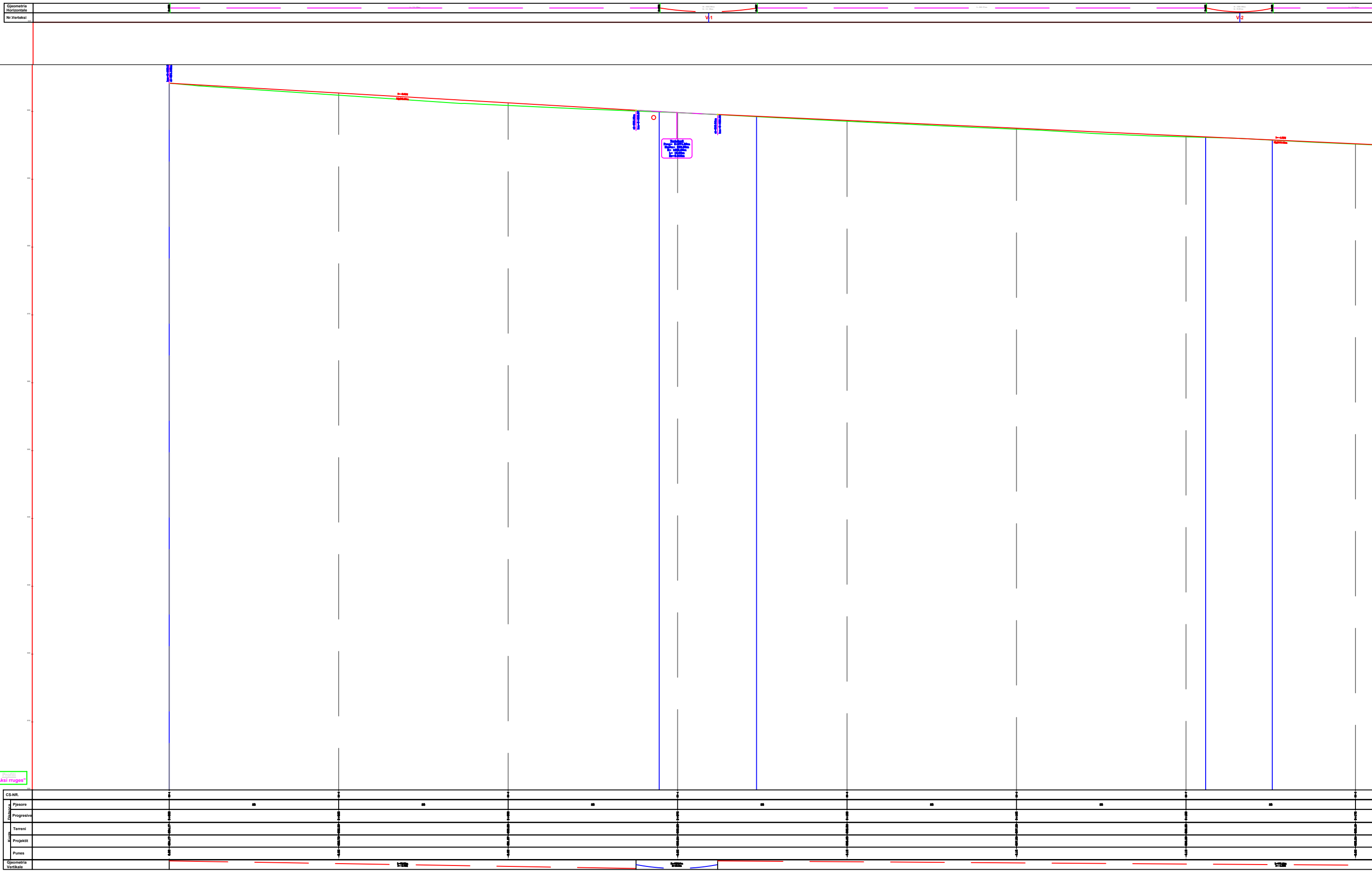

PROJESITUES : BASHKIA DIBER
 RIKONSTRUKSION DHE SISTEMIM ASFALTIM I RRUGES
 SE FSHATIT MAJTARE E POSHTME , NJ.A MAQELLARE

EMERTIMI : PROFILI GJATESORE

"ERALD-G" sh.p.k
 Rruga "Kongresi i Lushnjes"
 Tirane

DREJTUES PROJEKTI	PROJEKTUES	
Ing.Gezim ISLAMI	Ing.Erindi GJOKA	Hidr.Anisa ZAKA
	Top.Alfred NDREGJONI	Mek.Arben MUHA
	Top.Kujtim CANAMETI	Ing.Eraldo ISLAMI

SHKALLA	FLETA
1 : 500	3 : 01
TIRANE 2022	FORMAT A3

PROJ. "Aksi rruges"

CS-NR.	Pjesore	Progresive	Terroni	Projekti	Punes	Geometria Vertikale

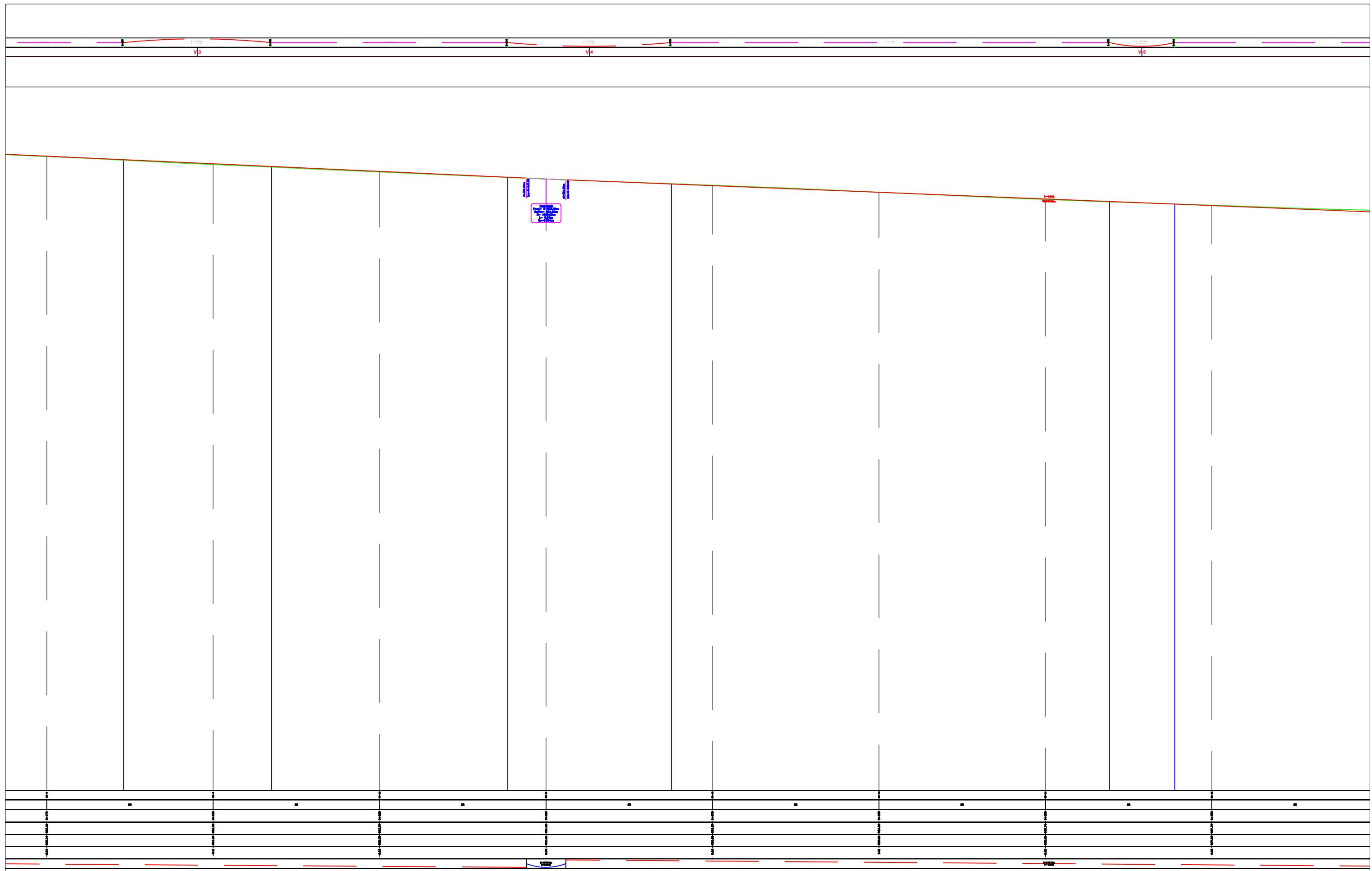

POROSITES : BASHKIA DIBER
 RIKONSTRUKSION DHE SISTEMIM ASFALTIM I RRUGES
 SE FSHATIT MAJTARE E POSHTME , NJ.A MAQELLARE

EMERTIMI : PROFILI GJATESORE

 "ERALD-G" sh.p.k
 Rruga "Kongresi i Lushnjes"
 Tirane

DREJTUES PROJEKTI
 Ing.Gezim ISLAMI

PROJEKTUES

Ing.Erindi GJOKA	Hidr.Anisa ZAKA
Top.Alfred NDREGJONI	Mek.Arben MUHA
Top.Kujtim CANAMETI	Ing.Eraldo ISLAMI

SHKALLA	FLETA
1 : 500	3 : 02
TIRANE 2022	FORMAT A3

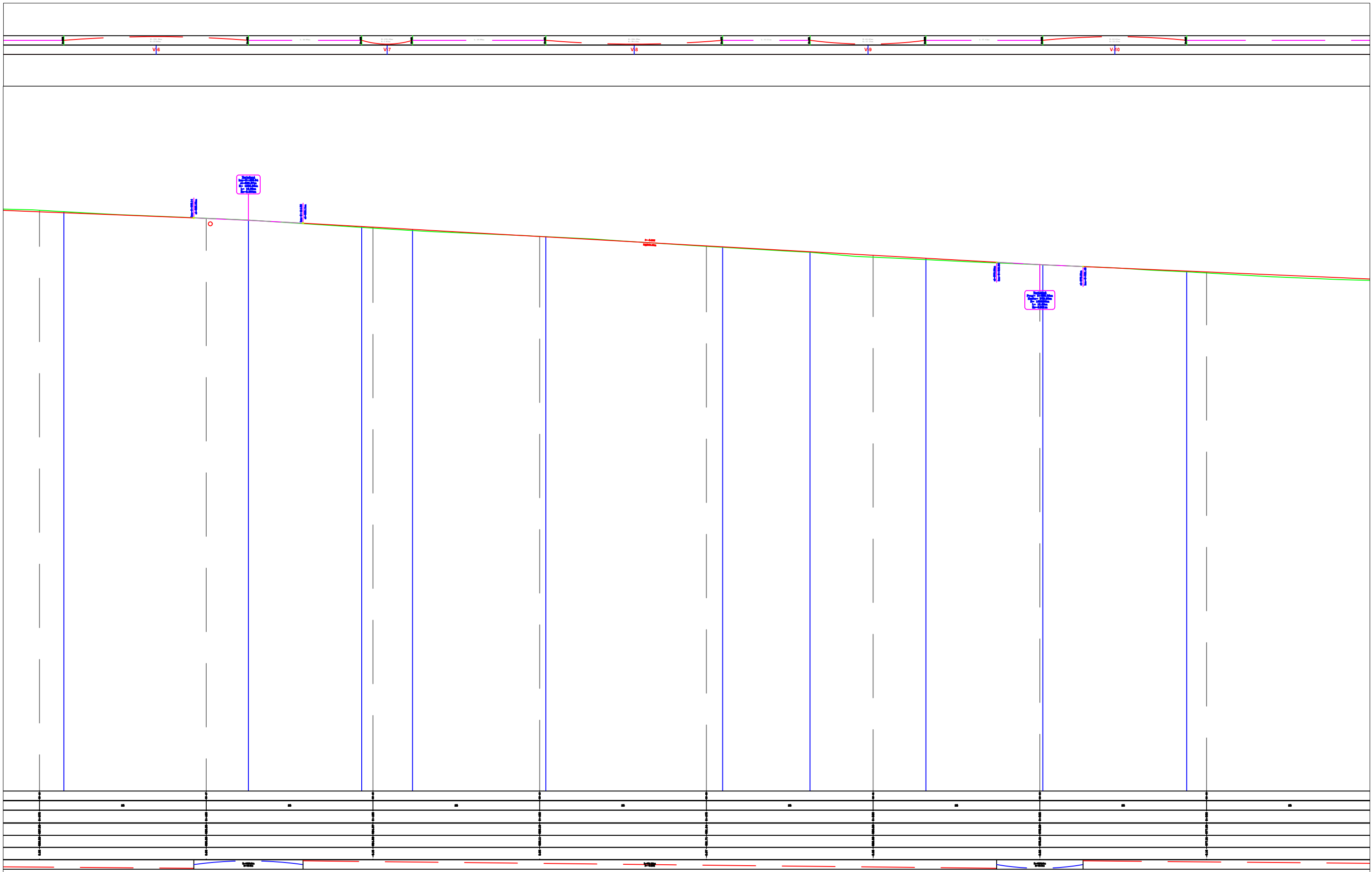

POROSITES : BASHKIA DIBER
 RIKONSTRUKSION DHE SISTEMIM ASFALTIM I RRUGES
 SE FSHATIT MAJTARE E POSHTME , NJ.A MAQELLARE

EMERTIMI : PROFILI GJATESORE
 "ERALD-G" sh.p.k
 Rruga "Kongresi i Lushnjes"
 Tirane

DREJTUES PROJEKTI
 Ing.Gezim ISLAMI

PROJEKTUES
 Ing.Erindi GJOKA
 Top.Alfred NDRREGJONI
 Top.Kujtim CANAMETI
 Hidr.Anisa ZAKA
 Mek.Arben MUHA
 Ing.Eraldo ISLAMI

SHKALLA	FLETA
1 : 500	3 : 03
TIRANE 2022	FORMAT A3

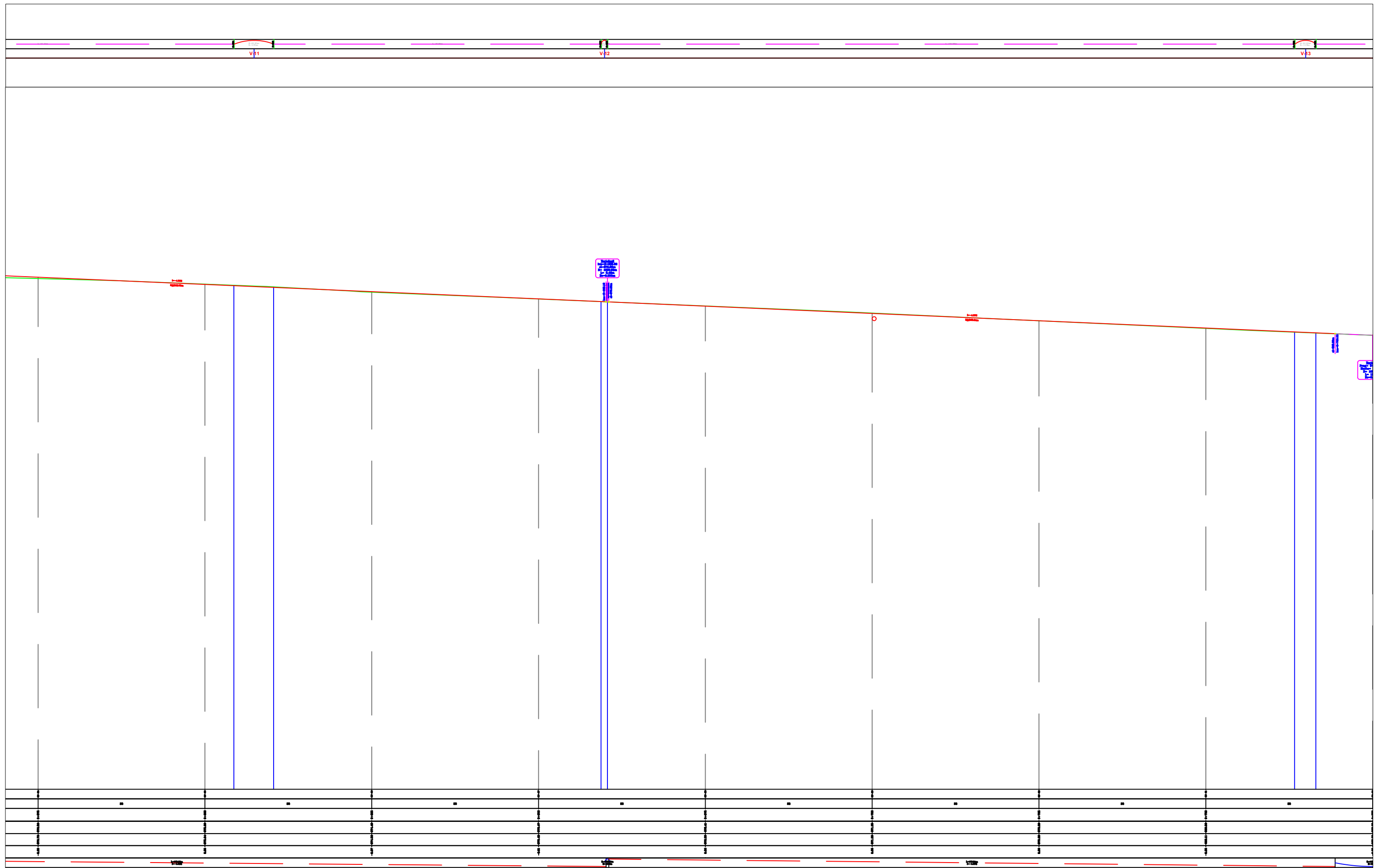

POROSITES : BASHKIA DIBER
 RIKONSTRUKSION DHE SISTEMIM ASFALTIM I RRUGES
 SE FSHATIT MAJTARE E POSHTME , NJ.A MAQELLARE

EMERTIMI : PROFILI GJATESORE
 "ERALD-G" sh.p.k
 Rruga "Kongresi i Lushnjes"
 Tirane

DREJTUES PROJEKTI
 Ing.Gezim ISLAMI

PROJEKTUES
 Ing.Erindi GJOKA
 Top.Alfred NDRREGJONI
 Top.Kujtim CANAMETI
 Hidr.Anisa ZAKA
 Mek.Arben MUHA
 Ing.Eraldo ISLAMI

SHKALLA	FLETA
1 : 500	3 : 04
TIRANE 2022	FORMAT A3

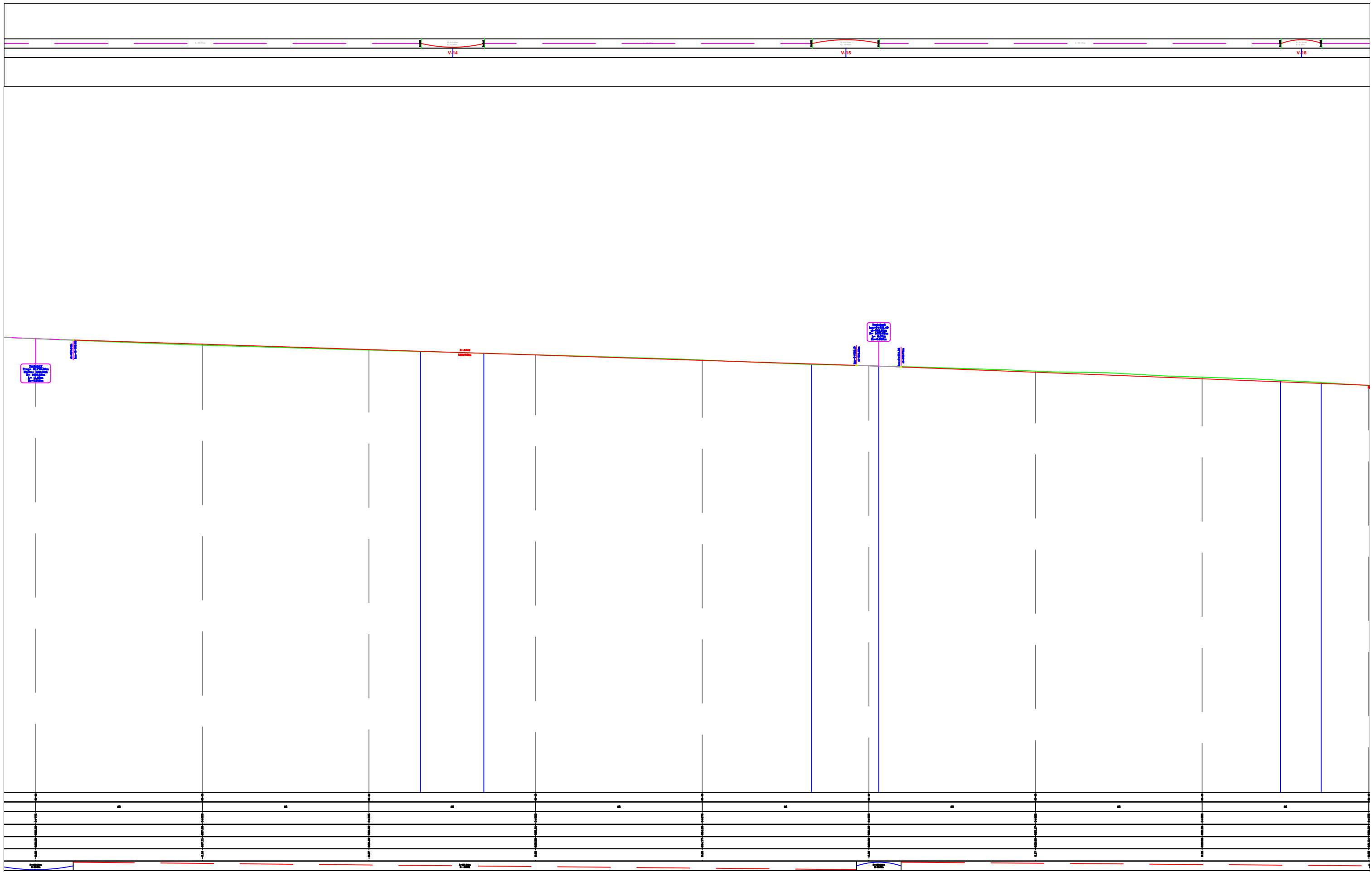

POROSITES : BASHKIA DIBER
 RIKONSTRUKSION DHE SISTEMIM ASFALTIM I RRUGES
 SE FSHATIT MAJTARE E POSHTME , NJ.A MAQELLARE

EMERTIMI : PROFILI GJATESORE
 "ERALD-G" sh.p.k
 Rruga "Kongresi i Lushnjes"
 Tirane

DREJTUES PROJEKTI	PROJEKTUES		
Ing.Gezim ISLAMI	Ing.Erindi GJOKA	Hidr.Anisa ZAKA	
	Top.Alfred NDREGJONI	Mek.Arben MUHA	
	Top.Kujtim CANAMETI	Ing.Eraldo ISLAMI	

SHKALLA	FLETA
1 : 500	3 : 05
TIRANE 2022	FORMAT A3

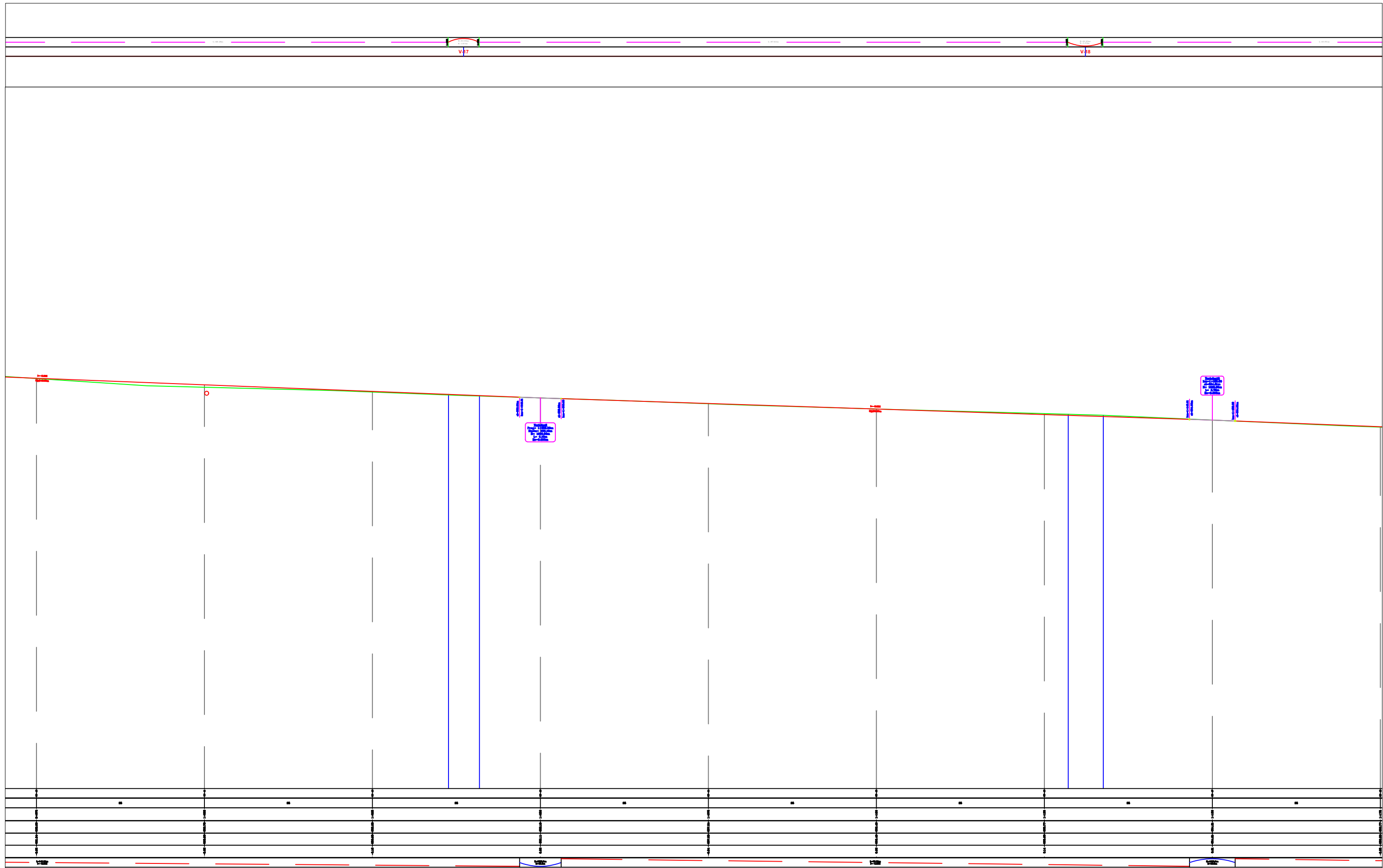

POROSITES : BASHKIA DIBER
 RIKONSTRUKSION DHE SISTEMIM ASFALTIM I RRUGES
 SE FSHATIT MAJTARE E POSHTME , NJ.A MAQELLARE

EMERTIMI : PROFILI GJATESORE
 "ERALD-G" sh.p.k
 Rruga "Kongresi i Lushnjes"
 Tirane

DREJTUES PROJEKTI
 Ing.Gezim ISLAMI

PROJEKTUES
 Ing.Erindi GJOKA
 Top.Alfred NDRREGJONI
 Top.Kujtim CANAMETI
 Hidr.Anisa ZAKA
 Mek.Arben MUHA
 Ing.Eraldo ISLAMI

SHKALLA	FLETA
1 : 500	3 : 06
TIRANE 2022	FORMAT A3

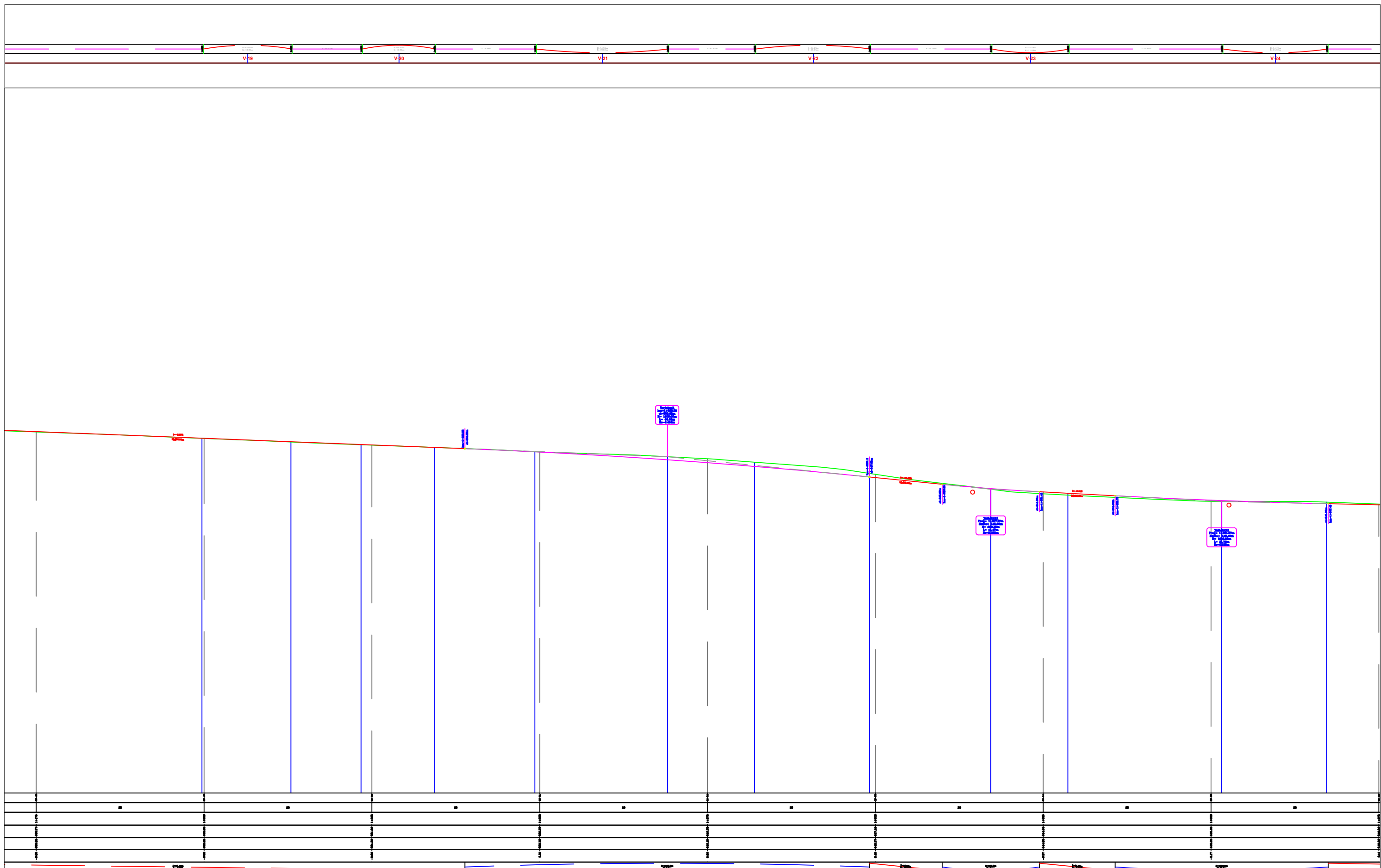

POROSITES : BASHKIA DIBER
 RIKONSTRUKSION DHE SISTEMIM ASFALTIM I RRUGES
 SE FSHATIT MAJTARE E POSHTME , NJ.A MAQELLARE

EMERTIMI : PROFILI GJATESORE
 "ERALD-G" sh.p.k
 Rruga "Kongresi i Lushnjes"
 Tirane

DREJTUES PROJEKTI
 Ing.Gezim ISLAMI

PROJEKTUES	
Ing.Erindi GJOKA	Hidr.Anisa ZAKA
Top.Alfred NDREGJONI	Mek.Arben MUHA
Top.Kujtim CANAMETI	Ing.Eraldo ISLAMI

SHKALLA	FLETA
1 : 500	3 : 07
TIRANE 2022	FORMAT A3

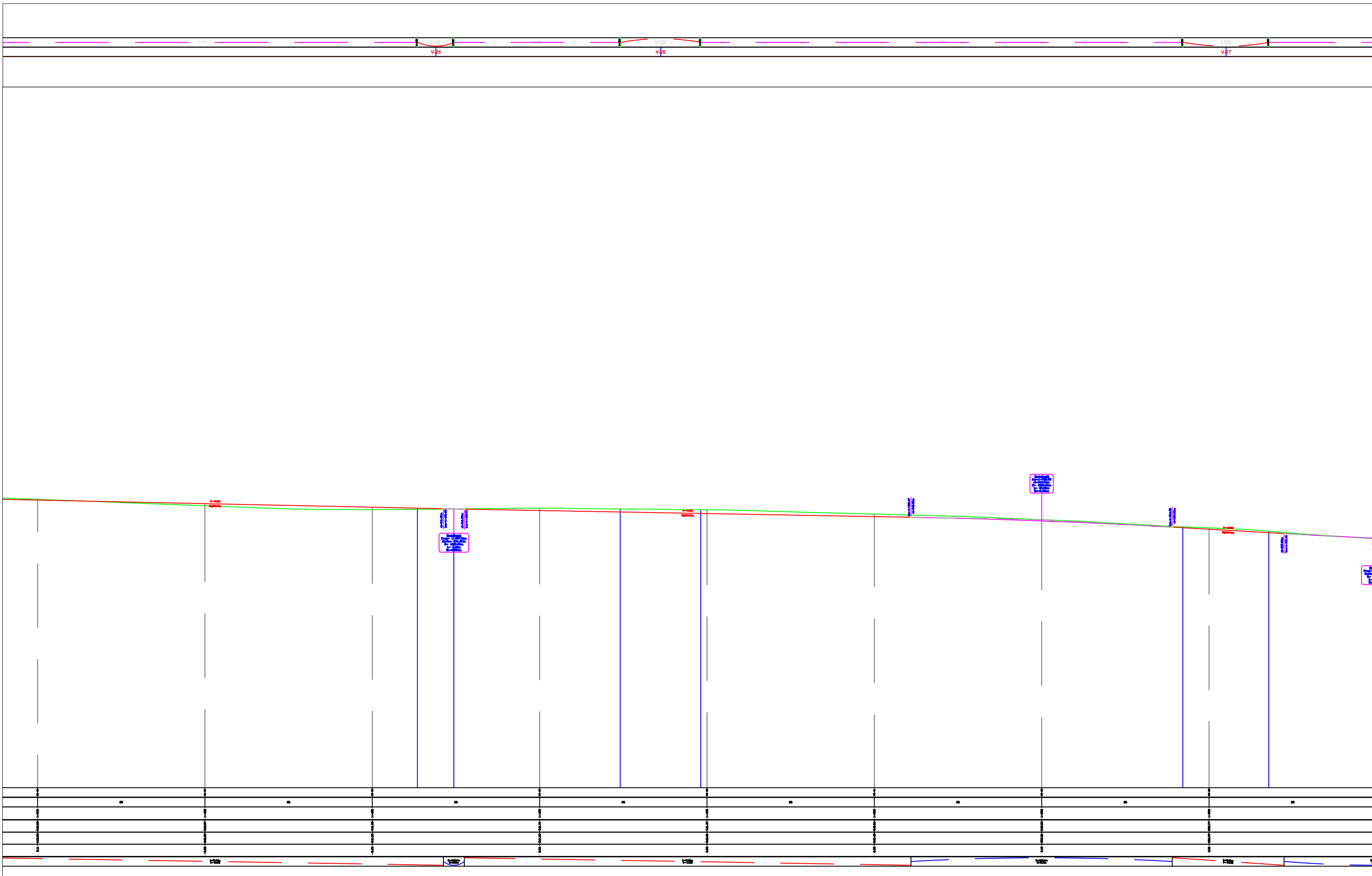

POROSITES : BASHKIA DIBER
 RIKONSTRUKSION DHE SISTEMIM ASFALTIM I RRUGES
 SE FSHATIT MAJTARE E POSHTME , NJ.A MAQELLARE

EMERTIMI : PROFILI GJATESORE
 "ERALD-G" sh.p.k
 Rruga "Kongresi i Lushnjes"
 Tirane

DREJTUES PROJEKTI
 Ing.Gezim ISLAMI

PROJEKTUES	
Ing.Erindi GJOKA	Hidr.Anisa ZAKA
Top.Alfred NDRREGJONI	Mek.Arben MUHA
Top.Kujtim CANAMETI	Ing.Eraldo ISLAMI

SHKALLA	FLETA
1 : 500	3 : 08
TIRANE 2022	FORMAT A3

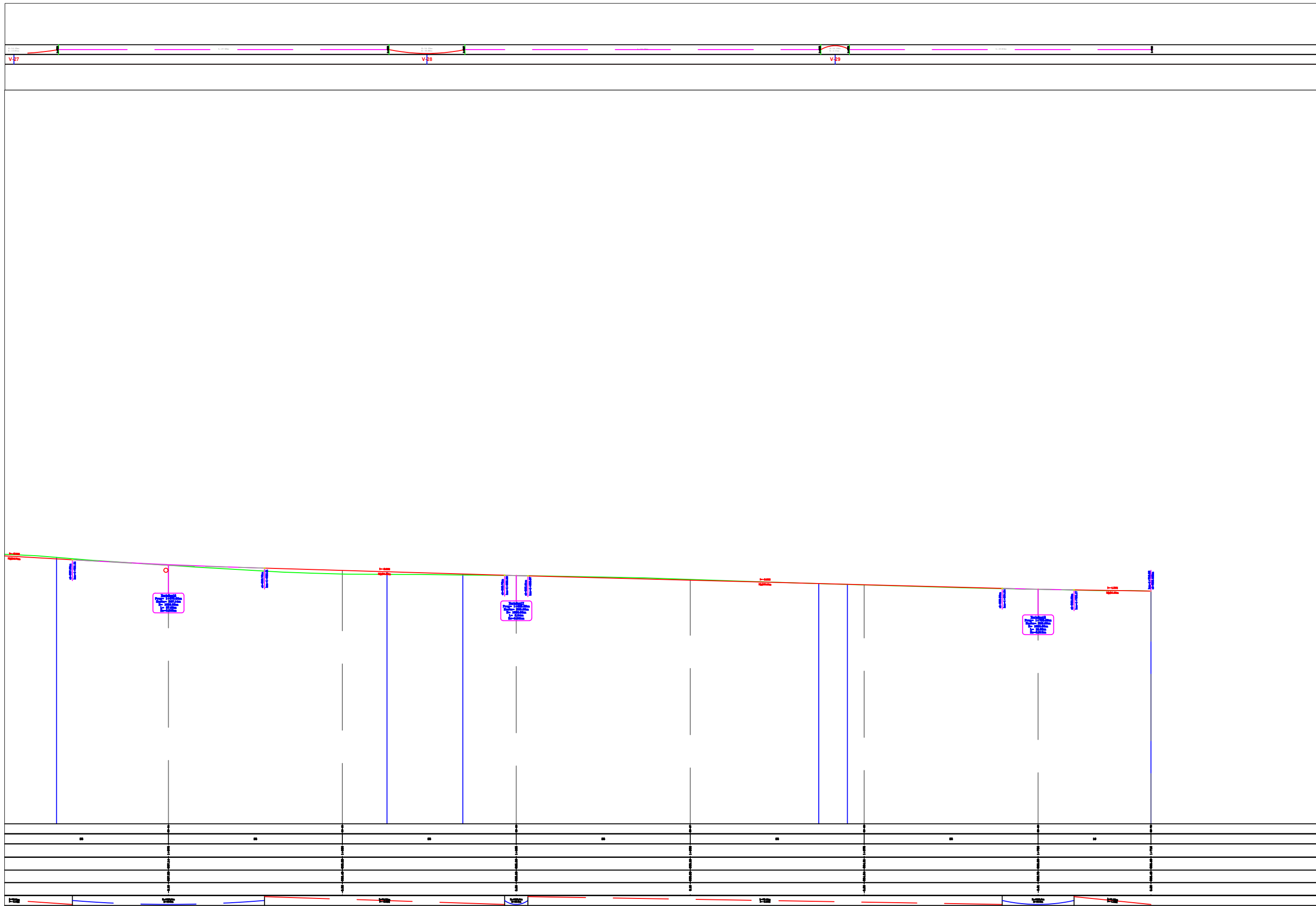

POROSITES : BASHKIA DIBER
 RIKONSTRUKSION DHE SISTEMIM ASFALTIM I RRUGES
 SE FSHATIT MAJTARE E POSHTME , NJ.A MAQELLARE

EMERTIMI : PROFILI GJATESORE
 "ERALD-G" sh.p.k
 Rruga "Kongresi i Lushnjes"
 Tirane

DREJTUES PROJEKTI
 Ing.Gezim ISLAMI

PROJEKTUES			
Ing.Erindi GJOKA		Hidr.Anisa ZAKA	
Top.Alfred NDRREGJONI		Mek.Arben MUHA	
Top.Kujtim CANAMETI		Ing.Eraldo ISLAMI	

SHKALLA	FLETA
1 : 500	3 : 09
TIRANE 2022	FORMAT A3

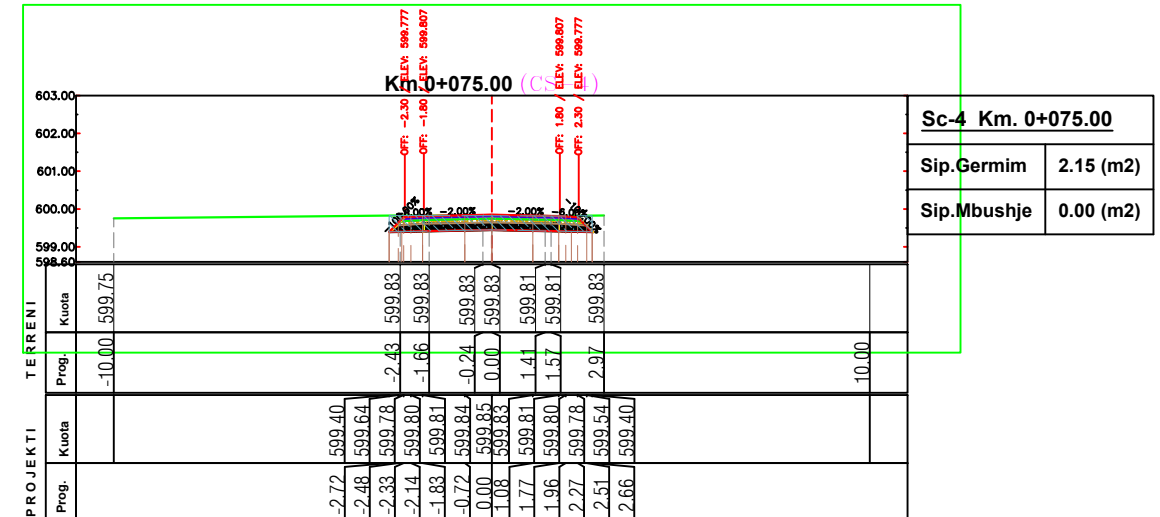
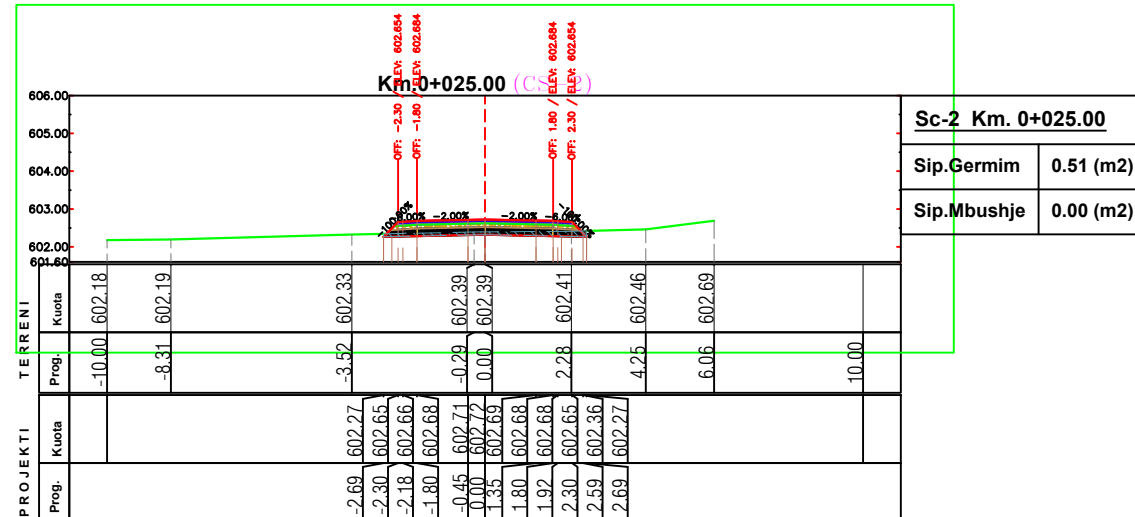
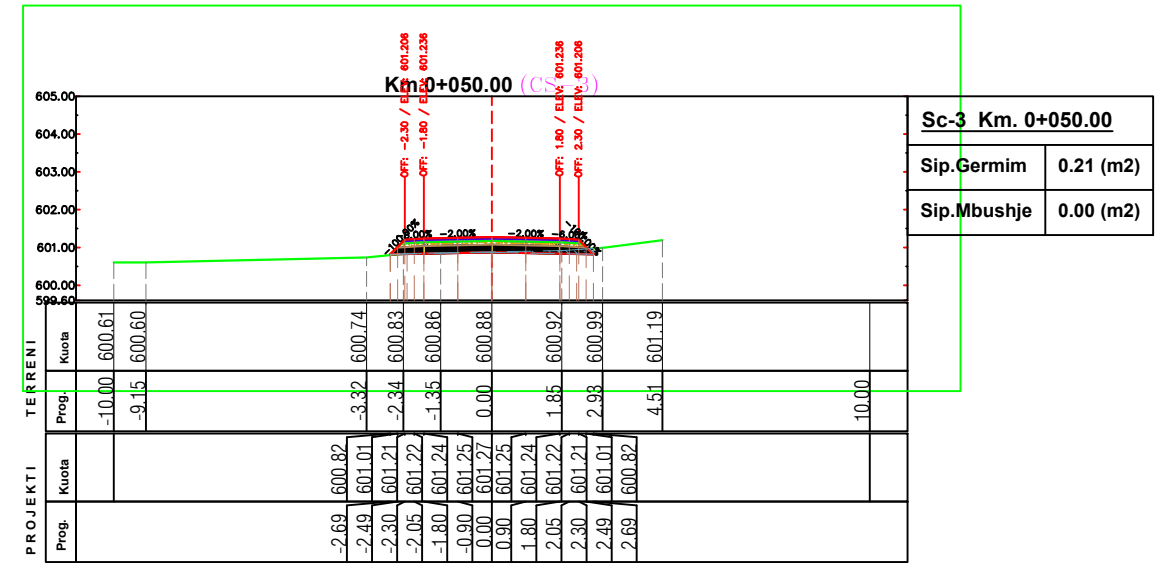
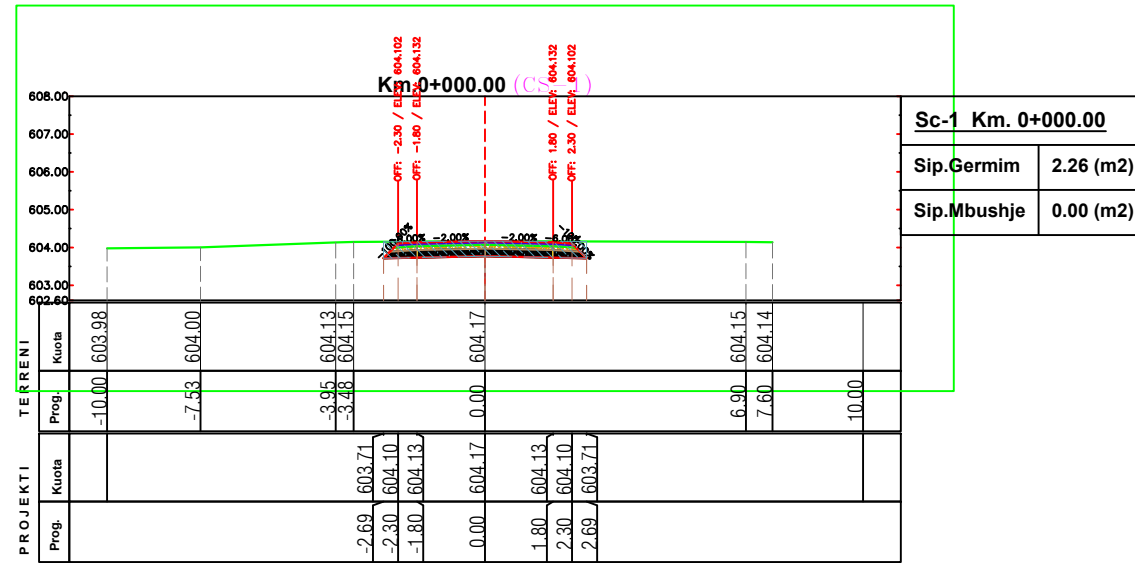

PROPOSITES : BASHKIA DIBER
 RIKONSTRUKSION DHE SISTEMIM ASFALTIM I RRUGES
 SE FSHATIT MAJTARE E POSHTME , NJ.A MAQELLARE

EMERTIMI : PROFILAT TERTHORE
 "ERALD-G" sh.p.k
 Rruga "Kongresi i Lushnjes"
 Tirane

DREJTUES PROJEKTI	PROJEKTUES	
Ing.Gezim ISLAMI	Ing.Erindi GJOKA	Hidr.Anisa ZAKA
	Top.Alfred NDRREGJONI	Mek.Arben MUHA
	Top.Kujtim CANAMETI	Ing.Eraldo ISLAMI

SHKALLA	FLETA
SHK - 1:200	4 - 01
TIRANE 2022	FORMAT A3

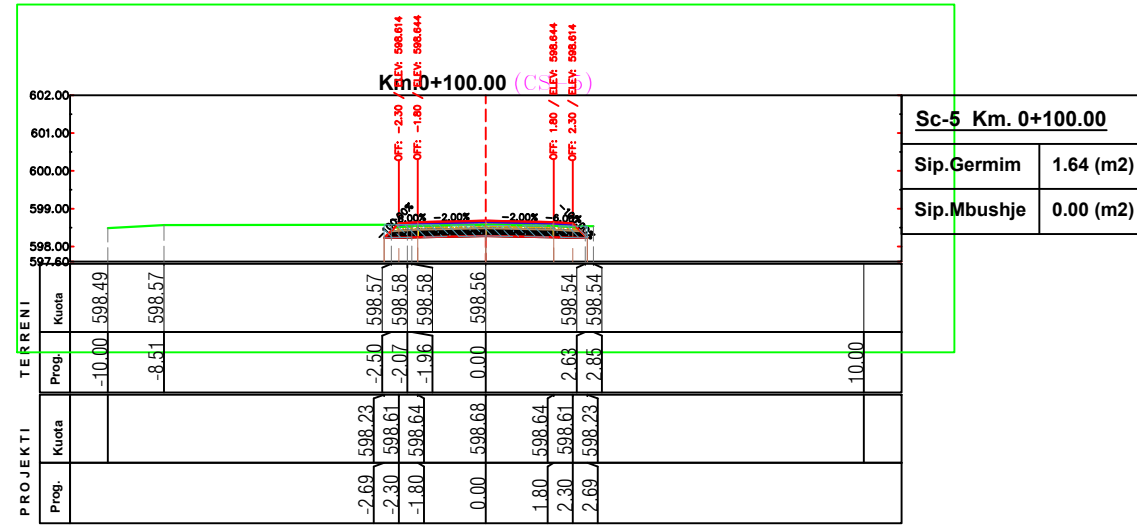

Sc-5 Km. 0+100.00	
Sip.Germim	1.64 (m2)
Sip.Mbushje	0.00 (m2)

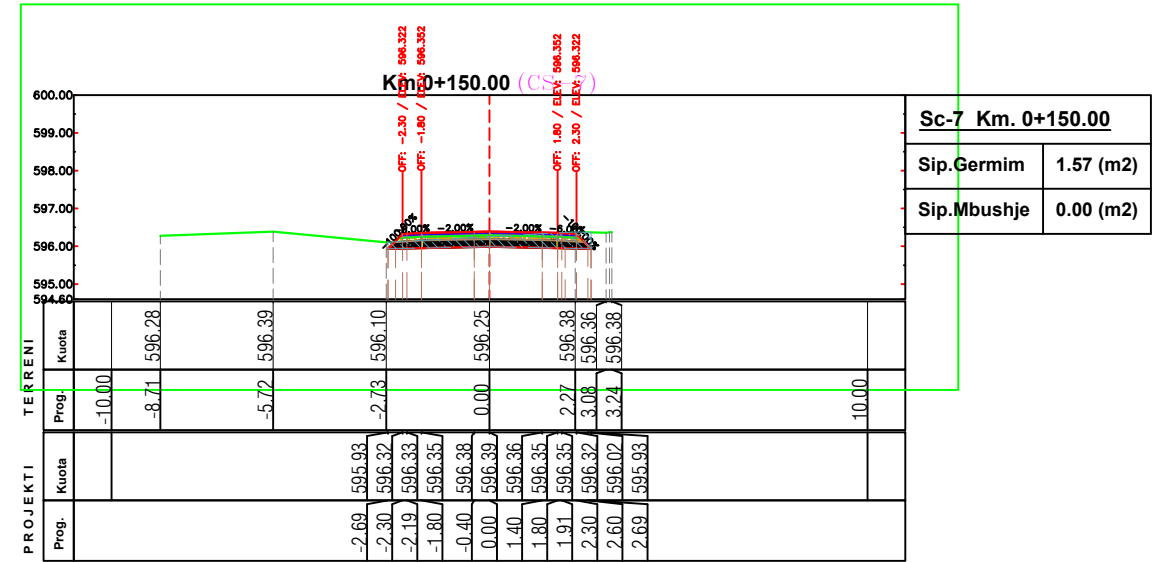

Sc-7 Km. 0+150.00	
Sip.Germim	1.57 (m2)
Sip.Mbushje	0.00 (m2)

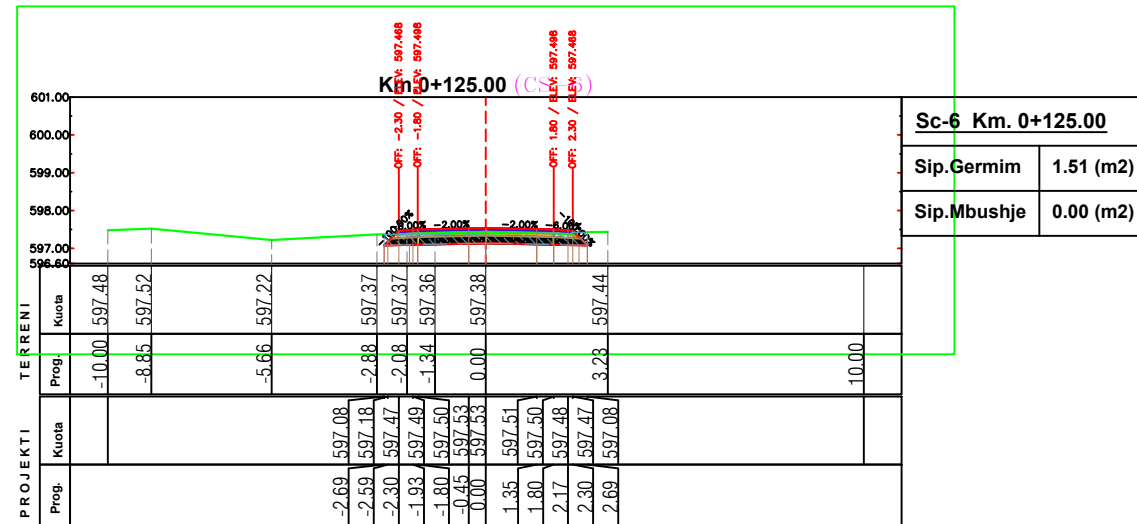

Sc-6 Km. 0+125.00	
Sip.Germim	1.51 (m2)
Sip.Mbushje	0.00 (m2)

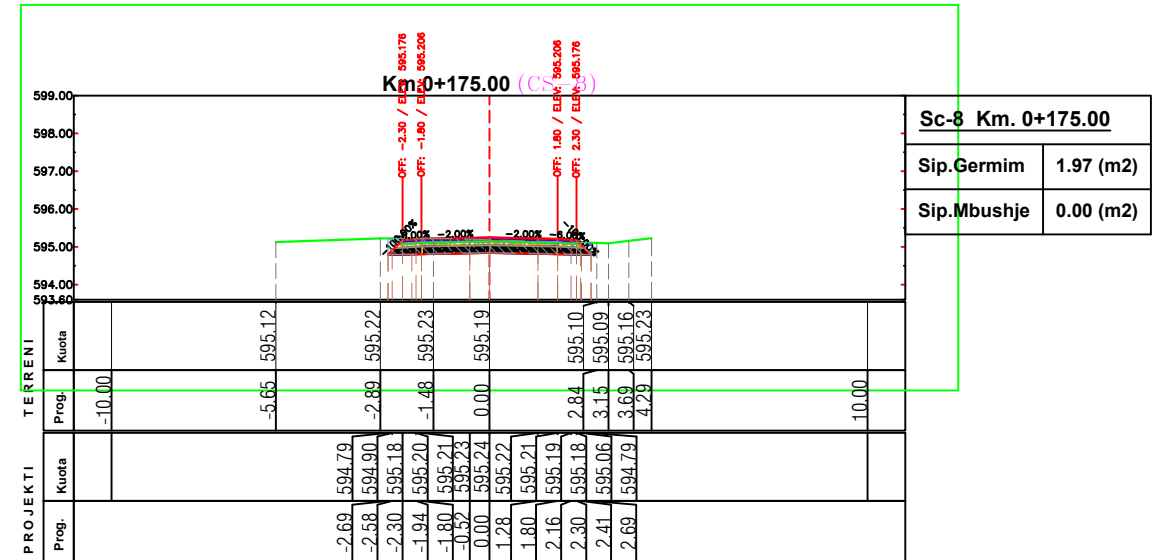

Sc-8 Km. 0+175.00	
Sip.Germim	1.97 (m2)
Sip.Mbushje	0.00 (m2)

POROSITES : BASHKIA DIBER

RIKONSTRUKSION DHE SISTEMIM ASFALTIM I RRUGES
SE FSHATIT MAJTARE E POSHTME , NJ.A MAQELLARE

EMERTIMI : PROFILAT TERTHORE

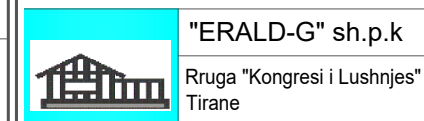

DREJTUES PROJEKTI

Ing.Gezim ISLAMI

PROJEKTUES

Ing.Erindi GJOKA	Hidr.Anisa ZAKA
Top.Alfred NDRREGJONI	Mek.Arben MUHA
Top.Kujtim CANAMETI	Ing.Eraldo ISLAMI

SHKALLA

SHK - 1:200

TIRANE 2022

FLETA

4 - 02

FORMAT A3

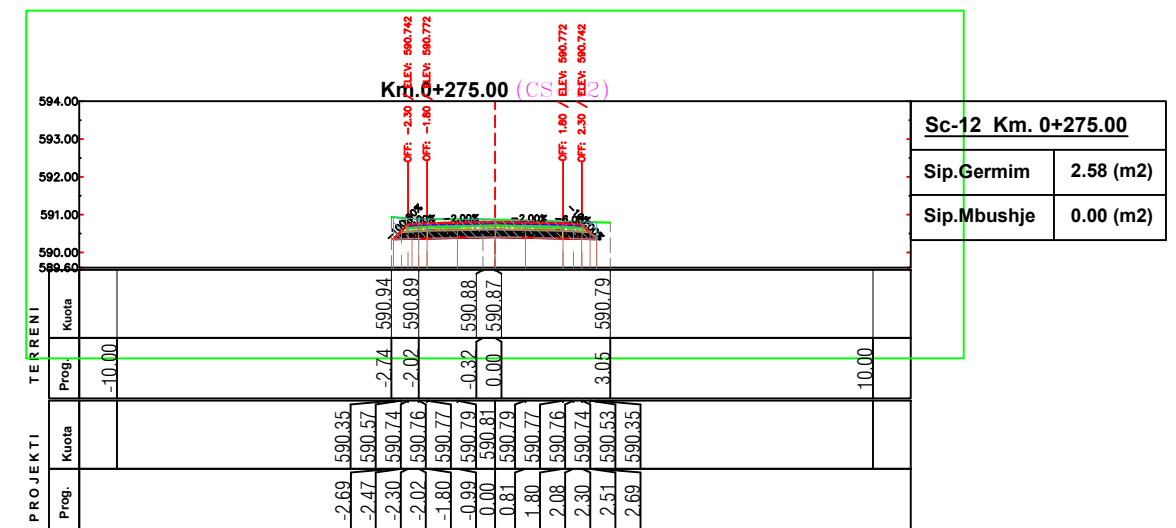
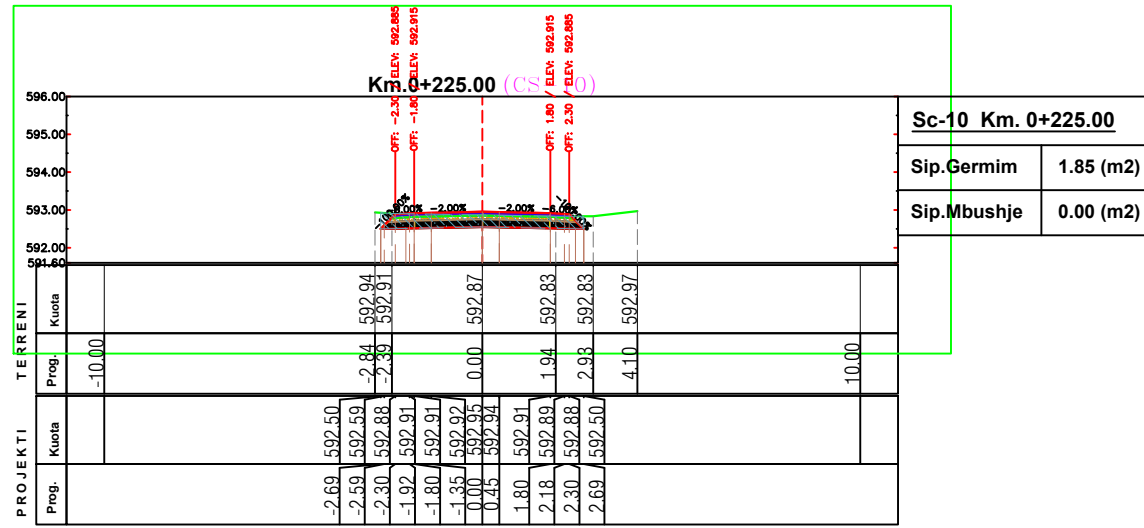
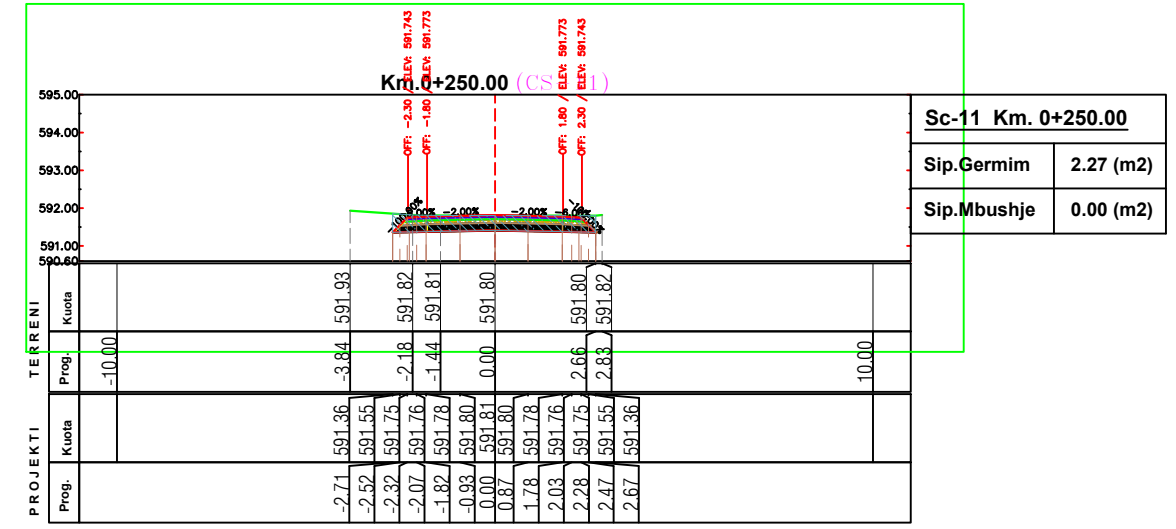
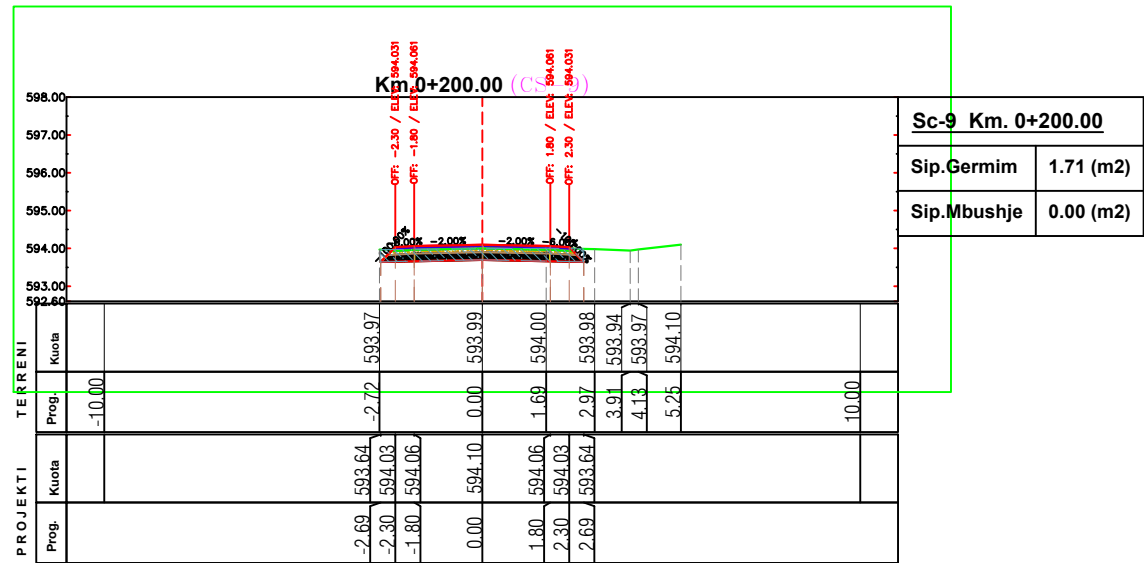

POROSITES : BASHKIA DIBER
 RIKONSTRUKSION DHE SISTEMIM ASFALTIM I RRUGES
 SE FSHATIT MAJTARE E POSHTME , NJ.A MAQELLARE

EMERTIMI : PROFILAT TERTHORE
 "ERALD-G" sh.p.k
 Rruga "Kongresi i Lushnjes"
 Tirane

DREJTUES PROJEKTI	PROJEKTUES		
Ing.Gezim ISLAMI	Ing.Erindi GJOKA	Hidr.Anisa ZAKA	
	Top.Alfred NDRREGJONI	Mek.Arben MUHA	
	Top.Kujtim CANAMETI	Ing.Eraldo ISLAMI	

SHKALLA	FLETA
SHK - 1:200	4 - 03
TIRANE 2022	FORMAT A3

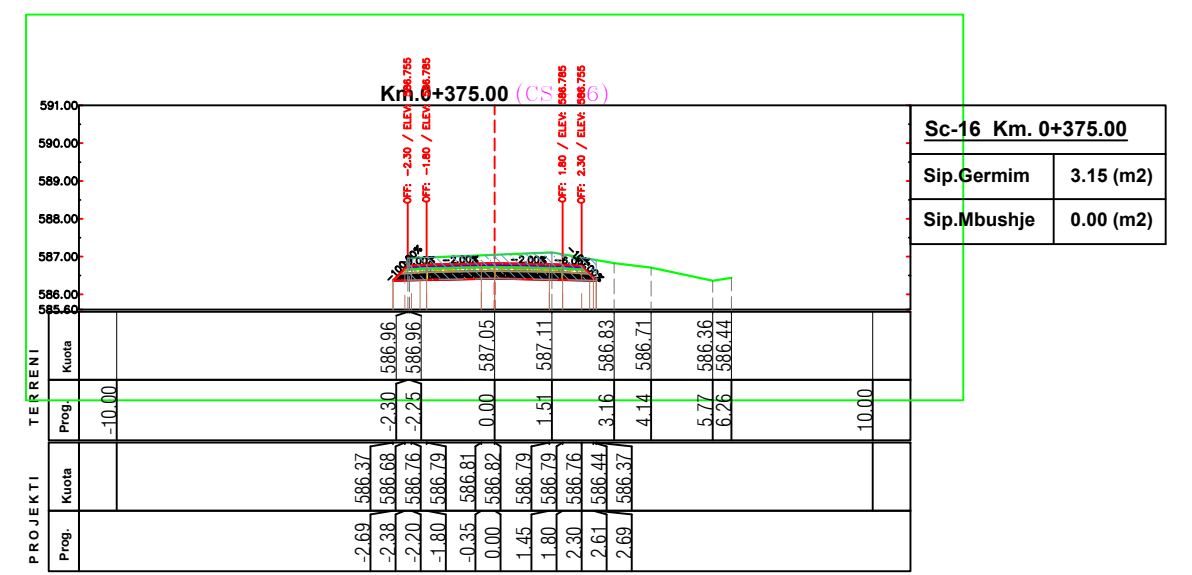
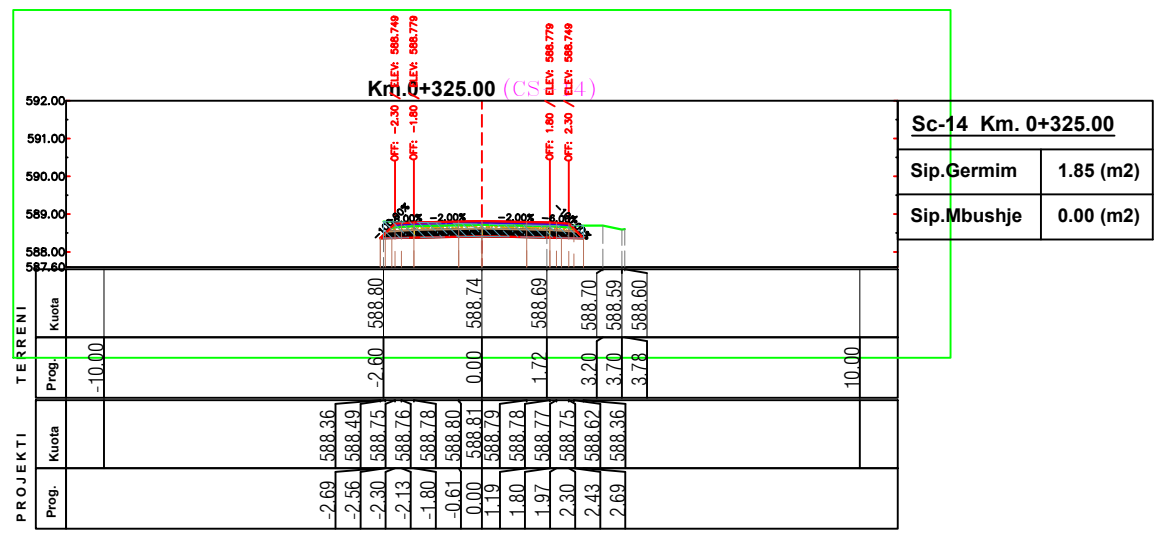
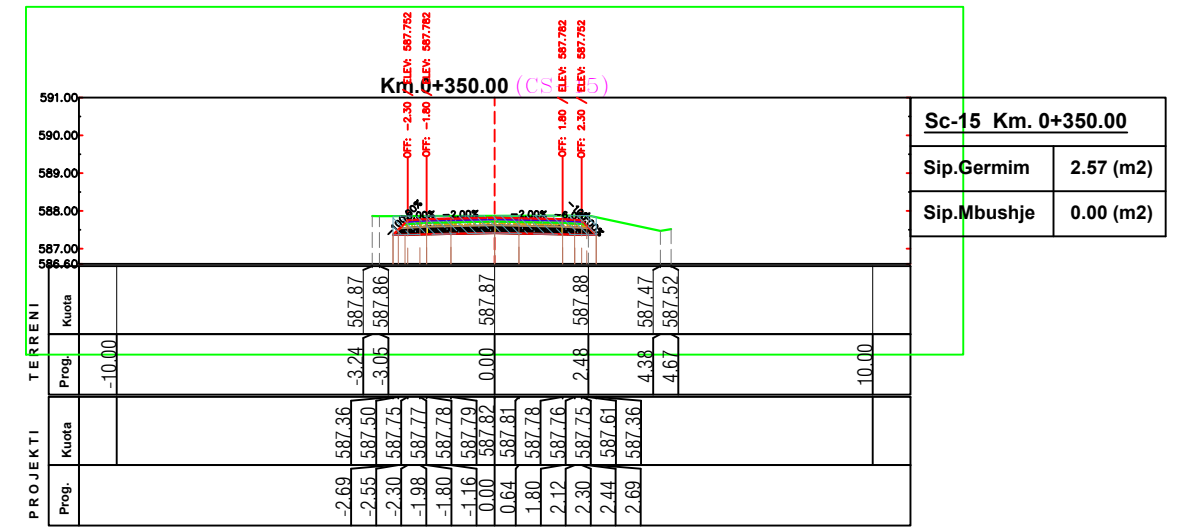
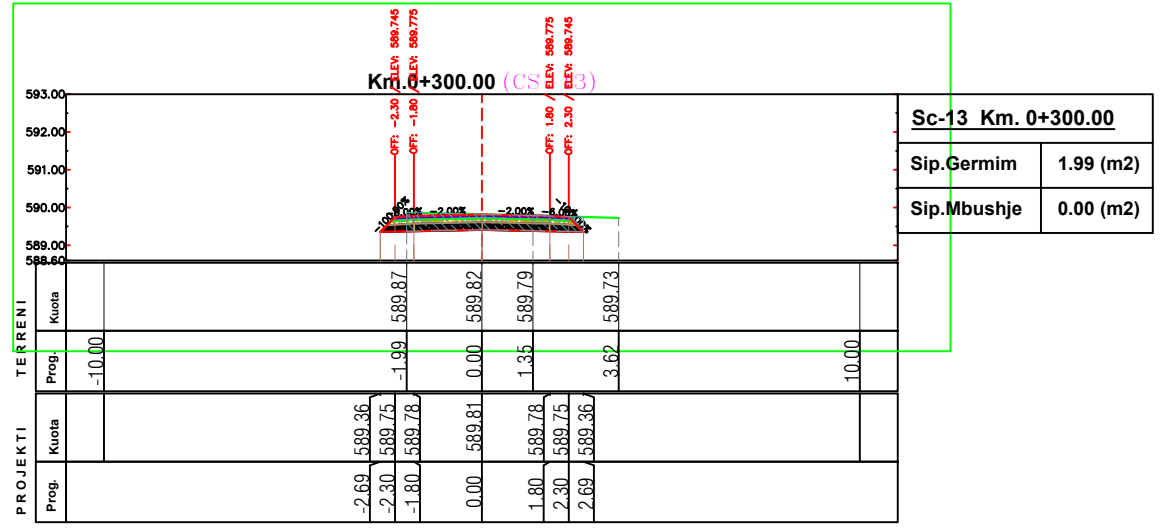

POROSITES : BASHKIA DIBER
 RIKONSTRUKSION DHE SISTEMIM ASFALTIM I RRUGES
 SE FSHATIT MAJTARE E POSHTME , NJ.A MAQELLARE

EMERTIMI : PROFILAT TERTHORE
 "ERALD-G" sh.p.k
 Rruga "Kongresi i Lushnjes"
 Tirane

DREJTUES PROJEKTI
 Ing.Gezim ISLAMI

PROJEKTUES
 Ing.Erindi GJOKA
 Hidr.Anisa ZAKA
 Mek.Arben MUHA
 Top.Kujtim CANAMETI
 Ing.Eraldo ISLAMI

SHKALLA
 SHK - 1:200
 TIRANE 2022

FLETA
 4 - 04
 FORMAT A3

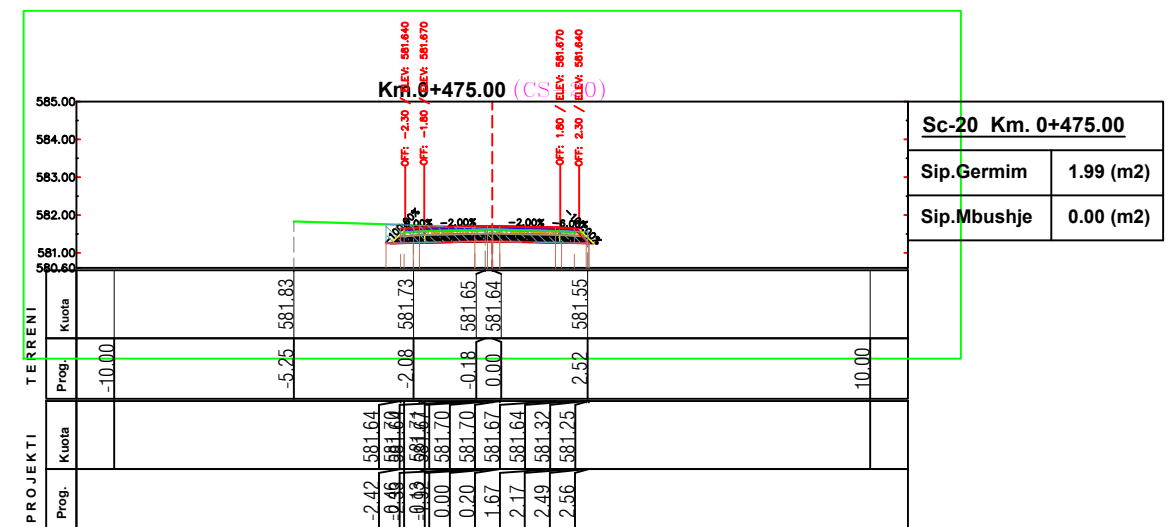
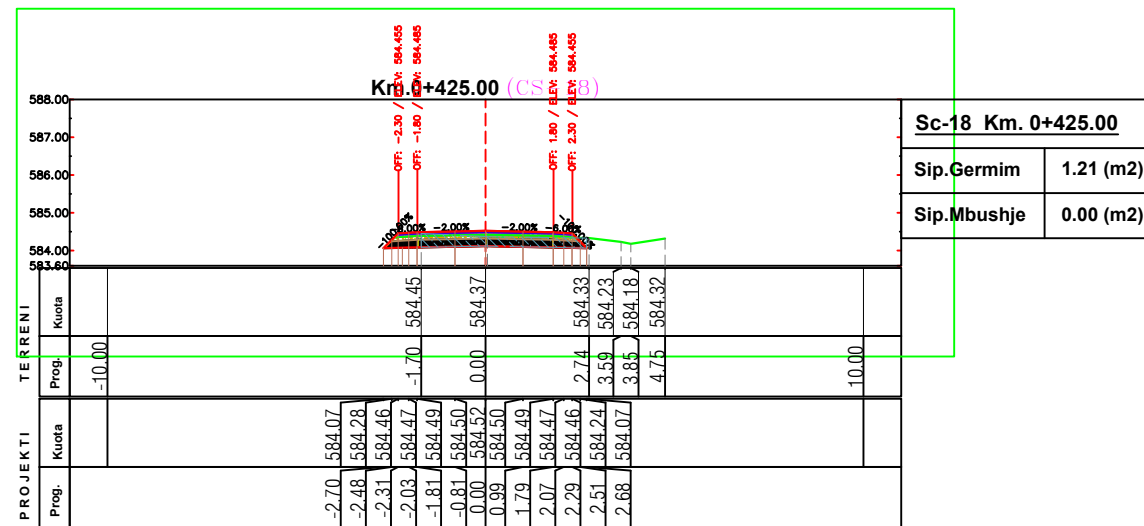
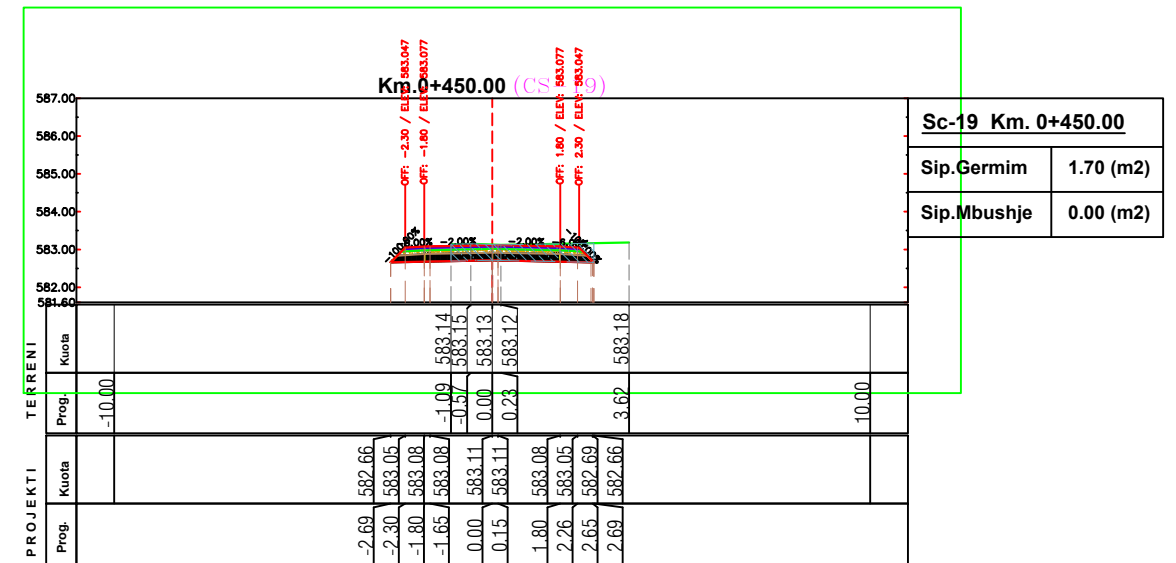
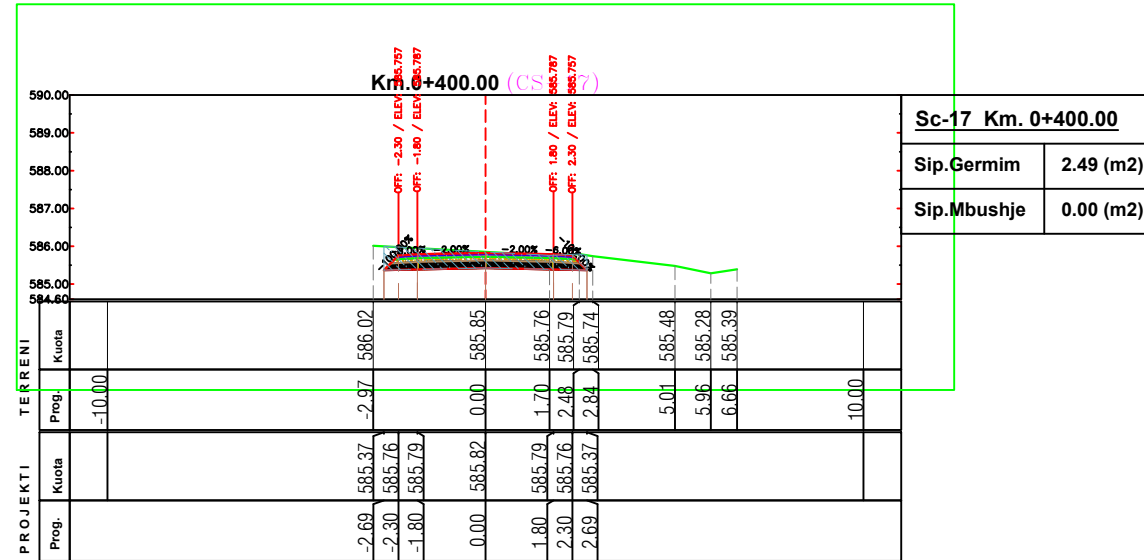

POROSITES : BASHKIA DIBER
 RIKONSTRUKSION DHE SISTEMIM ASFALTIM I RRUGES
 SE FSHATIT MAJTARE E POSHTME , NJ.A MAQELLARE

EMERTIMI : PROFILAT TERTHORE
 "ERALD-G" sh.p.k
 Rruga "Kongresi i Lushnjes"
 Tirane

DREJTUES PROJEKTI	PROJEKTUES			SHKALLA	FLETA
Ing.Gezim ISLAMI	Ing.Erindi GJOKA		Hidr.Anisa ZAKA	SHK - 1:200	4 - 05
	Top.Alfred NDRREGJONI		Mek.Arben MUHA		
	Top.Kujtim CANAMETI		Ing.Eraldo ISLAMI		
				TIRANE 2022	FORMAT A3

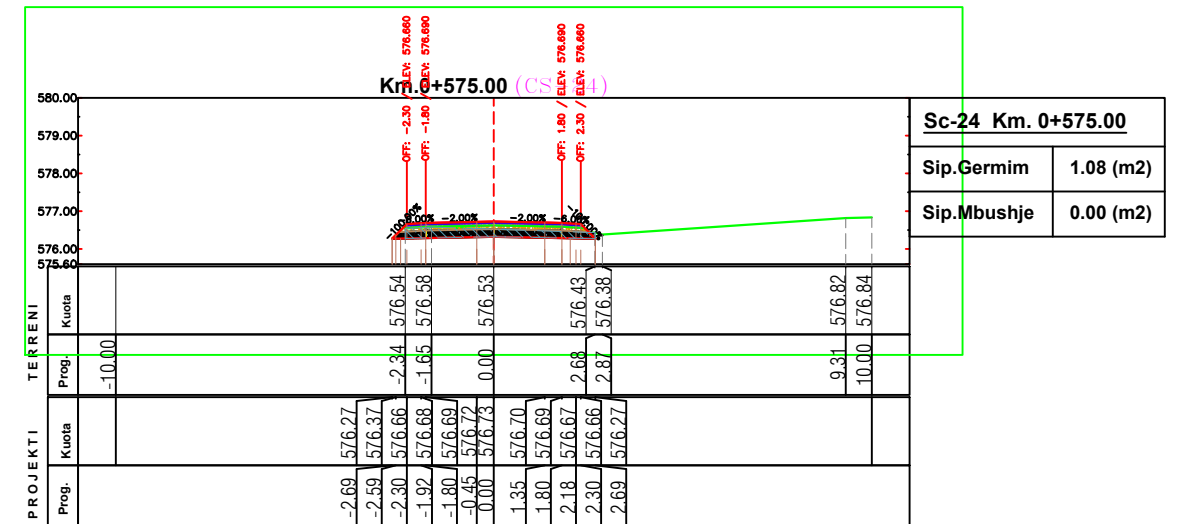
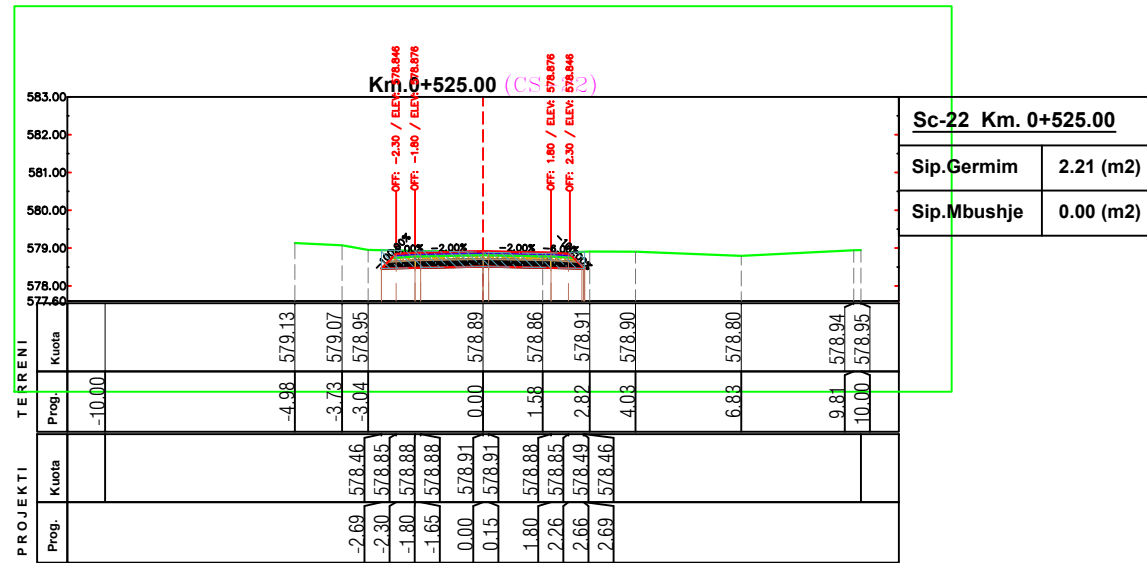
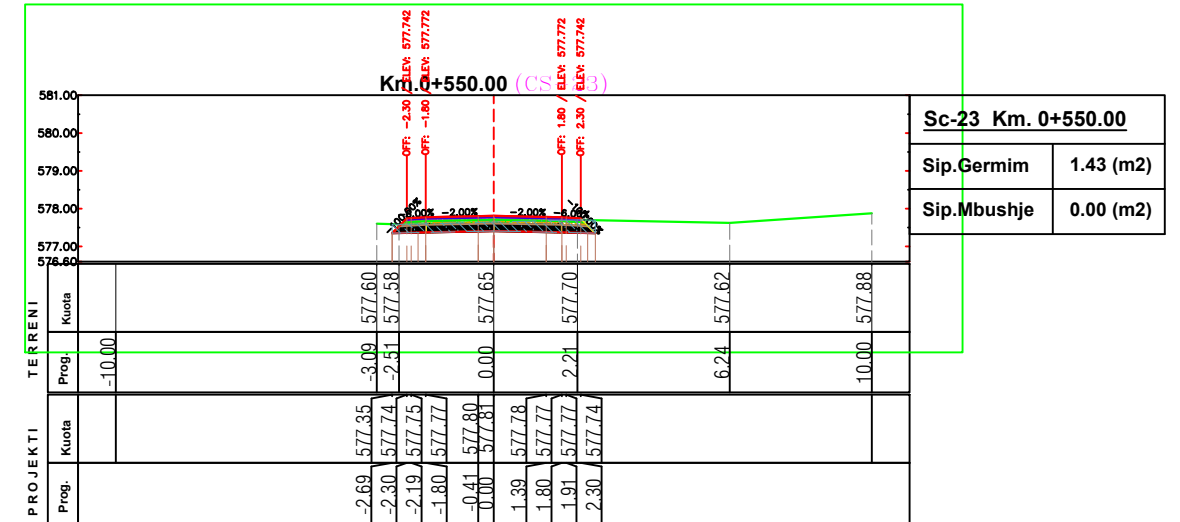
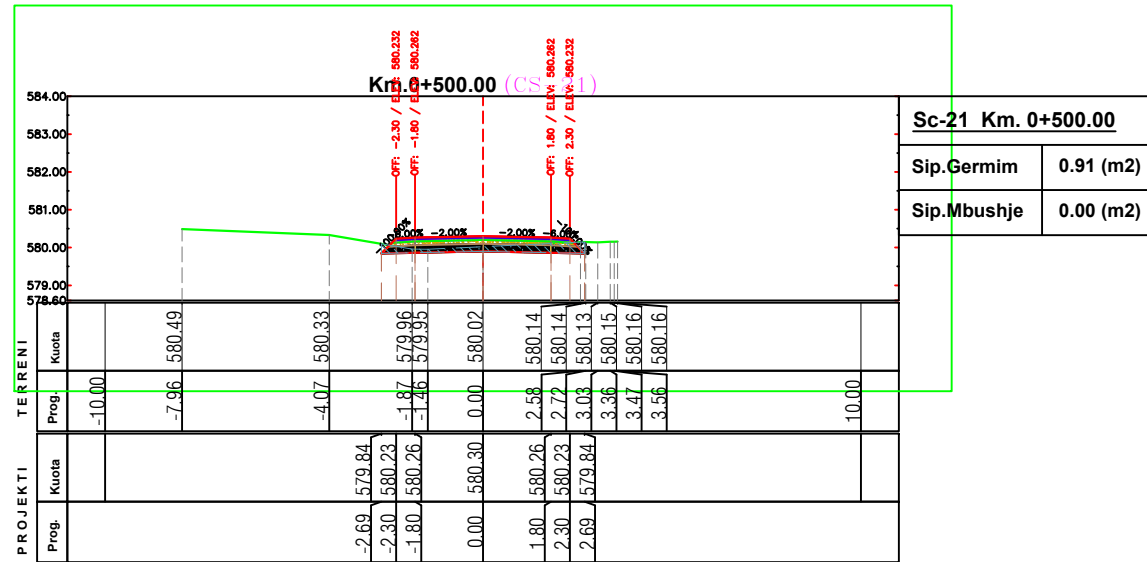

POROSITES : BASHKIA DIBER
 RIKONSTRUKSION DHE SISTEMIM ASFALTIM I RRUGES
 SE FSHATIT MAJTARE E POSHTME , NJ.A MAQELLARE

EMERTIMI : PROFILAT TERTHORE
 "ERALD-G" sh.p.k
 Rruga "Kongresi i Lushnjes"
 Tirane

DREJTUES PROJEKTI
 Ing.Gezim ISLAMI

PROJEKTUES
 Ing.Erindi GJOKA
 Hidr.Anisa ZAKA
 Top.Alfred NDRREGJONI
 Mek.Arben MUHA
 Top.Kujtim CANAMETI
 Ing.Eraldo ISLAMI

SHKALLA
 SHK - 1:200
 TIRANE 2022

FLETA
 4 - 06
 FORMAT A3

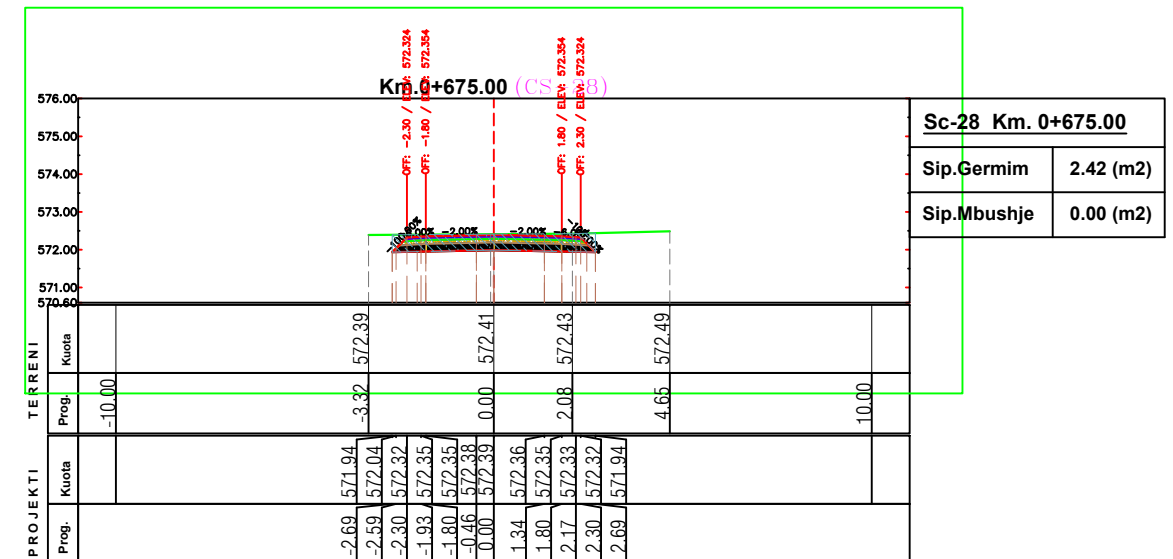
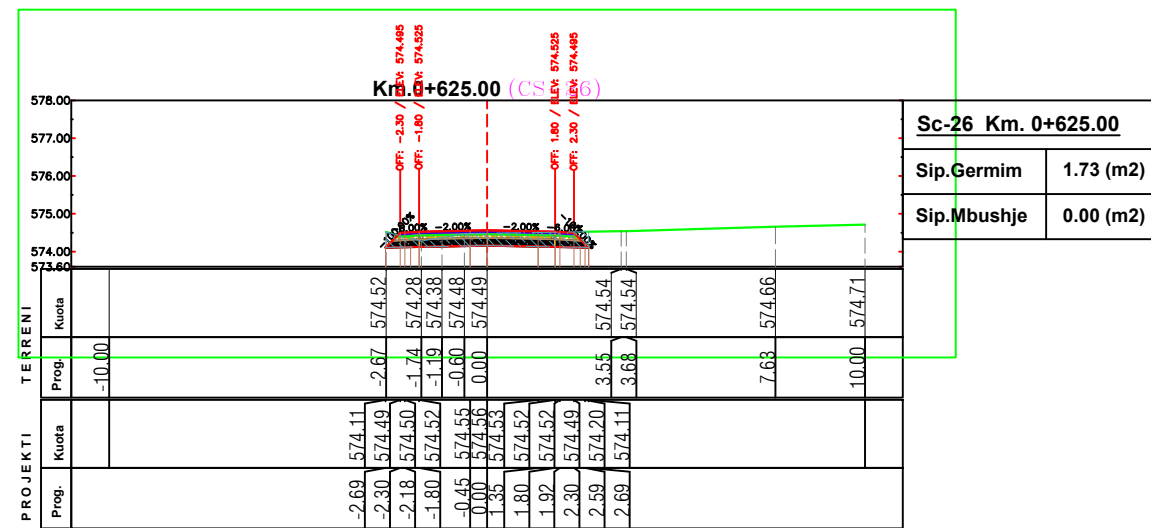
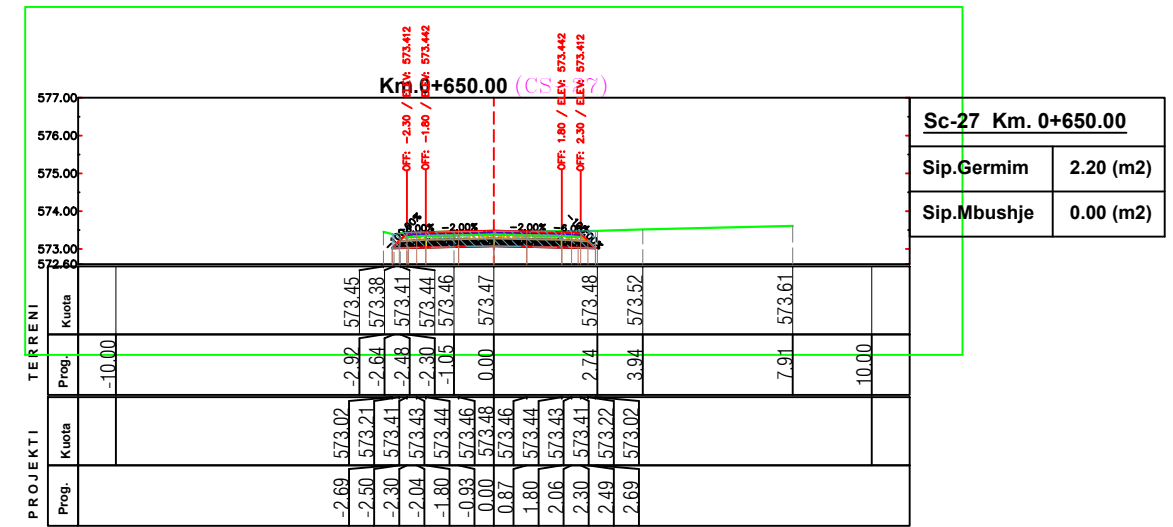
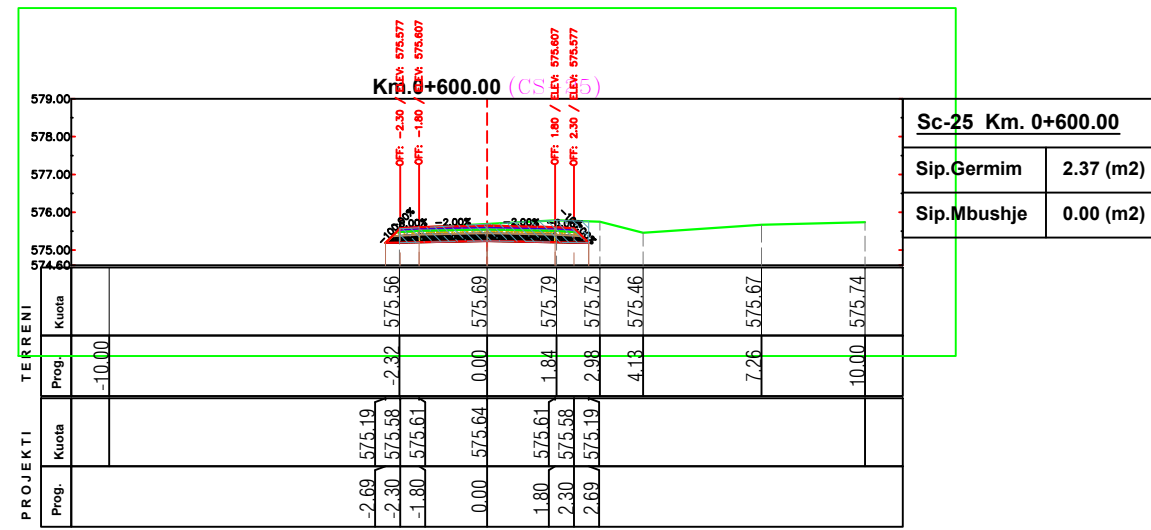

POROSITES : BASHKIA DIBER
 RIKONSTRUKSION DHE SISTEMIM ASFALTIM I RRUGES
 SE FSHATIT MAJTARE E POSHTME , NJ.A MAQELLARE

EMERTIMI : PROFILAT TERTHORE
 "ERALD-G" sh.p.k
 Rruga "Kongresi i Lushnjes"
 Tirane

DREJTUES PROJEKTI
 Ing.Gezim ISLAMI

PROJEKTUES
 Ing.Erindi GJOKA
 Hidr.Anisa ZAKA
 Top.Alfred NDRREGJONI
 Mek.Arben MUHA
 Top.Kujtim CANAMETI
 Ing.Eraldo ISLAMI

SHKALLA
 SHK - 1:200
 TIRANE 2022

FLETA
 4 - 07
 FORMAT A3

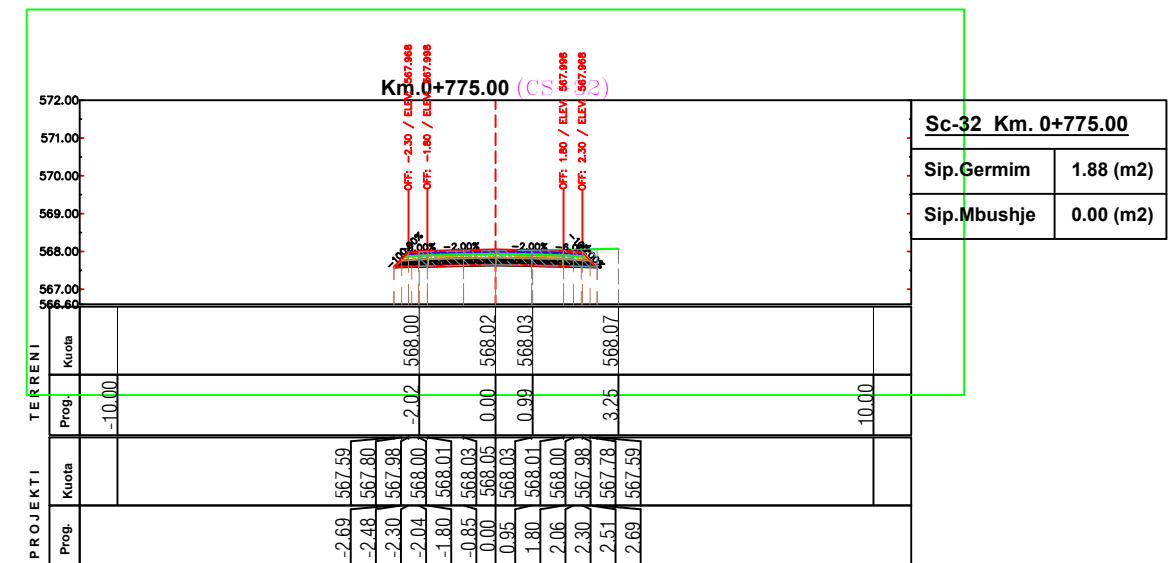
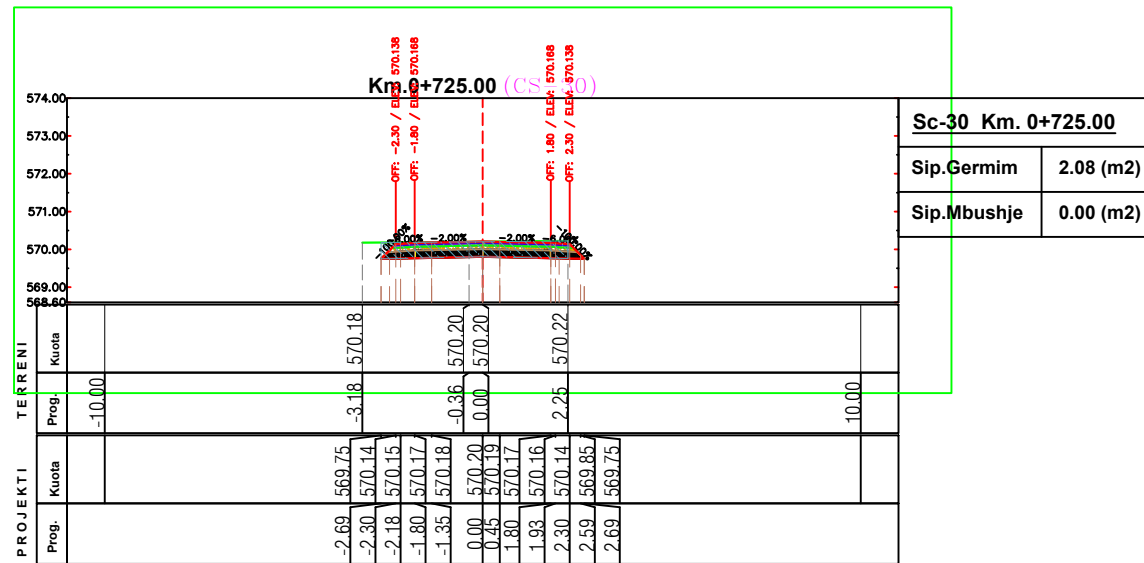
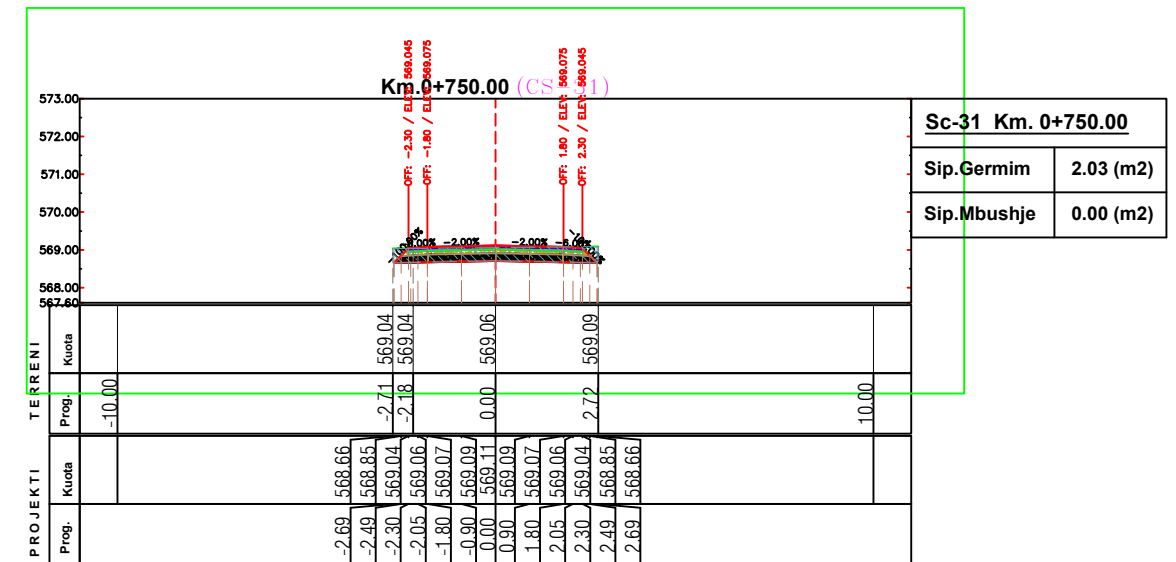
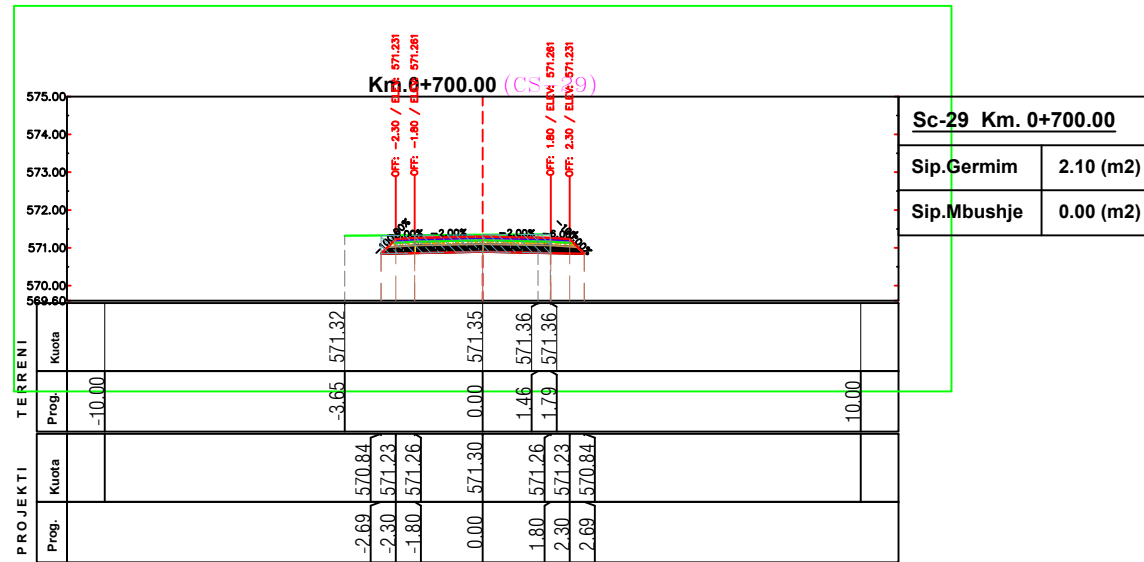

POROSITES : BASHKIA DIBER
 RIKONSTRUKSION DHE SISTEMIM ASFALTIM I RRUGES
 SE FSHATIT MAJTARE E POSHTME , NJ.A MAQELLARE

EMERTIMI : PROFILAT TERTHORE
 "ERALD-G" sh.p.k
 Rruga "Kongresi i Lushnjes"
 Tirane

DREJTUES PROJEKTI	PROJEKTUES	
Ing.Gezim ISLAMI	Ing.Erindi GJOKA	Hidr.Anisa ZAKA
	Top.Alfred NDRREGJONI	Mek.Arben MUHA
	Top.Kujtim CANAMETI	Ing.Eraldo ISLAMI

SHKALLA	FLETA
SHK - 1:200	4 - 08
TIRANE 2022	FORMAT A3

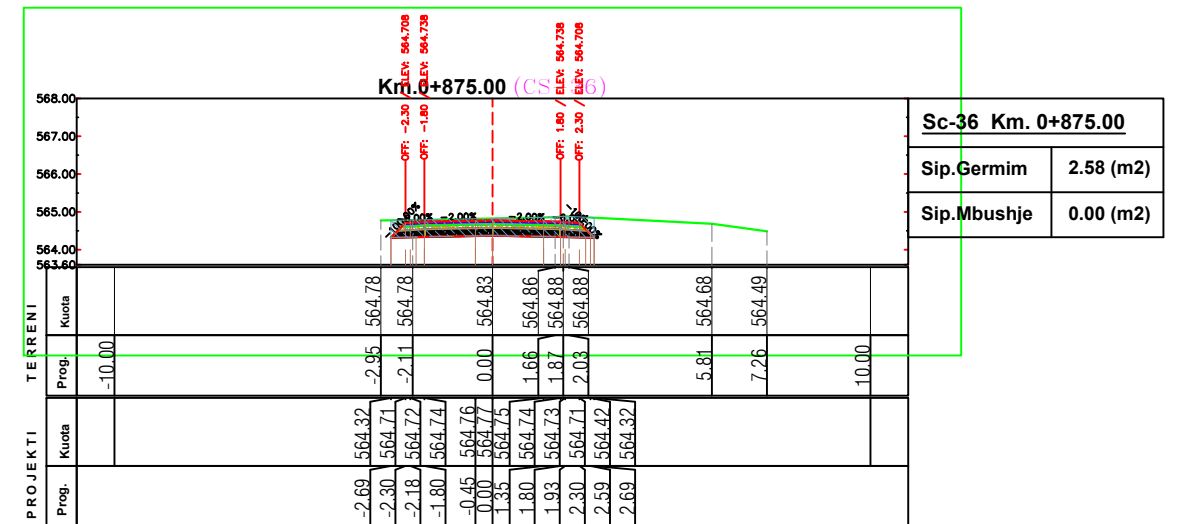
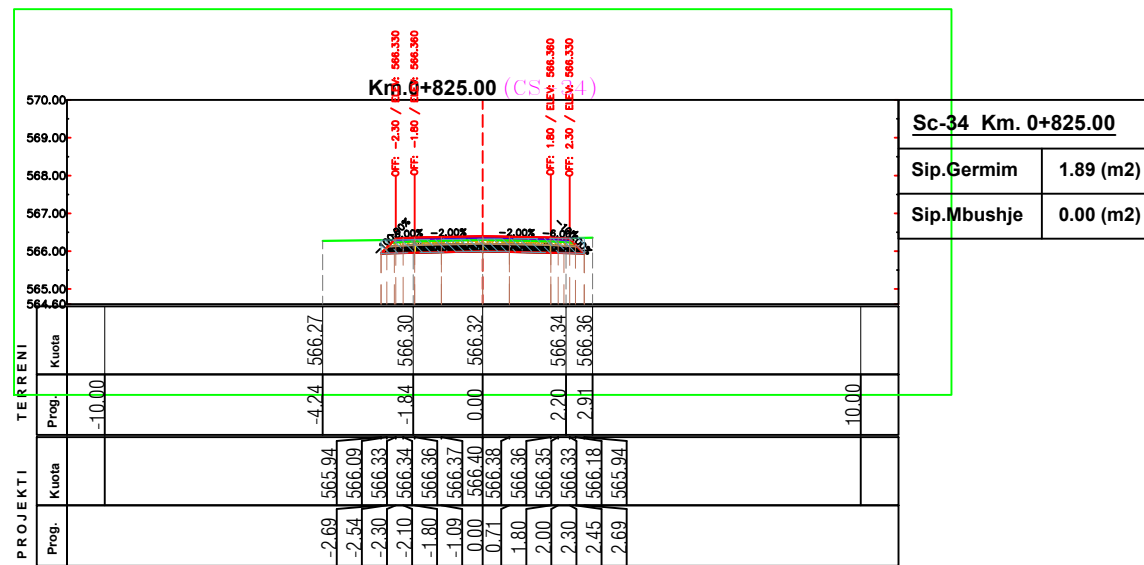
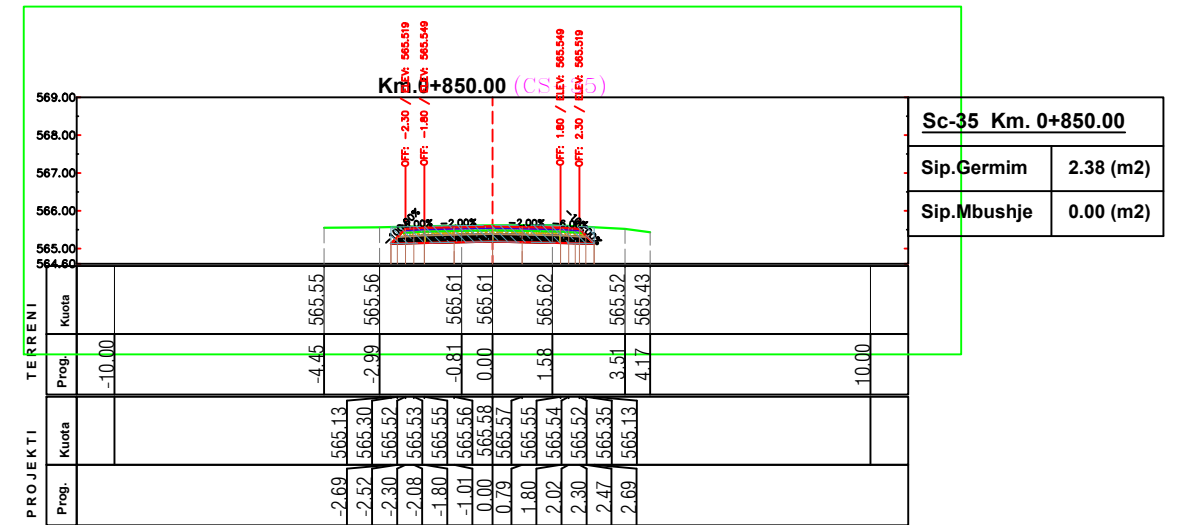
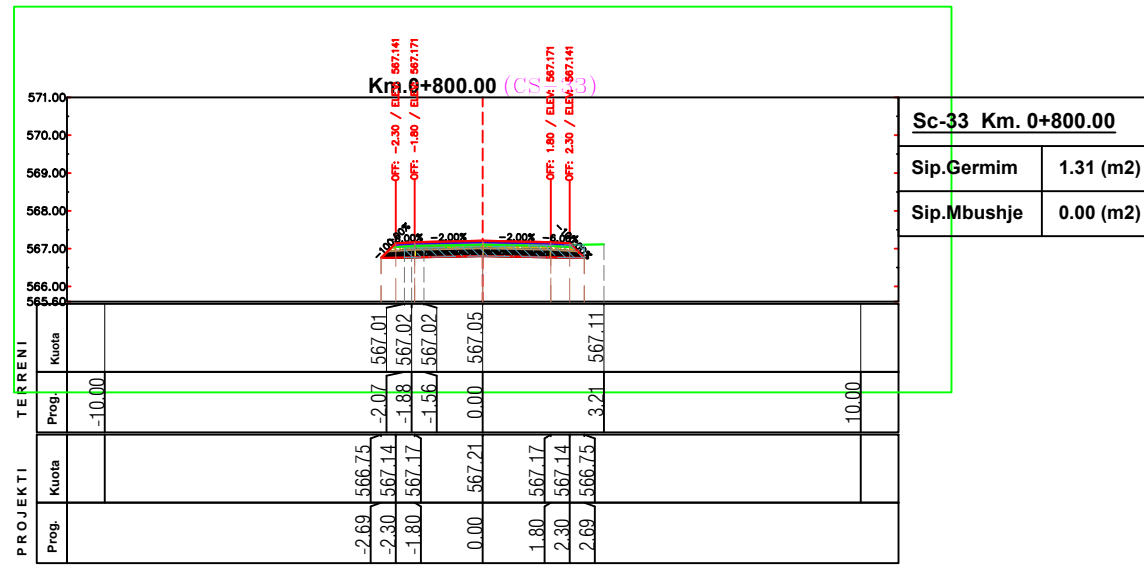

POROSITES : BASHKIA DIBER
 RIKONSTRUKSION DHE SISTEMIM ASFALTIM I RRUGES
 SE FSHATIT MAJTARE E POSHTME , NJ.A MAQELLARE

EMERTIMI : PROFILAT TERTHORE



DREJTUES PROJEKTI

Ing.Gezim ISLAMI

PROJEKTUES

Ing.Erindi GJOKA	Hidr.Anisa ZAKA
Top.Alfred NDRREGJONI	Mek.Arben MUHA
Top.Kujtim CANAMETI	Ing.Eraldo ISLAMI

SHKALLA

SHK - 1:200

TIRANE 2022

FLETA

4 - 09

FORMAT A3

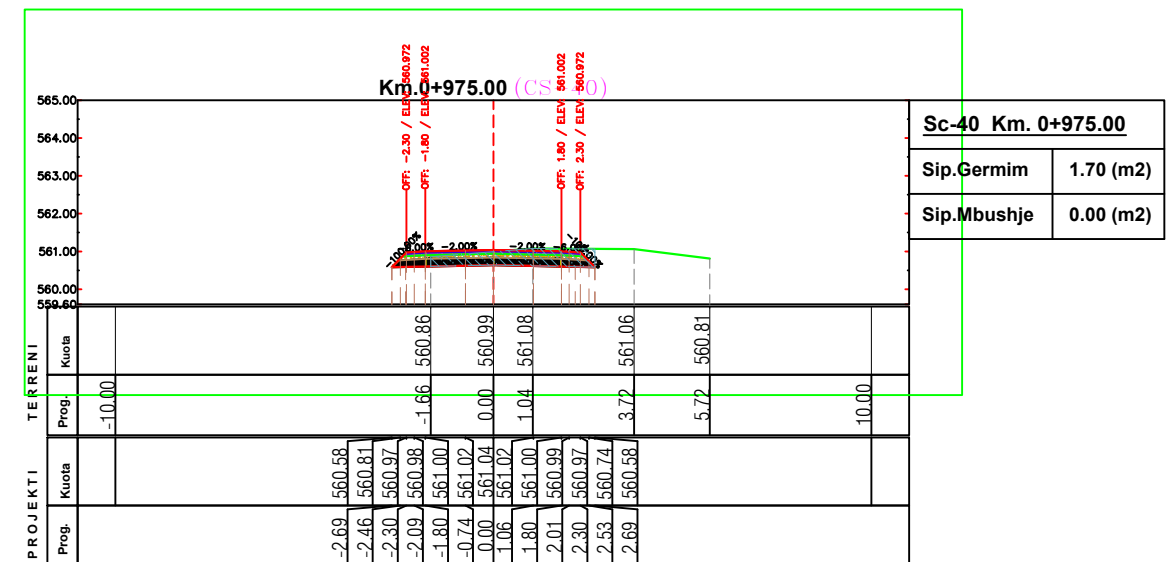
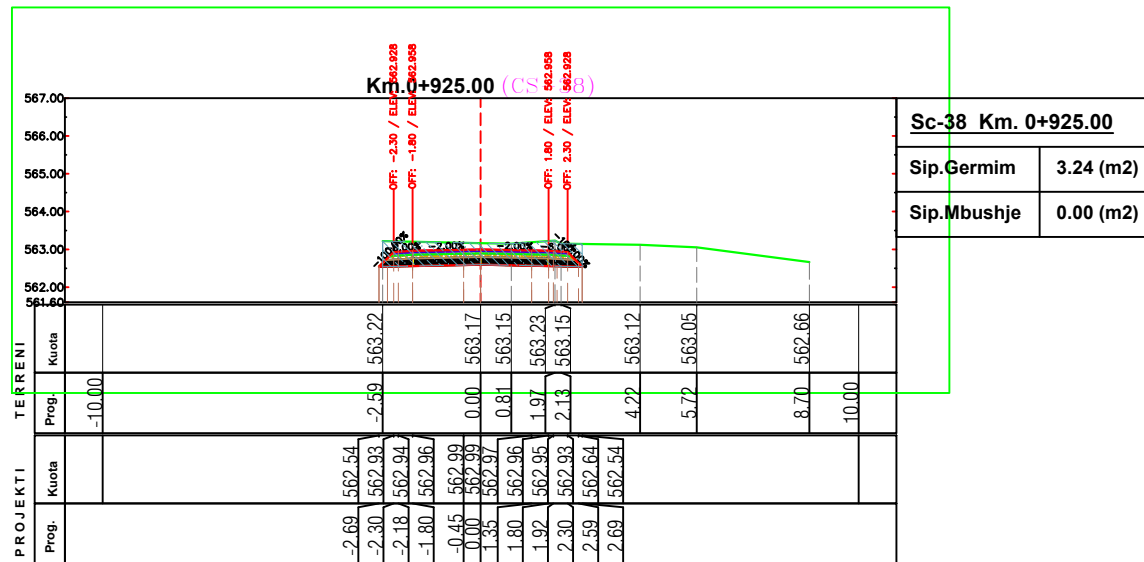
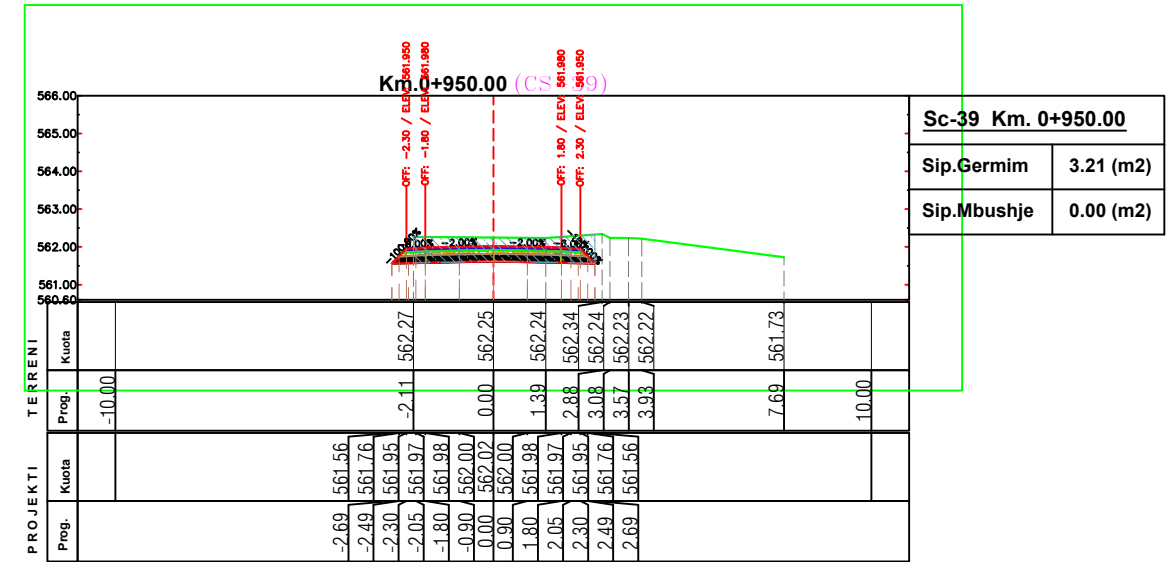
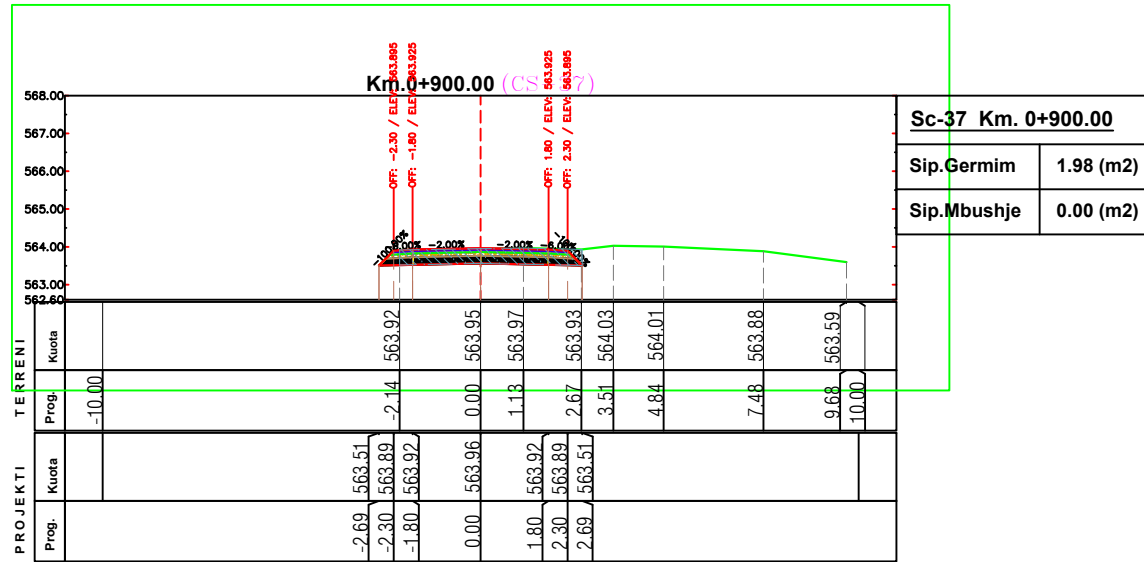

POROSITES : BASHKIA DIBER
 RIKONSTRUKSION DHE SISTEMIM ASFALTIM I RRUGES
 SE FSHATIT MAJTARE E POSHTME , NJ.A MAQELLARE

EMERTIMI : PROFILAT TERTHORE
 "ERALD-G" sh.p.k
 Rruga "Kongresi i Lushnjes"
 Tirane

DREJTUES PROJEKTI	PROJEKTUES		
Ing.Gezim ISLAMI	Ing.Erindi GJOKA	Hidr.Anisa ZAKA	
	Top.Alfred NDRREGJONI	Mek.Arben MUHA	
	Top.Kujtim CANAMETI	Ing.Eraldo ISLAMI	

SHKALLA	FLETA
SHK - 1:200	4 - 10
TIRANE 2022	FORMAT A3

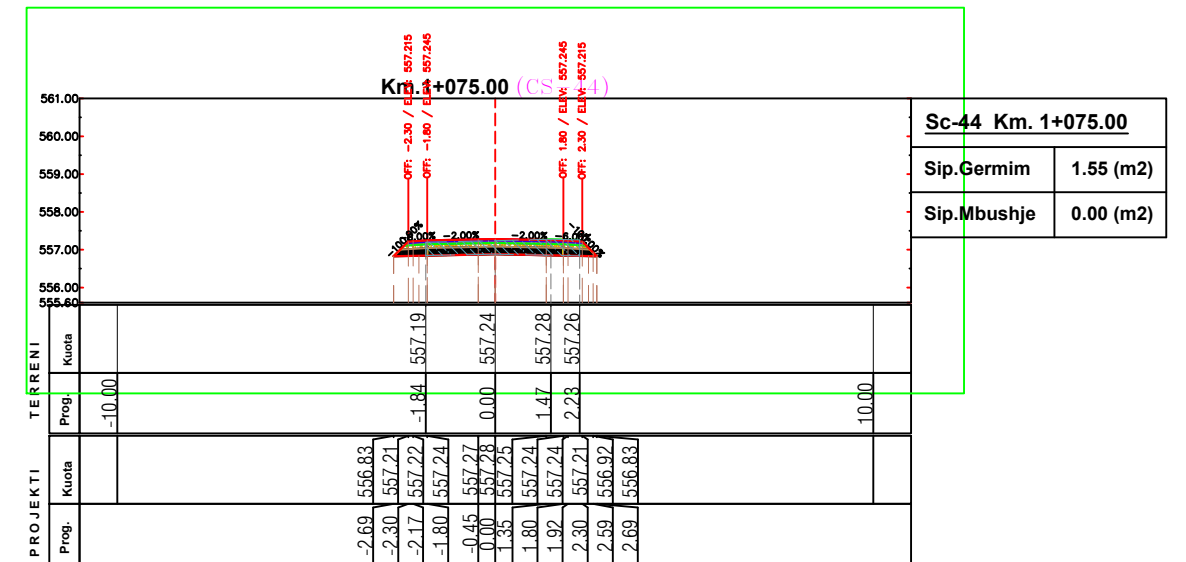
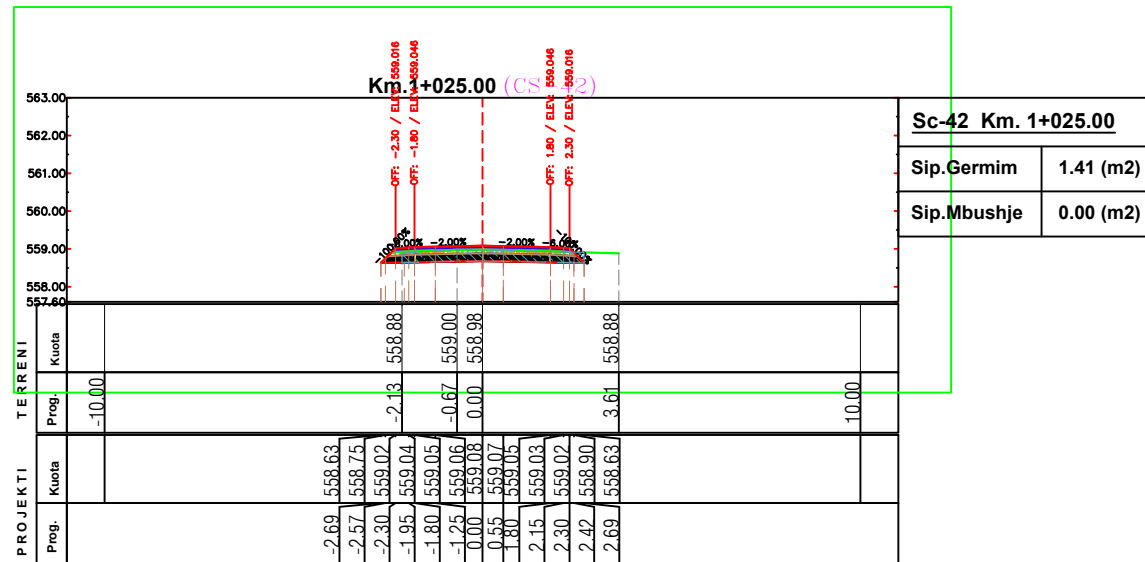
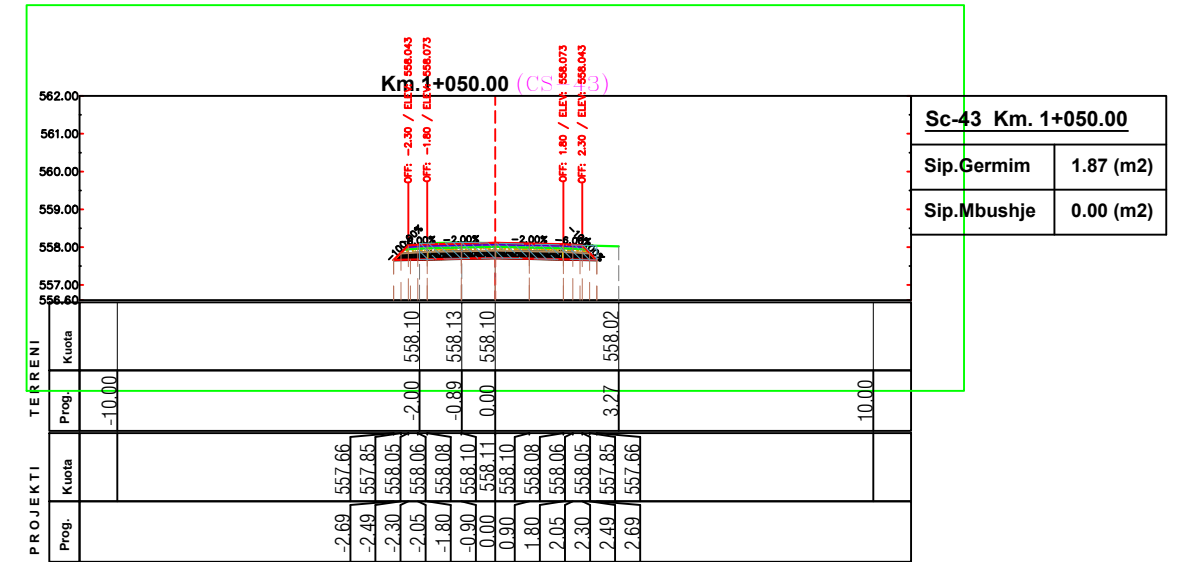
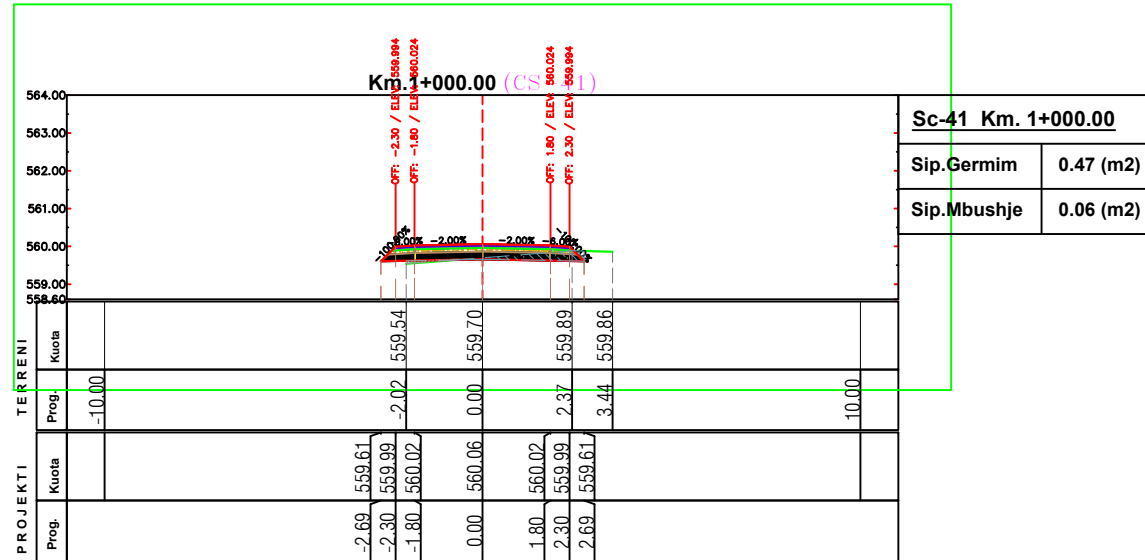

PROPOSITES : BASHKIA DIBER
 RIKONSTRUKSION DHE SISTEMIM ASFALTIM I RRUGES
 SE FSHATIT MAJTARE E POSHTME , NJ.A MAQELLARE

EMERTIMI : PROFILAT TERTHORE

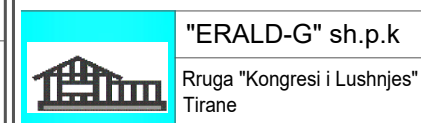

DREJTUES PROJEKTI
 Ing.Gezim ISLAMI

PROJEKTUES
 Ing.Erindi GJOKA
 Hidr.Anisa ZAKA
 Top.Alfred NDRREGJONI
 Mek.Arben MUHA
 Top.Kujtim CANAMETI
 Ing.Eraldo ISLAMI

SHKALLA
 SHK - 1:200
 TIRANE 2022

FLETA
 4 - 11
 FORMAT A3

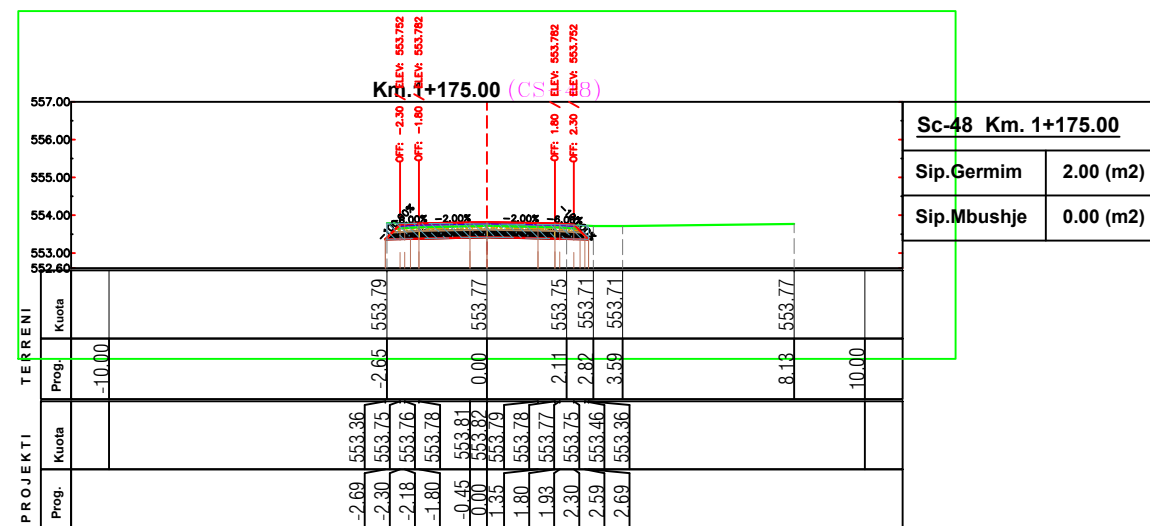
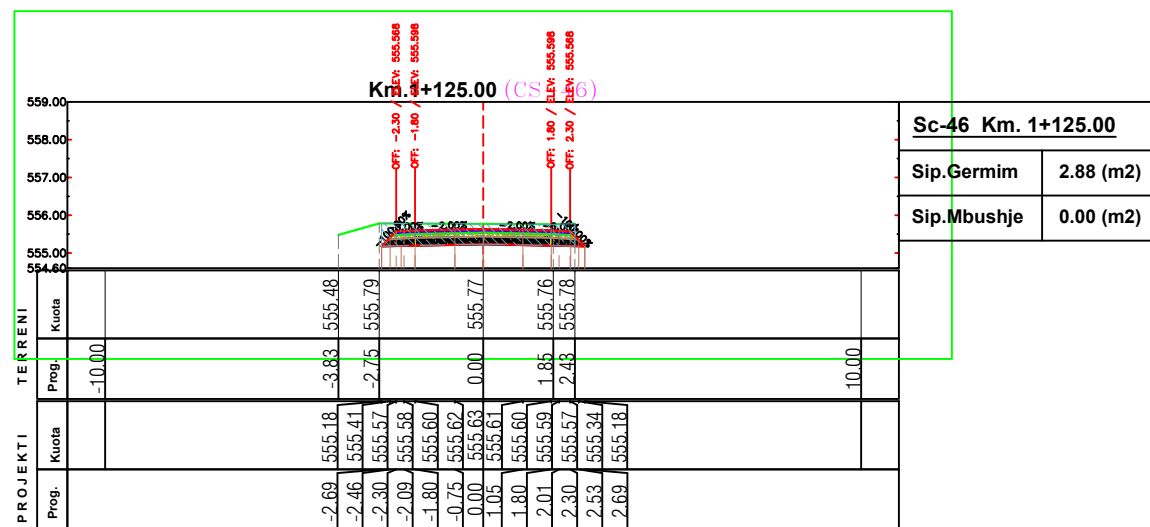
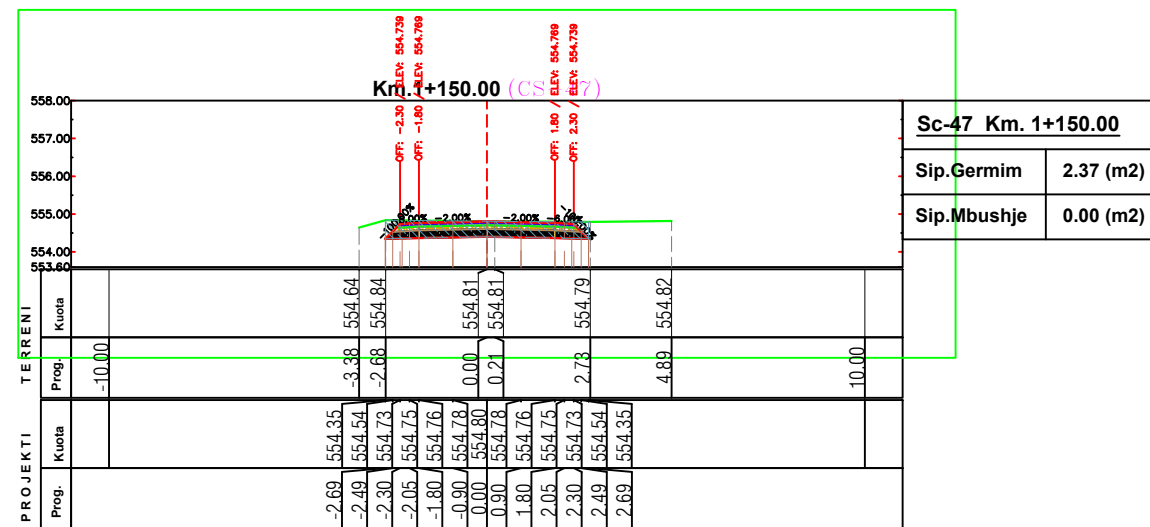
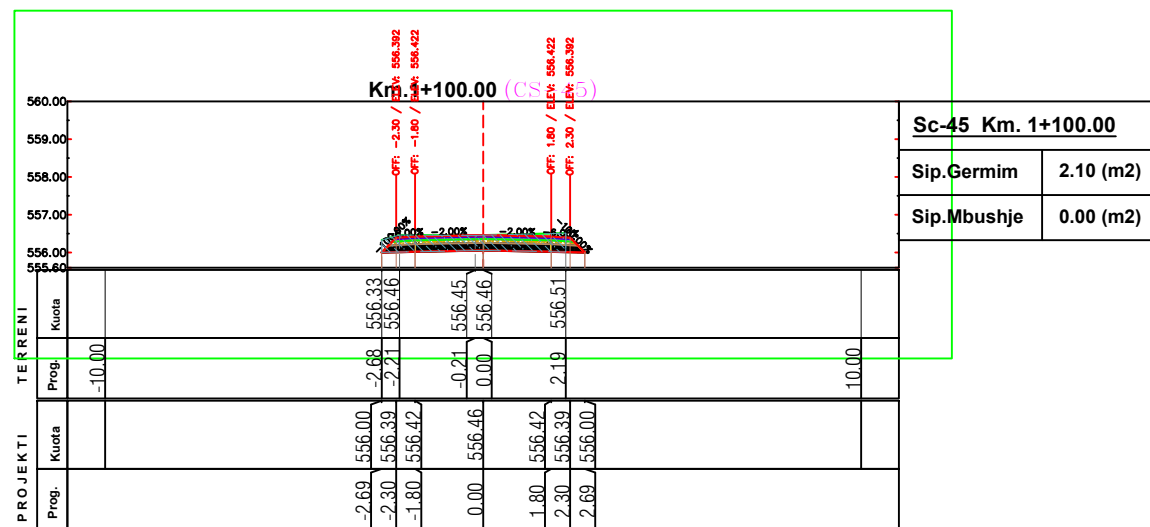

POROSITES : BASHKIA DIBER
 RIKONSTRUKSION DHE SISTEMIM ASFALTIM I RRUGES
 SE FSHATIT MAJTARE E POSHTME , NJ.A MAQELLARE

EMERTIMI : PROFILAT TERTHORE

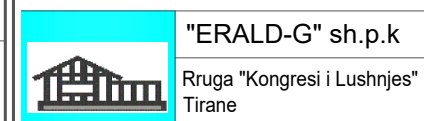

DREJTUES PROJEKTI

Ing.Gezim ISLAMI

PROJEKTUES

Ing.Erindi GJOKA	Hidr.Anisa ZAKA
Top.Alfred NDREGJONI	Mek.Arben MUHA
Top.Kujtim CANAMETI	Ing.Eraldo ISLAMI

SHKALLA

SHK - 1:200

TIRANE 2022

FLETA

4 - 12

FORMAT A3

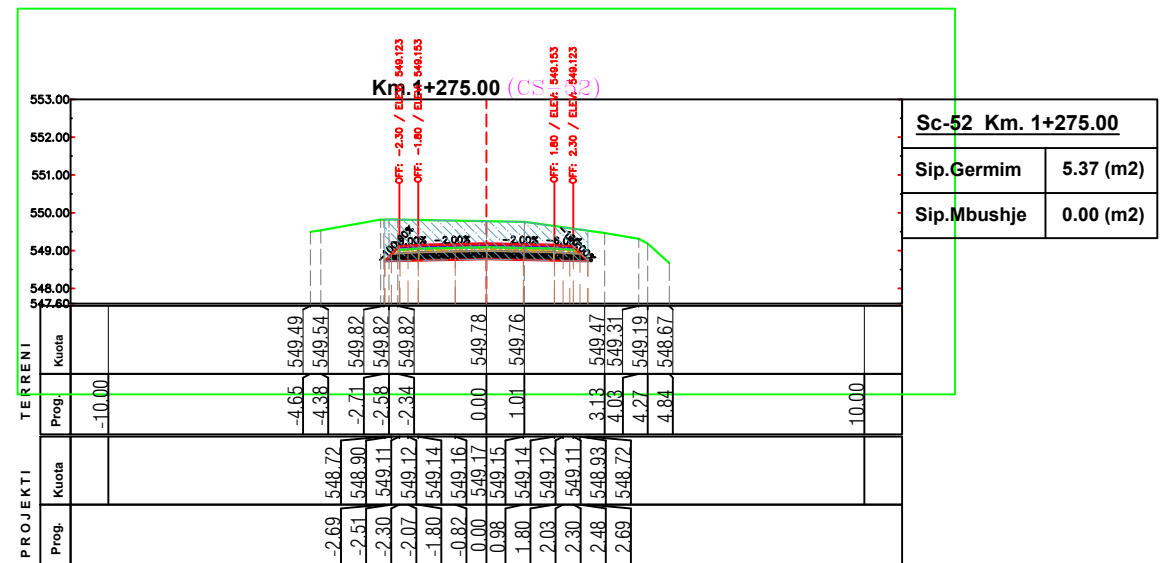
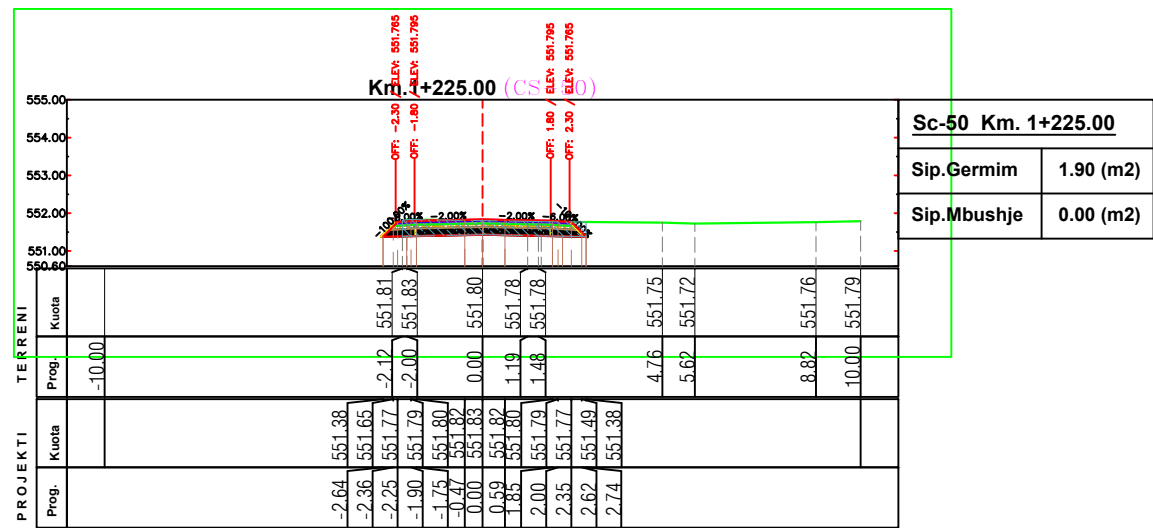
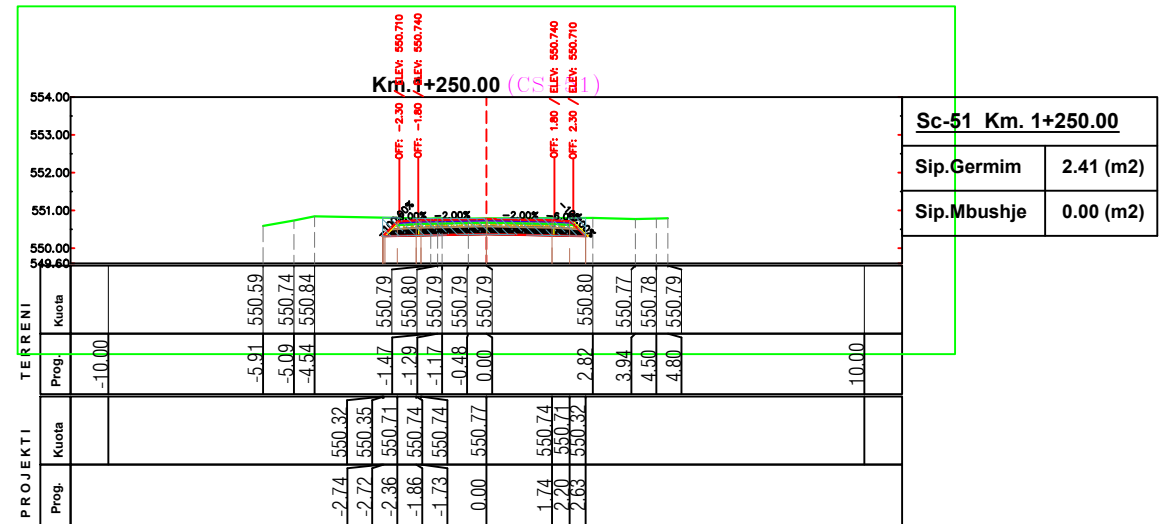
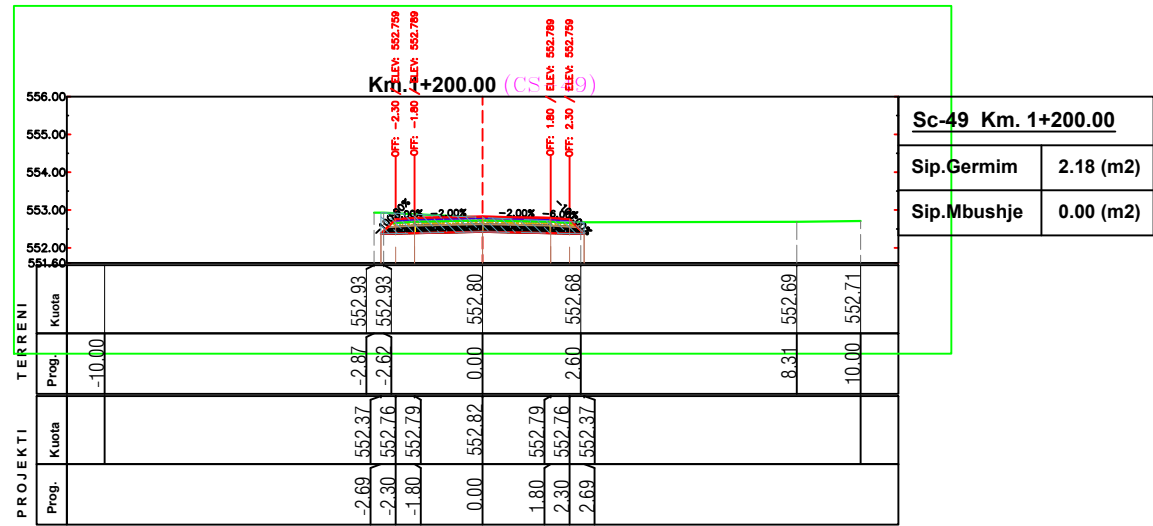

POROSITES : BASHKIA DIBER
 RIKONSTRUKSION DHE SISTEMIM ASFALTIM I RRUGES
 SE FSHATIT MAJTARE E POSHTME , NJ.A MAQELLARE

EMERTIMI : PROFILAT TERTHORE

 "ERALD-G" sh.p.k
 Rruga "Kongresi i Lushnjes"
 Tirane

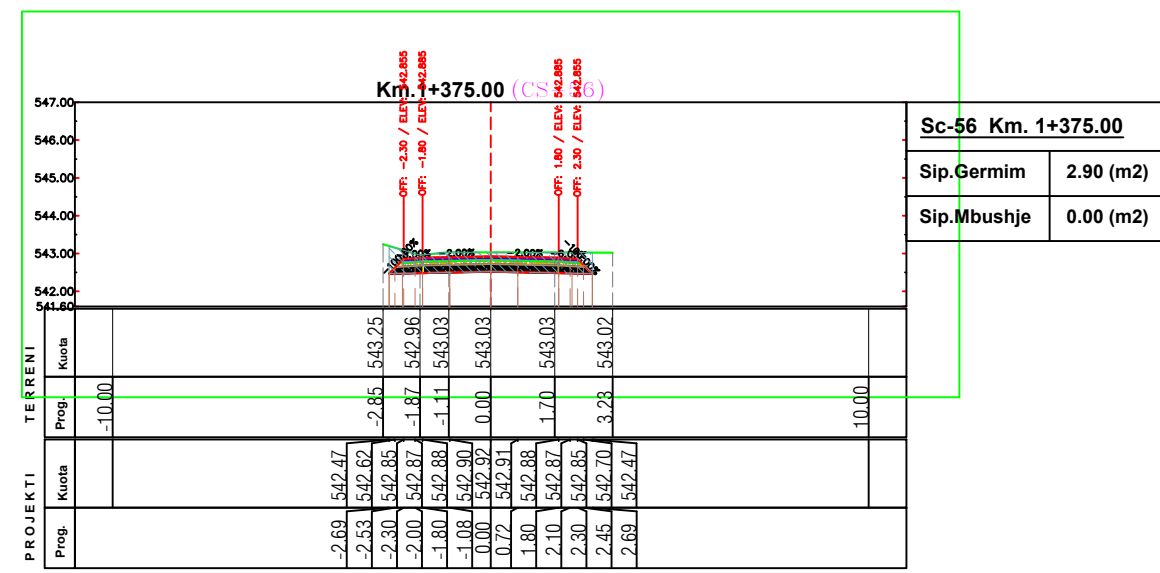
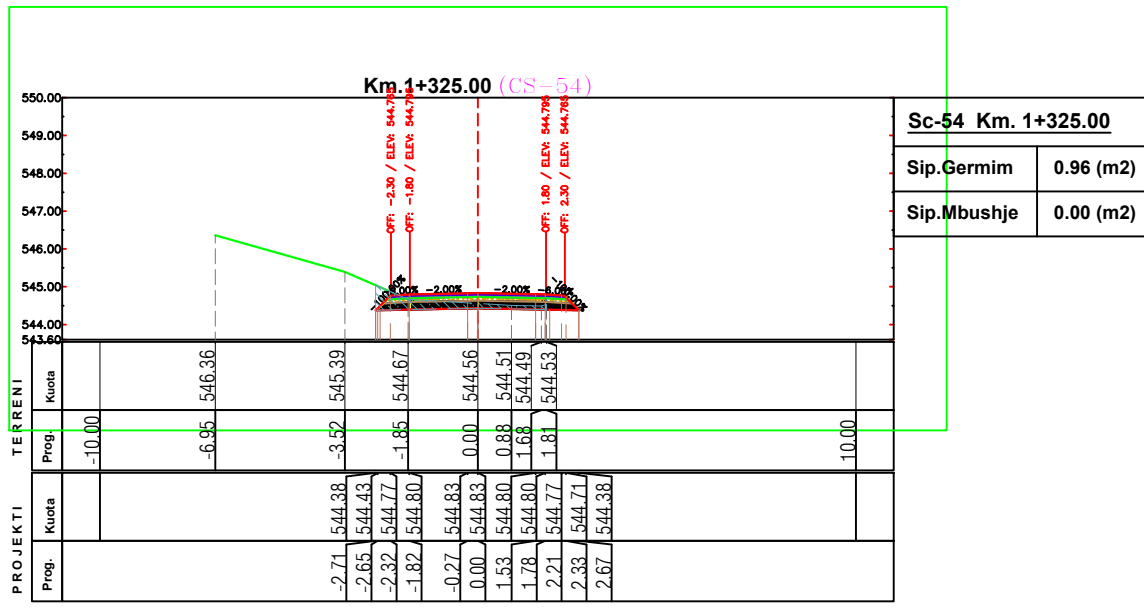
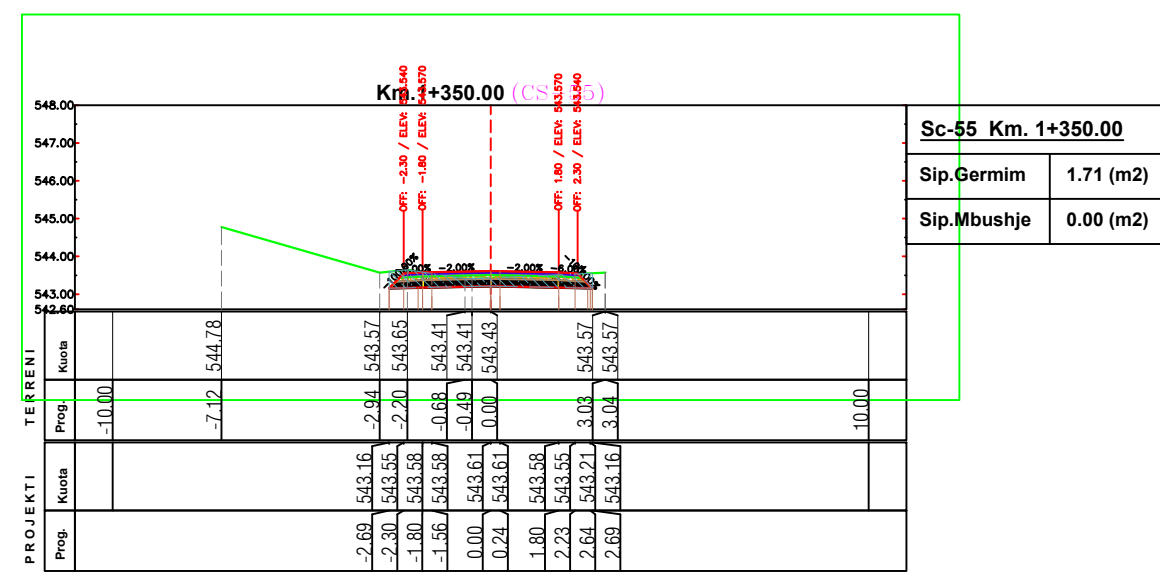
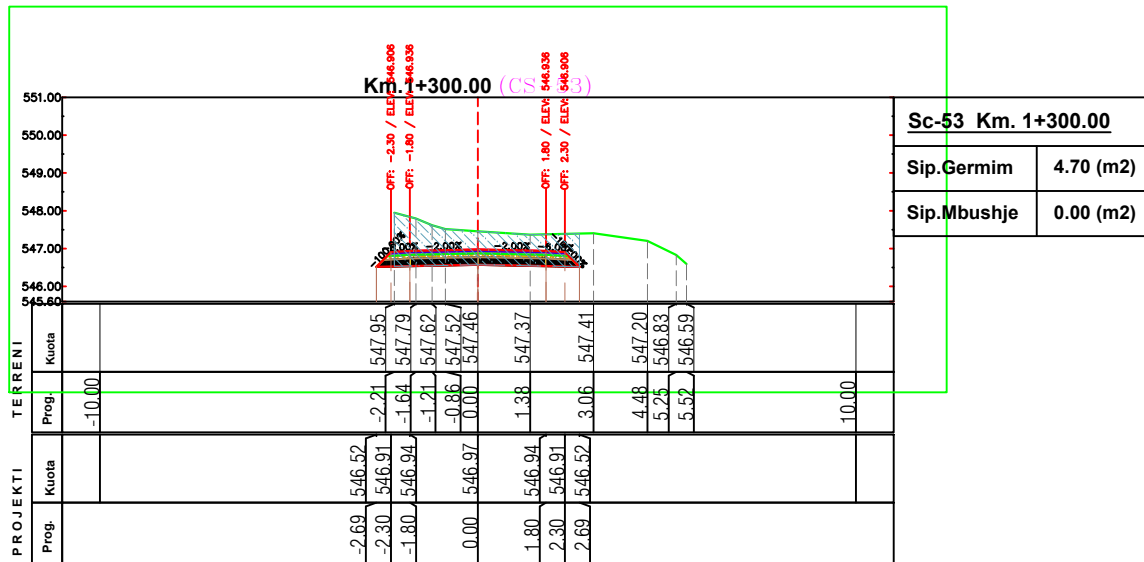
DREJTUES PROJEKTI	PROJEKTUES		SHKALLA	FLETA
Ing.Gezim ISLAMI	Ing.Erindi GJOKA	Hidr.Anisa ZAKA	SHK - 1:200	4 - 13
	Top.Alfred NDRREGJONI	Mek.Arben MUHA		
	Top.Kujtim CANAMETI	Ing.Eraldo ISLAMI		
			TIRANE 2022	FORMAT A3



POROSITES : BASHKIA DIBER
 RIKONSTRUKSION DHE SISTEMIM ASFALTIM I RRUGES
 SE FSHATIT MAJTARE E POSHTME , NJ.A MAQELLARE

EMERTIMI : PROFILAT TERTHORE
 "ERALD-G" sh.p.k
 Rruga "Kongresi i Lushnjes"
 Tirane

DREJTUES PROJEKTI	PROJEKTUES	
Ing.Gezim ISLAMI	Ing.Erindi GJOKA	Hidr.Anisa ZAKA
	Top.Alfred NDRREGJONI	Mek.Arben MUHA
	Top.Kujtim CANAMETI	Ing.Eraldo ISLAMI

SHKALLA	FLETA
SHK - 1:200	4 - 14
TIRANE 2022	FORMAT A3

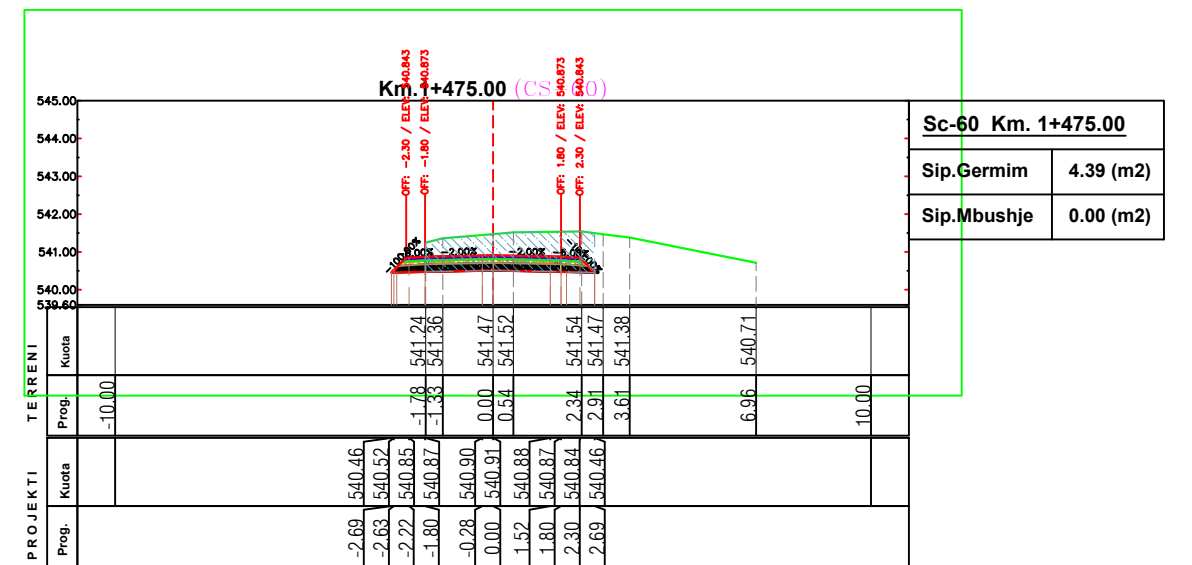
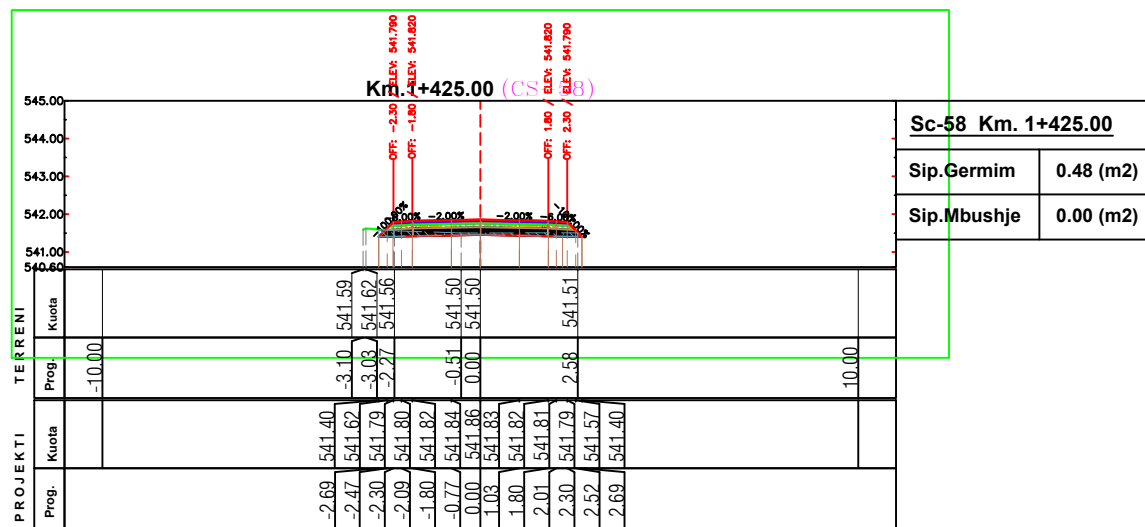
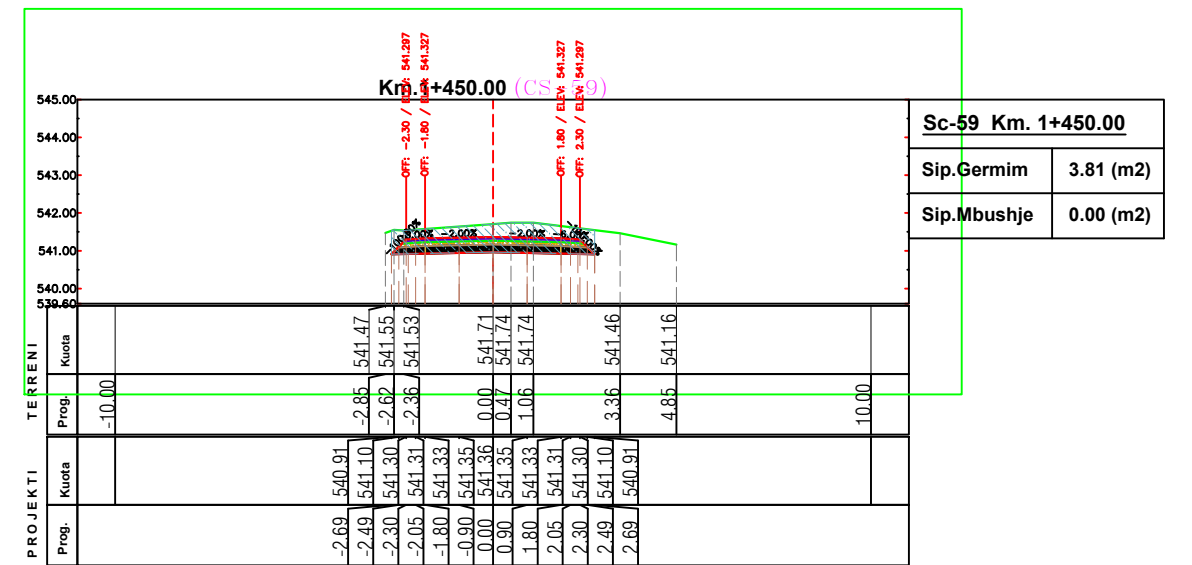
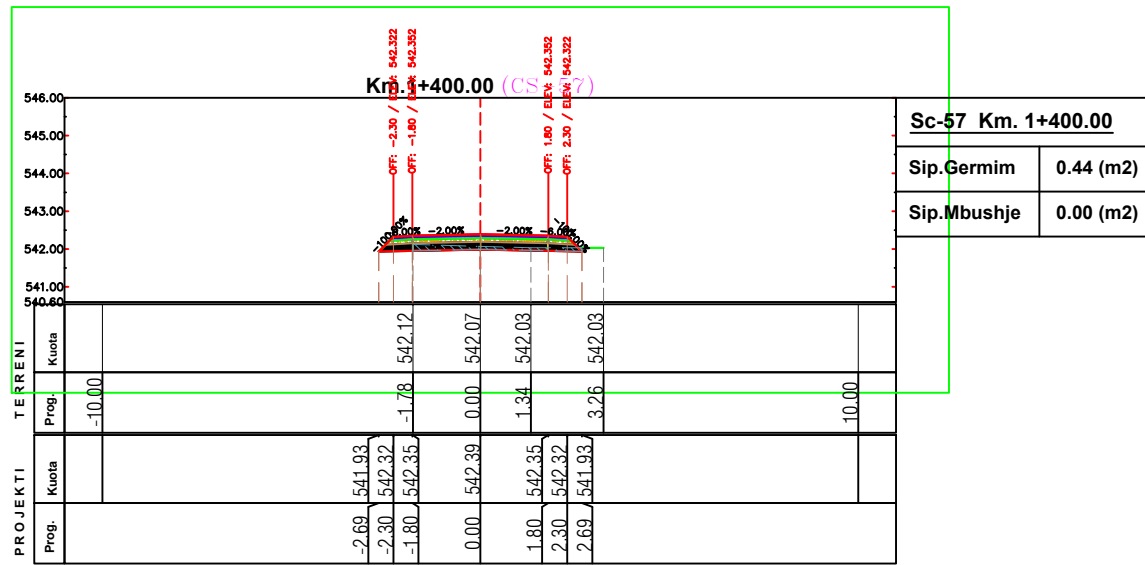

POROSITES : BASHKIA DIBER
 RIKONSTRUKSION DHE SISTEMIM ASFALTIM I RRUGES
 SE FSHATIT MAJTARE E POSHTME , NJ.A MAQELLARE

EMERTIMI : PROFILAT TERTHORE



"ERALD-G" sh.p.k
 Rruga "Kongresi i Lushnjes"
 Tirane

DREJTUES PROJEKTI
 Ing.Gezim ISLAMI

PROJEKTUES
 Ing.Erindi GJOKA
 Hidr.Anisa ZAKA
 Top.Alfred NDRREGJONI
 Mek.Arben MUHA
 Top.Kujtim CANAMETI
 Ing.Eraldo ISLAMI

SHKALLA
 SHK - 1:200
 TIRANE 2022

FLETA
 4 - 15
 FORMAT A3

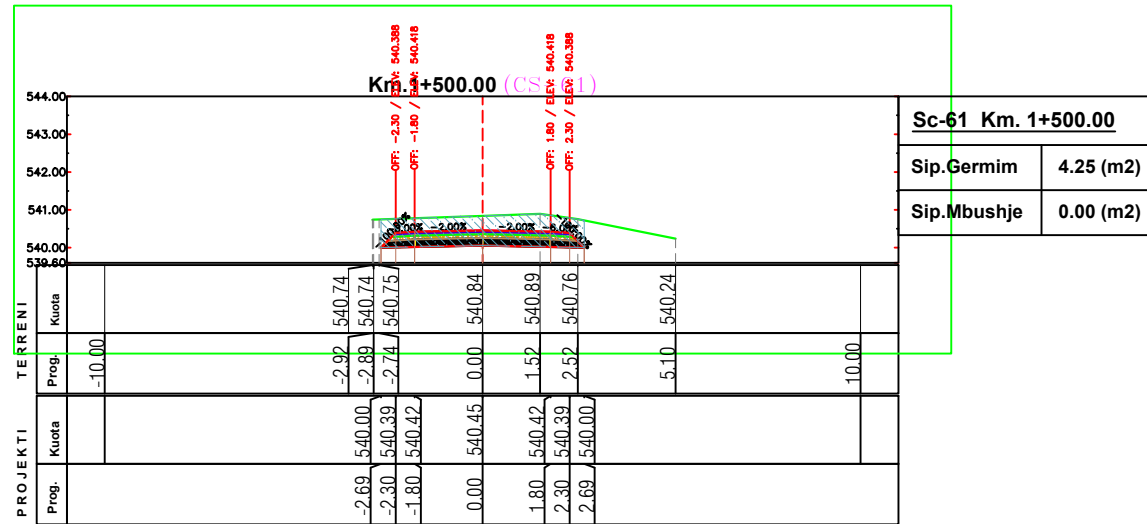

Sc-61 Km. 1+500.00	
Sip.Germim	4.25 (m2)
Sip.Mbushje	0.00 (m2)

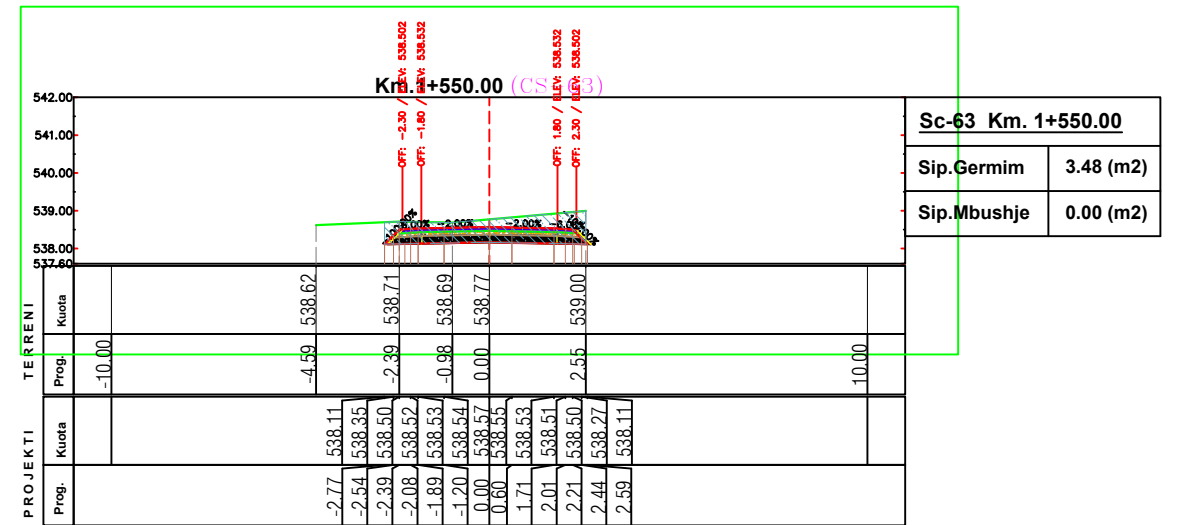

Sc-63 Km. 1+550.00	
Sip.Germim	3.48 (m2)
Sip.Mbushje	0.00 (m2)

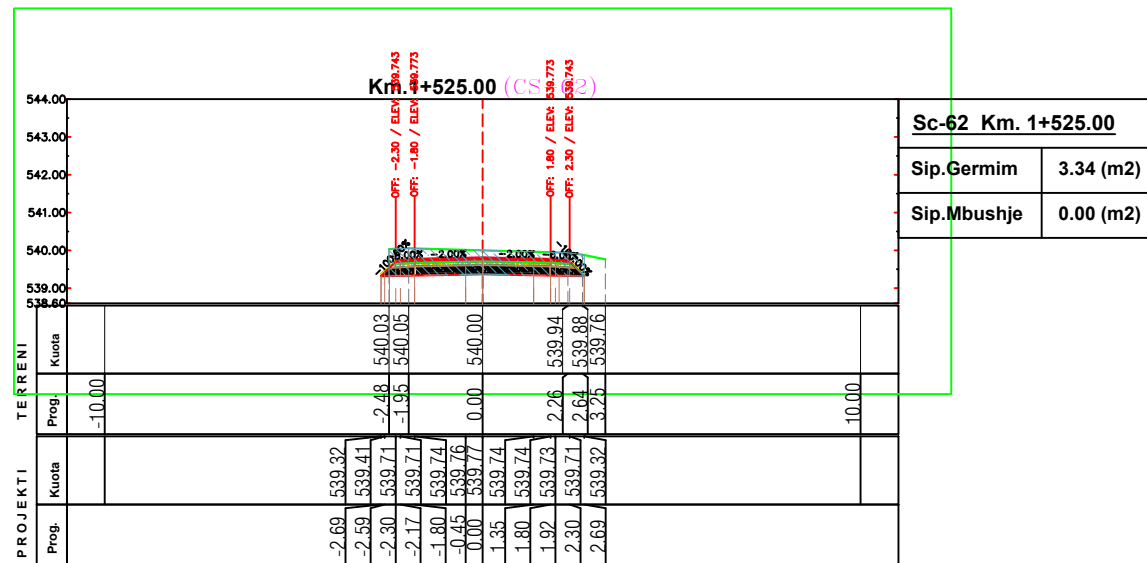

Sc-62 Km. 1+525.00	
Sip.Germim	3.34 (m2)
Sip.Mbushje	0.00 (m2)

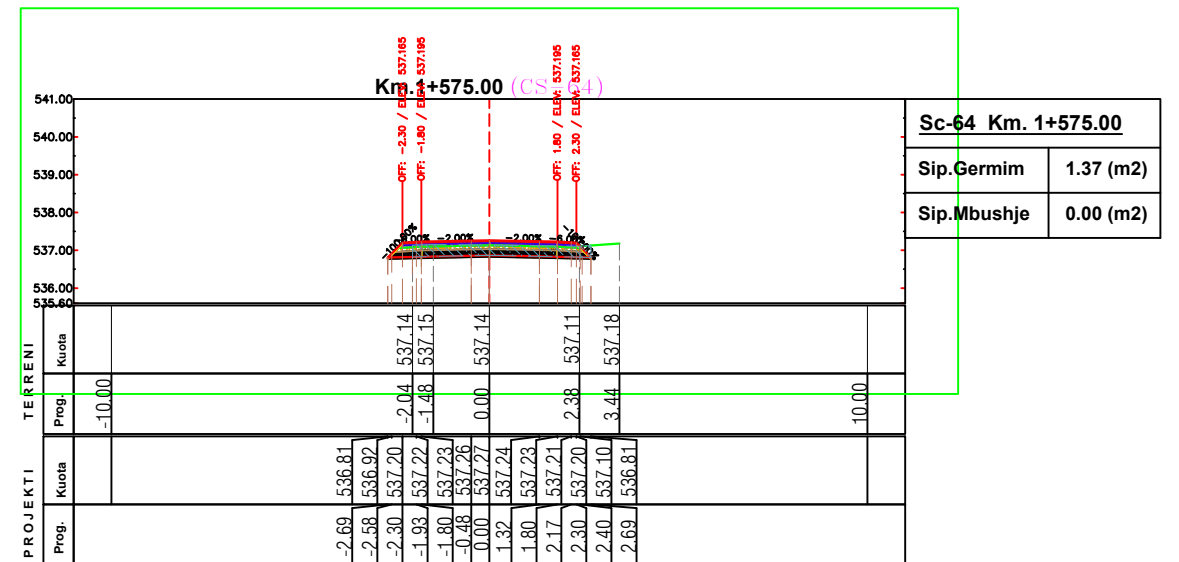

Sc-64 Km. 1+575.00	
Sip.Germim	1.37 (m2)
Sip.Mbushje	0.00 (m2)

POROSITES : BASHKIA DIBER
 RIKONSTRUKSION DHE SISTEMIM ASFALTIM I RRUGES
 SE FSHATIT MAJTARE E POSHTME , NJ.A MAQELLARE

EMERTIMI : PROFILAT TERTHORE

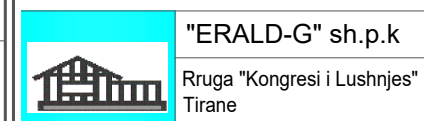

DREJTUES PROJEKTI
 Ing.Gezim ISLAMI

PROJEKTUES
 Ing.Erindi GJOKA
 Hidr.Anisa ZAKA
 Top.Alfred NDRREGJONI
 Mek.Arben MUHA
 Top.Kujtim CANAMETI
 Ing.Eraldo ISLAMI

SHKALLA
 SHK - 1:200
 TIRANE 2022

FLETA
 4 - 16
 FORMAT A3

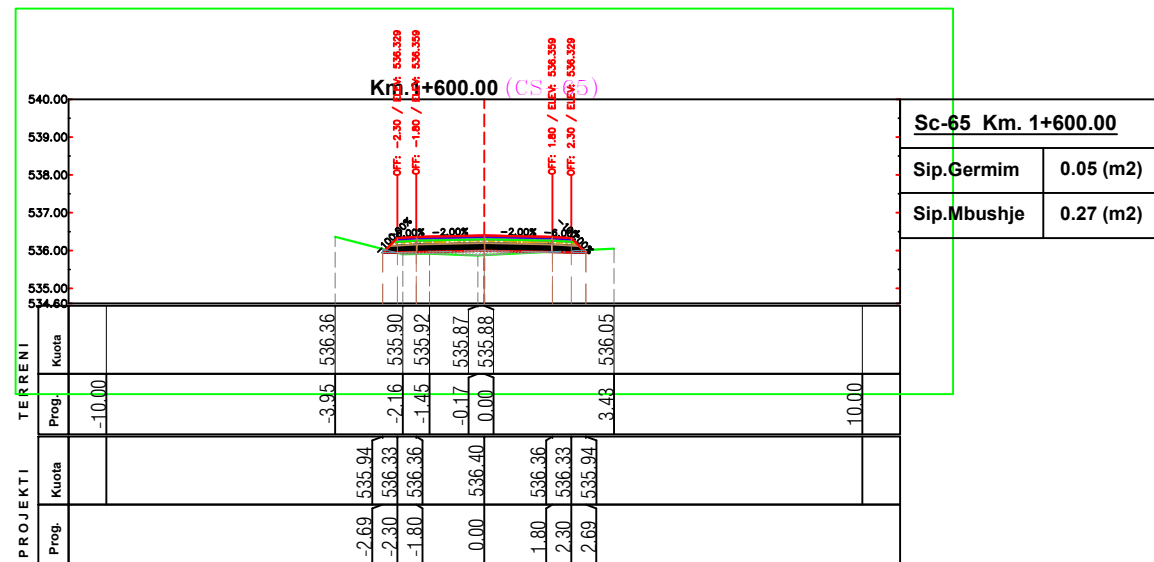

Sc-65 Km. 1+600.00	
Sip.Germim	0.05 (m2)
Sip.Mbushje	0.27 (m2)

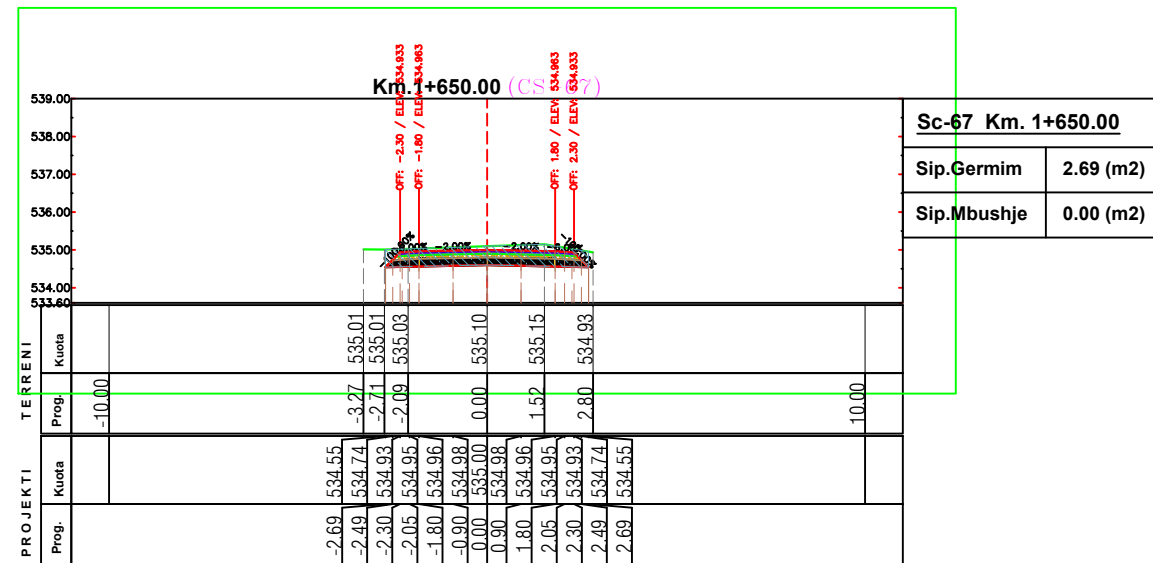

Sc-67 Km. 1+650.00	
Sip.Germim	2.69 (m2)
Sip.Mbushje	0.00 (m2)

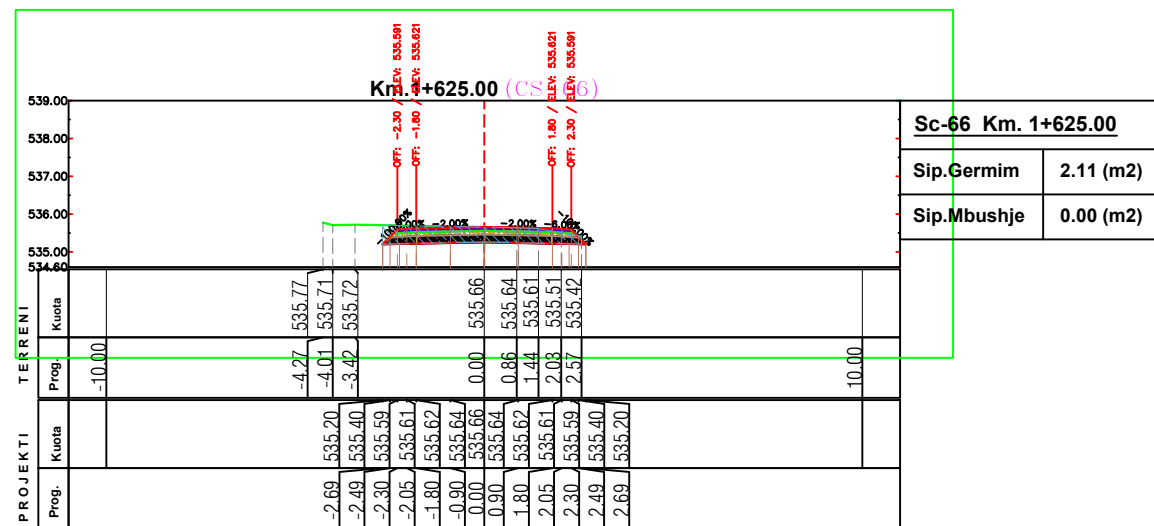

Sc-66 Km. 1+625.00	
Sip.Germim	2.11 (m2)
Sip.Mbushje	0.00 (m2)

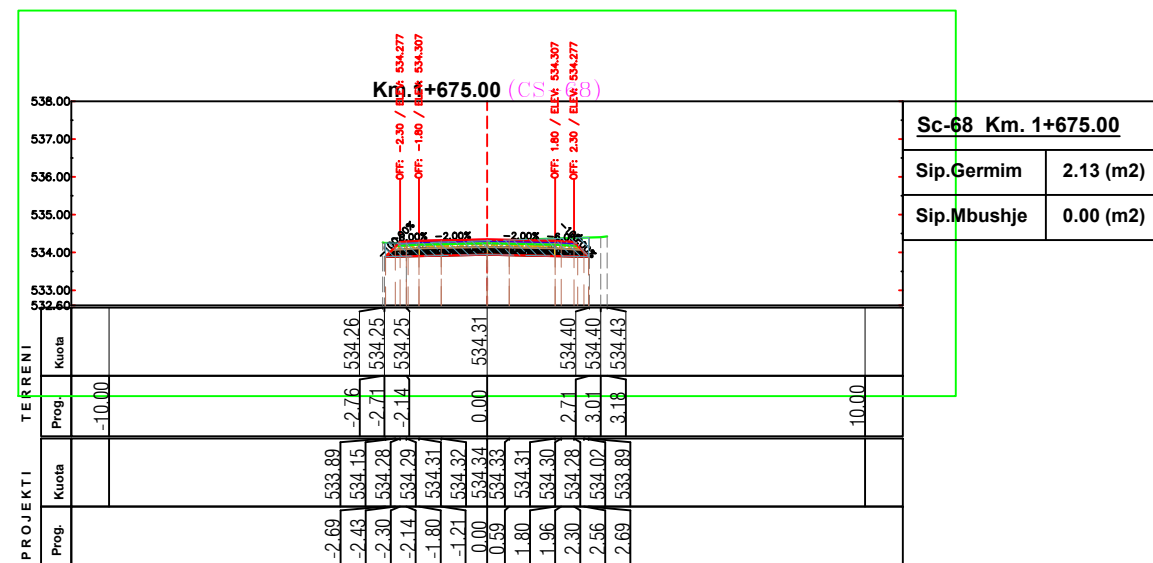

Sc-68 Km. 1+675.00	
Sip.Germim	2.13 (m2)
Sip.Mbushje	0.00 (m2)

PROPOSITES : BASHKIA DIBER
 RIKONSTRUKSION DHE SISTEMIM ASFALTIM I RRUGES
 SE FSHATIT MAJTARE E POSHTME , NJ.A MAQELLARE

EMERTIMI : PROFILAT TERTHORE

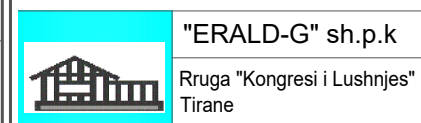

DREJTUES PROJEKTI
 Ing.Gezim ISLAMI

PROJEKTUES
 Ing.Erindi GJOKA
 Hidr.Anisa ZAKA
 Top.Alfred NDRREGJONI
 Mek.Arben MUHA
 Top.Kujtim CANAMETI
 Ing.Eraldo ISLAMI

SHKALLA
 SHK - 1:200
 TIRANE 2022

FLETA
 4 - 17
 FORMAT A3

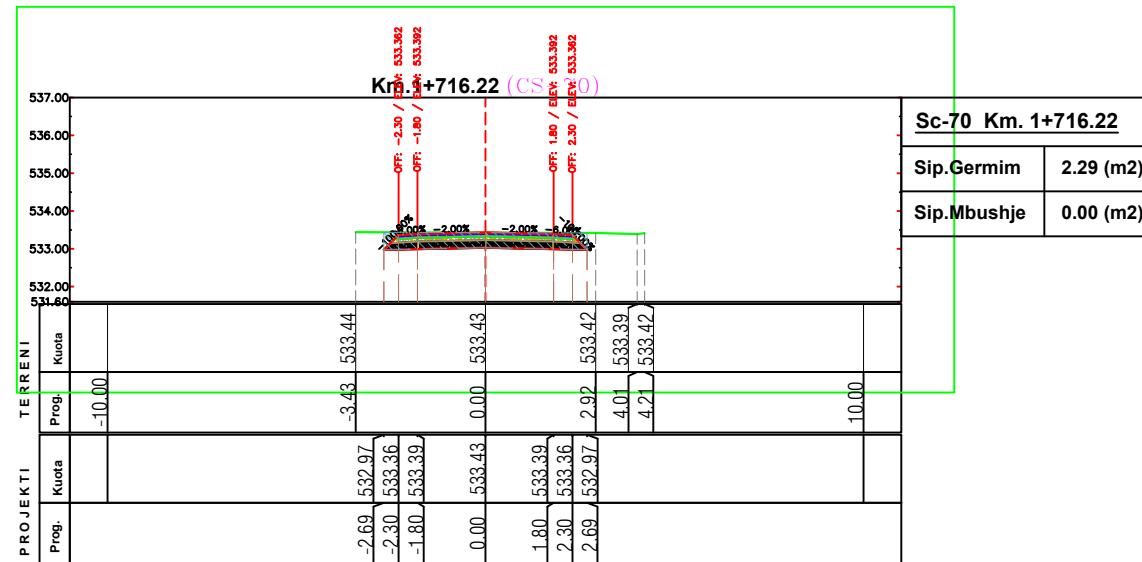
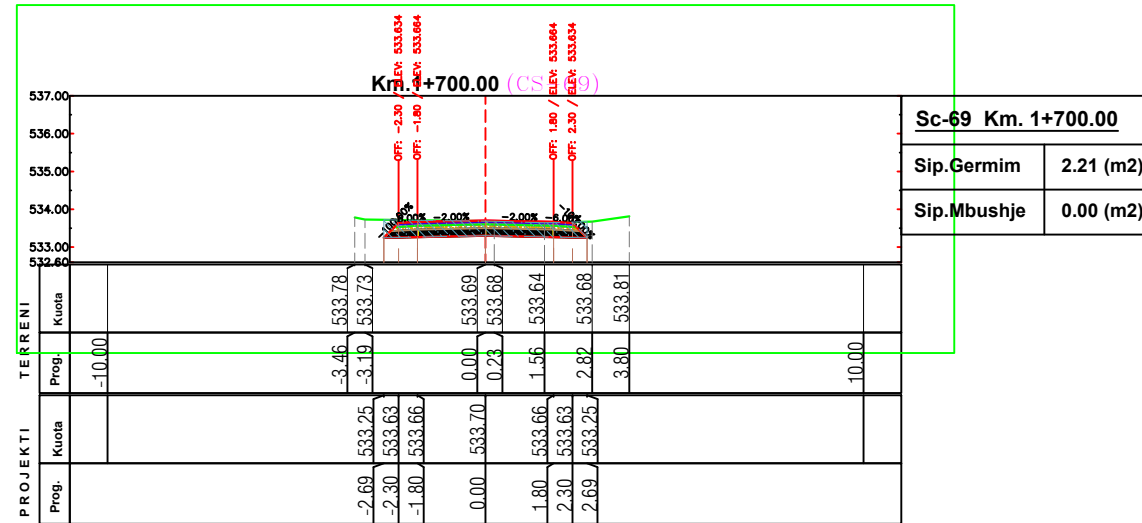

POROSITES : BASHKIA DIBER
 RIKONSTRUKSION DHE SISTEMIM ASFALTIM I RRUGES
 SE FSHATIT MAJTARE E POSHTME , NJ.A MAQELLARE

EMERTIMI : PROFILAT TERTHORE
 "ERALD-G" sh.p.k
 Rruga "Kongresi i Lushnjes"
 Tirane

DREJTUES PROJEKTI
 Ing.Gezim ISLAMI

PROJEKTUES
 Ing.Erindi GJOKA
 Hidr.Anisa ZAKA
 Top.Alfred NDREGJONI
 Mek.Arben MUHA
 Top.Kujtim CANAMETI
 Ing.Eraldo ISLAMI

SHKALLA	FLETA
SHK - 1:200	4 - 18
TIRANE 2022	FORMAT A3

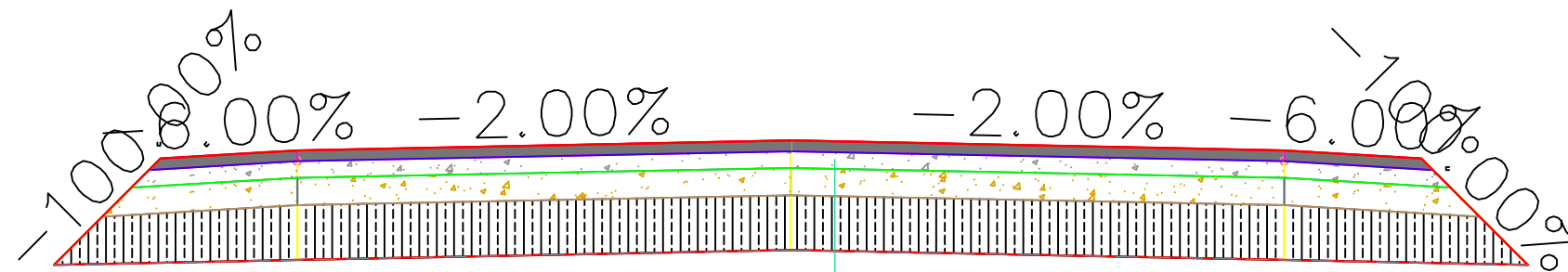
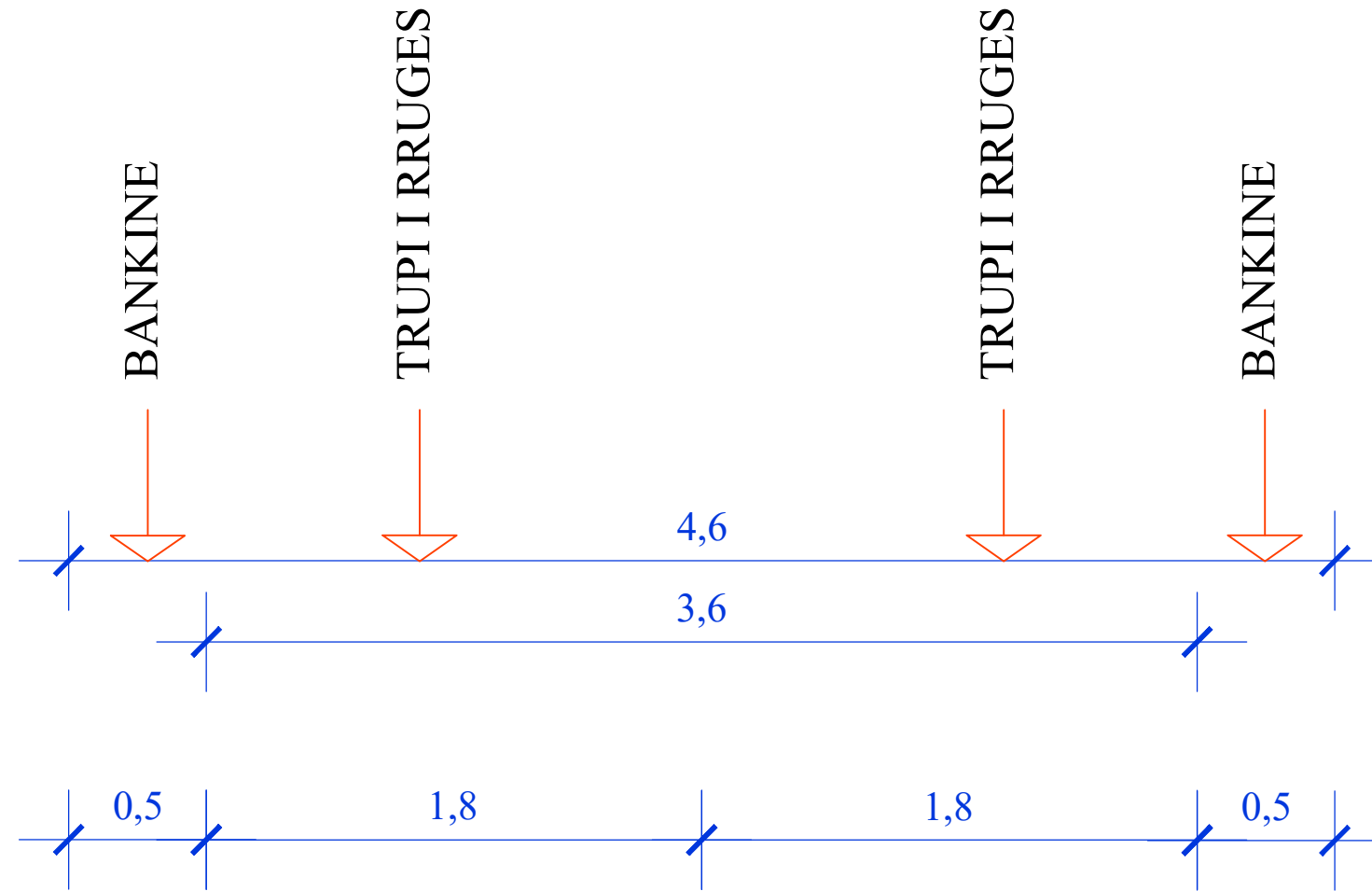

Asfaltobeton	3 cm
Binder	5 cm
Stabilizant	1x10 cm
Shtrese Cakelli	1x20 cm

POROSITES : BASHKIA DIBER

RIKONSTRUKSION DHE SISTEMIM ASFALTIM I RRUGES SE FSHATIT MAJTARE E POSHTME , NJ.A MAQELLARE

EMERTIMI : PROFIL TERTHOR TIP



"ERALD-G" sh.p.k
Rruga "Kongresi i Lushnjes"
Tirane

DREJTUES PROJEKTI

Ing.Gezim ISLAMI

PROJEKTUES

Ing.Erindi GJOKA

Top.Alfred NDRREGJONI

Top.Kujtim CANAMETI

Hidr.Anisa ZAKA

Mek.Arben MUHA

Ing.Eraldo ISLAMI

SHKALLA

1 : 25

TIRANE 2022

FLETA

5 : 01

FORMAT A3

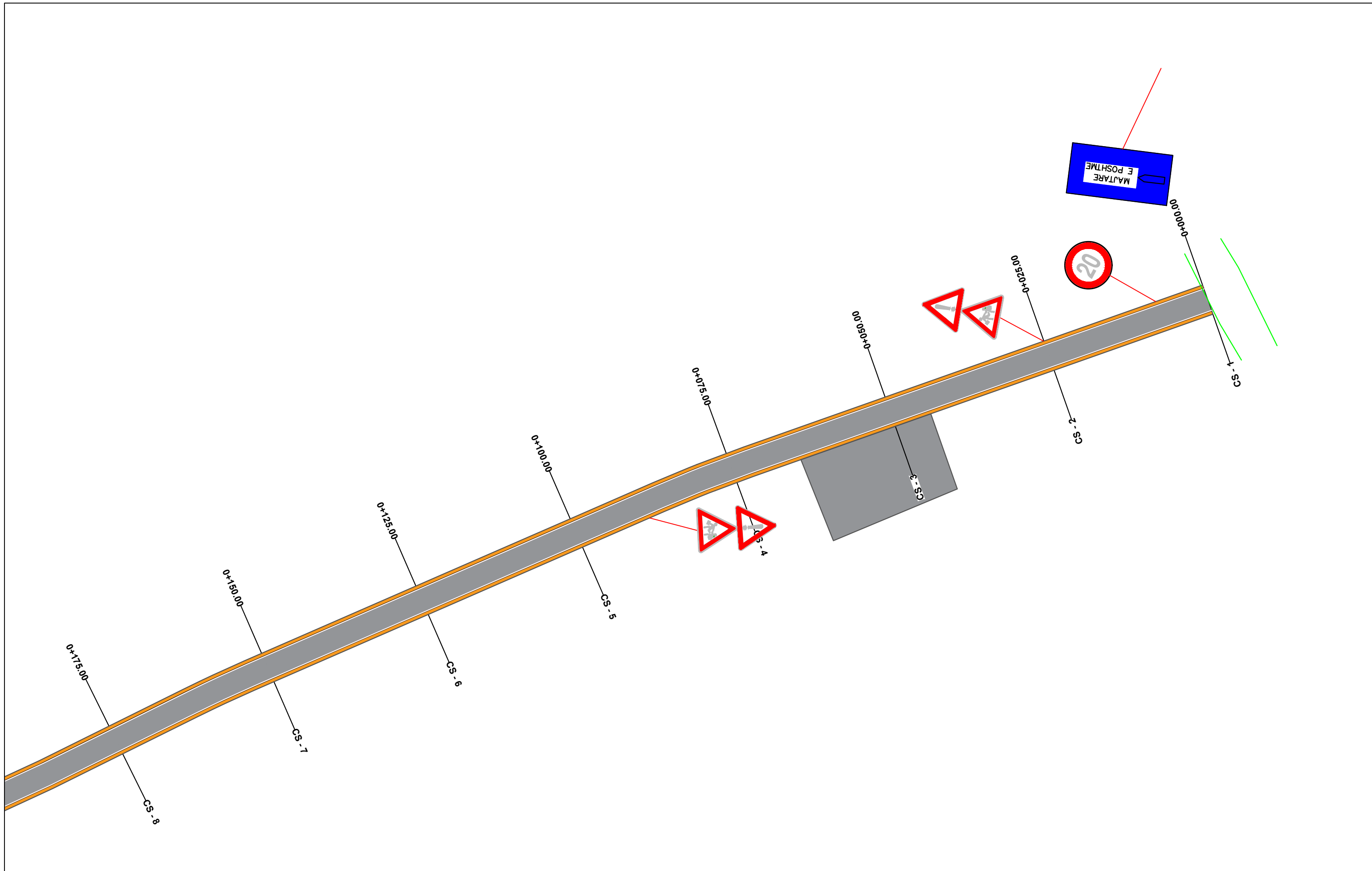

POROSITES : BASHKIA DIBER
 RIKONSTRUKSION DHE SISTEMIM ASFALTIM I RRUGES
 SE FSHATIT MAJTARE E POSHTME , NJ.A MAQELLARE

EMERTIMI : SINJALISTIKA E RRUGES
 "ERALD-G" sh.p.k
 Rruga "Kongresi i Lushnjes"
 Tirane

DREJTUES PROJEKTI
 Ing.Gezim ISLAMI

PROJEKTUES

Ing.Erindi GJOKA	Hidr.Anisa ZAKA
Top.Alfred NDREGJONI	Mek.Arben MUHA
Top.Kujtim CANAMETI	Ing.Eraldo ISLAMI

SHKALLA	FLETA
SHK - 1:500	6 - 01
TIRANE 2022	FORMAT A3

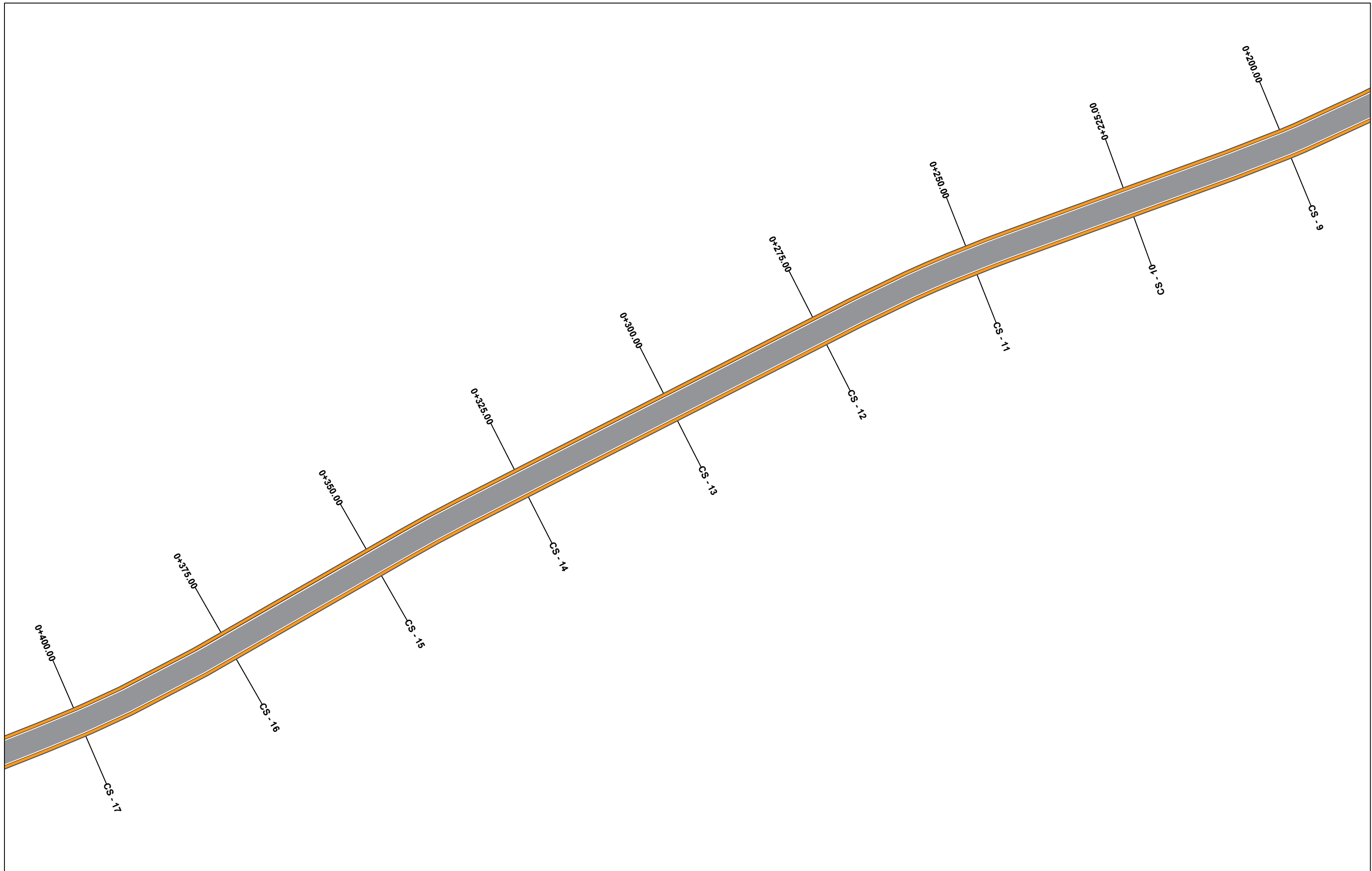

POROSITES : BASHKIA DIBER
 RIKONSTRUKSION DHE SISTEMIM ASFALTIM I RRUGES
 SE FSHATIT MAJTARE E POSHTME , NJ.A MAQELLARE

EMERTIMI : SINJALISTIKA E RRUGES

	"ERALD-G" sh.p.k
	Rruga "Kongresi i Lushnjes" Tirane

DREJTUES PROJEKTI

Ing.Gezim ISLAMI

PROJEKTUES

Ing.Erindi GJOKA	Hidr.Anisa ZAKA
Top.Alfred NDREGJONI	Mek.Arben MUHA
Top.Kujtim CANAMETI	Ing.Eraldo ISLAMI

SHKALLA

SHK - 1:500

TIRANE 2022

FLETA

6 - 02

FORMAT A3

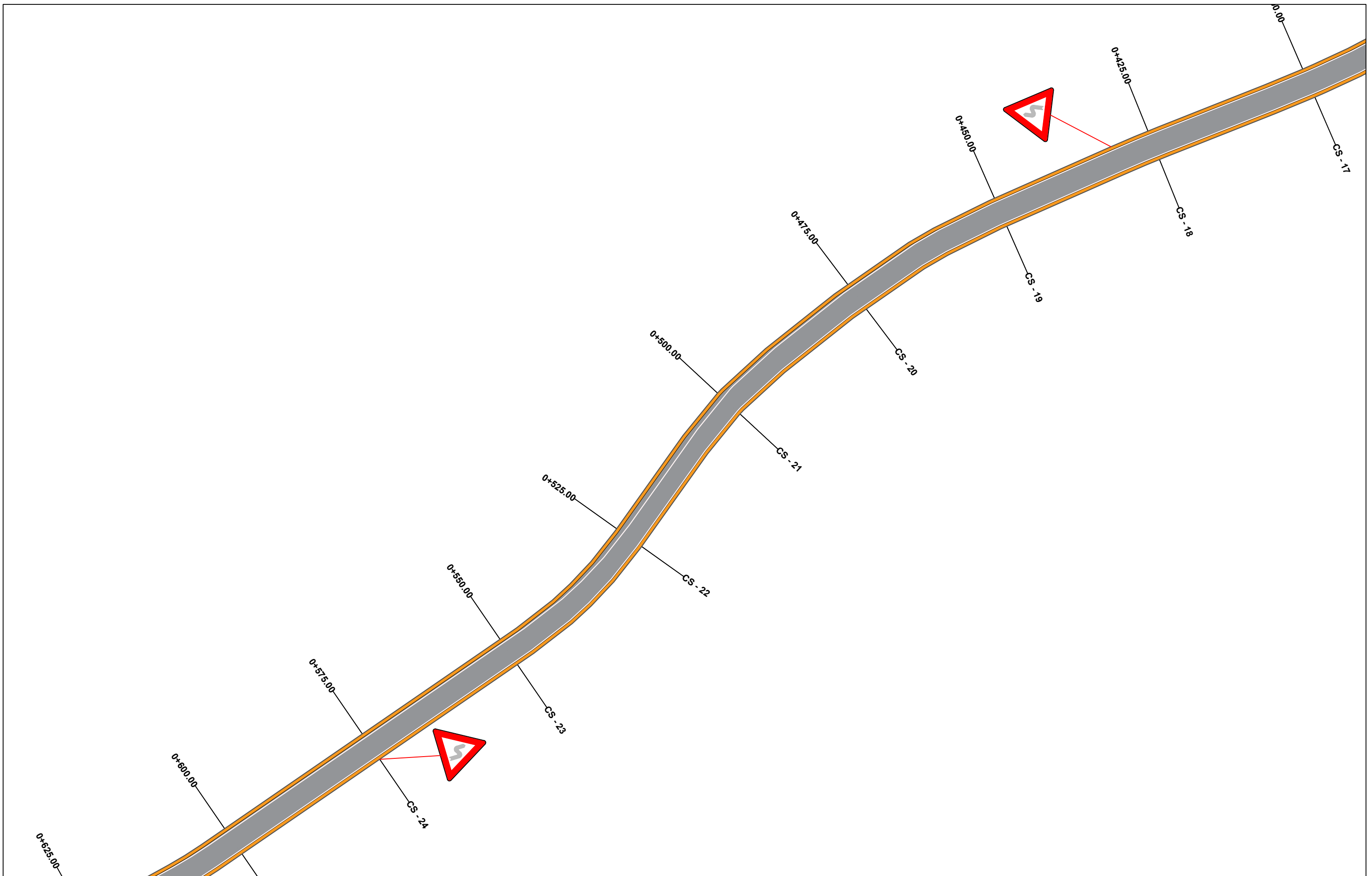

POROSITES : BASHKIA DIBER
 RIKONSTRUKSION DHE SISTEMIM ASFALTIM I RRUGES
 SE FSHATIT MAJTARE E POSHTME , NJ.A MAQELLARE

EMERTIMI : SINJALISTIKA E RRUGES

 "ERALD-G" sh.p.k
 Rruga "Kongresi i Lushnjes"
 Tirane

DREJTUES PROJEKTI
 Ing.Gezim ISLAMI

PROJEKTUES

Ing.Erindi GJOKA	Hidr.Anisa ZAKA
Top.Alfred NDREGJONI	Mek.Arben MUHA
Top.Kujtim CANAMETI	Ing.Eraldo ISLAMI

SHKALLA	FLETA
SHK - 1:500	6 - 03
TIRANE 2022	FORMAT A3

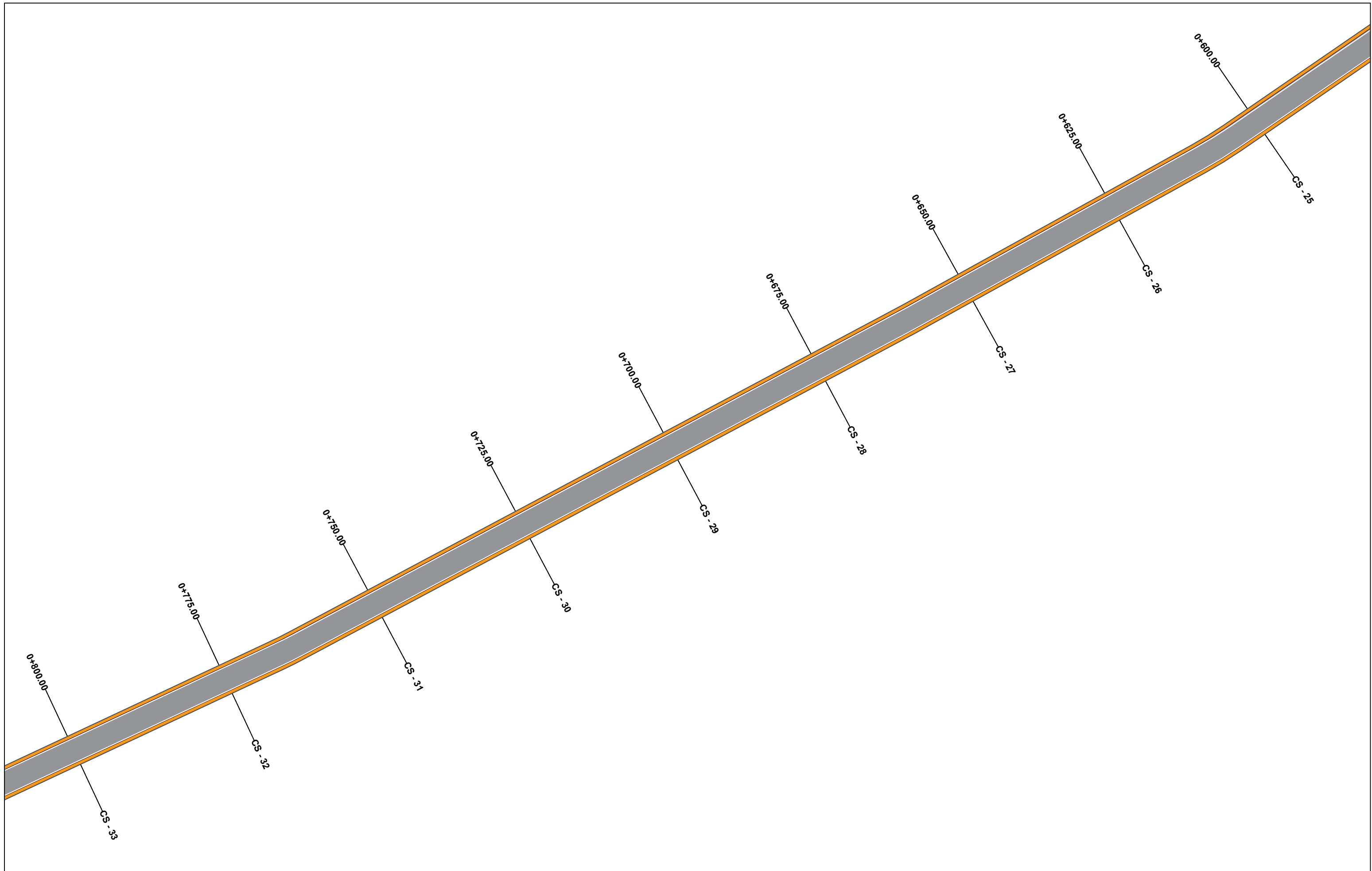

POROSITES : BASHKIA DIBER
 RIKONSTRUKSION DHE SISTEMIM ASFALTIM I RRUGES
 SE FSHATIT MAJTARE E POSHTME , NJ.A MAQELLARE

EMERTIMI : SINJALISTIKA E RRUGES

	"ERALD-G" sh.p.k
	Rruga "Kongresi i Lushnjes"
	Tirane

DREJTUES PROJEKTI
 Ing.Gezim ISLAMI

PROJEKTUES			
Ing.Erindi GJOKA		Hidr.Anisa ZAKA	
Top.Alfred NDREGJONI		Mek.Arben MUHA	
Top.Kujtim CANAMETI		Ing.Eraldo ISLAMI	

SHKALLA	FLETA
SHK - 1:500	6 - 04
TIRANE 2022	FORMAT A3

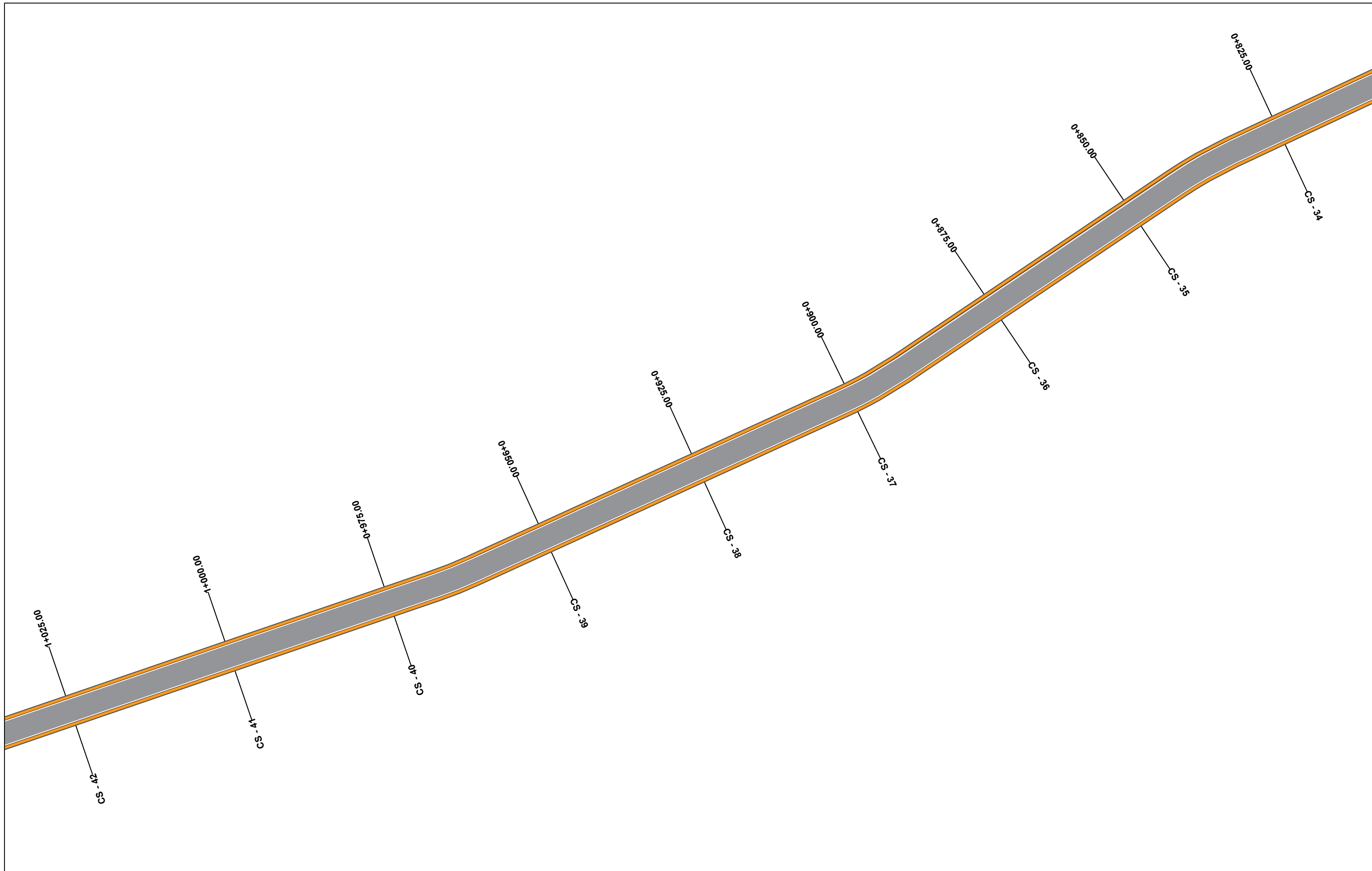

POROSITES : BASHKIA DIBER
 RIKONSTRUKSION DHE SISTEMIM ASFALTIM I RRUGES
 SE FSHATIT MAJTARE E POSHTME , NJ.A MAQELLARE

EMERTIMI : SINJALISTIKA E RRUGES

	"ERALD-G" sh.p.k
	Rruga "Kongresi i Lushnjes" Tirane

DREJTUES PROJEKTI	PROJEKTUES		
Ing.Gezim ISLAMI	Ing.Erindi GJOKA	Hidr.Anisa ZAKA	
	Top.Alfred NDREGJONI	Mek.Arben MUHA	
	Top.Kujtim CANAMETI	Ing.Eraldo ISLAMI	

SHKALLA	FLETA
SHK - 1:500	6 - 05
TIRANE 2022	FORMAT A3

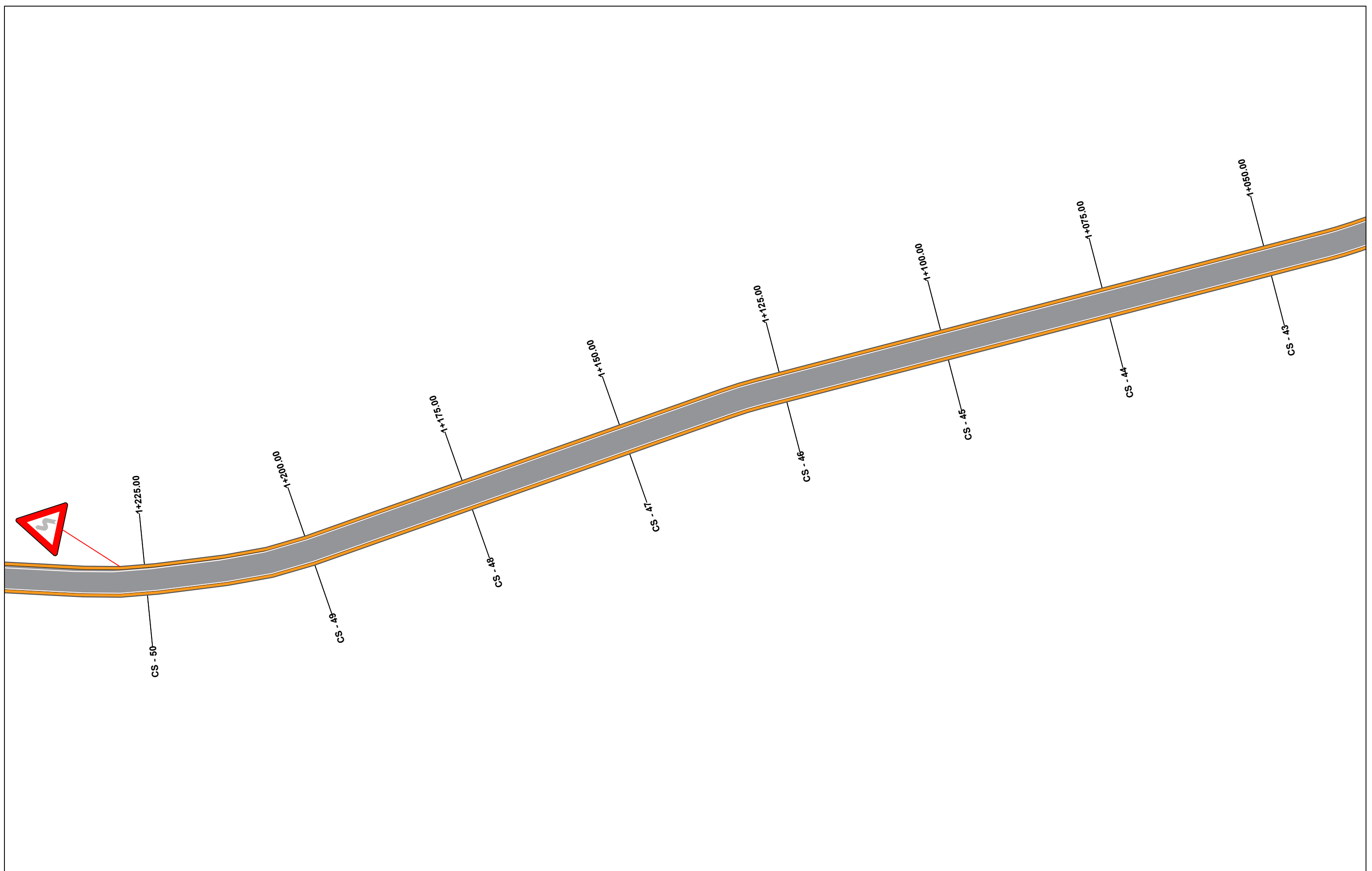

POROSITES : BASHKIA DIBER
 RIKONSTRUKSION DHE SISTEMIM ASFALTIM I RRUGES
 SE FSHATIT MAJTARE E POSHTME , NJ.A MAQELLARE

EMERTIMI : SINJALISTIKA E RRUGES

	"ERALD-G" sh.p.k
	Rruga "Kongresi i Lushnjes" Tirane

DREJTUES PROJEKTI	PROJEKTUES		
Ing.Gezim ISLAMI	Ing.Erindi GJOKA	Hidr.Anisa ZAKA	
	Top.Alfred NDREGJONI	Mek.Arben MUHA	
	Top.Kujtim CANAMETI	Ing.Eraldo ISLAMI	

SHKALLA	FLETA
SHK - 1:500	6 - 06
TIRANE 2022	FORMAT A3

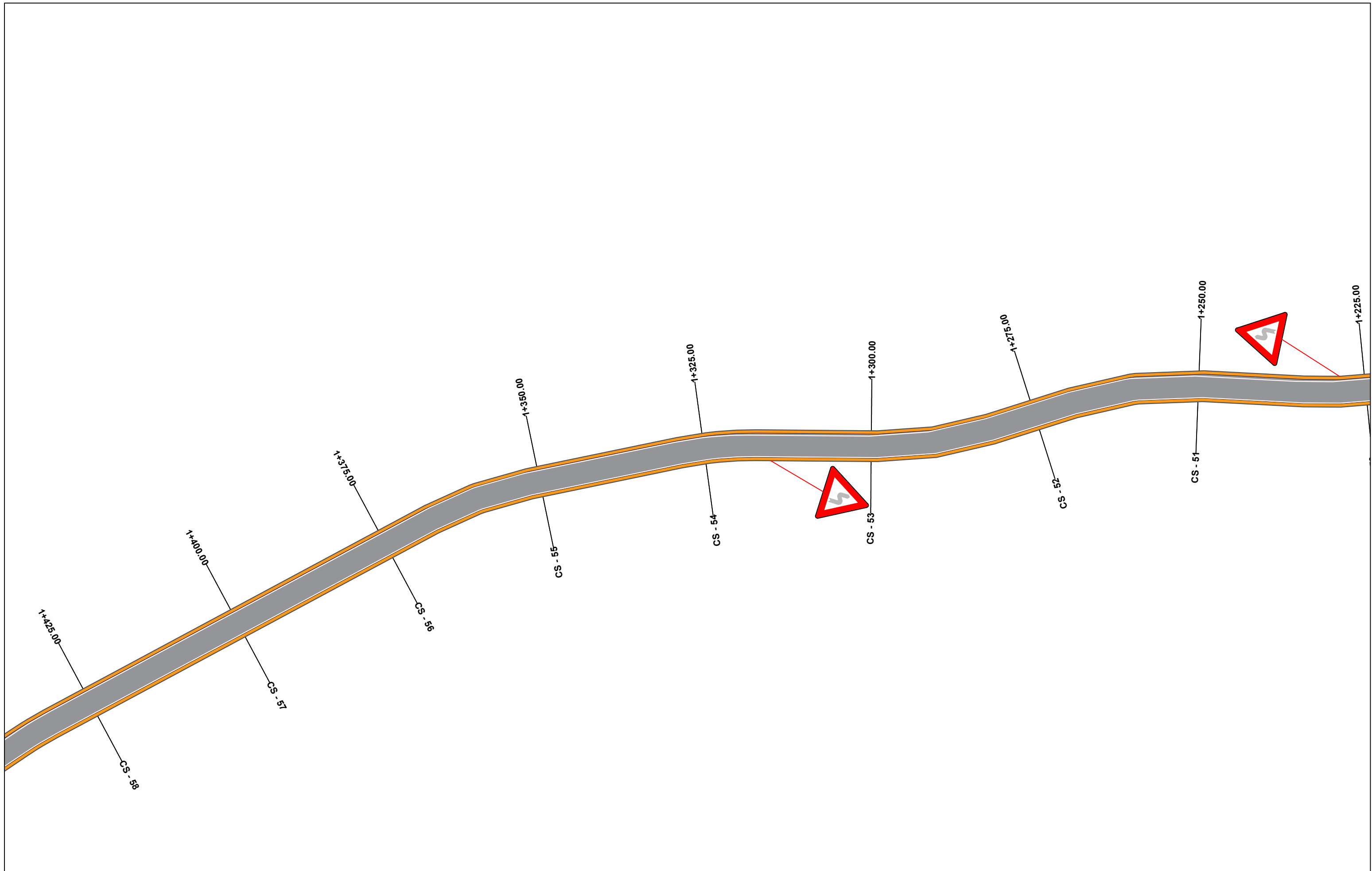

POROSITES : BASHKIA DIBER
 RIKONSTRUKSION DHE SISTEMIM ASFALTIM I RRUGES
 SE FSHATIT MAJTARE E POSHTME , NJ.A MAQELLARE

EMERTIMI : SINJALISTIKA E RRUGES



"ERALD-G" sh.p.k
 Rruga "Kongresi i Lushnjes"
 Tirane

DREJTUES PROJEKTI

Ing.Gezim ISLAMI

PROJEKTUES

Ing.Erindi GJOKA	Hidr.Anisa ZAKA
Top.Alfred NDREGJONI	Mek.Arben MUHA
Top.Kujtim CANAMETI	Ing.Eraldo ISLAMI

SHKALLA

SHK - 1:500

TIRANE 2022

FLETA

6 - 07

FORMAT A3

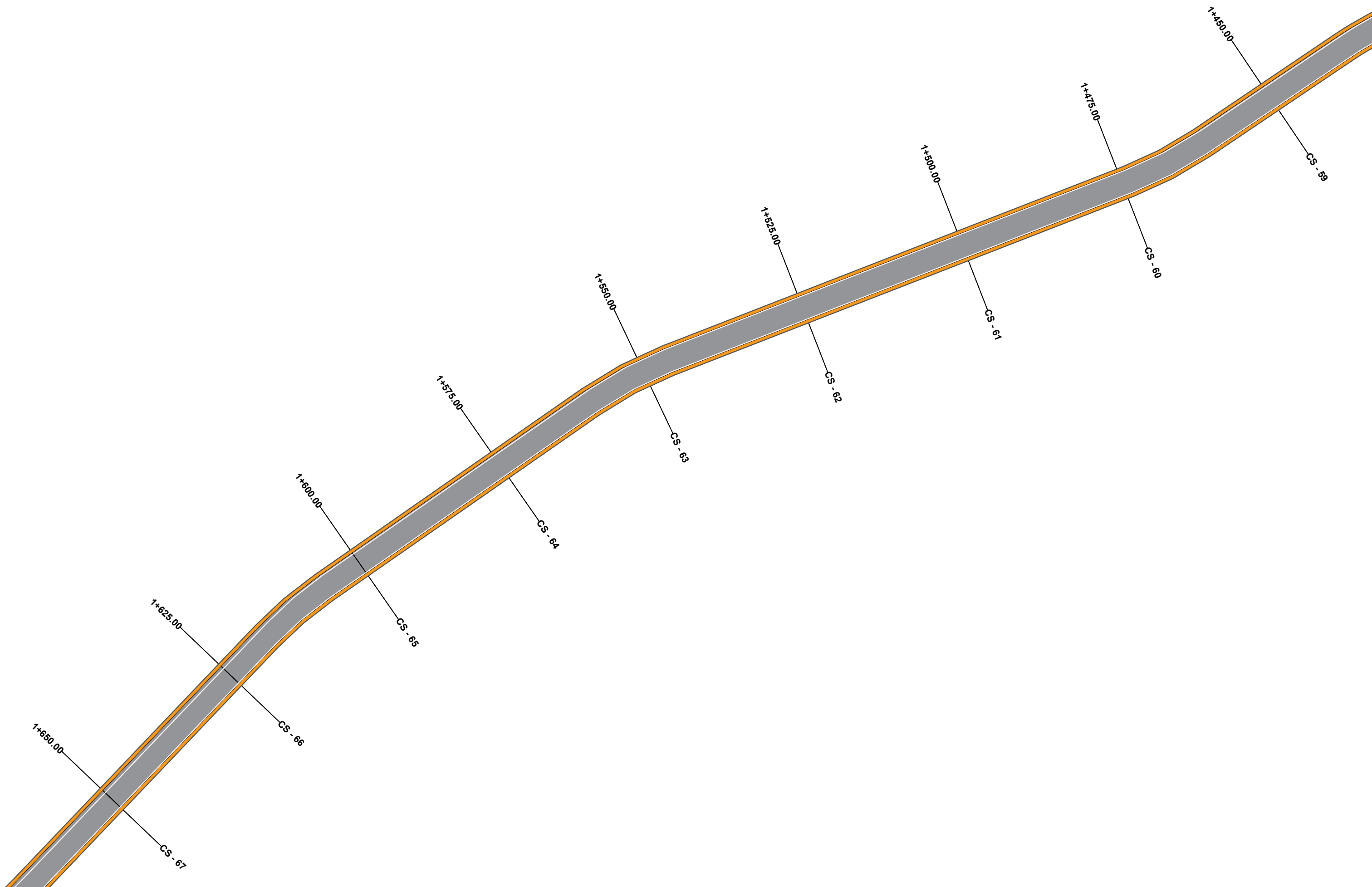

POROSITES : BASHKIA DIBER
 RIKONSTRUKSION DHE SISTEMIM ASFALTIM I RRUGES
 SE FSHATIT MAJTARE E POSHTME , NJ.A MAQELLARE

EMERTIMI : SINJALISTIKA E RRUGES

	"ERALD-G" sh.p.k
	Rruga "Kongresi i Lushnjes" Tirane

DREJTUES PROJEKTI

Ing.Gezim ISLAMI

PROJEKTUES

Ing.Erindi GJOKA	Hidr.Anisa ZAKA
Top.Alfred NDREGJONI	Mek.Arben MUHA
Top.Kujtim CANAMETI	Ing.Eraldo ISLAMI

SHKALLA

SHK - 1:500
TIRANE 2022

FLETA

6 - 08
FORMAT A3

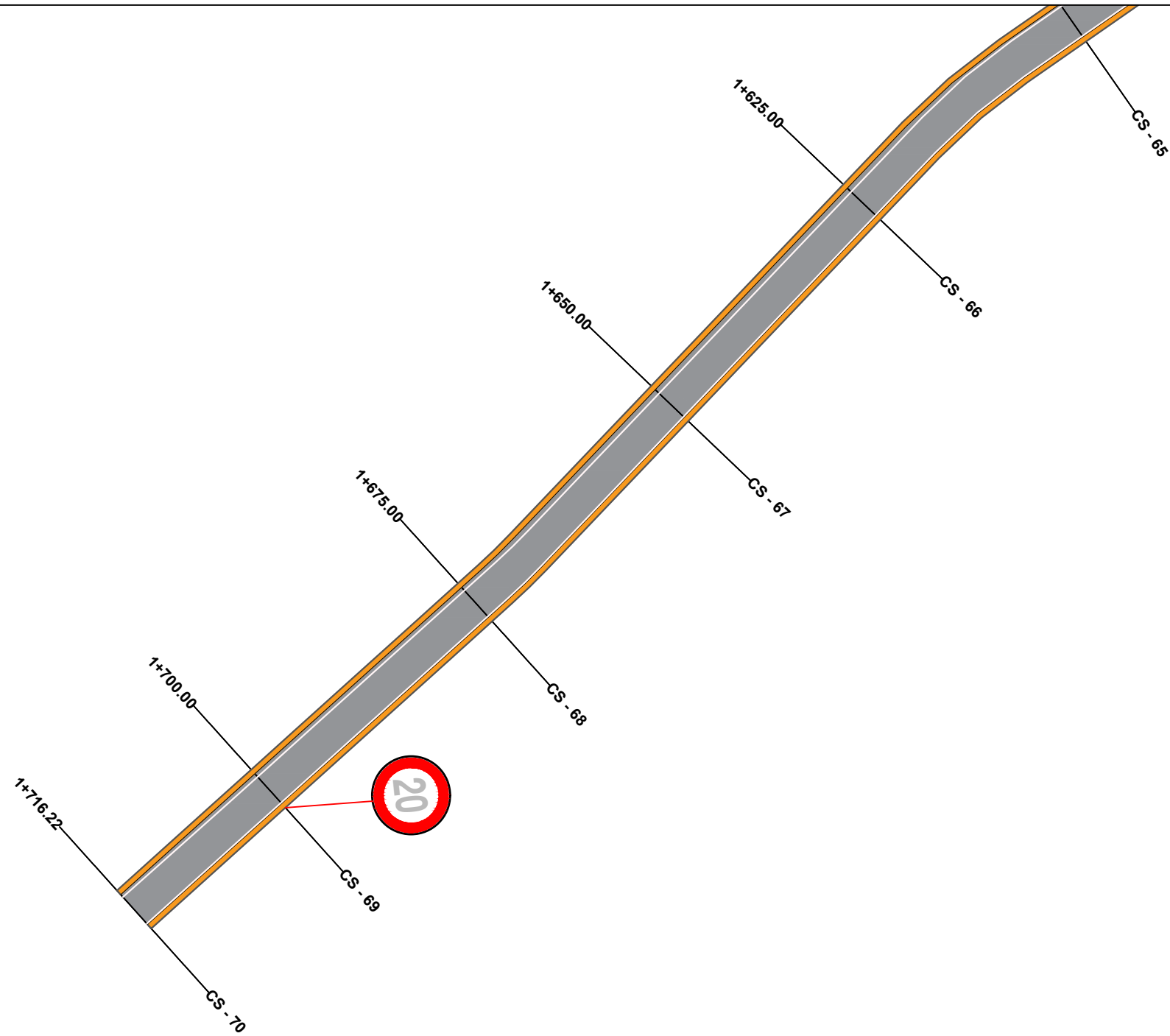

POROSITES : BASHKIA DIBER
 RIKONSTRUKSION DHE SISTEMIM ASFALTIM I RRUGES
 SE FSHATIT MAJTARE E POSHTME , NJ.A MAQELLARE

EMERTIMI : SINJALISTIKA E RRUGES

	"ERALD-G" sh.p.k
	Rruga "Kongresi i Lushnjes" Tirane

DREJTUES PROJEKTI

Ing.Gezim ISLAMI

PROJEKTUES

Ing.Erindi GJOKA	Hidr.Anisa ZAKA
Top.Alfred NDREGJONI	Mek.Arben MUHA
Top.Kujtim CANAMETI	Ing.Eraldo ISLAMI

SHKALLA

SHK - 1:500

TIRANE 2022

FLETA

6 - 09

FORMAT A3

TOMBINO Ø600 B/A

PRERJE NE AKS E TOMBINOS

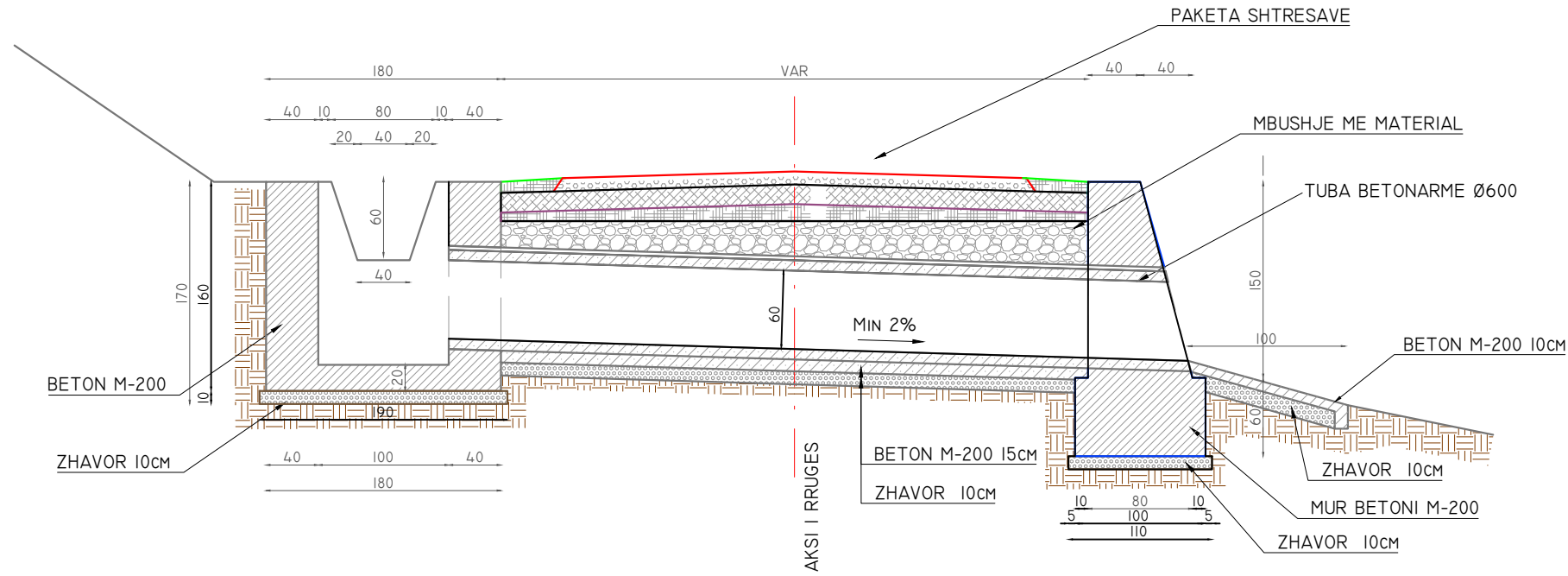

VOLUMET E PUNES

EMERTIMI		m ³
BETON M-200	PUSETA	3.30
	PORTALI	3.60
	DHEMBI + SHTRESA	0.10
	TOTALI	7.0
SHTRERE ZHAVORRI		1.23

PRERJA 1-1

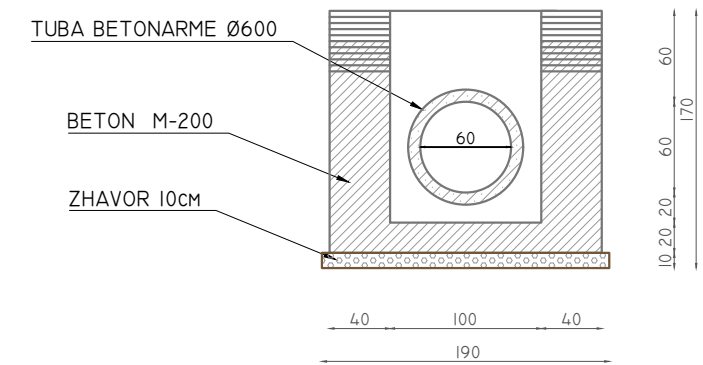

PLANIMETRIA

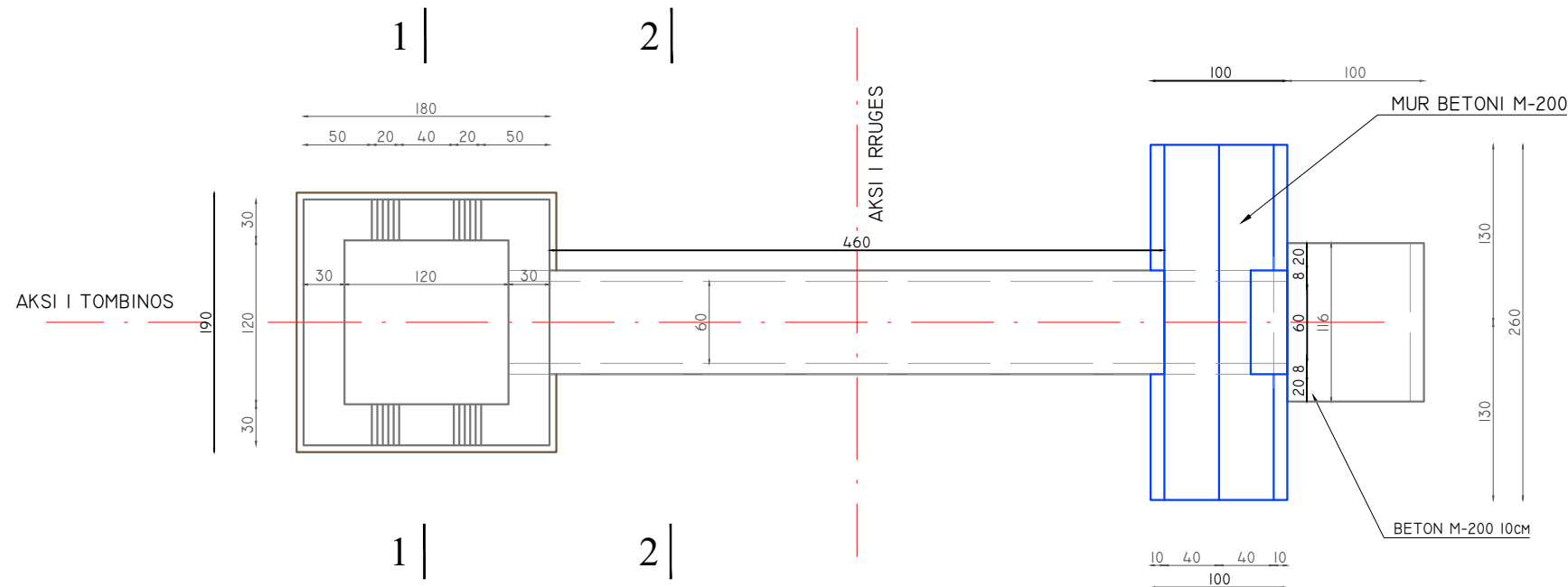

PRERJA 2-2

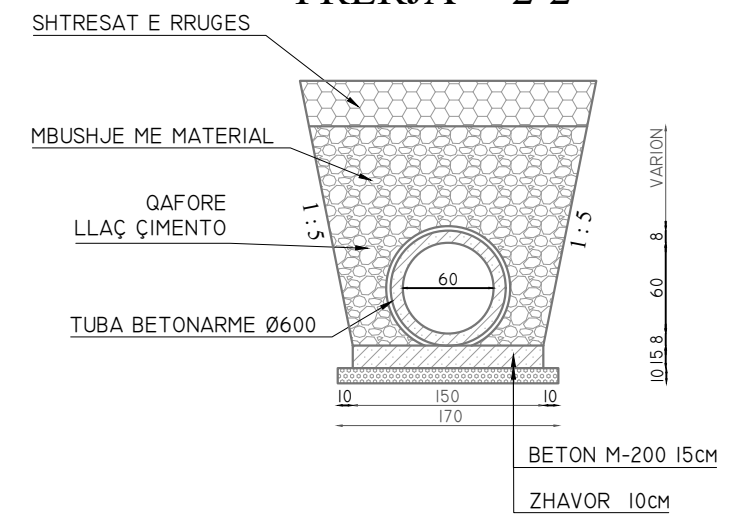

POSDITES : BASHKIA DIBER

RIKONSTRUKSION DHE SISTEMIM ASFALTIM I RRUGES SE FSHATIT MAJTARE E POSHTME , NJ.A MAQELLARE

EMERTIMI : DETAJE

"ERALD-G" sh.p.k
Rruga "Kongresi i Lushnjes"
Tirane

DREJTUES PROJEKTI

Ing.Gezim ISLAMI

PROJEKTUES

Ing.Erindi GJOKA
Top.Alfred NDREGJONI
Top.Kujtim CANAMETI

Hidr.Anisa ZAKA
Mek.Arben MUHA
Ing.Eraldo ISLAMI

SHKALLA

SHK - 1:50

TIRANE 2022

FLETA

7 - 01

FORMAT A3

SHENJAT PARANDALUESE

Trekendeshi: e kuqe reflektive

Sfondi: e kuqe reflektive

Simboli: zeze

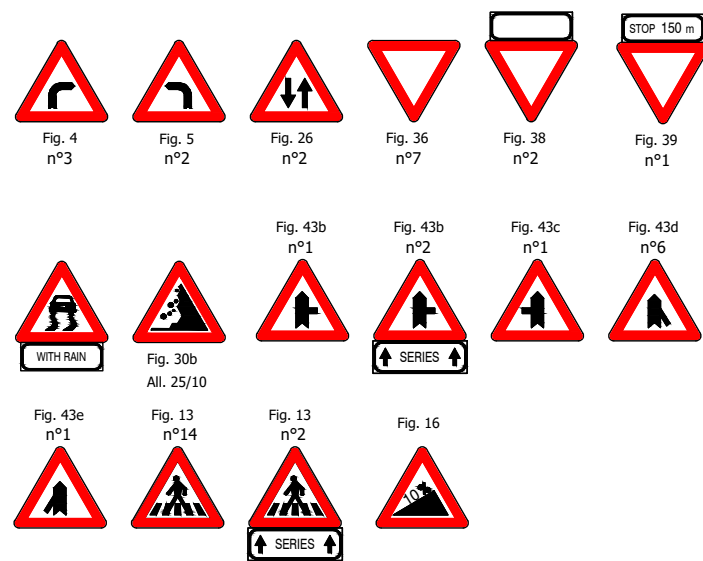

TABELAT POTESUESE

Tabela: e bardhe reflektive

Sfondi : e zeze

TABELAT SHITESE

Sfondi: e bardhe reflektive

TABELAT SHIGJETE

Sfondi: jeshile reflektive

Teksti: e zeze

Pozicioni i shenjave Chevron	
Rrezja e kthese (m)	Distanca (m)
30 - 50	8
50 - 100	12
100 - 200	20
200 - 400	30
>400 (nese duhet)	30-50

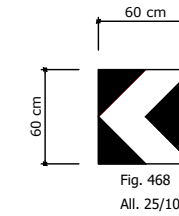

Shenja Chevron ne nje drejtim

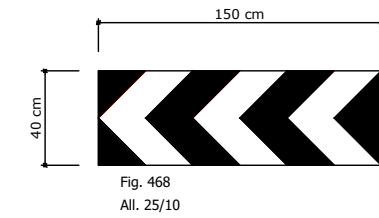

Shenja Chevron

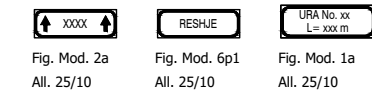
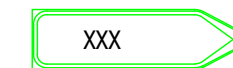

Fig. 249

All. 25/10



TABELAT INFORMUESE

Fig. 317 All. 25/10

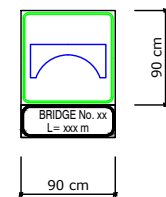

Fig. 295 All. 25/10

PROHIBIT SIGN SHENJA PARANDALUES

Ndalim parakalimi

Cepi & sfondi: e bardhe reflektive

Rrethi: e kuqe reflektive

Simboli: e zeze dhe kuqe reflektive

Limit shpejtesie

Rrethi: e kuqe reflektive

Simboli: e zeze reflektive

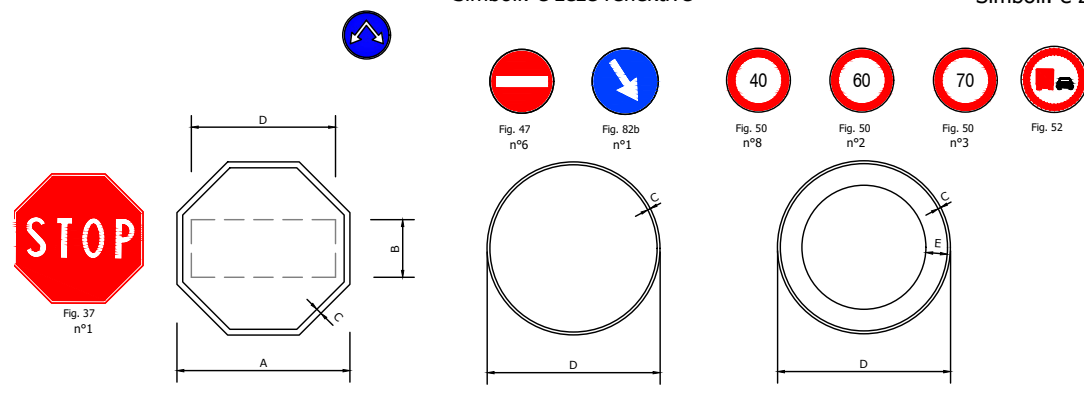

TETEKENDESH

	A	B	C	D
Small	60	20	2	50

SHENJAT DETYRUESE

	C	D
Small	0.8	40

SHENJAT PARANDALUESE

	C	D	E
Small	0.8	40	5
Normal	1	60	7.5

TREKENDORE

	A	C	E	R
Small	60	1	5.5	3
Normal	90	1.5	8	4.5

DREJTEKENDESH INFORMUES

	A	B	C	D	R
Small	58	0.3	0.6	18	2

DREJTEKENDESH

	A	B	C	D	R
Normal	90	0.8	1.5	30	5.5

Normal	C	D	E	H	L	M
	1.5	1	22	40	150	18
	N	R1	R2	R3	P	S
15.5	8	13	2	6.5	38	

DREJTEKENDORE

	A	B	C	D	R
Normal	90	135	1.6	0.8	7

POROSITES : BASHKIA DIBER

RIKONSTRUKSION DHE SISTEMIM ASFALTIM I RRUGES SE FSHATIT MAJTARE E POSHTME , NJ.A MAQELLARE

EMERTIMI : DETAJE SINJALISTIKE

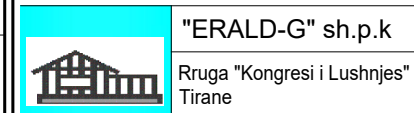

DREJTUES PROJEKTI

Ing.Gezim ISLAMI

PROJEKTUES

Ing.Erindi GJOKA

Ing.Alfred NDREGJONI

Top.Kujtim CANAMETI

Hidr.Anisa ZAKA

Mek.Arben MUHA

Ing. Eraldo Islami

SHKALLA

SHK - 1:50

TIRANE 2022

FLETA

7 - 02

FORMAT A3

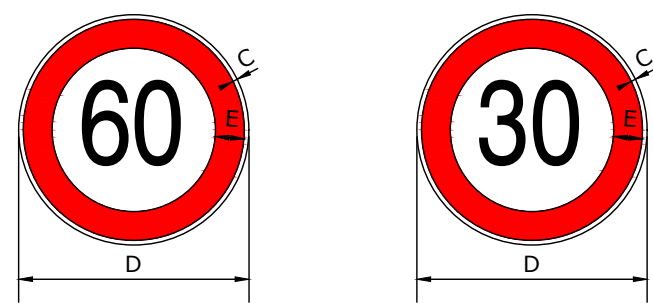

C	D	E
0.8	40	5

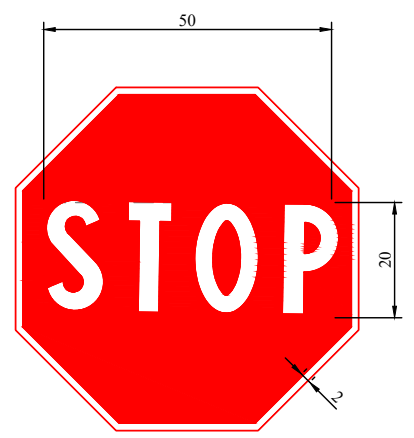

A	B	C	D
60	20	2	50

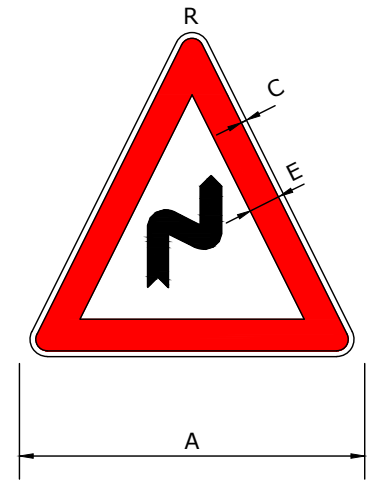

A	C	E	R
60	1	5.5	3

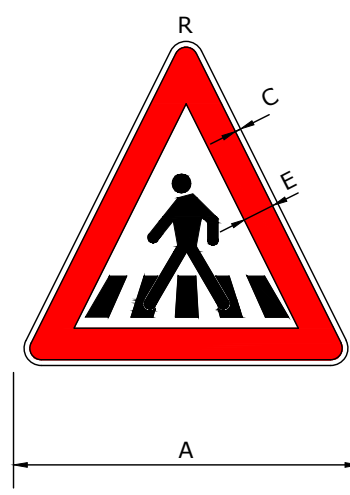

A	C	E	R
60	1	5.5	3

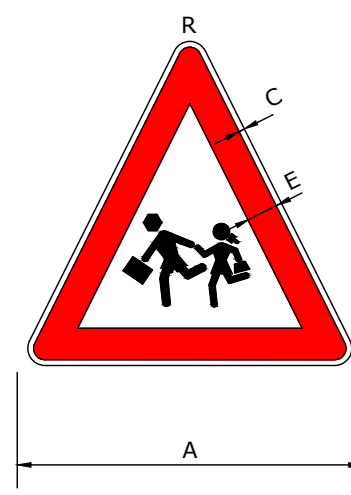

A	C	E	R
60	1	5.5	3

VIJEZIMI I RRUGEVE

VIJEZIMI NE KUFIJETE E RRUGES Tipi A"vazhduar"



Linjë paralajmëruese tek nyjet, kthesat dhe pikat e tjera të rrezikshme

Type E

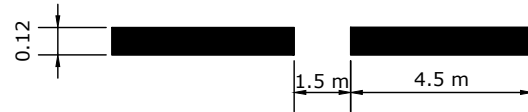

Vijëzimi tek cepi i karrexhatës, tek nyjet ose vendndodhjet anësore.

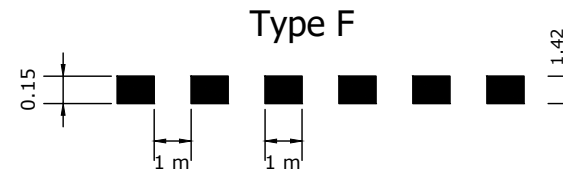

Type F

Vijëzimi i aksit qendror ose vijëzimi i korsisë për shpejtësi <50 km/h

Type D

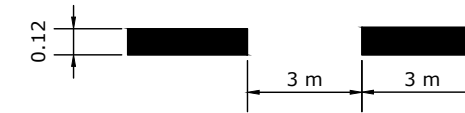

Udhëzuesi për automjetet që duhet të kalojnë nëpër një nyje.
Zakonisht përdoret tek nyjet komplekse.

Type G

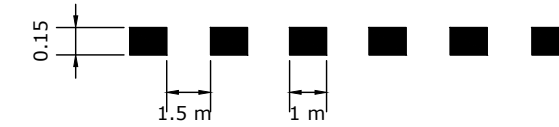

KALIMI KEMBESOREVE

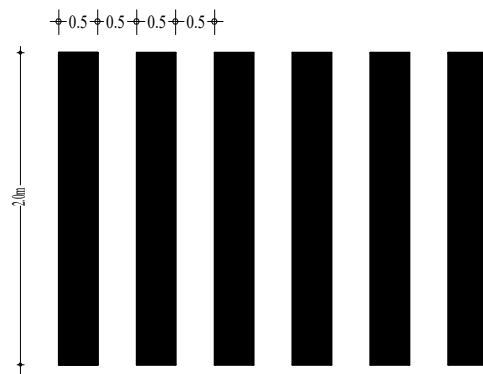

VIJEZIMI NE AKS TE RRUGES

Tipi A"vazhduar"

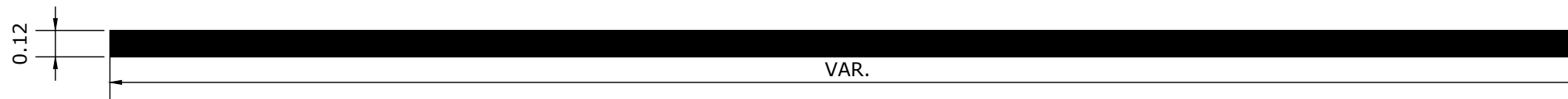

POROSITES : BASHKIA DIBER

RIKONSTRUKSION DHE SISTEMIM ASFALTIM I RRUGES
SE FSHATIT MAJTARE E POSHTME , NJ.A MAQELLARE

EMERTIMI : DETAJE SINJALISTIKE



"ERALD-G" sh.p.k
Rruga "Kongresi i Lushnjes"
Tirane

DREJTUES PROJEKTI

Ing.Gezim ISLAMI

PROJEKTUES

Ing.Erindi GJOKA

Ing.Alfred NDREGJONI

Top.Kujtim CANAMETI

Hidr.Anisa ZAKA

Mek.Arben MUHA

Ing. Eraldo Islami

SHKALLA

SHK - 1:50

TIRANE 2022

FLETA

7 - 04

FORMAT A3

VENDOSJA E TABELAVE

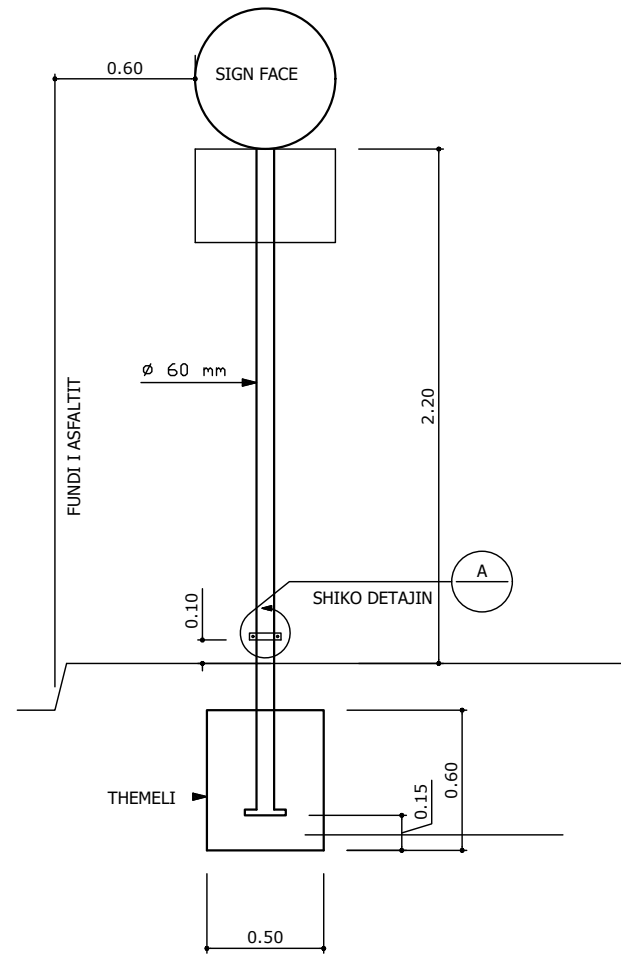

VENDOSJA E NJE TABELE

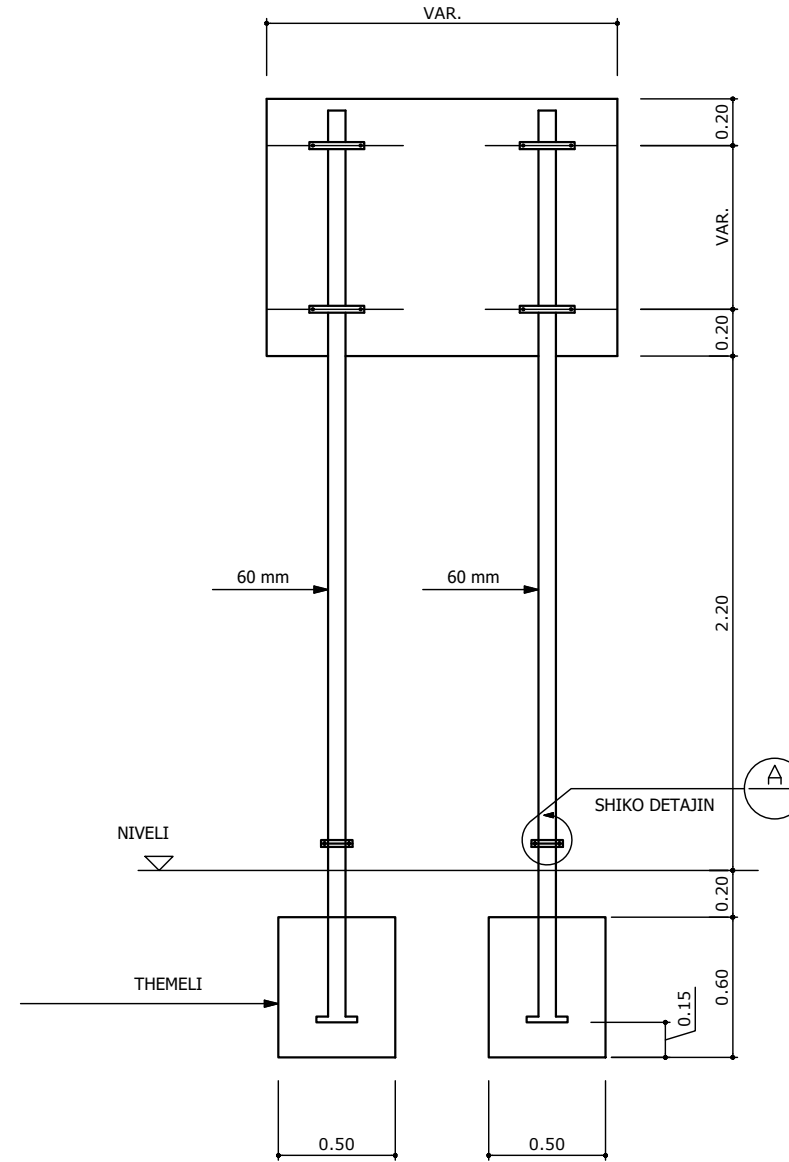

VENDOSJA E E DY TABELAVE

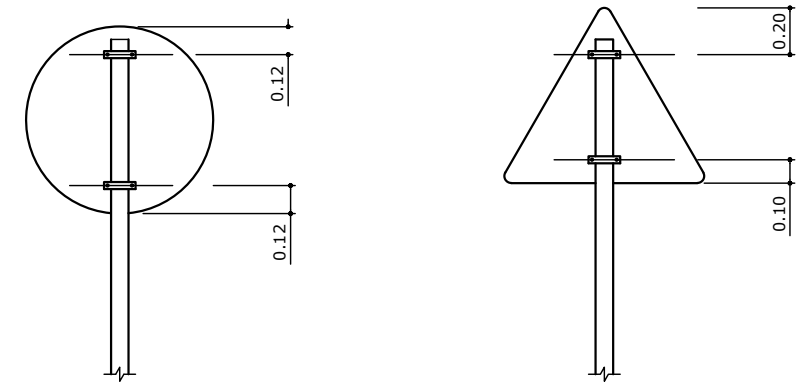

FIKSIMI I TABELES

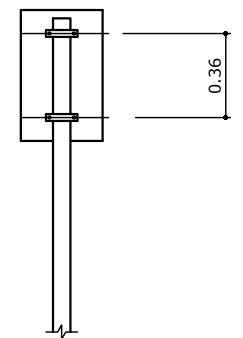
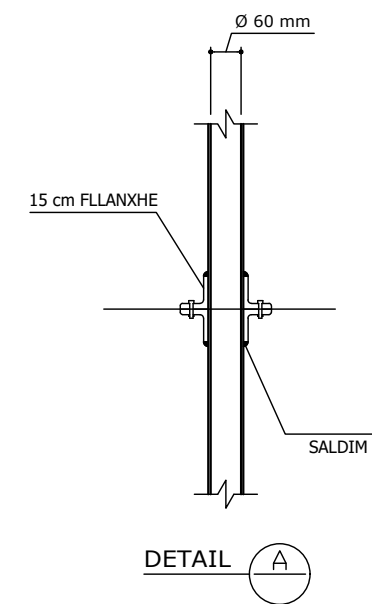

POROSITES : BASHKIA DIBER
RIKONSTRUKSION DHE SISTEMIM ASFALTIM I RRUGES SE FSHATIT MAJTARE E POSHTME , NJ.A MAQELLARE

EMERTIMI : DETAJE SINJALISTIKE

"ERALD-G" sh.p.k
Rruga "Kongresi i Lushnjes"
Tirane

DREJTUES PROJEKTI

Ing.Gezim ISLAMI

PROJEKTUES

Ing.Erindi GJOKA

Ing.Alfred NDRREGJONI

Top.Kujtim CANAMETI

Hidr.Anisa ZAKA

Mek.Arben MUHA

Ing. Eraldo Islami

SHKALLA

SHK - 1:50

TIRANE 2022

FLETA

7 - 05

FORMAT A3

INDIKATORI I CEPIT TE RRUGES

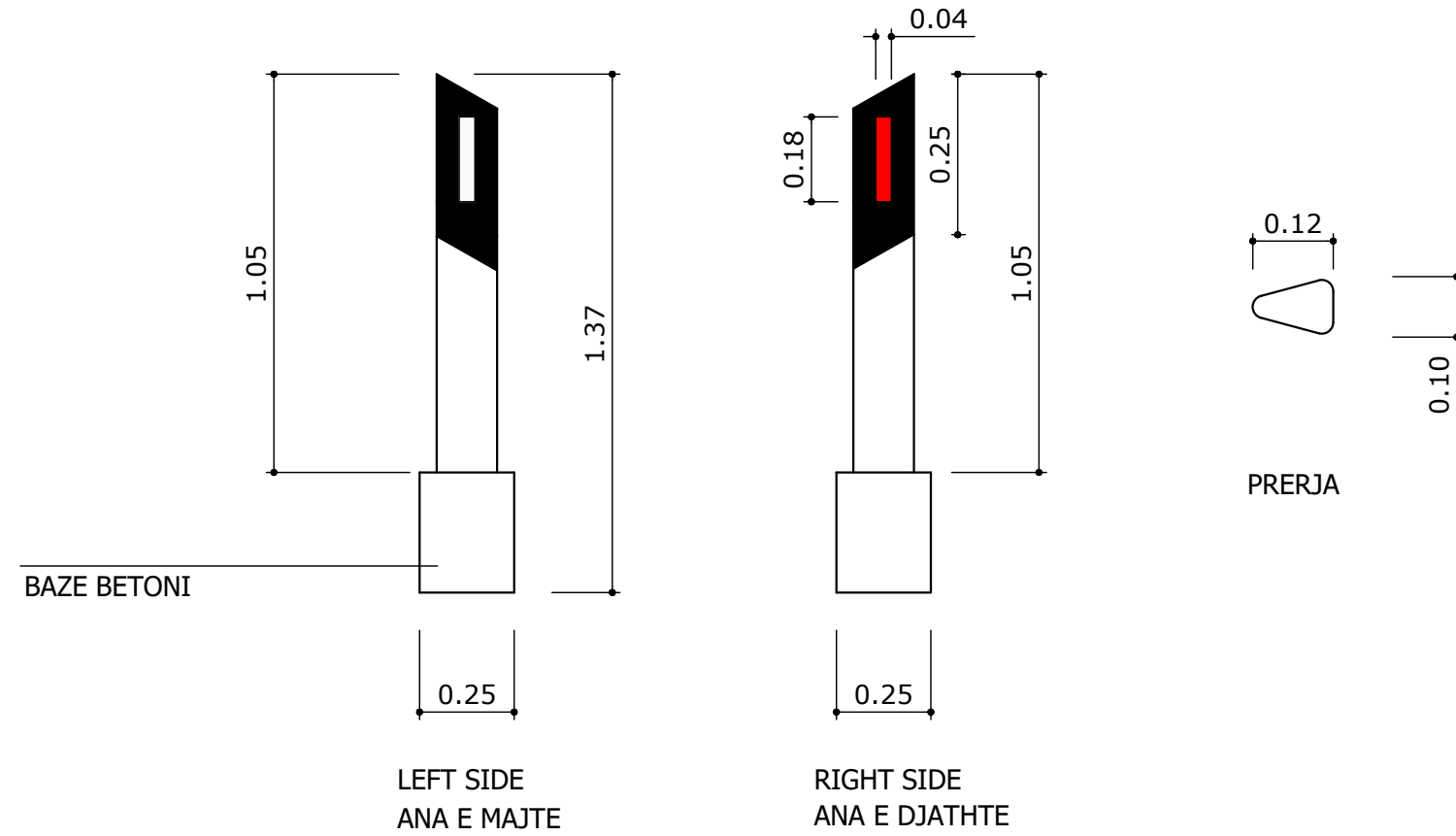

SHENIM: INDIKATORET E FUNDIT TE RRUGES VENDOSEN NE NJE DISTANCE PREJ 50 m.
NE RAST SE VENDOSEN NE GUARDRAIL TE RRUGES ATO FIKSOHEN NE FAQEN E TYRE.

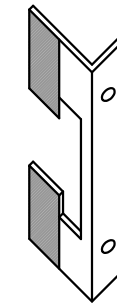

FIKSUES NE CEPAT E MUREVE TE BETONIT

POROSITES : BASHKIA DIBER
RIKONSTRUKSION DHE SISTEMIM ASFALTIM I RRUGES SE FSHATIT MAJTARE E POSHTME , NJ.A MAQELLARE

EMERTIMI : DETAJE SINJALISTIKE
 "ERALD-G" sh.p.k Rruga "Kongresi i Lushnjes" Tirane

DREJTUES PROJEKTI	PROJEKTUES		
Ing.Gezim ISLAMI	Ing.Erindi GJOKA		Hidr.Anisa ZAKA
	Ing.Alfred NDREGJONI		Mek.Arben MUHA
	Top.Kujtim CANAMETI		Ing. Eraldo Islami

SHKALLA	FLETA
SHK - 1:50	7 - 06
TIRANE 2022	FORMAT A3

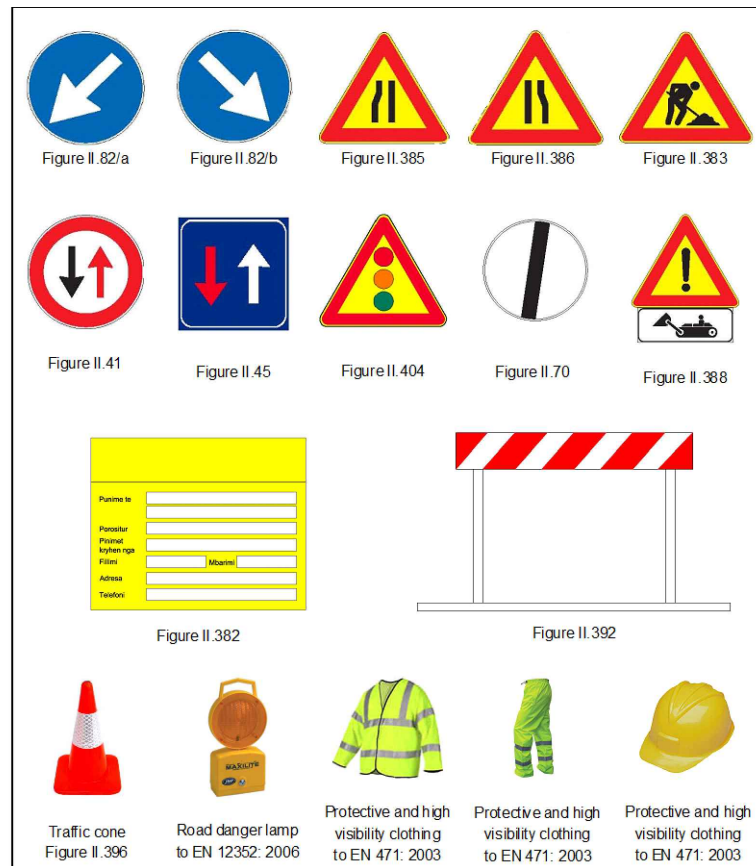

SHIGJETAT DREJTUESE

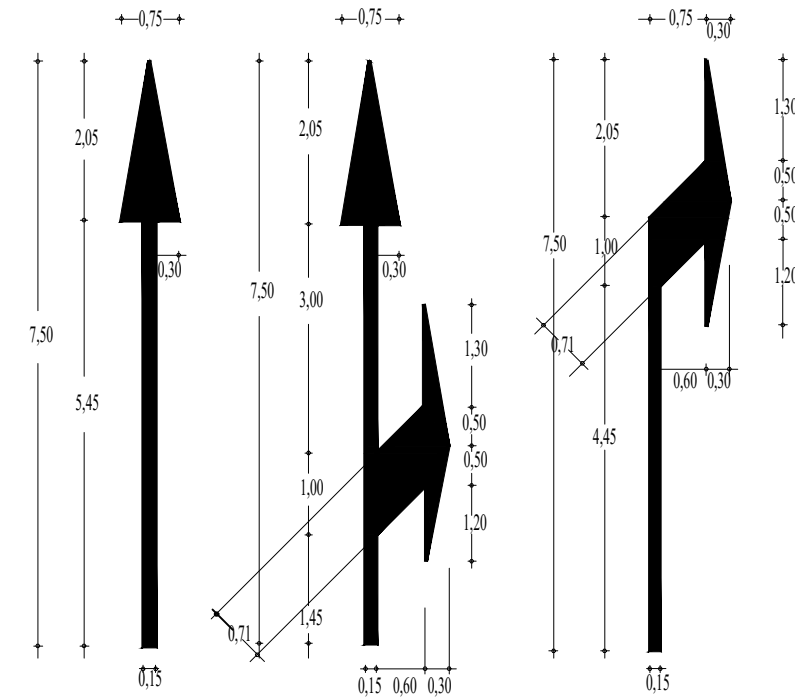

SHKRIMI I FJALES STOP

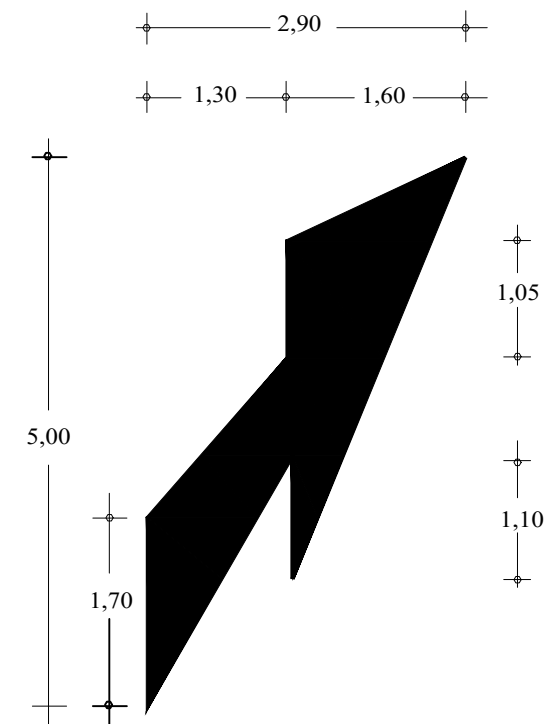
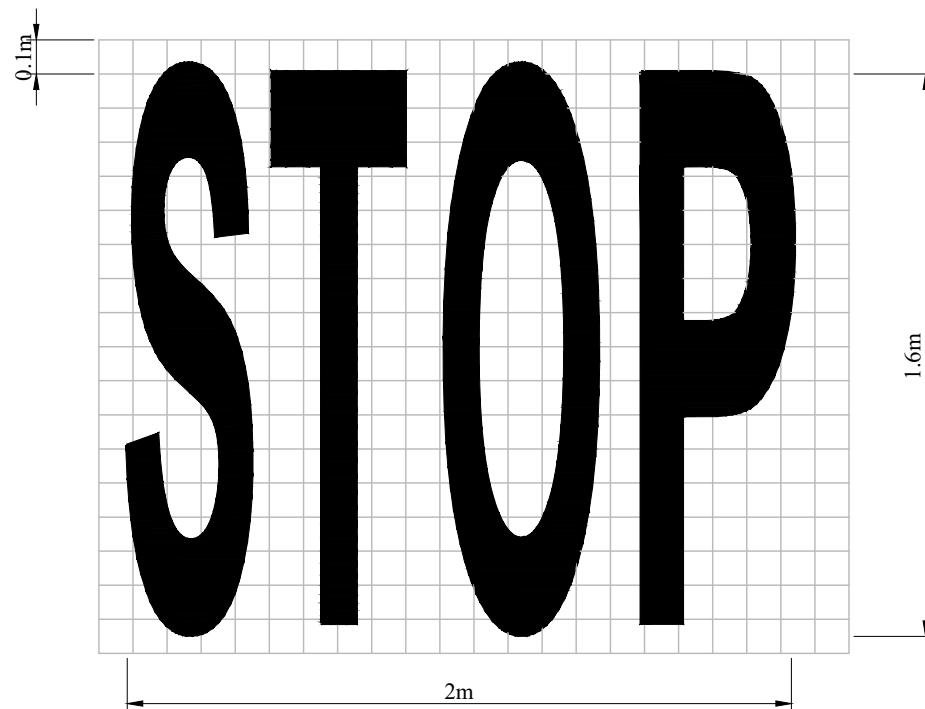

POROSITES : BASHKIA DIBER

RIKONSTRUKSION DHE SISTEMIM ASFALTIM I RRUGES SE FSHATIT MAJTARE E POSHTME , NJ.A MAQELLARE

EMERTIMI : DETAJE SINJALISTIKE

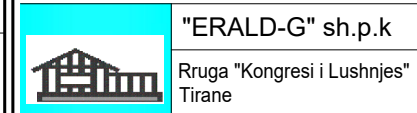

DREJTUES PROJEKTI

Ing.Gezim ISLAMI

PROJEKTUES

Ing.Erindi GJOKA

Ing.Alfred NDREGJONI

Top.Kujtim CANAMETI

Hidr.Anisa ZAKA

Mek.Arben MUHA

Ing. Eraldo Islami

SHKALLA

SHK - 1:50

TIRANE 2022

FLETA

7 - 07

FORMAT A3