

MIRATOHET
BASHKIA KRUJË
KRYETARI

Z. ARTUR BUSHI

PROJEKT

Z B A T I M I

OBJEKTI

RIJETËZIMI I KALLDRËMIT MESJETAR KRUJË-SARISALLTIK

**AUTORITETI
KONTRAKTOR**

BASHKIA KRUJË



KONSULENTI

“ERALD-G” Shpk

VITI 2017

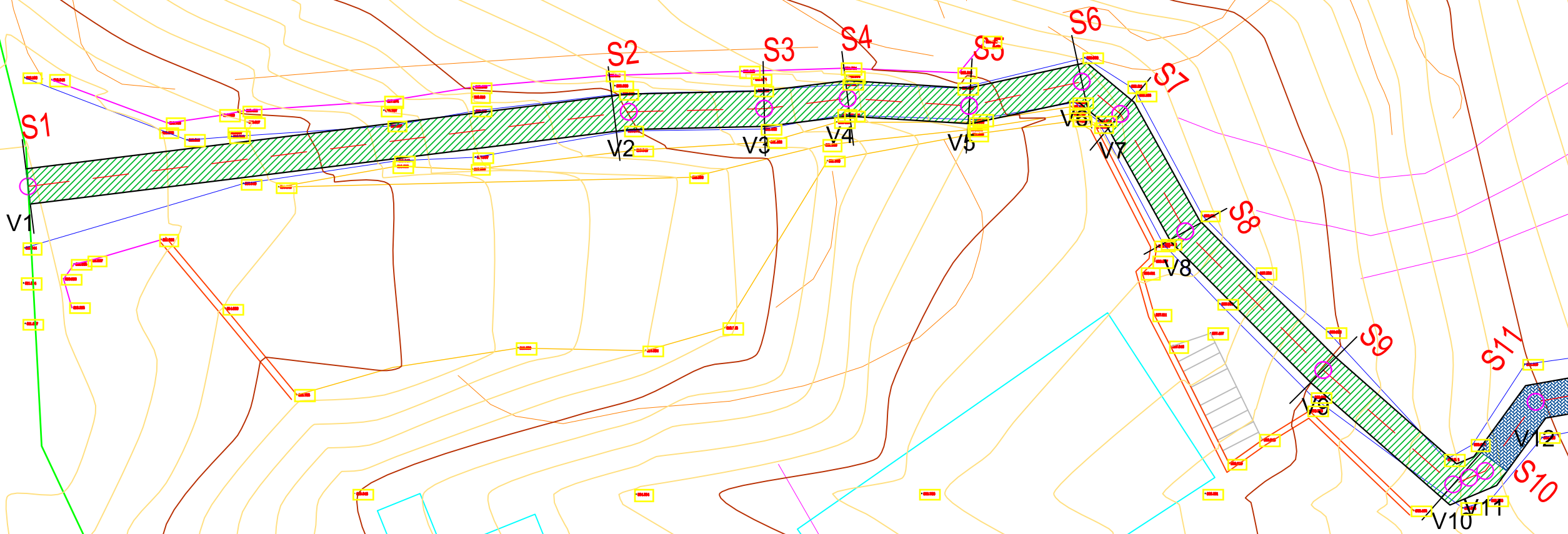
V1 **FILLIMI RRUGES**
 E= 399394.161
 N= 4596541.014



 Shkalle
 Ruge kembesore

Autoriteit Kontraktor : BASHKIA KRUJE

Objekti: Rikonstruksion Rruga Kembesore "Kruje - Sarisalltik"

Emertimi: PLANIMETRIA E RRUGES



"ERALD-G" Sh.p.k
 Adresa: Rruga "Koli Bano", Tirane

Drejtes i projektit

Inxh. Gezim ISLAMI

Projektues

Inxh. Aldo MERKAJ
 Ark.Elton Çarçani
 Hidr. Ersida VERÇANI

Elek. Hajdar KURTI
 Mek. Arben MUHA

SHKALLA

SHK 1:500

Tiranë 2017

FLETA

1 -01

Format A3

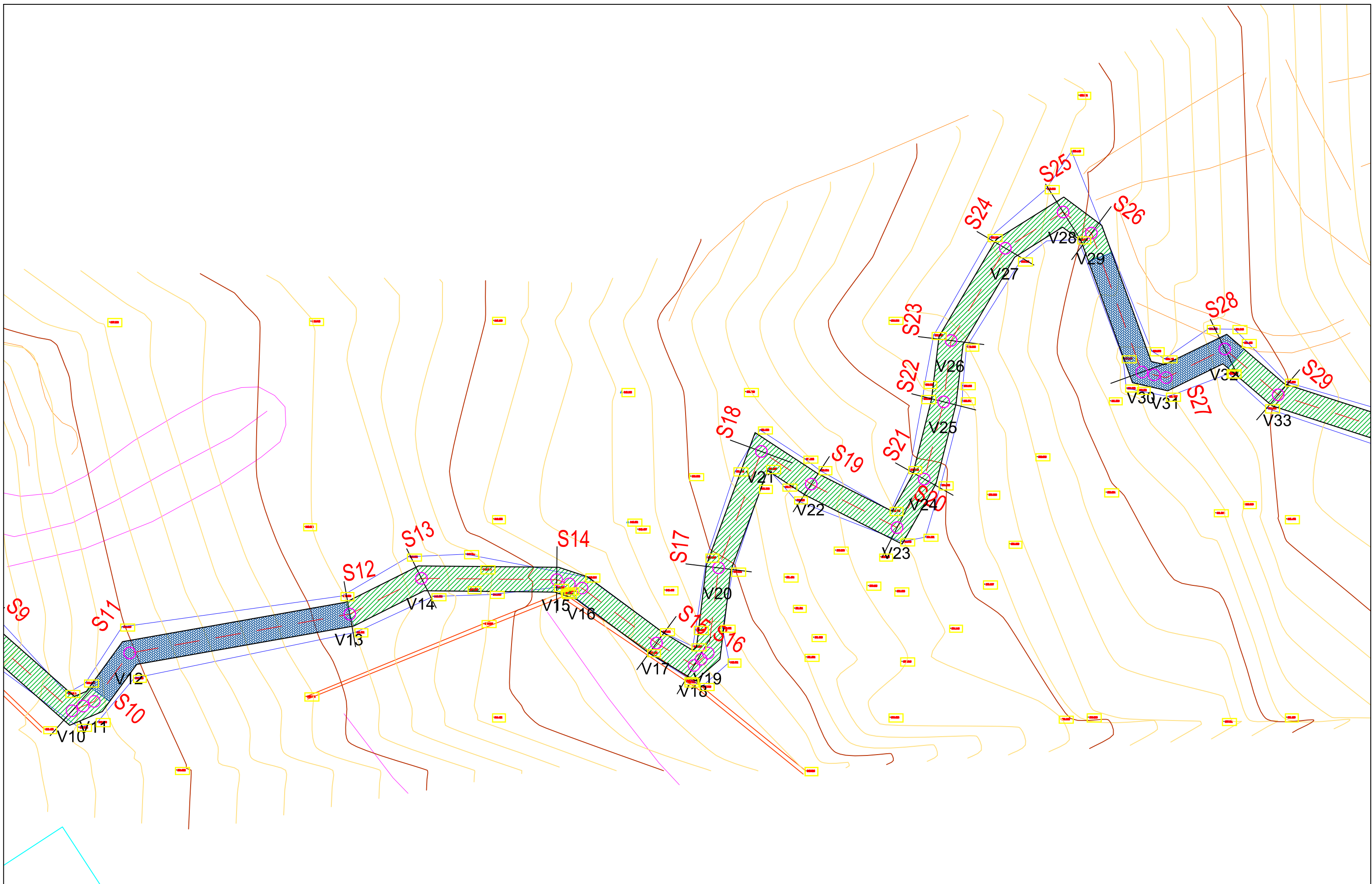

Autoriteit Kontraktor : BASHKIA KRUJE
Objekti: Rikonstruksion Rruga Kembesore "Kruje - Sarisalltik"

Emertimi: PLANIMETRIA E RRUGES
 "ERALD-G" Sh.p.k
 Adresa: Rruga "Koli Bano", Tirane



Drejtesues i projektit
 Inxh. Gezim ISLAMI

Projektues
 Inxh. Aldo MERKAJ
 Ark.Elton Çarçani
 Hidr. Ersida VERÇANI
 Elek. Hajdar KURTI
 Mek. Arben MUHA

SHKALLA
 SHK 1:500
 Tiranë 2017
FLETA
 1 -02
 Format A3

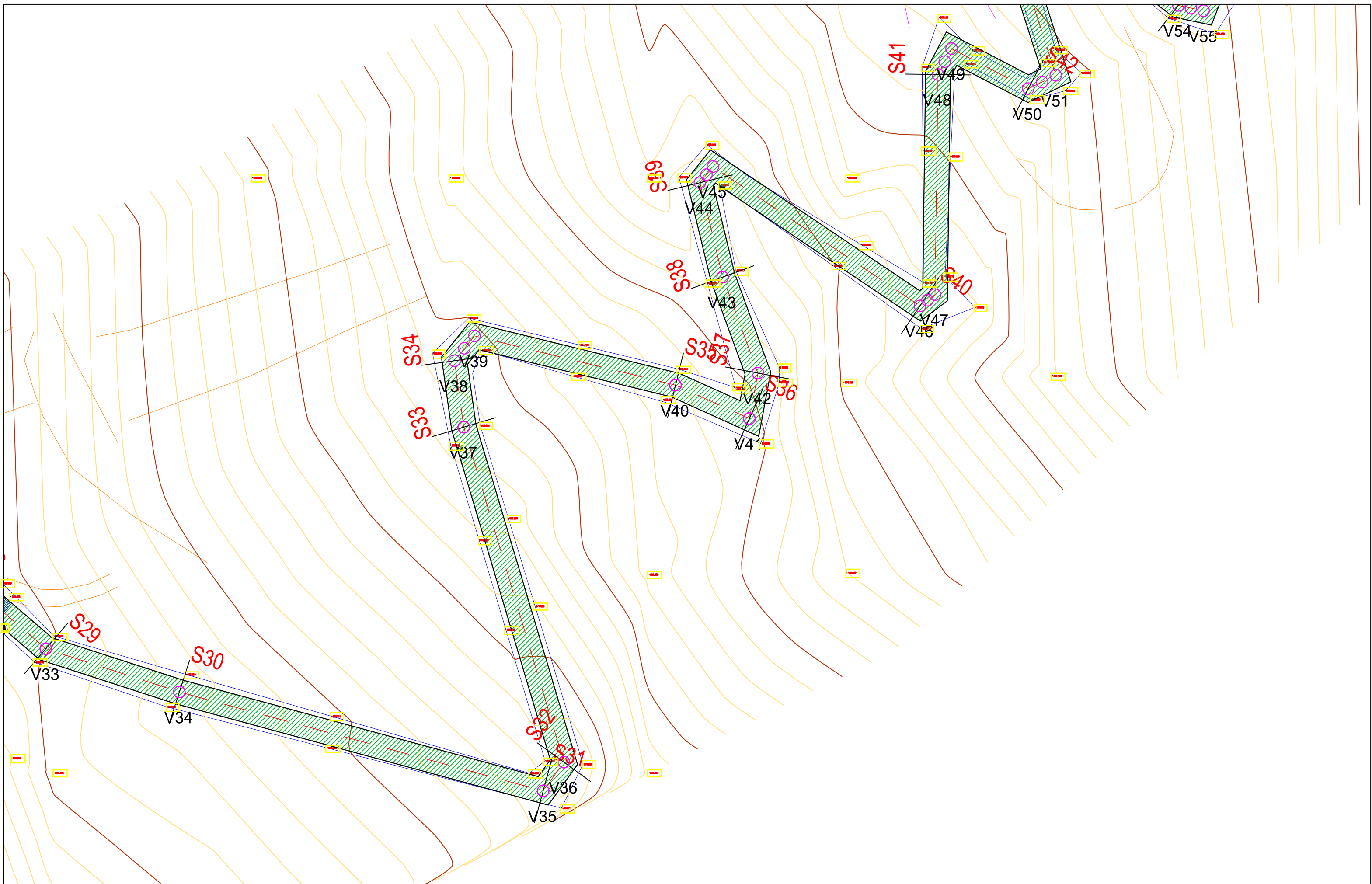

Autoriteit Kontraktor : BASHKIA KRUJE
Objekti: Rikonstruksion Rruga Kembesore "Kruje - Sarisalltik"

Emertimi: PLANIMETRIA E RRUGES
 "ERALD-G" Sh.p.k
 Adresa: Rruga "Koli Bano", Tirane



Drejtes i projektit
 Inxh. Gezim ISLAMI

Projektues	
Inxh. Aldo MERKAJ	Elek. Hajdar KURTI
Ark.Elton Çarçani	Mek. Arben MUHA
Hidr. Ersida VERÇANI	

SHKALLA	FLETA
SHK 1:500	1 -03
Tiranë 2017	Format A3

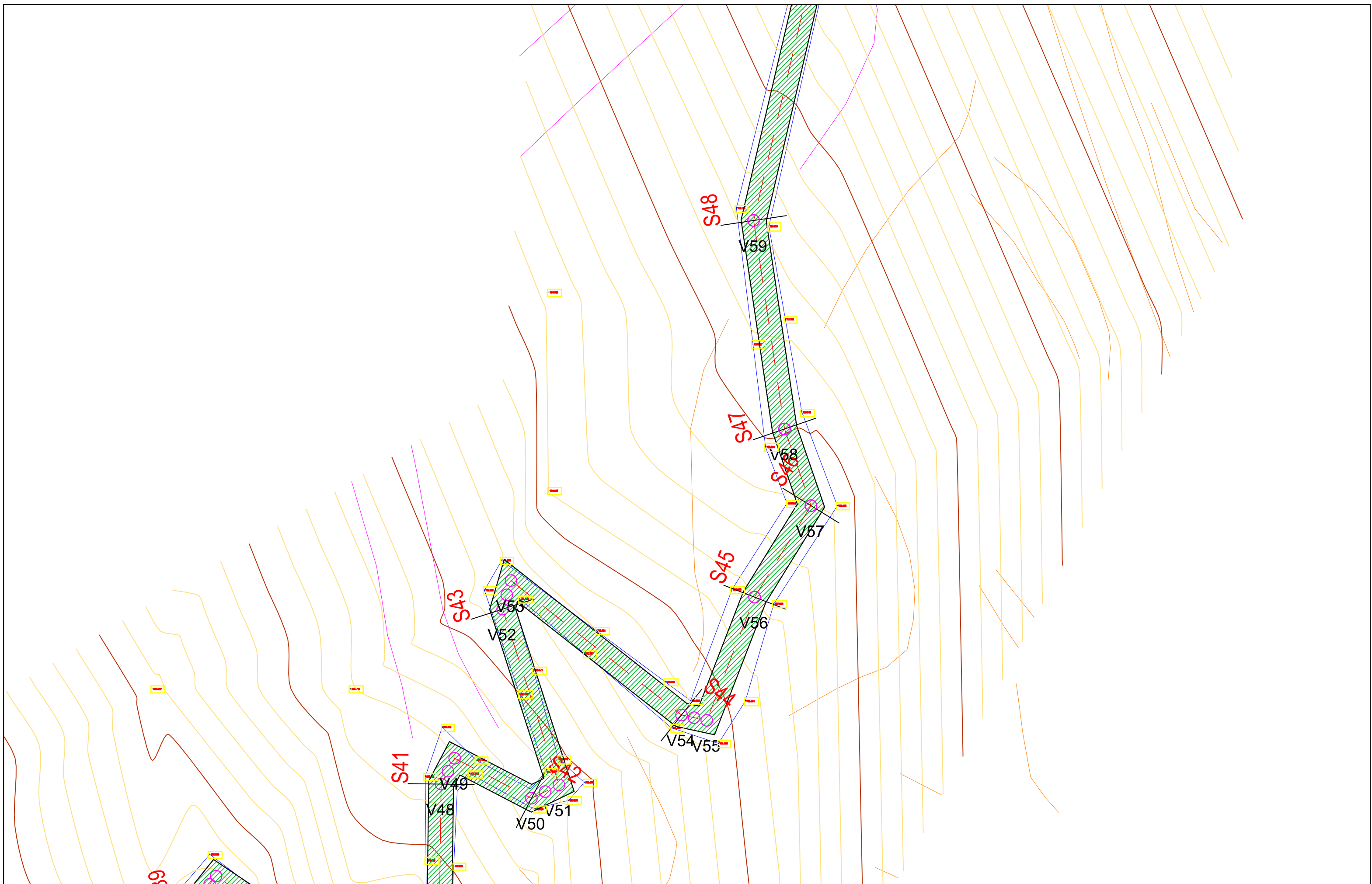

Autoriteit Kontraktor : BASHKIA KRUJE

Objekti: Rikonstruksion Rruga Kembesore "Kruje - Sarisalltik"

Emertimi: PLANIMETRIA E RRUGES



"ERALD-G" Sh.p.k
Adresa: Rruga "Koli Bano", Tirane

Drejtes i projektit

Inxh. Gezim ISLAMI

Projektues

Inxh. Aldo MERKAJ
Ark.Elton Çarçani
Hidr. Ersida VERÇANI

Elek. Hajdar KURTI
Mek. Arben MUHA

SHKALLA

SHK 1:500

Tiranë 2017

FLETA

1 -04

Format A3

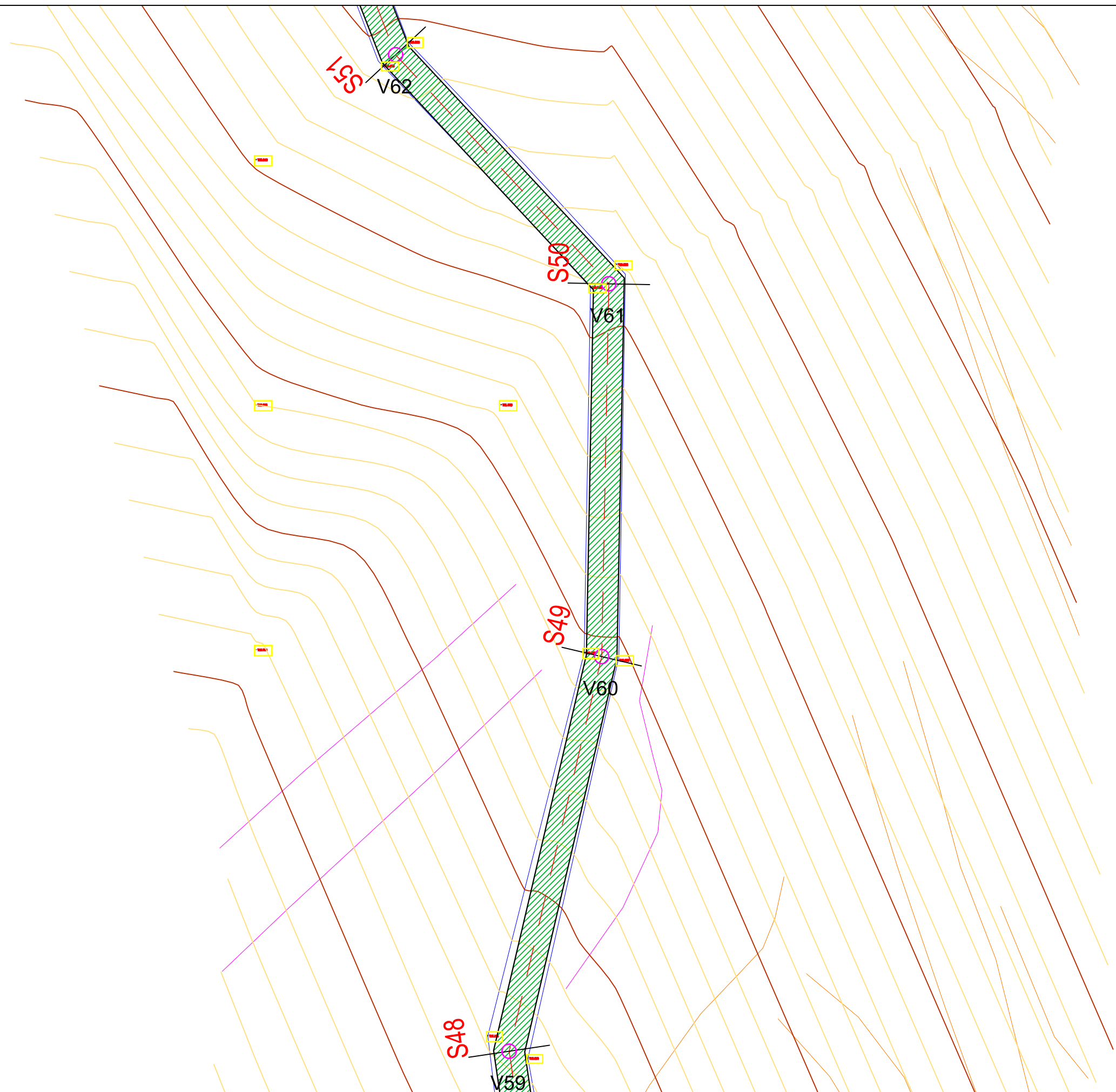

Autoriteit Kontraktor : BASHKIA KRUJE

Objekti: Rikonstruksion Rruga Kembesore "Kruje - Sarisalltik"

Emertimi: PLANIMETRIA E RRUGES



"ERALD-G" Sh.p.k
Adresa: Rruga "Koli Bano", Tirane

Drejtuës i projektit

Inxh. Gezim ISLAMI

Projektues

Inxh. Aldo MERKAJ
Ark.Elton Çarçani
Hidr. Ersida VERÇANI

Elek. Hajdar KURTI
Mek. Arben MUHA

SHKALLA

SHK 1:500

Tiranë 2017

FLETA

1 -05

Format A3

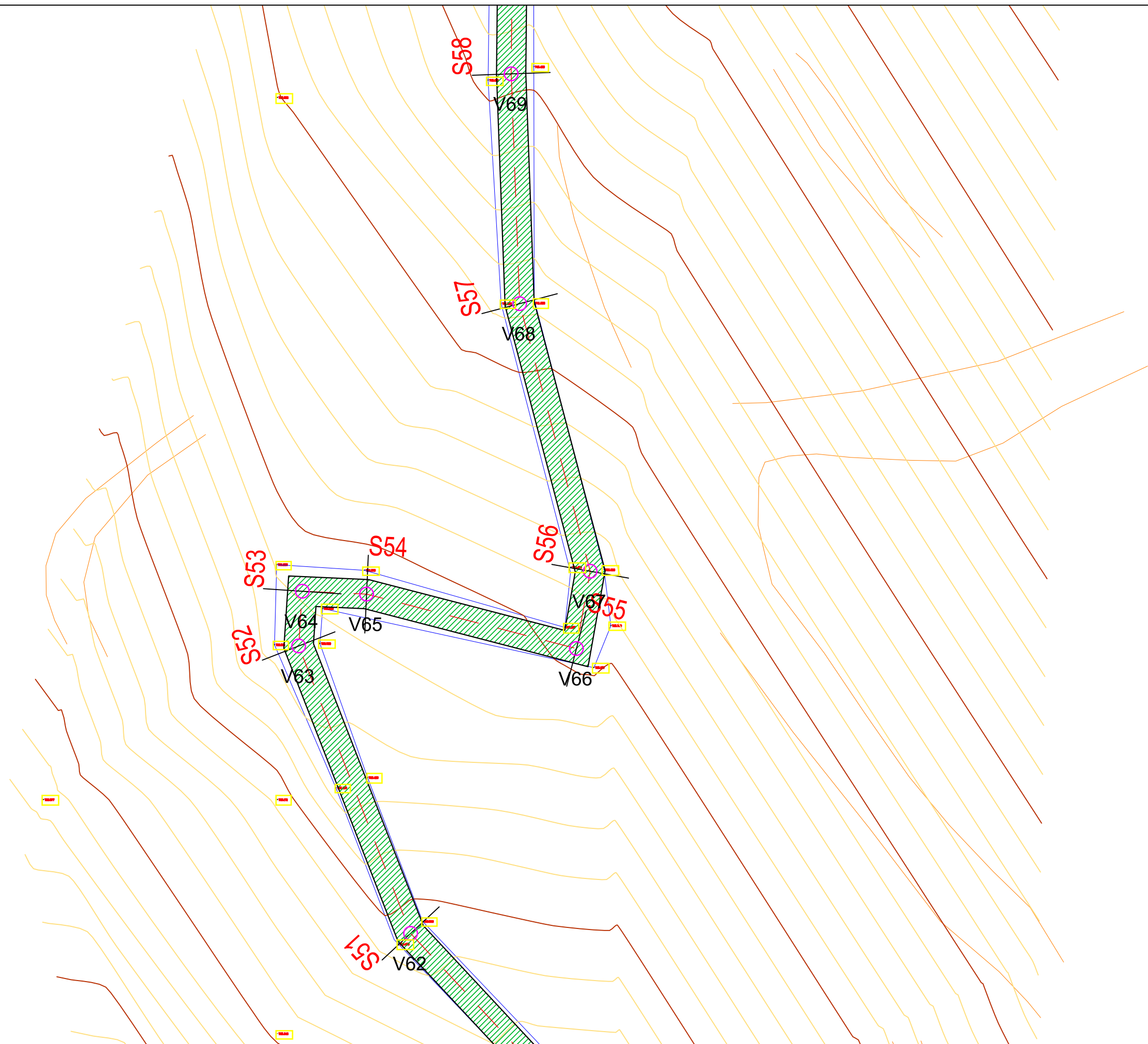

Autoriteit Kontraktor : BASHKIA KRUIJE

Objekti: Rikonstruksion Rruga Kembesore "Kruje - Sarisalltik"

Emertimi: PLANIMETRIA E RRUGES



"ERALD-G" Sh.p.k
Adresa: Rruga "Koli Bano", Tirane

Drejtes i projektit

Inxh. Gezim ISLAMI

Projektues

Inxh. Aldo MERKAJ
Ark.Elton Çarçani
Hidr. Ersida VERÇANI

Elek. Hajdar KURTI
Mek. Arben MUHA

SHKALLA

SHK 1:500

Tiranë 2017

FLETA

1 -06

Format A3

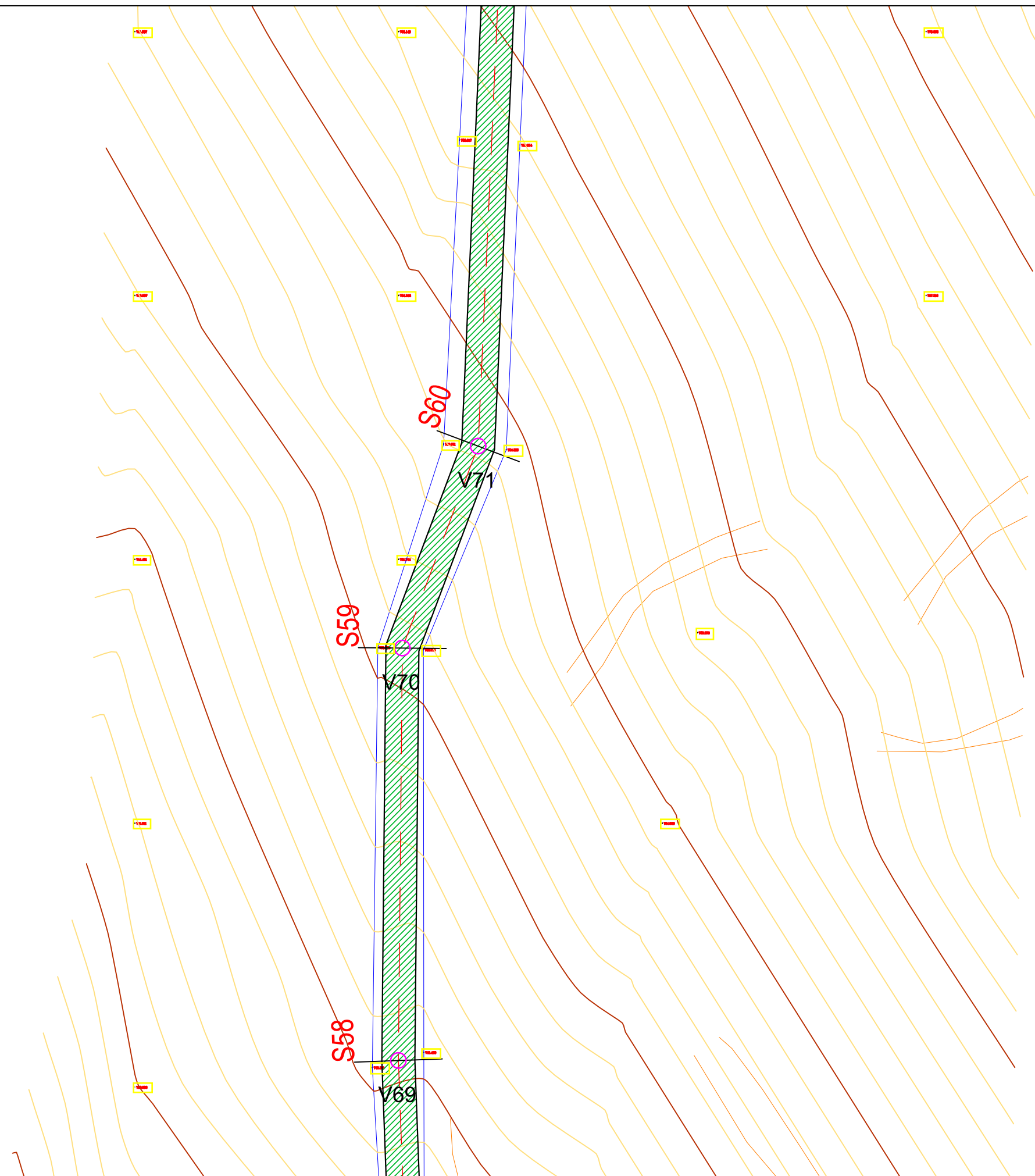

Autoriteit Kontraktor : BASHKIA KRUJE

Objekti: Rikonstruksion Rruga Kembesore "Kruje - Sarisalltik"

Emertimi: PLANIMETRIA E RRUGES



"ERALD-G" Sh.p.k
Adresa: Rruga "Koli Bano", Tirane

Drejtuës i projektit

Inxh. Gezim ISLAMI

Projektues

Inxh. Aldo MERKAJ
Ark.Elton Çarçani
Hidr. Ersida VERÇANI

Elek. Hajdar KURTI
Mek. Arben MUHA

SHKALLA

SHK 1:500

Tiranë 2017

FLETA

1 -07

Format A3

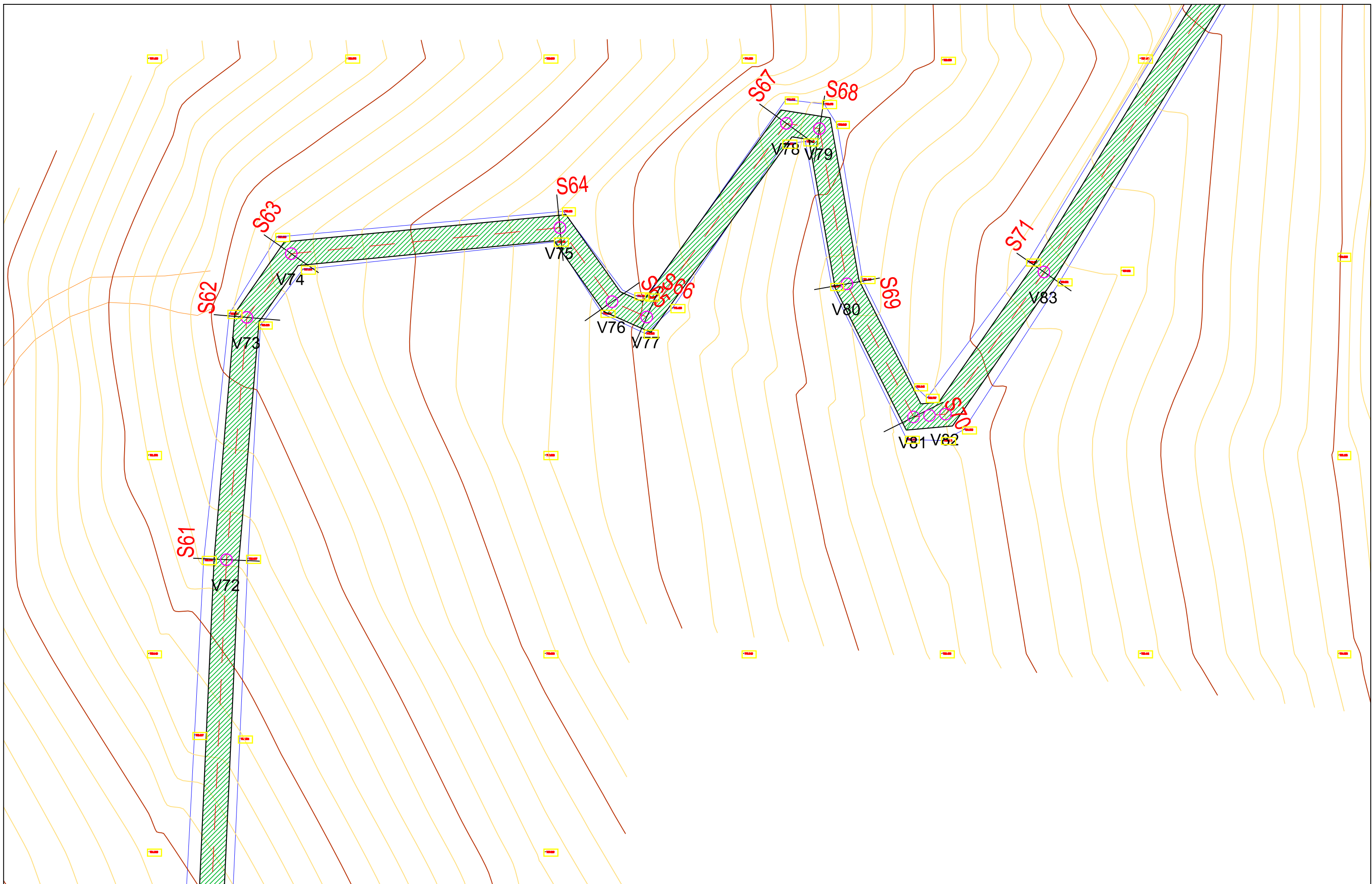

Autoriteit Kontraktor : BASHKIA KRUJE

Objekti: Rikonstruksion Rruga Kembesore "Kruje - Sarisalltik"

Emertimi: PLANIMETRIA E RRUGES



"ERALD-G" Sh.p.k
Adresa: Rruga "Koli Bano", Tirane

Drejtesues i projektit

Inxh. Gezim ISLAMI

Projektues

Inxh. Aldo MERKAJ
Ark. Elton Çarçani
Hidr. Ersida VERÇANI

Elek. Hajdar KURTI
Mek. Arben MUHA

SHKALLA

SHK 1:500

Tiranë 2017

FLETA

1 -08

Format A3

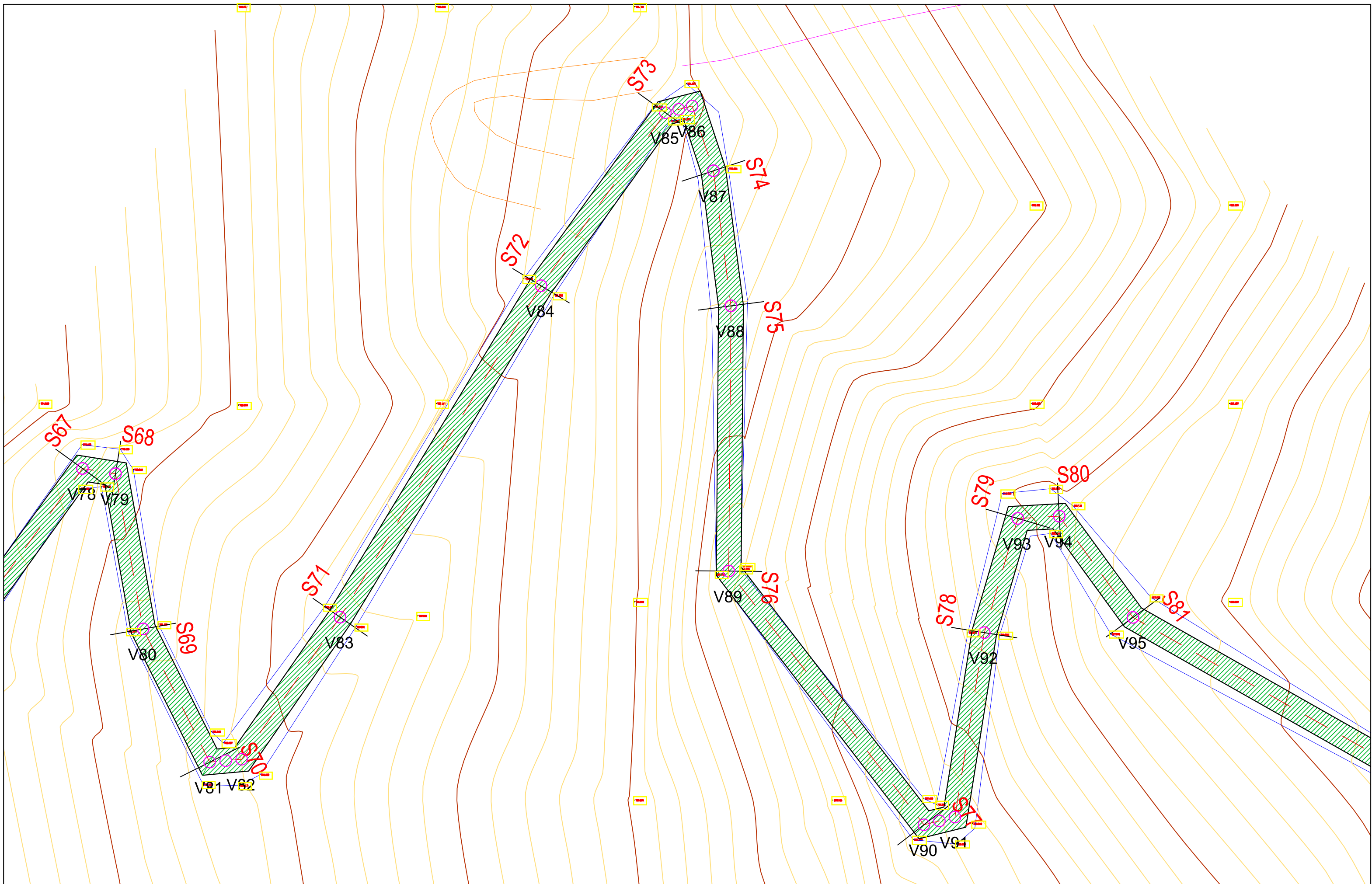

Autoriteit Kontraktor : BASHKIA KRUJE
 Objekti: Rikonstruksion Rruga Kembesore "Kruje - Sarisalltik"

Emertimi: PLANIMETRIA E RRUGES
 "ERALD-G" Sh.p.k
 Adresa: Rruga "Koli Bano", Tirane



Drejtes i projektit
 Inxh. Gezim ISLAMI

Projektues
 Inxh. Aldo MERKAJ
 Ark.Elton Çarçani
 Hidr. Ersida VERÇANI
 Elek. Hajdar KURTI
 Mek. Arben MUHA

SHKALLA	FLETA
SHK 1:500	1 -09
Tiranë 2017	Format A3

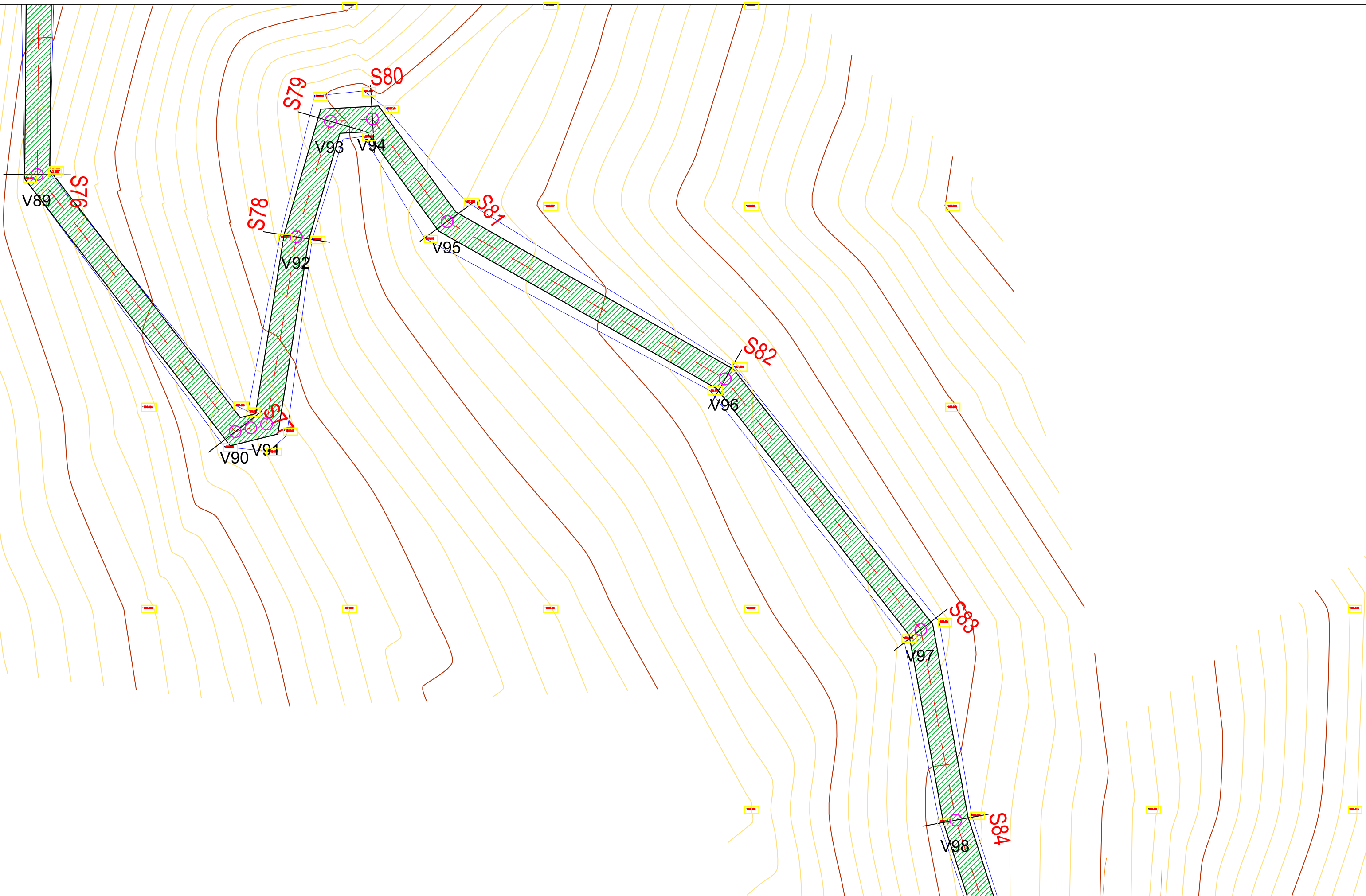

Autoriteit Kontraktor : BASHKIA KRUIJE

Objekti: Rikonstruksion Rruga Kembesore "Kruje - Sarisalltik"

Emertimi: PLANIMETRIA E RRUGES



"ERALD-G" Sh.p.k
Adresa: Rruga "Koli Bano", Tirane

Drejtues i projektit

Inxh. Gezim ISLAMI

Projektues

Inxh. Aldo MERKAJ
Ark.Elton Çarçani
Hidr. Ersida VERÇANI

Elek. Hajdar KURTI
Mek. Arben MUHA

SHKALLA

SHK 1:500

Tiranë 2017

FLETA

1 -10

Format A3

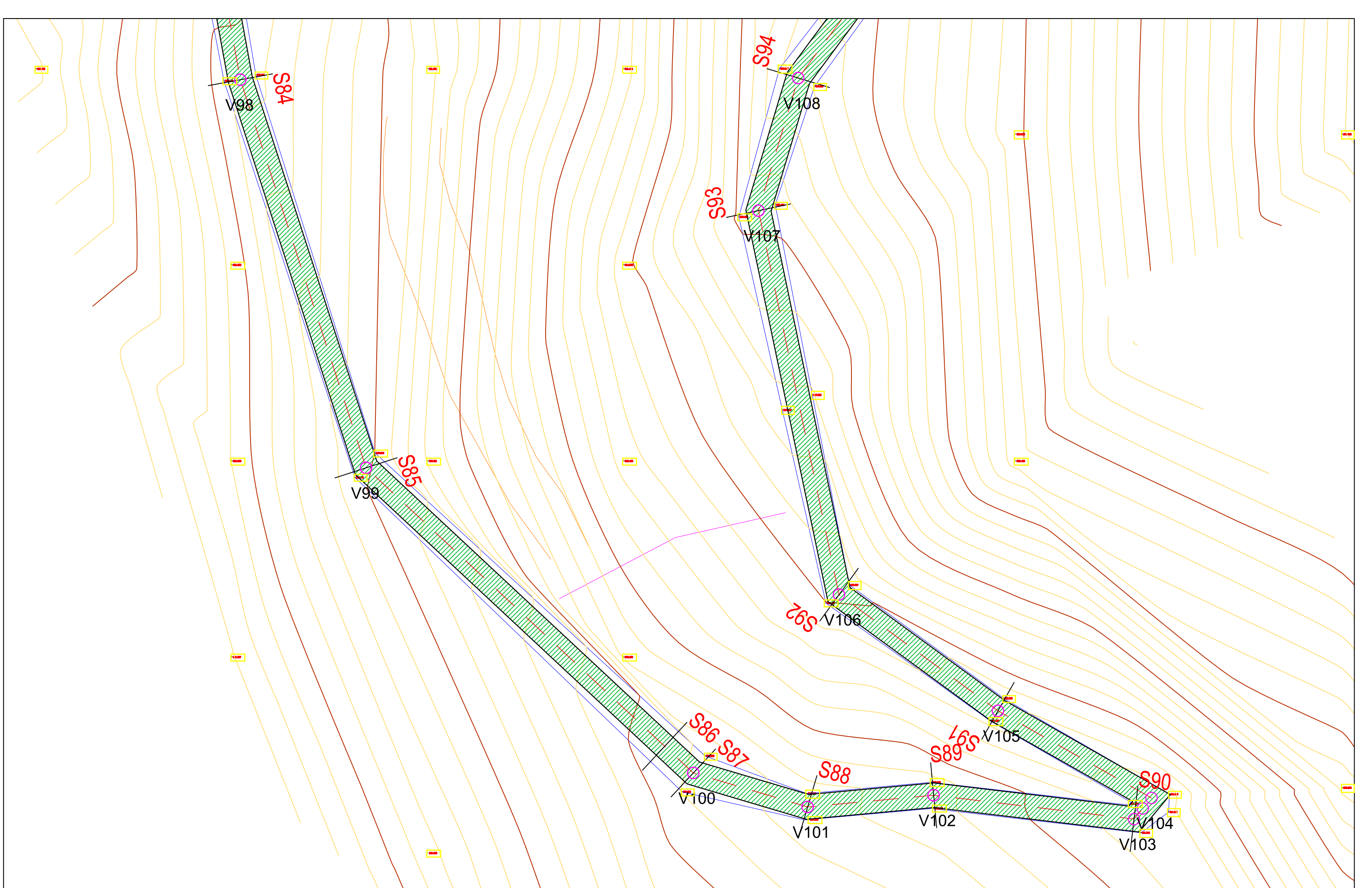

Autoriteit Kontraktor : BASHKIA KRUIJE

Objekti: Rikonstruksion Rruga Kembesore "Kruje - Sarisalltik"

Emertimi: PLANIMETRIA E RRUGES



"ERALD-G" Sh.p.k
Adresa: Rruga "Koli Bano", Tirane

Drejtues i projektit

Inxh. Gezim ISLAMI

Projektues

Inxh. Aldo MERKAJ
Ark.Elton Çarçani
Hidr. Ersida VERÇANI

Elek. Hajdar KURTI
Mek. Arben MUHA

SHKALLA

SHK 1:500

Tiranë 2017

FLETA

1 -11

Format A3

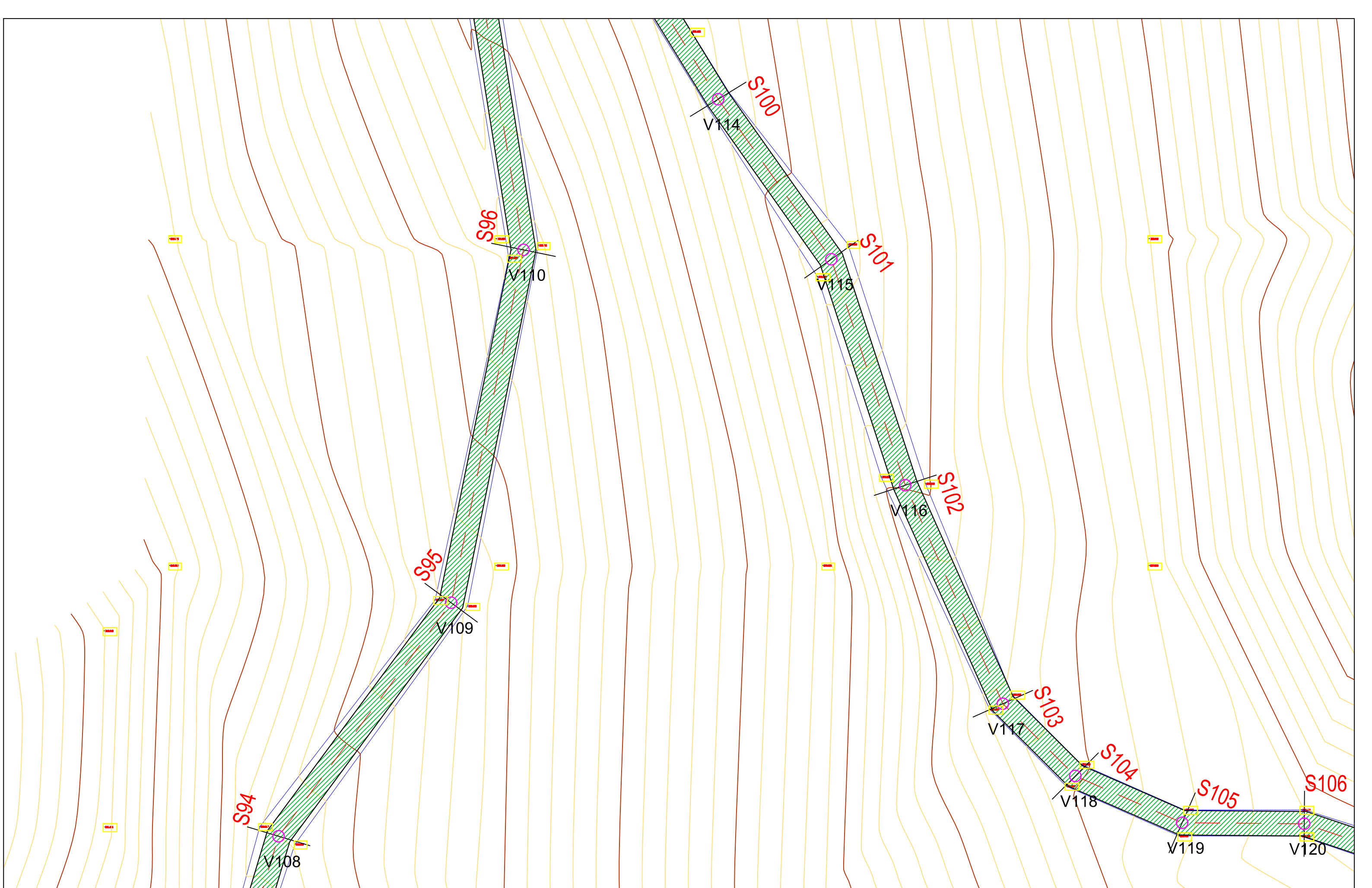

Autoriteit Kontraktor : BASHKIA KRUJE
Objekti: Rikonstruksion Rruga Kembesore "Kruje - Sarisalltik"

Emertimi: PLANIMETRIA E RRUGES
 "ERALD-G" Sh.p.k
 Adresa: Rruga "Koli Bano", Tirane

Drejtes i projektit
 Inxh. Gezim ISLAMI

Projektues
 Inxh. Aldo MERKAJ
 Ark.Elton Çarçani
 Hidr. Ersida VERÇANI
 Elek. Hajdar KURTI
 Mek. Arben MUHA

SHKALLA	FLETA
SHK 1:500	1 -12
Tiranë 2017	Format A3

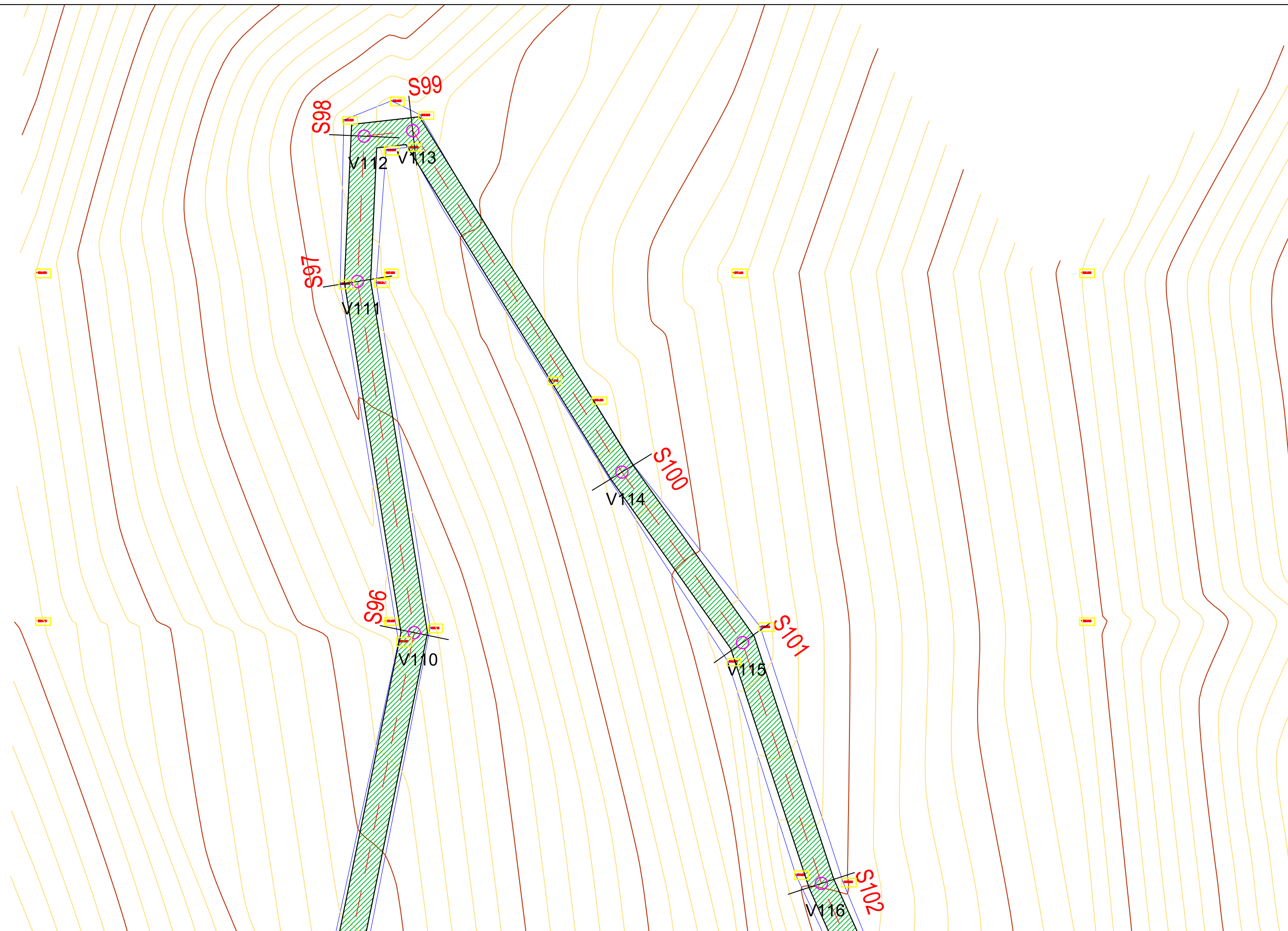

Autoriteit Kontraktor : BASHKIA KRUJE
 Objekti: Rikonstruksion Rruga Kembesore "Kruje - Sarisalltik"

Emertimi: PLANIMETRIA E RRUGES
 "ERALD-G" Sh.p.k
 Adresa: Rruga "Koli Bano", Tirane

Drejtuës i projektit
 Inxh. Gezim ISLAMI

Projektues
 Inxh. Aldo MERKAJ
 Ark.Elton Çarçani
 Hidr. Ersida VERÇANI
 Elek. Hajdar KURTI
 Mek. Arben MUHA

SHKALLA	FLETA
SHK 1:500	1 -13
Tiranë 2017	Format A3

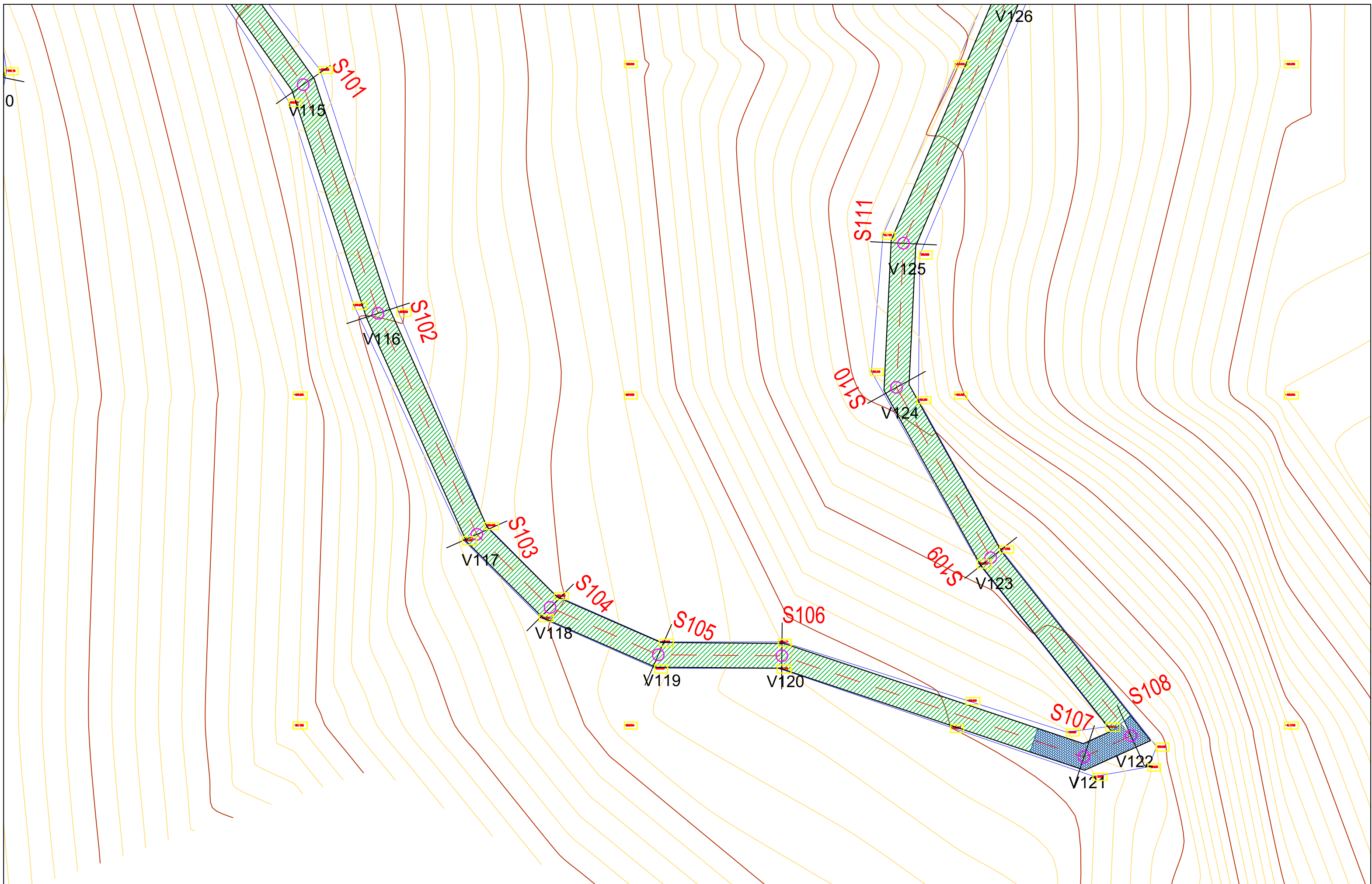

Autoriteit Kontraktor : BASHKIA KRUJE
Objekti: Rikonstruksion Rruga Kembesore "Kruje - Sarisalltik"

Emertimi: PLANIMETRIA E RRUGES

 "ERALD-G" Sh.p.k
 Adresa: Rruga "Koli Bano", Tirane

Drejtuës i projektit
 Inxh. Gezim ISLAMI

Projektues
 Inxh. Aldo MERKAJ
 Ark.Elton Çarçani
 Hidr. Ersida VERÇANI
 Elek. Hajdar KURTI
 Mek. Arben MUHA

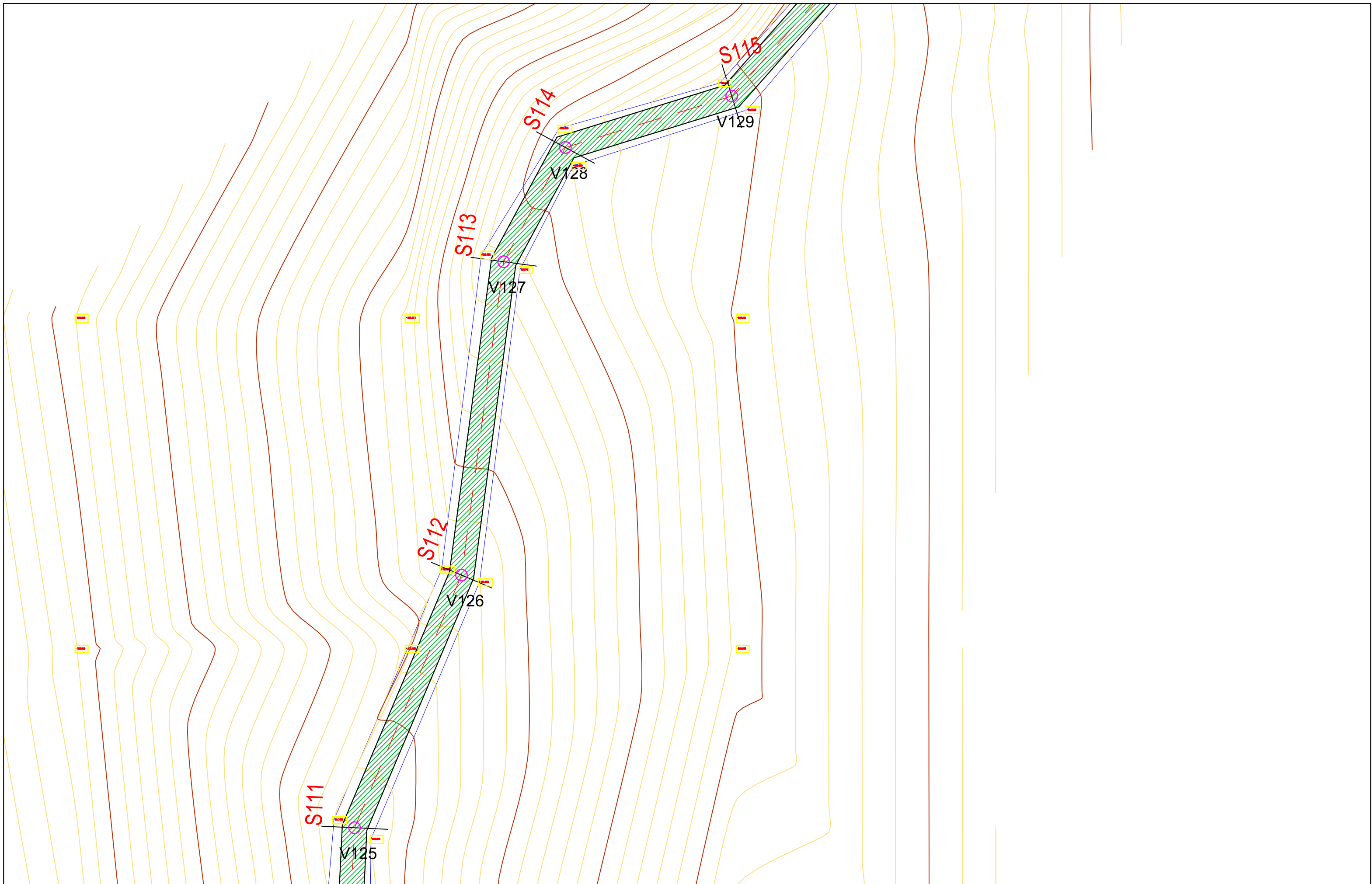
SHKALLA	FLETA
SHK 1:500	1 -14
Tiranë 2017	Format A3



Autoriteit Kontraktor : BASHKIA KRUJE

Objekti: Rikonstruksion Rruga Kembesore "Kruje - Sarisalltik"

Emertimi: PLANIMETRIA E RRUGES



"ERALD-G" Sh.p.k
Adresa: Rruga "Koli Bano", Tirane

Drejtes i projektit

Inxh. Gezim ISLAMI

Projektues

Inxh. Aldo MERKAJ
Ark.Elton Çarçani
Hidr. Ersida VERÇANI

Elek. Hajdar KURTI
Mek. Arben MUHA

SHKALLA

SHK 1:500

Tiranë 2017

FLETA

1 -15

Format A3

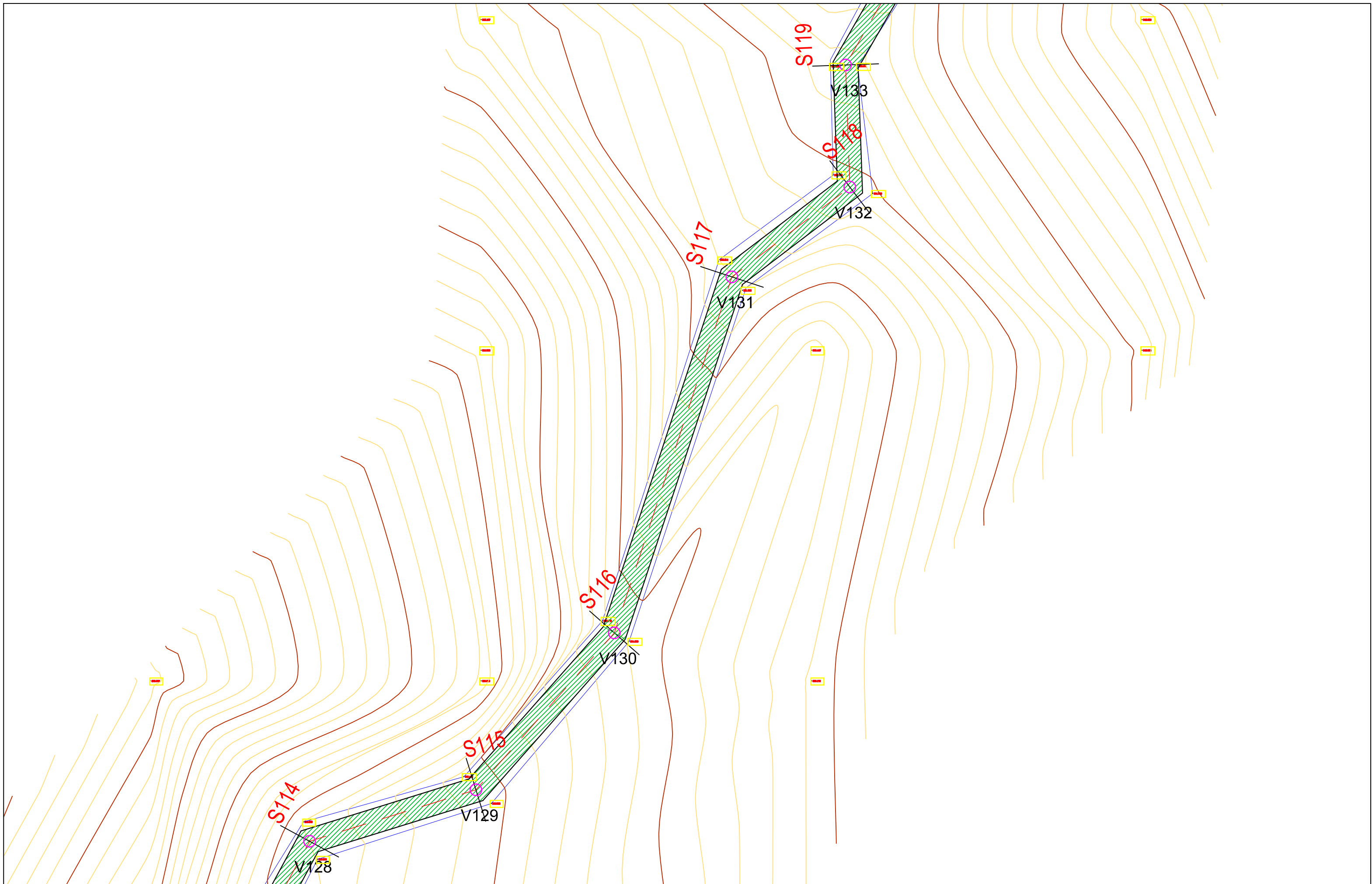

Autoriteit Kontraktor : BASHKIA KRUJE
 Objekti: Rikonstruksion Rruga Kembesore "Kruje - Sarisalltik"

Emertimi: PLANIMETRIA E RRUGES
 "ERALD-G" Sh.p.k
 Adresa: Rruga "Koli Bano", Tirane

Drejtes i projektit
 Inxh. Gezim ISLAMI

Projektues	
Inxh. Aldo MERKAJ	Elek. Hajdar KURTI
Ark.Elton Çarçani	Mek. Arben MUHA
Hidr. Ersida VERÇANI	

SHKALLA	FLETA
SHK 1:500	1 -16
Tiranë 2017	Format A3

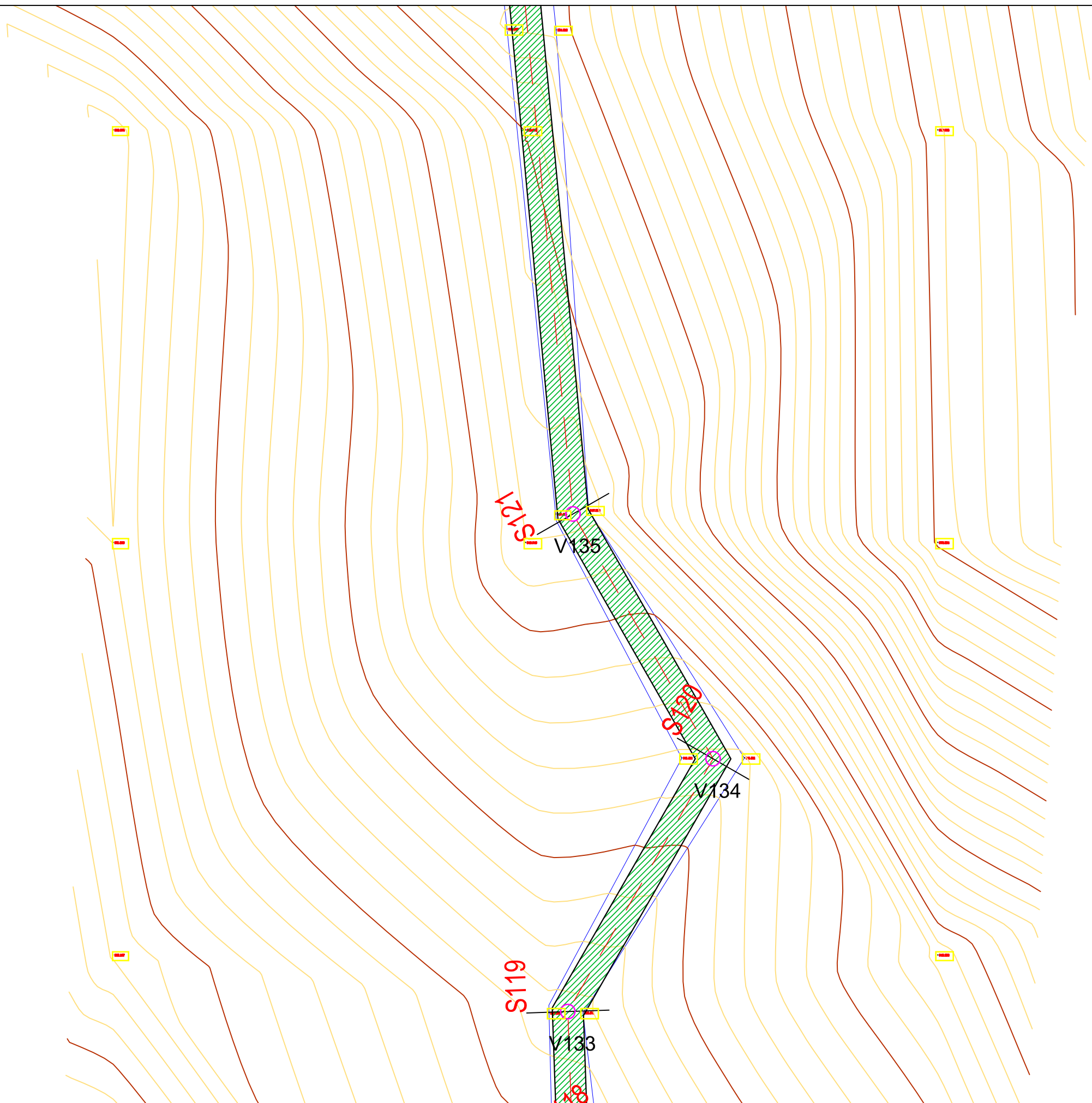

Autoriteit Kontraktor : BASHKIA KRUJE

Objekti: Rikonstruksion Rruga Kembesore "Kruje - Sarisalltik"

Emertimi: PLANIMETRIA E RRUGES



"ERALD-G" Sh.p.k
Adresa: Rruga "Koli Bano", Tirane

Drejtues i projektit

Inxh. Gezim ISLAMI

Projektues

Inxh. Aldo MERKAJ
Ark.Elton Çarçani
Hidr. Ersida VERÇANI

Elek. Hajdar KURTI
Mek. Arben MUHA

SHKALLA

SHK 1:500

Tiranë 2017

FLETA

1 -17

Format A3

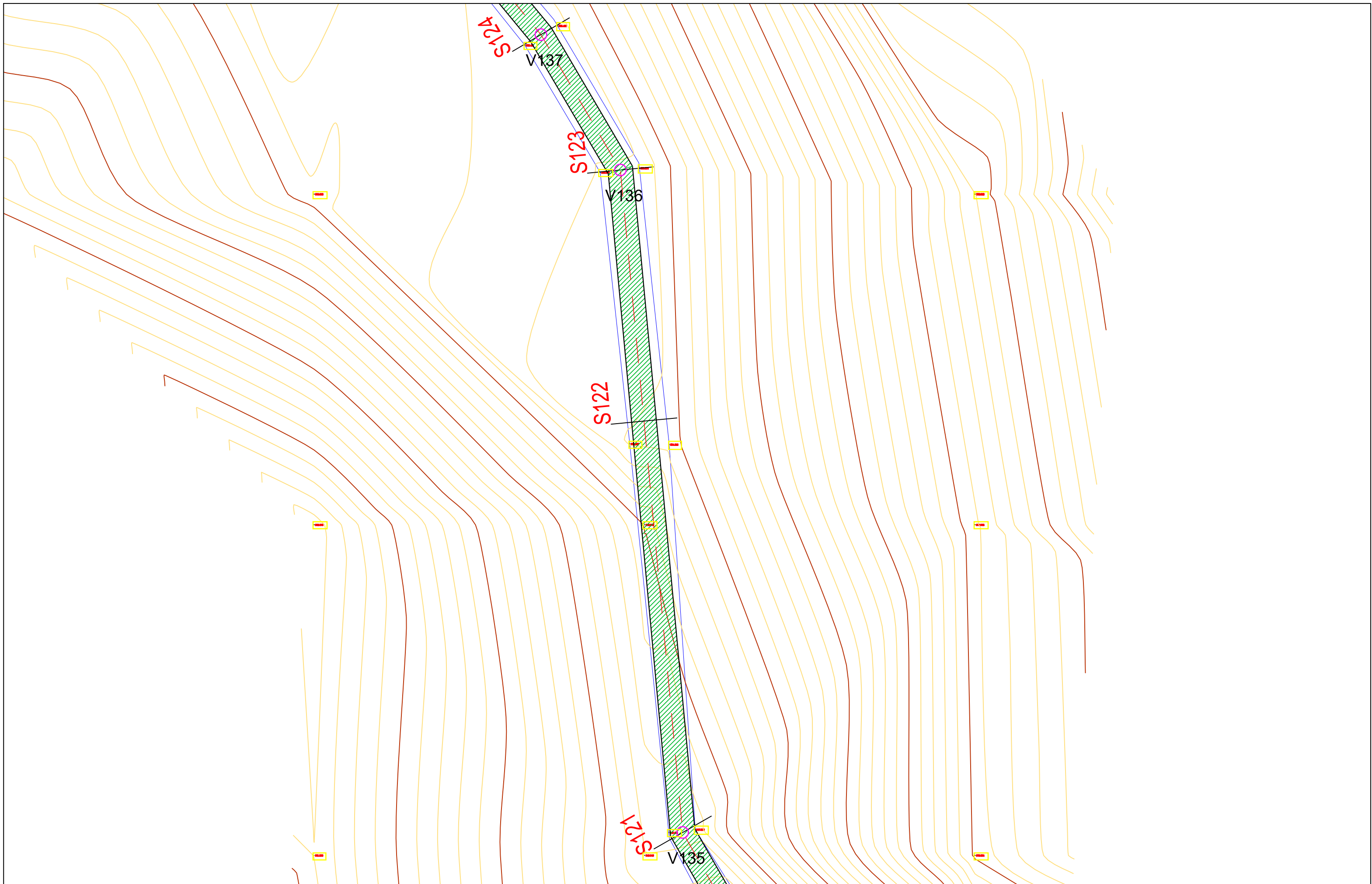

Autoriteit Kontraktor : BASHKIA KRUJE

Objekti: Rikonstruksion Rruga Kembesore "Kruje - Sarisalltik"

Emertimi: PLANIMETRIA E RRUGES



"ERALD-G" Sh.p.k
Adresa: Rruga "Koli Bano", Tirane

Drejtues i projektit

Inxh. Gezim ISLAMI

Projektues

Inxh. Aldo MERKAJ
Ark.Elton Çarçani
Hidr. Ersida VERÇANI

Elek. Hajdar KURTI
Mek. Arben MUHA

SHKALLA

SHK 1:500

Tiranë 2017

FLETA

1 -18

Format A3

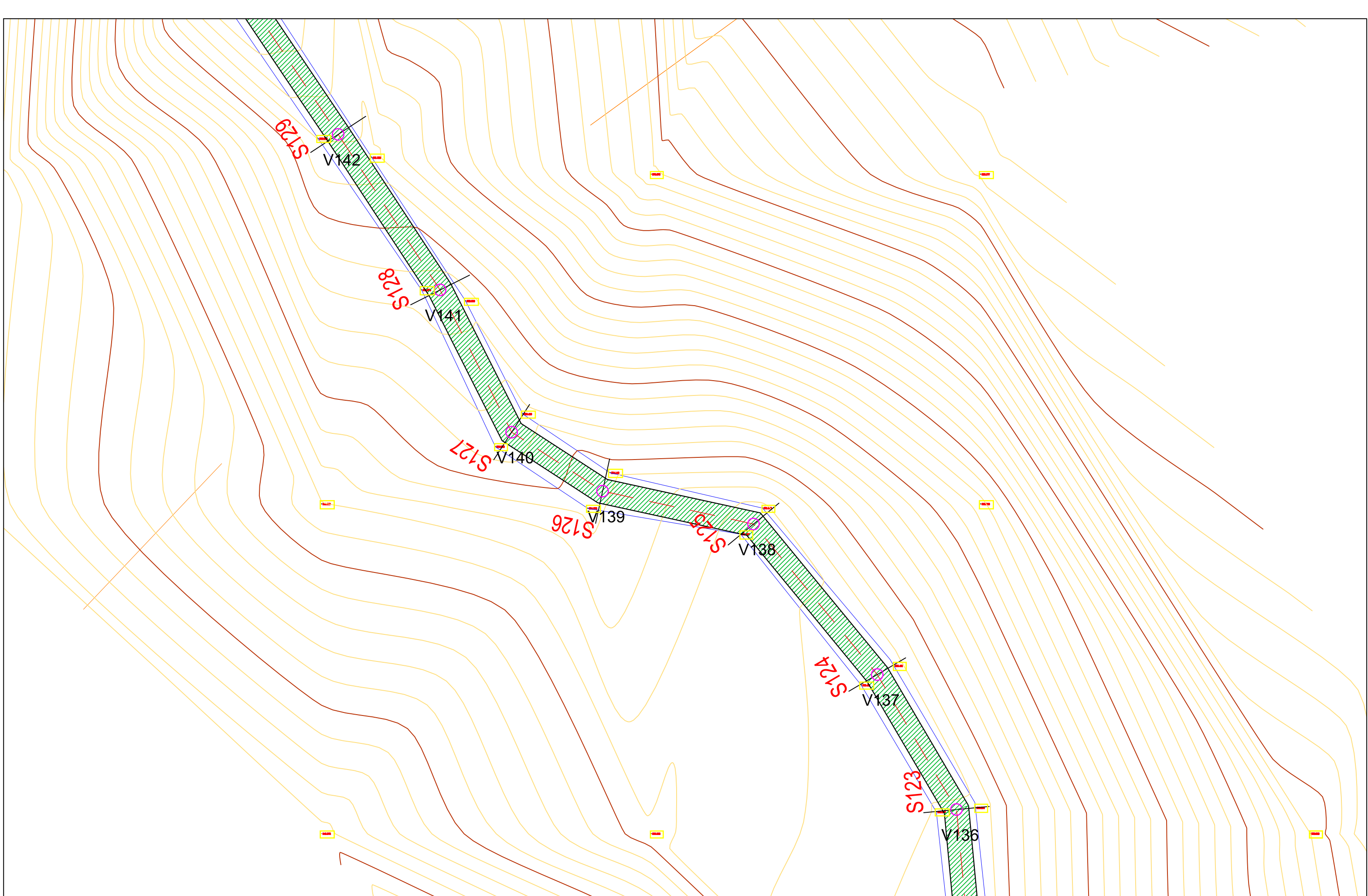

Autoriteit Kontraktor : BASHKIA KRUJE Objekti: Rikonstruksion Rruga Kembesore "Kruje - Sarisalltik"	Emertimi: PLANIMETRIA E RRUGES  "ERALD-G" Sh.p.k Adresa: Rruga "Koli Bano", Tirane	Drejtues i projektit Inxh. Gezim ISLAMI	Projektues Inxh. Aldo MERKAJ Ark.Elton Çarçani Hidr. Ersida VERÇANI		Elek. Hajdar KURTI Mek. Arben MUHA	SHKALLA SHK 1:500 Tiranë 2017	FLETA 1 -19 Format A3

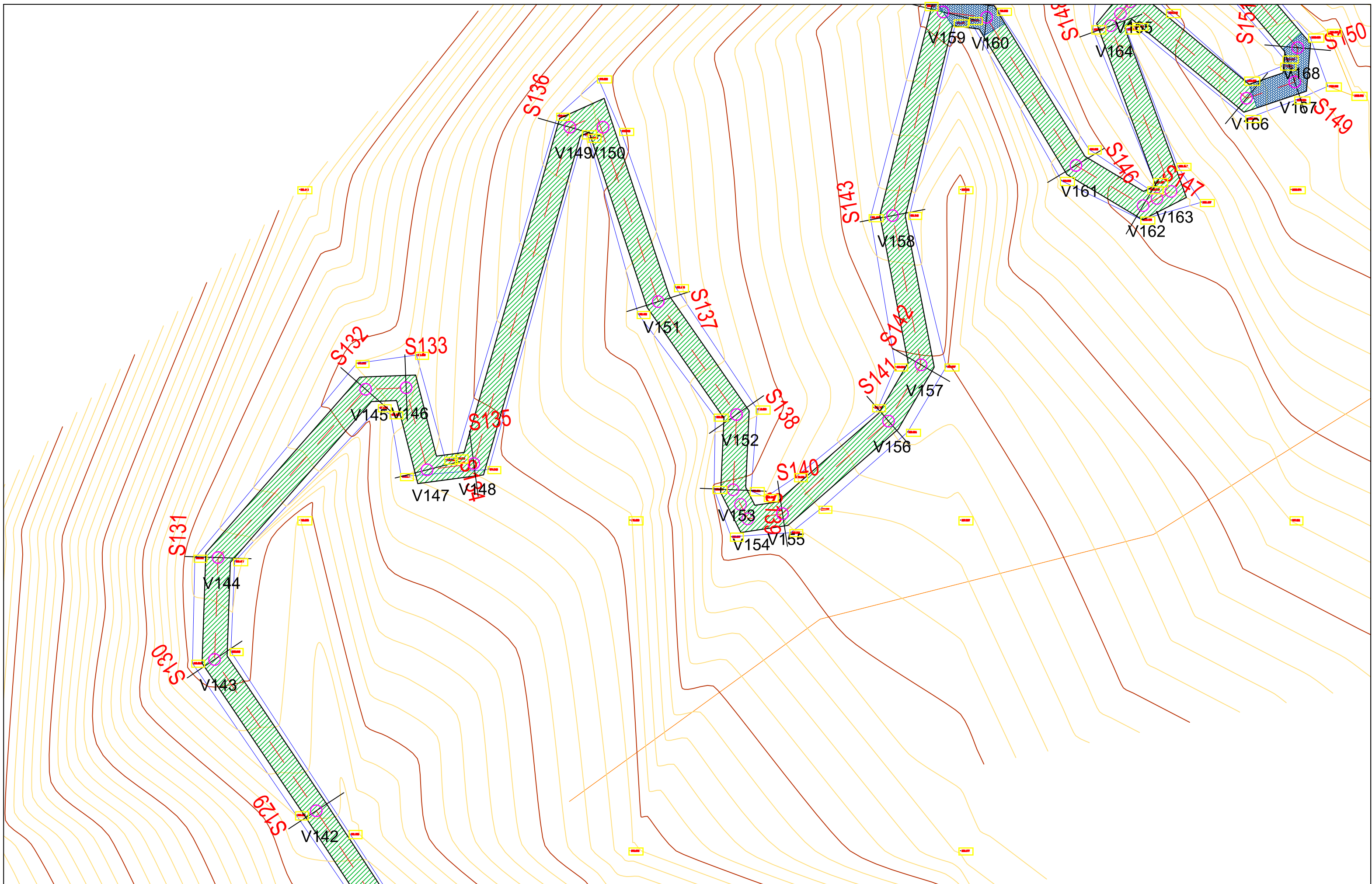

Autoriteit Kontraktor : BASHKIA KRUIJE
 Objekti: Rikonstruksion Rruga Kembesore "Kruje - Sarisalltik"

Emertimi: PLANIMETRIA E RRUGES
 "ERALD-G" Sh.p.k
 Adresa: Rruga "Koli Bano", Tirane



Drejtesues i projektit
 Inxh. Gezim ISLAMI

Projektues
 Inxh. Aldo MERKAJ
 Ark.Elton Çarçani
 Hidr. Ersida VERÇANI
 Elek. Hajdar KURTI
 Mek. Arben MUHA

SHKALLA	FLETA
SHK 1:500	1 -20
Tiranë 2017	Format A3

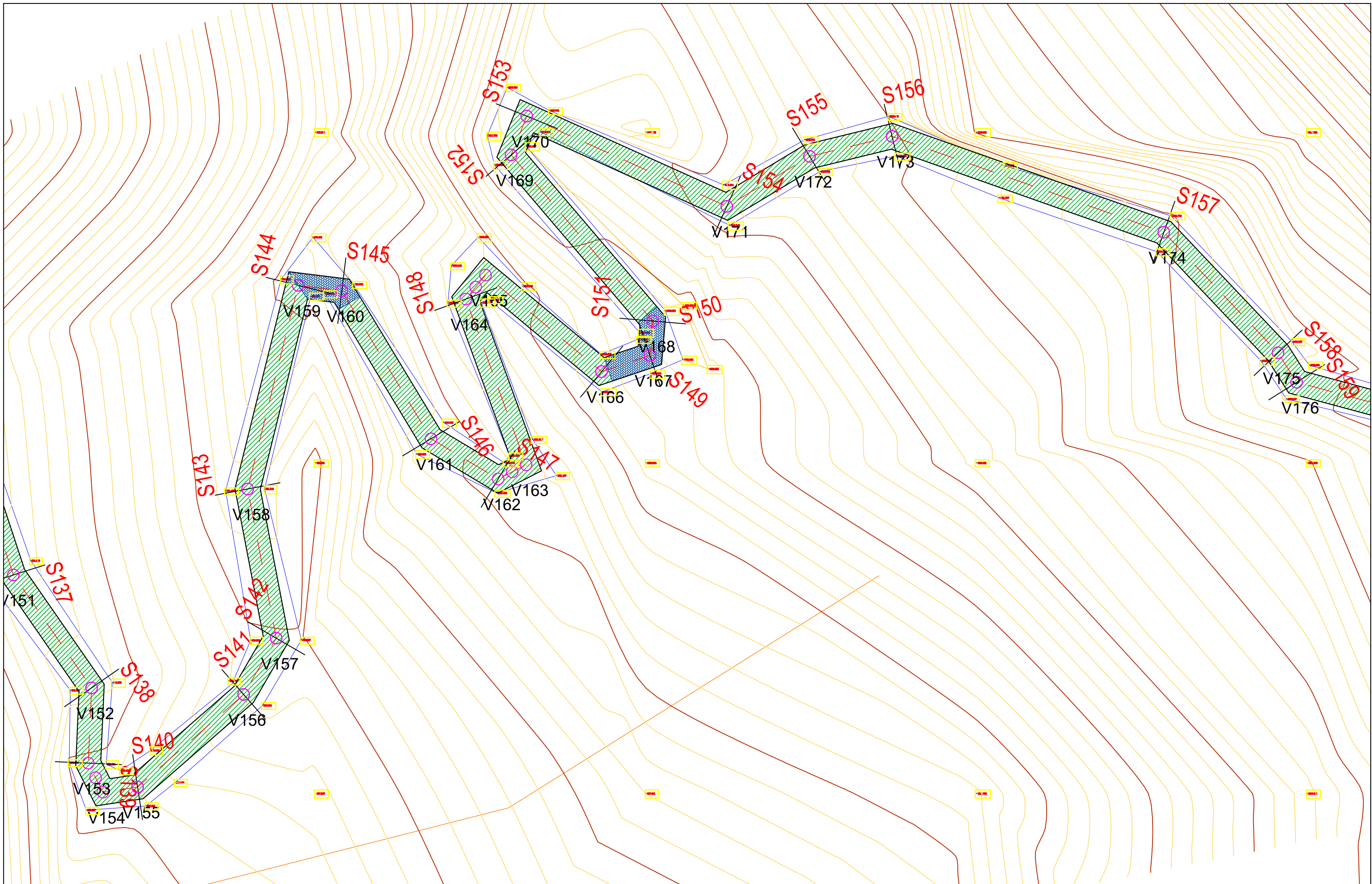

Autoriteit Kontraktor : BASHKIA KRUJE
 Objekti: Rikonstrukcion Rruga Kembesore "Kruje - Sarisalltik"

Emertimi: PLANIMETRIA E RRUGES
 "ERALD-G" Sh.p.k
 Adresa: Rruga "Koli Bano", Tirane



Drejtes i projektit
 Inxh. Gezim ISLAMI

Projektues
 Inxh. Aldo MERKAJ
 Ark.Elton Çarçani
 Hidr. Ersida VERÇANI
 Elek. Hajdar KURTI
 Mek. Arben MUHA

SHKALLA	FLETA
SHK 1:500	1 -21
Tiranë 2017	Format A3

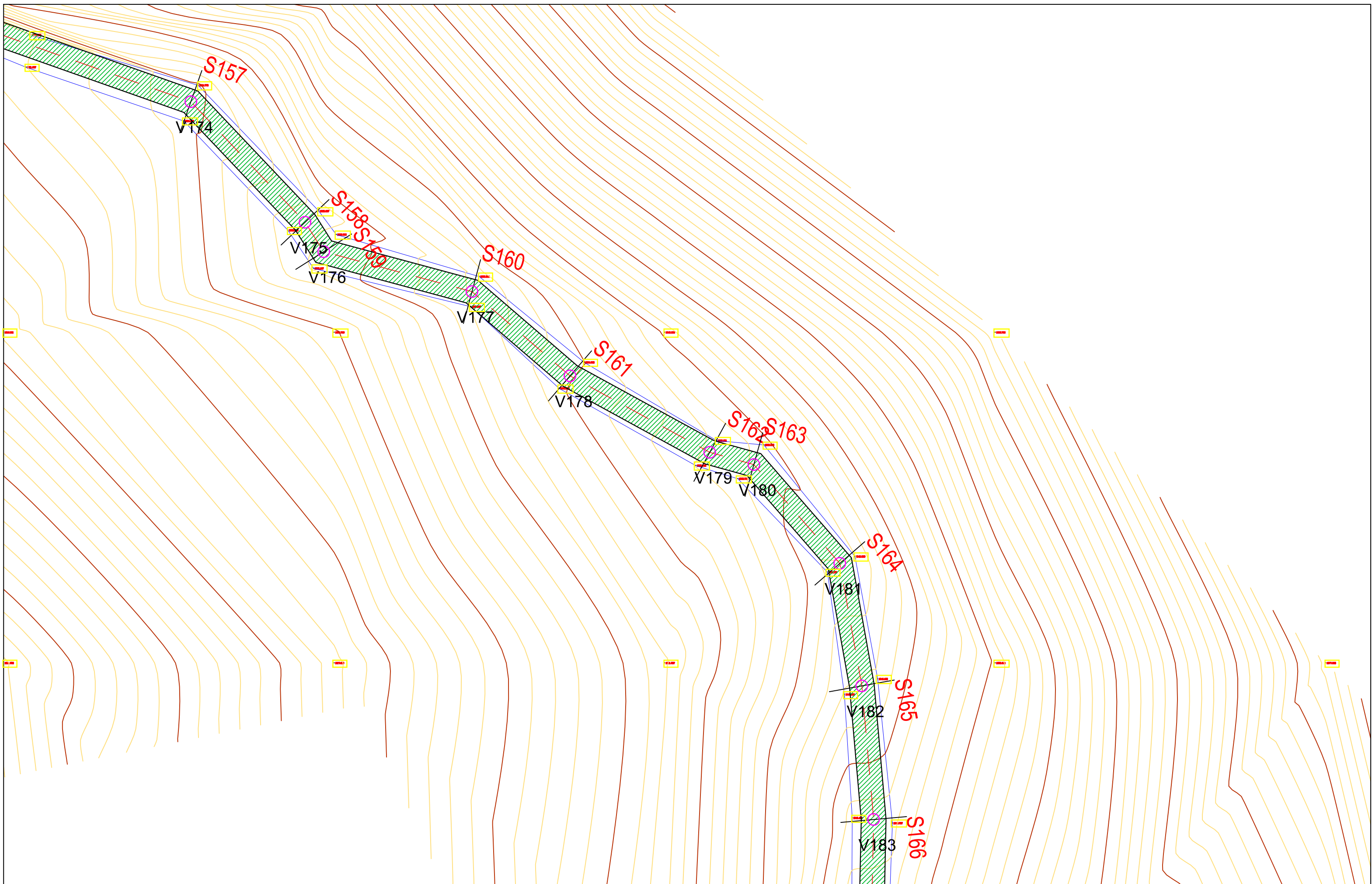

Autoriteit Kontraktor : BASHKIA KRUJE
Objekti: Rikonstruksion Rruga Kembesore "Kruje - Sarisalltik"

Emertimi: PLANIMETRIA E RRUGES

 "ERALD-G" Sh.p.k
 Adresa: Rruga "Koli Bano", Tirane

Drejtesues i projektit
 Inxh. Gezim ISLAMI

Projektues

Inxh. Aldo MERKAJ	Elek. Hajdar KURTI
Ark.Elton Çarçani	Mek. Arben MUHA
Hidr. Ersida VERÇANI	

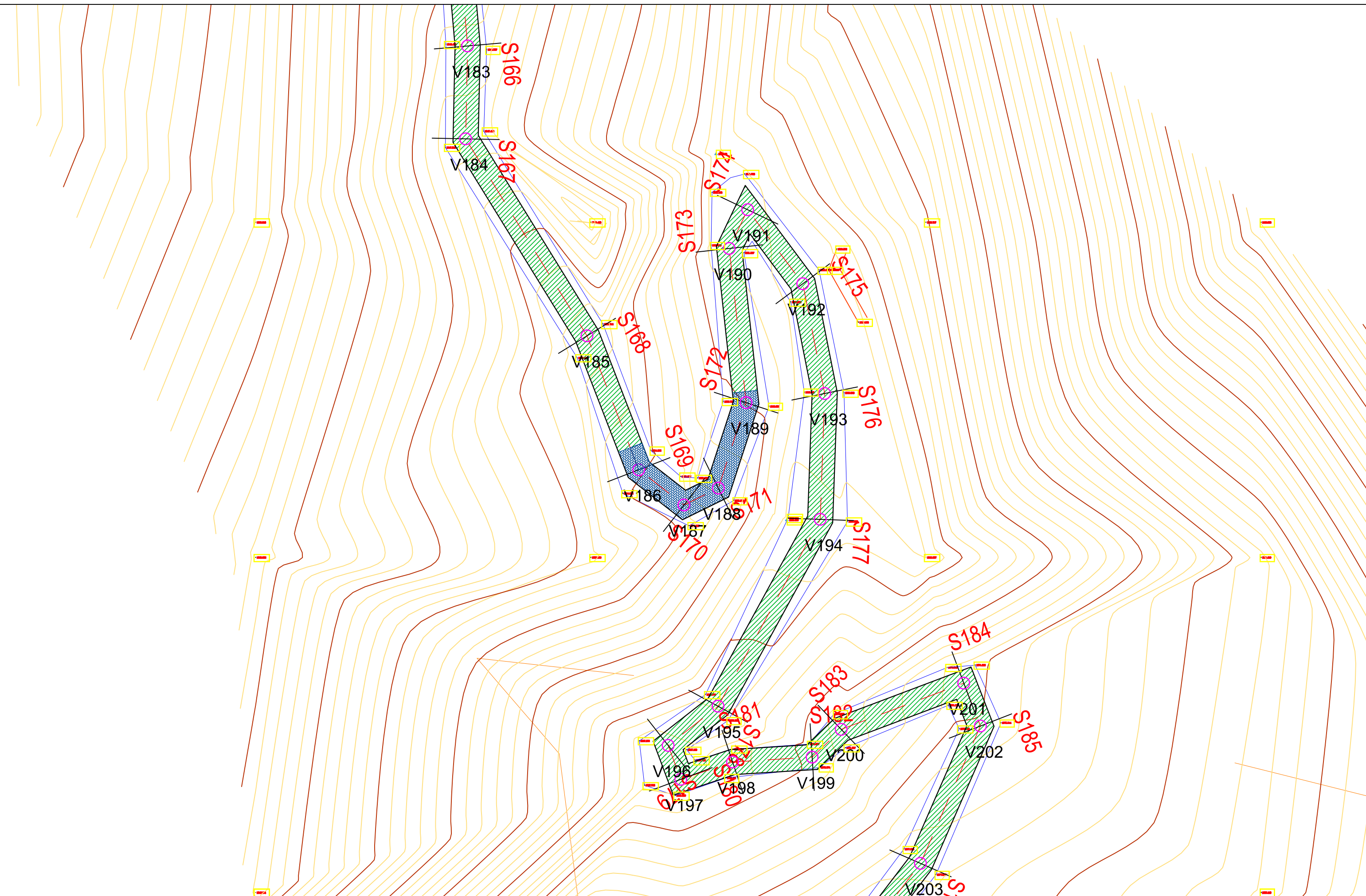
SHKALLA	FLETA
SHK 1:500	1 -22
Tiranë 2017	Format A3



Autoriteit Kontraktor : BASHKIA KRUIJE
 Objekti: Rikonstruksion Rruga Kembesore "Kruje - Sarisalltik"

Emertimi: PLANIMETRIA E RRUGES
 "ERALD-G" Sh.p.k
 Adresa: Rruga "Koli Bano", Tirane



Drejtes i projektit
 Inxh. Gezim ISLAMI

Projektues
 Inxh. Aldo MERKAJ
 Ark.Elton Çarçani
 Hidr. Ersida VERÇANI
 Elek. Hajdar KURTI
 Mek. Arben MUHA

SHKALLA	FLETA
SHK 1:500	1 -23
Tiranë 2017	Format A3

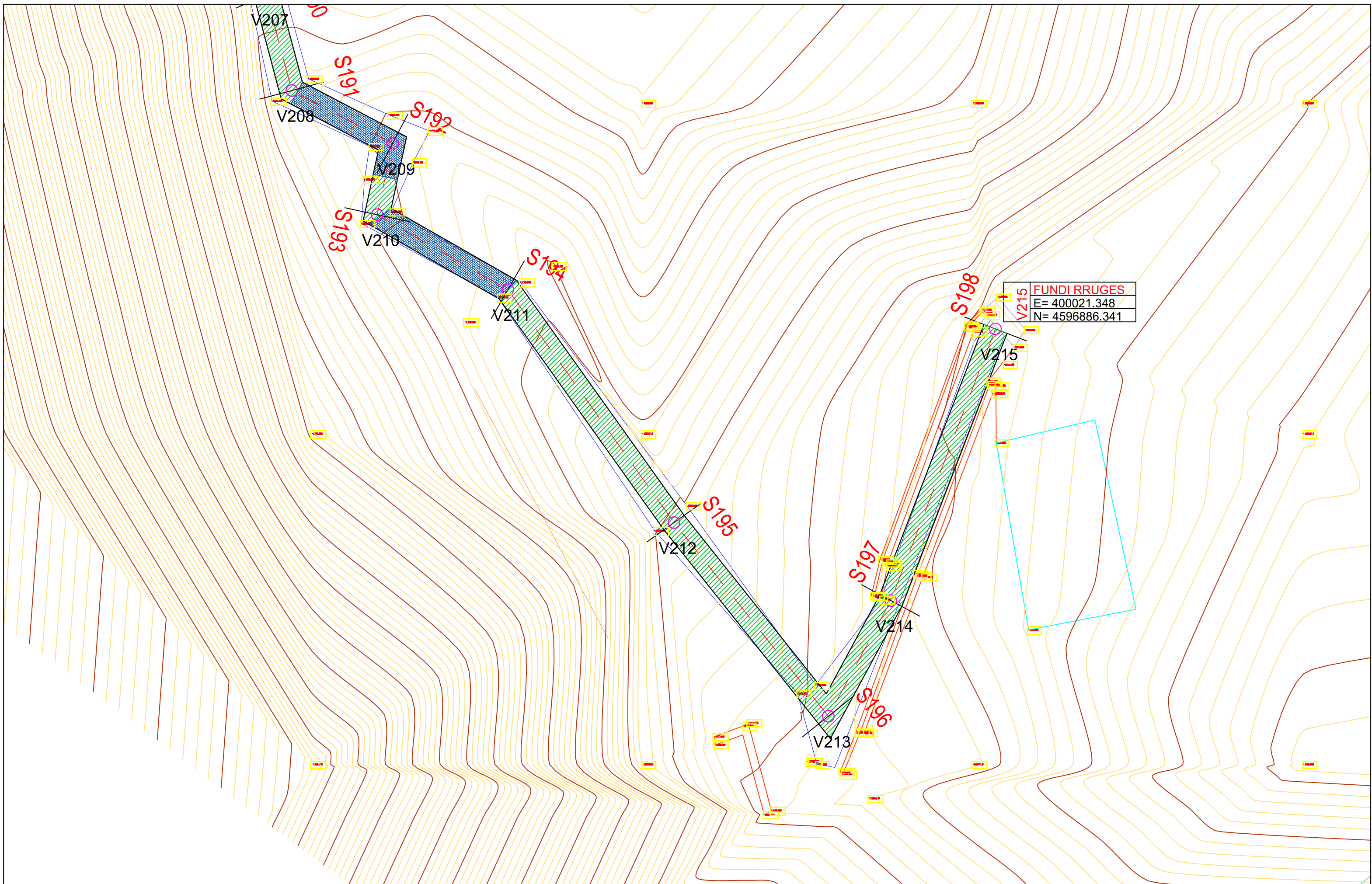

Autoriteit Kontraktor : BASHKIA KRUJE

Objekti: Rikonstruksion Rruga Kembesore "Kruje - Sarisalltik"

Emertimi: PLANIMETRIA E RRUGES



"ERALD-G" Sh.p.k
Adresa: Rruga "Koli Bano", Tirane

Drejtesues i projektit

Inxh. Gezim ISLAMI

Projektues

Inxh. Aldo MERKAJ
Ark.Elton Çarçani
Hidr. Ersida VERÇANI

Elek. Hajdar KURTI
Mek. Arben MUHA

SHKALLA

SHK 1:500

Tiranë 2017

FLETA

1 -25

Format A3

V2	a = 6.43114c E= 399419.594 N= 4596544.176	V32	a = 74.05971c E= 399524.263 N= 4596550.282	V62	a = 24.07343c E= 399594.832 N= 4596665.145	V22	a = -7.06048c E= 399499.236 N= 4596542.106	V52	a = 37.79878c E= 399585.202 N= 4596592.837	V82	a = -55.71537c E= 399648.222 N= 4596770.486	V102	a = 13.40619c E= 399774.969 N= 4596699.543	V132	a = -60.82782c E= 399882.315 N= 4596849.880	V162	a = -64.27081c E= 399891.046 N= 4596999.035
V3	a = -6.39128c E= 399425.327 N= 4596544.306	V33	a = -25.19151c E= 399527.492 N= 4596547.513	V63	a = 27.86058c E= 399589.090 N= 4596679.884	V23	a = -97.22964c E= 399504.430 N= 4596539.479	V53	a = 124.42284c E= 399585.705 N= 4596594.563	V83	a = -3.88216c E= 399654.178 N= 4596779.081	V103	a = -63.44522c E= 399787.242 N= 4596698.084	V133	a = 35.44860c E= 399882.055 N= 4596857.266	V163	a = -92.27957c E= 399892.737 N= 4596999.895
V4	a = 11.80139c E= 399428.860 N= 4596544.743	V34	a = -3.05110c E= 399535.571 N= 4596544.897	V64	a = 98.64765c E= 399589.276 N= 4596682.692	V24	a = -16.89822c E= 399506.078 N= 4596542.413	V54	a = -29.07105c E= 399596.026 N= 4596586.433	V84	a = 5.00141c E= 399666.334 N= 4596799.132	V104	a = -111.22240c E= 399788.313 N= 4596699.375	V134	a = -66.30514c E= 399889.099 N= 4596869.522	V164	a = 65.86013c E= 399889.088 N= 4597009.916
V5	a = -17.47835c E= 399434.005 N= 4596544.422	V35	a = -76.97654c E= 399557.587 N= 4596538.917	V65	a = 13.29426c E= 399592.570 N= 4596682.544	V25	a = -8.09754c E= 399507.253 N= 4596547.086	V55	a = -89.86087c E= 399597.556 N= 4596586.106	V85	a = 44.53970c E= 399673.863 N= 4596809.599	V105	a = 7.28410c E= 399778.910 N= 4596704.712	V135	a = 27.12559c E= 399882.304 N= 4596881.393	V165	a = 100.50168c E= 399890.275 N= 4597011.368
V6	a = 57.68637c E= 399438.771 N= 4596545.449	V36	a = -58.40477c E= 399558.843 N= 4596540.651	V66	a = -104.91361c E= 399603.333 N= 4596679.753	V26	a = 26.31213c E= 399507.697 N= 4596550.795	V56	a = 11.63607c E= 399600.446 N= 4596593.561	V86	a = 95.52322c E= 399675.477 N= 4596810.007	V106	a = 46.67900c E= 399769.172 N= 4596711.822	V136	a = -27.82382c E= 399878.534 N= 4596921.470	V166	a = -64.84223c E= 399897.305 N= 4597005.528
V7	a = 23.65869c E= 399440.407 N= 4596544.088	V37	a = 9.58758c E= 399552.783 N= 4596560.918	V67	a = -27.65643c E= 399604.040 N= 4596683.716	V27	a = 30.45150c E= 399510.986 N= 4596556.377	V57	a = -56.27022c E= 399603.860 N= 4596599.097	V87	a = 12.01041c E= 399676.768 N= 4596806.084	V107	a = 31.76322c E= 399764.239 N= 4596735.323	V137	a = -10.03017c E= 399873.726 N= 4596929.660	V167	a = -73.84029c E= 399900.225 N= 4597006.513
V8	a = -17.63780c E= 399443.159 N= 4596539.113	V38	a = 51.95202c E= 399552.217 N= 4596564.936	V68	a = 14.07357c E= 399600.421 N= 4596697.437	V28	a = 76.35552c E= 399514.479 N= 4596558.567	V58	a = 11.70744c E= 399602.264 N= 4596603.737	V88	a = 8.76473c E= 399677.830 N= 4596797.914	V108	a = 21.94535c E= 399766.678 N= 4596743.436	V138	a = -42.51773c E= 399866.216 N= 4596938.789	V168	a = -50.40560c E= 399900.403 N= 4597008.588
V9	a = -4.24484c E= 399448.997 N= 4596533.239	V39	a = 72.27332c E= 399553.426 N= 4596566.443	V69	a = 2.96155c E= 399599.987 N= 4596709.220	V29	a = 37.13760c E= 399516.191 N= 4596557.294	V59	a = 24.04700c E= 399600.392 N= 4596616.346	V89	a = -42.29772c E= 399677.695 N= 4596781.868	V109	a = -27.65593c E= 399777.247 N= 4596757.728	V139	a = 22.96292c E= 399857.055 N= 4596940.785	V169	a = 69.46698c E= 399891.831 N= 4597018.638
V10	a = -71.23099c E= 399454.500 N= 4596528.395	V40	a = 11.66868c E= 399565.597 N= 4596563.457	V70	a = 22.25116c E= 399600.169 N= 4596727.975	V30	a = -63.45985c E= 399519.241 N= 4596548.888	V60	a = -13.44003c E= 399604.924 N= 4596635.672	V90	a = -73.70589c E= 399689.507 N= 4596766.522	V110	a = -23.08307c E= 399781.678 N= 4596779.328	V140	a = 33.69208c E= 399851.535 N= 4596944.364	V170	a = 102.45035c E= 399892.780 N= 4597020.980
V11	a = -34.61714c E= 399455.852 N= 4596528.962	V41	a = -115.21319c E= 399570.067 N= 4596561.440	V71	a = -20.04619c E= 399603.617 N= 4596737.157	V91	a = -74.47775c E= 399691.383 N= 4596766.987	V121	a = -47.47353c E= 399847.779 N= 4596738.082	V151	a = -19.04538c E= 399861.707 N= 4596993.228	V111	a = 13.09015c E= 399778.418 N= 4596799.496	V141	a = -7.24337c E= 399847.194 N= 4596952.988	V171	a = -61.51474c E= 399904.882 N= 4597015.525
V12	a = 48.76942c E= 399457.988 N= 4596531.892	V42	a = -34.11311c E= 399570.581 N= 4596564.188	V72	a = 2.55036c E= 399604.705 N= 4596761.679	V92	a = 8.08697c E= 399693.160 N= 4596778.145	V122	a = -115.57757c E= 399850.624 N= 4596739.362	V152	a = 41.41918c E= 399866.442 N= 4596986.396	V112	a = 89.95474c E= 399778.797 N= 4596807.845	V142	a = -0.73930c E= 399841.009 N= 4596962.426	V172	a = 19.32057c E= 399909.895 N= 4597018.549
V13	a = -18.35945c E= 399471.312 N= 4596534.245	V43	a = 7.22176c E= 399568.454 N= 4596569.998	V73	a = 33.33144c E= 399605.945 N= 4596776.336	V93	a = 78.31583c E= 399695.183 N= 4596785.051	V123	a = 10.33885c E= 399842.138 N= 4596750.129	V153	a = -32.62743c E= 399866.239 N= 4596981.843	V113	a = 72.16881c E= 399781.587 N= 4596808.160	V143	a = 39.85875c E= 399834.859 N= 4596971.577	V173	a = 36.83976c E= 399914.879 N= 4597019.765
V14	a = 30.10931c E= 399475.645 N= 4596536.409	V44	a = 58.22544c E= 399567.073 N= 4596575.703	V74	a = 55.15201c E= 399608.627 N= 4596780.190	V94	a = 63.46869c E= 399697.696 N= 4596785.191	V124	a = 35.23333c E= 399836.437 N= 4596760.440	V154	a = -79.70557c E= 399867.129 N= 4596980.082	V114	a = -4.21098c E= 399793.601 N= 4596788.547	V144	a = 43.64945c E= 399835.071 N= 4596977.742	V174	a = 30.10200c E= 399931.328 N= 4597013.958
V15	a = 19.83641c E= 399483.833 N= 4596536.329	V45	a = 94.58609c E= 399567.860 N= 4596576.682	V75	a = 67.05302c E= 399624.887 N= 4596781.764	V95	a = -27.12190c E= 399702.157 N= 4596779.066	V125	a = 22.42720c E= 399836.859 N= 4596769.157	V155	a = -36.17147c E= 399869.225 N= 4596980.397	V115	a = 19.04407c E= 399800.531 N= 4596778.752	V145	a = 51.71988c E= 399843.999 N= 4596987.921	V175	a = 12.34363c E= 399938.240 N= 4597006.665
V16	a = 20.05543c E= 399485.368 N= 4596535.818	V46	a = -78.66958c E= 399580.390 N= 4596568.255	V76	a = -34.42561c E= 399628.043 N= 4596777.287	V96	a = 25.01079c E= 399718.745 N= 4596769.672	V126	a = -16.99987c E= 399843.332 N= 4596784.439	V156	a = -20.88274c E= 399875.643 N= 4596985.996	V116	a = -6.60280c E= 399805.062 N= 4596764.922	V146	a = 86.48800c E= 399846.448 N= 4596988.015	V176	a = -47.31509c E= 399939.367 N= 4597004.886
V17	a = -6.30349c E= 399489.869 N= 4596532.492	V47	a = -58.15689c E= 399581.299 N= 4596568.937	V77	a = -86.69172c E= 399630.139 N= 4596776.361	V97	a = 30.64492c E= 399730.423 N= 4596754.707	V127	a = 23.07350c E= 399845.881 N= 4596803.401	V157	a = -45.50932c E= 399877.616 N= 4596989.399	V117	a = -23.33521c E= 399811.040 N= 4596751.547	V147	a = -92.46645c E= 399847.719 N= 4596983.050	V177	a = 28.46076c E= 399948.341 N= 4597002.471
V18	a = -80.03013c E= 399492.143 N= 4596531.137	V48	a = 29.92703c E= 399581.480 N= 4596582.252	V78	a = 70.21988c E= 399638.590 N= 4596788.073	V98	a = -8.40748c E= 399732.507 N= 4596743.337	V128	a = 49.31576c E= 399849.618 N= 4596810.306	V158	a = 27.54997c E= 399875.885 N= 4596998.427	V118	a = -23.64353c E= 399815.475 N= 4596747.125	V148	a = -73.84930c E= 399850.545 N= 4596983.426	V178	a = -13.32739c E= 399954.274 N= 4596997.372
V19	a = -46.47339c E= 399493.002 N= 4596531.890	V49	a = 99.74081c E= 399582.300 N= 4596583.813	V79	a = 78.80024c E= 399640.589 N= 4596787.756	V99	a = -32.30191c E= 399740.204 N= 4596719.582	V129	a = -34.86009c E= 399859.685 N= 4596813.421	V159	a = 92.33170c E= 399878.943 N= 4597010.746	V119	a = -25.74373c E= 399822.019 N= 4596744.261	V149	a = 82.27009c E= 399856.364 N= 4597003.777	V179	a = -14.63476c E= 399962.728 N= 4596992.747
V20	a = 14.72081c E= 399493.629 N= 4596537.044	V50	a = -59.21818c E= 399586.947 N= 4596581.396	V80	a = -18.34170c E= 399642.256 N= 4596778.368	V100	a = -29.39494c E= 399760.249 N= 4596700.906	V130	a = -25.72231c E= 399868.062 N= 4596822.912	V160	a = 57.63525c E= 399881.583 N= 4597010.420	V120	a = 20.03917c E= 399829.497 N= 4596744.200	V150	a = 80.46276c E= 399858.364 N= 4597003.777	V180	a = 37.17294c E= 399965.398 N= 4596992.006

Autoriteit Kontraktor : BASHKIA KRUIJE

Objekti: Rikonstruksjon Rruga Kembesore "Kruje - Sarisalltik"

Emertimi: PLANIMETRIA E RRUGES



"ERALD-G" Sh.p.k

Adresa: Rruga "Koli Bano",Tirane

Drejtesues i projektit

Inxh. Gezim ISLAMI

Projektues

Inxh. Aldo MERKAJ

Ark.Elton Çarçani

Hidr. Ersida VERÇANI

Elek. Hajdar KURTI

Mek. Arben MUHA

SHKALLA

SHK 1:500

Tiranë 2017

FLETA

1 -25

Format A3

V181	a = 34.24807c E= 399970.599 N= 4596986.030	V201	a = 99.35287c E= 400002.257 N= 4596932.503
V182	a = 5.73581c E= 399971.934 N= 4596978.618	V202	a = 49.78696c E= 400003.251 N= 4596929.945
V183	a = 6.97520c E= 399972.648 N= 4596970.535	V203	a = 15.35112c E= 399999.674 N= 4596921.747
V184	a = -36.51833c E= 399972.529 N= 4596964.991	V204	a = 28.76109c E= 399993.748 N= 4596913.993
V185	a = 11.68582c E= 399979.773 N= 4596953.233	V205	a = 25.74285c E= 399986.928 N= 4596910.559
V186	a = -34.37706c E= 399982.860 N= 4596945.241	V206	a = -123.32841c E= 399975.717 N= 4596909.862
V187	a = -71.28662c E= 399985.560 N= 4596943.136	V207	a = 10.73708c E= 399977.215 N= 4596906.583
V188	a = -50.82228c E= 399987.607 N= 4596944.144	V208	a = -52.66554c E= 399978.763 N= 4596900.761
V189	a = -26.98466c E= 399989.268 N= 4596949.243	V209	a = 82.73604c E= 399984.859 N= 4596897.559
V190	a = 35.16315c E= 399988.261 N= 4596958.448	V210	a = -80.39417c E= 399983.929 N= 4596893.248
V191	a = 130.99898c E= 399989.359 N= 4596960.760	V211	a = 27.41146c E= 399991.838 N= 4596888.715
V192	a = 28.25858c E= 399992.651 N= 4596956.343	V212	a = -3.39278c E= 400001.893 N= 4596874.624
V193	a = 14.76100c E= 399993.956 N= 4596949.791	V213	a = -125.63291c E= 400011.233 N= 4596862.909
V194	a = 29.59730c E= 399993.691 N= 4596942.279	V214	a = -8.09023c E= 400015.012 N= 4596869.908
V195	a = 25.84020c E= 399987.595 N= 4596931.125		
V196	a = -80.41203c E= 399984.613 N= 4596928.788		
V197	a = -97.75978c E= 399985.368 N= 4596926.764		
V198	a = 16.55413c E= 399988.460 N= 4596927.795		
V199	a = -44.67359c E= 399993.210 N= 4596928.089		
V200	a = 25.66118c E= 399994.940 N= 4596929.745		

Autoriteit Kontraktor : BASHKIA KRUJE
Objekti: Rikonstruksion Rruga Kembesore "Kruje - Sarisalltik"

Emertimi: PLANIMETRIA E RRUGES
 "ERALD-G" Sh.p.k
Adresa: Rruga "Koli Bano", Tirane

Drejtues i projektit	Projektues		
Inxh. Gezim ISLAMI	Inxh. Aldo MERKAJ	Elek. Hajdar KURTI	
	Ark.Elton Çarçani	Mek. Arben MUHA	
	Hidr. Ersida VERÇANI		

SHKALLA	FLETA
SHK 1:500	1 -25
Tiranë 2017	Format A3



Autoriteit Kontraktor : BASHKIA KRUJE

Objekti: Rikonstruksion Rruga Kembesore "Kruje - Sarisalltik"

Emertimi: PAMJE 3 DIMENSIONALE



"ERALD-G" Sh.p.k

Adresa: Rruga "Koli Bano", Tirane

Drejtues i projektit

Inxh. Gezim ISLAMI

Projektues

Inxh. Aldo MERKAJ

Ark.Elton Çarçani

Hidr. Ersida VERÇANI

Elek. Hajdar KURTI

Mek. Arben MUHA

SHKALLA

SHK 1:VAR

Tiranë 2017

FLETA

5 -01

Format A3



Autoriteit Kontraktor : BASHKIA KRUJE

Objekti: Rikonstruksion Rruga Kembesore "Kruje - Sarisalltik"

Emertimi: PAMJE 3 DIMENSIONALE



"ERALD-G" Sh.p.k

Adresa: Rruga "Koli Bano", Tirane

Drejtues i projektit

Inxh. Gezim ISLAMI

Projektues

Inxh. Aldo MERKAJ

Ark.Elton Çarçani

Hidr. Ersida VERÇANI

Elek. Hajdar KURTI

Mek. Arben MUHA

SHKALLA

SHK 1:VAR

Tiranë 2017

FLETA

5 -02

Format A3



Autoriteit Kontraktor : BASHKIA KRUJE

Objekti: Rikonstruksion Rruga Kembesore "Kruje - Sarisalltik"

Emertimi: PAMJE 3 DIMENSIONALE



"ERALD-G" Sh.p.k

Adresa: Rruga "Koli Bano", Tirane

Drejtes i projektit

Inxh. Gezim ISLAMI

Projektues

Inxh. Aldo MERKAJ

Ark.Elton Çarçani

Hidr. Ersida VERÇANI

Elek. Hajdar KURTI

Mek. Arben MUHA

SHKALLA

SHK 1:VAR

Tiranë 2017

FLETA

5 -03

Format A3



Autoriteit Kontraktor : BASHKIA KRUIJE

Objekti: Rikonstruksion Rruga Kembesore "Kruje - Sarisalltik"

Emertimi: PAMJE 3 DIMENSIONALE



"ERALD-G" Sh.p.k

Adresa: Rruga "Koli Bano", Tirane

Drejtues i projektit

Inxh. Gezim ISLAMI

Projektues

Inxh. Aldo MERKAJ

Ark.Elton Çarçani

Hidr. Ersida VERÇANI

Elek. Hajdar KURTI

Mek. Arben MUHA

SHKALLA

SHK 1:VAR

Tiranë 2017

FLETA

5 -04

Format A3



Autoriteit Kontraktor : BASHKIA KRUJE

Objekti: Rikonstruksion Rruga Kembesore "Kruje - Sarisalltik"

Emertimi: PAMJE 3 DIMENSIONALE



"ERALD-G" Sh.p.k

Adresa: Rruga "Koli Bano", Tirane

Drejtues i projektit

Inxn. Gezim ISLAMI

Projektues

Inxh. Aldo MERKAJ

Ark.Elton Çarçani

Hidr. Ersida VERÇANI

Elek. Hajdar KURTI

Mek. Arben MUHA

SHKALLA

SHK 1:VAR

Tiranë 2017

FLETA

5 -05

Format A3

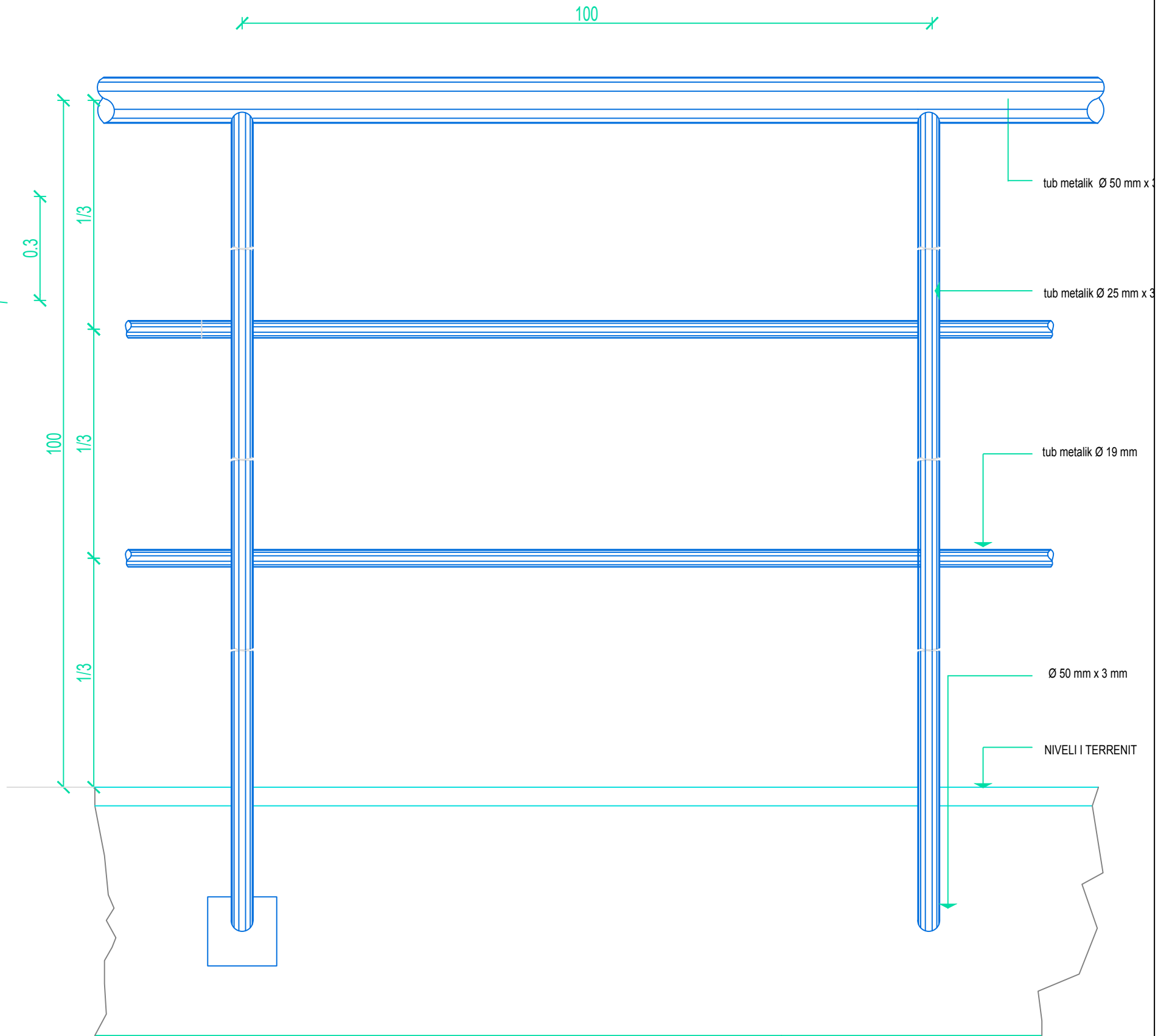
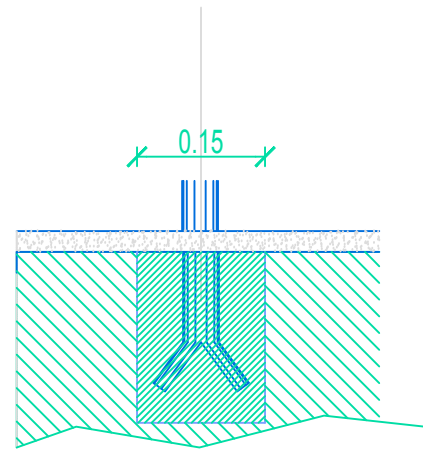
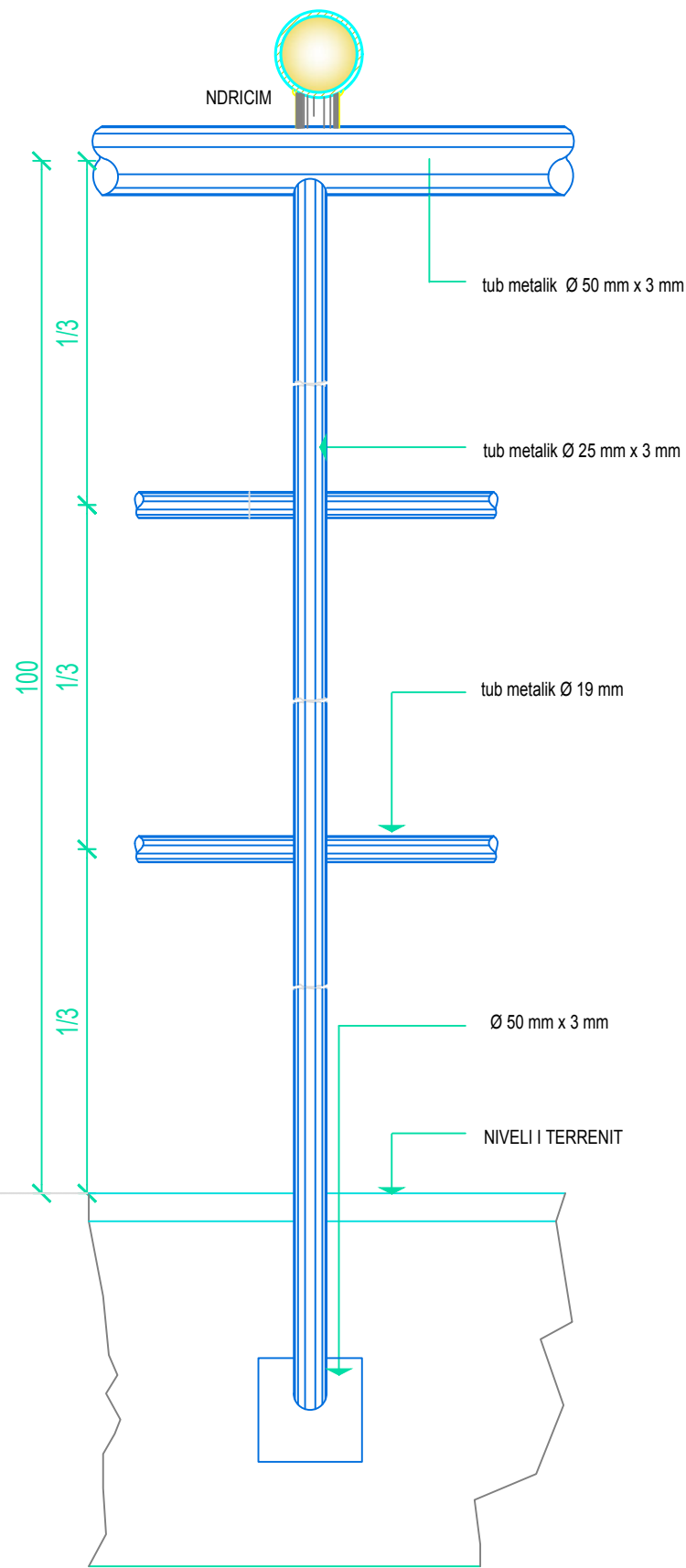

Autoriteit Kontraktor : BASHKIA KRUIJE

Objekti: Rikonstruksion Rruga Kembesore "Kruje - Sarisalltik"

Emertimi: DETAJE



"ERALD-G" Sh.p.k

Adresa: Rruga "Koli Bano", Tirane

Drejtues i projektit

Inxh. Gezim ISLAMI

Projektues

Inxh. Aldo MERKAJ

Ark.Elton Çarçani

Hidr. Ersida VERÇANI

Elek. Hajdar KURTI

Mek. Arben MUHA

SHKALLA

SHK 1:50

Tiranë 2017

FLETA

4 -01

Format A3

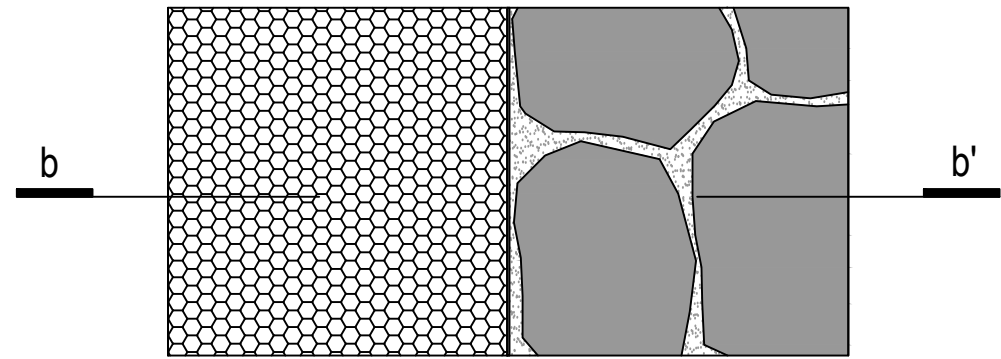
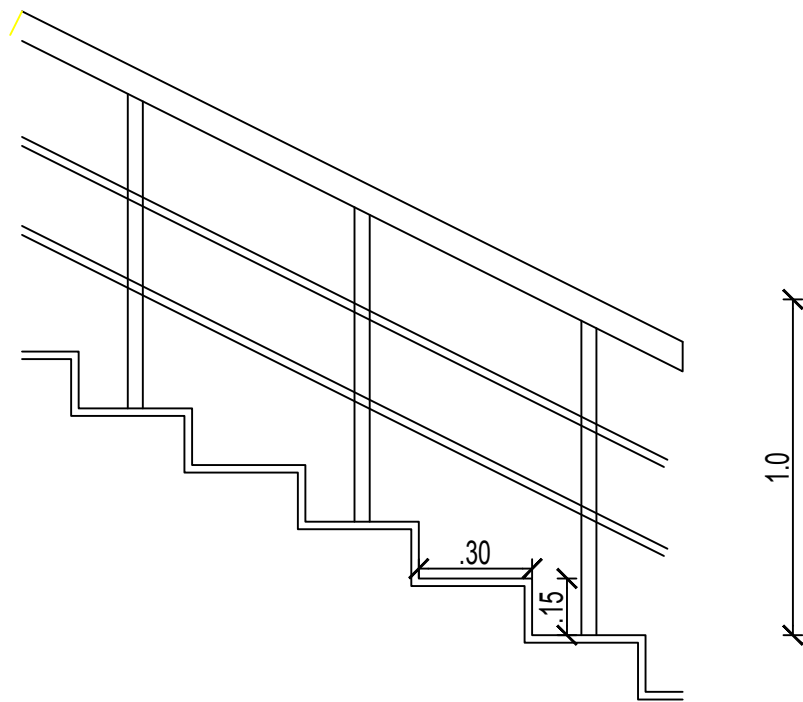

GURE ME PERMASA 0.1*0.2

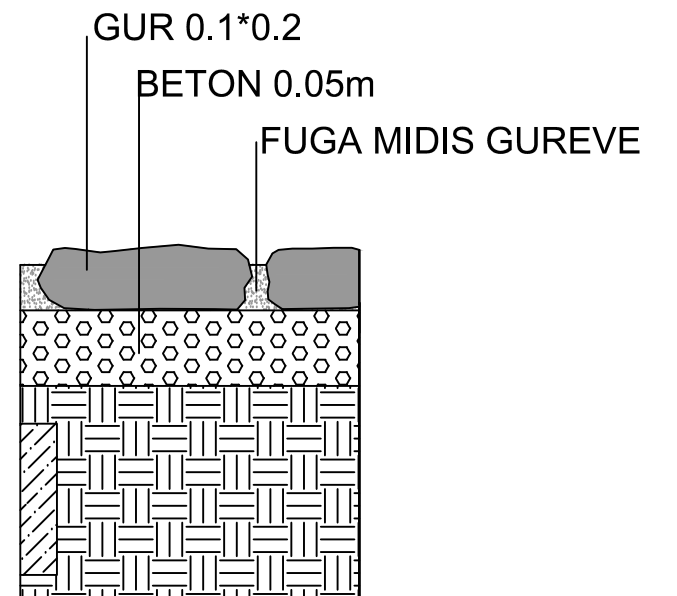
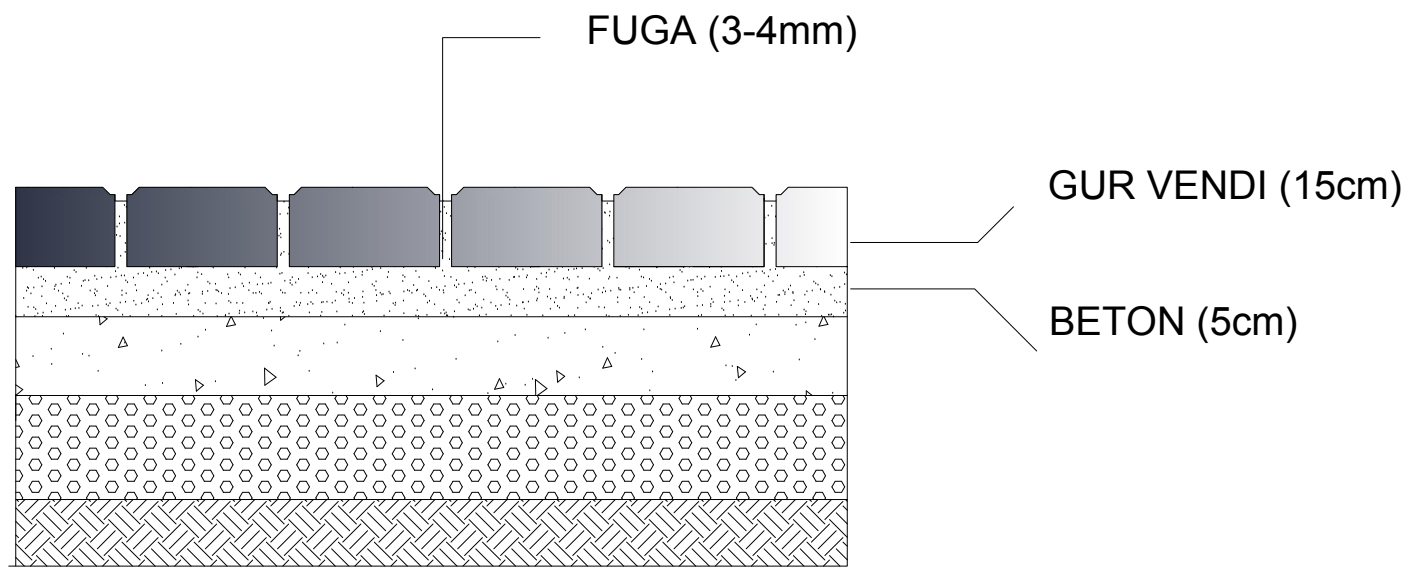

Autoriteit Kontraktor : BASHKIA KRUIJE

Objekti: Rikonstruksion Rruga Kembesore "Kruje - Sarisalltik"

Emertimi: DETAJE



"ERALD-G" Sh.p.k

Adresa: Rruga "Koli Bano", Tirane

Drejtues i projektit

Inxh. Gezim ISLAMI

Projektues

Inxh. Aldo MERKAJ

Ark.Elton Çarçani

Hidr. Ersida VERÇANI

Elek. Hajdar KURTI

Mek. Arben MUHA

SHKALLA

SHK 1:50

Tiranë 2017

FLETA

4 -02

Format A3