

AUTORITETI KONTRAKTOR:
BASHKIA DIBËR



MIRATOHET
BASHKIA DIBËR
KRYETARI

Z. RAHIM SPAHIU

KONSULENTI: "2 ED" sh.p.k



"2 ED" sh.p.k

PROJEKT - ZBATIMI

PROJEKT

Objekti: "SISTEMIM - ASFALTIM I RRUGËVE TË BRENDSHME TË FSHATIT GREVË,
NJËSIA ADMINISTRATIVE MELAN, BASHKIA DIBËR"

VITI 2024

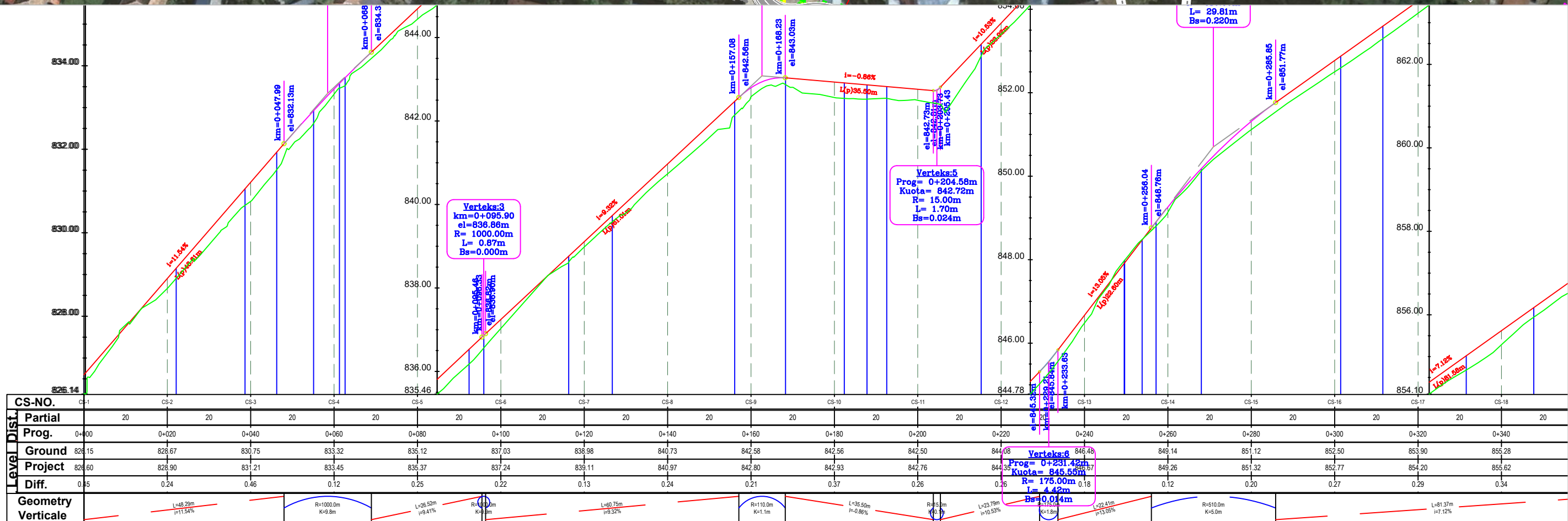

CS-NO.	CS-1	CS-2	CS-3	CS-4	CS-5	CS-6	CS-7	CS-8	CS-9	CS-10	CS-11	CS-12	CS-13	CS-14	CS-15	CS-16	CS-17	CS-18				
Partial	20	20	20	20	20	20	20	20	20	20	20	20	20	20	20	20	20	20				
Prog.	0+00	0+20	0+40	0+60	0+80	0+100	0+120	0+140	0+160	0+180	0+200	0+220	0+240	0+260	0+280	0+300	0+320	0+340				
Ground	826.15	828.67	830.75	833.32	835.12	837.03	838.98	840.73	842.58	842.56	842.50	844.08	846.48	849.14	851.12	852.50	853.90	855.28				
Project	826.60	828.90	831.21	833.45	835.37	837.24	839.11	840.97	842.80	842.93	842.76	844.35	846.57	849.26	851.32	852.77	854.20	855.62				
Diff.	0.45	0.24	0.46	0.12	0.25	0.22	0.13	0.24	0.21	0.37	0.26	0.26	0.18	0.12	0.20	0.27	0.29	0.34				
Geometry	L=48.29m i=11.54%		R=1000.0m K=9.8m		L=26.52m i=9.41%		R=110.0m K=1.1m		L=60.75m i=9.32%		L=35.50m i=-0.86%		R=15.00m K=1.8m		L=23.79m i=10.53%		L=22.41m i=13.05%		R=510.0m K=5.0m		L=81.37m i=7.12%	



Porositesi
BASHKIA DIBER

Objekti: "SISTEMIM - ASFALTIM I RRUGËVE TË BRENDSHME TË FSHATIT GREVË, NJËSIA ADMINISTRATIVE MELAN, BASHKIA DIBËR"

Emertimi:
**PLANIMETRIA
PROFILI GJATESOR**

PROJEKT ZBATIMI

GRUPI PROJEKTUES	Ing.Hidro. Mark PEMAJ	Firma:	
	Ing.Top. Bilbil NURÇE	Firma:	
Periodha:	SHTATOR 2024		
	Shkalla:	1:1000	
	Fleta:	Nr. 1	

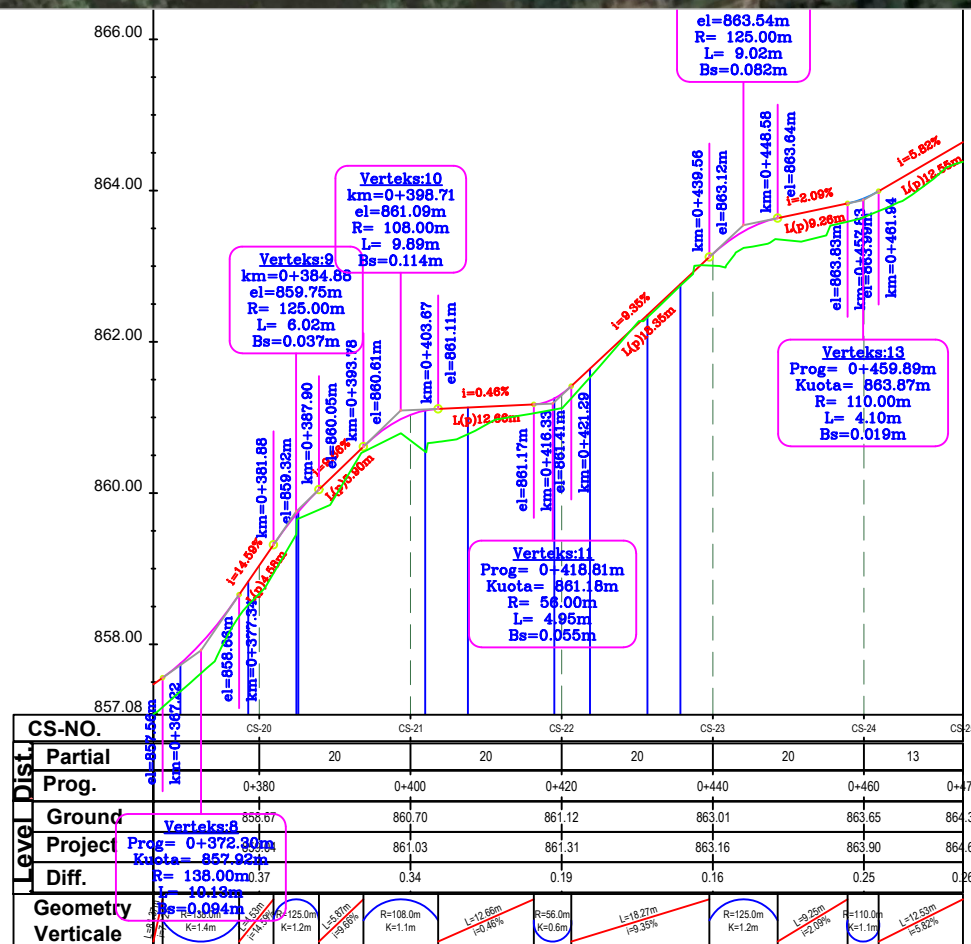

2D PROJEKTIM
DESIGN
SUPERVISION
KOLAUDIM
Adresa: Rruga "Bardhyl", Njësia Bashkiake nr. 8, TIRANË



Porositesi
BASHKIA DIBER

Objekti: "SISTEMIM - ASFALTIM I
RRUGËVE TË BRENDSHME TË FSHATIT
GREVË, NJËSIA ADMINISTRATIVE MELAN,
BASHKIA DIBËR"

Emertimi:

**PLANIMETRIA
PROFILI GJATESOR**

PROJEKT ZBATIMI

GRUPI
PROJEKTUES

Ing.Hidro. Mark PEMAJ
Ing.Top. Bilbil NURÇE

Firma:
Firma:

Periudha:
SHTATOR 2024

Shkalla: 1:1000
Fleta: Nr. 2

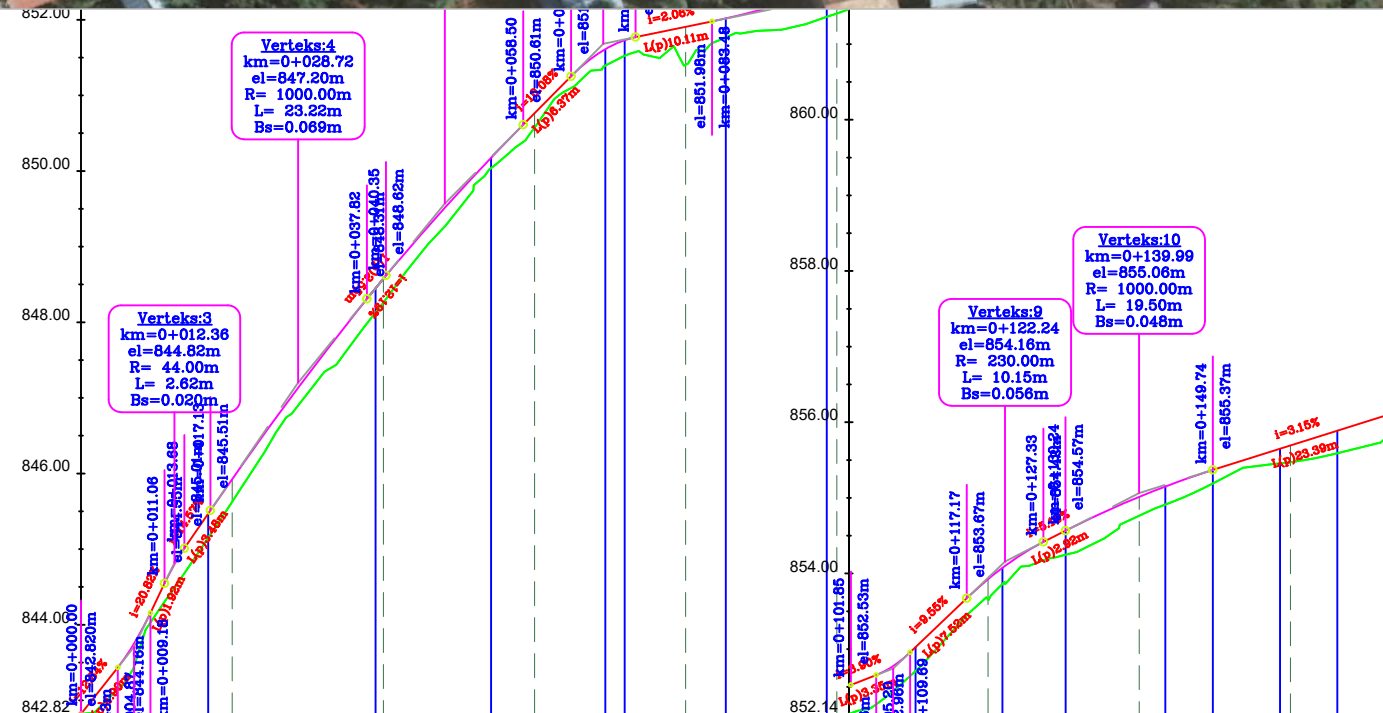

CS-NO.	CS-1	CS-2	CS-3	CS-4	CS-5	CS-6	CS-7	CS-8	CS-9	CS-10
Partial Dist.	20	20	20	20	20	20	20	20	13	
Prog.	0+000	0+020	0+040	0+060	0+080	0+100	0+120	0+140	0+160	0+173
Level										
Ground	842.82	845.63	846.26	850.57	851.41	852.08	853.66	854.76	855.47	855.80
Project	843.82	845.93	846.58	850.76	851.91	852.49	853.93	855.02	855.69	856.09
Diff.	0.00	0.30	0.32	0.19	0.50	0.37	0.27	0.25	0.22	0.29
Geometry	R=1000.0m K=9.7m		R=1000.0m K=9.8m		R=107.0m K=1.1m		R=1000.0m K=10.0m		R=230.0m K=2.3m	
Verticale	L=4.31m Bs=0.040m		L=23.22m Bs=0.089m		L=2.62m Bs=0.020m		L=80.00m Bs=0.032m		L=19.50m Bs=0.048m	

2D PROJEKTIM
DESIGN
SUPERVISION
KOLAUDIM
Adresa: Rruga "Bardhyl", Njësia Bashkiake nr. 8, TIRANË

Porositesi
BASHKIA DIBER

Objekti: "SISTEMIM - ASFALTIM I
RRUGËVE TË BRENDSHME TË FSHATIT
GREVË, NËSIA ADMINISTRATIVE MELAN,
BASHKIA DIBËR"

Emertimi:
PLANIMETRIA
PROFILI GJATESOR

PROJEKT ZBATIMI

GRUPI PROJEKTUES	Ing.Hidro. Mark PEMAJ	Firma:	
	Ing.Top. Bilbil NURÇE	Firma:	
Periudha: SHTATOR 2024		Shkalla:	1:1000
		Fleta:	Nr. 1

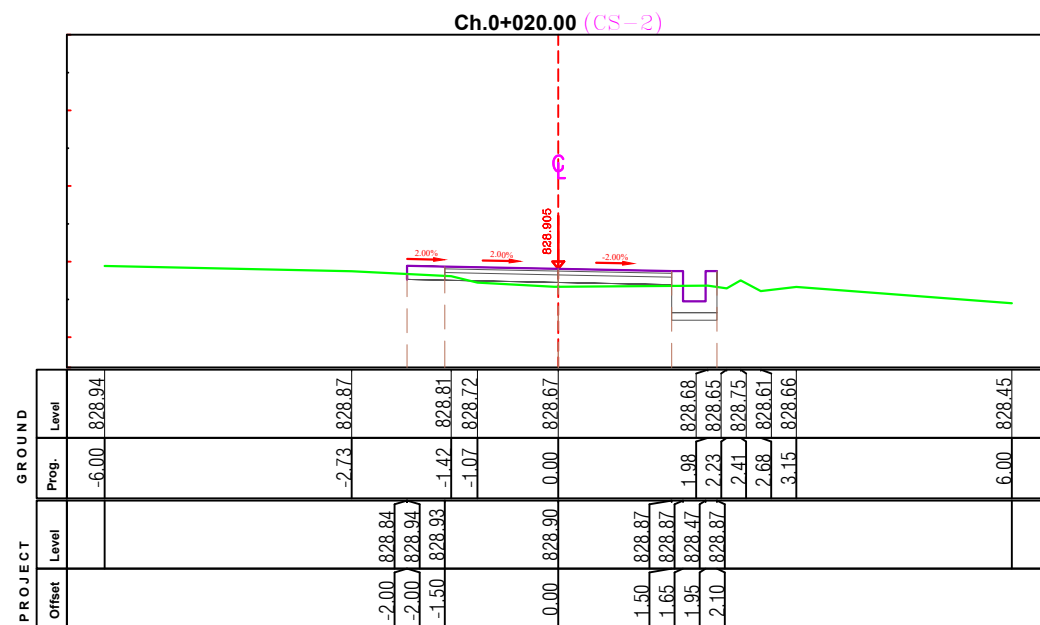
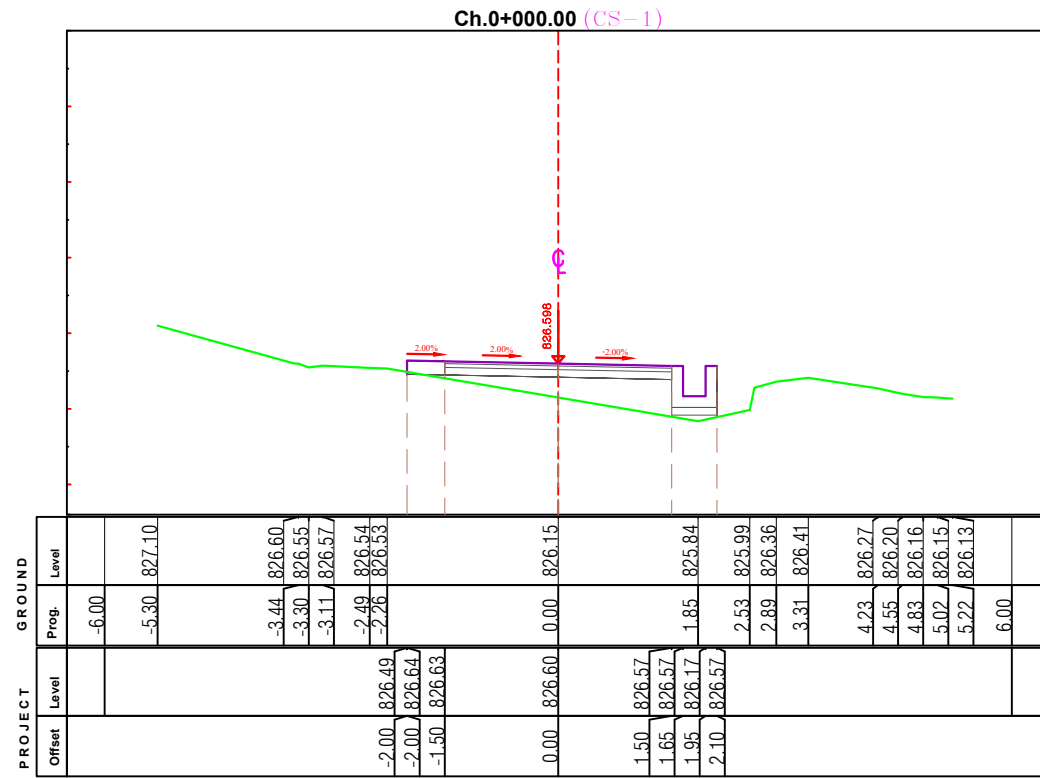

**Porositesi
BASHKIA DIBER**

Objekti: "SISTEMIM - ASFALTIM I RRUGËVE TË BRENDSHME TË FSHATIT GREVË, NJËSIA ADMINISTRATIVE MELAN, BASHKIA DIBËR"

Emertimi:
PROFLET TERTHORE

PROJEKT ZBATIMI

GRUPI PROJEKTUES	Ing.Hidro. Mark PEMAJ	Firma:	
	Ing.Top. Bilbil NURÇE	Firma:	
Periudha: SHTATOR 2024		Shkalla:	1:100
		Fleta:	Nr. 1

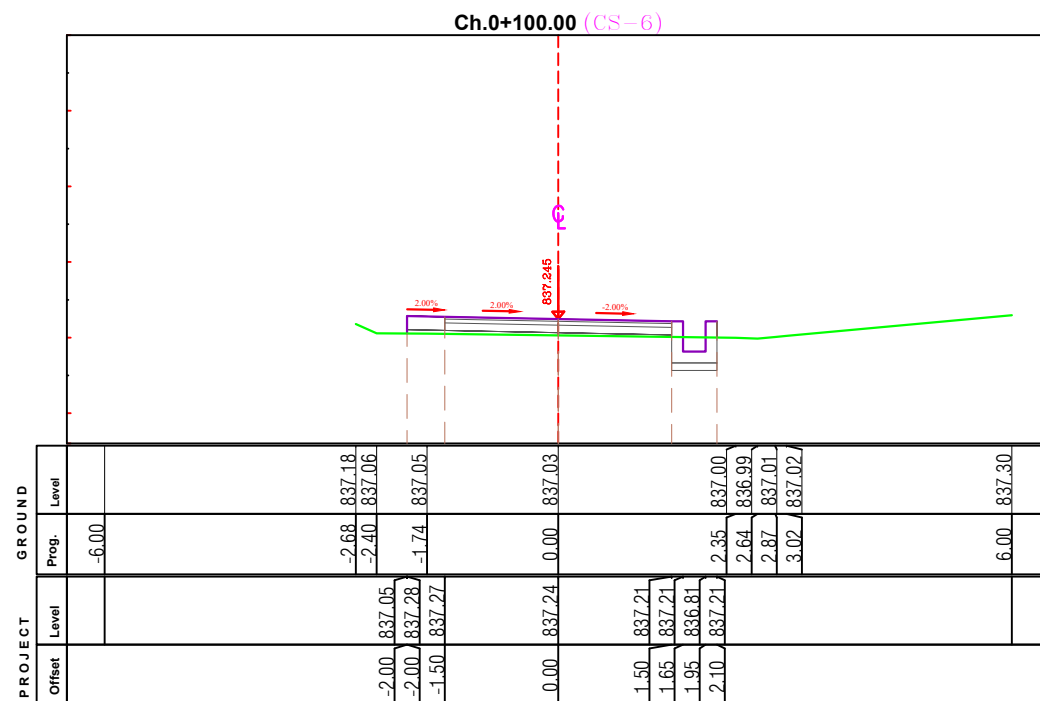
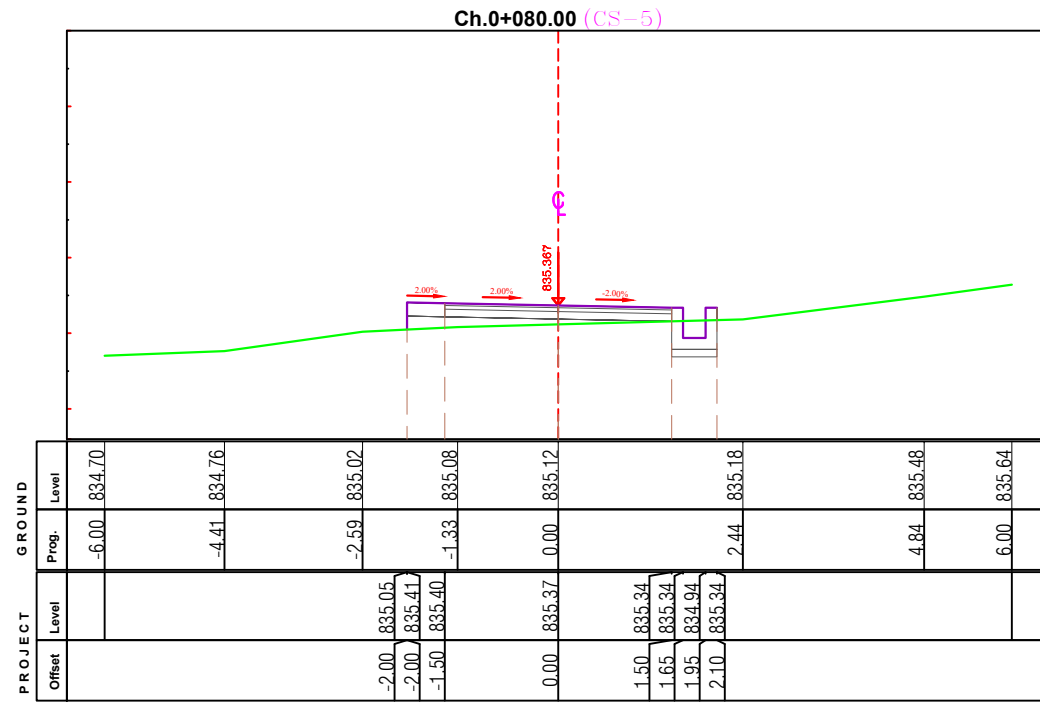

Porositesi
BASHKIA DIBER

Objekti: "SISTEMIM - ASFALTIM I RRUGËVE TË BRENDSHME TË FSHATIT GREVË, NJËSIA ADMINISTRATIVE MELAN, BASHKIA DIBËR"

Emertimi:

PROFLET TERTHORE

PROJEKT ZBATIMI

GRUPI PROJEKTUES

Ing.Hidro. Mark PEMAJ
Ing.Top. Bilbil NURÇE

Firma:
Firma:

Periudha:
SHTATOR 2024

Shkalla: 1:100
Fleta: Nr. 3

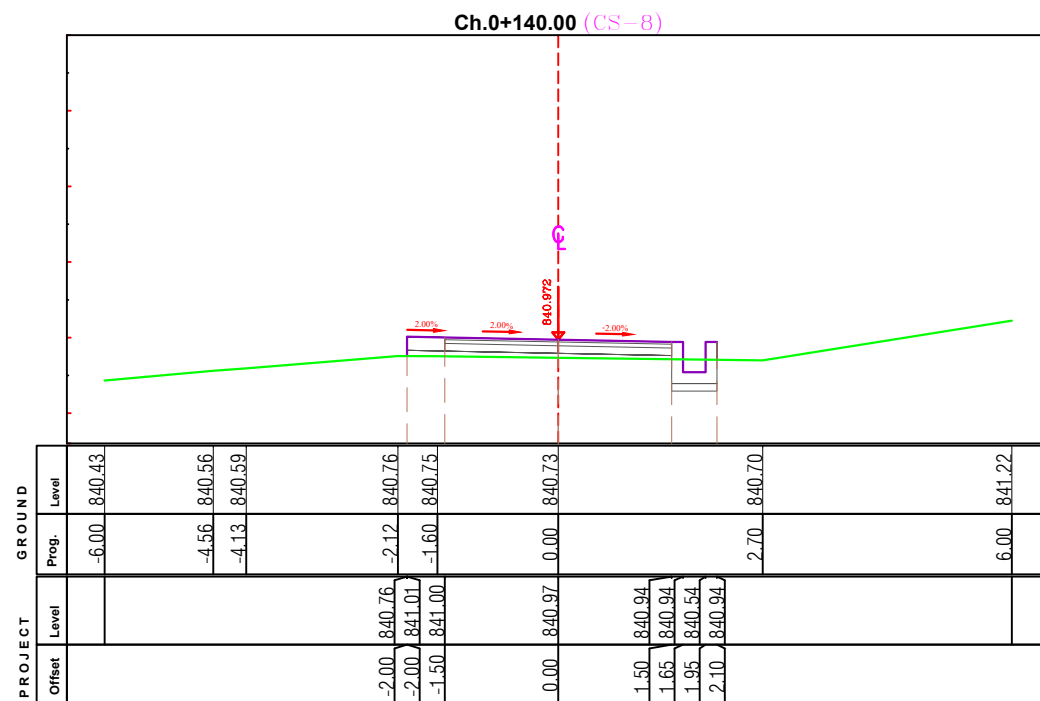
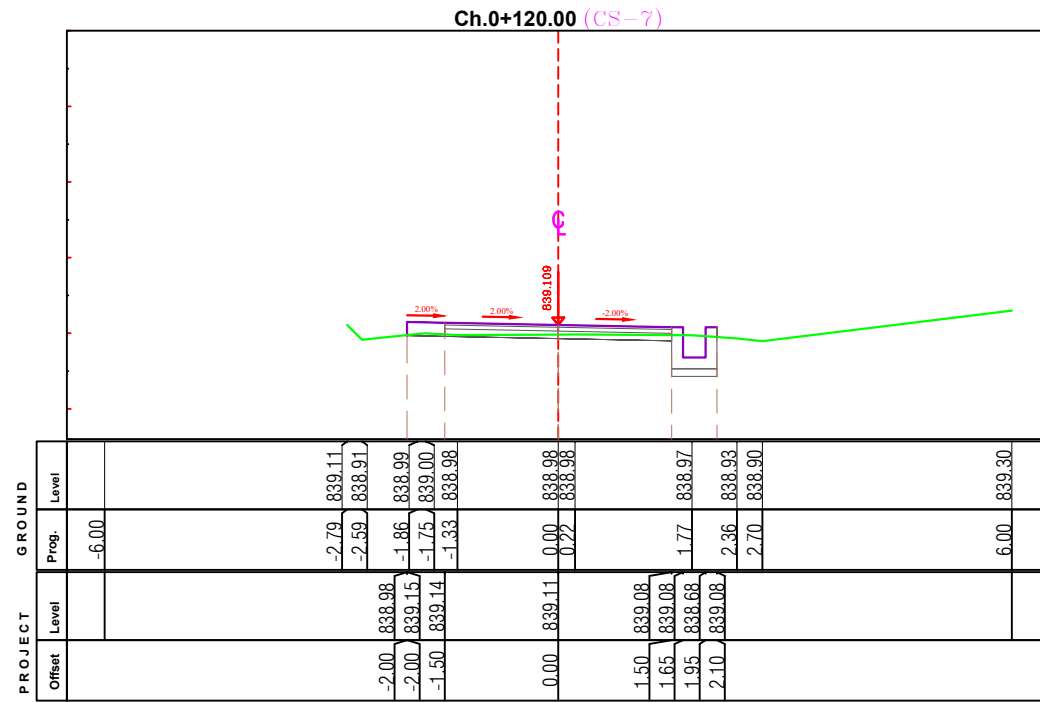

Porositesi
BASHKIA DIBER

Objekti: "SISTEMIM - ASFALTIM I RRUGËVE TË BRENDSHME TË FSHATIT GREVË, NJËSIA ADMINISTRATIVE MELAN, BASHKIA DIBËR"

Emertimi:
PROFLET TERTHORE

PROJEKT ZBATIMI

GRUPI PROJEKTUES	Ing.Hidro. Mark PEMAJ	Firma:	
	Ing.Top. Bilbil NURÇE	Firma:	
Periudha: SHTATOR 2024		Shkalla:	1:100
		Fleta:	Nr. 4

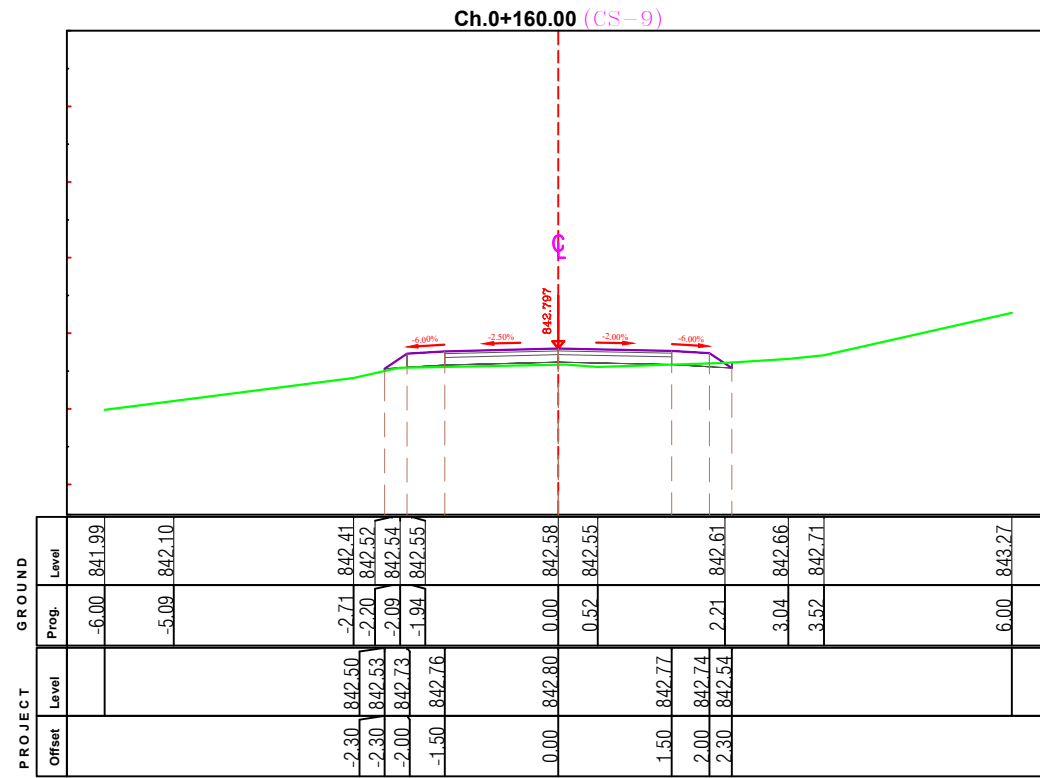

Porositesi
BASHKIA DIBER

Objekti: "SISTEMIM - ASFALTIM I RRUGËVE TË BRENDSHME TË FSHATIT GREVË, NJËSIA ADMINISTRATIVE MELAN, BASHKIA DIBËR"

Emertimi:

PROFLET TERTHORE

PROJEKT ZBATIMI

GRUPI PROJEKTUES

Ing.Hidro. Mark PEMAJ
Ing.Top. Bilbil NURÇE

Firma:
Firma:

Periudha:
SHTATOR 2024

Shkalla: 1:100
Fleta: Nr. 5

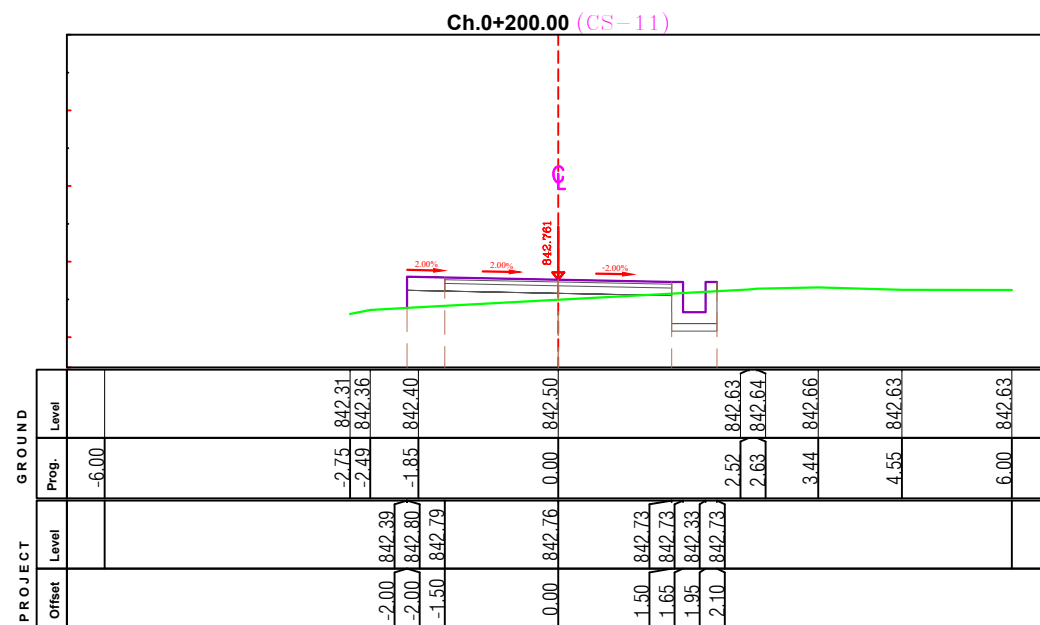
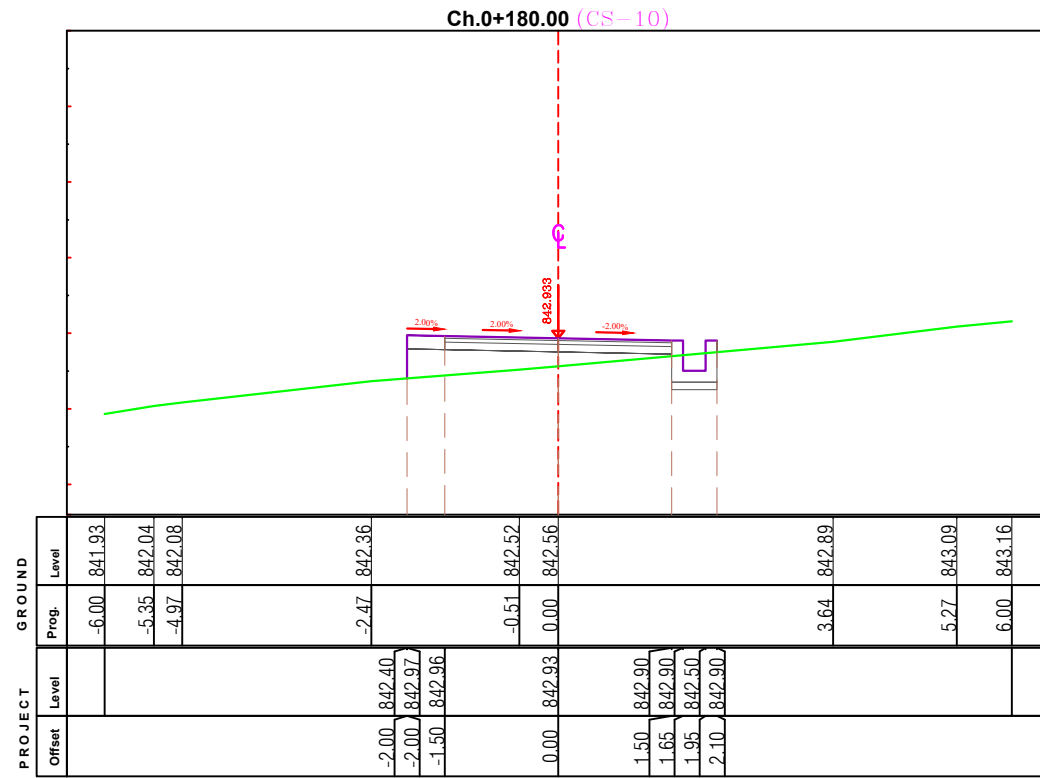

Porositesi
BASHKIA DIBER

Objekti: "SISTEMIM - ASFALTIM I RRUGËVE TË BRENDSHME TË FSHATIT GREVË, NJËSIA ADMINISTRATIVE MELAN, BASHKIA DIBËR"

Emertimi:

PROFLET TERTHORE

PROJEKT ZBATIMI

GRUPI PROJEKTUES	Ing.Hidro. Mark PEMAJ	Firma:	
	Ing.Top. Bilbil NURÇE	Firma:	
Periudha:		Shkalla:	1:100
SHTATOR 2024		Fleta:	Nr. 6

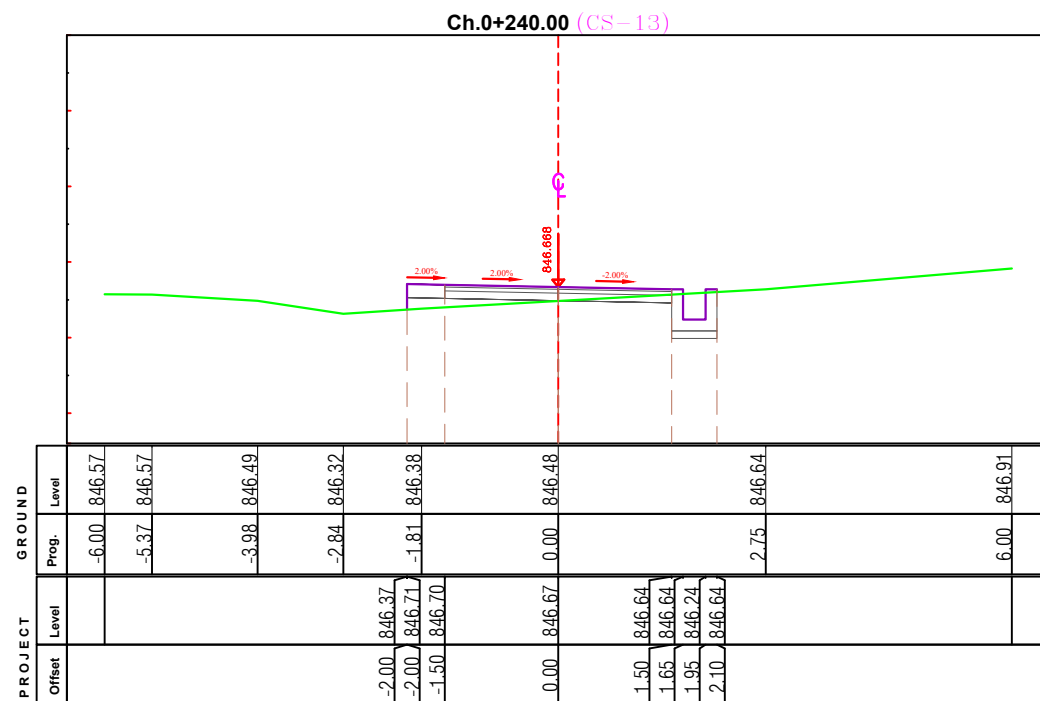
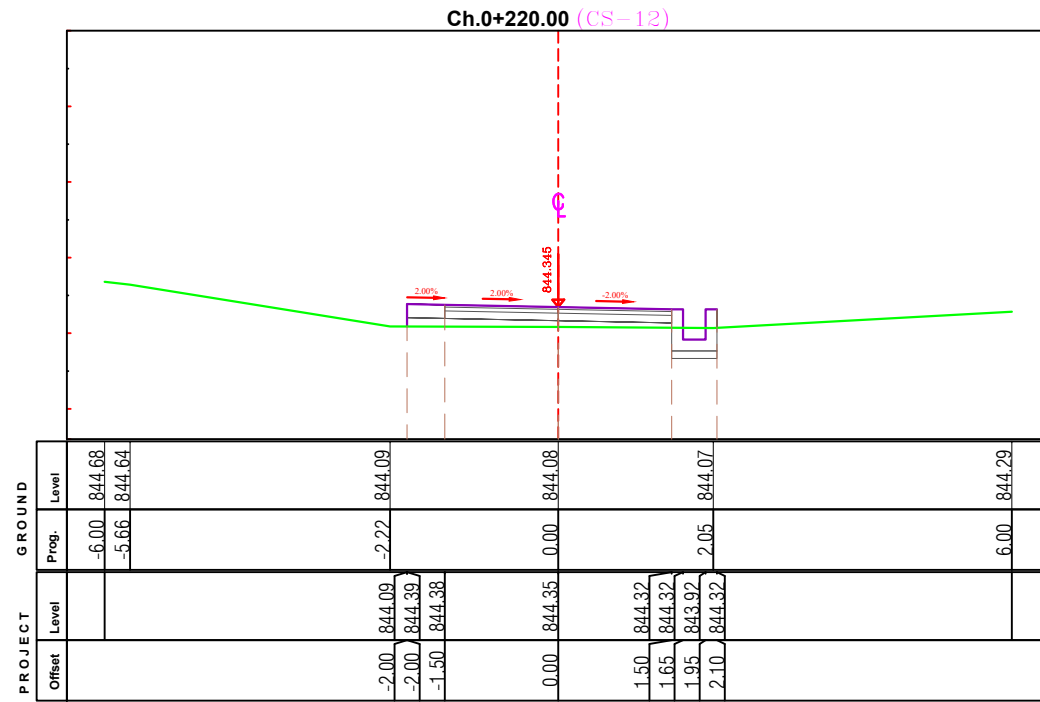

**Porositesi
BASHKIA DIBER**

Objekti: "SISTEMIM - ASFALTIM I RRUGËVE TË BRENDSHME TË FSHATIT GREVË, NJËSIA ADMINISTRATIVE MELAN, BASHKIA DIBËR"

Emertimi:

PROFILET TERTHORE

PROJEKT ZBATIMI

**GRUPI
PROJEKTUES**

Ing.Hidro. Mark PEMAJ
Ing.Top. Bilbil NURÇE

Firma:
Firma:

Periudha:
SHTATOR 2024

Shkalla: 1:100
Fleta: Nr. 7

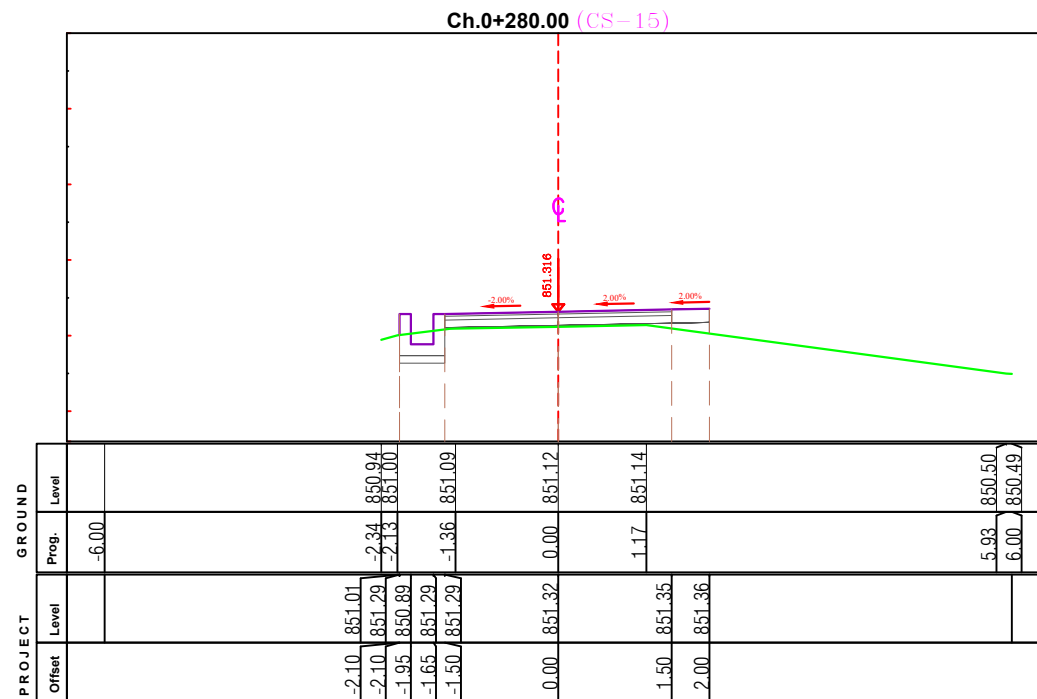
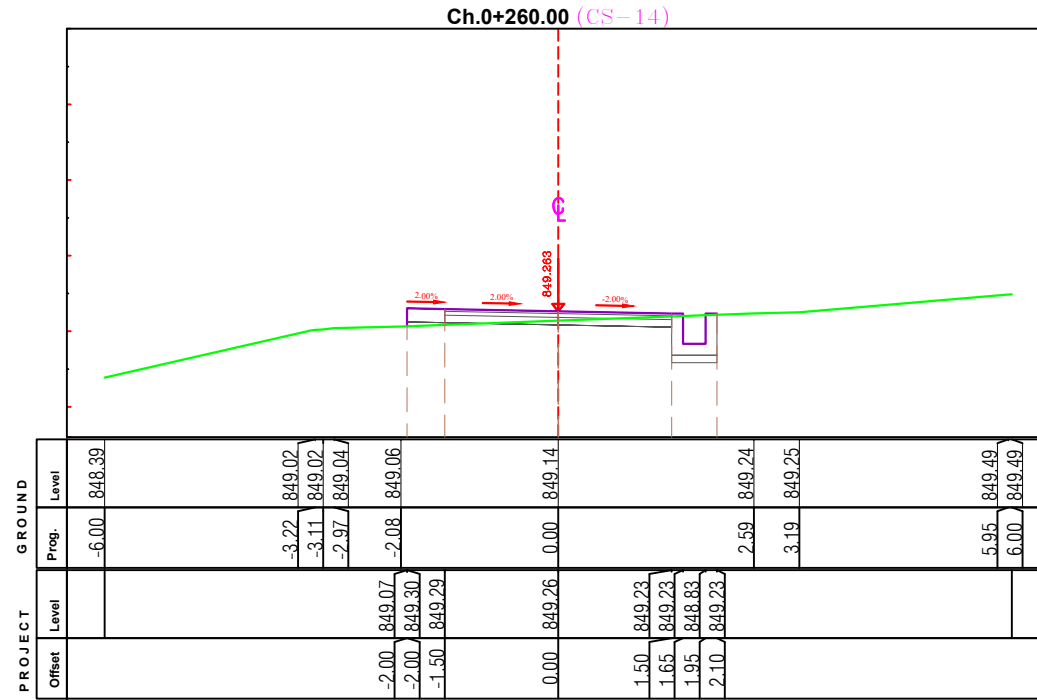

2D **PROJEKTIM**
DESIGN
SUPERVISION
KOLAUDIM

Adresa: Rruga "Barshy", Njesia Bashkiake nr. 8, TIRANE

Porositesi
BASHKIA DIBER

Objekti: "SISTEMIM - ASFALTIM I RRUGËVE TË BRENDSHME TË FSHATIT GREVË, NJËSIA ADMINISTRATIVE MELAN, BASHKIA DIBËR"

Emertimi:

PROFLET TERTHORE

PROJEKT ZBATIMI

GRUPI PROJEKTUES	Ing.Hidro. Mark PEMAJ	Firma:	
	Ing.Top. Bilbil NURÇE	Firma:	
Periudha:		Shkalla:	1:100
SHTATOR 2024		Fleta:	Nr. 8

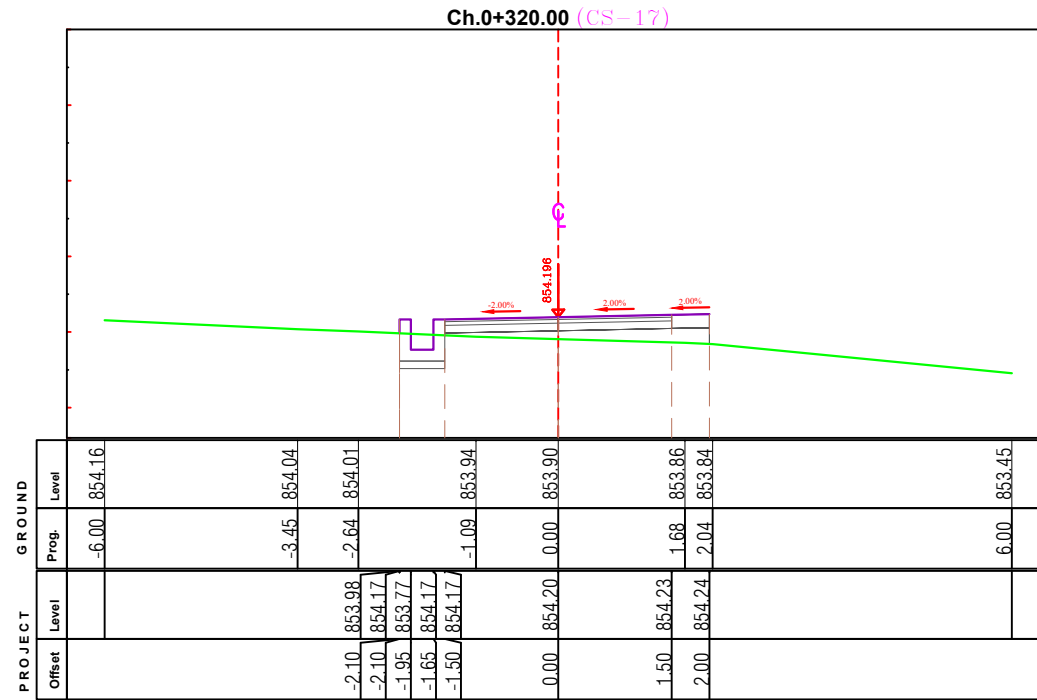
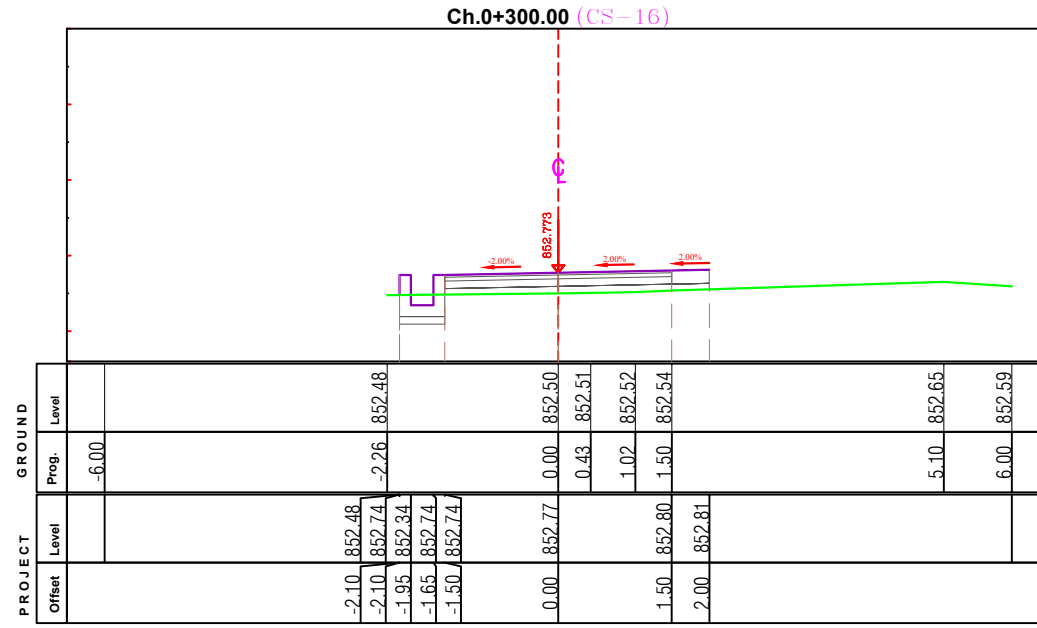

Porositesi
BASHKIA DIBER

Objekti: "SISTEMIM - ASFALTIM I RRUGËVE TË BRENDSHME TË FSHATIT GREVË, NJËSIA ADMINISTRATIVE MELAN, BASHKIA DIBËR"

Emertimi:
PROFLET TERTHORE

PROJEKT ZBATIMI

GRUPI PROJEKTUES	Ing.Hidro. Mark PEMAJ	Firma:	
	Ing.Top. Bilbil NURÇE	Firma:	
Periudha: SHTATOR 2024		Shkalla:	1:100
		Fleta:	Nr. 9

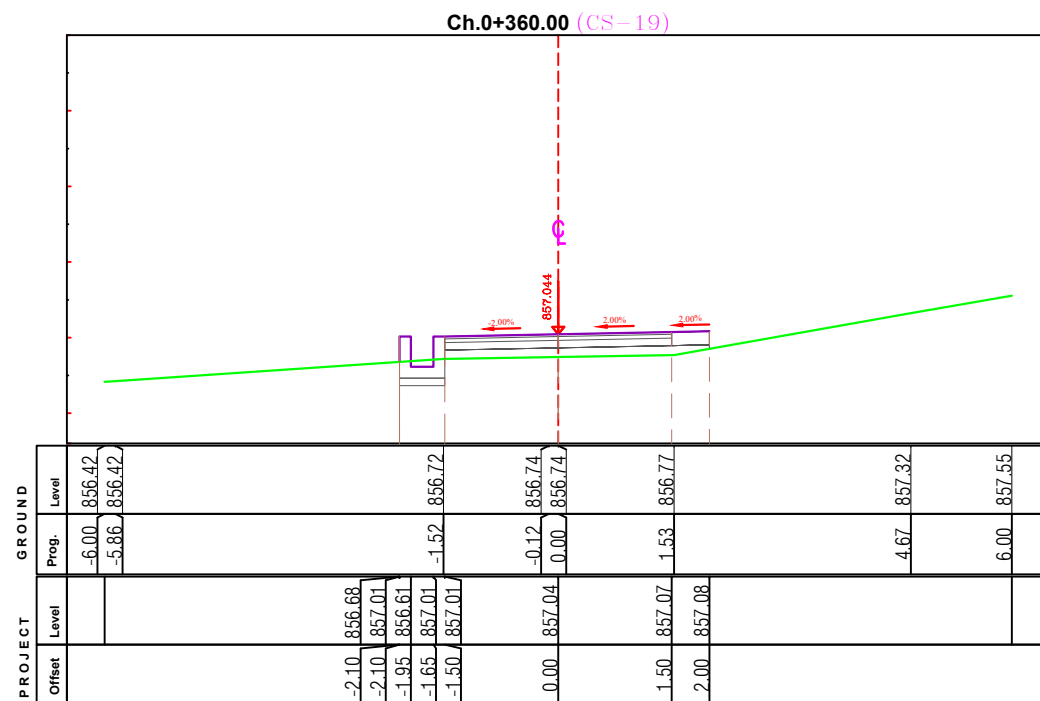
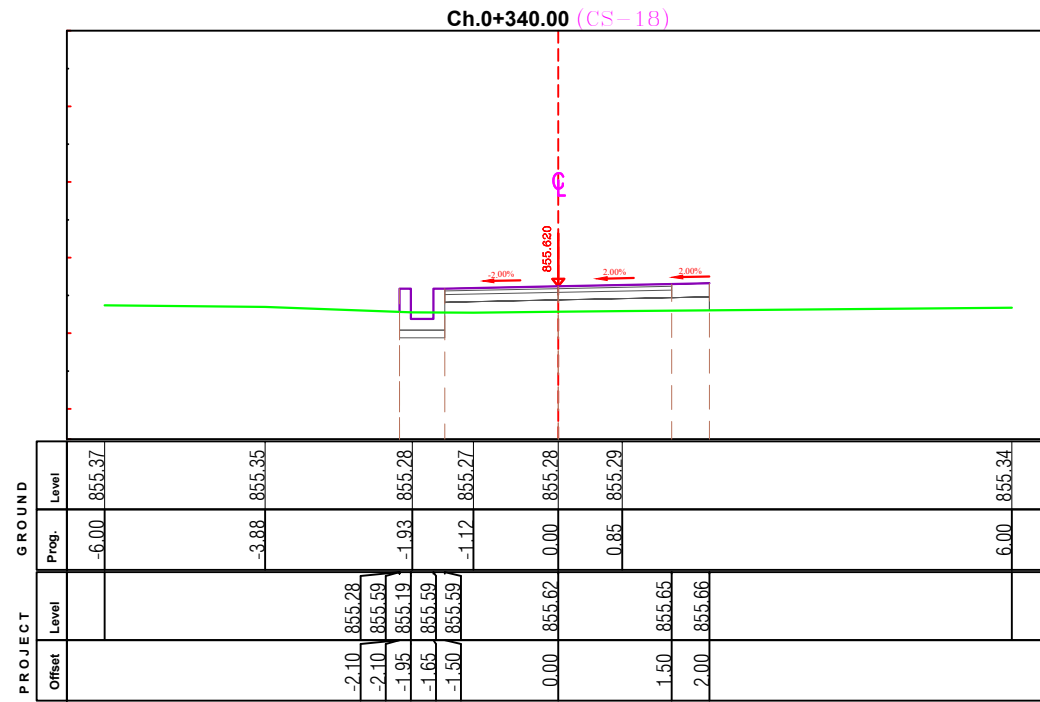

Porositesi
BASHKIA DIBER

Objekti: "SISTEMIM - ASFALTIM I RRUGËVE TË BRENDSHME TË FSHATIT GREVË, NJËSIA ADMINISTRATIVE MELAN, BASHKIA DIBËR"

Emertimi:
PROFLET TERTHORE

PROJEKT ZBATIMI

GRUPI PROJEKTUES	Ing.Hidro. Mark PEMAJ	Firma:	
	Ing.Top. Bilbil NURÇE	Firma:	
Periudha: SHTATOR 2024		Shkalla:	1:100
		Fleta:	Nr. 10

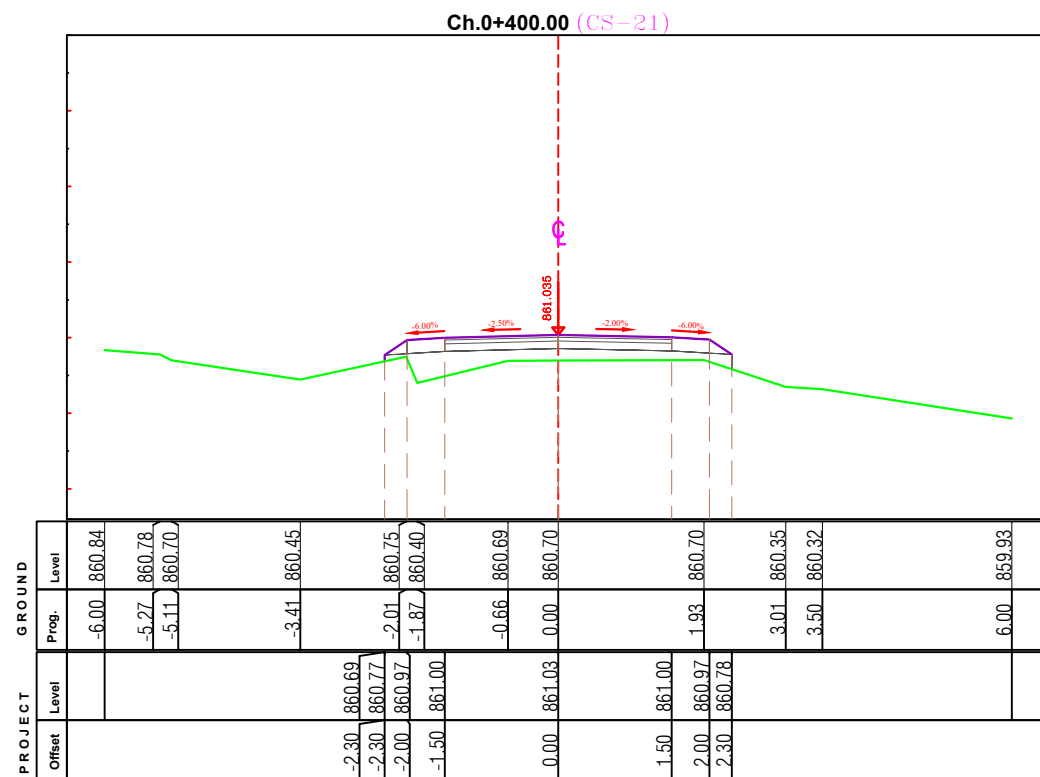
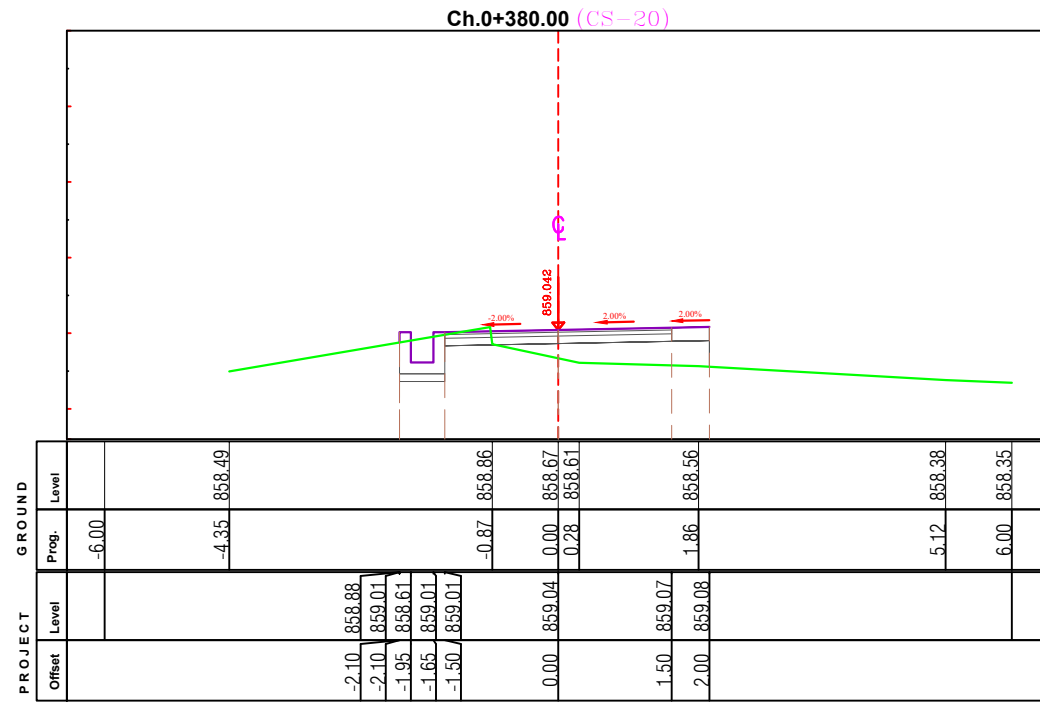

2D **PROJEKTIM
DESIGN
SUPERVISION
KOLAUDIM**

Adresa: Rruga "Barahyl", Njesia Bashkiake nr. 8, TIRANE

Porositesi
BASHKIA DIBER

Objekti: "SISTEMIM - ASFALTIM I RRUGËVE TË BRENDSHME TË FSHATIT GREVË, NJËSIA ADMINISTRATIVE MELAN, BASHKIA DIBËR"

Emertimi:

PROFLET TERTHORE

PROJEKT ZBATIMI

GRUPI PROJEKTUES	Ing.Hidro. Mark PEMAJ	Firma:	
	Ing.Top. Bilbil NURÇE	Firma:	
Periudha:		Shkalla:	1:100
SHTATOR 2024		Fleta:	Nr. 11

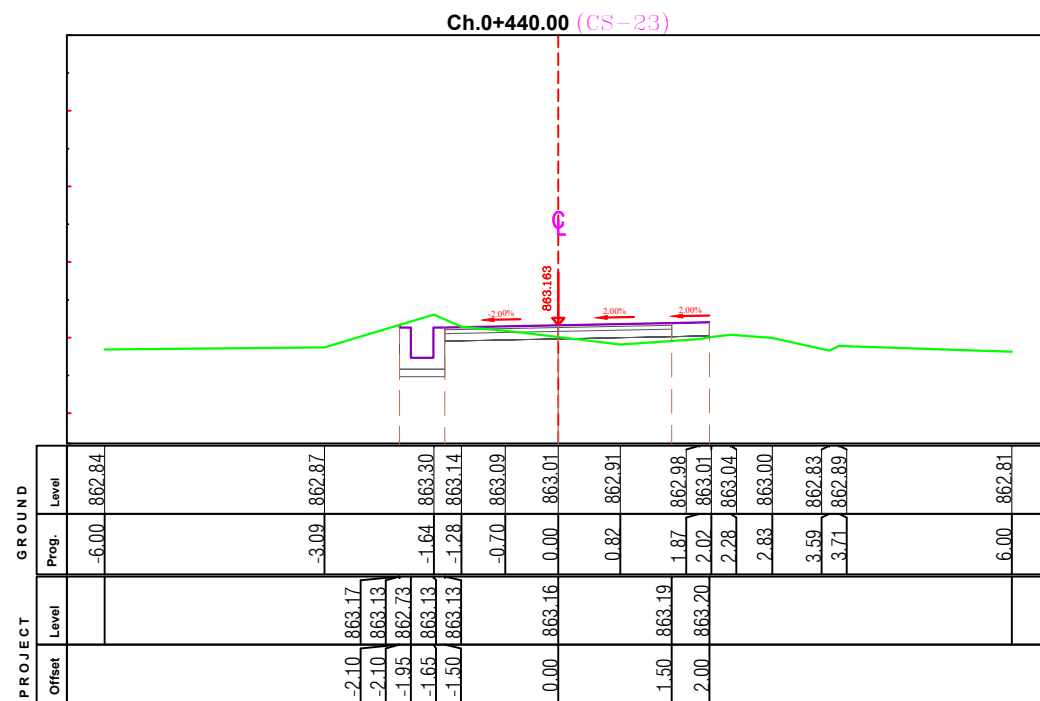
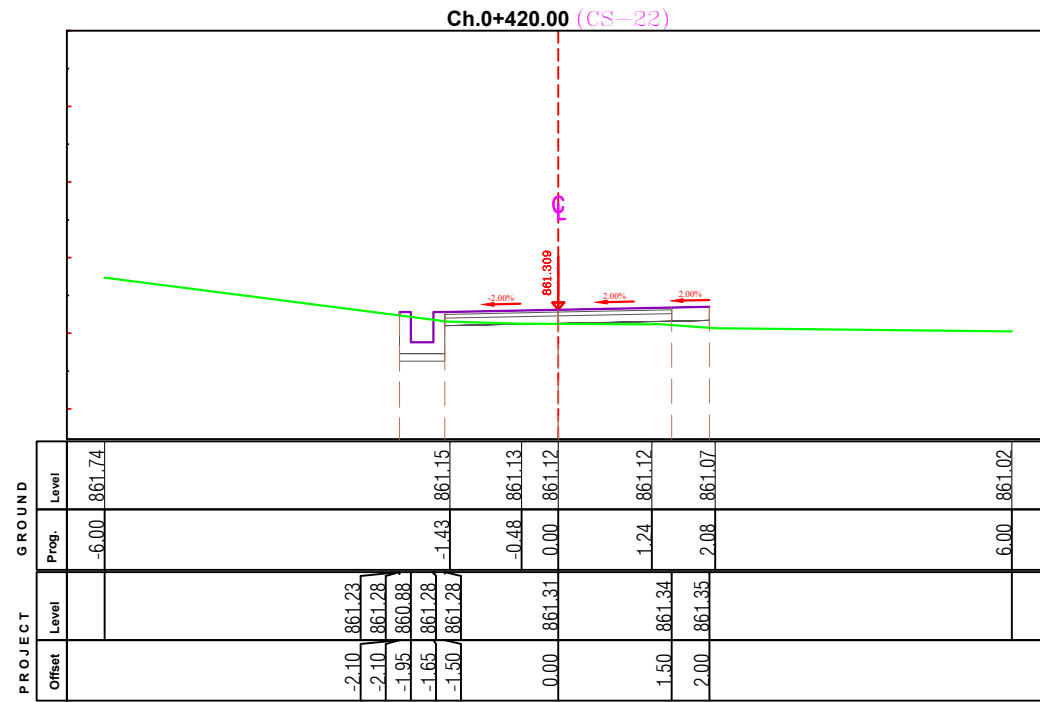

**Porositesi
BASHKIA DIBER**

Objekti: "SISTEMIM - ASFALTIM I RRUGËVE TË BRENDSHME TË FSHATIT GREVË, NJËSIA ADMINISTRATIVE MELAN, BASHKIA DIBËR"

Emertimi:
PROFLET TERTHORE

PROJEKT ZBATIMI

GRUPI PROJEKTUES	Ing.Hidro. Mark PEMAJ	Firma:	
	Ing.Top. Bilbil NURÇE	Firma:	
Periudha: SHTATOR 2024		Shkalla:	1:100
		Fleta:	Nr. 12

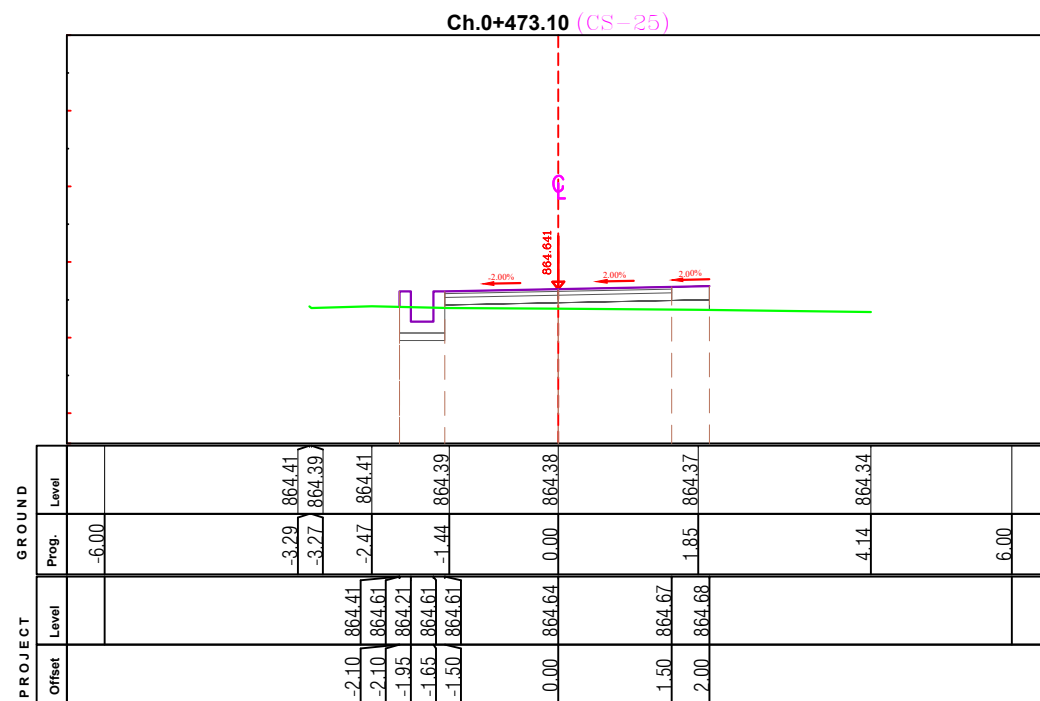
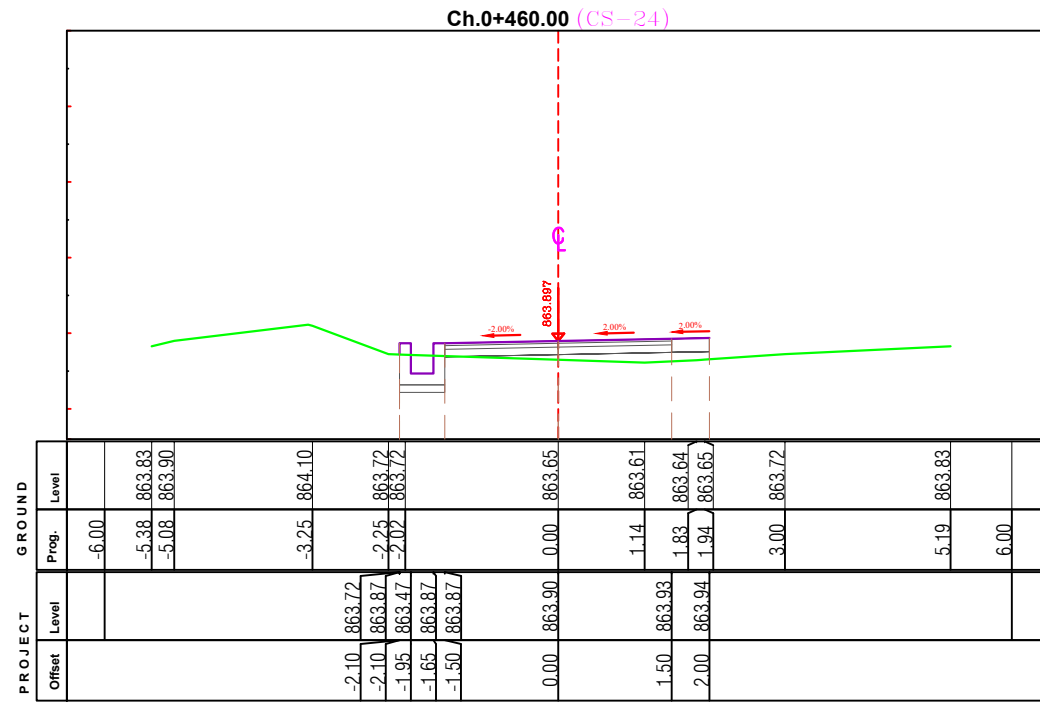

2D **PROJEKTIM
DESIGN
SUPERVISION
KOLAUDIM**

Adresa: Rruga "Barahy", Njesia Bashkiake nr. 8, TIRANË

Porositesi
BASHKIA DIBER

Objekti: "SISTEMIM - ASFALTIM I RRUGËVE TË BRENDSHME TË FSHATIT GREVË, NJËSIA ADMINISTRATIVE MELAN, BASHKIA DIBËR"

Emertimi:

PROFLET TERTHORE

PROJEKT ZBATIMI

GRUPI PROJEKTUES	Ing.Hidro. Mark PEMAJ	Firma:	
	Ing.Top. Bilbil NURÇE	Firma:	
Periudha:		Shkalla:	1:100
SHTATOR 2024		Fleta:	Nr. 13

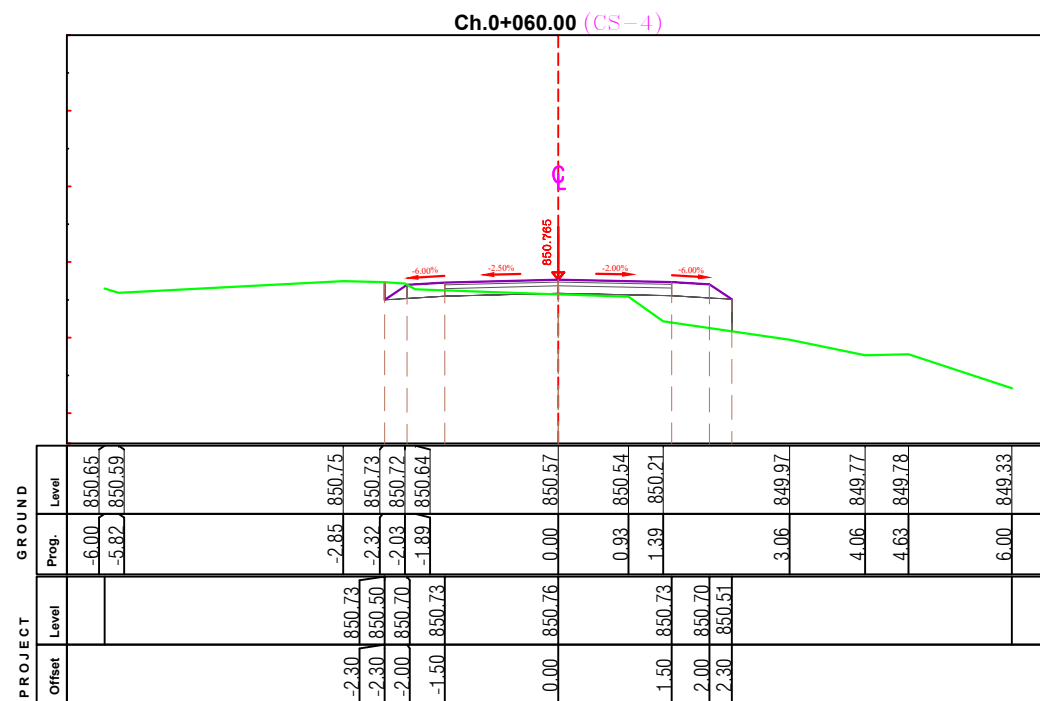
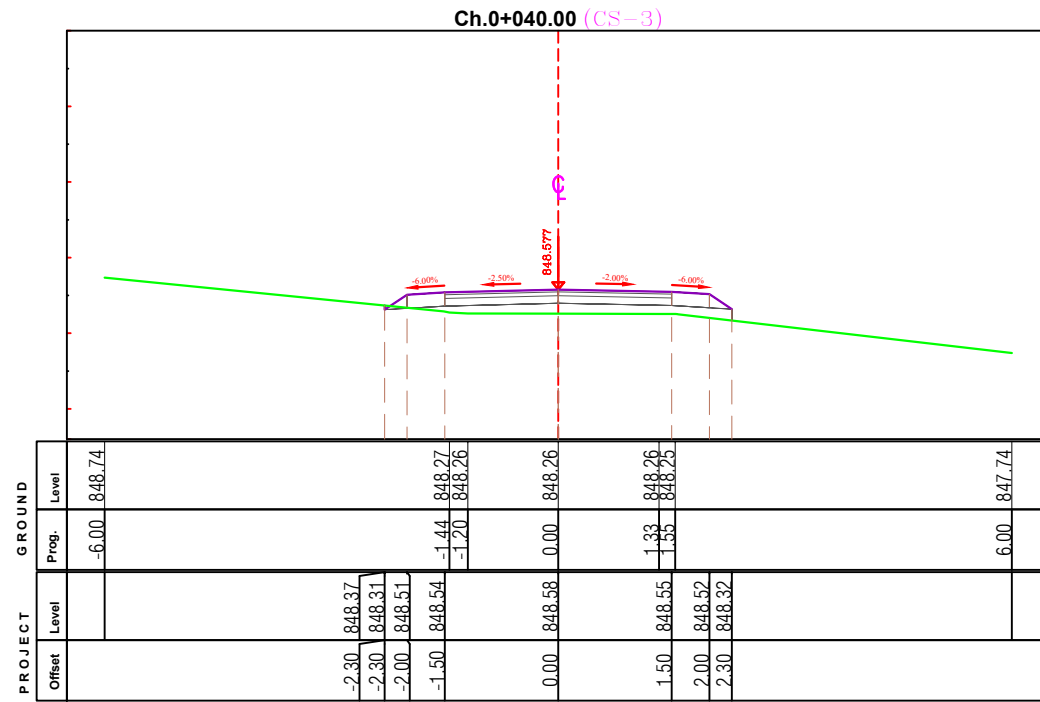

2D **PROJEKTIM
DESIGN
SUPERVISION
KOLAUDIM**

Adresa: Rruga "Barahy", Njesia Bashkiake nr. 8, TIRANE

**Porositesi
BASHKIA DIBER**

Objekti: "SISTEMIM - ASFALTIM I
RRUGËVE TË BRENDSHME TË FSHATIT
GREVË, NJËSIA ADMINISTRATIVE MELAN,
BASHKIA DIBËR"

Emertimi:

PROFLET TERTHORE

PROJEKT ZBATIMI

GRUPI PROJEKTUES	Ing.Hidro. Mark PEMAJ	Firma:	
	Ing.Top. Bilbil NURÇE	Firma:	
Periudha:		Shkalla:	1:100
SHTATOR 2024		Fleta:	Nr. 2

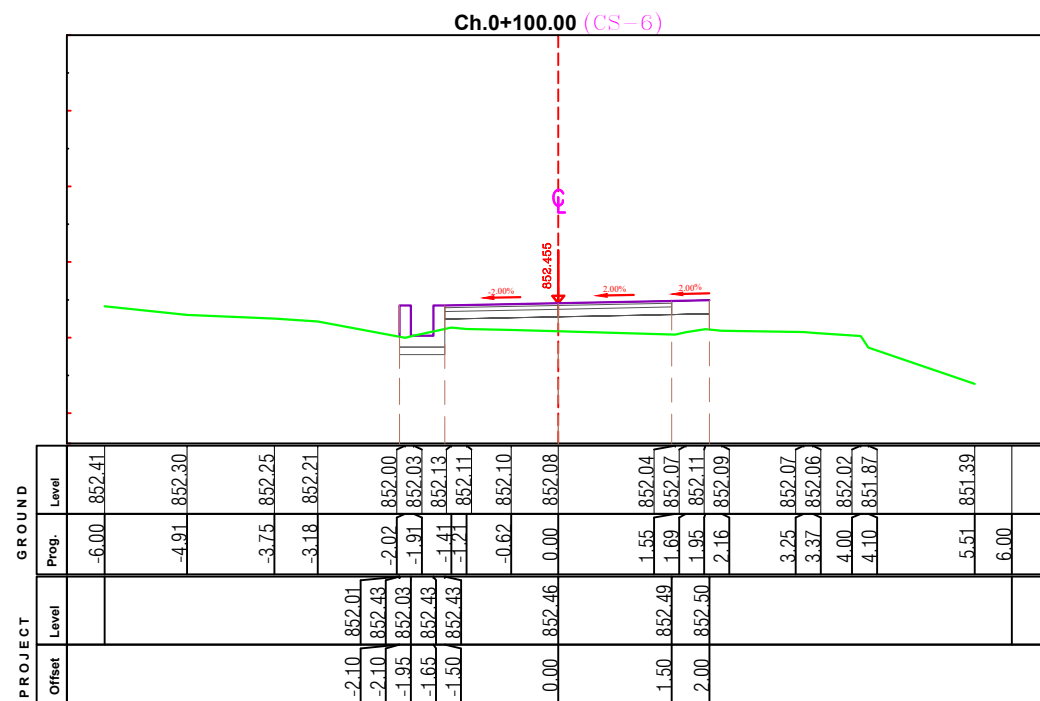
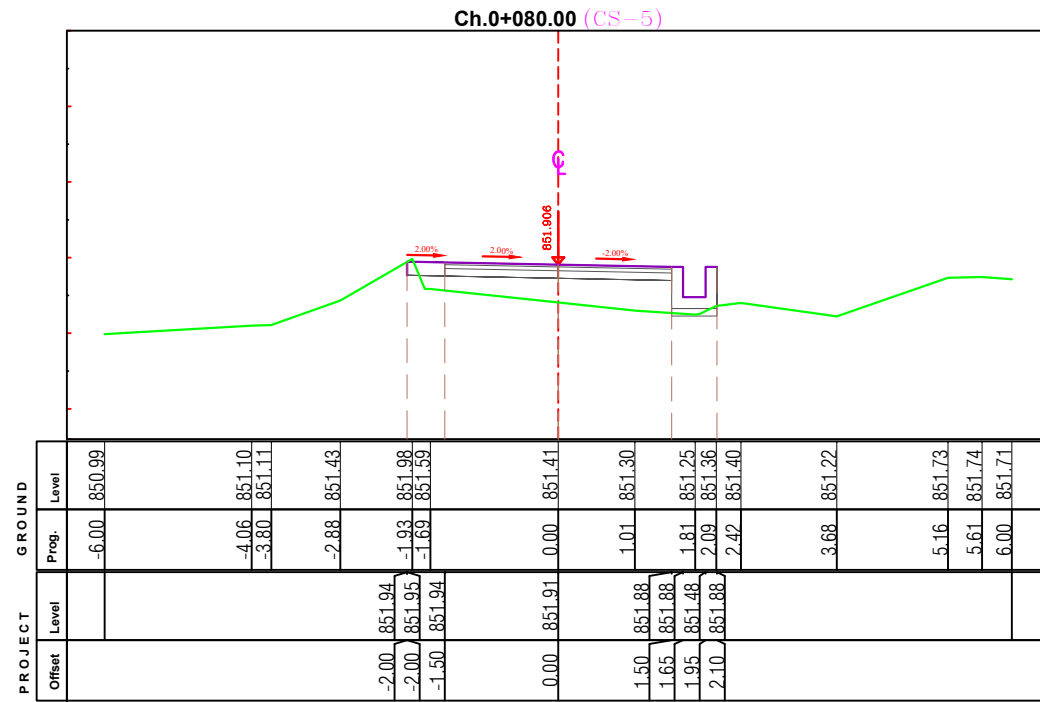

Porositesi
BASHKIA DIBER

Objekti: "SISTEMIM - ASFALTIM I RRUGËVE TË BRENDSHME TË FSHATIT GREVË, NJËSIA ADMINISTRATIVE MELAN, BASHKIA DIBËR"

Emertimi:
PROFLET TERTHORE

PROJEKT ZBATIMI

GRUPI PROJEKTUES	Ing.Hidro. Mark PEMAJ	Firma:	
	Ing.Top. Bilbil NURÇE	Firma:	
Periudha: SHTATOR 2024		Shkalla:	1:100
		Fleta:	Nr. 3

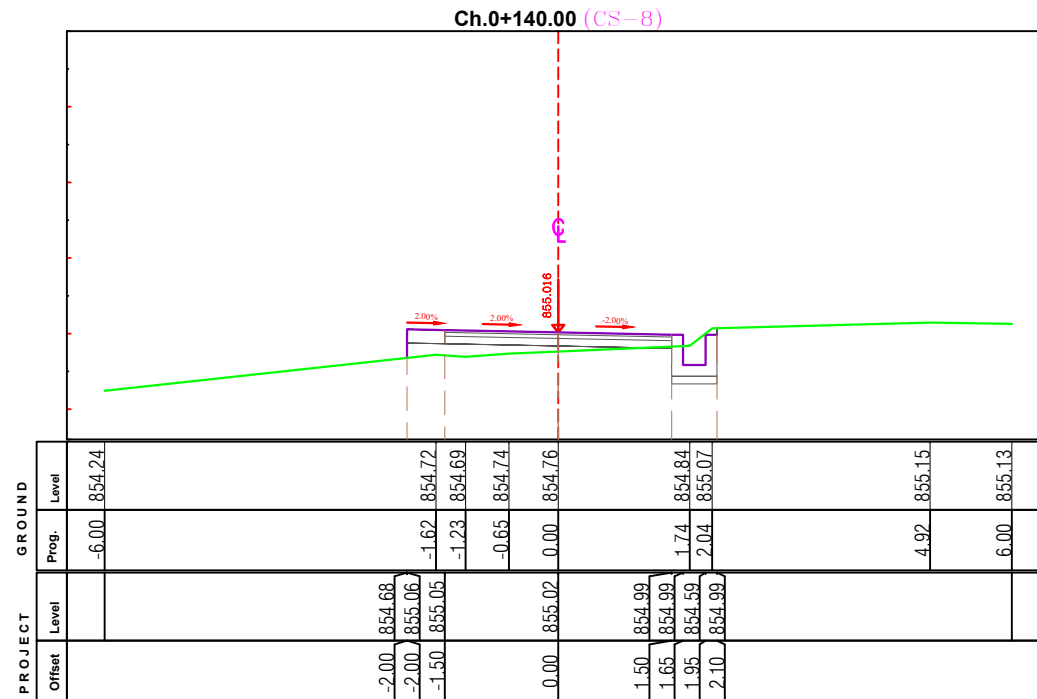
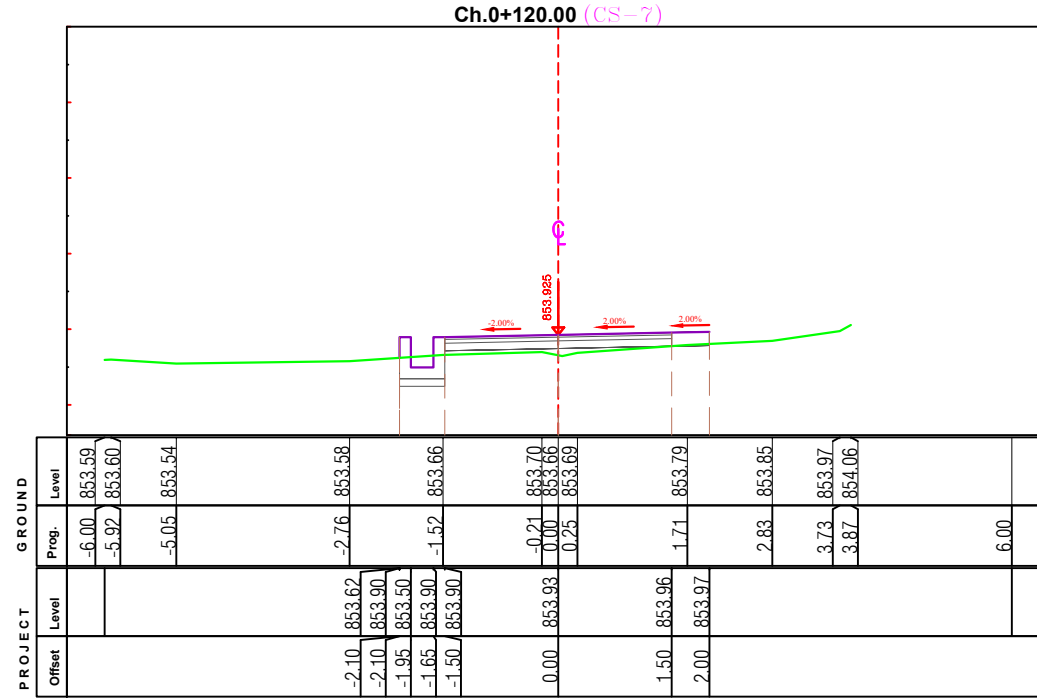

Porositesi
BASHKIA DIBER

Objekti: "SISTEMIM - ASFALTIM I RRUGËVE TË BRENDSHME TË FSHATIT GREVË, NJËSIA ADMINISTRATIVE MELAN, BASHKIA DIBËR"

Emertimi:
PROFLET TERTHORE

PROJEKT ZBATIMI

GRUPI PROJEKTUES	Ing.Hidro. Mark PEMAJ	Firma:	
	Ing.Top. Bilbil NURÇE	Firma:	
Periudha:		Shkalla:	1:100
SHTATOR 2024		Fleta:	Nr. 4

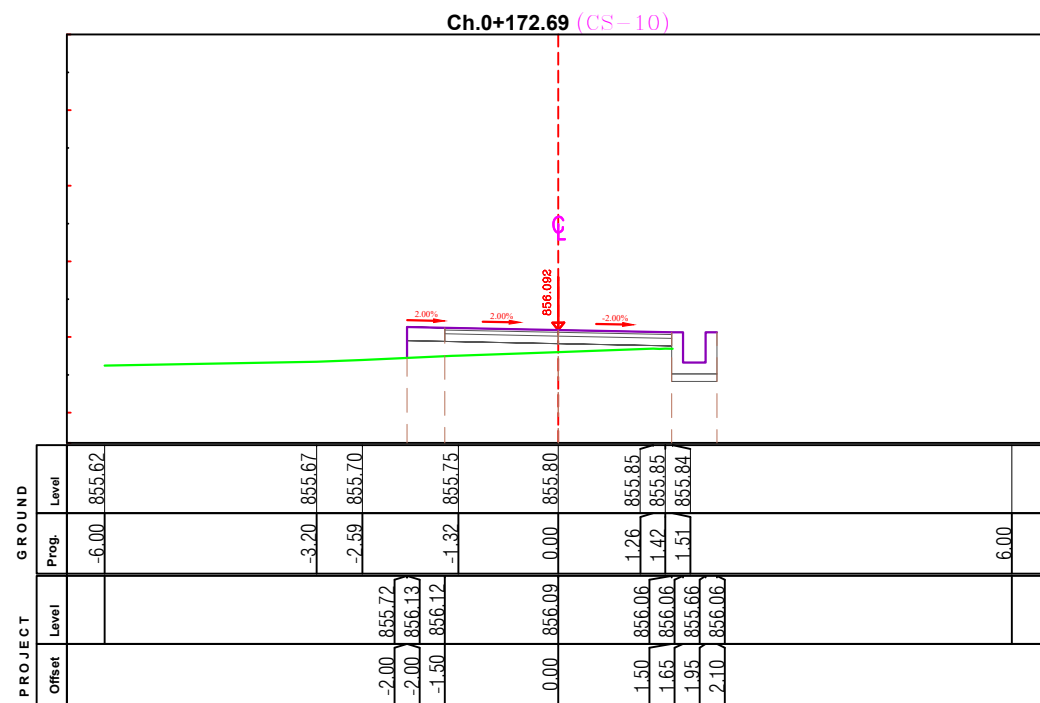
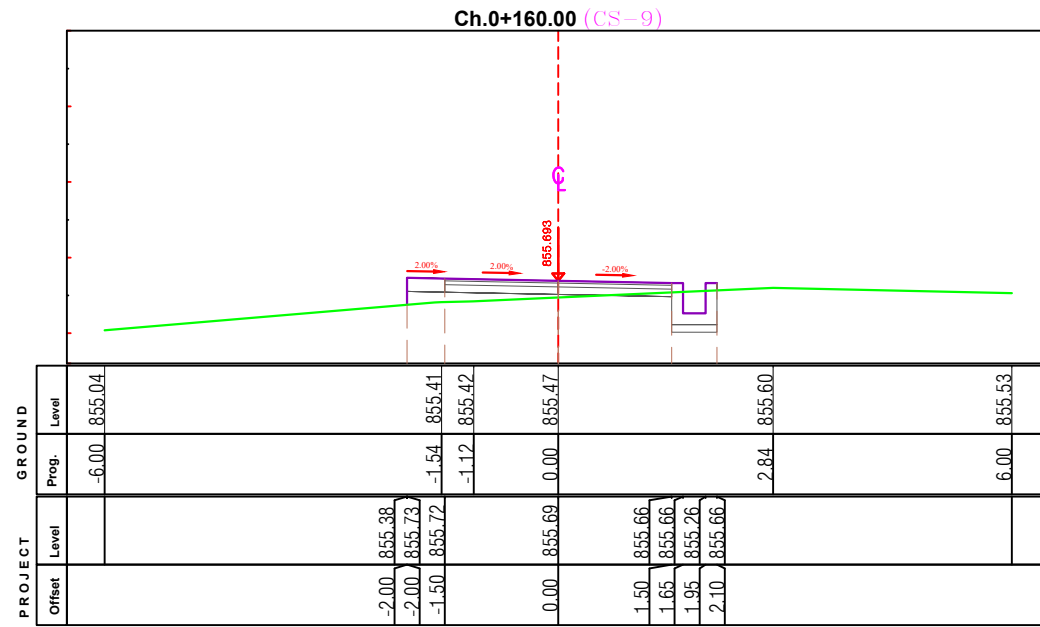

Porositesi
BASHKIA DIBER

Objekti: "SISTEMIM - ASFALTIM I RRUGËVE TË BRENDSHME TË FSHATIT GREVË, NJËSIA ADMINISTRATIVE MELAN, BASHKIA DIBËR"

Emertimi:
PROFLET TERTHORE

PROJEKT ZBATIMI

GRUPI PROJEKTUES	Ing.Hidro. Mark PEMAJ	Firma:	
	Ing.Top. Bilbil NURÇE	Firma:	
Periudha: SHTATOR 2024		Shkalla:	1:100
		Fleta:	Nr. 5

Profili terthor tip 1 i rrugeve te brendshme Greve

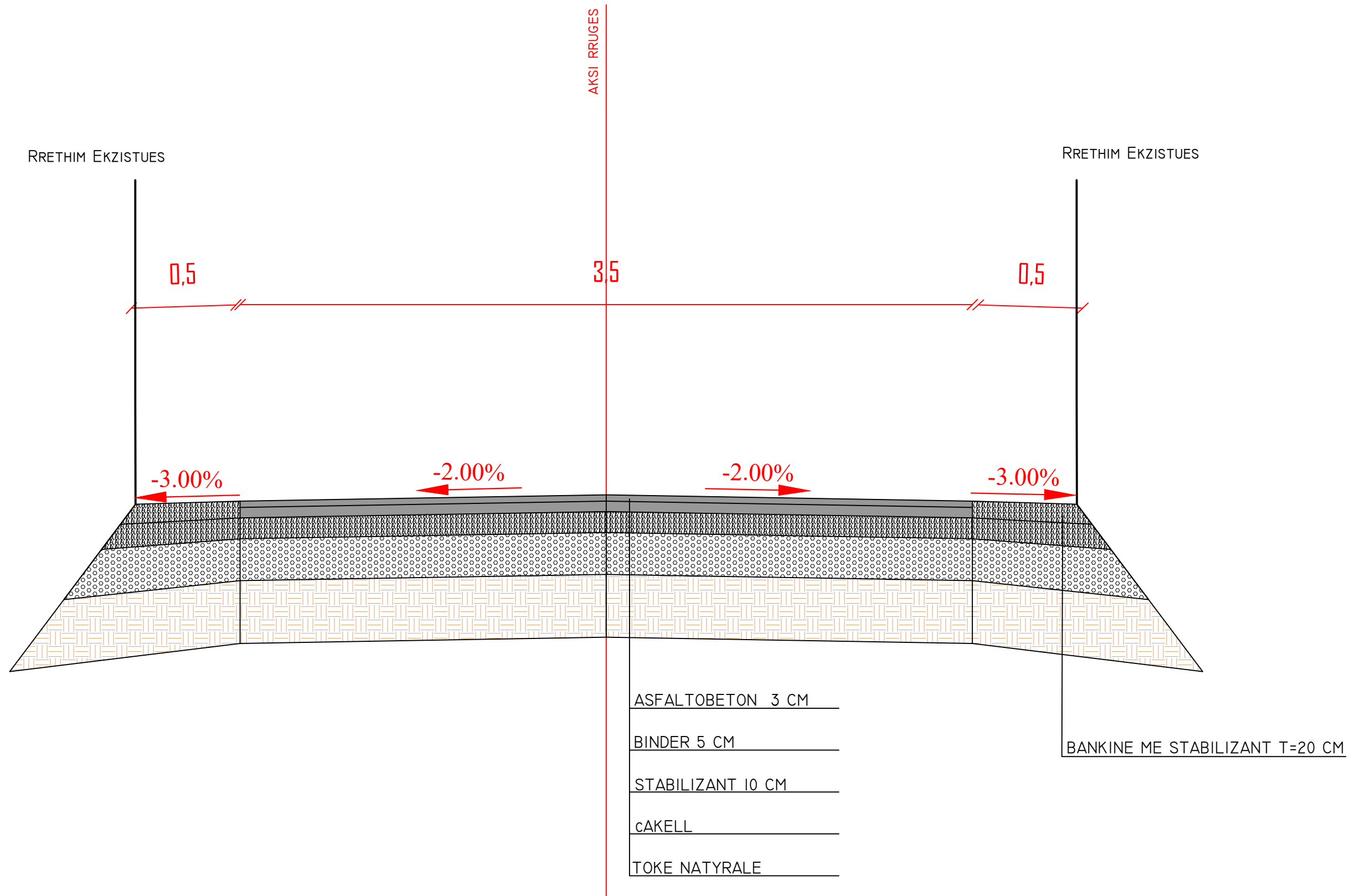

2D PROJEKTIM
DESIGN
SUPERVISION
KOLAUDIM
Adresa: Rruga "Barahy", Njesia Bashkiake nr. 8, TIRANE



Porositesi
BASHKIA DIBER

Objekti: "SISTEMIM - ASFALTIM I
RRUGEVE TE BRENDESHME TE
FSHATIT GREVE".

Emertimi:

PROFIL TIP I RRUGES

PROJEKT ZBATIMI

GRUPI
PROJEKTUES

Ing.Hidro. Mark PEMAJ
Ing.Top. Bilbil NURÇE

Firma:
Firma:

Periudha:
SHTATOR 2024

Shkalla: 1:500
Fleta: Nr. 1

Profili terthor tip 2 i rrugeve te brendshme Greve

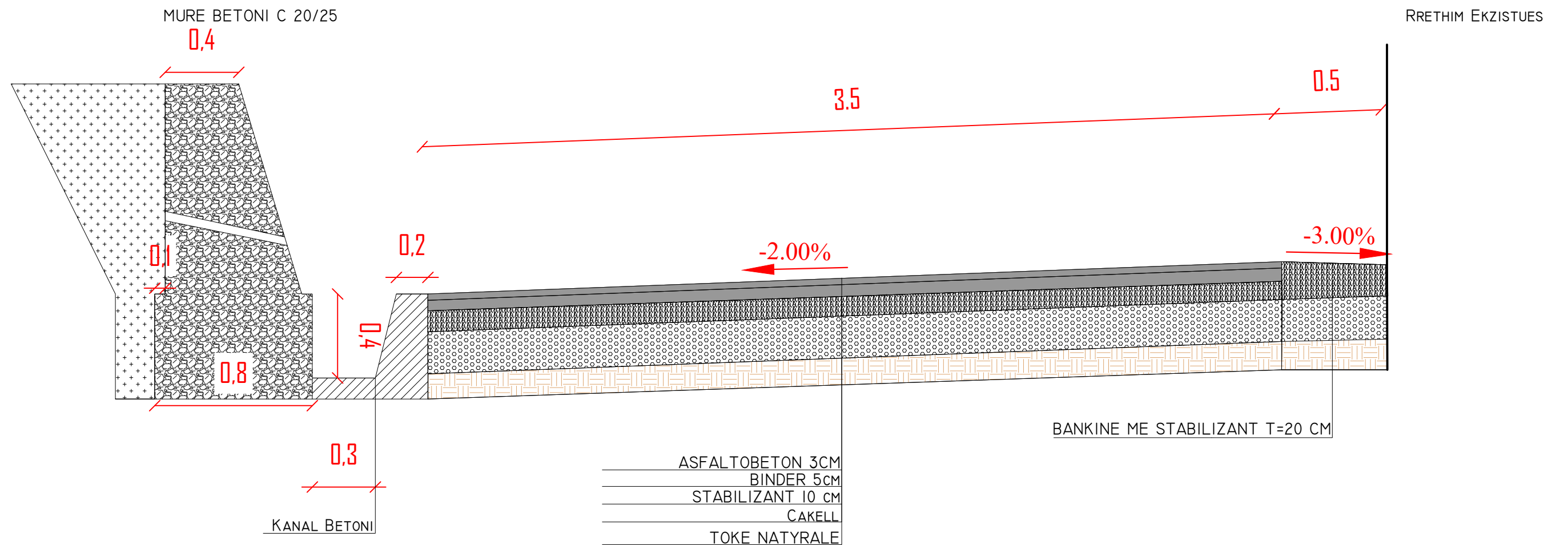

2D PROJEKTIM
DESIGN
SUPERVISION
KOLAUDIM
Adresa: Rruga "Barahy", Njesia Bashkiake nr. 8, TIRANE



Porositesi
BASHKIA DIBER

Objekti: "SISTEMIM - ASFALTIM I
RRUGEVE TE BRENDESHME TE
FSHATIT GREVE".

Emertimi:

PROFIL TIP I RRUGES

PROJEKT ZBATIMI

GRUPI
PROJEKTUES

Ing.Hidro. Mark PEMAJ
Ing.Top. Bilbil NURÇE

Firma:
Firma:

Periudha:
SHTATOR 2024

Shkalla: 1:500
Fleta: Nr. 2

Profili terthor tip 3 i rrugeve te brendshme Greve

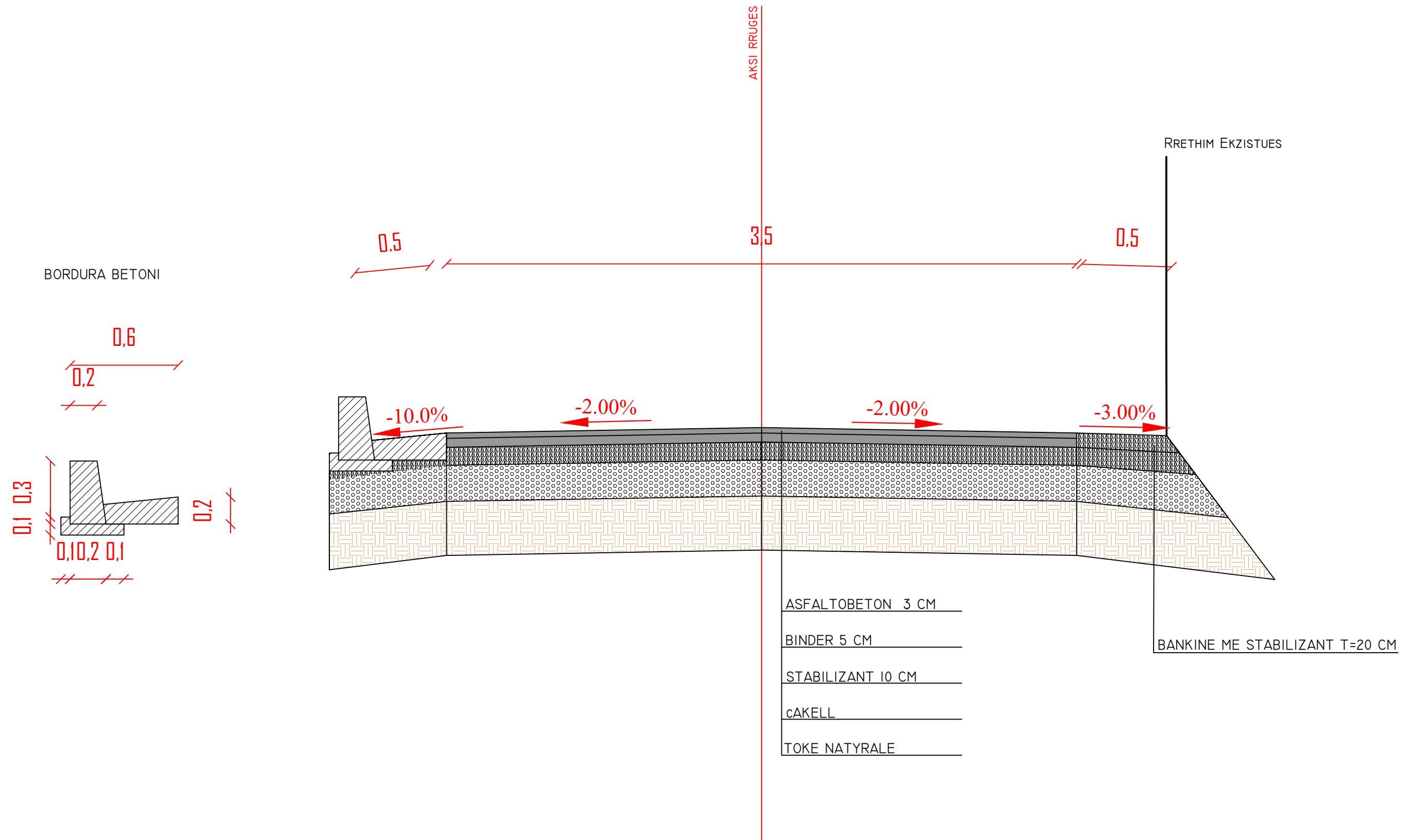

2D PROJEKTIM
DESIGN
SUPERVISION
KOLAUDIM
Adresa: Rruga "Barahy", Njesia Bashkiake nr. 8, TIRANE



Porositesi
BASHKIA DIBER

Objekti: "SISTEMIM - ASFALTIM I RRUGEVE TE BRENDESHME TE FSHATIT GREVE".

Emertimi:

PROFIL TIP I RRUGES

PROJEKT ZBATIMI

GRUPI
PROJEKTUES

Ing.Hidro. Mark PEMAJ
Ing.Top. Bilbil NURÇE

Firma:
Firma:

Periudha:
SHTATOR 2024

Shkalla: 1:500
Fleta: Nr. 3

PRERJE TERTHORE E KANALIT PER TUB MERALIK Ø 219mm

PAMJE E PORTALIT

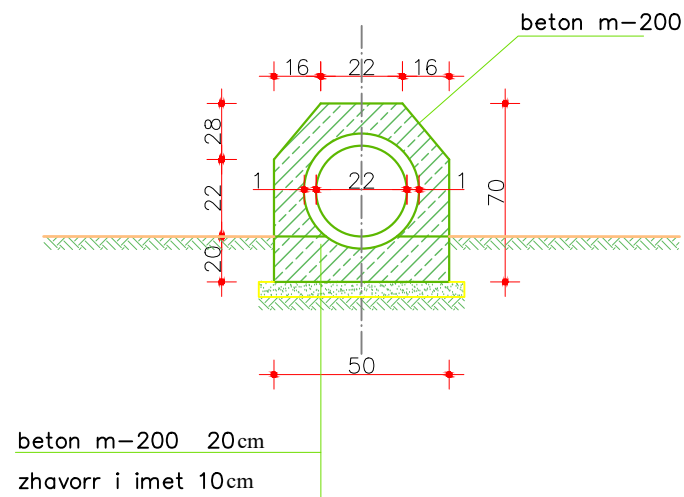

SHTRESAT E RRUGES

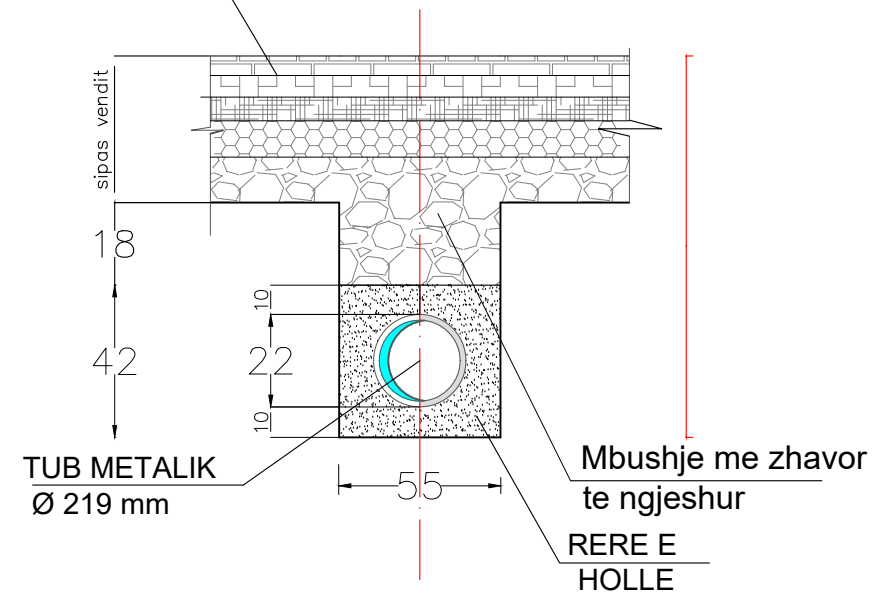

MURE BETONI C 20/25

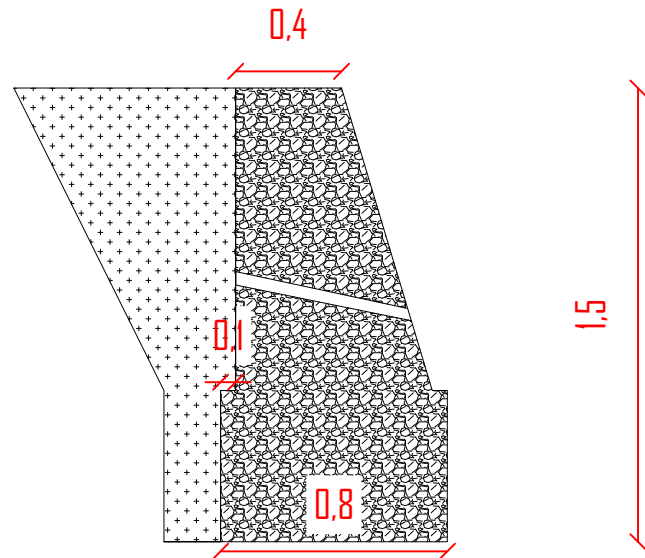

SHTRESAT RRUGORE

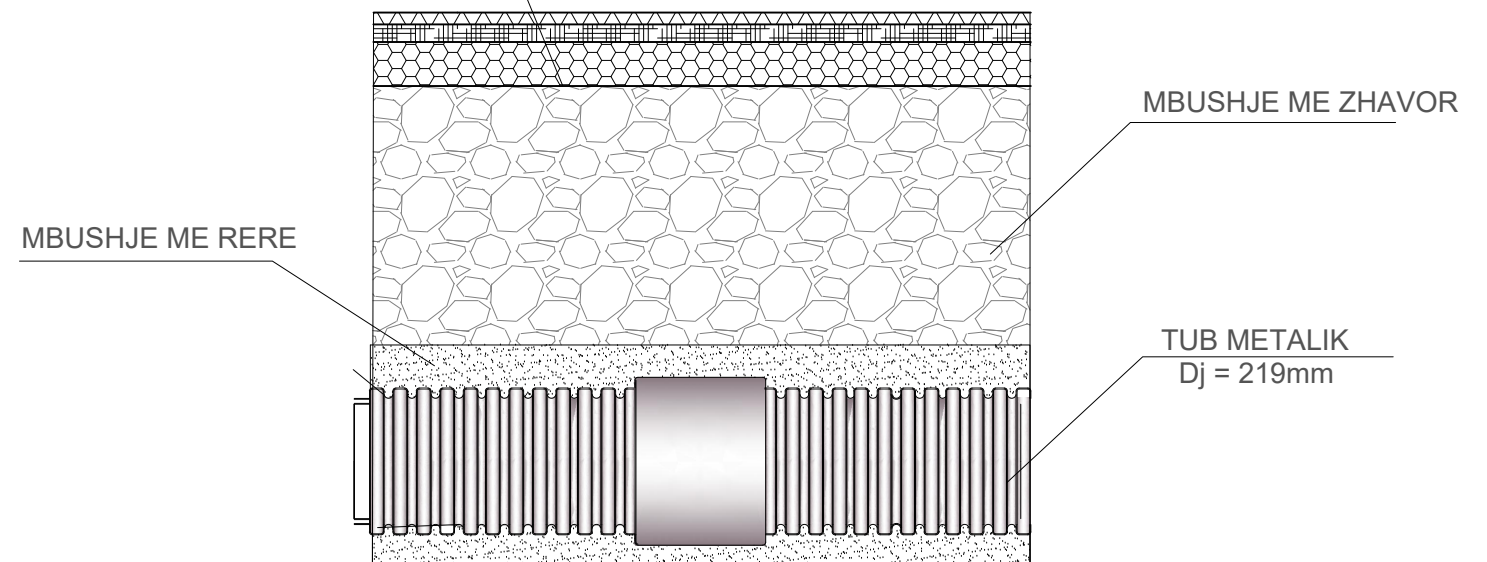

2D PROJEKTIM
DESIGN
SUPERVISION
KOLAUDIM
Adresa: Rruga "Barahy", Njesia Bashkiake nr. 8, TIRANE



Porositesi
BASHKIA DIBER

Objekti: "SISTEMIM - ASFALTIM I
RRUGEVE TE BRENDESHME TE
FSHATIT GREVE".

Emertimi:

DETAJE TE NDRYSHME

PROJEKT ZBATIMI

GRUPI
PROJEKTUES

Ing.Hidro. Mark PEMAJ
Ing.Top. Bilbil NURÇE

Firma:
Firma:

Periudha:

SHTATOR 2024

Shkalla: 1:500
Fleta: Nr. 2

PRERJE GJATESORE E TOMBINOS SH. 1:50

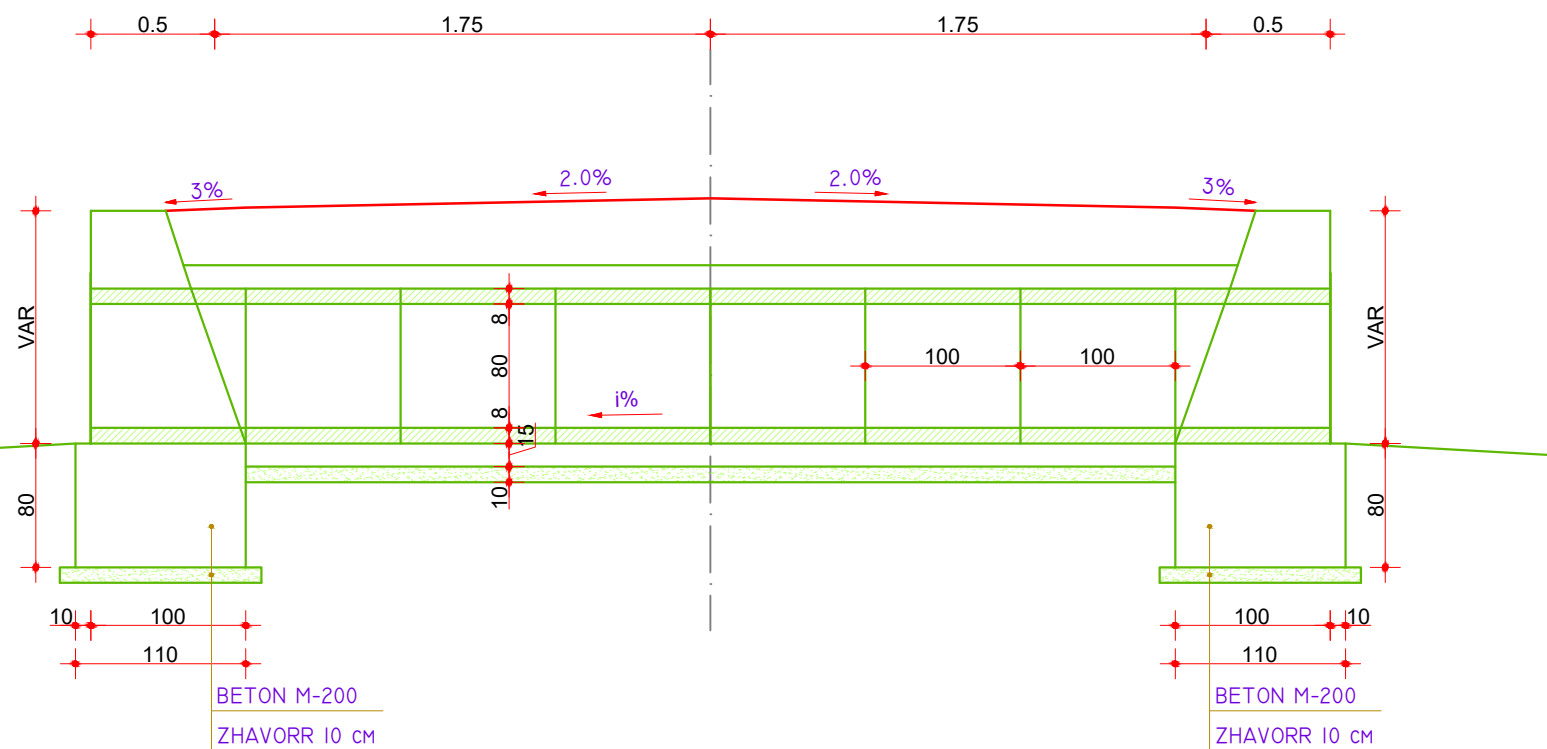

KONSTRUKSION I ZBULUAR SH. 1:50

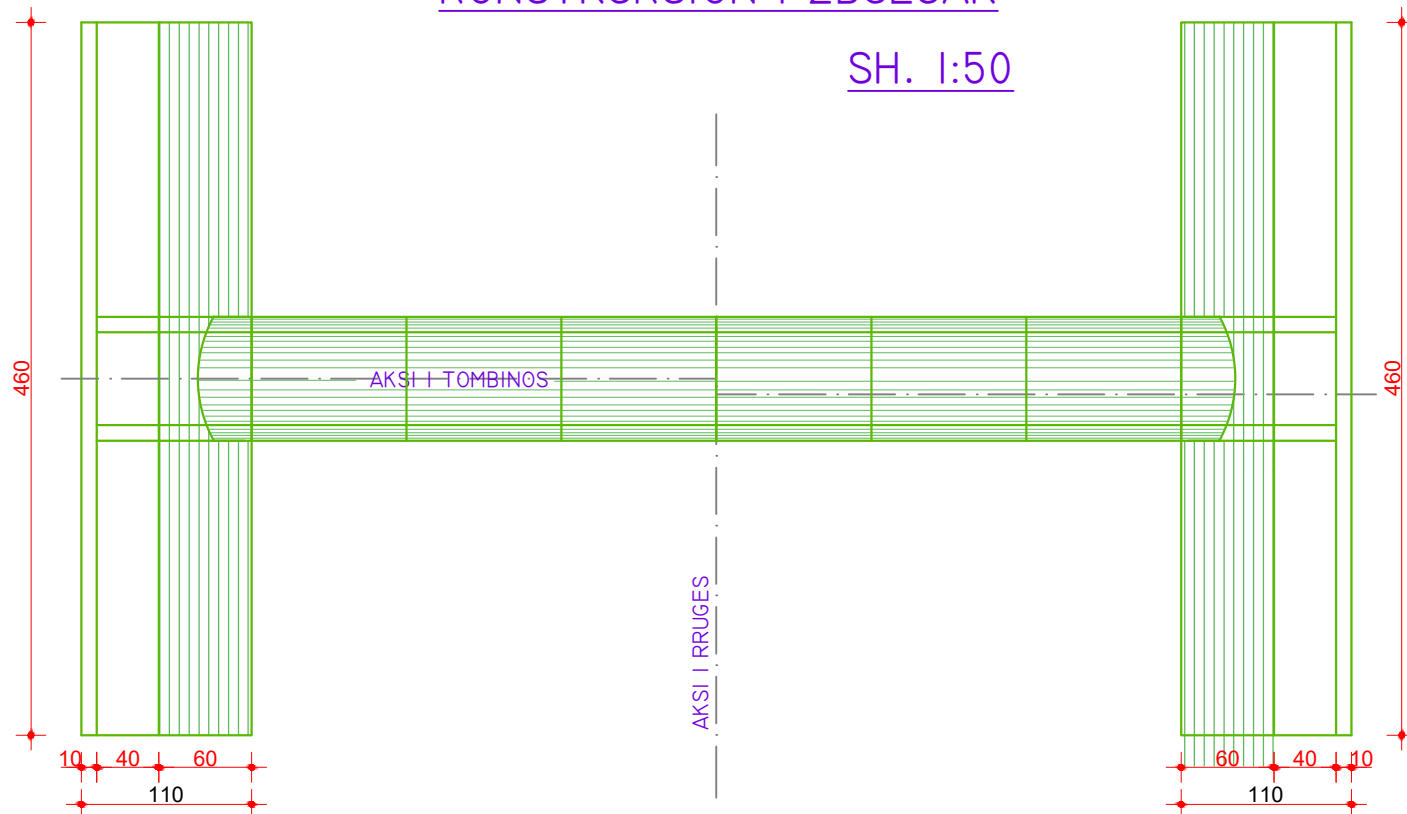

Shenim:

1. Ky projekt tip eshte parashikuar per terrene prej dherash
2. Per rastin e terreneve jo te pjerrtet tombino zbatohet ne te dy anet me portal.
3. Portalet dhe pusetat do te jene M-200 ndersa betoni i shtreses m-150.

TOMBINO TIP Ø600

PAMJA E PORTALIT SH. 1:50

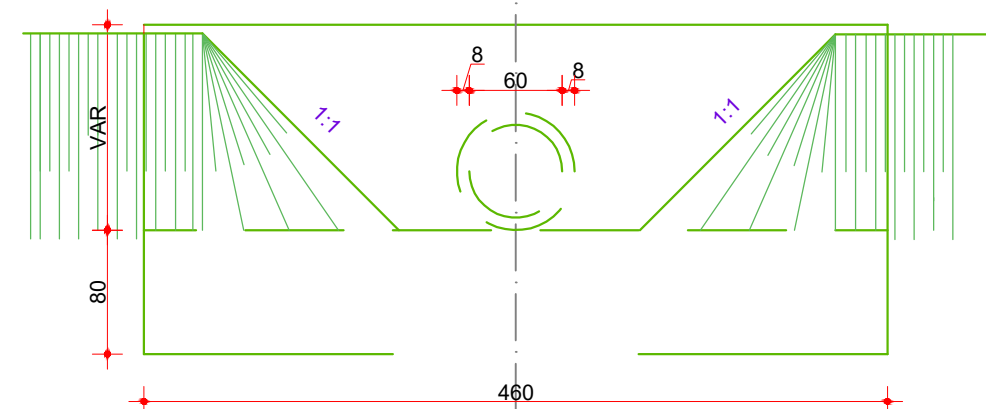

Prerje A-A

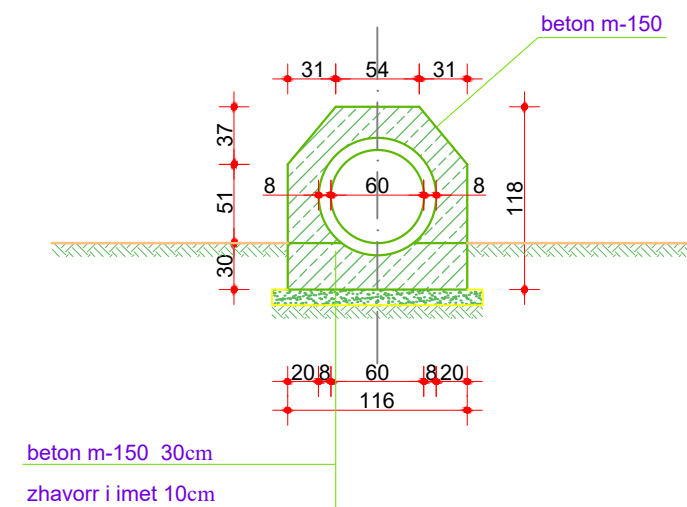

<p>PROJEKTOI:</p>  <p>Adresa: Rruga "Bardhyl", Njesia Bashkiake nr. 8, TIRANE</p>	<p>POROSITI:</p> <p>BASHKIA DIBER</p>	<p>Emertimi:</p> <p>DETAJ TOMBINO TIP + PORTAL</p>	<p>GRUPI PROJEKTUES</p> <p>Ing.Hidro. Mark PEMAJ Firma:</p> <p>Ing.Top. Bilbil NURÇE Firma:</p>
	<p>Objekti: "SISTEMIM - ASFALTIM I RRUGEVE TE BRENDESHME TE FSHATIT GREVE, BASHKIA DIBER".</p>	<p>PROJEKT - ZBATIMI</p>	