

MIRATOI:

**KRYETARI I BASHKISË
ARTUR BUSHI**

PROJEKT ZBATIMI

OBJEKTI:

**"RIKUALIFIKIM URBAN I SHESHEVE TE PALLATEVE TE
SHEMBURA NE TERRITORIN E NJESISE ADMINISTRATIVE
FUSHE KRUJE"**

PROJEKTUESI:

"ERALD G" shpk

INVESTITORI:

BASHKIA KRUJË

KRUJË, 2023

SHESHI PERBALLE SPITALIT



REPUBLIKA E SHQIPERISE
BASHKIA KRUJE

"ERALD G" shpk

PROJEKT ZBATIMI

"RIKUALIFIKIM URBAN I SHESHEVE TE PALLATEVE TE
SHEMBURA NE TERRITORIN E NJESISE ADMINISTRATIVE
FUSHE KRUJE"

PLAN SISTEMIMI

PROJEKTUES:

"ERALD G" shpk

SHKALLA

1: __

FLETA 00

2023

SHESHI PERBALLE SPITALIT

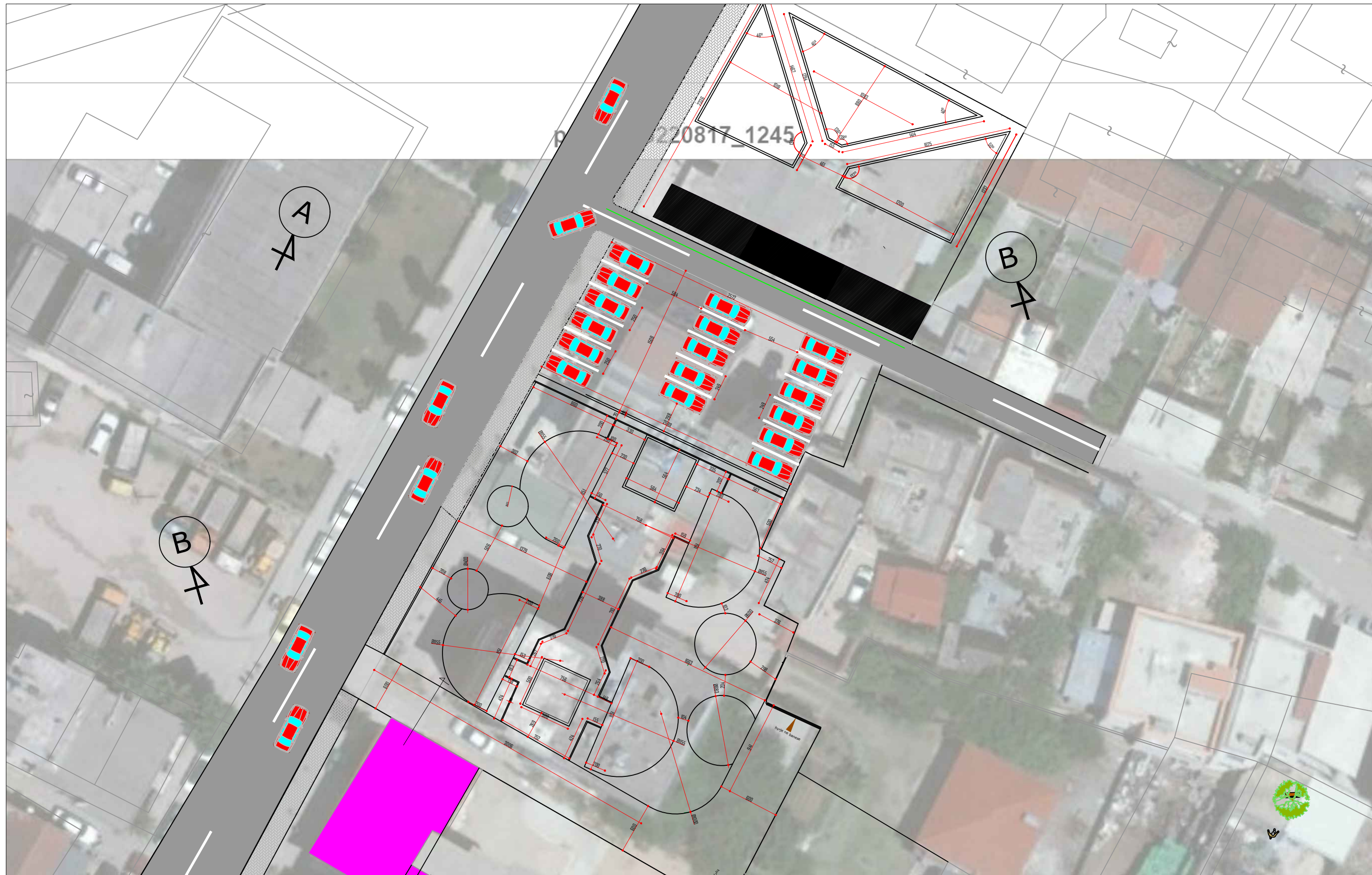

REPUBLIKA E SHQIPERISE
BASHKIA KRUJE

"ERALD G" shpk

PROJEKT ZBATIMI

"RIKUALIFIKIM URBAN I SHESHEVE TE PALLATEVE TE
SHEMBURA NE TERRITORIN E NJESISE ADMINISTRATIVE
FUSHE KRUJE"

PLAN DIMENSIONIMI

PROJEKTUES:

"ERALD G" shpk

SHKALLA

1 : __

FLETA 00

2023

SHESHI PERBALLE SPITALIT

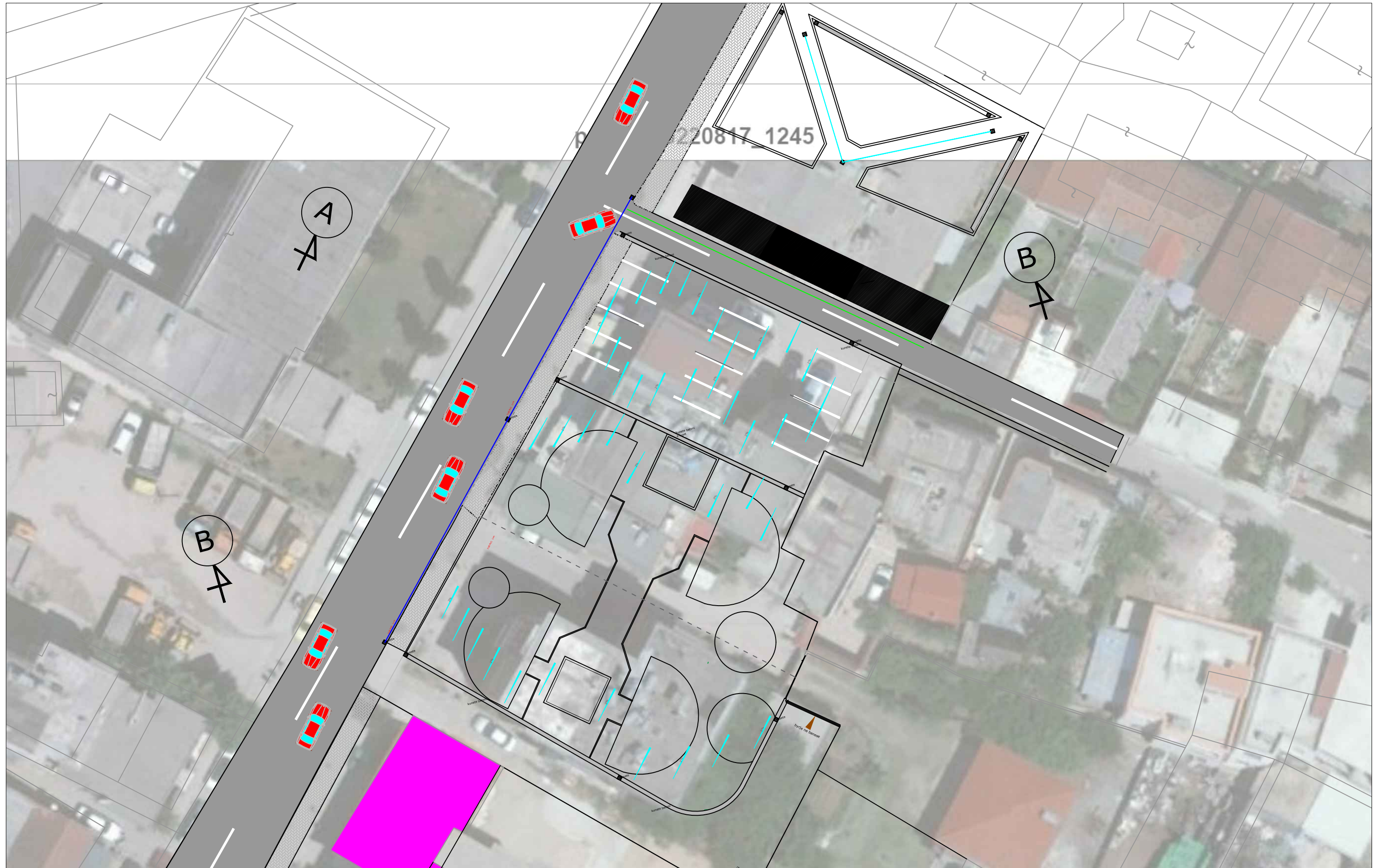

REPUBLIKA E SHQIPERISE
BASHKIA KRUJE

"ERALD G" shpk

PROJEKT ZBATIMI

"RIKUALIFIKIM URBAN I SHESHEVE TE PALLATEVE TE
SHEMBURA NE TERRITORIN E NJESISE ADMINISTRATIVE
FUSHE KRUJE"

RRJETI I KANALIZIMEVE KUB

PROJEKTUES:

"ERALD G" shpk

FLETA 00

SHKALLA

1: __

2023

SHESHI PERBALLE SPITALIT



	REPUBLIKA E SHQIPERISE BASHKIA KRUJE	PROJEKT ZBATIMI "RIKUALIFIKIM URBAN I SHESHEVE TE PALLATEVE TE SHEMBURA NE TERRITORIN E NJESISE ADMINISTRATIVE FUSHE KRUJE"	RRJETI I NDRICIMIT	PROJEKTUES: "ERALD G" shpk	FLETA 00
	"ERALD G" shpk			SHKALLA 1 : __	2023

SHESHI PERBALLE SPITALIT

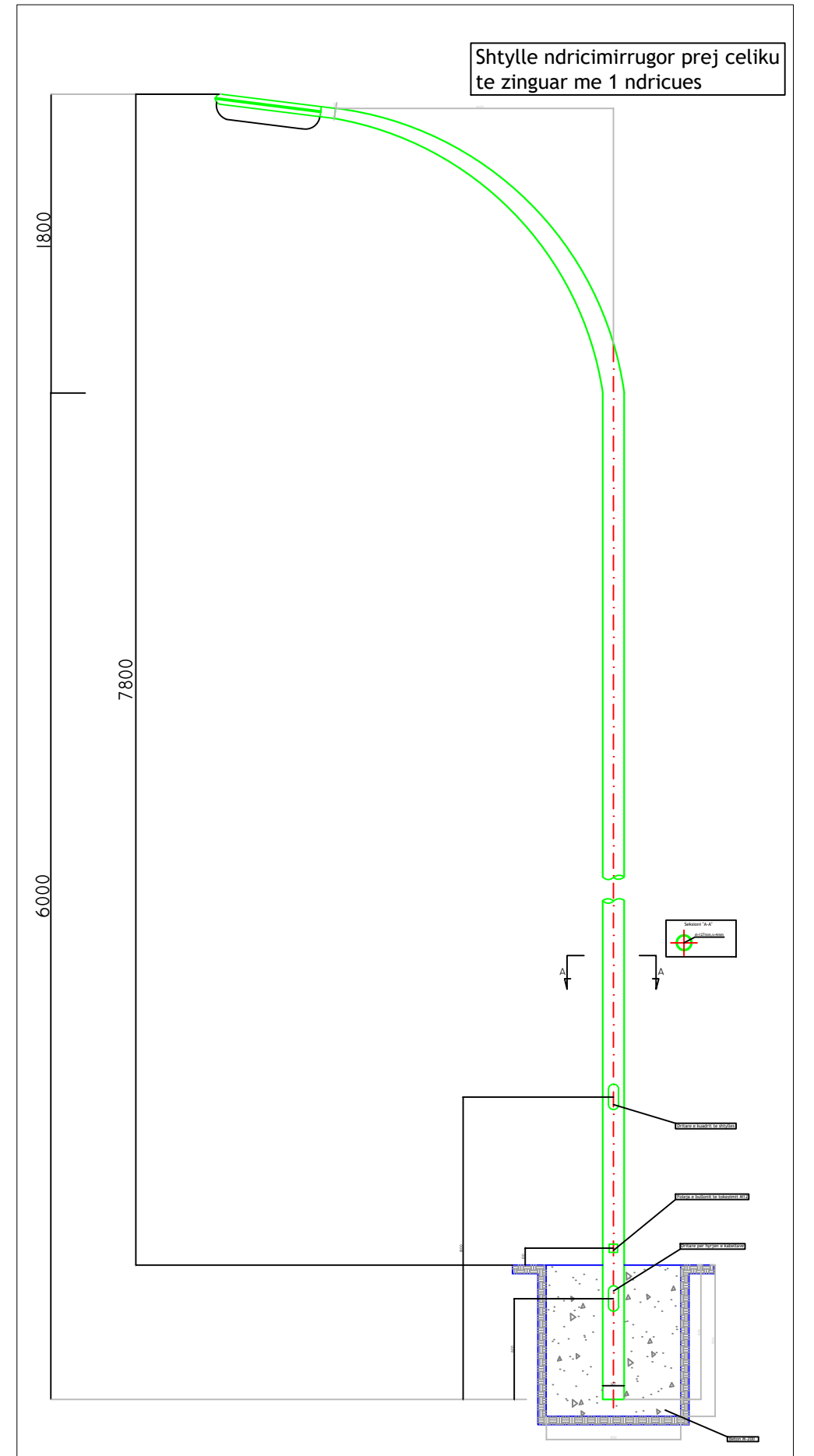
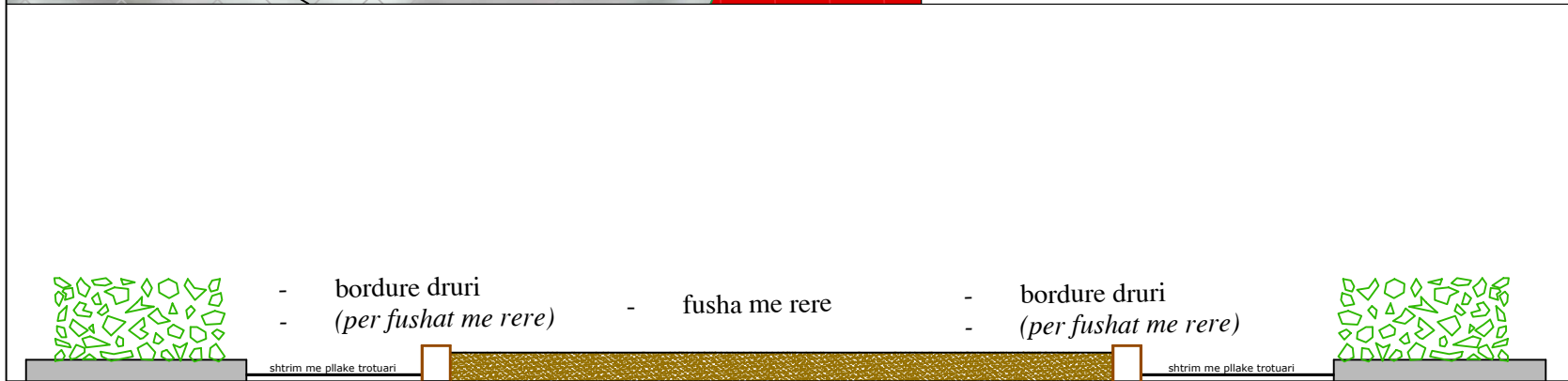
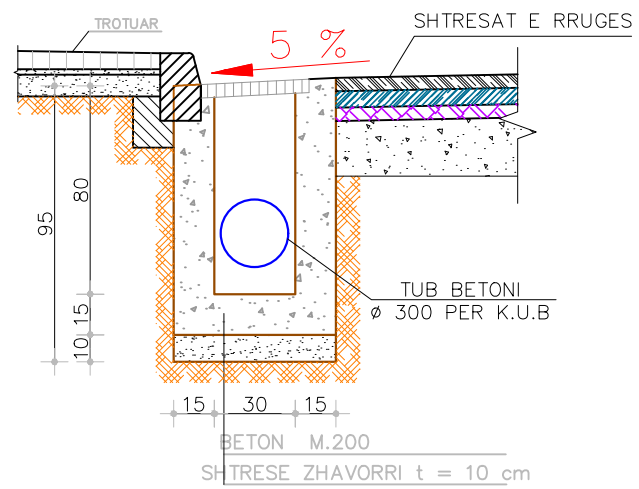
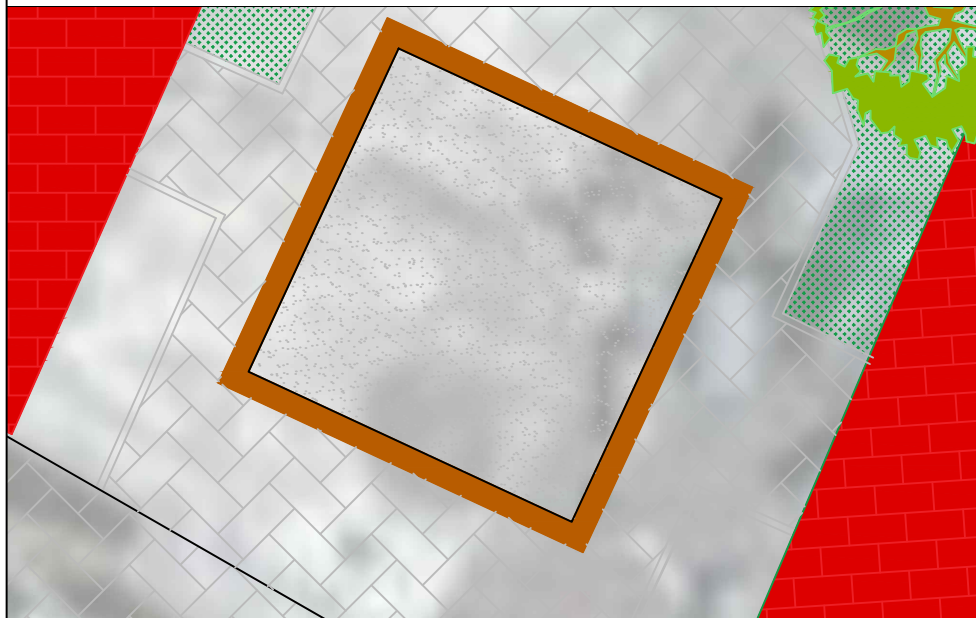
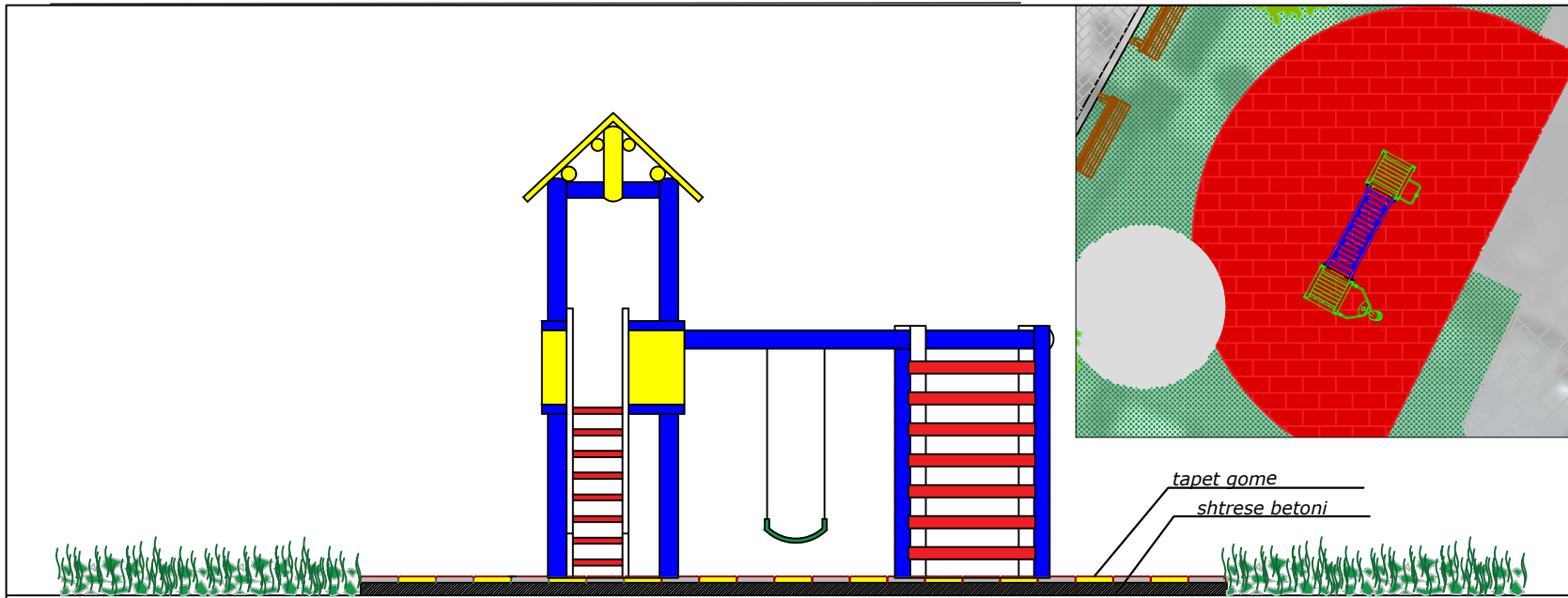

REPUBLIKA E SHQIPERISE
BASHKIA KRUJE

PROJEKT ZBATIMI

"RIKUALIFIKIM URBAN I SHESHEVE TE PALLATEVE TE
SHEMBURA NE TERRITORIN E NJESISE ADMINISTRATIVE
FUSHE KRUJE"

DETAJE

PROJEKTUES:

"ERALD G" shpk

FLETA 00

"ERALD G" shpk

SHKALLA

1 : __

2023

SHESHI PERBALLE SPITALIT

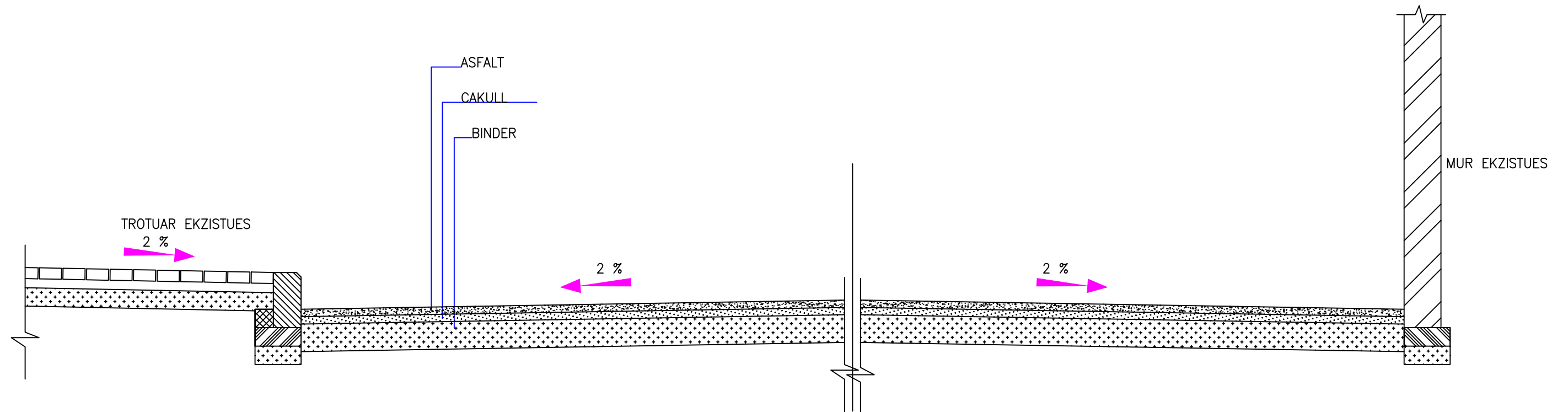
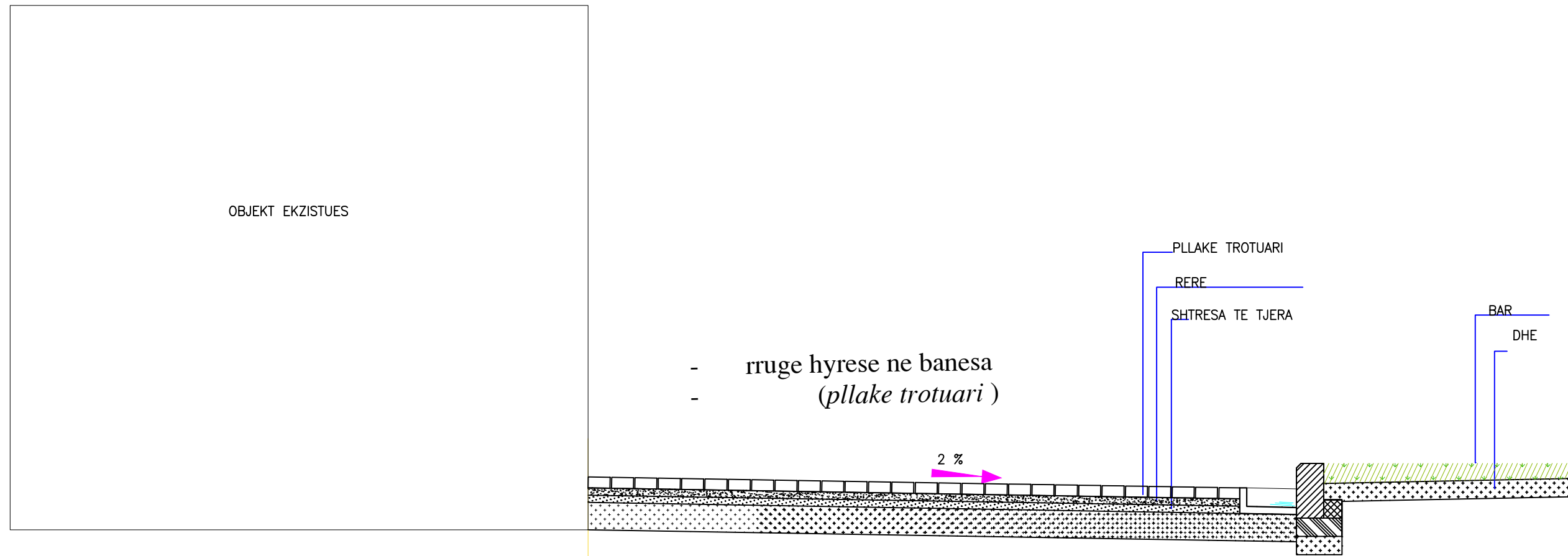

REPUBLIKA E SHQIPERISE
BASHKIA KRUJE

"ERALD G" shpk

PROJEKT ZBATIMI

"RIKUALIFIKIM URBAN I SHESHEVE TE PALLATEVE TE
SHEMBURA NE TERRITORIN E NJESISE ADMINISTRATIVE
FUSHE KRUJE"

DETAJE

PROJEKTUES:

"ERALD G" shpk

SHKALLA

1: __

FLETA 00

2023

SHESHI PERBALLE SPITALIT

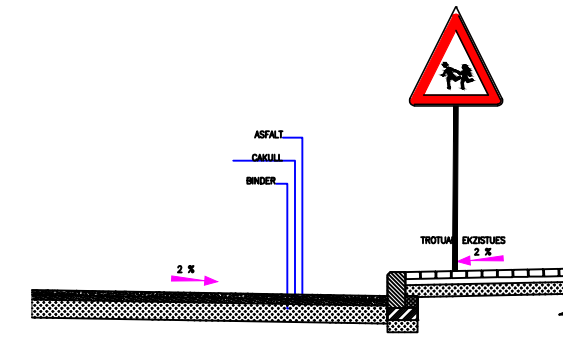
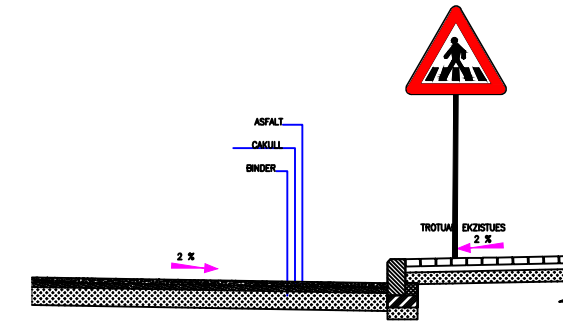
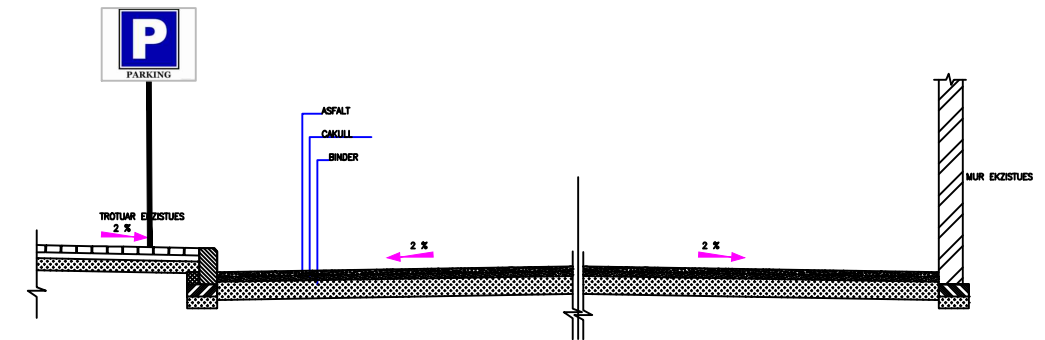
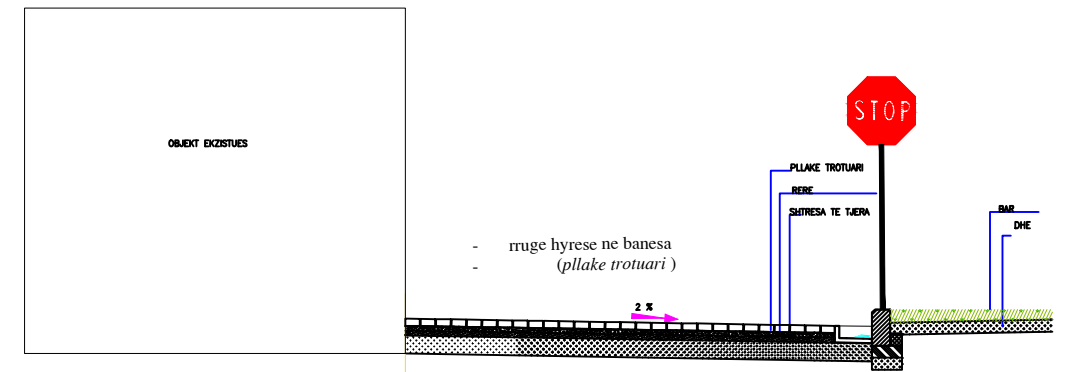
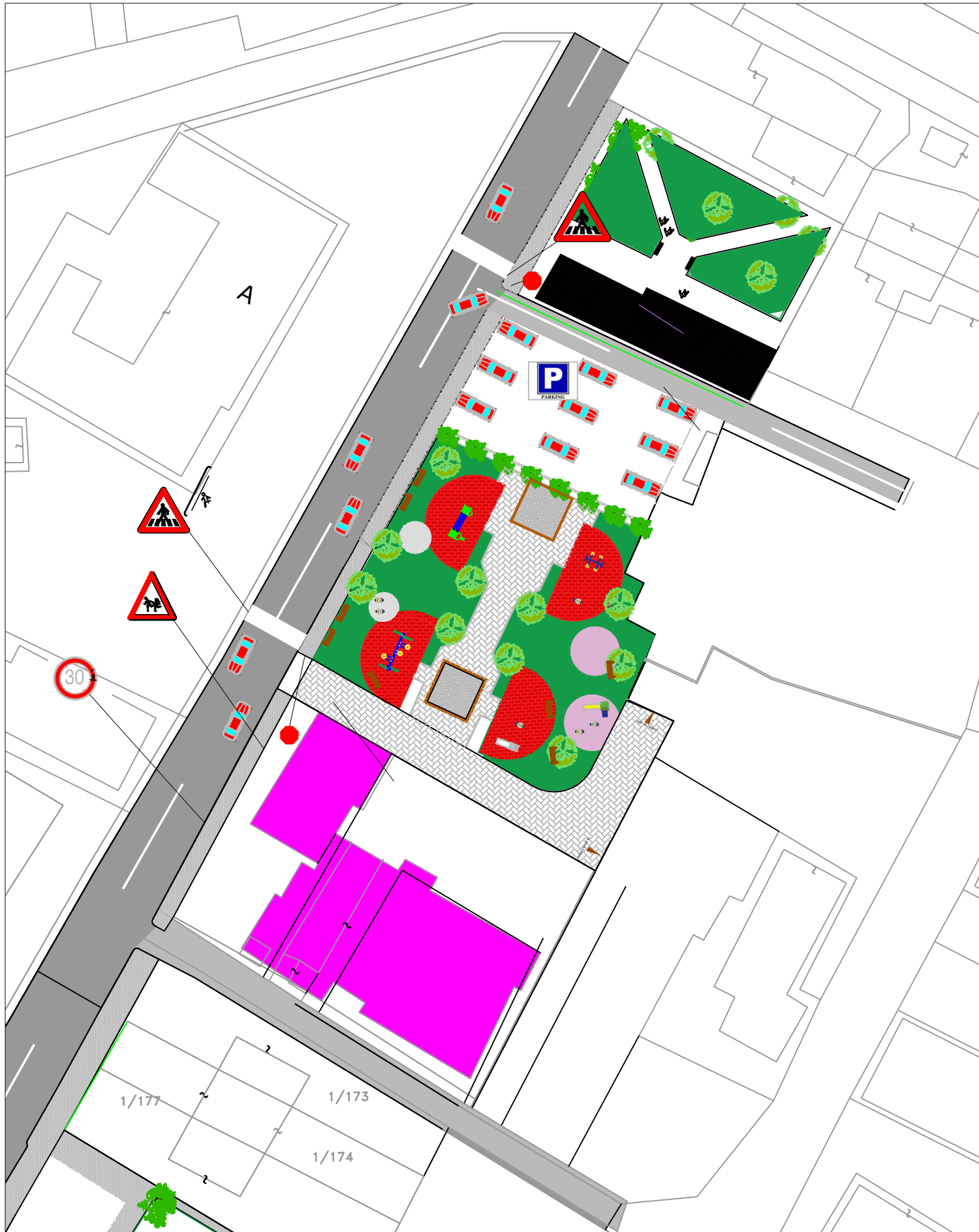

SHESHI PERBALLE SPITALIT



REPUBLIKA E SHQIPERISE
BASHKIA KRUJE

"ERALD G" shpk

PROJEKT ZBATIMI

"RIKUALIFIKIM URBAN I SHESHEVE TE PALLATEVE TE
SHEMBURA NE TERRITORIN E NJESISE ADMINISTRATIVE
FUSHE KRUJE"

DETAJE

PROJEKTUES:

"ERALD G" shpk

SHKALLA

1 : __

FLETA 00

2023

SHESHI PERBALLE SPITALIT



REPUBLIKA E SHQIPERISE
BASHKIA KRUJE

"ERALD G" shpk

PROJEKT ZBATIMI

"RIKUALIFIKIM URBAN I SHESHEVE TE PALLATEVE TE
SHEMBURA NE TERRITORIN E NJESISE ADMINISTRATIVE
FUSHE KRUJE"

DETAJE

PROJEKTUES:

"ERALD G" shpk

SHKALLA

1 : __

FLETA 00

2023

SHESHI PERBALLE SPITALIT



REPUBLIKA E SHQIPERISE
BASHKIA KRUJE

"ERALD G" shpk

PROJEKT ZBATIMI

"RIKUALIFIKIM URBAN I SHESHEVE TE PALLATEVE TE
SHEMBURA NE TERRITORIN E NJESISE ADMINISTRATIVE
FUSHE KRUJE"

PLAN SISTEMIMI

PROJEKTUES:

"ERALD G" shpk

SHKALLA

1 : __

FLETA 00

2023

SHESHI PRANE BASHKISE



REPUBLIKA E SHQIPERISE
BASHKIA KRUJE

"ERALD G" shpk

PROJEKT ZBATIMI
"RIKUALIFIKIM URBAN I SHESHEVE TE PALLATEVE TE
SHEMBURA NE TERRITORIN E NJESISE ADMINISTRATIVE
FUSHE KRUJE"

PLAN SISTEMIMI

PROJEKTUES:

"ERALD G" shpk

SHKALLA

1: __

FLETA 04

2022

SHESHI PRANE BASHKISE



REPUBLIKA E SHQIPERISE
BASHKIA KRUJE

"ERALD G" shpk

PROJEKT ZBATIMI
"RIKUALIFIKIM URBAN I SHESHEVE TE PALLATEVE TE
SHEMBURA NE TERRITORIN E NJESISE ADMINISTRATIVE
FUSHE KRUJE"

RRJETI I KANALIZIMEVE KUB

PROJEKTUES:

"ERALD G" shpk

SHKALLA

1: __

FLETA 04

2022

SHESHI PRANE BASHKISE

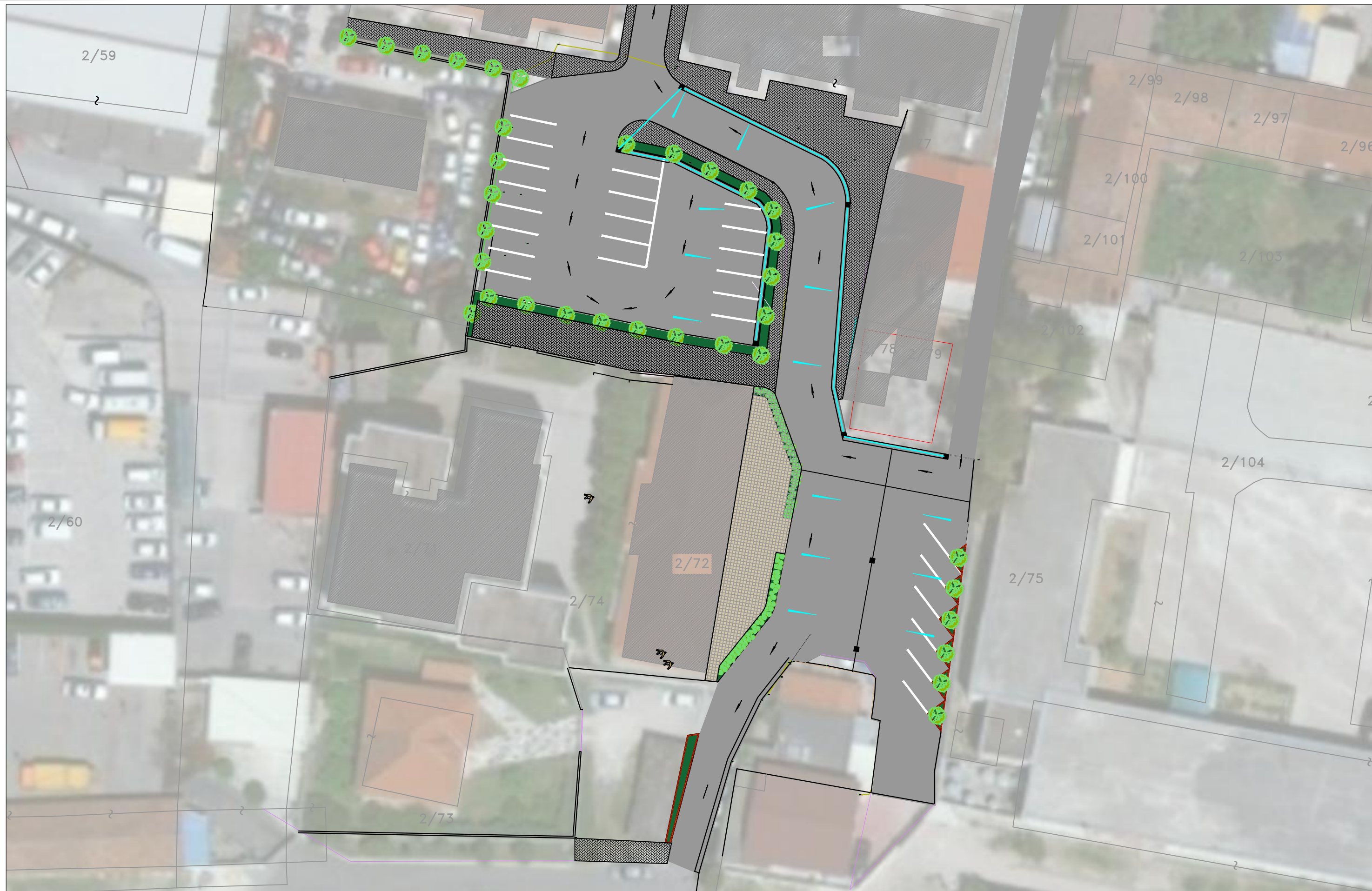

REPUBLIKA E SHQIPERISE
BASHKIA KRUJE

"ERALD G" shpk

PROJEKT ZBATIMI
"RIKUALIFIKIM URBAN I SHESHEVE TE PALLATEVE TE
SHEMBURA NE TERRITORIN E NJESISE ADMINISTRATIVE
FUSHE KRUJE"

RRJETI I KANALIZIMEVE KUB

PROJEKTUES:

"ERALD G" shpk

SHKALLA

1: __

FLETA 04

2022

SHESHI PRANE BASHKISE

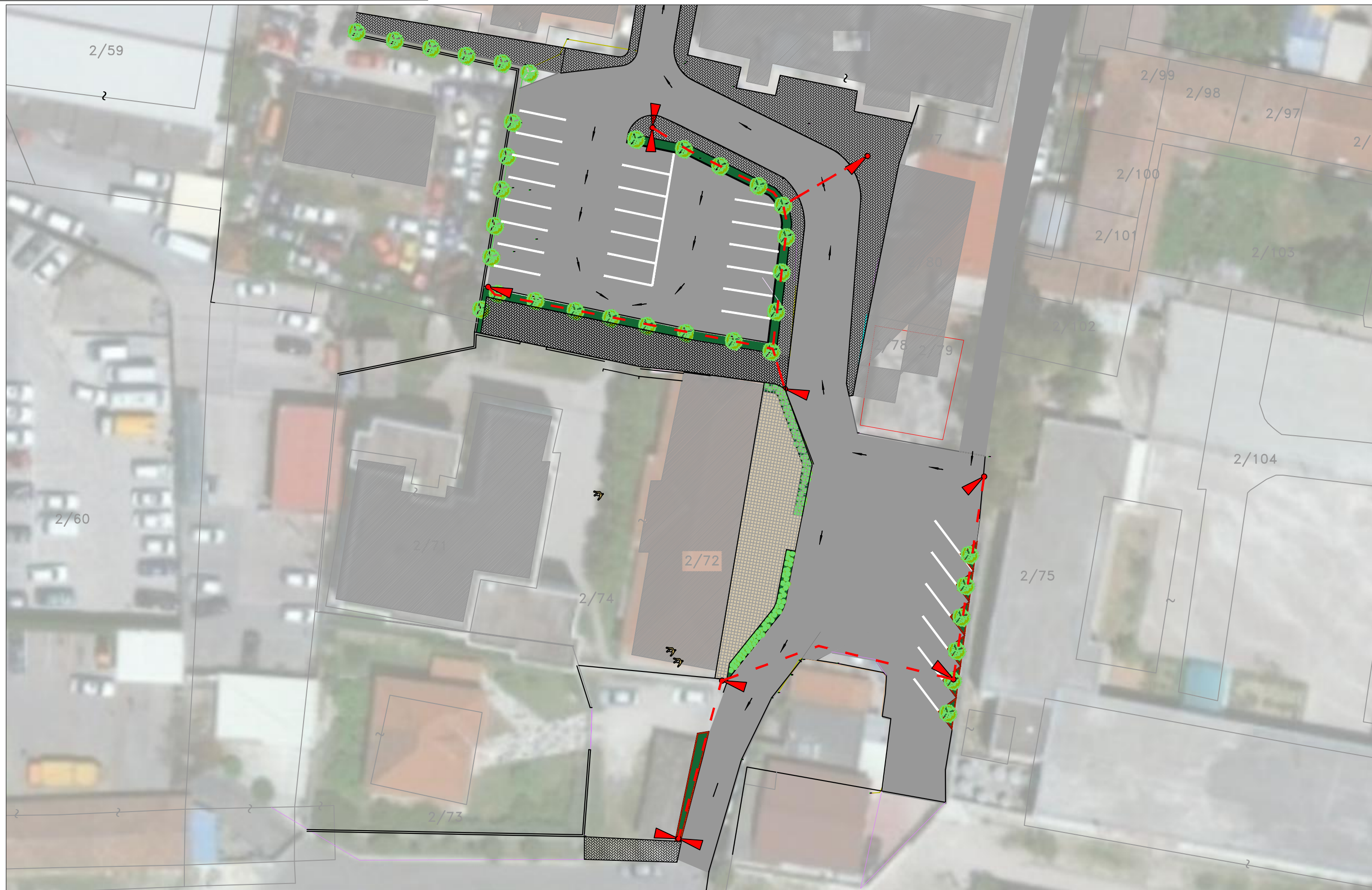

REPUBLIKA E SHQIPERISE
BASHKIA KRUJE

"ERALD G" shpk

PROJEKT ZBATIMI
"RIKUALIFIKIM URBAN I SHESHEVE TE PALLATEVE TE
SHEMBURA NE TERRITORIN E NJESISE ADMINISTRATIVE
FUSHE KRUJE"

PLANI I NDRICIMIT

PROJEKTUES:

"ERALD G" shpk

SHKALLA

1: __

FLETA 04

2022