

**MIRATOI : BASHKIA MALLAKASTER
KRYETARI
QERIM ISMAILAJ**

PROJEKT ZBATIMI

**Objekti : "OBJEKTI: RIKONSTRUKSION I RRUGEVE NE FSHATRAT E
NJESISE ADMINISTRATIVE FRATAR DHE KUTE"**



REPUBLIKA E SHQIPERISE
BASHKIA MALLAKASTER

STUDIM PROJEKTIM
- PROJEKT ZBATIM -

2024

OBJEKTI: RIKONSTRUKSION I RRUGEVE NE FSHATRAT E NJESISE
ADMINISTRATIVE FRATAR DHE KUTE

PROJEKTOI: XH & MILER sh.p.k



REPUBLIKA E SHQIPERISE
BASHKIA MALLAKASTER

STUDIM PROJEKTIM
- PROJEKT ZBATIM -
2024

OBJEKTI: RIKONSTRUKSION I RRUGEVE NE FSHATRA E NJESISE
ADMINISTRATIVE FRATAR DHE KUTE

PROJEKTOI: XH & MILER sh.p.k

RRUGE NE FSHATIN FRATAR
HOROGRAFIA E RRUGES

Shkalla	Viz.
	FL-01



REPUBLIKA E SHQIPERISE
BASHKIA MALLAKASTER

STUDIM PROJEKTIM
- PROJEKT ZBATIM -
2024

OBJEKTI: RIKONSTRUKSION I RRUGEVE NE FSHATRA E NJESISE
ADMINISTRATIVE FRATAR DHE KUTE

PROJEKTOI: XH & MILER sh.p.k

RRUGE NE FSHATIN FRATAR
HOROGRAFIA E RRUGES

Shkalla 1:750	Viz. FL-02
------------------	---------------

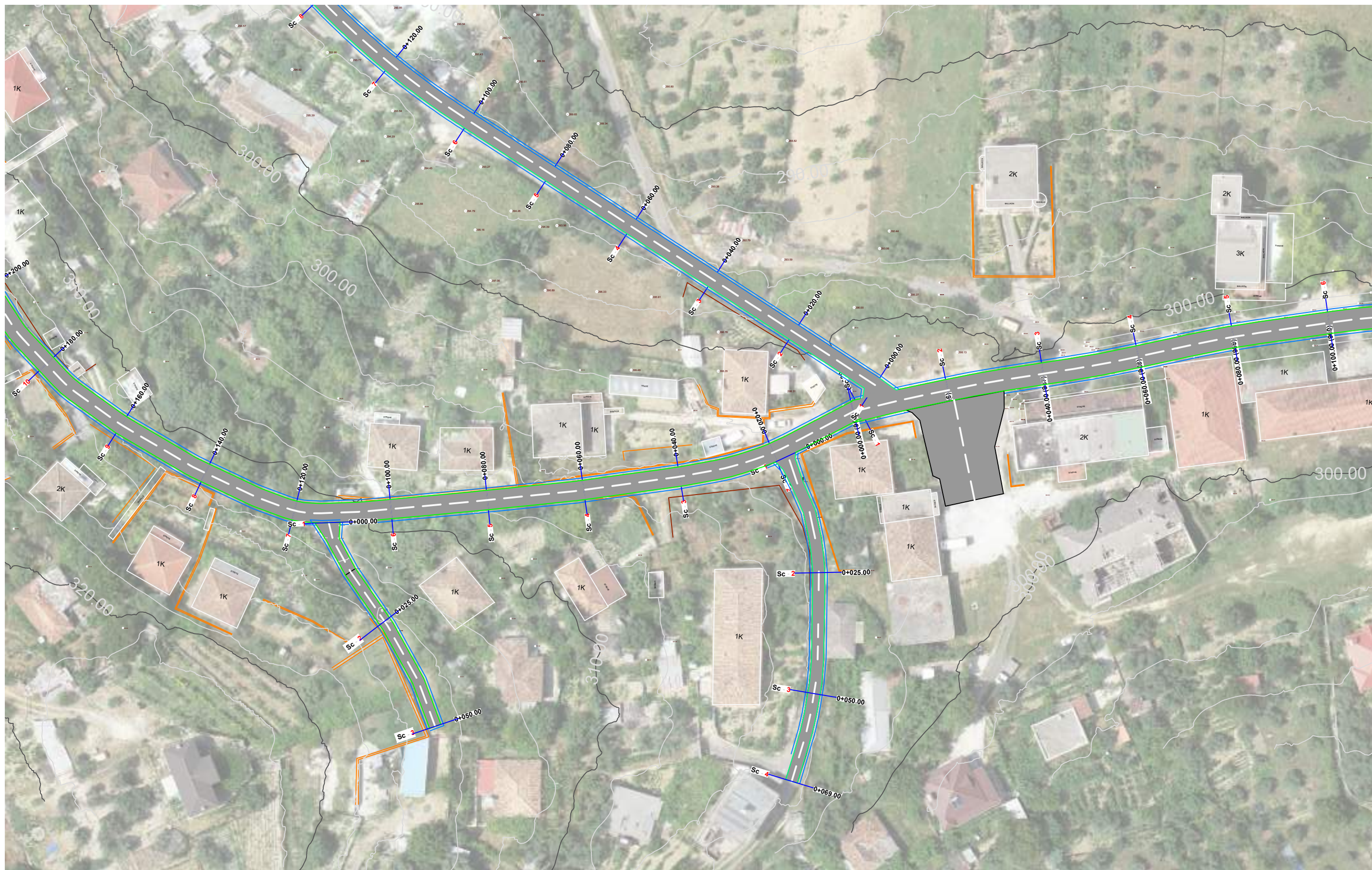

REPUBLIKA E SHQIPERISE
BASHKIA MALLAKASTER

STUDIM PROJEKTIM
- PROJEKT ZBATIM -
2024

OBJEKTI: RIKONSTRUKSION I RRUGEVE NE FSHATROT E NJESISE
ADMINISTRATIVE FRATAR DHE KUTE

PROJEKTOI: XH & MILER sh.p.k

RRUGE NE FSHATIN FRATAR
HOROGRAFIA E RRUGES

Shkalla
1:750

Viz.
FL-03



REPUBLIKA E SHQIPERISE
BASHKIA MALLAKASTER

STUDIM PROJEKTIM
- PROJEKT ZBATIM -
2024

OBJEKTI: RIKONSTRUKSION I RRUGEVE NE FSHATRA E NJESISE
ADMINISTRATIVE FRATAR DHE KUTE

PROJEKTOI: XH & MILER sh.p.k

RRUGE NE FSHATIN FRATAR
HOROGRAFIA E RRUGES

Shkalla
1:750

Viz.
FL-04



REPUBLIKA E SHQIPERISE
BASHKIA MALLAKASTER

STUDIM PROJEKTIM
- PROJEKT ZBATIM -
2024

OBJEKTI: RIKONSTRUKSION I RRUGEVE NE FSHATROT E NJESISE
ADMINISTRATIVE FRATAR DHE KUTE

PROJEKTOI: XH & MILER sh.p.k

RRUGE NE FSHATIN FRATAR
HOROGRAFIA E RRUGES

Shkalla
1:750

Viz.
FL-05



REPUBLIKA E SHQIPERISE
BASHKIA MALLAKASTER

STUDIM PROJEKTIM
- PROJEKT ZBATIM -
2024

OBJEKTI: RIKONSTRUKSION I RRUGEVE NE FSHATRA E NJESISE
ADMINISTRATIVE FRATAR DHE KUTE

PROJEKTOI: XH & MILER sh.p.k

RRUGE NE FSHATIN FRATAR
HOROGRAFIA E RRUGES

Shkalla	Viz.
	FL-06



REPUBLIKA E SHQIPERISE
BASHKIA MALLAKASTER

STUDIM PROJEKTIM
- PROJEKT ZBATIM -
2024

OBJEKTI: RIKONSTRUKSION I RRUGEVE NE FSHATRAE E NJESISE
ADMINISTRATIVE FRATAR DHE KUTE

PROJEKTOI: XH & MILER sh.p.k

RRUGE NE FSHATIN FRATAR
HOROGRAFIA E RRUGES

Shkalla
1:750

Viz.
FL-07

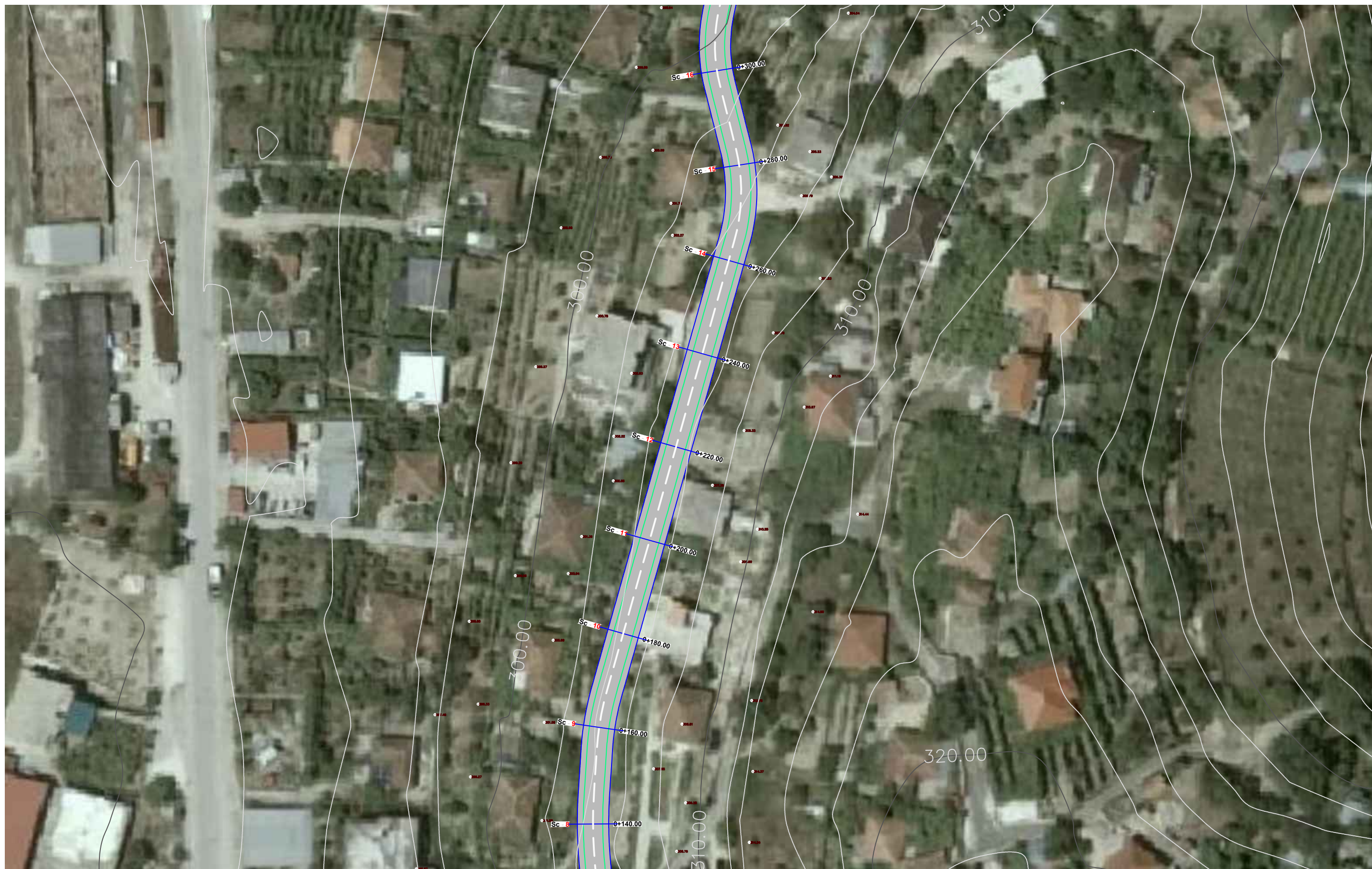

REPUBLIKA E SHQIPERISE
BASHKIA MALLAKASTER

STUDIM PROJEKTIM
- PROJEKT ZBATIM -
2024

OBJEKTI: RIKONSTRUKSION I RRUGEVE NE FSHATRA T E NJESISE
ADMINISTRATIVE FRATAR DHE KUTE

PROJEKTOI: XH & MILER sh.p.k

RRUGE NE FSHATIN FRATAR
HOROGRAFIA E RRUGES

Shkalla
1:750

Viz.
FL-08



REPUBLIKA E SHQIPERISE
BASHKIA MALLAKASTER

STUDIM PROJEKTIM
- PROJEKT ZBATIM -
2024

OBJEKTI: RIKONSTRUKSION I RRUGEVE NE FSHATRA E NJESISE
ADMINISTRATIVE FRATAR DHE KUTE

PROJEKTOI: XH & MILER sh.p.k

RRUGE NE FSHATIN FRATAR
HOROGRAFIA E RRUGES

Shkalla 1:750	Viz. FL-09
------------------	---------------



REPUBLIKA E SHQIPERISE
BASHKIA MALLAKASTER

STUDIM PROJEKTIM
- PROJEKT ZBATIM -
2024

OBJEKTI: RIKONSTRUKSION I RRUGEVE NE FSHATRA E NJESISE
ADMINISTRATIVE FRATAR DHE KUTE

PROJEKTOI: XH & MILER sh.p.k

RRUGE NE FSHATIN FRATAR
HOROGRAFIA E RRUGES

Shkalla	Viz.
	FL-10



REPUBLIKA E SHQIPERISE
BASHKIA MALLAKASTER

STUDIM PROJEKTIM
- PROJEKT ZBATIM -
2024

OBJEKTI: RIKONSTRUKSION I RRUGEVE NE FSHATRA E NJESISE
ADMINISTRATIVE FRATAR DHE KUTE

PROJEKTOI: XH & MILER sh.p.k

RRUGE NE FSHATIN FRATAR
HOROGRAFIA E RRUGES

Shkalla
1:750

Viz.
FL-11



REPUBLIKA E SHQIPERISE
BASHKIA MALLAKASTER

STUDIM PROJEKTIM
- PROJEKT ZBATIM -
2024

OBJEKTI: RIKONSTRUKSION I RRUGEVE NE FSHATRA E NJESISE
ADMINISTRATIVE FRATAR DHE KUTE

PROJEKTOI: XH & MILER sh.p.k

RRUGE NE FSHATIN FRATAR
HOROGRAFIA E RRUGES

Shkalla
1:750

Viz.
FL-12



REPUBLIKA E SHQIPERISE
BASHKIA MALLAKASTER

STUDIM PROJEKTIM
- PROJEKT ZBATIM -
2024

OBJEKTI: RIKONSTRUKSION I RRUGEVE NE FSHATRA E NJESISE
ADMINISTRATIVE FRATAR DHE KUTE

PROJEKTOI: XH & MILER sh.p.k

RRUGE NE FSHATIN FRATAR
HOROGRAFIA E RRUGES

Shkalla
1:750

Viz.
FL-13



REPUBLIKA E SHQIPERISE
BASHKIA MALLAKASTER

STUDIM PROJEKTIM
- PROJEKT ZBATIM -
2024

OBJEKTI: RIKONSTRUKSION I RRUGEVE NE FSHATRAT E NJESISE
ADMINISTRATIVE FRATAR DHE KUTE

PROJEKTOI: XH & MILER sh.p.k

RRUGE NE FSHATIN FRATAR
PLANIMETRIA E RRUGES

Shkalla	Viz.
	FL-14

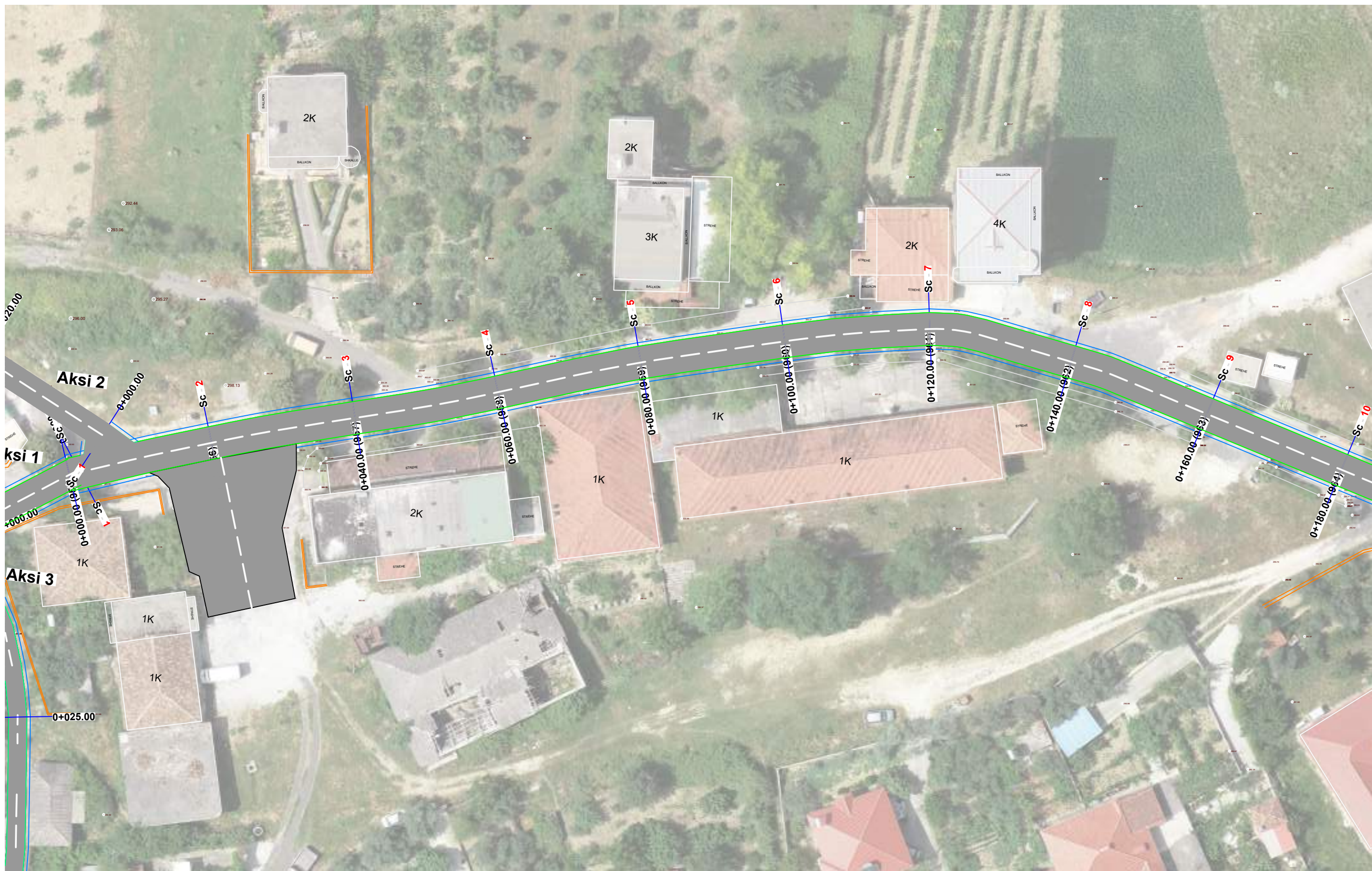

 REPUBLIKA E SHQIPERISE BASHKIA MALLAKASTER	STUDIM PROJEKTIM - PROJEKT ZBATIM - 2024	OBJEKTI: RIKONSTRUKSION I RRUGEVE NE FSHATRAT E NJESISE ADMINISTRATIVE FRATAR DHE KUTE	PROJEKTOI: XH & MILER sh.p.k	RRUGE NE FSHATIN FRATAR PLANIMETRIA E RRUGES	
				Shkalla 1:500	Viz. FL-15



REPUBLIKA E SHQIPERISE
BASHKIA MALLAKASTER

STUDIM PROJEKTIM
- PROJEKT ZBATIM -
2024

OBJEKTI: RIKONSTRUKSION I RRUGEVE NE FSHATRAT E NJESISE
ADMINISTRATIVE FRATAR DHE KUTE

PROJEKTOI: XH & MILER sh.p.k

RRUGE NE FSHATIN FRATAR
PLANIMETRIA E RRUGES

Shkalla
1:500
Viz.
FL-16



REPUBLIKA E SHQIPERISE
BASHKIA MALLAKASTER

STUDIM PROJEKTIM
- PROJEKT ZBATIM -
2024

OBJEKTI: RIKONSTRUKSION I RRUGEVE NE FSHATRAT E NJESISE
ADMINISTRATIVE FRATAR DHE KUTE

PROJEKTOI: XH & MILER sh.p.k

RRUGE NE FSHATIN FRATAR
PLANIMETRIA E RRUGES

Shkalla
1:500

Viz.
FL-17



REPUBLIKA E SHQIPERISE
BASHKIA MALLAKASTER

STUDIM PROJEKTIM
- PROJEKT ZBATIM -
2024

OBJEKTI: RIKONSTRUKSION I RRUGEVE NE FSHATRAZAT E NJESISE
ADMINISTRATIVE FRATAR DHE KUTE

PROJEKTOI: XH & MILER sh.p.k

RRUGE NE FSHATIN FRATAR
PLANIMETRIA E RRUGES

Shkalla
1:500

Viz.
FL-18



REPUBLIKA E SHQIPERISE
BASHKIA MALLAKASTER

STUDIM PROJEKTIM
- PROJEKT ZBATIM -
2024

OBJEKTI: RIKONSTRUKSION I RRUGEVE NE FSHATRAT E NJESISE
ADMINISTRATIVE FRATAR DHE KUTE

PROJEKTOI: XH & MILER sh.p.k

RRUGE NE FSHATIN FRATAR
PLANIMETRIA E RRUGES

Shkalla
1:500

Viz.
FL-19



REPUBLIKA E SHQIPERISE
BASHKIA MALLAKASTER

STUDIM PROJEKTIM
- PROJEKT ZBATIM -
2024

OBJEKTI: RIKONSTRUKSION I RRUGEVE NE FSHATRAZ E NJESISE
ADMINISTRATIVE FRATAR DHE KUTE

PROJEKTOI: XH & MILER sh.p.k

RRUGE NE FSHATIN FRATAR
PLANIMETRIA E RRUGES

Shkalla
1:500

Viz.
FL-20



REPUBLIKA E SHQIPERISE
BASHKIA MALLAKASTER

STUDIM PROJEKTIM
- PROJEKT ZBATIM -
2024

OBJEKTI: RIKONSTRUKSION I RRUGEVE NE FSHATRA T E NJESISE
ADMINISTRATIVE FRATAR DHE KUTE

PROJEKTOI: XH & MILER sh.p.k

RRUGE NE FSHATIN FRATAR
PLANIMETRIA E RRUGES

Shkalla	Viz.
	FL-21

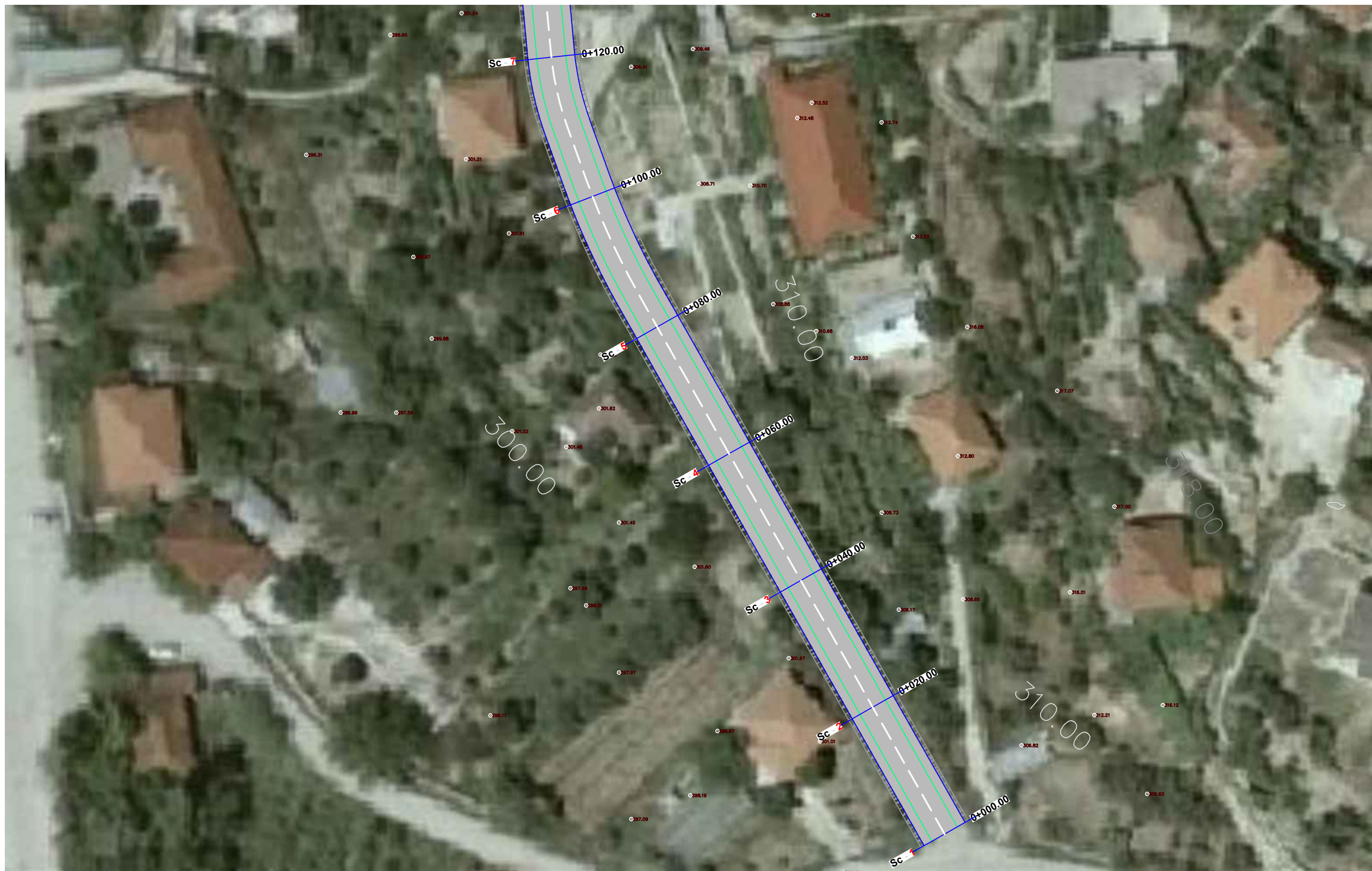

 REPUBLIKA E SHQIPERISE BASHKIA MALLAKASTER	STUDIM PROJEKTIM - PROJEKT ZBATIM - 2024	OBJEKTI: RIKONSTRUKSION I RRUGEVE NE FSHATRAT E NJESISE ADMINISTRATIVE FRATAR DHE KUTE	PROJEKTOI: XH & MILER sh.p.k	RRUGE NE FSHATIN FRATAR PLANIMETRIA E RRUGES	
				Shkalla 1:500	Viz. FL-22

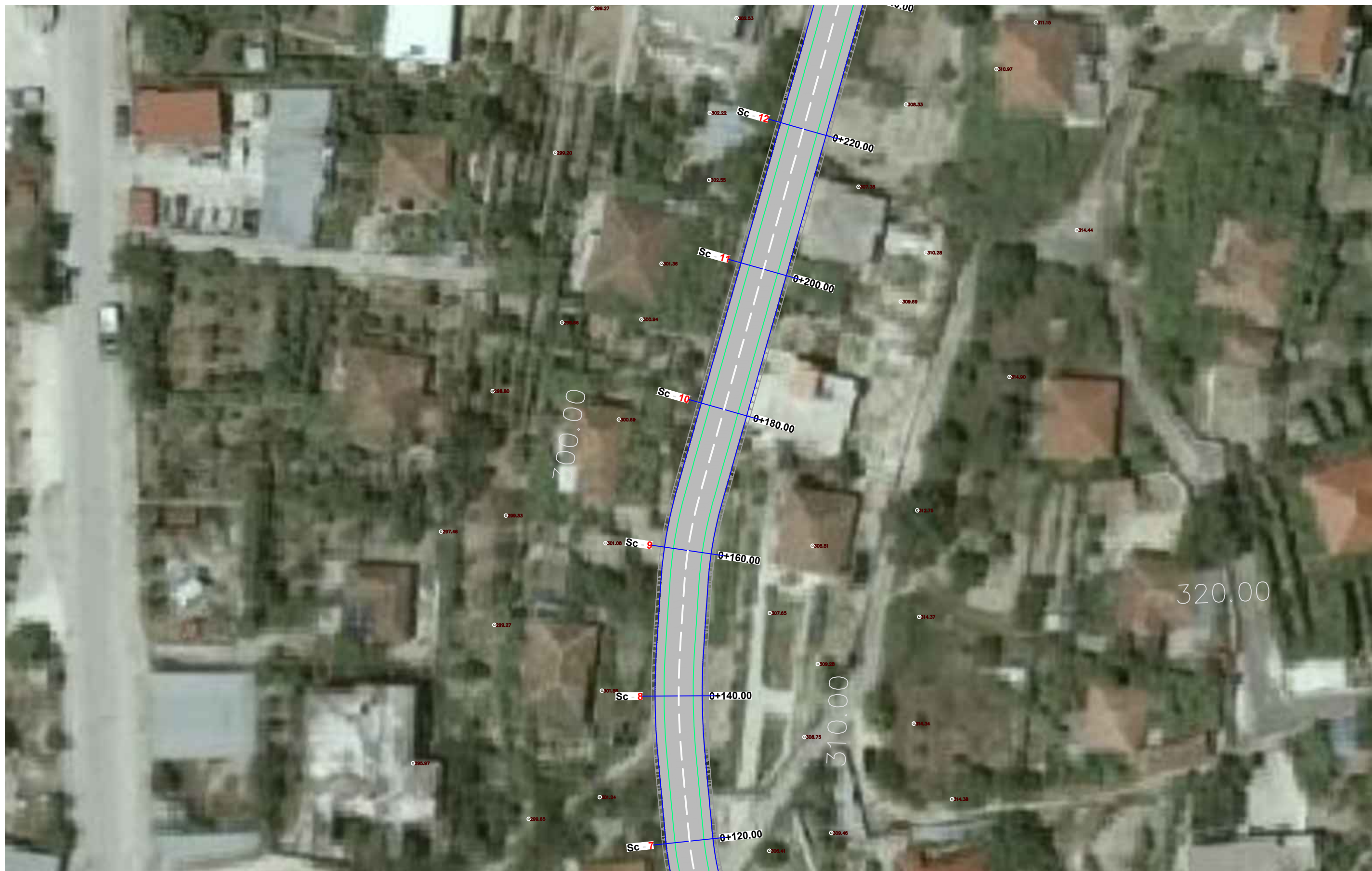

REPUBLIKA E SHQIPERISE
BASHKIA MALLAKASTER

STUDIM PROJEKTIM
- PROJEKT ZBATIM -
2024

OBJEKTI: RIKONSTRUKSION I RRUGEVE NE FSHATRAZ E NJESISE
ADMINISTRATIVE FRATAR DHE KUTE

PROJEKTOI: XH & MILER sh.p.k

RRUGE NE FSHATIN FRATAR
PLANIMETRIA E RRUGES

Shkalla
1:500

Viz.
FL-23

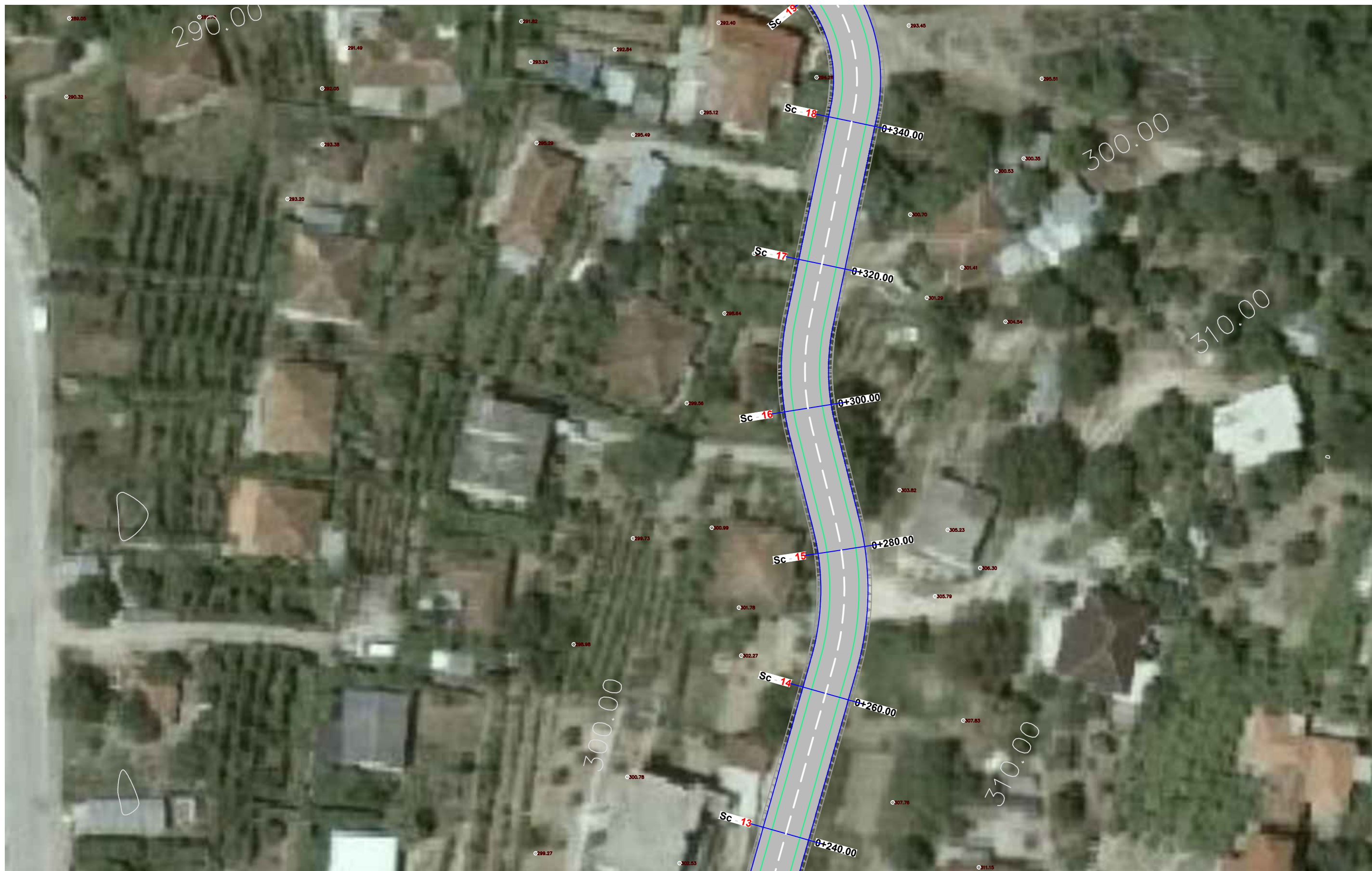

REPUBLIKA E SHQIPERISE
BASHKIA MALLAKASTER

STUDIM PROJEKTIM
- PROJEKT ZBATIM -
2024

OBJEKTI: RIKONSTRUKSION I RRUGEVE NE FSHATRA E NJESISE
ADMINISTRATIVE FRATAR DHE KUTE

PROJEKTOI: XH & MILER sh.p.k

RRUGE NE FSHATIN FRATAR
PLANIMETRIA E RRUGES

Shkalla
1:500

Viz.
FL-24

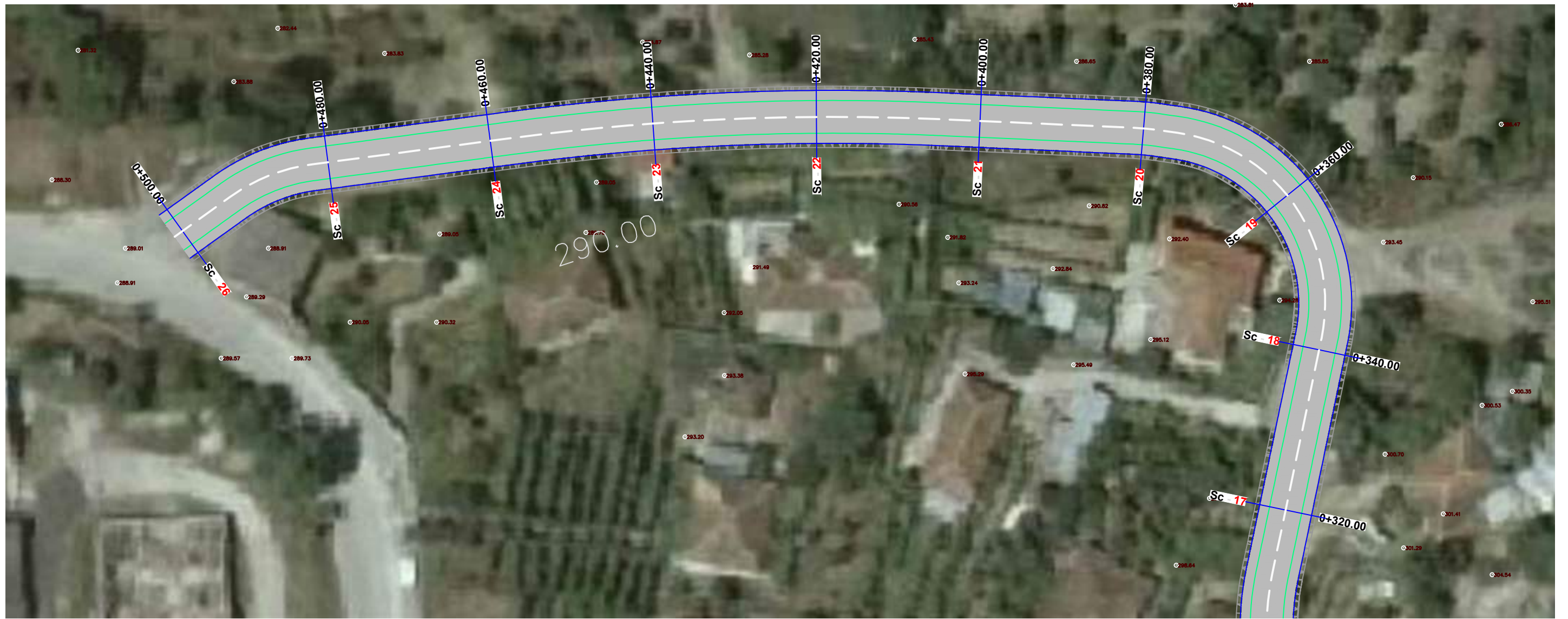

REPUBLIKA E SHQIPERISE
BASHKIA MALLAKASTER

STUDIM PROJEKTIM
- PROJEKT ZBATIM -

2024

OBJEKTI: RIKONSTRUKSION I RRUGEVE NE FSHATRA E NJESISE
ADMINISTRATIVE FRATAR DHE KUTE

PROJEKTOI: XH & MILER sh.p.k

RRUGE NE FSHATIN FRATAR

PLANIMETRIA E RRUGES

Shkalla
1:500

Viz.
FL-25



REPUBLIKA E SHQIPERISE
BASHKIA MALLAKASTER

STUDIM PROJEKTIM
- PROJEKT ZBATIM -
2024

OBJEKTI: RIKONSTRUKSION I RRUGEVE NE FSHATRA E NJESISE
ADMINISTRATIVE FRATAR DHE KUTE

PROJEKTOI: XH & MILER sh.p.k

RRUGE NE FSHATIN FRATAR
PLANIMETRIA E RRUGES

Shkalla	Viz.
	FL-26



REPUBLIKA E SHQIPERISE
BASHKIA MALLAKASTER

STUDIM PROJEKTIM
- PROJEKT ZBATIM -

2024

OBJEKTI: RIKONSTRUKSION I RRUGEVE NE FSHATRA E NJESISE
ADMINISTRATIVE FRATAR DHE KUTE

PROJEKTOI: XH & MILER sh.p.k

RRUGE NE FSHATIN FRATAR

PLANIMETRIA E RRUGES

Shkalla
1:500

Viz.
FL-27

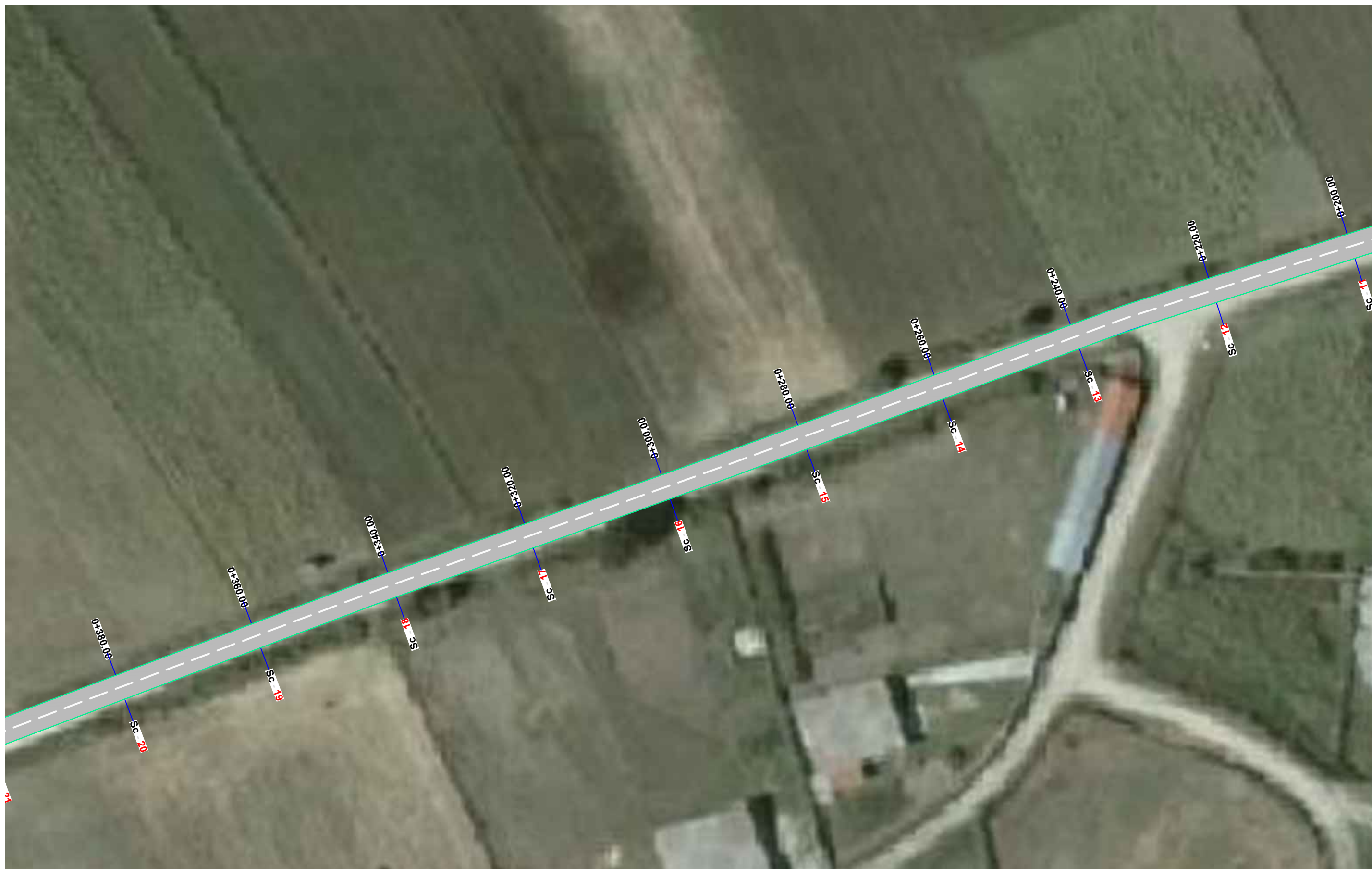

 REPUBLIKA E SHQIPERISE BASHKIA MALLAKASTER	STUDIM PROJEKTIM - PROJEKT ZBATIM -	OBJEKTI: RIKONSTRUKSION I RRUGEVE NE FSHATRA E NJESISE ADMINISTRATIVE FRATAR DHE KUTE	PROJEKTOI: XH & MILER sh.p.k	RRUGE NE FSHATIN FRATAR	
	2024			PLANIMETRIA E RRUGES	Shkalla 1:500



 REPUBLIKA E SHQIPERISE BASHKIA MALLAKASTER	STUDIM PROJEKTIM - PROJEKT ZBATIM -	OBJEKTI: RIKONSTRUKSION I RRUGEVE NE FSHATRA E NJESISE ADMINISTRATIVE FRATAR DHE KUTE	PROJEKTOI: XH & MILER sh.p.k	RRUGE NE FSHATIN FRATAR	
	2024			PLANIMETRIA E RRUGES	Shkalla 1:500



 REPUBLIKA E SHQIPERISE BASHKIA MALLAKASTER	STUDIM PROJEKTIM - PROJEKT ZBATIM -	OBJEKTI: RIKONSTRUKSION I RRUGEVE NE FSHATRA E NJESISE ADMINISTRATIVE FRATAR DHE KUTE	PROJEKTOI: XH & MILER sh.p.k	RRUGE NE FSHATIN FRATAR	
	2024			PLANIMETRIA E RRUGES	

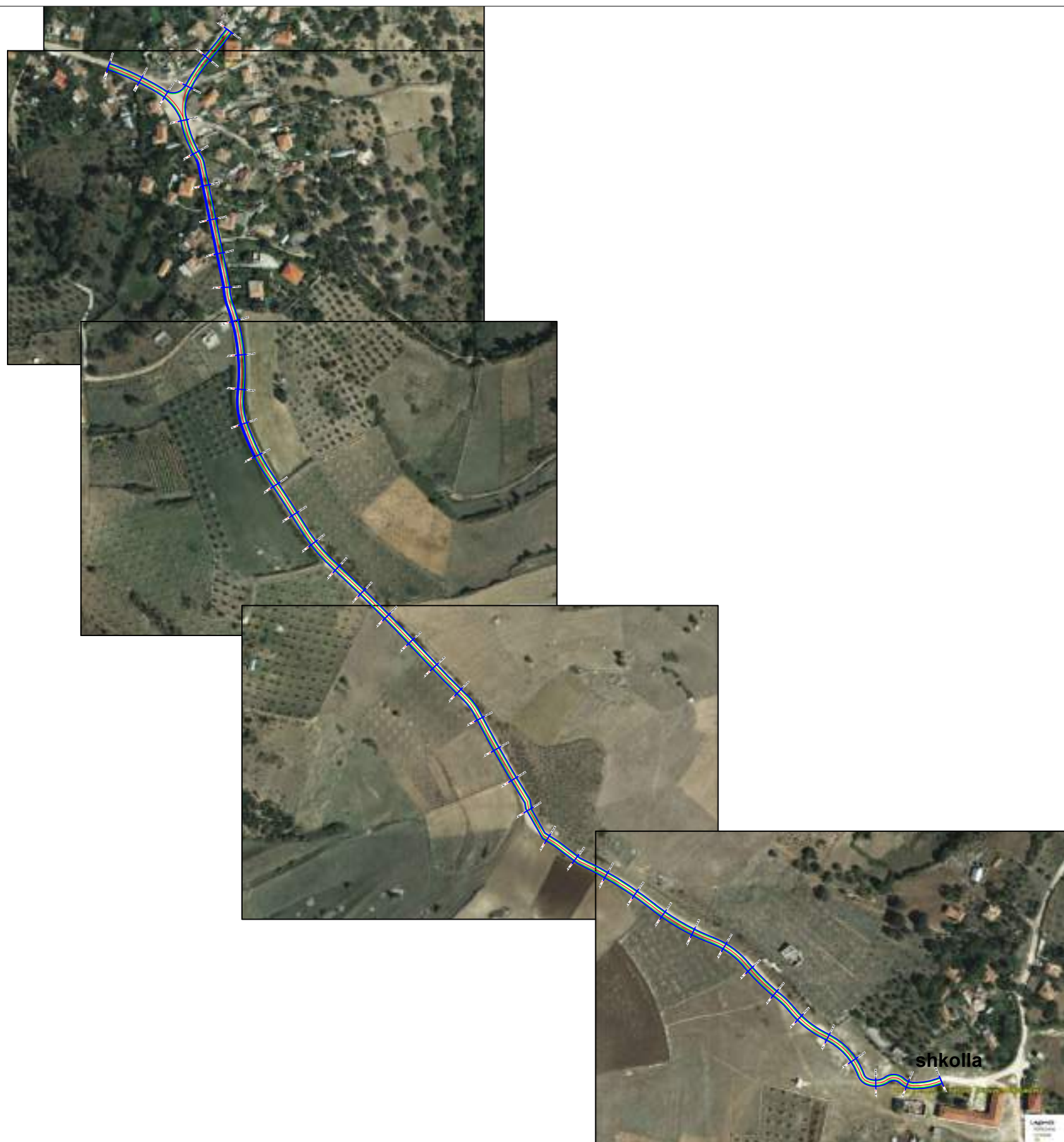

REPUBLIKA E SHQIPERISE
BASHKIA MALLAKASTER

STUDIM PROJEKTIM
- PROJEKT ZBATIM -
2024

OBJEKTI: RIKONSTRUKSION I RRUGEVE NE FSHATRAT E NJESISE
ADMINISTRATIVE FRATAR DHE KUTE

PROJEKTOI: XH & MILER sh.p.k

RRUGE NE FSHATIN DRIZAR
PLANIMETRIA E RRUGES

Shkalla

Viz.

FL-31



shk

'Dino Ahmeti', 9 V

 REPUBLIKA E SHQIPERISE BASHKIA MALLAKASTER	STUDIM PROJEKTIM - PROJEKT ZBATIM -	OBJEKTI: RIKONSTRUKSION I RRUGEVE NE FSHATRA E NJESISE ADMINISTRATIVE FRATAR DHE KUTE	PROJEKTOI: XH & MILER sh.p.k	RRUGE NE FSHATIN DRIZAR	
	2024			PLANIMETRIA E RRUGES	Shkalla 1:500



REPUBLIKA E SHQIPERISE
BASHKIA MALLAKASTER

STUDIM PROJEKTIM
- PROJEKT ZBATIM -

2024

OBJEKTI: RIKONSTRUKSION I RRUGEVE NE FSHATRA E NJESISE
ADMINISTRATIVE FRATAR DHE KUTE

PROJEKTOI: XH & MILER sh.p.k

RRUGE NE FSHATIN DRIZAR

PLANIMETRIA E RRUGES

Shkalla
1:500

Viz.
FL-33

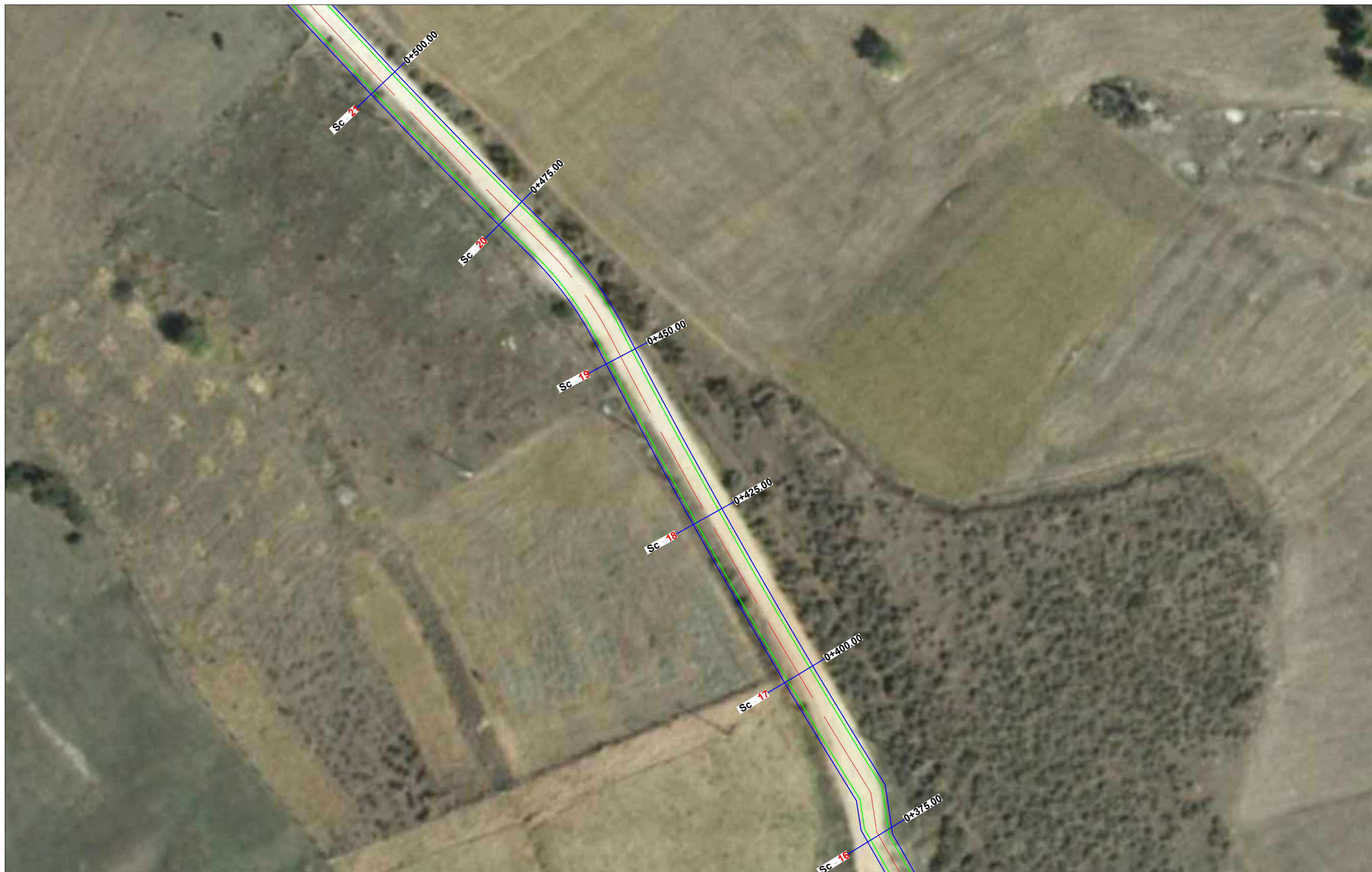

 REPUBLIKA E SHQIPERISE BASHKIA MALLAKASTER	STUDIM PROJEKTIM - PROJEKT ZBATIM -	OBJEKTI: RIKONSTRUKSION I RRUGEVE NE FSHATRA E NJESISE ADMINISTRATIVE FRATAR DHE KUTE	PROJEKTOI: XH & MILER sh.p.k	RRUGE NE FSHATIN DRIZAR	
	2024			PLANIMETRIA E RRUGES	



REPUBLIKA E SHQIPERISE
BASHKIA MALLAKASTER

STUDIM PROJEKTIM
- PROJEKT ZBATIM -
2024

OBJEKTI: RIKONSTRUKSION I RRUGEVE NE FSHATRA E NJESISE
ADMINISTRATIVE FRATAR DHE KUTE

PROJEKTOI: XH & MILER sh.p.k

RRUGE NE FSHATIN DRIZAR
PLANIMETRIA E RRUGES

Shkalla
1:500

Viz.
FL-35

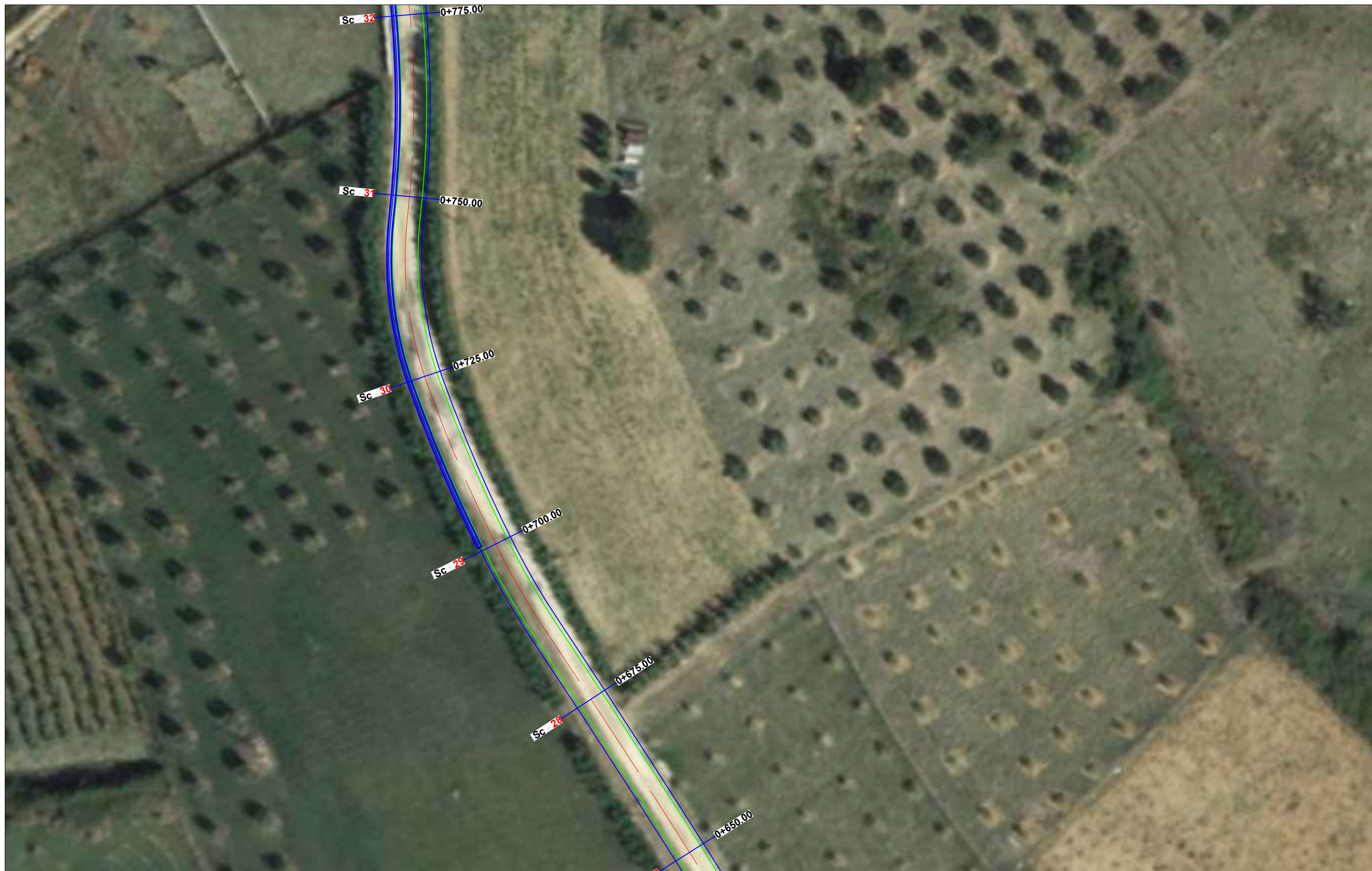

 REPUBLIKA E SHQIPERISE BASHKIA MALLAKASTER	STUDIM PROJEKTIM - PROJEKT ZBATIM -	OBJEKTI: RIKONSTRUKSION I RRUGEVE NE FSHATRAT E NJESISE ADMINISTRATIVE FRATAR DHE KUTE	PROJEKTOI: XH & MILER sh.p.k	RRUGE NE FSHATIN DRIZAR	
	2024			PLANIMETRIA E RRUGES	



REPUBLIKA E SHQIPERISE
BASHKIA MALLAKASTER

STUDIM PROJEKTIM
- PROJEKT ZBATIM -
2024

OBJEKTI: RIKONSTRUKSION I RRUGEVE NE FSHATRAT E NJESISE
ADMINISTRATIVE FRATAR DHE KUTE

PROJEKTOI: XH & MILER sh.p.k

RRUGE NE FSHATIN DRIZAR
PLANIMETRIA E RRUGES

Shkalla
1:500

Viz.
FL-37

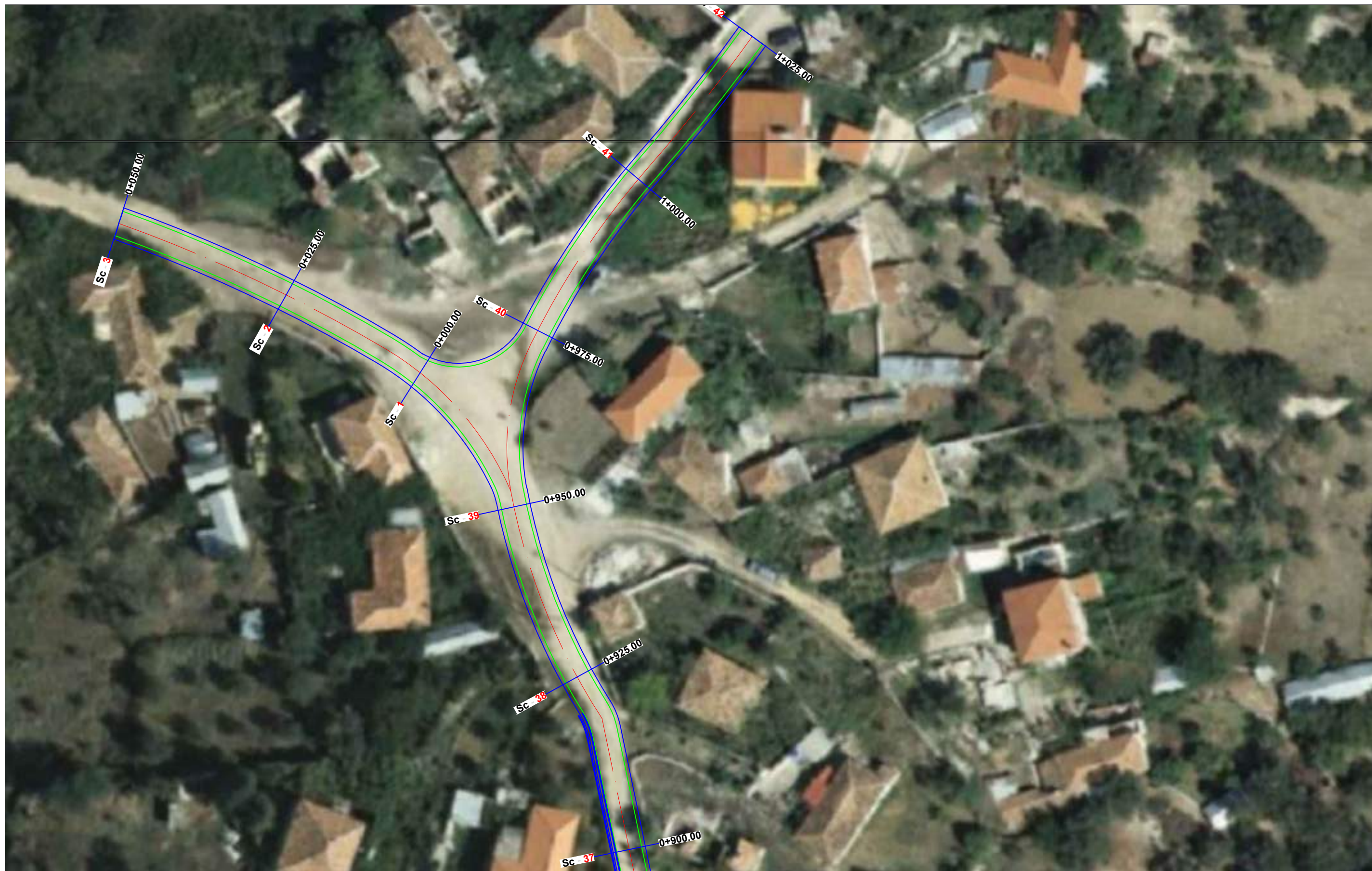

REPUBLIKA E SHQIPERISE
BASHKIA MALLAKASTER

STUDIM PROJEKTIM
- PROJEKT ZBATIM -
2024

OBJEKTI: RIKONSTRUKSION I RRUGEVE NE FSHATRAT E NJESISE
ADMINISTRATIVE FRATAR DHE KUTE

PROJEKTOI: XH & MILER sh.p.k

RRUGE NE FSHATIN DRIZAR
PLANIMETRIA E RRUGES

Shkalla
1:500

Viz.
FL-38

Profili gjatesor

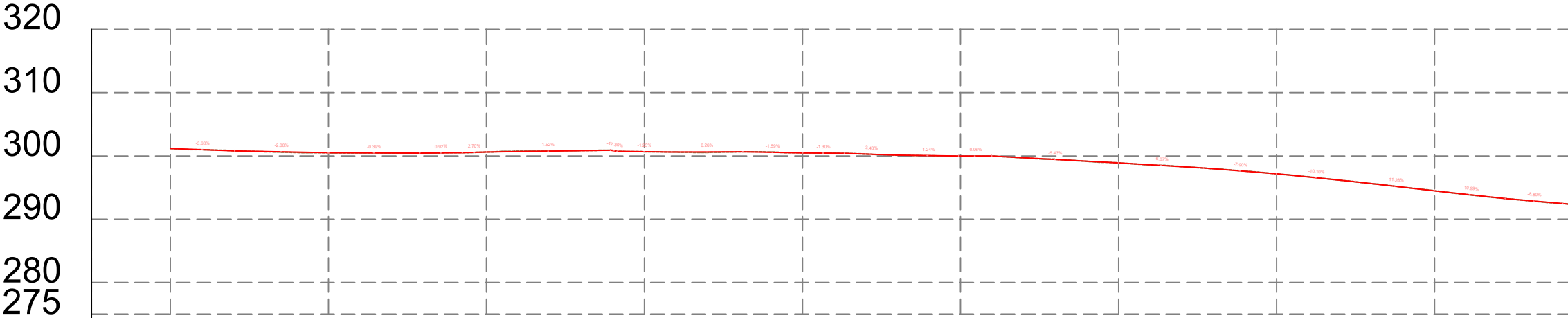

Distanca	Progresive	0+000	0+025	0+050	0+075	0+100	0+125	0+150	0+175	0+200			
	Pjesore	1	2	3	4	5	6	7	8	9	10	11	12
Kuota	Terreni	301.18	300.49	300.60	300.67	300.49	300.00	298.90	297.17	294.50			
	Projekti	301.18	300.50	300.60	300.66	300.49	300.00	298.90	297.17	294.50			



Profili gjatesor aksi 1

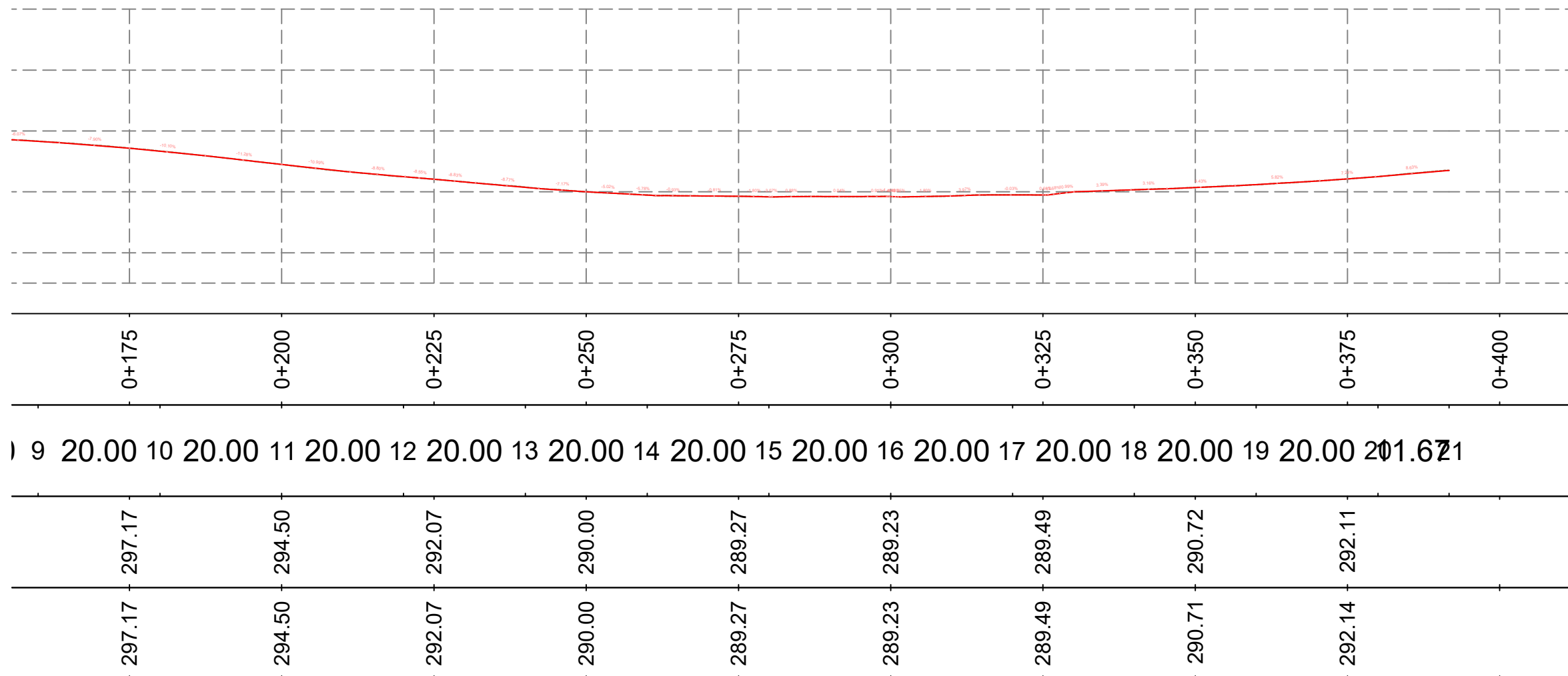

9 20.00 10 20.00 11 20.00 12 20.00 13 20.00 14 20.00 15 20.00 16 20.00 17 20.00 18 20.00 19 20.00 20 1.67 21

Profili gjatesor aksi 1

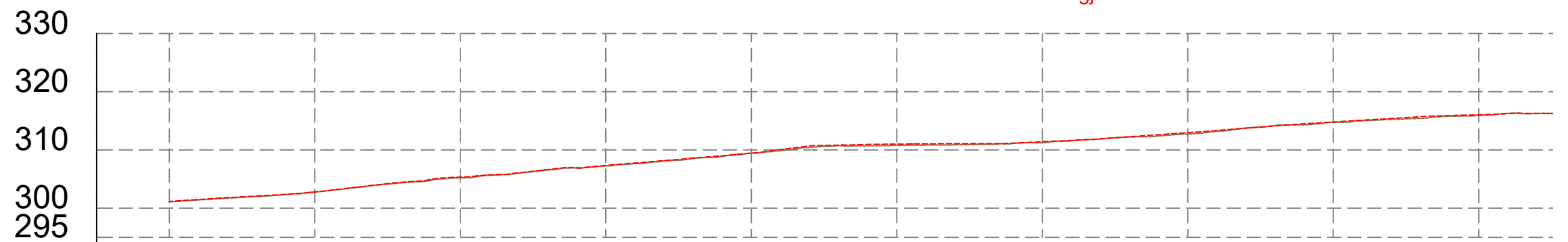

Distanca	Progresive	0+000	0+025	0+050	0+075	0+100	0+125	0+150	0+175	0+200	0+225	
	Pjesore	1	2	3	4	5	6	7	8	9	10	11
Kuota	Terreni	301.08	302.79	305.23	307.25	309.44	310.79	311.24	312.75	314.74	315.96	
	Projekti	301.18	302.79	305.34	307.35	309.46	311.02	311.42	312.99	314.82	316.05	



Profili gjatesor aksi 1

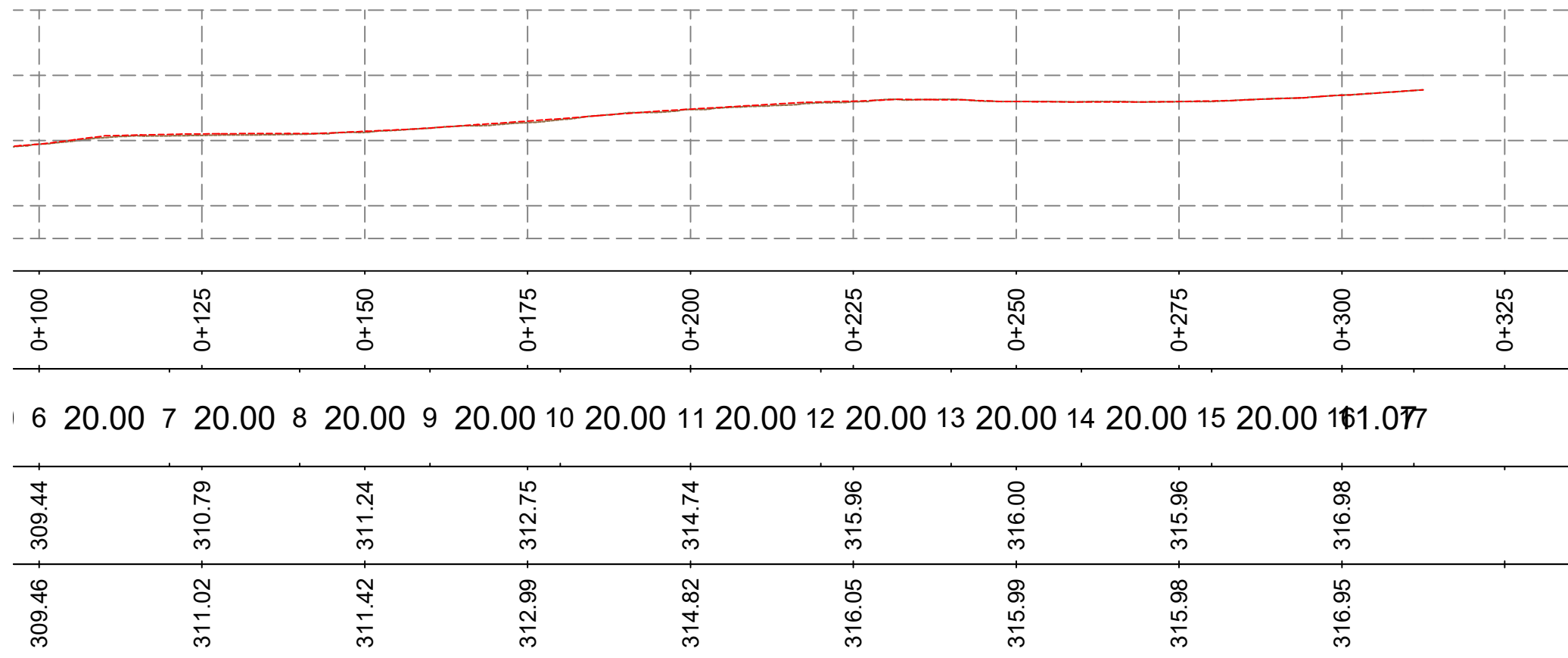

Profili gjatesor aksi 2

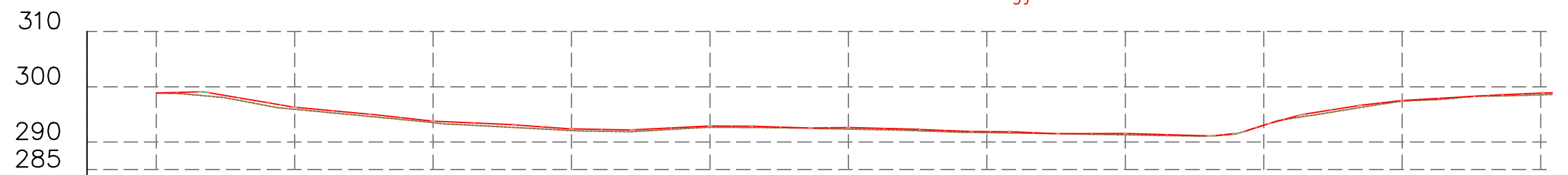

Distanca	Progresive	0+000	0+025	0+050	0+075	0+100	0+125	0+150	0+175	0+200	0+225	0+250			
	Pjesore		1	2	3	4	5	6	7	8	9	10	11	12	13
Kuota	Terreni	298.88	295.92	293.51	292.07	292.67	292.35	291.71	291.30	293.04	297.38	298.55			
	Projekti	298.88	296.30	293.79	292.38	292.91	292.64	291.90	291.54	293.04	297.50	298.86			



Profili gjatesor aksi 2

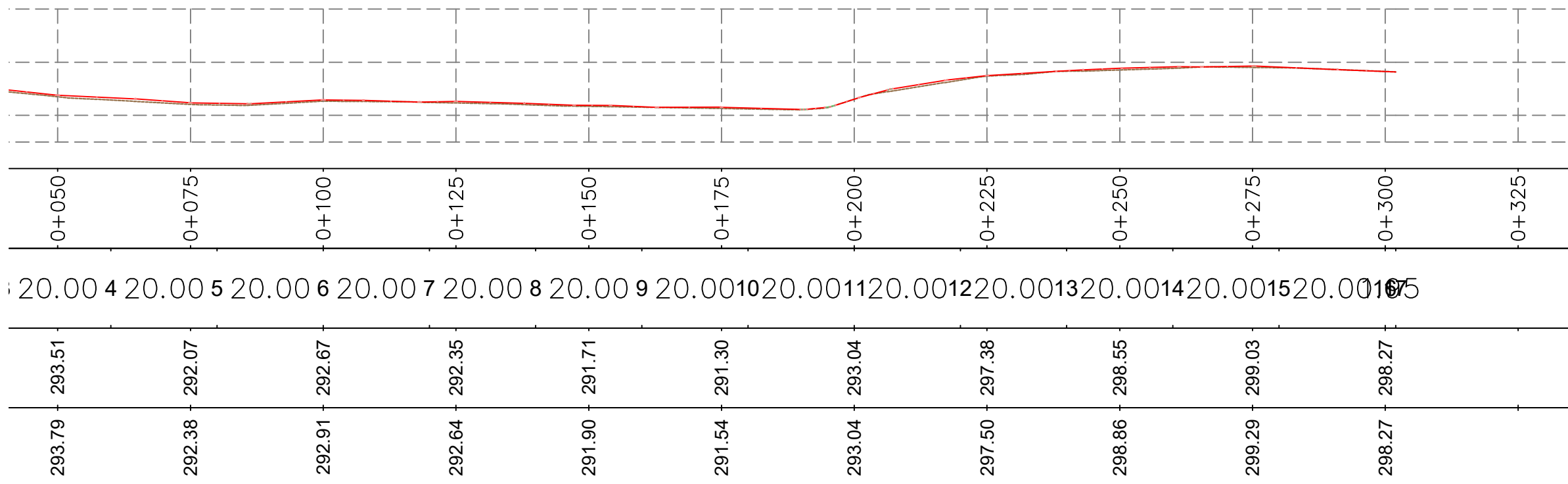

REPUBLIKA E SHQIPERISE
BASHKIA MALLAKASTER

STUDIM PROJEKTIM
- PROJEKT ZBATIM -

2024

OBJEKTI: RIKONSTRUKSION I RRUGEVE NE FSHATRAT E NJESISE
ADMINISTRATIVE FRATAR DHE KUTE

PROJEKTOI: XH & MILER sh.p.k

RRUGE NE FSHATIN FRATAR
PROFILI GJATESOR I RRUGES

Shkalla

Viz.

FL-44

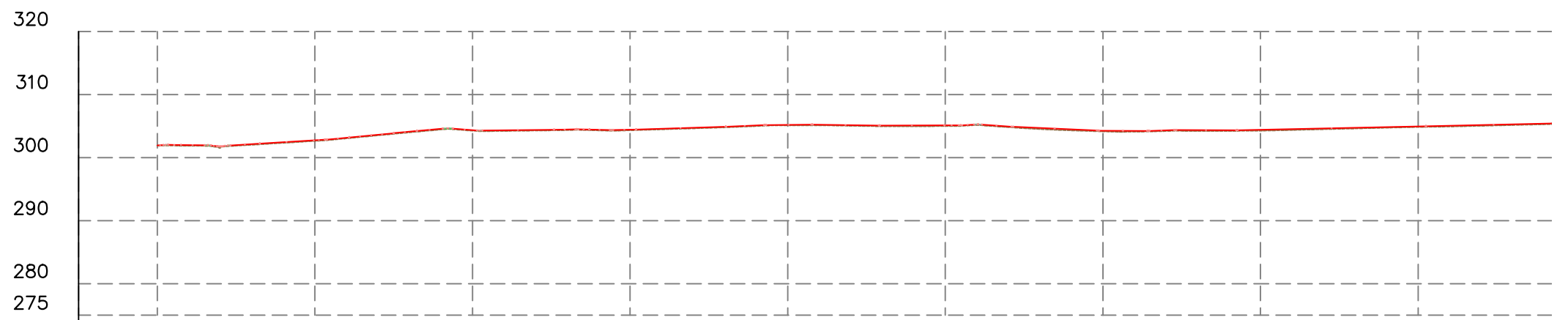

Distanca	Progresive	0+000	0+025	0+050	0+075	0+100	0+125	0+150	0+175	0+200		
	Pjesore	1	2	3	4	5	6	7	8	9	10	11
Kuota	Terreni	301.94	302.65	304.28	304.35	305.12	305.01	304.17	304.28	304.87		
	Projekti	301.94	302.75	304.38	304.45	305.21	305.11	304.29	304.43	304.96		



Profili gjatesor aksi 5

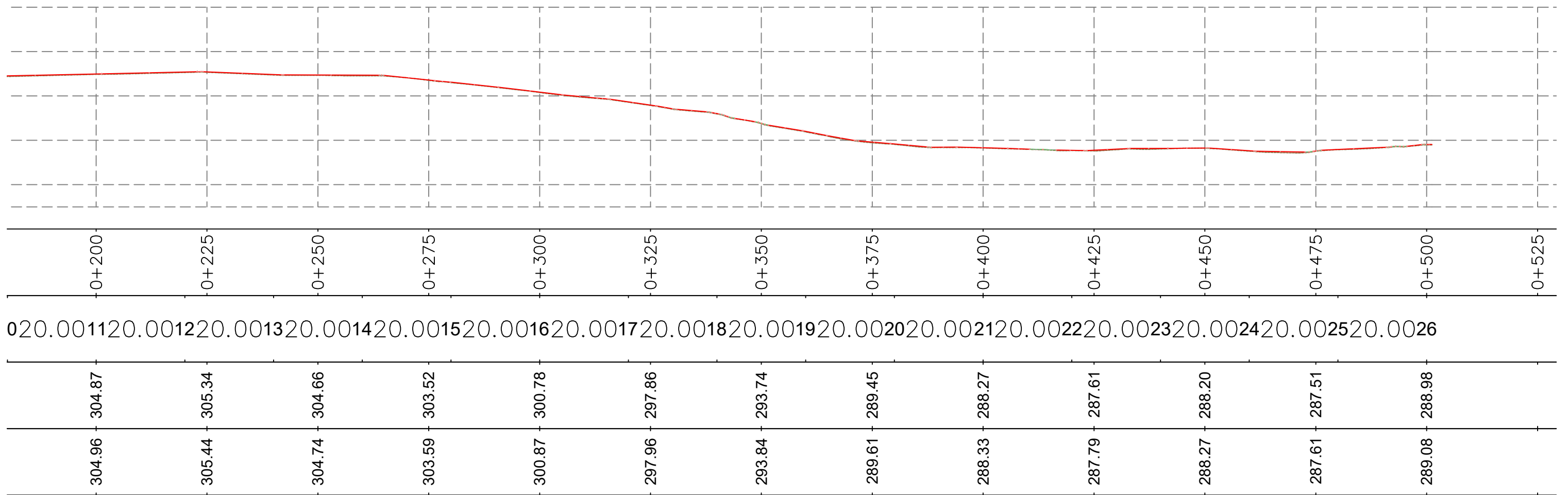

Profili gjatesor aksi 6

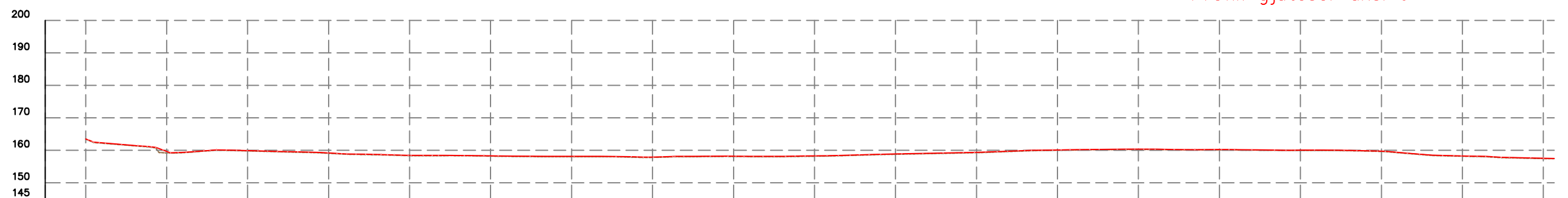

Distanca	Progresive	0+000	0+025	0+050	0+075	0+100	0+125	0+150	0+175	0+200	0+225	0+250	0+275	0+300	0+325	0+350	0+375	0+400	0+425	0+450				
	Pjesore	1	2	3	4	5	6	7	8	9	10	11	12	13	14	15	16	17	18	19	20	21	22	23
Kuota	Terreni	163.44	159.16	159.80	159.07	158.34	158.19	158.02	157.81	158.09	158.17	158.76	159.26	160.00	160.25	160.11	159.95	159.63	158.16	157.45				
	Projekti	163.44	159.66	159.90	159.17	158.44	158.30	158.13	157.91	158.19	158.27	158.86	159.37	160.10	160.34	160.21	160.04	159.72	158.26	157.55				



REPUBLIKA E SHQIPERISE
BASHKIA MALLAKASTER

STUDIM PROJEKTIM
- PROJEKT ZBATIM -

2024

OBJEKTI: RIKONSTRUKSION I RRUGEVE NE FSHATRA E NJESISE
ADMINISTRATIVE FRATAR DHE KUTE

PROJEKTOI: XH & MILER sh.p.k

RRUGE NE FSHATIN FRATAR

PROFILI GJATESOR I RRUGES

Shkalla Viz.
FL-47

Profili gjatesor aksi 6

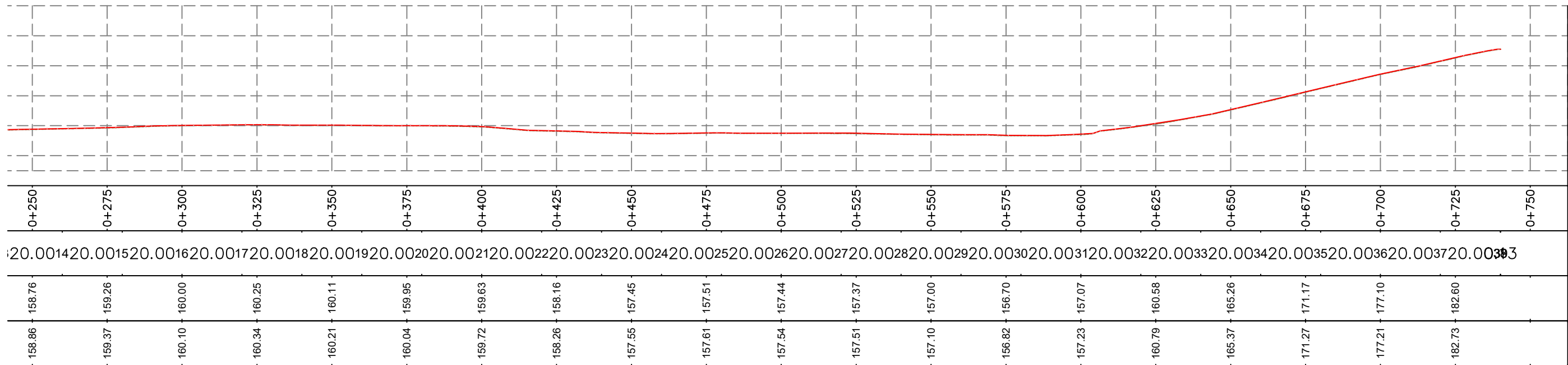

PAMJE BALLORE E PORTALIT Sh 1:50

PLANIMETRIA E PORTALEVE PER TOMBINO Ø 600 Sh. 1:50

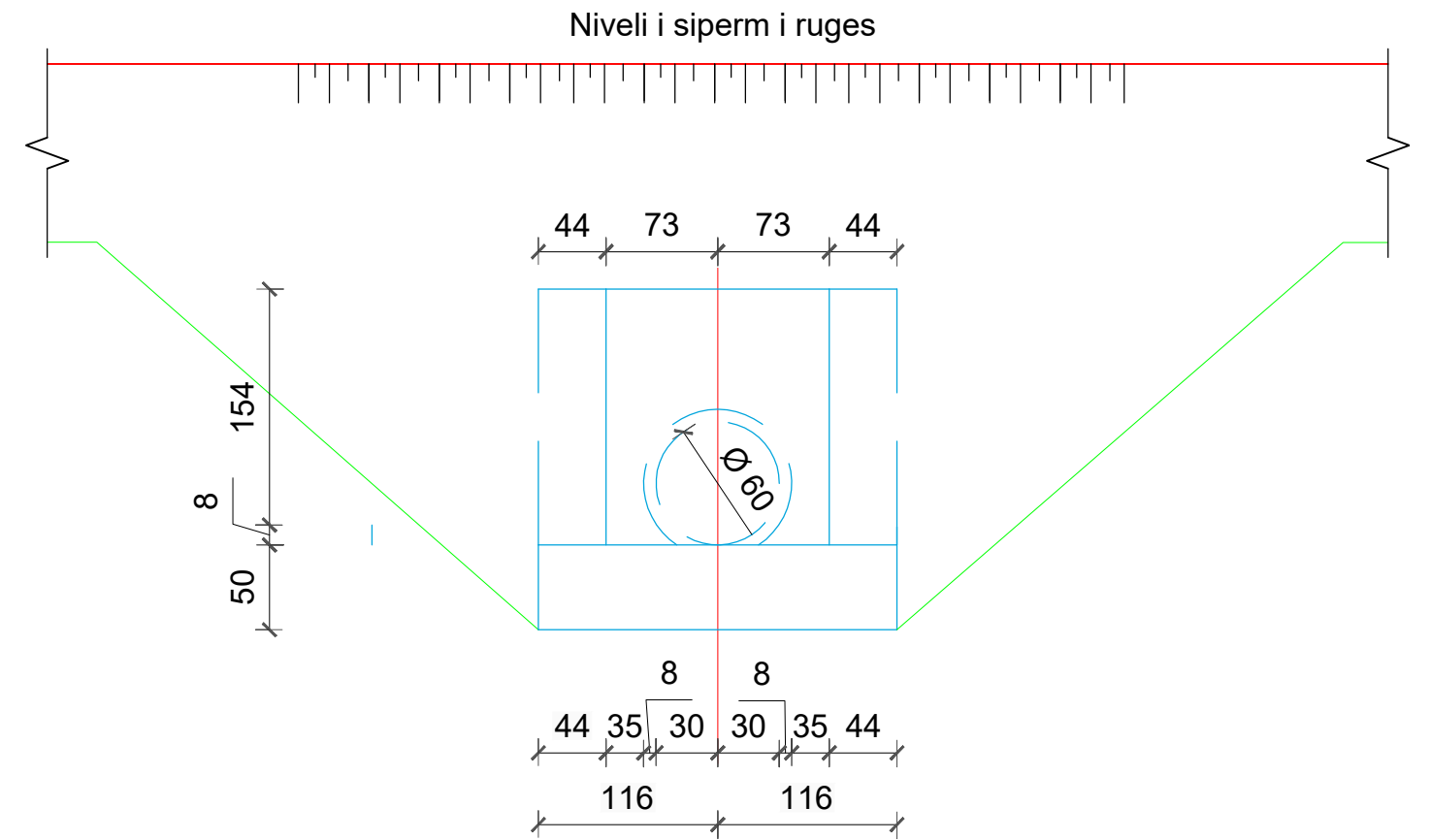
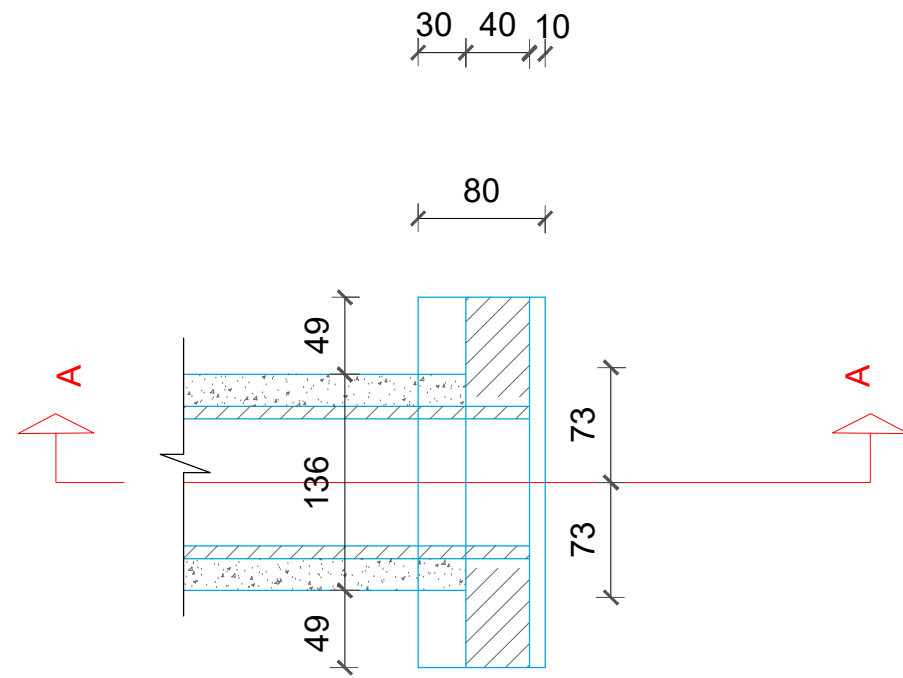

PRERJA A-A Sh.1:50

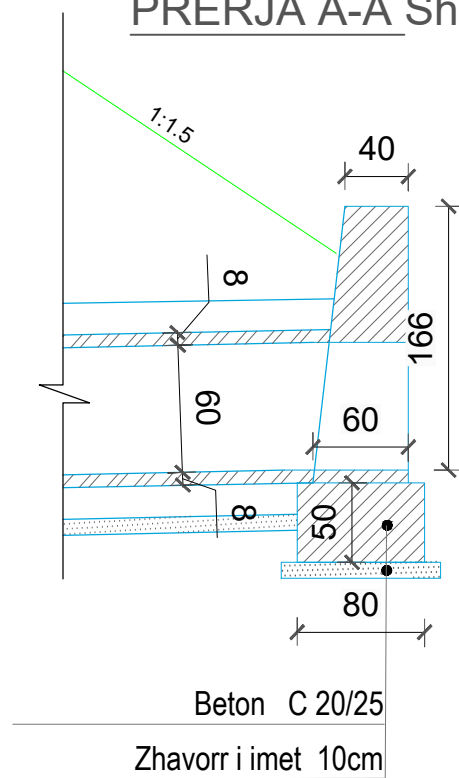

REPUBLIKA E SHQIPERISE
BASHKIA MALLAKASTER

STUDIM PROJEKTIM
- PROJEKT ZBATIM -

2024

OBJEKTI: RIKONSTRUKSION I RRUGEVE NE FSHATRAT E NJESISE
ADMINISTRATIVE FRATAR DHE KUTE

PROJEKTOI: XH & MILER sh.p.k

TOMBINO

DETAJE TOMBINO

Shkalla
1:50

Viz.
FL-1

Rruga Fratar Aksi 1
km (0+000.00 - 0+380.00)

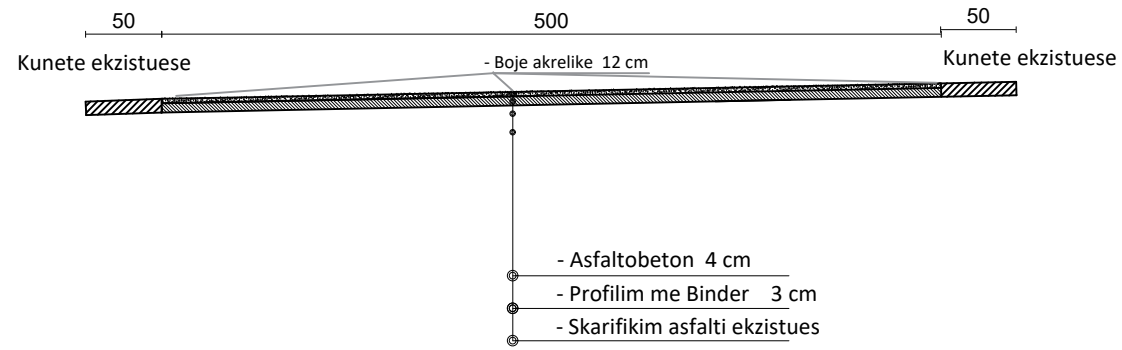

Rruga Fratar Aksi 2
km (0+000.00 - 0+302.00)

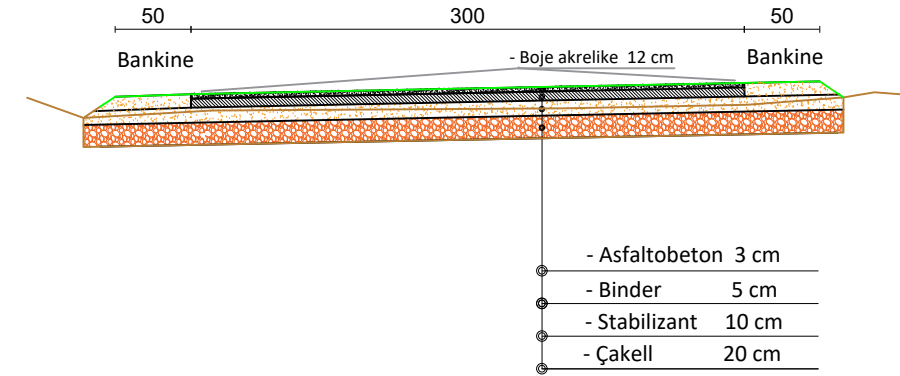

Rruga Fratar Aksi 1
km (0+000.00 - 0+311.00)

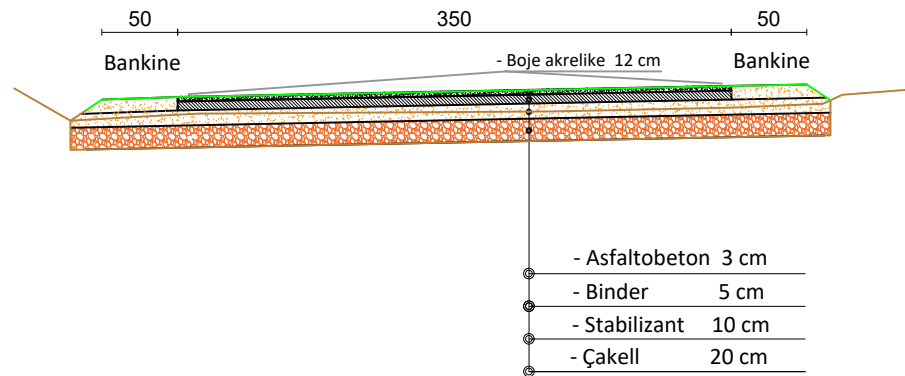

Rruga Fratar Aksi 3
km (0+000.00 - 0+069.00)

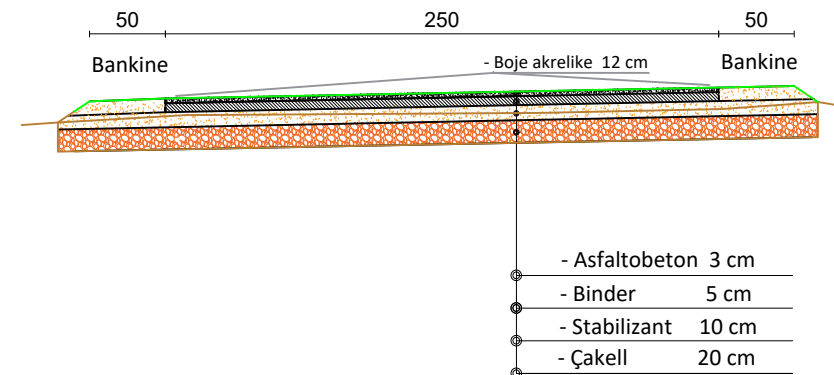

REPUBLIKA E SHQIPERISE
BASHKIA MALLAKASTER

STUDIM PROJEKTIM
- PROJEKT ZBATIM -

2024

OBJEKTI: RIKONSTRUKSION I RRUGEVE NE FSHATRAT E NJESISE
ADMINISTRATIVE FRATAR DHE KUTE

PROJEKTOI: XH & MILER sh.p.k

Xhuljeta
Duro

Digitally signed by
Xhuljeta Duro
Date: 2024.11.15
14:57:31 +02'00'

RRUGE NE FSHATIN FRATAR DHE KUTE

PROFILI TERTHOR I RRUGES

Shkalla Viz.
FL-49

Rruga Fratar Aksi 4
km (0+000.00 - 0+050.00)

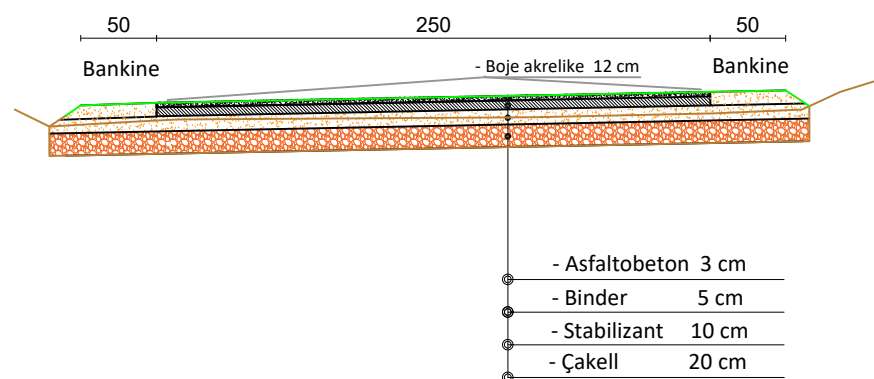

Rruga Fratar Aksi 6
km (0+000.00 - 0+740.00)

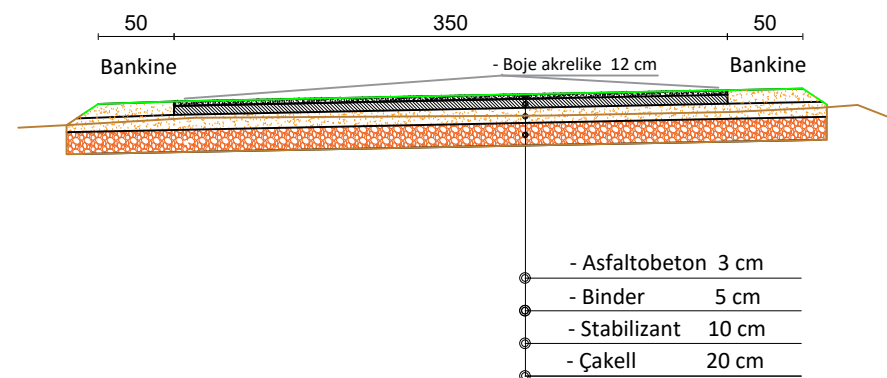

Rruga Fratar Aksi 5
km (0+000.00 - 0+500.00)

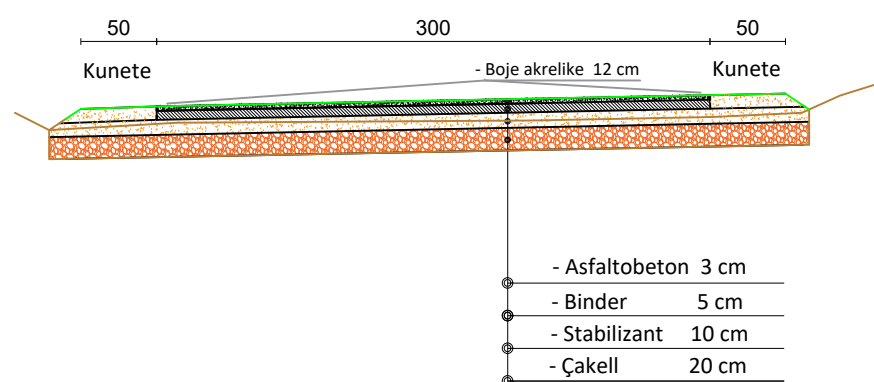

Rruga Drizar
km (0+000.00 - 1+025.00)

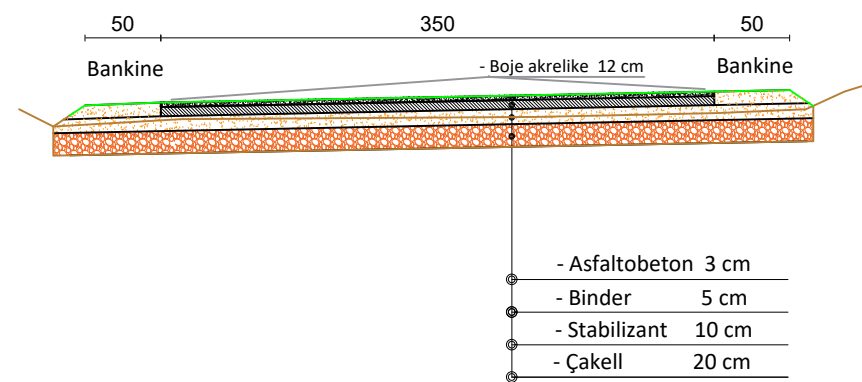

REPUBLIKA E SHQIPERISE
BASHKIA MALLAKASTER

STUDIM PROJEKTIM
- PROJEKT ZBATIM -

2024

OBJEKTI: RIKONSTRUKSION I RRUGEVE NE FSHATRAT E NJESISE
ADMINISTRATIVE FRATAR DHE KUTE

PROJEKTOI: XH & MILER sh.p.k

RRUGE NE FSHATIN FRATAR DHE KUTE

PROFILI TERTHOR I RRUGES

Shkalla

Viz.

FL-50