

MIRATOHET  
KRYETAR  
Z.NERTIL BELLAJ



BASHKIA SELENICË

# PROJEKT ZBATIMI

"RIKUALIFIKIM URBAN I PALLATEVE NË HYRJE TË SELENICËS"

SELNICË 2024



**PROJEKTUES: "SIRE-ALB" SH.P.K**

HEAD OFFICE - VLORË;  
Mob: +355 69 81 65 747 NIPT: M36415202E  
Rruga "Gjergj Arianiti", Lagjia "Pavarësia"  
Pallati "Endru", Kati Përdhe 9414, Vlorë  
e-mail: sire-alb@outlook.com

## PËRMBAJTJA

MASTERPLANI  
 PLANI I SHESHIT  
 MASTERPLANI TEKNIK  
 DETAJI I PARKUT  
 PLANI I NDRIÇIMIT  
 PLANI I K.U.B  
 PRERJE A-A  
 SHTRESAT E FASADES NE PRERJE  
 DETAJE TE MBYLLJES SE FASADES  
 DETAJE TE ULLUQEVE DHE VESHJET ZINKATO  
 BETONIMI I FUSHËS SË SPORTIT ME FUGA DILATACIONI  
 DETAJE TË RRETHIMIT TË FUSHËS SPORTIVE  
 DETAJE I ARMIMIT TE KOLLONCINAVE DHE TRAREVE  
 DETAJ I RRETHIMIT TË SHKOLLËS  
 DETAJE TË MBJELLJES SË PEMËVE  
 DETAJE TË KOSHIT TË BASKETBOLLIT  
 DETAJE TË STOLAVE + KOSHAVE  
 DETAJE TE KENDIT TE LOJRAVE  
 DETAJE NDRICIMI  
 DETAJE TE PORTËS SË MINFUTBOLLIT  
 DETAJE TË STOLAVE + KOSHAVE  
 FASADA JUGORE  
 FASADA VERIORE  
 FASADA LINDORE  
 FASADA PERENDIMORE  
 RENDERA 3D

OBJEKTI :

PROJEKTI I ZBATIMIT  
 "RIKUALIFIKIM URBAN I PALLATEVE NË HYRJE TË  
 SELENICËS"

VENDODHJA: QYTETI SELENICË



BASHKIA SELENICË

GRUPI I PROJEKTIMIT

SIRE-ALB SH.P.K

NR.LICENSE: N.7185/5

ING. MESUDE AHMETAJ LIC K.2715/1

ING. BESTAR ÇEKREZI LIC M.1464/1

ING. SULLTANE NEZHAI LIC E.0638/2

ING. RENALDO KARAJ

ARK. TATJANE LIÇAJ LIC A.0823

SHENIME:



DATA: GUSHT 2024

EMËRTESA E FLETËS:

PERMBAJTJA

FL.A 01



Architecture Engineering

e-mail: sire-alb@outlook.com

Tel: 0698165747

Adresa: Rr. "Cjergj Arjanit",  
Lagja "Pavarësia, Vlorë"

# MASTERPLANI



OBJEKTI :  
 PROJEKTI I ZBATIMIT  
 "RIKUALIFIKIM URBAN I PALLATEVE NË HYRJE TË SELENICËS"

VENDODHJA: QYTETI SELENICE,  
 BASHKIA SELENICE



BASHKIA SELENICE

GRUPI I PROJEKTIMIT  
 SIRE-ALB SH.P.K  
 NR.LICENSE: N.7185/5

ING. MESUDE AHMETAJ LIC K.2715/1  
 ING. BESTAR ÇEKREZI LIC M.1464/1  
 ING. SULLTANE NEZHAI LIC E.0638/2  
 ING. RENALDO KARAJ  
 ARK. TATJANE LIÇAJ LIC A.0823

SHENIME:

DATA: GUSHT 2024

EMËRTESA E FLETËS:

MASTERPLANI

SH: 1:500

FL.A02



**SIRE** ALB  
 Architecture Engineering  
 e-mail: sire-alb@outlook.com  
 Tel: 0696165747  
 Adresa: Rr. "Cjergj Arjanit",  
 Lagja "Povarsia, Vlojt"

# MASTERPLANI TEKNIK



OBJEKTI :  
 PROJEKTI I ZBATIMIT  
 "RIKUALIFIKIM URBAN I PALLATEVE NË HYRJE TË SELENICËS"

VENDODHJA: QYTETI SELENICE,  
 BASHKIA SELENICE



BASHKIA SELENICE

GRUPI I PROJEKTIMIT

SIRE-ALB SH.P.K

NR.LICENSE: N.7185/5

- ING. MESUDE AHMETAJ LIC K.2715/1
- ING. BESTAR ÇEKREZI LIC M.1464/1
- ING. SULLTANE NEZHAJ LIC E.0638/2
- ING. RENALDO KARAJ
- ARK. TATJANE LIÇAJ LIC A.0823

SHENIME:

DATA: GUSHT 2024

EMËRTESA E FLETËS:

MASTERPLANI

SH: 1:500

FL. A03



SIRE ALB  
 Architecture Engineering  
 e-mail: sire-alb@outlook.com  
 Tel: 0698165747  
 Adresa: Rr. "Cjergj Arjani",  
 Lagjia "Pavarësia, Vlorë"

# DETAJ I PARKUT



OBJEKTI :

PROJEKTI I ZBATIMIT  
 "RIKUALIFIKIM URBAN I PALLATEVE NË HYRJË TË SELENICËS"

VENDODHJA: QYTETI SELENICE,  
 BASHKIA SELENICE



BASHKIA SELENICE

GRUPI I PROJEKTIMIT

SIRE-ALB SH.P.K

NR.LICENSE: N.7185/5

ING. MESUDE AHMETAJ LIC K.2715/1

ING. BESTAR ÇEKREZI LIC M.1464/1

ING. SULLTANE NEZHAI LIC E.0638/2

ING. RENALDO KARAJ

ARK. TATJANE LIÇAË LIC A.0823

SHENIME:

	Plante		Bllokuar të Integruar		Planime
	Placime		Planime		Vendje me sist. ven. kuptim
	Plote me ujë		Shirëz bekuar		Skizë
	Plote me ujë për tërësi		Shirëzë rrethore 1m-5m		Muze rrethore
	Plote bekuar		Shirëzë rrethore 7.5m		Muze rrethore
	Plote bekuar		Shirëzë rrethore 7.5m		Muze rrethore
	Plote bekuar		Shirëzë rrethore 7.5m		Muze rrethore
	Plote bekuar		Shirëzë rrethore 7.5m		Muze rrethore
	Plote bekuar		Shirëzë rrethore 7.5m		Muze rrethore

DATA: GUSHT 2024

EMËRTESA E FLETËS:

DETAJ I PARKUT

SH: 1:500

FL. A04



Architecture Engineering  
 e-mail: sire-alb@outlook.com  
 Tel: 06/98165747  
 Adresa: Rr. "Gjergj Arjanit",  
 Lagja "Plovaresia, Vlore"

# PLANI I NDRICIMIT



OBJEKTI :

PROJEKTI I ZBATIMIT  
"RIKUALIFIKIM URBAN I PALLATEVE NË HYRJE TË  
SELENICËS"

VENDODHJA: QYTETI SELENICE,  
BASHKIA SELENICE



BASHKIA SELENICE

GRUPI I PROJEKTIMIT

SIRE-ALB SH.P.K

NR.LICENSE: N.7185/5

ING. MESUDE AHMETAJ LIC K.2715/1

ING. BESTAR ÇEKREZI LIC M.1464/1

ING. SULLTANE NEZHAJ LIC E.0638/2

ING. RENALDO KARAJ

ARK. TATJANE LIÇAJ LIC A.0823

SHENIME:

- Shiritja aditimi n=5m
- Shiritja aditimi n=7.8 m
- Proshkollat e fushave sportive n= 5.70 m

DATA: GUSHT 2024

EMËRTESA E FLETËS:

PLANI I NDRICIMIT

SH: 1:500

FL.A05



SIRE ALB  
Architecture Engineering  
e-mail: sire-alb@outlook.com  
Tel: 0698165747  
Adresa: Rr. "Gjergj Arjanit",  
Llogja "Pavarësia, Vlorë"

# PLANI K.U.B



OBJEKTI :

PROJEKTI I ZBATIMIT  
"RIKUALIFIKIM URBAN I PALLATEVE NË HYRJE TË  
SELENICËS"

VENDODHJA: QYTETI SELENICE,  
BASHKIA SELENICE



BASHKIA SELENICE

GRUPI I PROJEKTIMIT

SIRE-ALB SH.P.K

NR.LICENSE: N.7185/5

ING. MESUDE AHMETAJ	LIC K.2715/I
ING. BESTAR ÇEKREZI	LIC M.1464/I
ING. SULTANE NEZHAJ	LIC E.0638/2
ING. RENALDO KARAJ	
ARK. TATJANE LIÇAJ	LIC A.0823

SHENIME:

— RIKUALIFIKIM KANALEVE  
■ KËNËTE  
■ PUSËTE

DATA: GUSHT 2024

EMËRTESA E FLETËS:

PLANI K.U.B

SH: 1:500

FL. A06



SIRE ALB  
Architecture Engineering

e-mail: sire-alb@outlook.com  
Tel: 0698165747  
Adresa: Rr. "Gjergj Arjanit",  
Lagja "Pavarsia, Vlorë"

PRERJE

PRERJA A-A

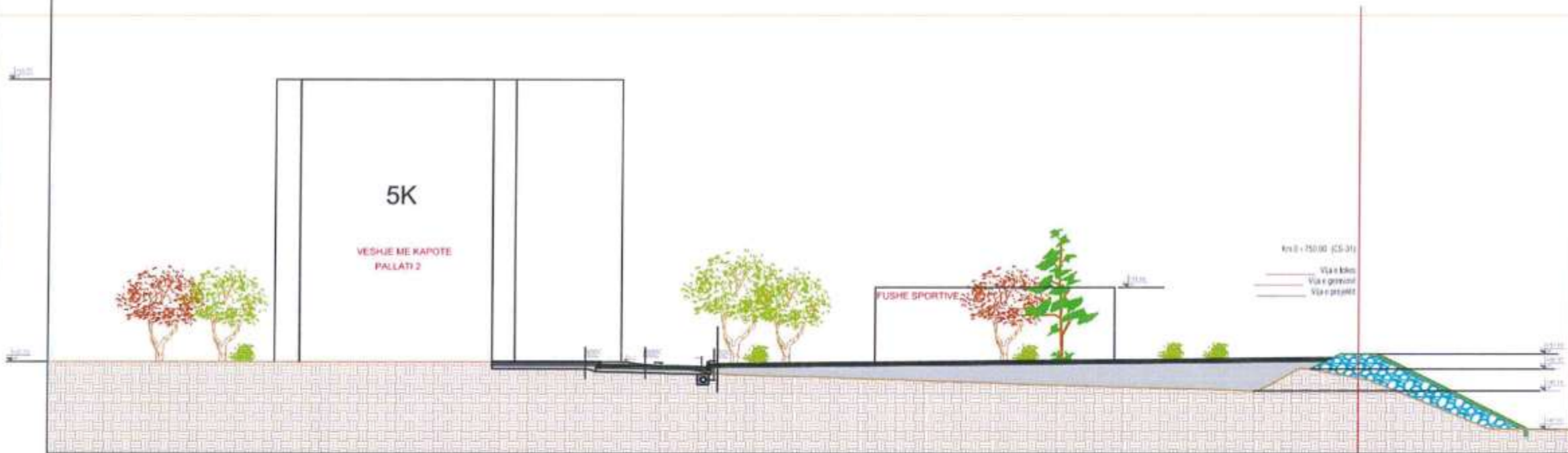

OBJEKTI :  
 PROJEKTI I ZBATIMIT  
 "RIKUALIFIKIM URBAN I PALLATEVE NË HYRJE TË SELENICËS"

VENDODHJA: QYTETI SELENICË



BASHKIA SELENICË

GRUPI I PROJEKTIMIT	
SIRE-ALB SH.P.K	
NR.LICENSE: N.7185/5	
ING. MESUDE AHMETAJ	LIC K.2715/1
ING. BESTAR ÇEKREZI	LIC M.1464/1
ING. SULLTANE NEZHAI	LIC E.0638/2
ING. RENALDO KARAJ	
ARK. TATJANE LIÇAJ	LIC A.0823

DETAJ I RRUGES ME TROTUARIN SH. 1:30

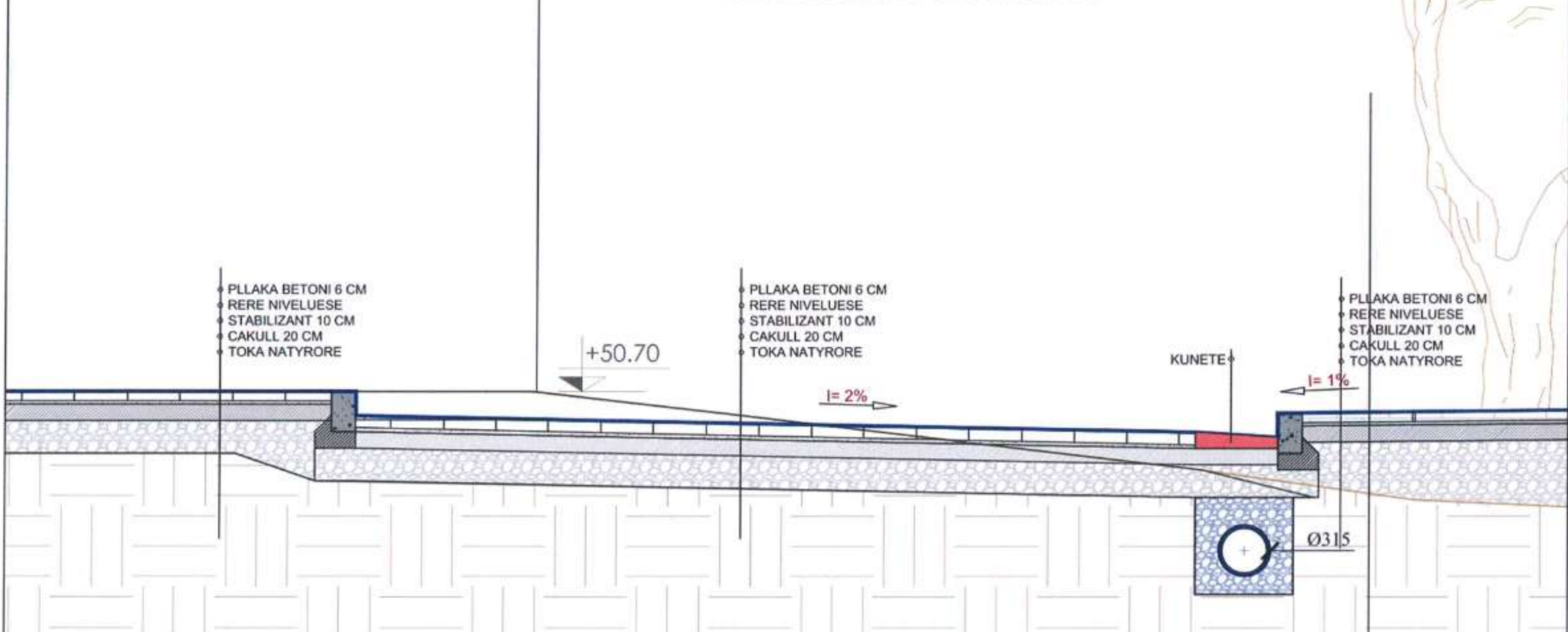

SHENIME:

DATA: GUSHT 2024	
EMËRTESA E FLETËS:	
PRERJA A-A	
SH.I:250	FL.A07

e-mail: sire-alb@outlook.com  
 Tel: 0698165747  
 Adresa: Rr. "Cjergj Arjanit",  
 Lagjia "Pavaresia, Vlorë"



# DETAJE TË SHITESAVE TE FSADES

D1

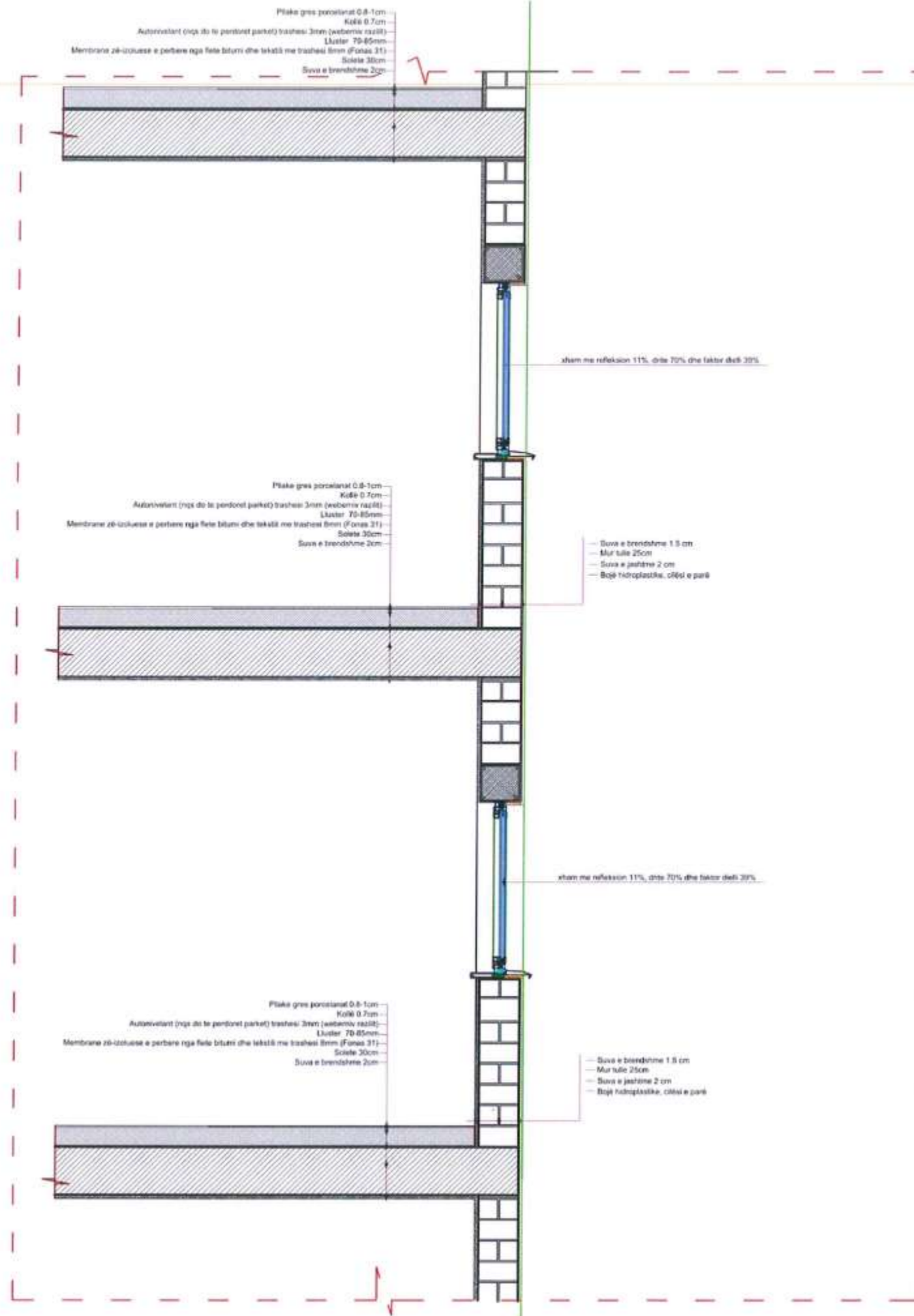

OBJEKTI :

PROJEKTI I ZBATIMIT  
"RIKUALIFIKIM URBAN I PALLATEVE NË HYRJE TË SELENICËS"

VENDODHJA: QYTETI SELENICË



BASHKIA SELENICË

GRUPI I PROJEKTIMIT

SIRE-ALB SH.P.K

NR.LICENSE: N.7185/5

ING. MESUDE AHMETAJ LIC K.2715/1

ING. BESTAR ÇEKREZI LIC M.1464/1

ING. SULLTANE NEZHAI LIC E.0638/2

ING. RENALDO KARAJ

ARK. TATJANE LIÇAJ LIC A.0823

SHENIME:



DATA: GUSHT 2024

EMËRTESA E FLETËS:

DETAJE TE SHITESAVE TE FSADES

SH.1:30

FL.A 08

SIRE ALB  
Architecture Engineering

e-mail: sire-alb@outlook.com  
Tel: 0698 165747  
Adresa: Rr. "Gjergj Arjanit",  
Lagjia "Pavarësia, Vlorë"

# DETAJE TË MBYLLJES SË FASADËS

D2

PJESA FUNDORE E FASADAVE SH.1.30

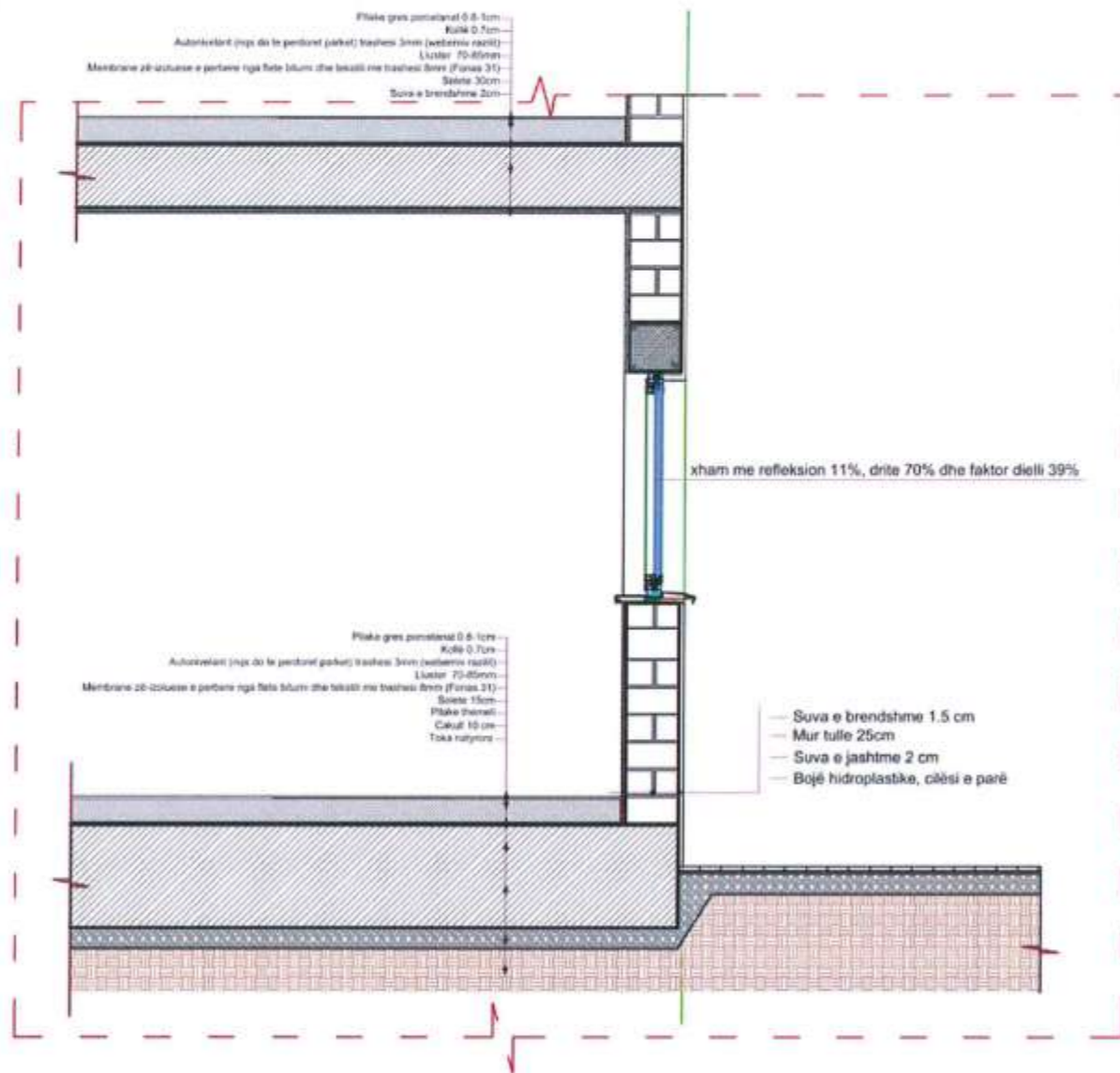

D3

ULLUQET DHE PROFILET ZINKATO SH.1.50

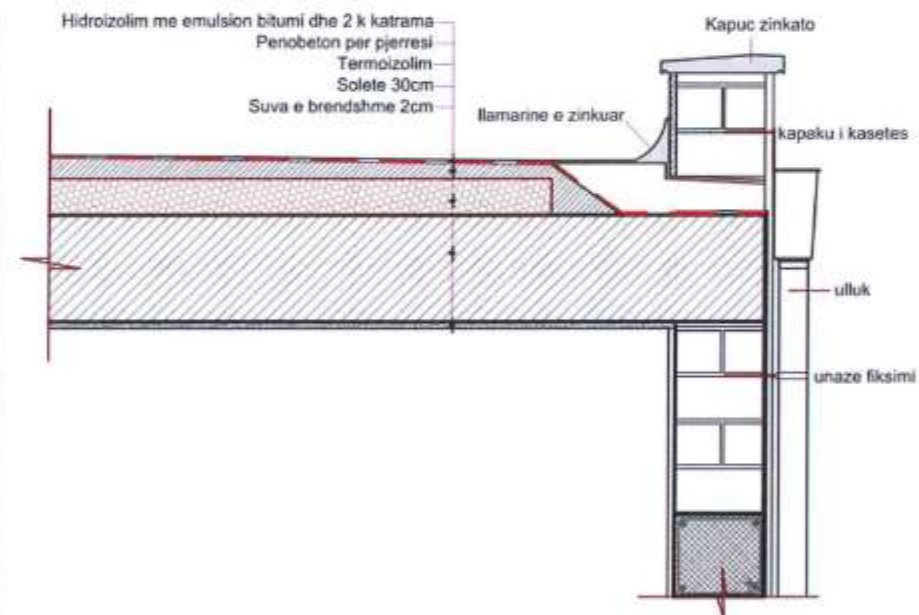

OBJEKTI :

PROJEKTI I ZBATIMIT  
"RIKUALIFIKIM URBAN I PALLATEVE NË HYRJE TË SELENICËS"

VENDODHJA: QYTETI SELENICË



BASHKIA SELENICË

GRUPI I PROJEKTIMIT

SIRE-ALB SH.P.K

NR.LICENSE: N.7185/5

ING. MESUDE AHMETAJ LIC K.2715/1

ING. BESTAR ÇEKREZI LIC M.1464/1

ING. SULLTANE NEZHAJ LIC E.0638/2

ING. RENALDO KARAJ

ARK. TATJANE LIÇAJ LIC A.0823

SHENIME:



DATA: GUSHT 2024

EMËRTESA E FLETËS:

DETAJE TË MBYLLJES SË FASADËS

SH.1:30

FL.A 09

SIRE ALB

Architecture Engineering

e-mail: sire-alb@outlook.com

Tel: 0698165747

Adresa: Rr. "Gjergj Arianiti",  
Lagjia "Pavarësia, Vlorë"

# PLANI I FUSHËS SË SPORTIT

D4

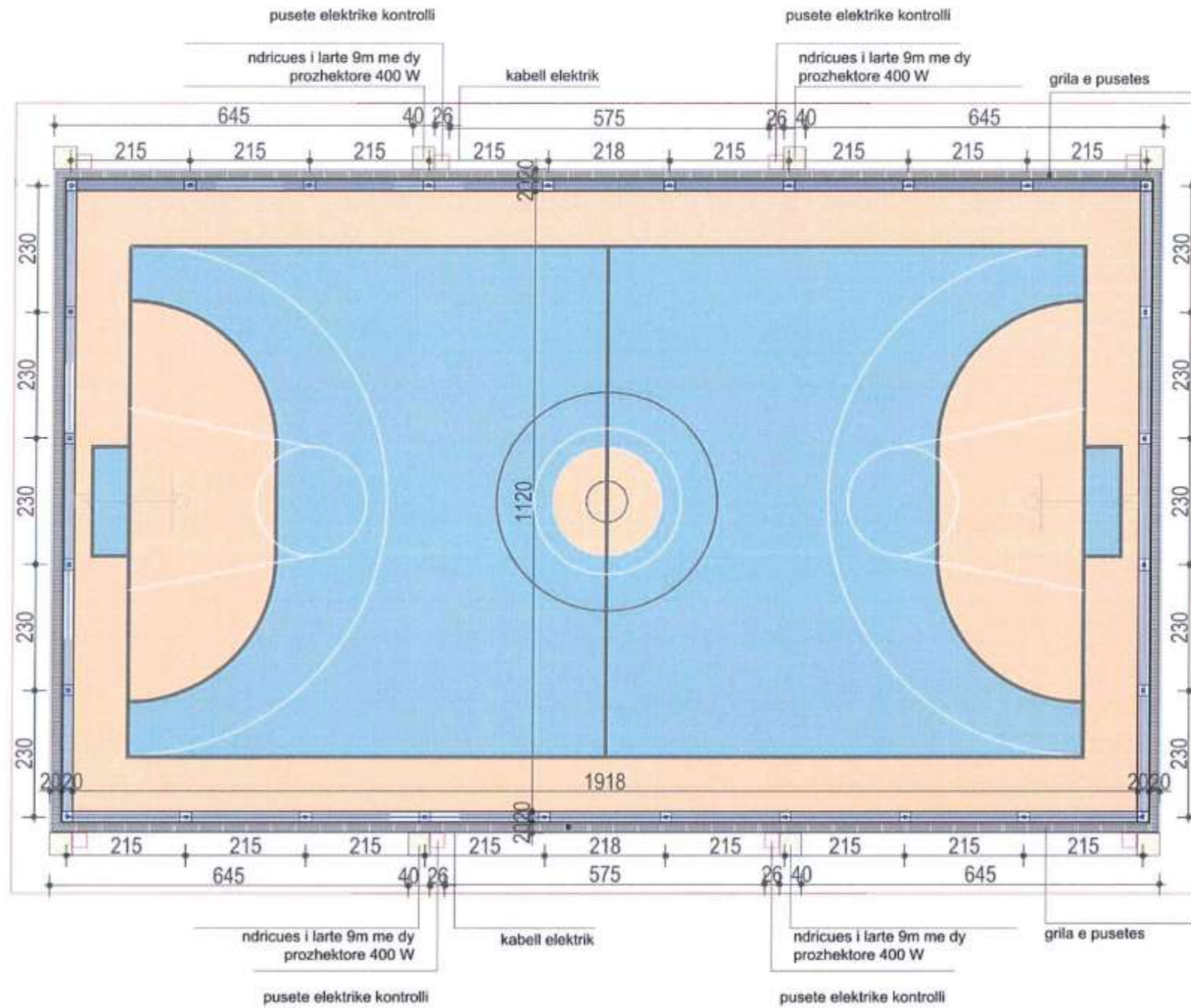

OBJEKTI :

PROJEKTI I ZBATIMIT  
"RIKUALIFIKIM URBAN I PALLATEVE NË HYRJE TË SELENICËS"

VENDODHJA: QYTETI SELENICË



BASHKIA SELENICË

GRUPI I PROJEKTIMIT

SIRE-ALB SH.P.K

NR. LICENSE: N. 7185/5

ING. MESUDE AHMETAJ LIC K.2715/1

ING. BESTAR ÇEKREZI LIC M.1464/1

ING. SULLTANE NEZHAI LIC E.0638/2

ING. RENALDO KARAJ

ARK. TATJANE LIÇAJ LIC A.0823

SHENIME:



DATA: GUSHT 2024

EMËRTESA E FLETËS:

PLANI I FUSHËS SË SPORTIT

SH.I:100

FL.A10



Architecture Engineering

e-mail: sirez-alb@outlook.com

Tel. 0698165747

Adresa: Rr. "Clergj Aranit",

Llogja "Pavarësia, Vlorë"

# BETONIMI I FUSHES SE SPORTIT ME FUGA DILATACIONI

D4

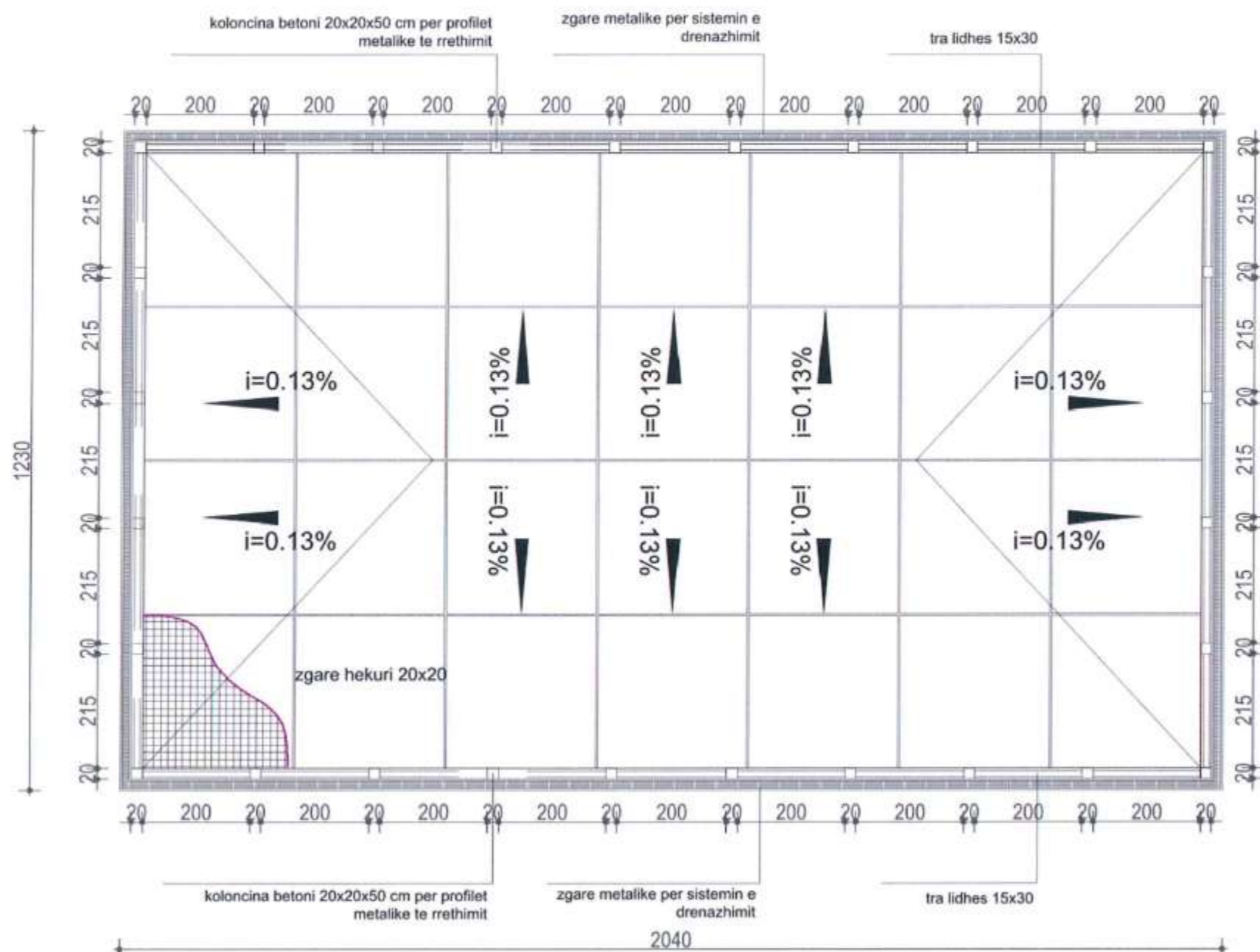

OBJEKTI :

PROJEKTI I ZBATIMIT  
"RIKUALIFIKIM URBAN I PALLATEVE NË HYRJE TË SELENICËS"

VENDODHJA: QYTETI SELENICË



BASHKIA SELENICË

GRUPI I PROJEKTIMIT

SIRE-ALB SH.P.K

NR.LICENSE: N.7185/5

ING. MESUDE AHMETAJ LIC K.2715/1

ING. BESTAR ÇEKREZI LIC M.1464/1

ING. SULLTANE NEZHAI LIC E.0638/2

ING. RENALDO KARAJ

ARK. TATJANE LIÇAJ LIC A.0823

SHENIME:



DATA: GUSHT 2024

EMËRTESA E FLETËS:

BETONIMI I FUSHES SE SPORTIT ME FUGA DILATACIONI

SH.I:100

FL.AII

SIRE ALB

Architecture Engineering

e-mail: sire-alb@outlook.com

Tel: 0698165747

Adresa: Rr. "Clergi Arjanit",  
Lagja "Pavarësia, Vlorë"

# DETAJE TË RRETHIMIT TË FUSHËS SPORTIVE DHE SHTRESAT

D5

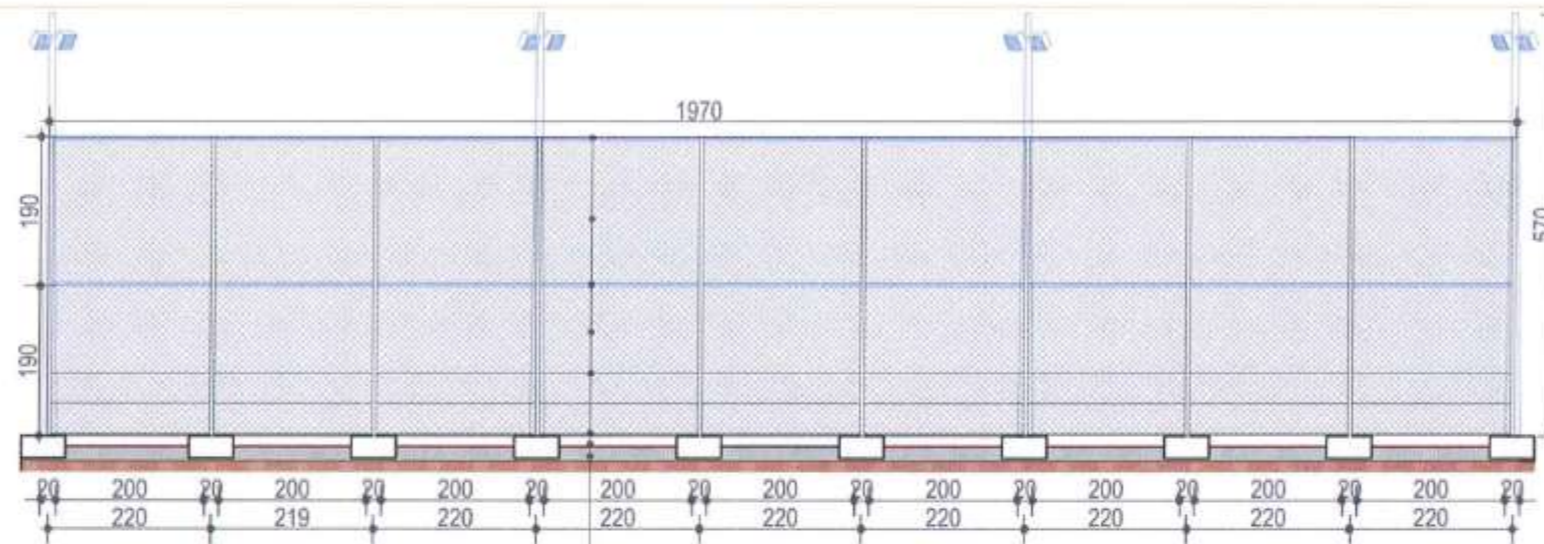

- profil lidhes metalik 60x40x4 mm
- rrjete metalike xingato e plastifikuar D = 3.5mm
- profil lidhes metalik 4x6 cm
- rrjete metalike xingato e plastifikuar D = 3.5mm
- kavo celiku
- profil lidhes metalik 4x6 cm
- tra lidhes betonarme 15x30
- cakell 20 cm
- toke natyrale

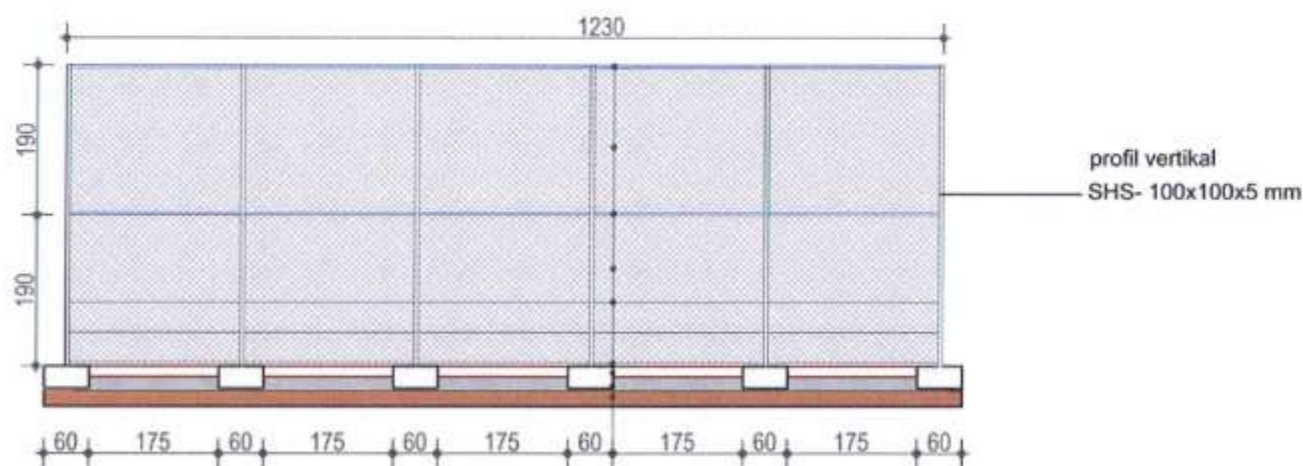

profil vertikal  
SHS- 100x100x5 mm

- profil lidhes metalik shs 60x40x4 mm
- rrjete metalike xingato e plastifikuar D = 3.5mm
- profil lidhes metalik 4x6 cm
- rrjete metalike xingato e plastifikuar D = 3.5mm
- kavo celiku
- profil lidhes metalik 4x6 cm
- tra lidhes betonarme 15x30
- cakell 20 cm
- toke natyrale

SHTRESAT FUNDORE

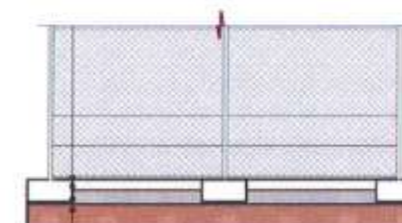

- boje e fushes sportive
- beton 15 cm
- cakull 15 cm
- toka natyrore

OBJEKTI :

PROJEKTI I ZBATIMIT  
"RIKUALIFIKIM URBAN I PALLATEVE NË HYRJE TË  
SELENICËS"

VENDODHJA: QYTETI SELENICË



BASHKIA SELENICË

GRUPI I PROJEKTIMIT

SIRE-ALB SH.P.K

NR.LICENSE: N.7185/5

ING. MESUDE AHMETAJ LIC K.2715/1

ING. BESTAR ÇEKREZI LIC M.1464/1

ING. SULLTANE NEZHAI LIC E.0638/2

ING. RENALDO KARAJ

ARK. TATJANE LIÇAJ LIC A.0823

SHENIME:



DATA: GUSHT 2024

EMËRTESA E FLETËS:

DETAJE TE RRETHIMIT TE FUSHES SPORTIVE DHE SHTRESAT

SH.I:100

FL.A12

SIRE-ALB  
Architecture Engineering

e-mail: sire-alb@outlook.com

Tel: 0698165747

Adresa: Rr. "Gjergj Arjanit",

Lagja "Pavarsia, Vlorë"

DETAJE TË ARMIMIT TË KOLLONCINAVE B/A 20x20 DHE TRAUT 15x30 CM

ARMIMI I KOLLONCINAVE 20x20 cm

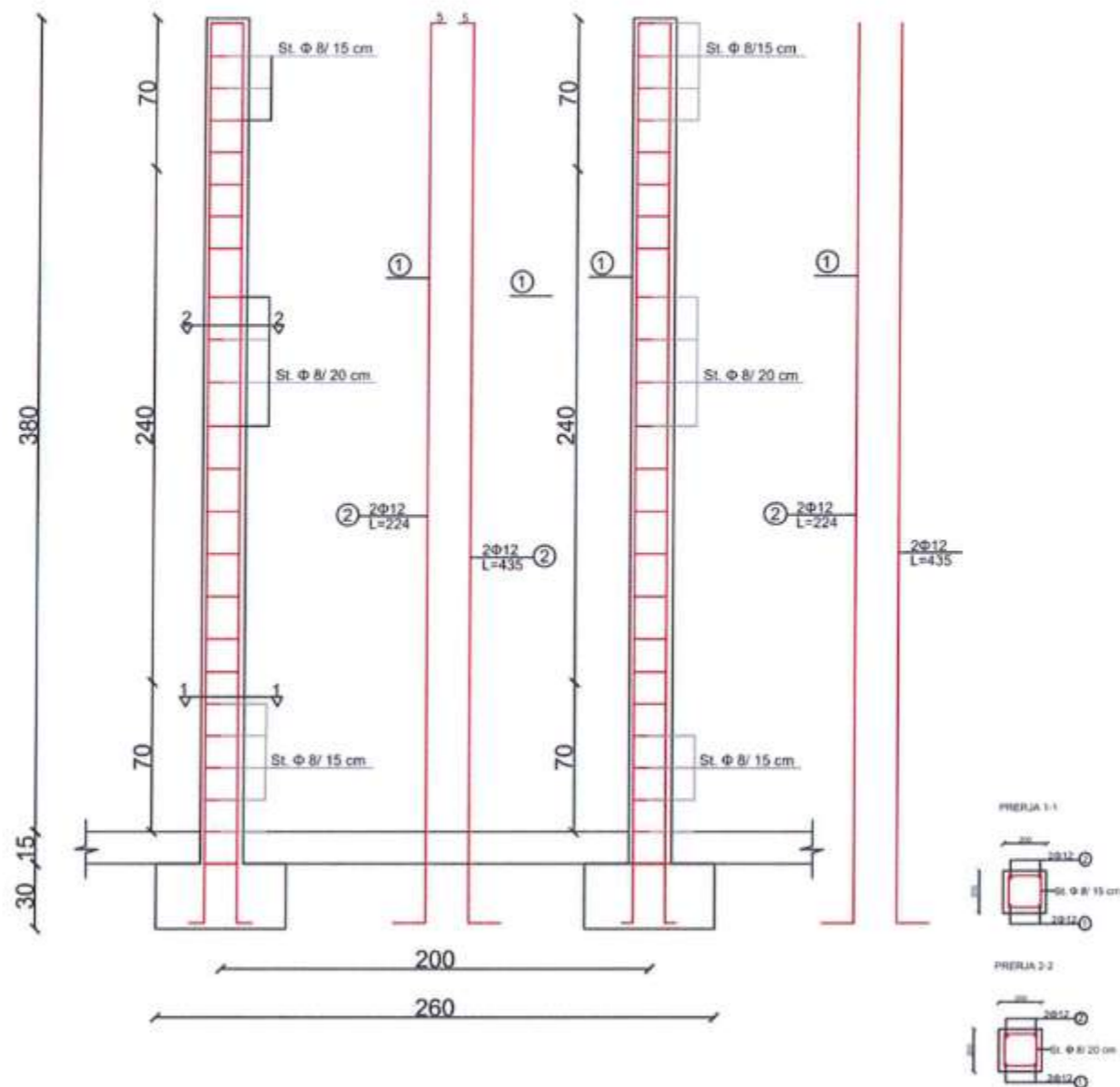

ARMIMI I TRAREVE 30x15 cm

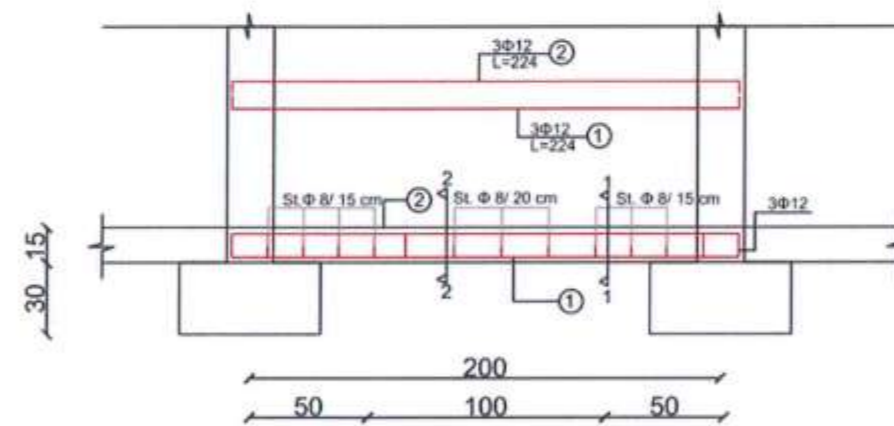

OBJEKTI :

PROJEKTI I ZBATIMIT  
"RIKUALIFIKIM URBAN I PALLATEVE NË HYRJE TË SELENICËS"

VENDODHJA: QYTETI SELENICË



BASHKIA SELENICË

GRUPI I PROJEKTIMIT

SIRE-ALB SH.P.K

NR. LICENSE: N. 7185/5

ING. MESUDE AHMETAJ LIC K.2715/1

ING. BESTAR ÇEKREZI LIC M.1464/1

ING. SULLTANE NEZHAI LIC E.0638/2

ING. RENALDO KARAJ

ARK. TATJANE LIÇAJ LIC A.0823

SHENIME:



DATA: GUSHT 2024

EMËRTESA E FLETËS:

DETAJE ARMIMI TE KOLLONCINAVE DHE TRAUT

SH.I:35

FL.A13

SIRE ALB

Architecture Engineering

e-mail: sire-alb@outlook.com

Tel: 0698165747

Adresa: Rr. "Gjergj Arvaniti",  
Lagjia "Pavarësia, Vlorë"

# DETAJE TË RRETHIMIT TË FUSHËS SPORTIVE

D6

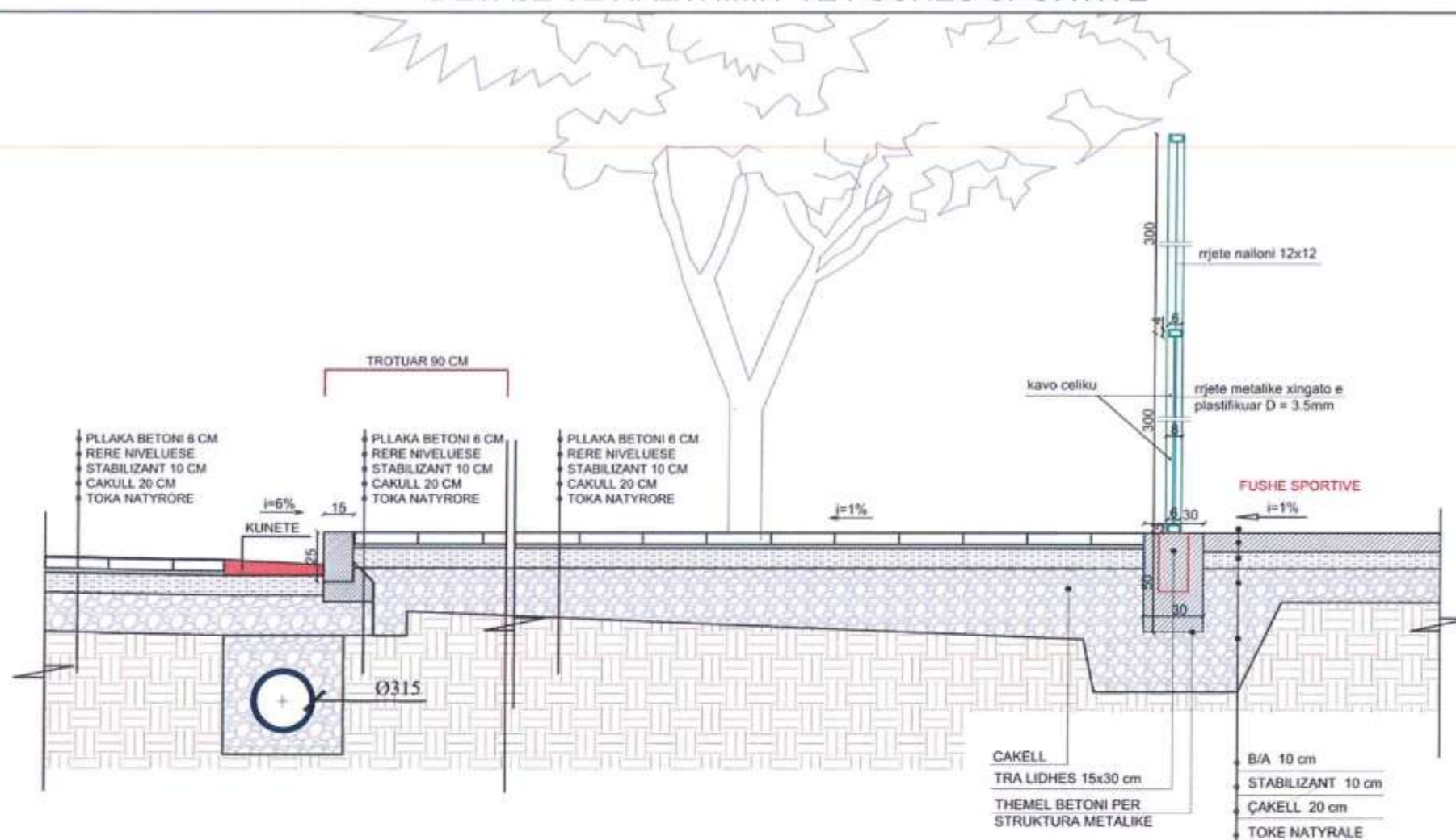

D7

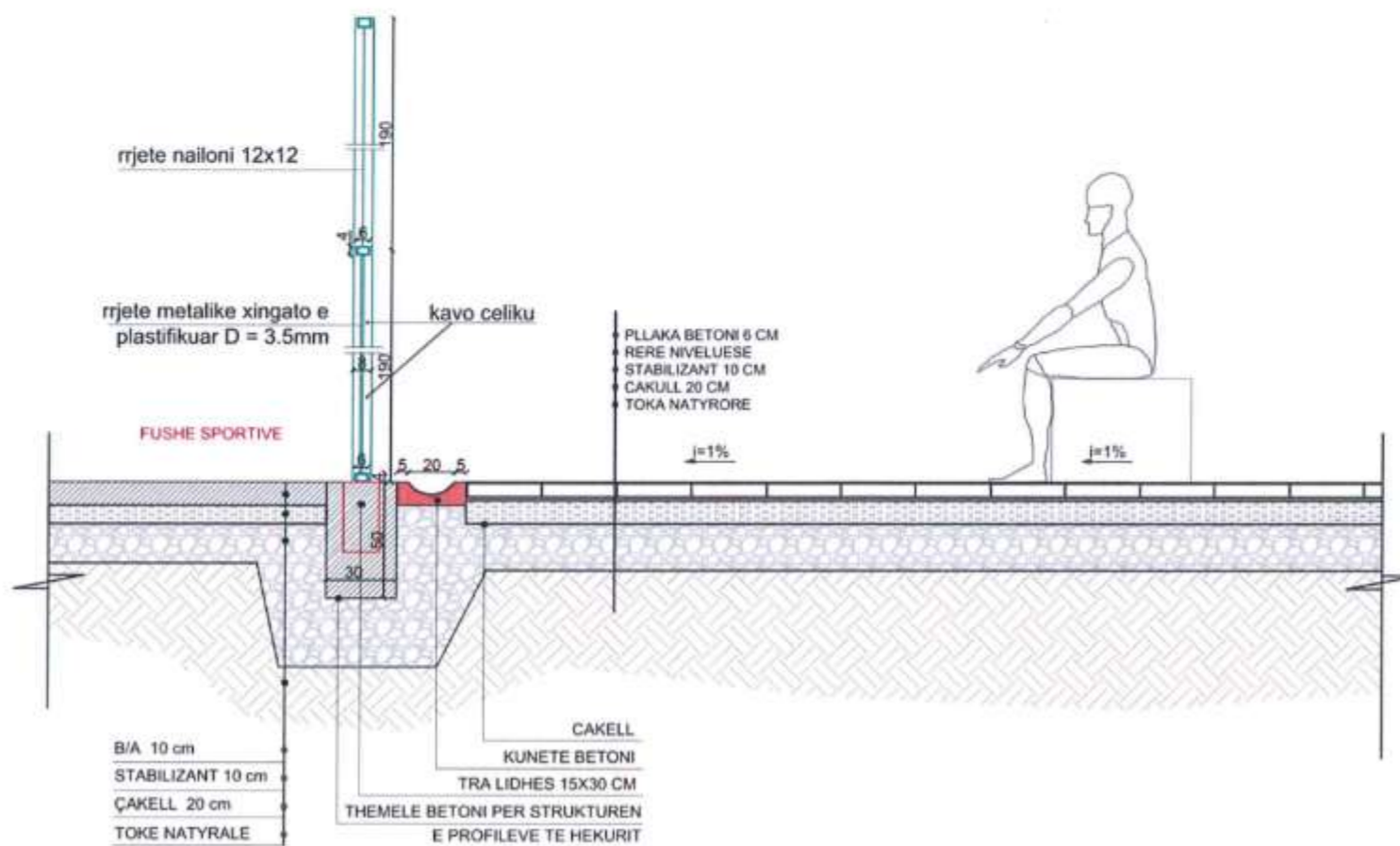

OBJEKTI :

PROJEKTI I ZBATIMIT  
"RIKUALIFIKIM URBAN I PALLATEVE NË HYRJE TË SELENICËS"

VENDODHJA: QYTETI SELENICË



BASHKIA SELENICË

GRUPI I PROJEKTIMIT

SIRE-ALB SH.P.K

NR.LICENSE: N.7185/5

ING. MESUDE AHMETAJ LIC K.2715/1

ING. BESTAR ÇEKREZI LIC M.1464/1

ING. SULLTANE NEZHAI LIC E.0638/2

ING. RENALDO KARAJ

ARK. TATJANE LIÇAJ LIC A.0823

SHENIME:



DATA: GUSHT 2024 M38415202E

EMËRTESA E FLETËS:

DETAJE TE RRETHIMIT TE FUSHES SPORTIVE

SH.I:30

FL.A14



Architecture Engineering

e-mail: sire-alb@outlook.com

Tel: 0698165747

Adresa: Rr. "Gjergj Arjanit",  
Lagja "Pavarsia, Vlorë"

# DETAJE TË RRETHIMIT TË SHKOLLËS

D8

DETAJ 3

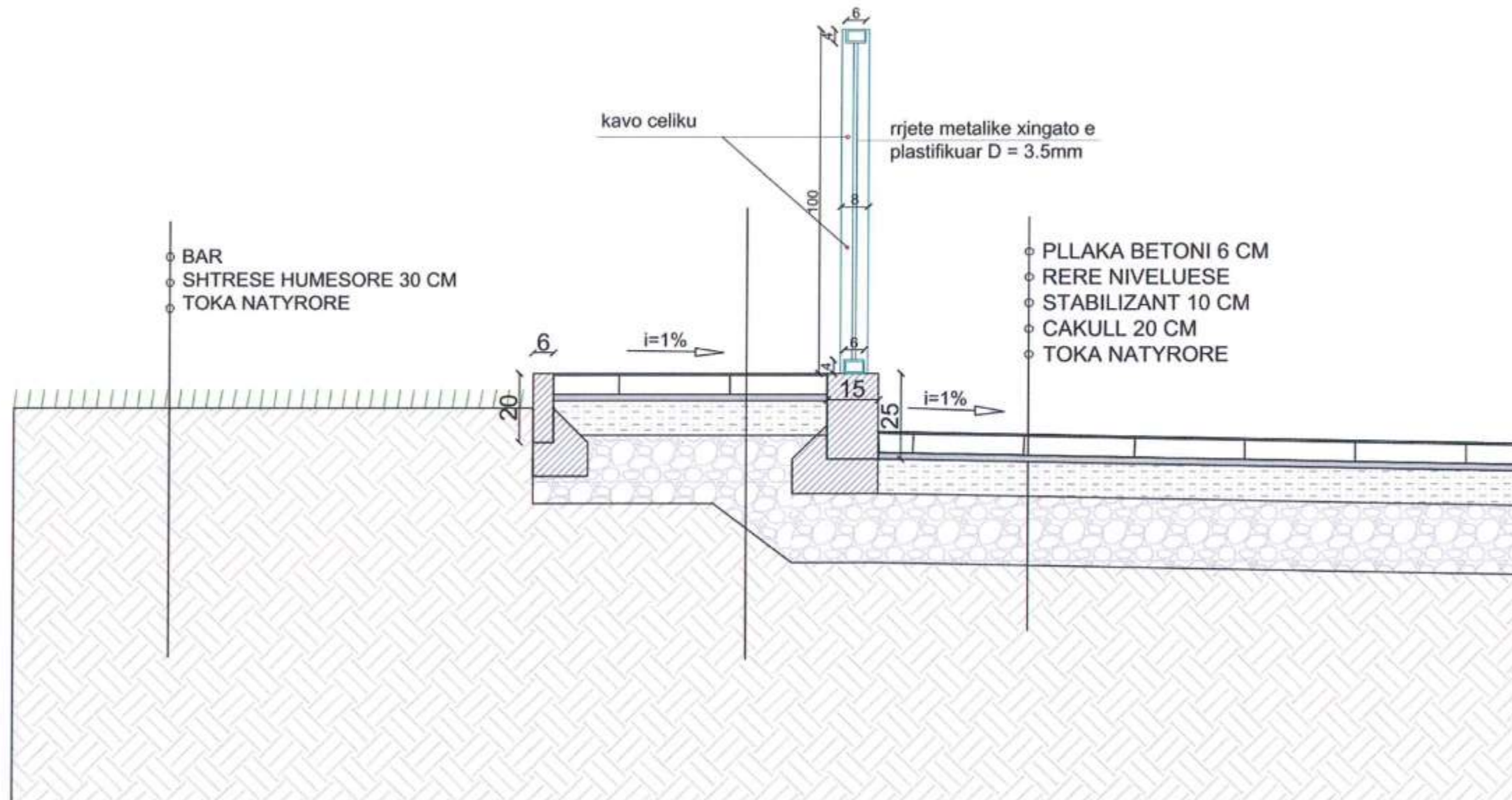

OBJEKTI :

PROJEKTI I ZBATIMIT  
"RIKUALIFIKIM URBAN I PALLATEVE NË HYRJE TË SELENICËS"

VENDODHJA: QYTETI SELENICË



BASHKIA SELENICË

GRUPI I PROJEKTIMIT

SIRE-ALB SH.P.K

NR.LICENSE: N. 7185/5

ING. MESUDE AHMETAJ LIC K.2715/1

ING. BESTAR ÇEKREZI LIC M.1464/1

ING. SULLTANE NEZHAI LIC E.0638/2

ING. RENALDO KARAJ

ARK. TATJANE LIÇAJ LIC A.0823

SHENIME:



DATA: GUSHT 2024

EMËRTESA E FLETËS:

DETAJE TË RRETHIMIT TË SHKOLLËS

SH.I:40

FL.A15



Architecture Engineering

e-mail: sire-alb@outlook.com

Tel: 0698165747

Adresa: Rr. "Gjergj Arjanit",  
Lagjia "Pavarsia, Vlorë"



# DETAJE TË MBJELLJES SË PEMËVE

D9

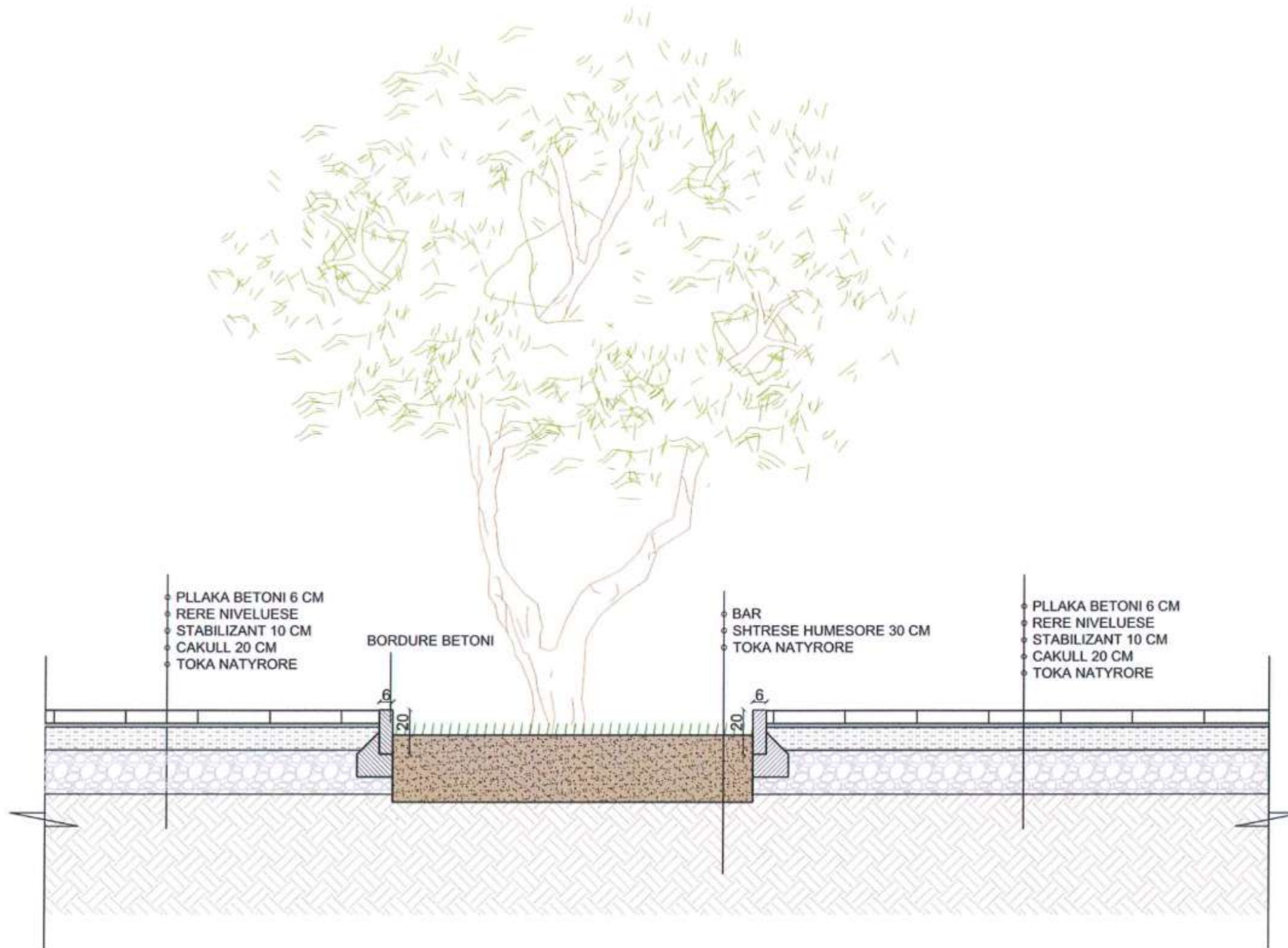

OBJEKTI :

PROJEKTI I ZBATIMIT  
"RIKUALIFIKIM URBAN I PALLATEVE NË HYRJE TË SELENICËS"

VENDODHJA: QYTETI SELENICË



BASHKIA SELENICË

GRUPI I PROJEKTIMIT

SIRE-ALB SH.P.K

NR. LICENSE: N. 7185/5

ING. MESUDE AHMETAJ LIC K.2715/1

ING. BESTAR ÇEKREZI LIC M.1464/1

ING. SULLTANE NEZHAI LIC E.0638/2

ING. RENALDO KARAJ

ARK. TATJANE LIÇAJ LIC A.0823

SHENIME:



DATA: GUSHT 2024

EMËRTESA E FLETËS:

DETAJE TE MBJELLJES SE PEMEVE

SH.1:40

FL.A16

**SIRE** ALB  
Architecture Engineering

e-mail: sire-alb@outlook.com  
Tel: 0698165747  
Adresa: Rr. "Gjergj Arjanit",  
Lagja "Pavarësia, Vlorë"

# DETAJE TË KOSHIT TË BASKETBOLLIT

D10

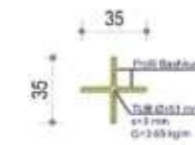
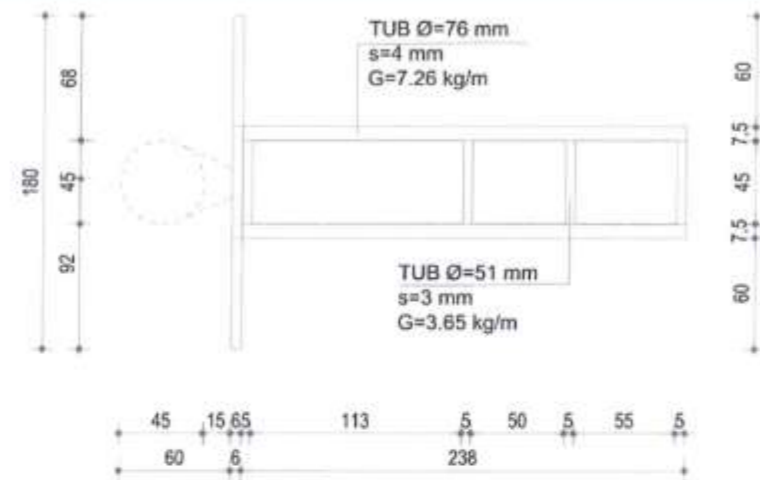

DETALJI B

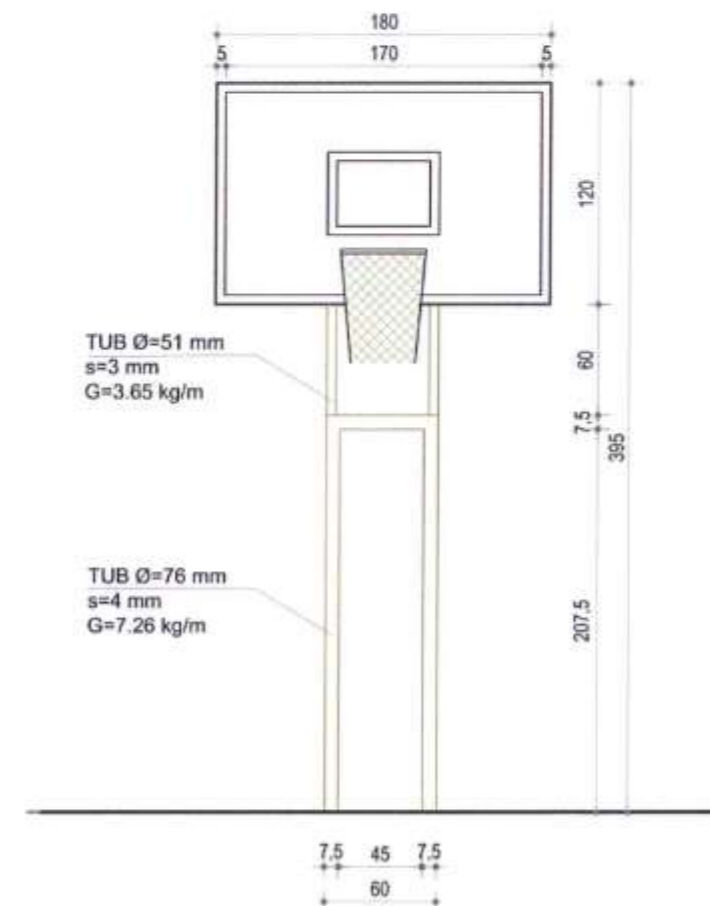
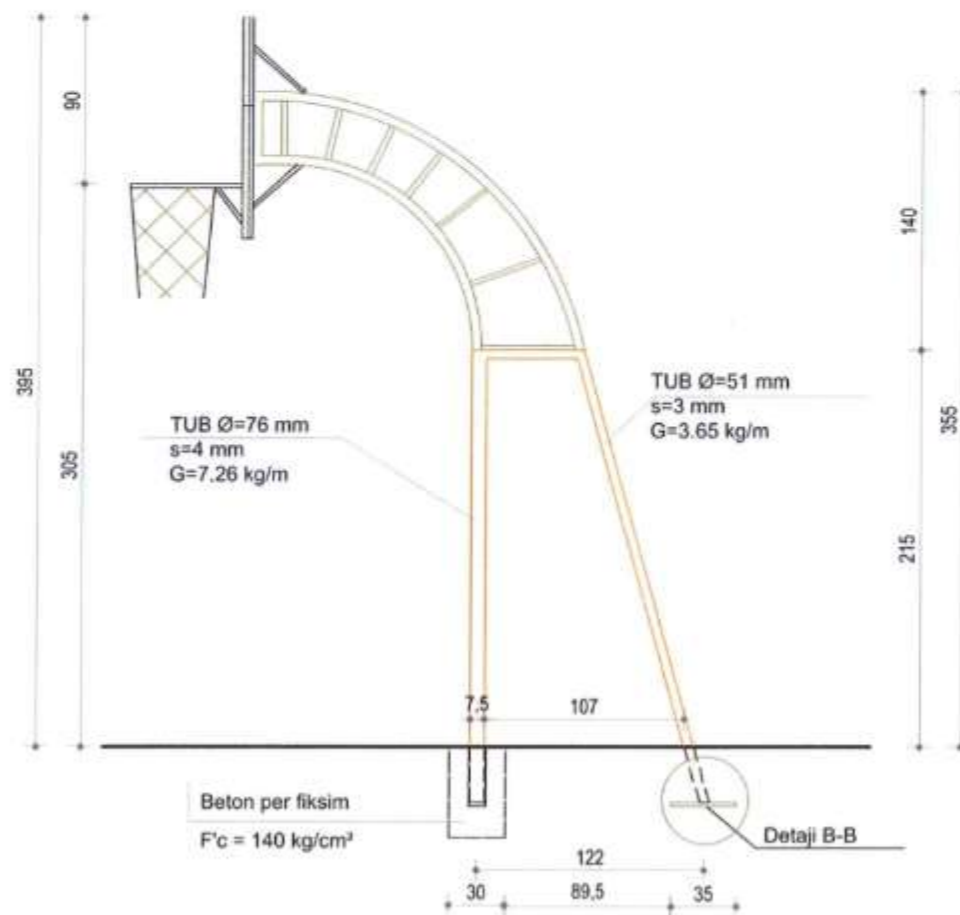

OBJEKTI :

PROJEKTI I ZBATIMIT  
"RIKUALIFIKIM URBAN I PALLATEVE NË HYRJE TË  
SELENICË"

VENDODHJA: QYTETI SELENICË



BASHKIA SELENICË

GRUPI I PROJEKTIMIT

SIRE-ALB SH.P.K

NR.LICENSE: N.7185/5

ING. MESUDE AHMETAJ LIC K.2715/1

ING. BESTAR ÇEKREZI LIC M.1464/1

ING. SULLTANE NEZHAI LIC E.0638/2

ING. RENALDO KARAJ

ARK. TATJANE LIÇAJ LIC A.0823

SHENIME:



DATA: GUSHT 2024

EMËRTESA E FLETËS:

DETAJE TE KOSHIT TE BASKETBOLLIT

SH.I:40

FL.A17

SIRE ALB  
Architecture Engineering

e-mail: sire-alb@outlook.com

Tel: 0698165747

Adresa: Rr. "Cergj Arjanit",

Logjia "Povarsia, Vlorë"

DETAJE TË KOSHAVE DHE STOLAVE TE PARKUT

D11

DETAJ I KOSHAVE TE PARKUT

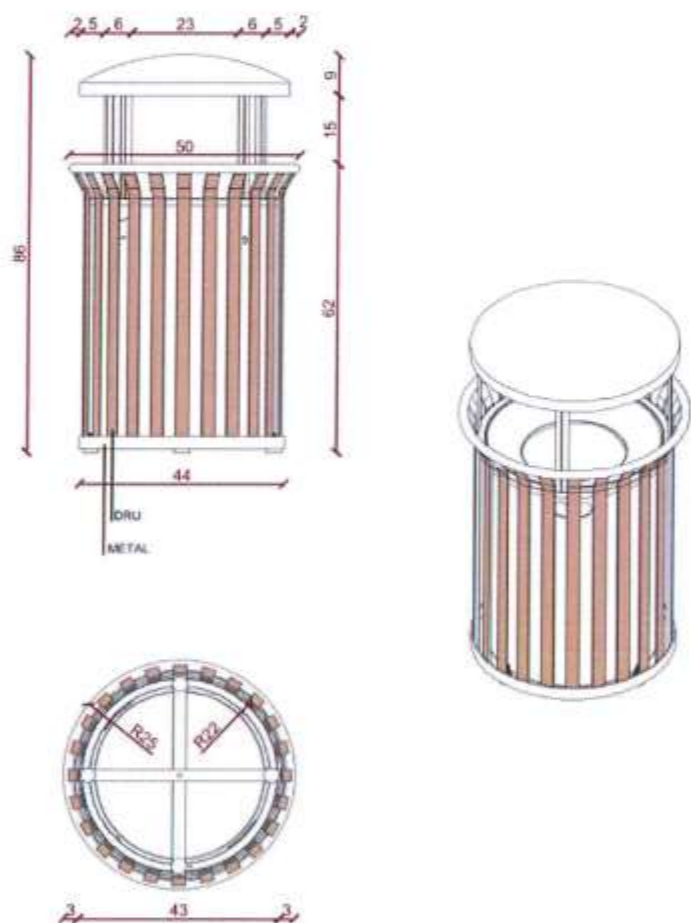

D12

DETAJ I STOLAVE PREJ BETONI

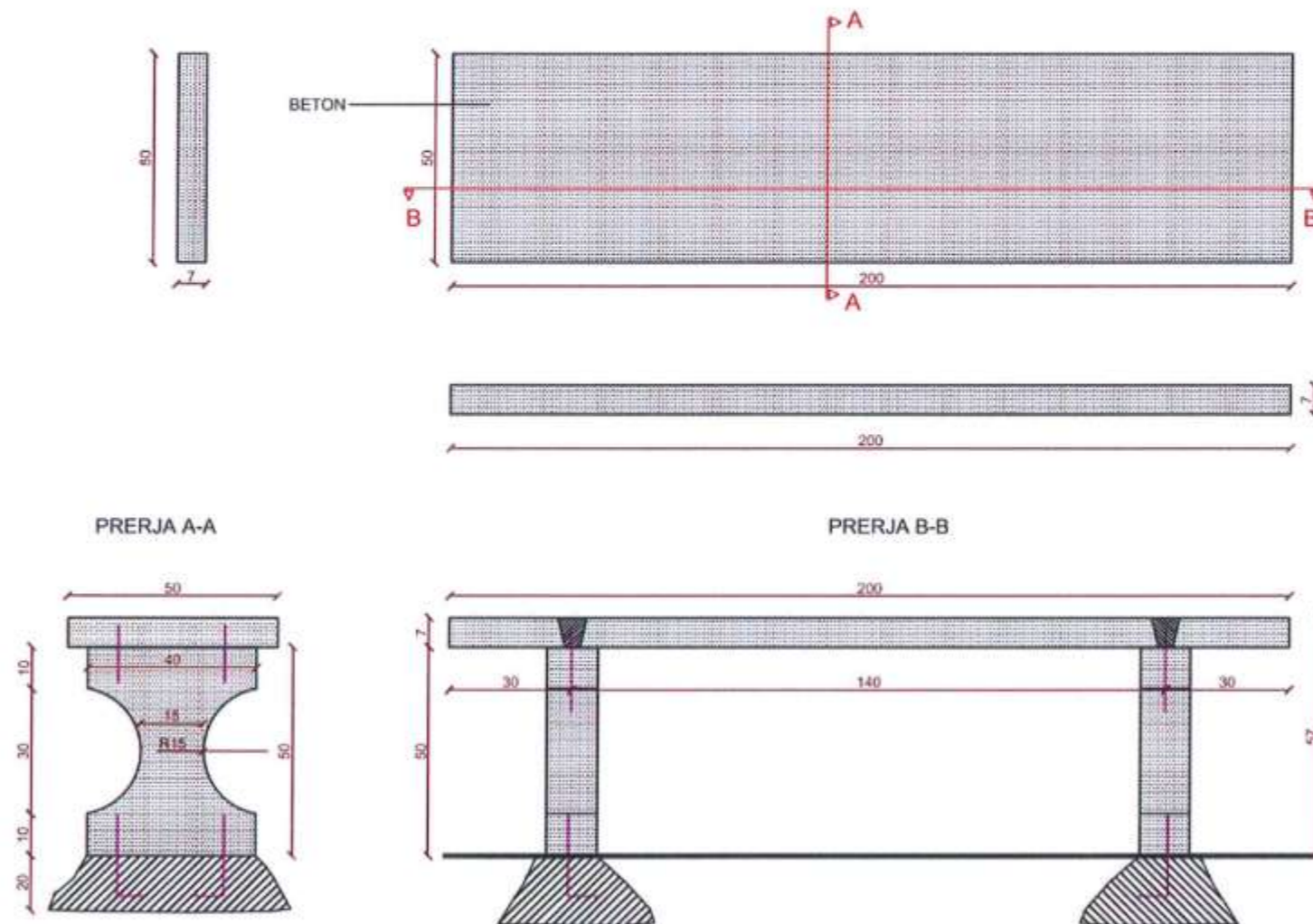

OBJEKTI :

PROJEKTI I ZBATIMIT  
"RIKUALIFIKIM URBAN I PALLATEVE NË HYRJE TË SELENICËS"

VENDODHJA: QYTETI SELENICË



BASHKIA SELENICË

GRUPI I PROJEKTIMIT

SIRE-ALB SH.P.K

NR.LICENSE: N. 7185/5

ING. MESUDE AHMETAJ LIC K.2715/1

ING. BESTAR ÇEKREZI LIC M.1464/1

ING. SULLTANE NEZHAI LIC E.0638/2

ING. RENALDO KARAJ

ARK. TATJANE LIÇAJ LIC A.0823

SHENIME:



DATA: GUSHT 2024

EMËRTESA E FLETËS:

DETAJE TE SISTEMIMIT

SH.I:15

FL.A18



Architecture Engineering

e-mail: sire-alb@outlook.com

Tel: 0698165747

Adresa: Rr. "Clergj Arjanit",  
Lagja "Pavarësia, Vlorë"

DETAJE TE KENDIT TE LOJERAVE

D13

DETAJ I LOJERAVE TE PARKUT

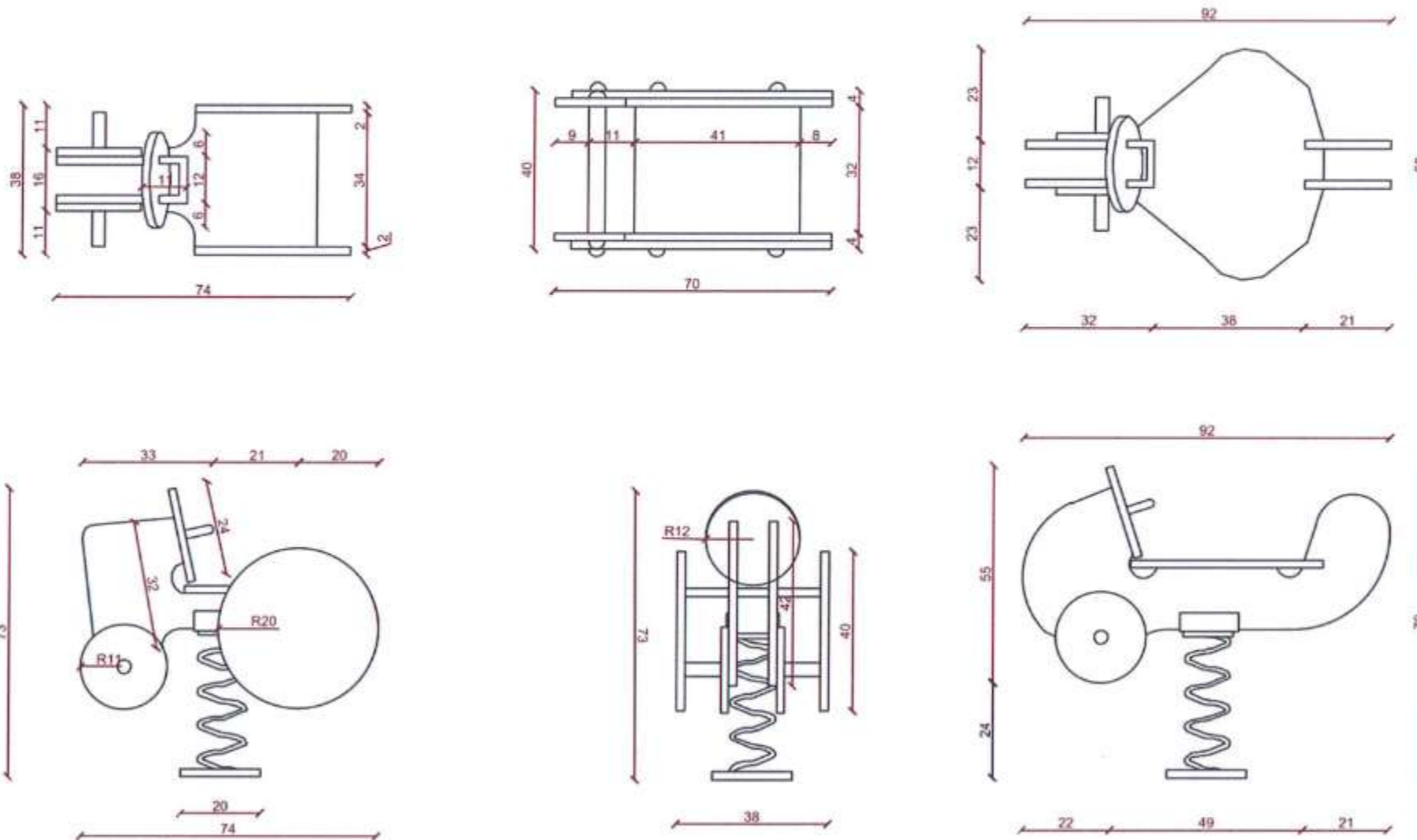

OBJEKTI :

PROJEKTI I ZBATIMIT  
"RIKUALIFIKIM URBAN I PALLATEVE NË HYRJE TË  
SELENICËS"

VENDODHJA: QYTETI SELENICË



BASHKIA SELENICË

GRUPI I PROJEKTIMIT

SIRE-ALB SH.P.K

NR.LICENSE: N.7185/5

ING. MESUDE AHMETAJ LIC K.2715/1

ING. BESTAR ÇEKREZI LIC M.1464/1

ING. SULLTANE NEZHAI LIC E.0638/2

ING. RENALDO KARAJ

ARK. TATJANE LIÇAJ LIC A.0823

SHENIME:



DATA: GUSHT 2024

EMËRTESA E FLETËS:

DETAJE TE KENDIT TE LOJERAVE

SH.I:15

FL.A19

SIRE ALB

Architecture Engineering

e-mail: sire-alb@outlook.com

Tel: 0698165747

Adresa: Rr. "Gjergj Arjanit",

Lagja "Povarsia, Vlorë"

DETAJE TE KENDIT TE LOJERAVE

D14

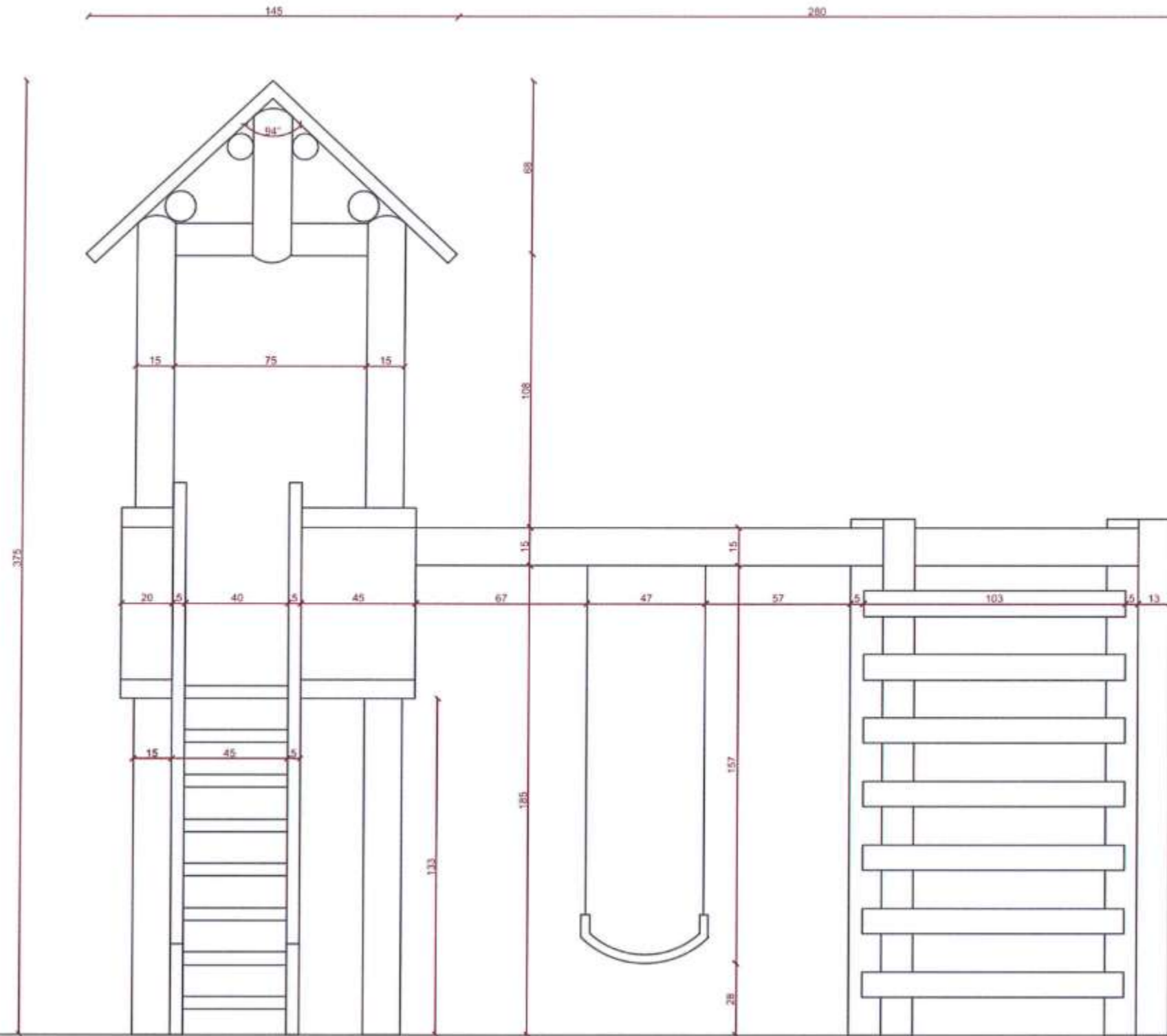

OBJEKTI :

PROJEKTI I ZBATIMIT  
"RIKUALIFIKIM URBAN I PALLATEVE NË HYRJE TË  
SELENICËS"

VENDODHJA: QYTETI SELENICË



BASHKIA SELENICË

GRUPI I PROJEKTIMIT

SIRE-ALB SH.P.K

NR. LICENSE: N.7185/5

ING. MESUDE AHMETAJ LIC K.2715/1

ING. BESTAR ÇEKREZI LIC M.1464/1

ING. SULLTANE NEZHAI LIC E.0638/2

ING. RENALDO KARAJ

ARK. TATJANE LIÇAJ LIC A.0823

SHENIME:



DATA: GUSHT 2024

EMËRTESA E FLETËS:

DETAJE TE KENDIT TE LOJERAVE

SH.1:20

FL.A 20

**SIRE** ALB

Architecture Engineering

e-mail: sire-alb@outlook.com

Tel: 0698165747

Adresa: Rr. "Gjergj Arjanti",

Lagja "Povarsia, Vlorë"

DETAJE TE KENDIT TE LOJERAVE

D15

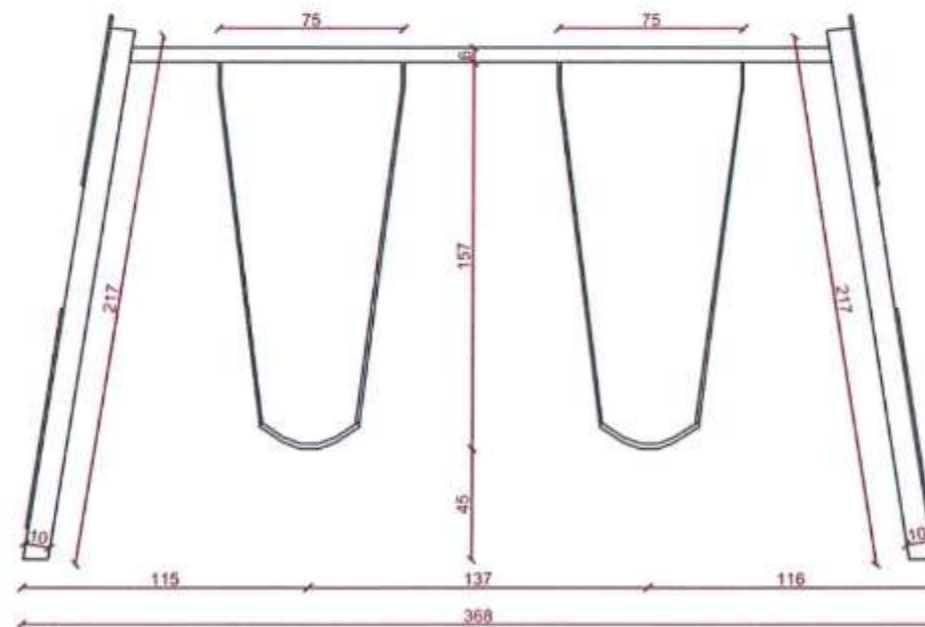
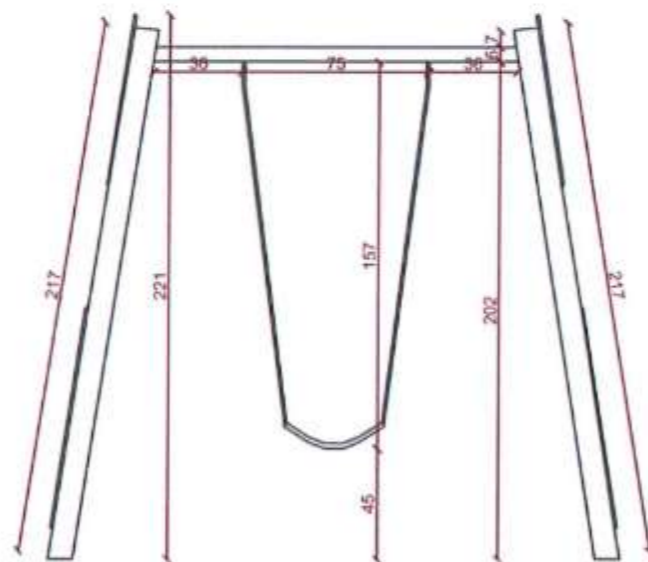
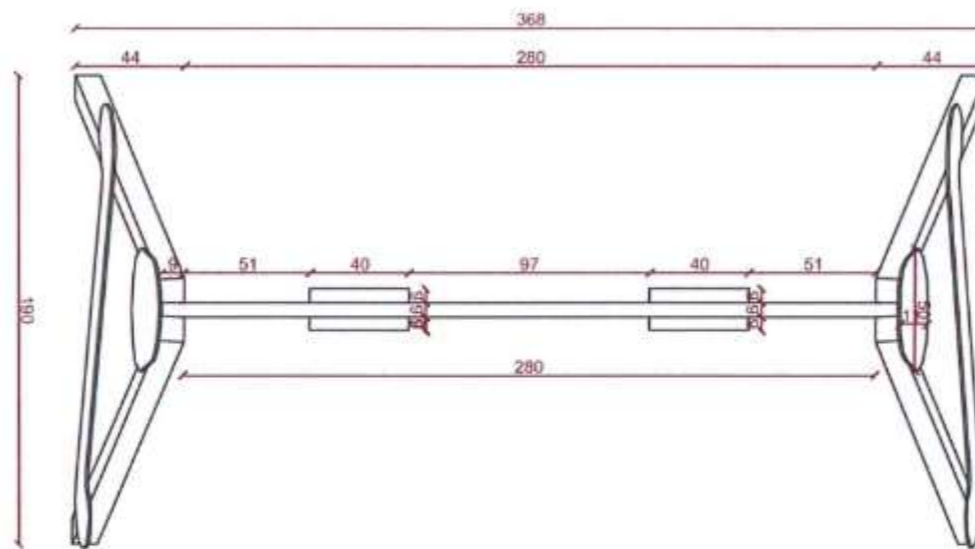
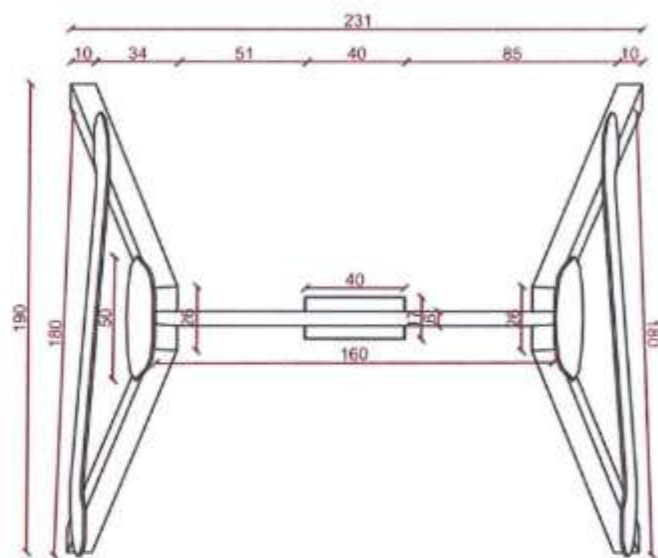

OBJEKTI :

PROJEKTI I ZBATIMIT  
"RIKUALIFIKIM URBAN I PALLATEVE NË HYRJE TË SELENICËS"

VENDODHJA: QYTETI SELENICË



BASHKIA SELENICË

GRUPI I PROJEKTIMIT

SIRE-ALB SH.P.K

NR. LICENSE: N. 7185/5

ING. MESUDE AHMETAJ LIC K.2715/1

ING. BESTAR ÇEKREZI LIC M.1464/1

ING. SULLTANE NEZHAI LIC E.0638/2

ING. RENALDO KARAJ

ARK. TATJANE LIÇAJ LIC A.0823

SHENIME:



DATA: GUSHT 2024

EMËRTESA E FLETËS:

DETAJE TE KENDIT TE LOJERAVE

SH.1:30

FL.A 21

SIRE ALB  
Architecture Engineering

e-mail: sire-alb@outlook.com  
Tel: 0698 165747  
Adresa: Rr. "Clergj Arjanit",  
Lagja "Pavarësia, Vlorë"

D16

NDRICUESIT RRUGORË

SHTYLLË ELEKTRIKE ME PUSETË NË TOKË ME LIDHJE EKUIPOTENCIALE DHE MORSETERIA E LINJËS SË NDRIÇIMIT

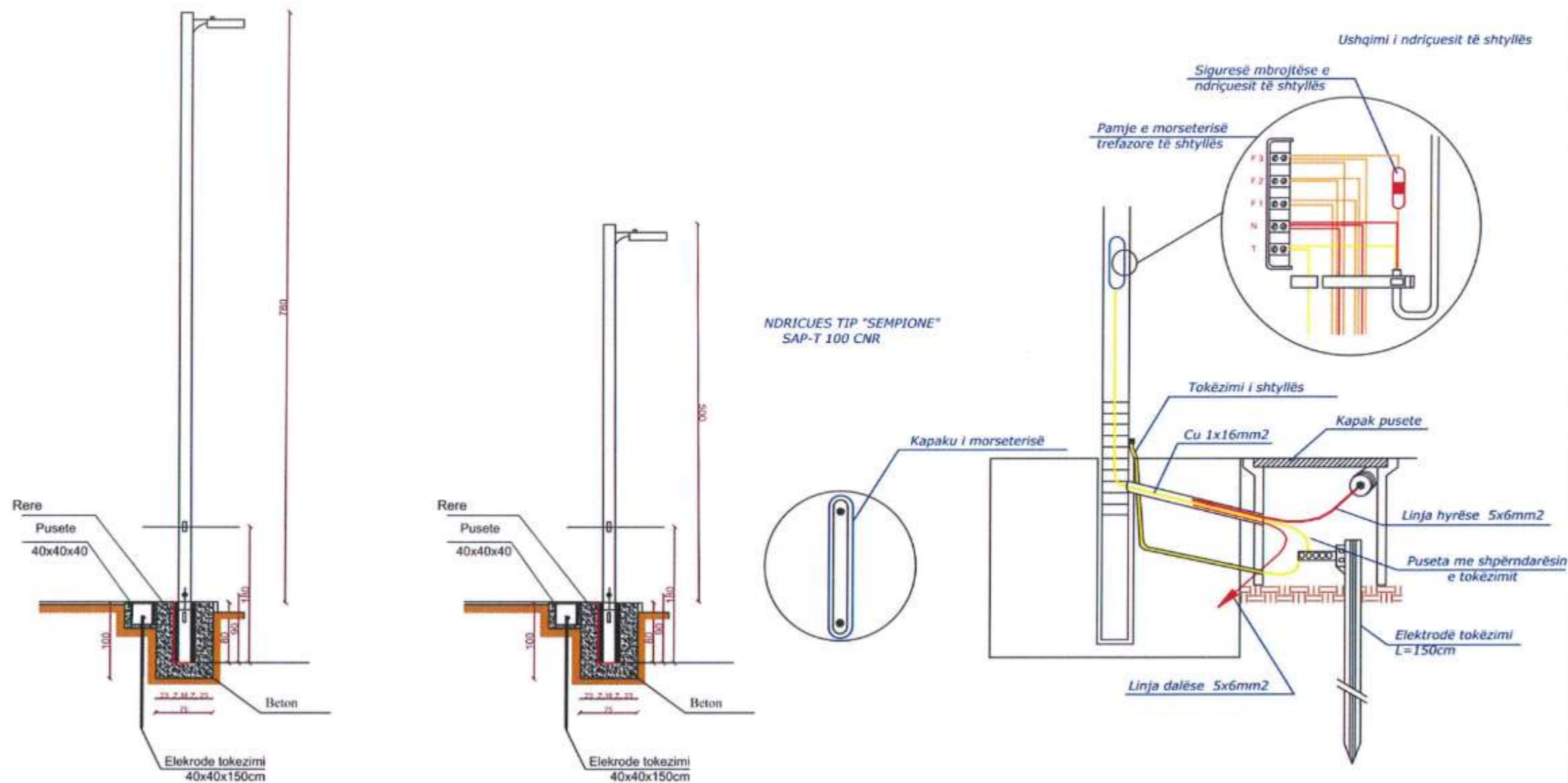

OBJEKTI :  
PROJEKTI I ZBATIMIT  
"RIKUALIFIKIM URBAN I PALLATEVE NË HYRJE TË SELENICËS"

VENDODHJA: QYTETI SELENICË



BASHKIA SELENICË

GRUPI I PROJEKTIMIT	
SIRE-ALB SH.P.K	
NR.LICENSE: N.7185/5	
ING. MESUDE AHMETAJ	LIC K.2715/1
ING. BESTAR ÇEKREZI	LIC M.1464/1
ING. SULLTANE NEZHAI	LIC E.0638/2
ING. RENALDO KARAJ	
ARK. TATJANE LIÇAJ	LIC A.0823



DATA: GUSHT 2024  
EMËRTESA E FLETËS:  
DETAJE PER NDRICUESIT H-7.8 DHE 5 M

SH.I:20	FL.A 22
---------	---------

SIRE-ALB  
Architecture Engineering  
e-mail: sire-alb@outlook.com  
Tel: 0698165747  
Adresa: Rr. "Gjergj Arjanit",  
Lagjia "Pavarësia, Vlorë"

DETAJE NDRICIMI- PROZHEKTORET E FUSHES SPORTIVE

D17

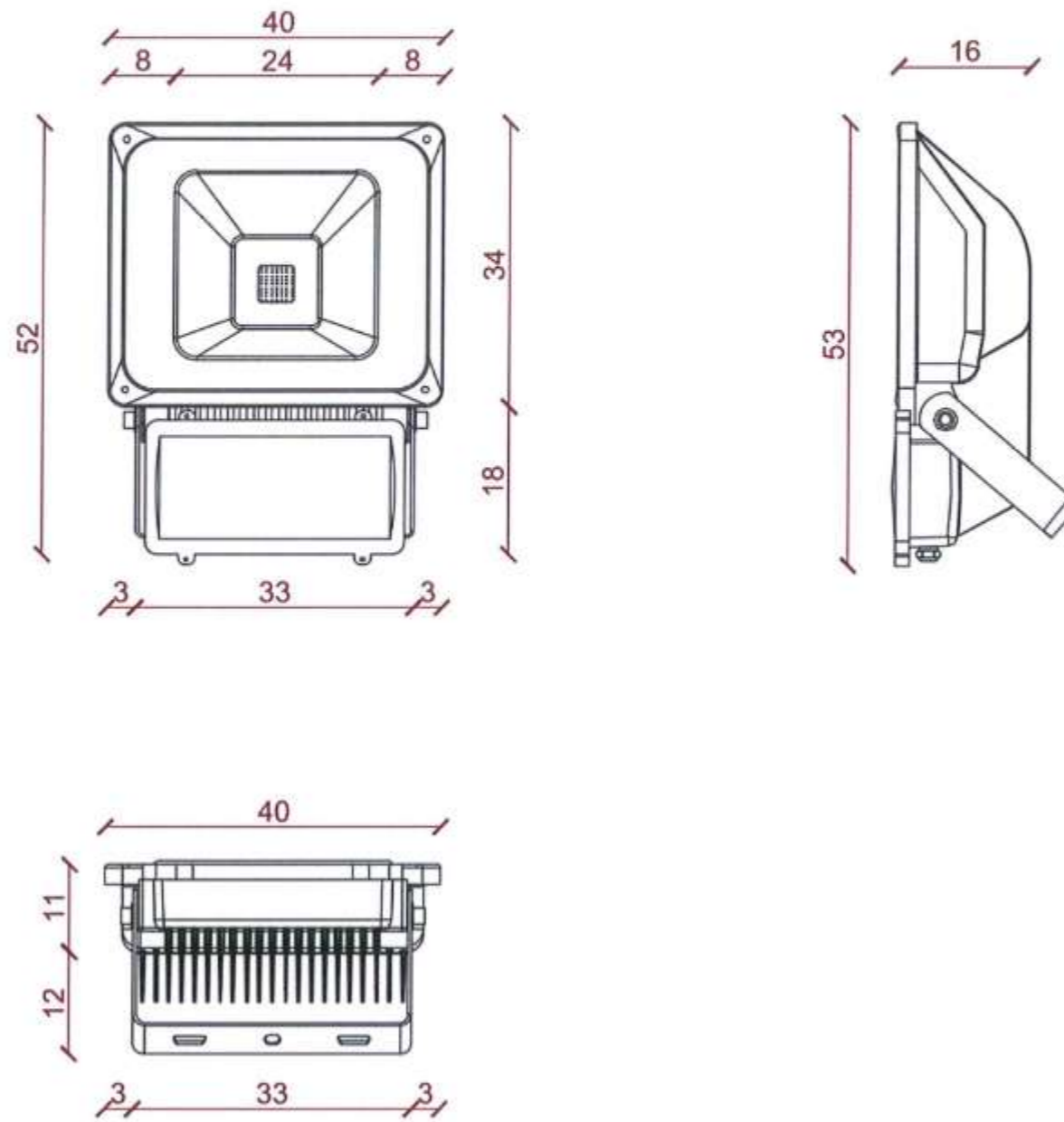

OBJEKTI :

PROJEKTI I ZBATIMIT  
"RIKUALIFIKIM URBAN I PALLATEVE NË HYRJE TË SELENICËS"

VENDODHJA: QYTETI SELENICË



BASHKIA SELENICË

GRUPI I PROJEKTIMIT

SIRE-ALB SH.P.K

NR. LICENSE: N.7185/5

ING. MESUDE AHMETAJ LIC K.2715/1

ING. BESTAR ÇEKREZI LIC M.1464/1

ING. SULLTANE NEZHAI LIC E.0638/2

ING. RENALDO KARAJ

ARK. TATJANE LIÇAJ LIC A.0823

SHENIME:



DATA: GUSHT 2024

EMËRTESA E FLETËS:

DETAJE NDRICIMI- PROZHEKTORET E FUSHES SPORTIVE

SH.I:8

FL.A 23

SIRE ALB  
Architecture Engineering

e-mail: sire-alb@outlook.com  
Tel: 0698165747  
Adresa: Rr. "Gjergj Arjanit",  
Lagjia "Pavarësia, Vlorë"



DETAJ I PORTËS SË FUSHËS SË MINIFUTBOLLIT

D18

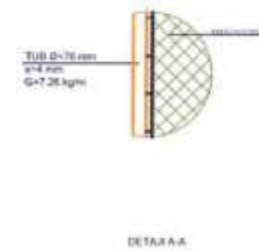
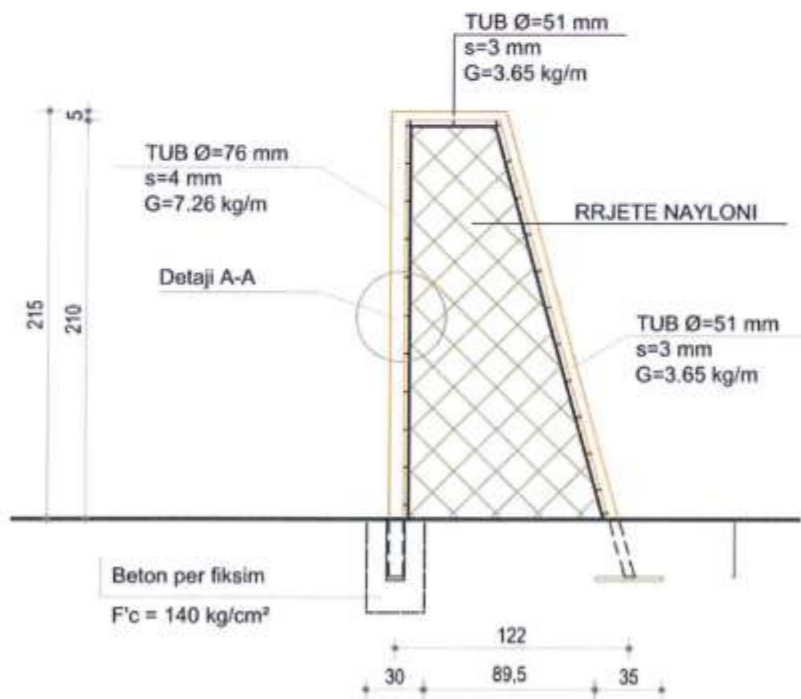
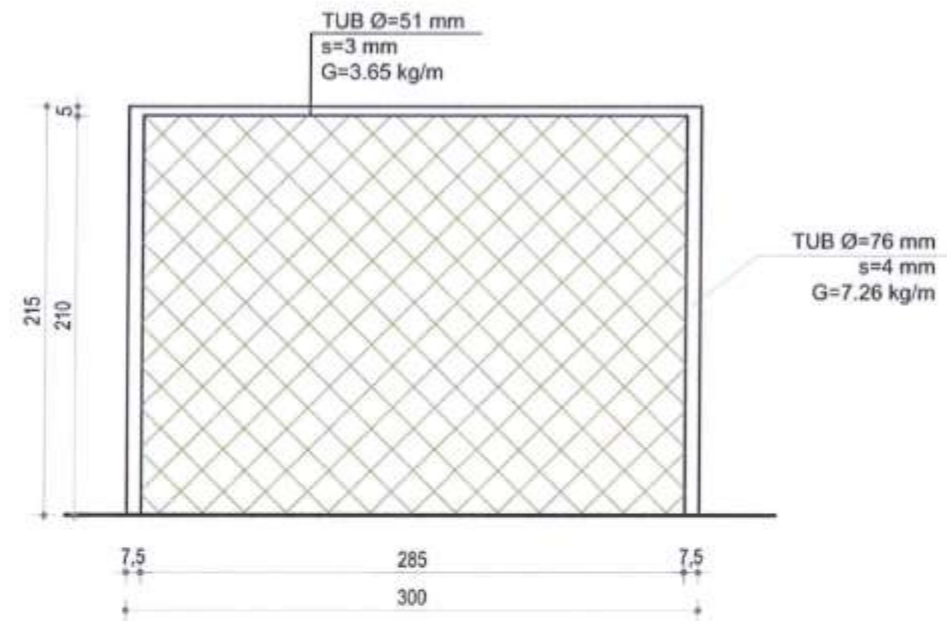

OBJEKTI :

PROJEKTI I ZBATIMIT  
"RIKUALIFIKIM URBAN I PALLATEVE NË HYRJE TË SELENICËS"

VENDODHJA: QYTETI SELENICË



BASHKIA SELENICË

GRUPI I PROJEKTIMIT

SIRE-ALB SH.P.K

NR.LICENSE: N.7185/5

ING. MESUDE AHMETAJ LIC K.2715/1

ING. BESTAR ÇEKREZI LIC M.1464/1

ING. SULLTANE NEZHAI LIC E.0638/2

ING. RENALDO KARAJ

ARK. TATJANE LIÇAJ LIC A.0823

SHENIME:



DATA: GUSHT 2024

EMËRTESA E FLETËS:

DETAJ I PORTES SE FUSHES SE MINIFUTBOLLIT

SH.I:8

FL.A 24

SIRE ALB  
Architecture Engineering

e-mail: sire-alb@outlook.com  
Tel: 0698165747  
Adresa: Rr. "Gjergj Arjanit",  
Lagja "Pavarsia, Vlorë"

# FASADA JUGORE - PALLATI I

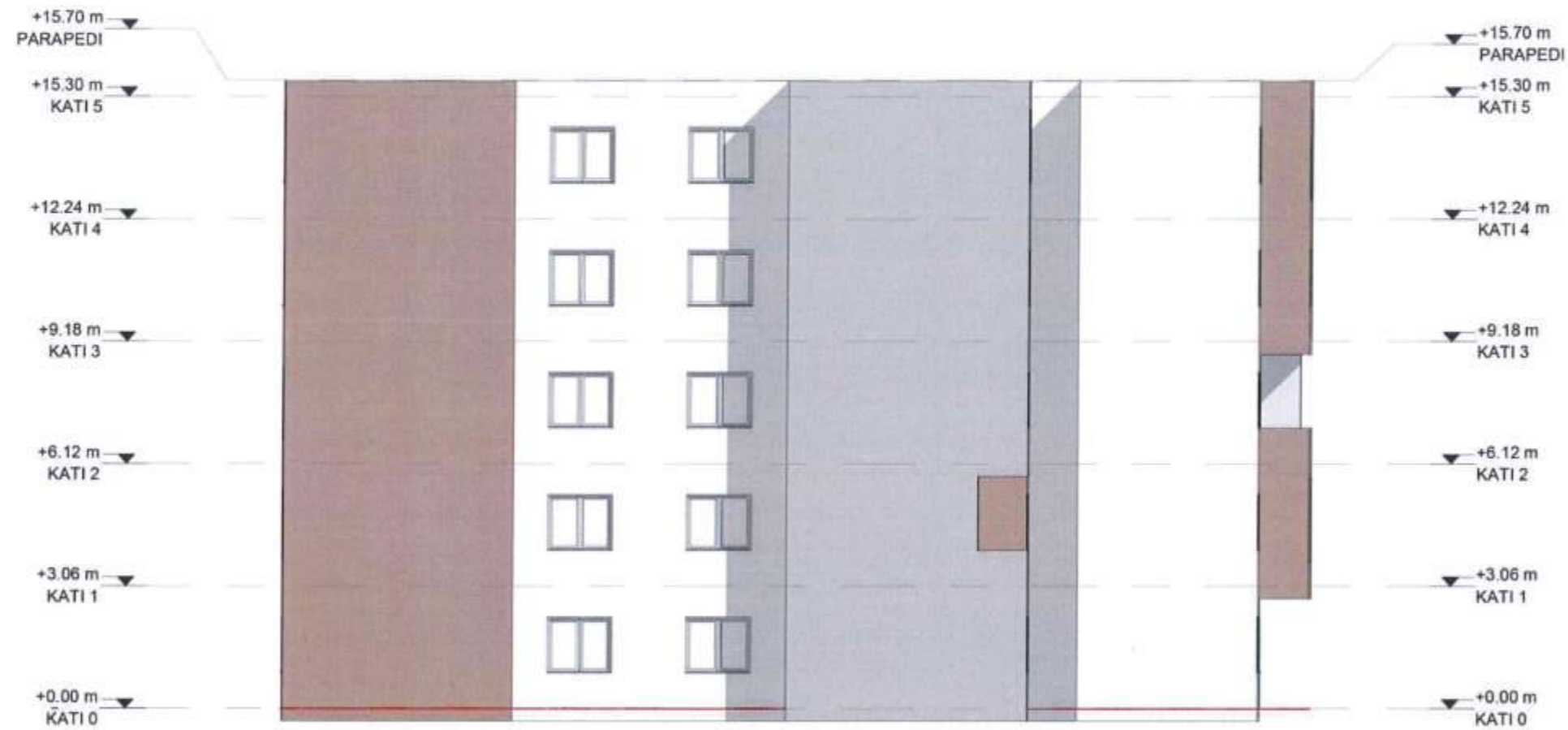

OBJEKTI:

"RIKUALIFIKIM URBAN I PALLATEVE NË HYRJE TË SELENICËS"

VENDODHJA: BASHKIA SELENICË



BASHKIA SELENICË

GRUPI I PROJEKTIMIT

SIRE-ALB SH.P.K

NR.LICENSE: n:7185/5

ING. MESUDE AHMETAJ LIC K.2715/1

ING. BESTAR ÇEKREZI LIC M.1464/1

ING. SULLTANE NEZHAJ LIC E.0638/2

ING. RENALDO KARAJ

ING. TATJANE LICAJ LIC A.0823

SHENIME



DATA: GUSHT 2024

TITULLI I FLETËS:

FASADA JUGORE - PALLATI I

SH. I : 150

FL. A 25

**SIRE** ALB

Architecture Engineering

e-mail: sire-alb@outlook.com

Tel: 0698165747

Adresa: Rr. "Gjergj Arantit",

Lagjia "Pavarsia, Vlorë"

# FASADA LINDORE - PALLATI I



OBJEKTI:

"RIKUALIFIKIM URBAN I PALLATEVE NË HYRJE TË SELENICËS"

VENDODHJA: BASHKIA SELENICË



BASHKIA SELENICË

GRUPI I PROJEKTIMIT

SIRE-ALB SH.P.K

NR.LICENSE: n:7185/5

ING. MESUDE AHMETAJ LIC K.2715/1

ING. BESTAR ÇEKREZI LIC M.1464/1

ING. SULLTANE NEZHAI LIC E.0638/2

ING. RENALDO KARAJ

ING. TATJANE LICAJ LIC A.0823

SHENIME

REGJISTRAT E SUIVAËSËRE PASALE:

Beige (RAL 1001)

RAL 9001  
Signal White

DATA: GUSHT 2024

TITULLI I FLETËS:

FASADA LINDORE - PALLATI I

SH. I : 150

FL. A26



**SIRE** ALB

Architecture Engineering

e-mail: sire-alb@outlook.com

Tel: 0698165747

Adresa: Rr. "Gjergj Arjanit",

Lagja "Pavarsia, Vlorë"

# FASADA PERENDIMORE - PALLATI I

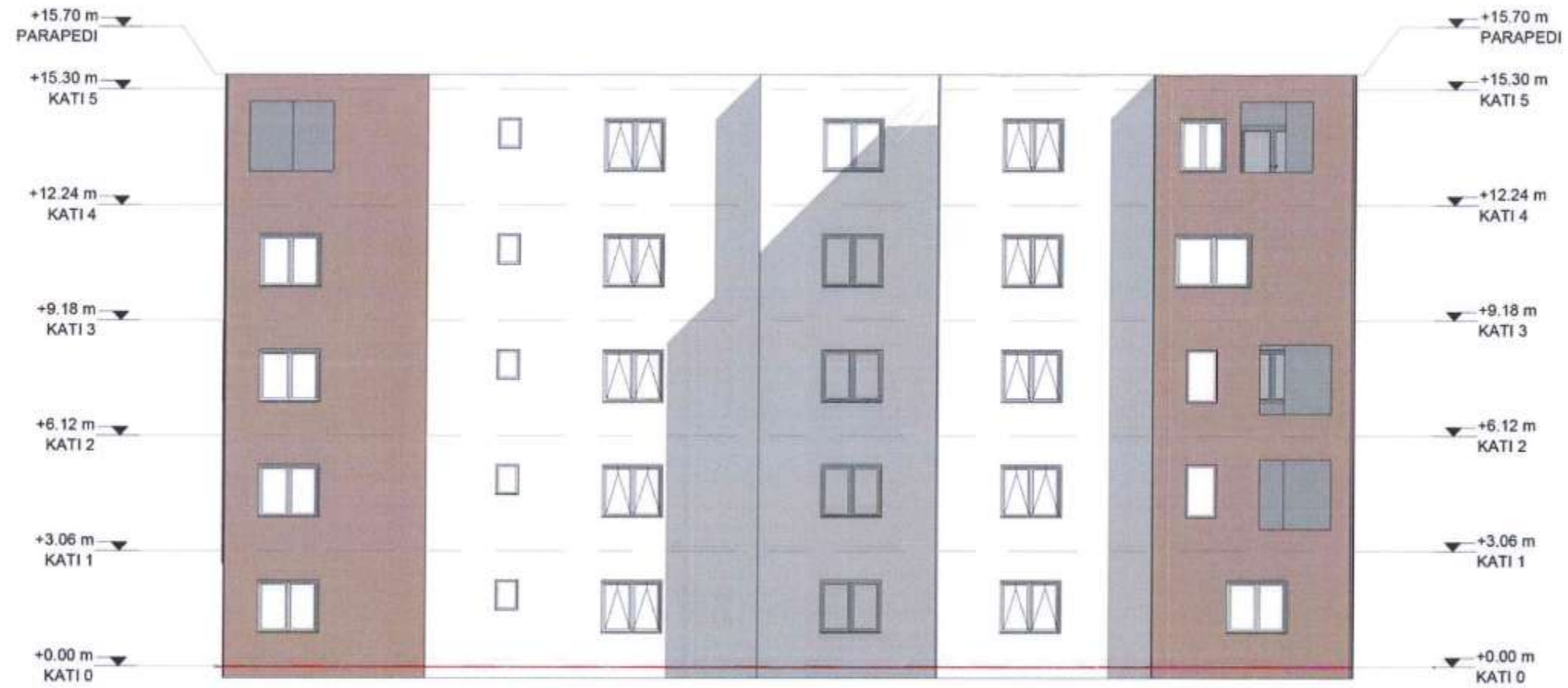

OBJEKTI:

"RIKUALIFIKIM URBAN I PALLATEVE NË HYRJE TË SELENICËS"

VENDODHJA: BASHKIA SELENICË



BASHKIA SELENICË

GRUPI I PROJEKTIMIT

SIRE-ALB SH.P.K

NR.LICENSE: N:7185/5

ING. MESUDE AHMETAJ LIC K.2715/1

ING. BESTAR ÇEKREZI LIC M.1464/1

ING. SULLTANE NEZHAJ LIC E.0638/2

ING. RENALDO KARAJ

ING. TATJANE LICAJ LIC A.0823

SHENIME



DATA: GUSHT 2024

TITULLI I FLETËS:

FASADA PERENDIMORE - PALLATI I

SH. I : 150

FL. A27

**SIRE** ALB  
Architecture Engineering

e-mail: sire-alb@outlook.com

Tel: 0698165747

Adresa: Rr. "Gjergj Arjanit",

Lagja "Pavarsia, Vlorë"

# FASADA VERIORE - PALLATI I



OBJEKTI:

"RIKUALIFIKIM URBAN I PALLATEVE NË  
HYRJE TË SELENICËS"

VENDODHJA: BASHKIA SELENICË



BASHKIA SELENICË

GRUPI I PROJEKTIMIT

SIRE-ALB SH.P.K

NR.LICENSE: n:7185/5

ING. MESUDE AHMETAJ LIC K.2715/1

ING. BESTAR ÇEKREZI LIC M.1464/1

ING. SULLTANE NEZHAJ LIC E.0638/2

ING. RENALDO KARAJ

ING. TATJANE LICAJ LIC A.0823

SHENIME



DATA: GUSHT 2024

TITULLI I FLETËS:

FASADA VERIORE - PALLATI I

SH. I : 150

FL. A28

**SIRE** ALB  
Architecture Engineering

e-mail: sire-alb@outlook.com

Tel: 0698165747

Adresa: Rr. "Gjergj Arjanit",

Lagja "Pavarësia, Vlorë"

# FASADA JUGORE - PALLATI 2

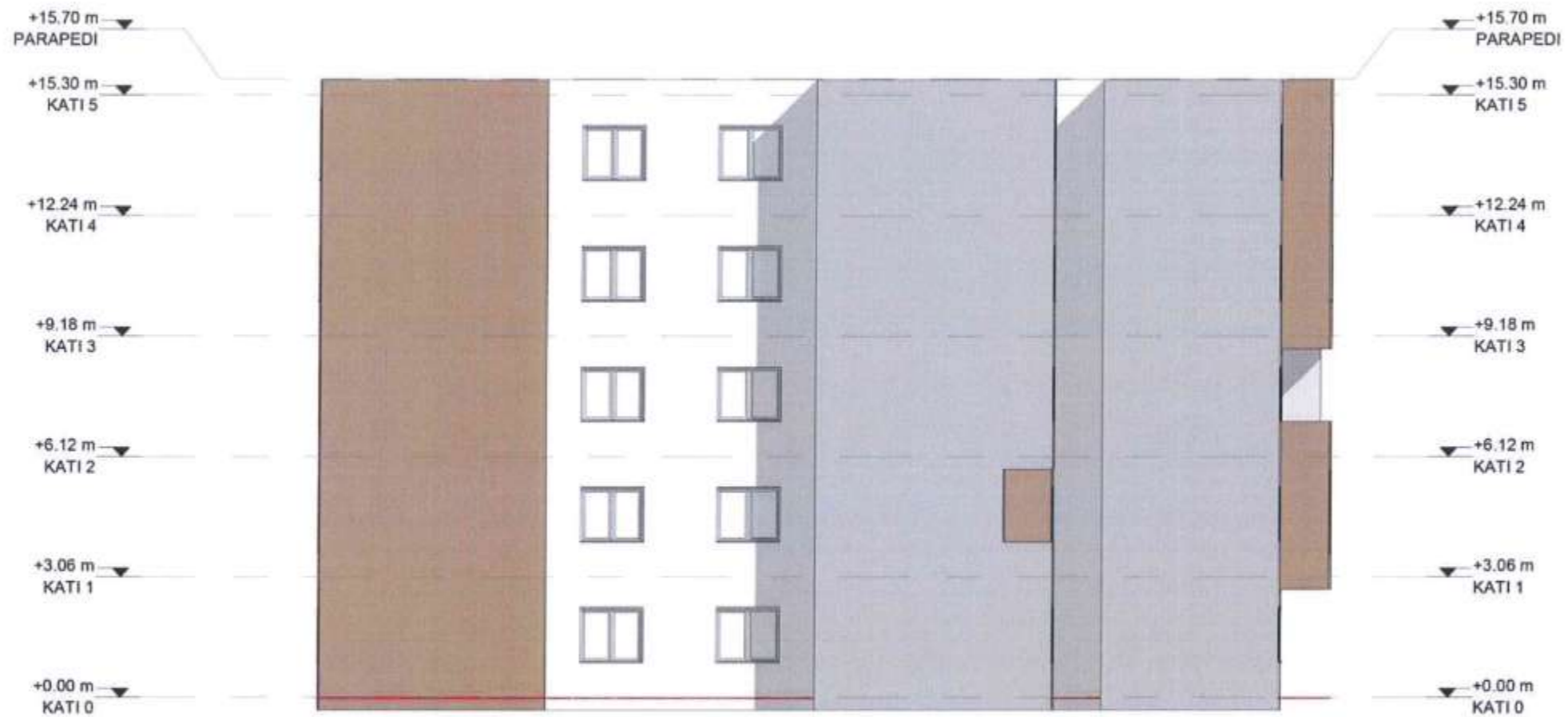

OBJEKTI:

"RIKUALIFIKIM URBAN I PALLATEVE NË HYRJE TË SELENICËS"

VENDODHJA: BASHKIA SELENICË



BASHKIA SELENICË

GRUPI I PROJEKTIMIT

SIRE-ALB SH.P.K

NR.LICENSE: N.7185/5

ING. MESUDE AHMETAJ LIC K.2715/1

ING. BESTAR ÇEKREZI LIC M.1464/1

ING. SULLTANE NEZHAI LIC E.0638/2

ING. RENALDO KARAJ

ING. TATJANE LICAJ LIC A.0823

SHENIME



DATA: GUSHT 2024

TITULLI I FLETËS:

FASADA JUGORE - PALLATI 2

SH. 1 : 150

FL. A29

**SIRE** ALB  
Architecture Engineering

e-mail: sire-alb@outlook.com

Tel: 0698165747

Adresa: Rr. "Gjergj Arjanit",

Lagja "Pavarësia, Vlorë"

# FASADA VERIORE - PALLATI 2

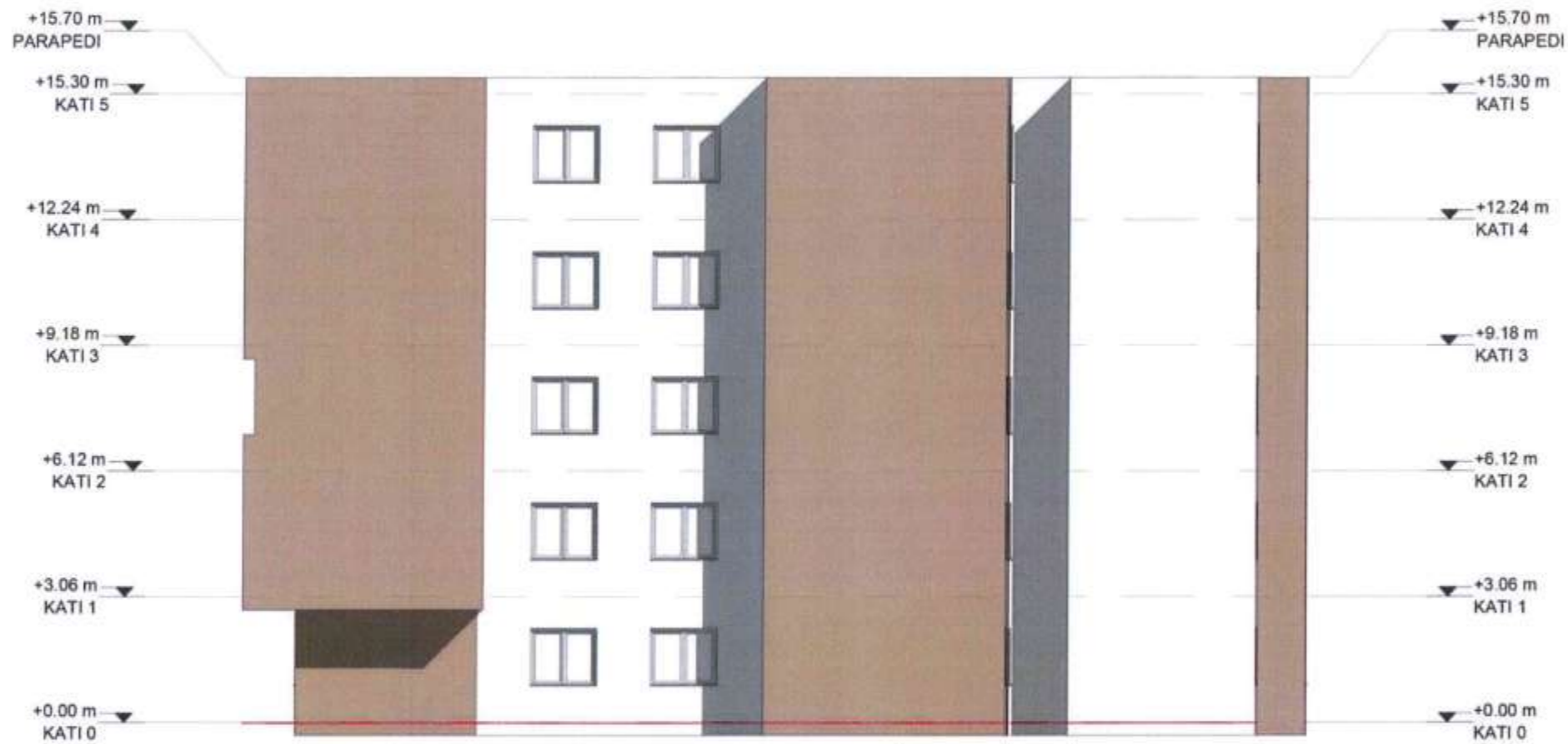

OBJEKTI:

"RIKUALIFIKIM URBAN I PALLATEVE NË HYRJE TË SELENICËS"

VENDODHJA: BASHKIA SELENICË



BASHKIA SELENICË

GRUPI I PROJEKTIMIT

SIRE-ALB SH.P.K

NR.LICENSE: N.7185/5

ING. MESUDE AHMETAJ LIC K.2715/1

ING. BESTAR ÇEKREZI LIC M.1464/1

ING. SULLTANE NEZHAI LIC E.0638/2

ING. RENALDO KARAJ

ING. TATJANE LICAJ LIC A.0823

SHENIME



DATA: GUSHT 2024

TITULLI I FLETËS:

FASADA VERIORE - PALLATI 2

SH. I : 150

FL. A30

**SIRE** ALB  
Architecture Engineering

e-mail: sire-alb@outlook.com

Tel: 0698165747

Adresa: Rr. "Gjergj Arjanit",

Llogjia "Pavarësia, Vlorë"

## FASADA LINDORE - PALLATI 2

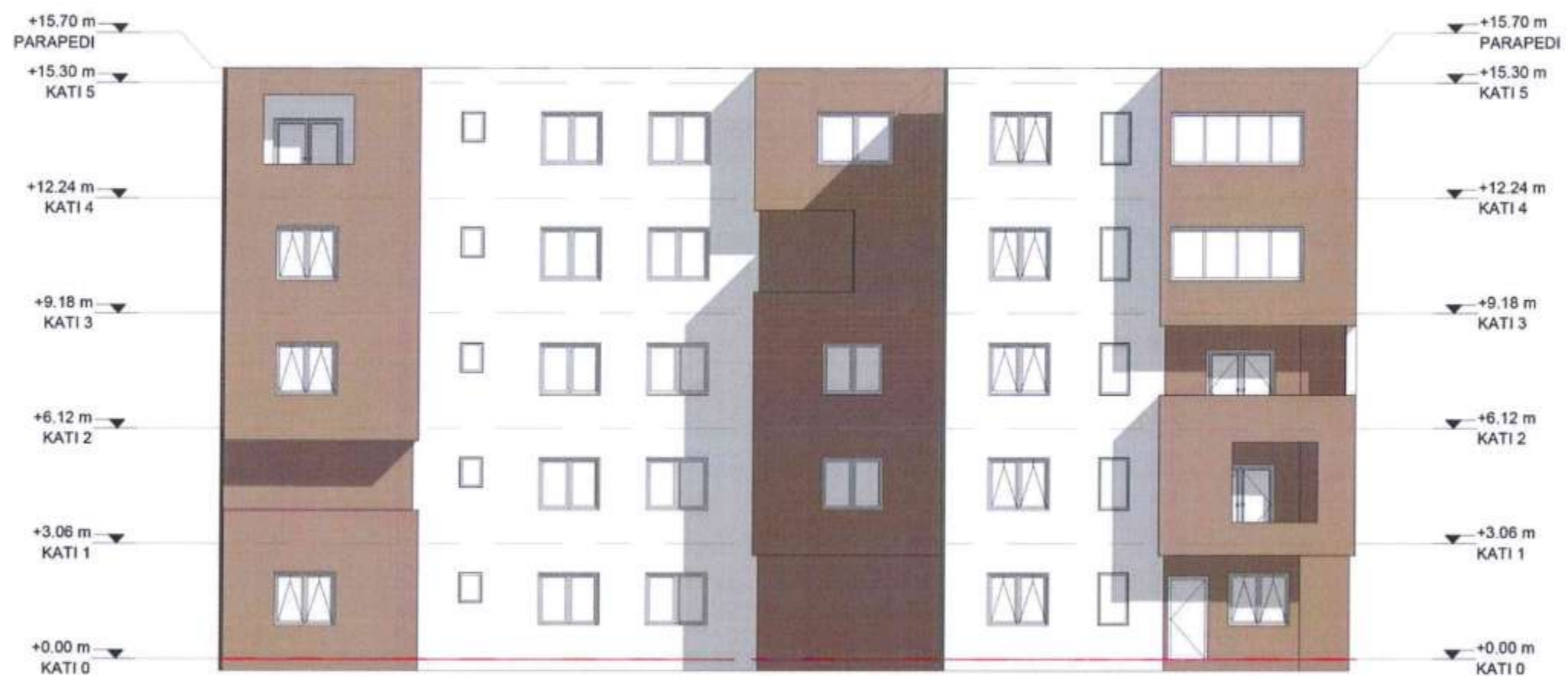

OBJEKTI:

"RIKUALIFIKIM URBAN I PALLATEVE NË HYRJE TË SELENICËS"

VENDODHJA: BASHKIA SELENICË



BASHKIA SELENICË

GRUPI I PROJEKTIMIT

SIRE-ALB SH.P.K

NR.LICENSE: N:7185/3

ING. MESUDE AHMETAJ LIC K.2715/1

ING. BESTAR ÇEKREZI LIC M.1464/1

ING. SULLTANE NEZHAI LIC E.0638/2

ING. RENALDO KARAJ

ING. TATJANE LICAJ LIC A.0823

SHENIME



DATA: MAJ 2024

TITULLI I FLETËS:

FASADA LINDORE - PALLATI 2

SH. 1 : 150

FL. A3I

**SIRE** ALB  
Architecture Engineering

e-mail: sire-alb@outlook.com  
Tel: 0698165747  
Adresa: Rr. "Gjergj Arjanit",  
Lagja "Pavarsia, Vlorë"



# FASADA PERENDIMORE - PALLATI 2



OBJEKTI:

"RIKUALIFIKIM URBAN I PALLATEVE NË HYRJE TË SELENICËS"

VENDODHJA: BASHKIA SELENICË



BASHKIA SELENICË

GRUPI I PROJEKTIMIT

SIRE-ALB SH.P.K

NR.LICENSE: n.7185/3

ING. MESUDE AHMETAJ LIC K.2715/1

ING. BESTAR ÇEKREZI LIC M.1464/1

ING. SULLTANE NEZHAI LIC E.0638/2

ING. RENALDO KARAJ

ING. TATJANE LICAJ LIC A.0823

SHENIME



DATA: GUSHT 2024

TITULLI I FLETËS:

FASADA PERENDIMORE - PALLATI 2

SH. I : 150

FL. A32



Architecture Engineering

e-mail: sire-alb@outlook.com

Tel: 0698165747

Adresa: Rr. "Gjergj Arjanit",

Lagja "Pavarësia, Vlorë"

RENDER

OBJEKTI:

"RIKUALIFIKIM URBAN I PALLATEVE NË  
HYRJE TË SELENICËS"

VENDODHJA: BASHKIA SELENICË



BASHKIA SELENICË

GRUPI I PROJEKTIMIT

SIRE-ALB SH.P.K

NR.LICENSE: n:7185/5

ING. MESUDE AHMETAJ LIC K.2715/1

ING. BESTAR ÇEKREZI LIC M.1464/1

ING. SULLTANE NEZHAJ LIC E.0638/2

ING. RENALDO KARAJ

ING. TATJANE LICAJ LIC A.0823

SHENIME



DATA: GUSHT 2024

TITULLI I FLETËS:

RENDER

SH.

FL.33



Architecture Engineering

e-mail: sire-alb@outlook.com

Tel: 0698165747

Adresa: Rr. "Gjergj Arjanit",  
Lagja "Rovarësia, Vlorë"

RENDER

OBJEKTI:

"RIKUALIFIKIM URBAN I PALLATEVE NË HYRJE TË SELENICËS"

VENDODHJA: BASHKIA SELENICË



BASHKIA SELENICË

GRUPI I PROJEKTIMIT

SIRE-ALB SH.P.K

NR.LICENSE: N:7185/5

ING. MESUDE AHMETAJ LIC K.2715/1

ING. BESTAR ÇEKREZI LIC M.1464/1

ING. SULTANE NEZHAI LIC E.0658/2

ING. RENALDO KARAJ

ING. TATJANE LICAJ LIC A.0823

SHENIME



DATA: GUSHT 2024

TITULLI I FLETËS:

RENDER

SH.

FL. A34



SIRE ALB

Architecture Engineering

e-mail: sire-alb@outlook.com

Tel: 0698 165747

Adresa: Rr. "Gjergj Arjanit",

Lagja "Pavarësia, Vlorë"

RENDER

OBJEKTI:

"RIKUALIFIKIM URBAN I PALLATEVE NË  
HYRJE TË SELENICËS"

VENDODHJA: BASHKIA SELENICË



BASHKIA SELENICË

GRUPI I PROJEKTIMIT

SIRE-ALB SH.P.K

NR.LICENSE: n:7185/5

ING. MESUDE AHMETAJ LIC K.2715/1

ING. BESTAR ÇEKREZI LIC M.1464/1

ING. SULLTANE NEZHAIJ LIC E.0638/2

ING. RENALDO KARAJ

ING. TATJANE LICAJ LIC A.0823

SHENIME



DATA: GUËHT 2024

TITULLI I FLETËS:

RENDER

SH.

FL. A35



SIRE ALB

Architecture Engineering

e-mail: sire-alb@outlook.com

Tel: 0698165747

Adresa: Rr. "Gjergj Arjanit",  
Lagjia "Pavarsia, Vlorë"

RENDER

OBJEKTI:

"RIKUALIFIKIM URBAN I PALLATEVE NË  
HYRJE TË SELENICËS"

VENDODHJA: BASHKIA SELENICË



BASHKIA SELENICË

GRUPI I PROJEKTIMIT

SIRE-ALB SH.P.K

NR.LICENSE: n.7185/3

ING. MESUDE AHMETAJ LIC K.2715/1

ING. BESTAR ÇEKREZI LIC M.1464/1

ING. SULLTANE NEZHAI LIC E.0638/2

ING. RENALDO KARAJ

ING. TATJANE LICAJ LIC A.0823

SHENIME



DATA: GUSHT 2024

TITULLI I FLETËS:

RENDER

SH.

FL. A36



Architecture Engineering

e-mail: sire-alba@outlook.com

Tel: 0698165747

Adresa: Rr. "Gjergj Arlani",

Lagjia "Pavarësia, Vlorë"

RENDER

OBJEKTI:

"RIKUALIFIKIM URBAN I PALLATEVE NË  
HYRJE TË SELENICËS"

VENDODHJA: BASHKIA SELENICË



BASHKIA SELENICË

GRUPI I PROJEKTIMIT

SIRE-ALB SH.P.K

NR.LICENSE: N:7185/5

ING. MESUDE AHMETAJ LIC K.2715/1

ING. BESTAR ÇEKREZI LIC M.1464/1

ING. SULLTANE NEZHAI LIC E.0638/2

ING. RENALDO KARAJ

ING. TATJANE LICAJ LIC A.0823

SHENIME



DATA: GUSHT 2024

TITULLI I FLETËS:

RENDER

SH.

FL. A37



**SIRE** ALB  
Architecture Engineering  
e-mail: sire-alb@outlook.com  
Tel: 0698165747  
Adresa: Rr. "Gjergj Arianiti",  
Lagja "Pavarësia, Vlorë"