



BASHKIA VLORE

MIRATOI
KRYETARI I BASHKISË VLORE

ERMAL DREDHA

RIKUALIFIKIM I RRUGËS TE FABRIKA E ÇIMENTOS LOT 1

FAZA E PARË
PROJEKT ZBATIMI

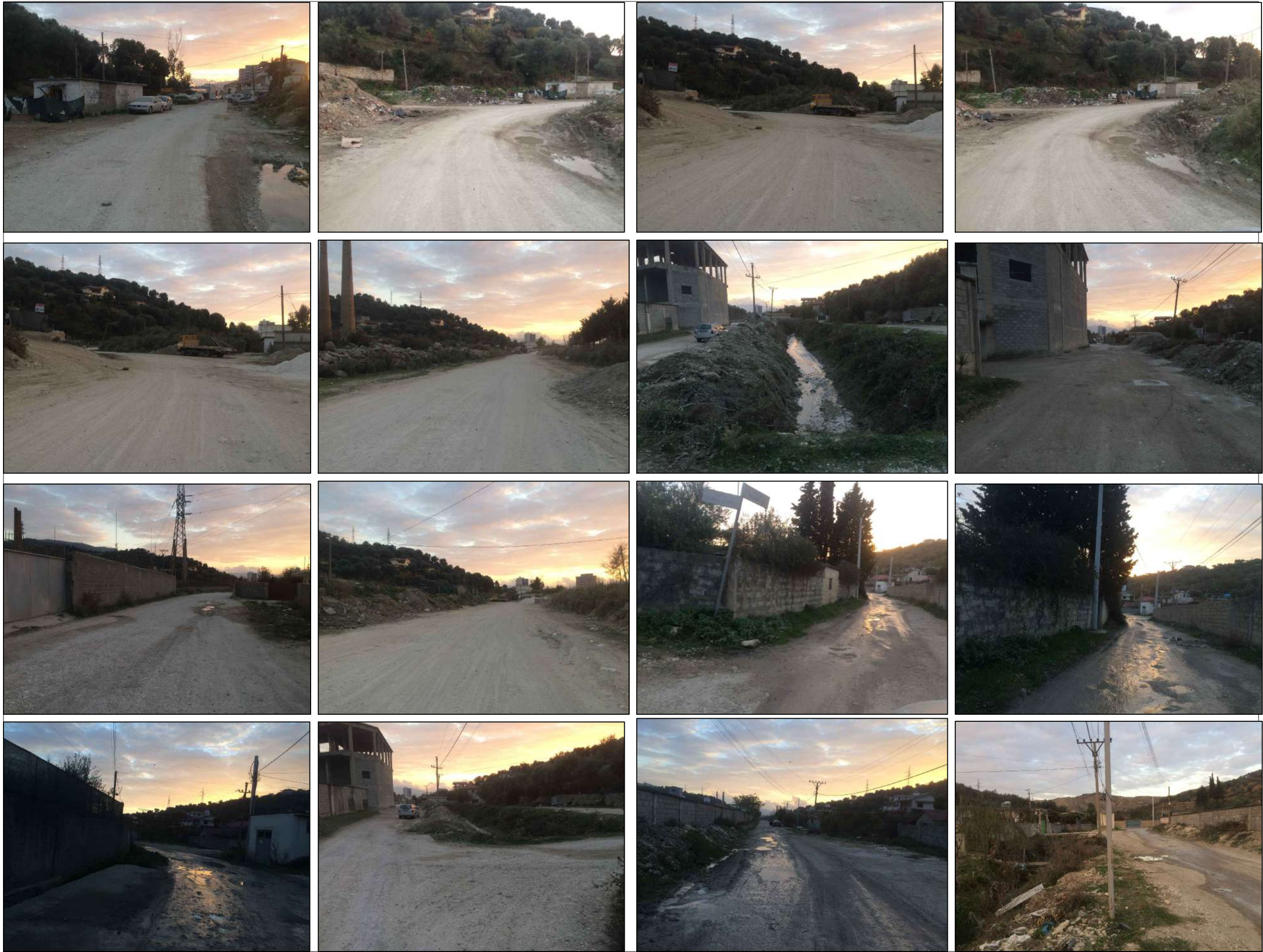

Punoi:
 Urb Erlind Kapaj
 Drejtor:
 Ark Klaudio Mehmetaj



BASHKIA VLORË

DREJTORIA E
 PLANIFIKIMIT DHE
 KONTROLLIT TË
 ZHVILLIMIT

PROJEKT: RIKUALIFIKIM I RRUGËS TE FABRIKA E ÇIMENTOS LOT 1

FOTOGRAFI TË GJENDJES EKZISTUESE

VLORE 2024

A-01

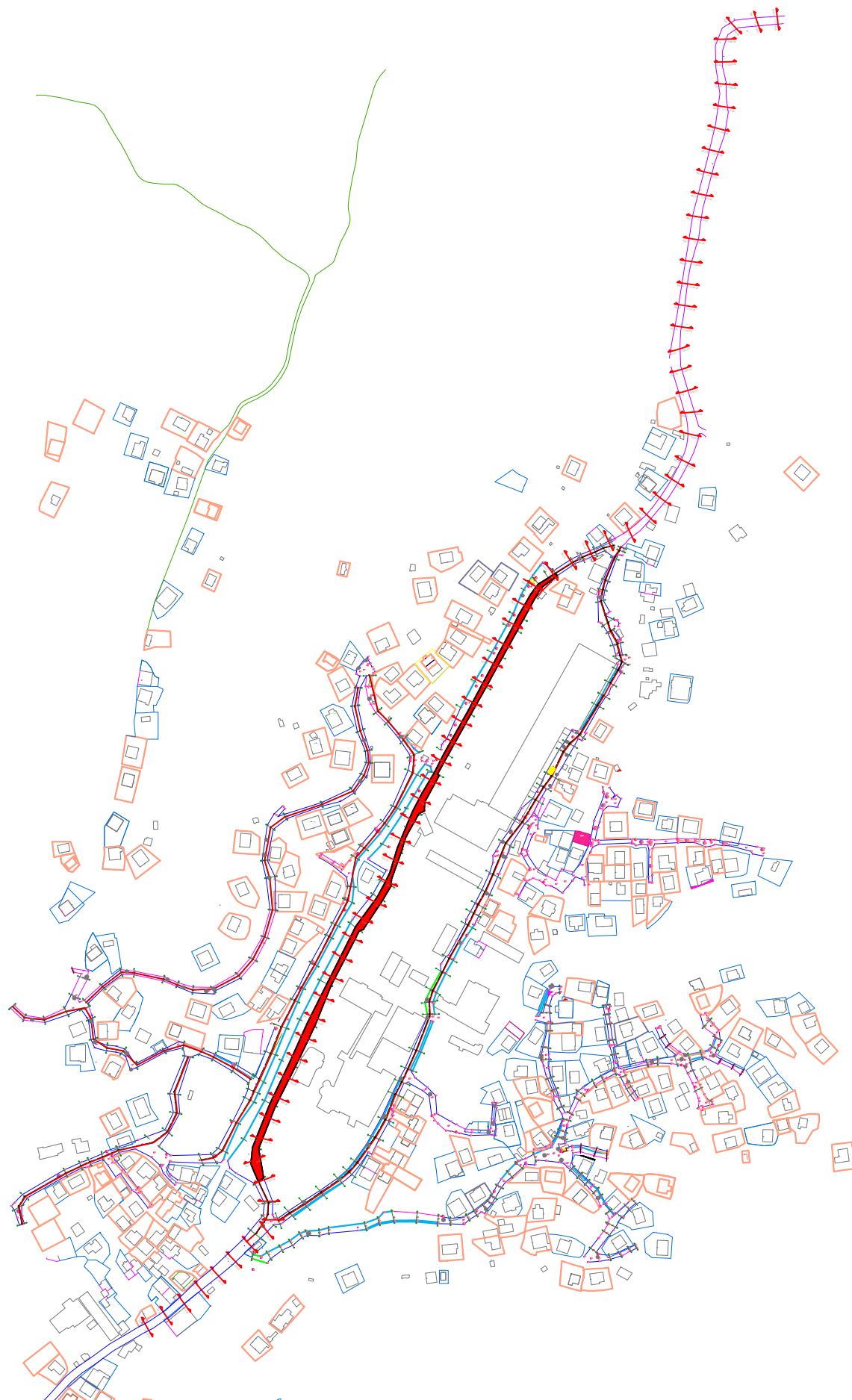

Punoi:
Urb Erlind Kapaj
Drejtor:
Ark Klaudio Mehmetaj



BASHKIA VLORE

DREJTORIA E
PLANIFIKIMIT DHE
KONTROLLIT TË
ZHVILLIMIT

PROJEKT: RIKUALIFIKIM I RRUGËS TE FABRIKA E ÇIMENTOS LOT 1

GJENDJA EKZISTUESE

VLORE 2024

A-02

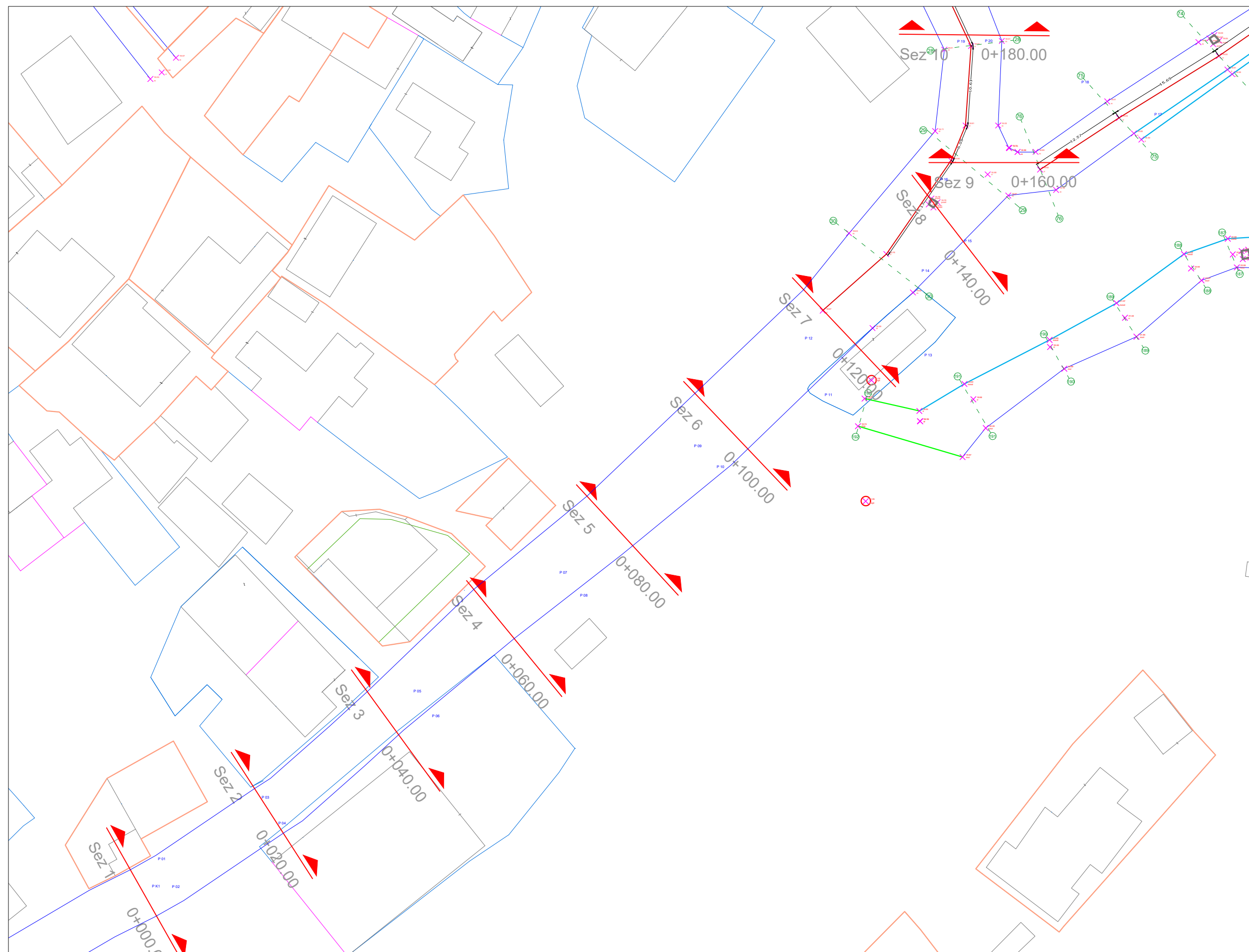

Punoi:
 Urb Erlind Kapaj
 Drejtor:
 Ark Klaudio Mehmetaj



BASHKIA VLORE

DREJTORIA E
 PLANIFIKIMIT DHE
 KONTROLLIT TË
 ZHVILLIMIT

PROJEKT: RIKUALIFIKIM I RRUGËS TE FABRIKA E ÇIMENTOS LOT 1
 SH 1:500

GJENDJA EKZISTUESE

VLORE 2024

A-03

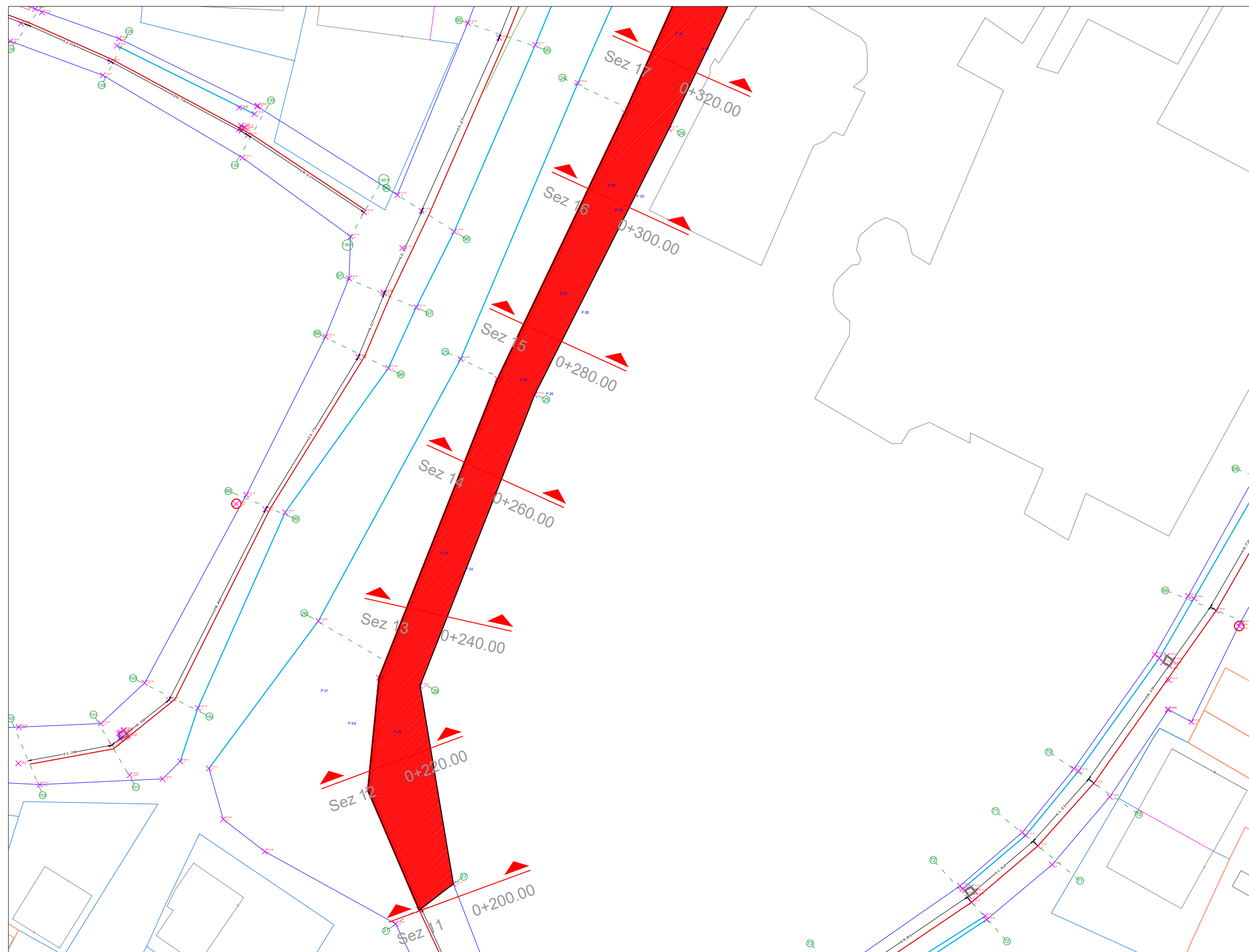

Punoi:
Urb Erlind Kapaj
Drejtor:
Ark Klaudio Mehmetaj



BASHKIA VLORE

DREJTORIA E
PLANIFIKIMIT DHE
KONTROLLIT TË
ZHVILLIMIT

PROJEKT: RIKUALIFIKIM I RRUGËS TE FABRIKA E ÇIMENTOS LOT 1
SH 1:500

GJENDJA EKZISTUESE

VLORE 2024

A-04



Punoi:
Urb Erlind Kapaj
Drejtör:
Ark Klaudio Mehmetaj



BASHKIA VLORE

DREJTORIA E
PLANIFIKIMIT DHE
KONTROLLIT TË
ZHVILLIMIT

PROJEKT: RIKUALIFIKIM I RRUGËS TE FABRIKA E ÇIMENTOS LOT 1
SH 1:500

GJENDJA EKZISTUESE

VLORE 2024

A-05

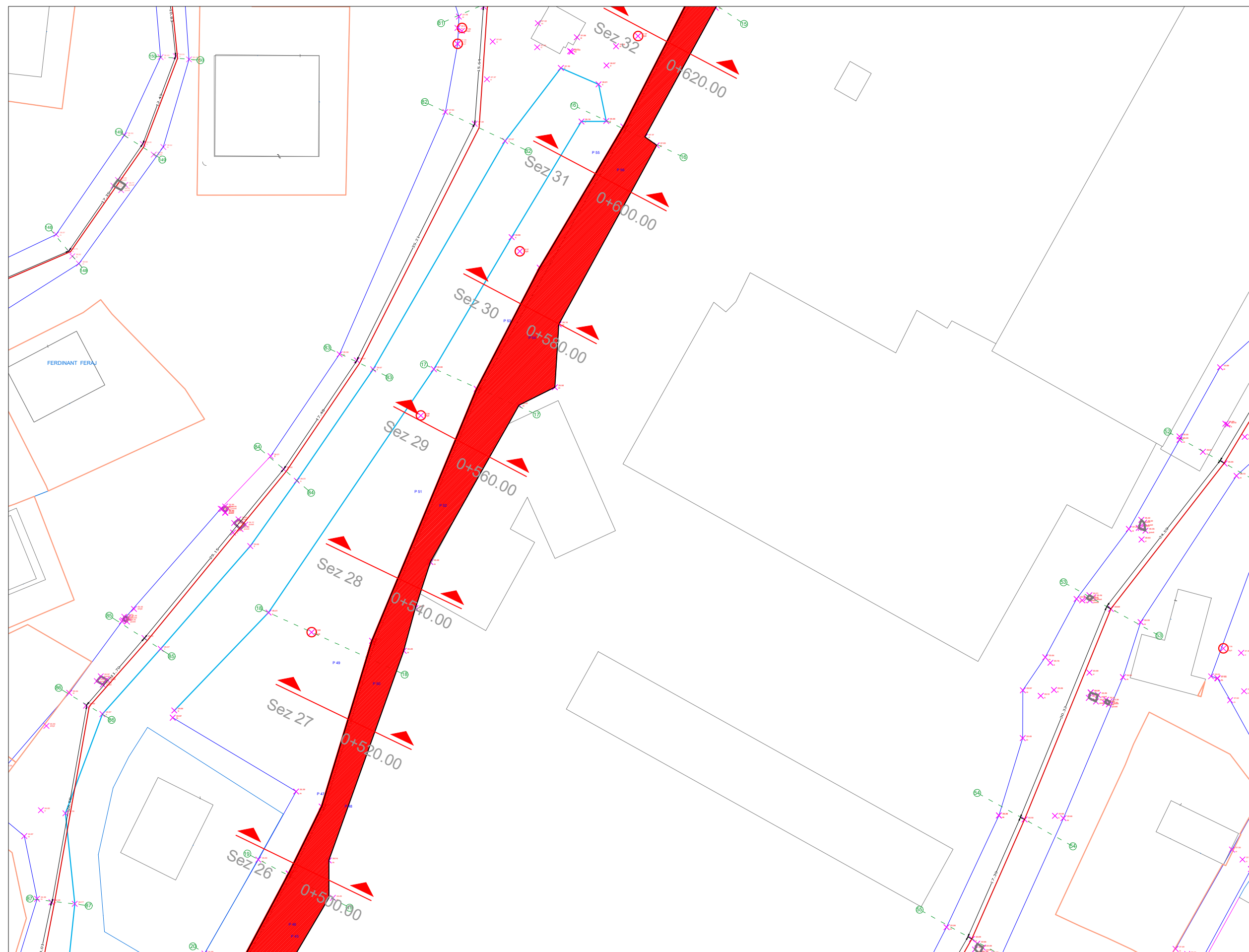

Punoi:
Urb Erlind Kapaj
Drejtor:
Ark Klaudio Mehmetaj



BASHKIA VLORE

DREJTORIA E
PLANIFIKIMIT DHE
KONTROLLIT TË
ZHVILLIMIT

PROJEKT: RIKUALIFIKIM I RRUGËS TE FABRIKA E ÇIMENTOS LOT 1
SH 1:500

GJENDJA EKZISTUESE

VLORE 2024

A-06



Punoi:
Urb Erlind Kapaj
Drejtor:
Ark Klaudio Mehmetaj



BASHKIA VLORE

DREJTORIA E
PLANIFIKIMIT DHE
KONTROLLIT TË
ZHVILLIMIT

PROJEKT: RIKUALIFIKIM I RRUGËS TE FABRIKA E ÇIMENTOS LOT 1
SH 1:500

GJENDJA EKZISTUESE

VLORE 2024

A-07

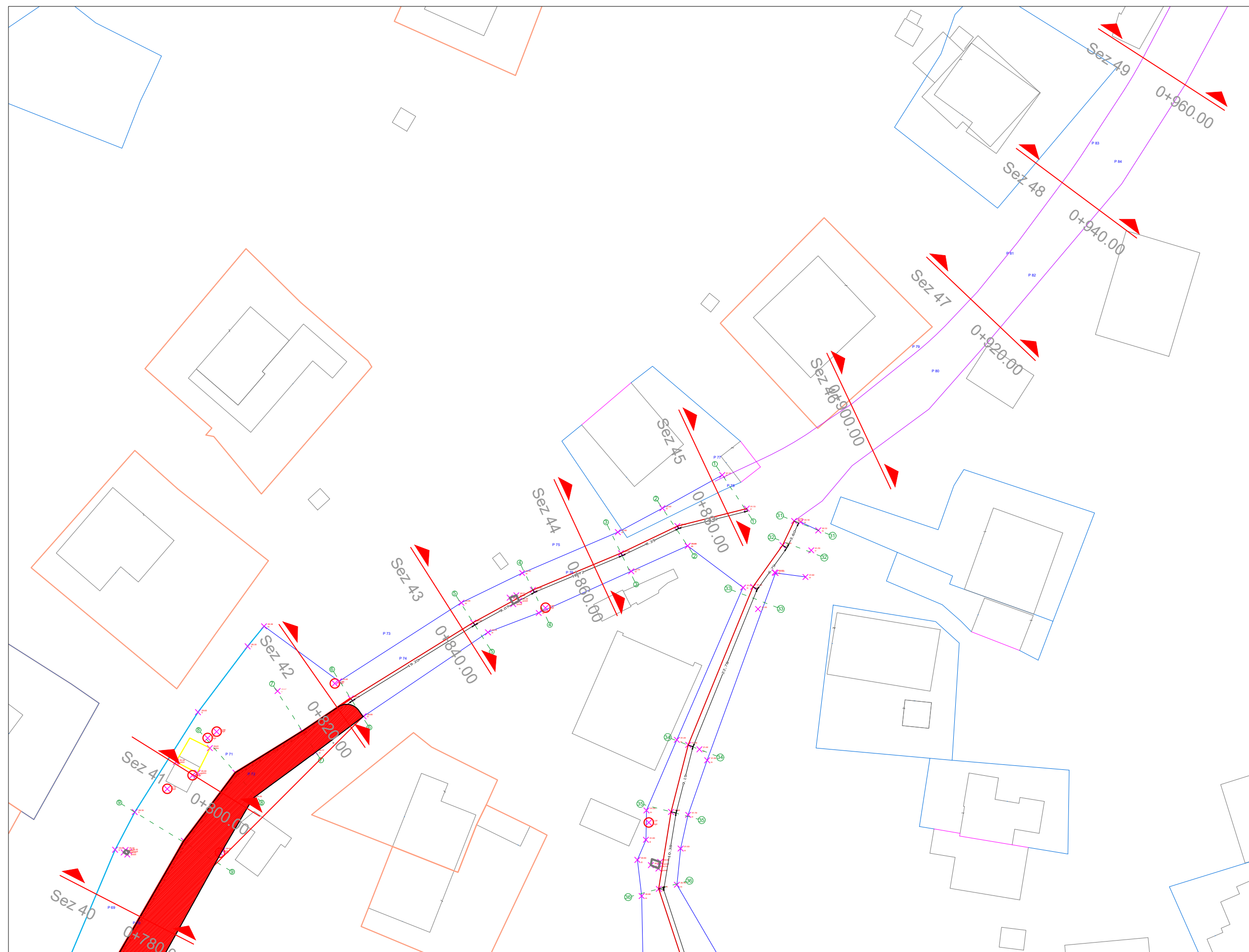

Punoi:
 Urb Erlind Kapaj
 Drejtor:
 Ark Klaudio Mehmetaj



BASHKIA VLORE

DREJTORIA E
 PLANIFIKIMIT DHE
 KONTROLLIT TË
 ZHVILLIMIT

PROJEKT: RIKUALIFIKIM I RRUGËS TE FABRIKA E ÇIMENTOS LOT 1
 SH 1:500

GJENDJA EKZISTUESE

VLORE 2024

A-08

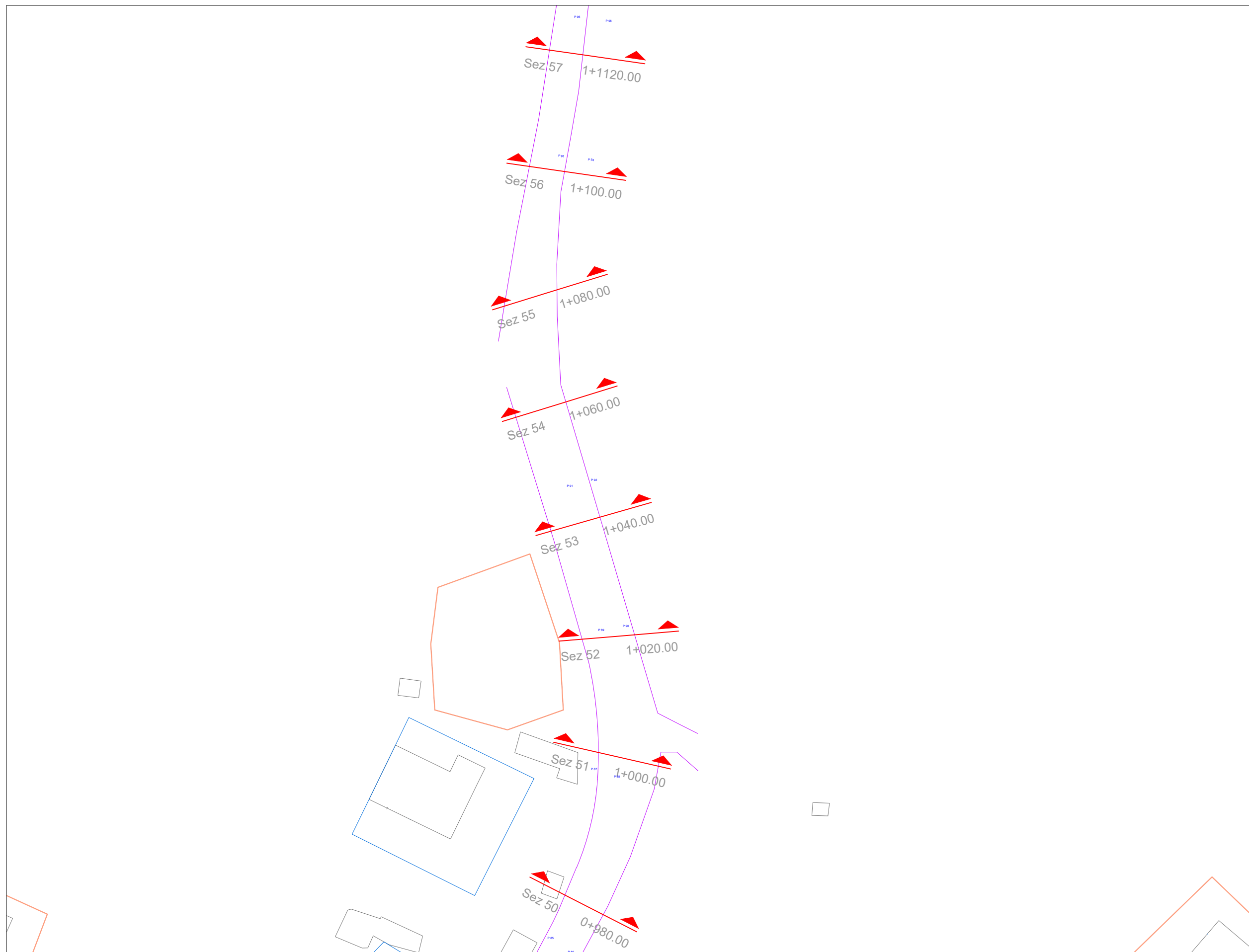

Punoi:
Urb Erlind Kapaj
Drejtor:
Ark Klaudio Mehmetaj



BASHKIA VLORË

DREJTORIA E
PLANIFIKIMIT DHE
KONTROLLIT TË
ZHVILLIMIT

PROJEKT: RIKUALIFIKIM I RRUGËS TE FABRIKA E ÇIMENTOS LOT 1
SH 1:500

GJENDJA EKZISTUESE

VLORE 2024

A-09

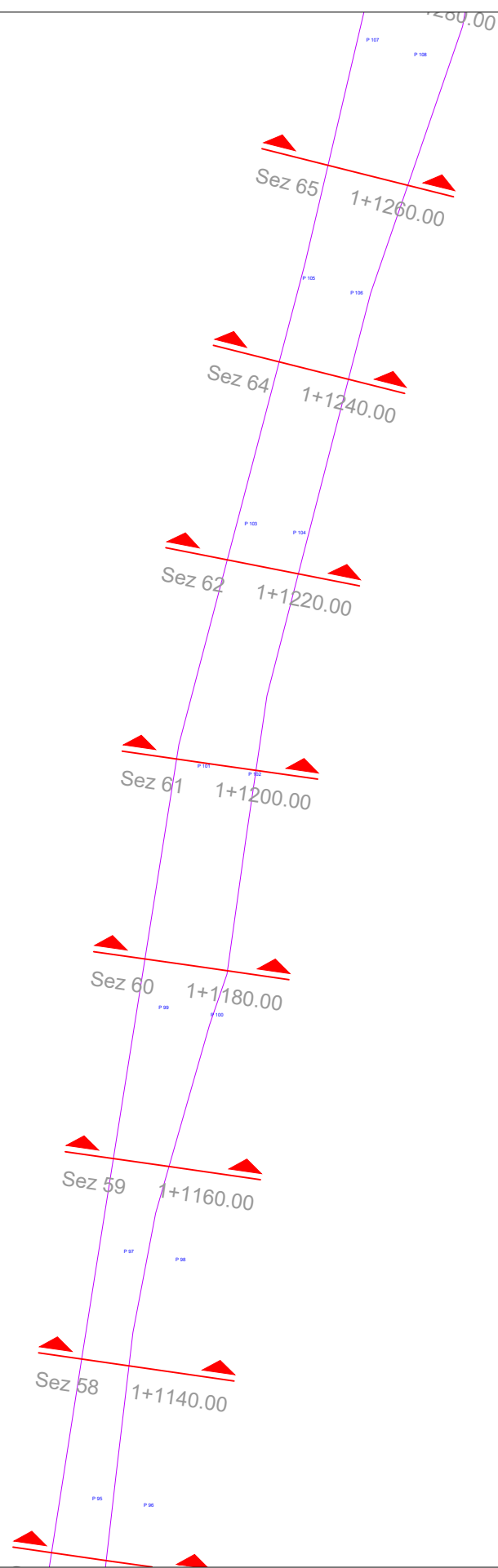

Punoi:
 Urb Erlind Kapaj
 Drejtor:
 Ark Klaudio Mehmetaj



BASHKIA VLORE

DREJTORIA E
 PLANIFIKIMIT DHE
 KONTROLLIT TË
 ZHVILLIMIT

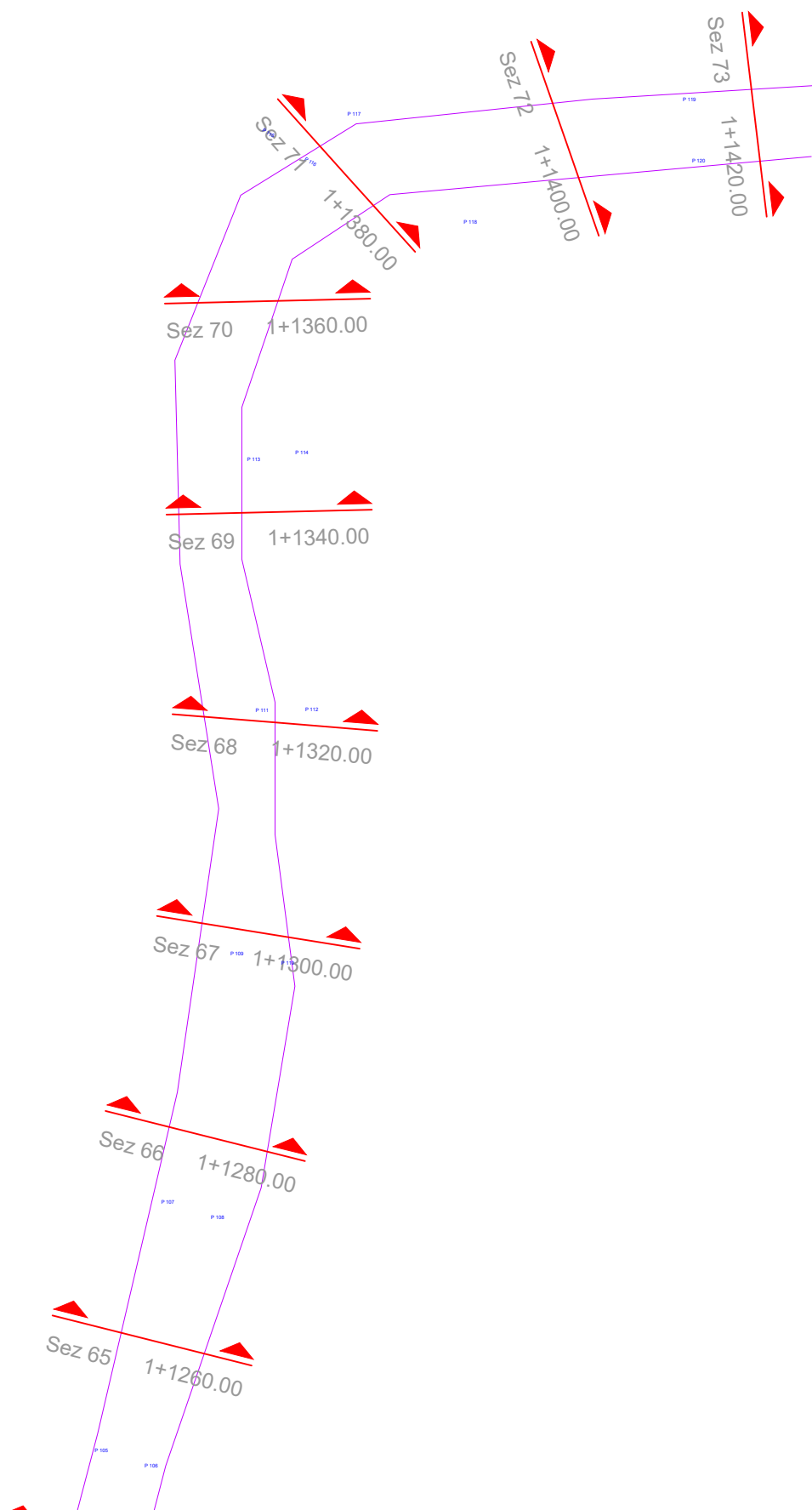

Punoi:
 Urb Erlind Kapaj
 Drejtor:
 Ark Klaudio Mehmetaj



BASHKIA VLORE

DREJTORIA E
 PLANIFIKIMIT DHE
 KONTROLLIT TË
 ZHVILLIMIT

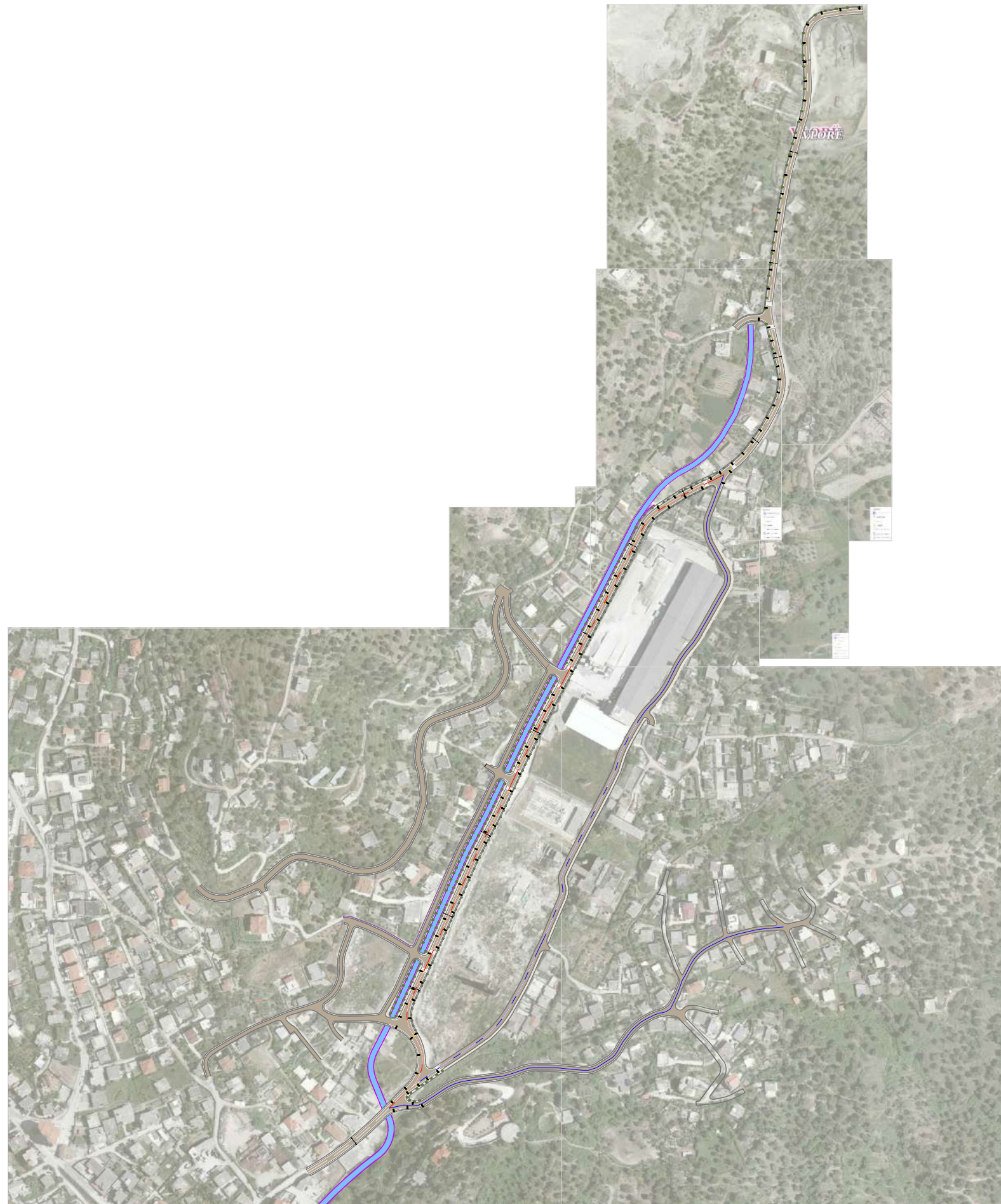

Punoi:
Urb Erlind Kapaj
Drejtör:
Ark Klaudio Mehmetaj



BASHKIA VLORË

DREJTORIA E
PLANIFIKIMIT DHE
KONTROLLIT TË
ZHVILLIMIT

PROJEKT: RIKUALIFIKIM I RRUGËS TE FABRIKA E ÇIMENTOS LOT 1

VLORE 2024

PLANIMETRI E RRUGËS "EDUARD LIR"

A-12

FAZA E PARË:

RIKUALIFIKIM I BLLOKUT TË BANESAVE KUFIZUAR NGA "RRUGA" EDUARD ILIR

Gjatësia = 1474 m

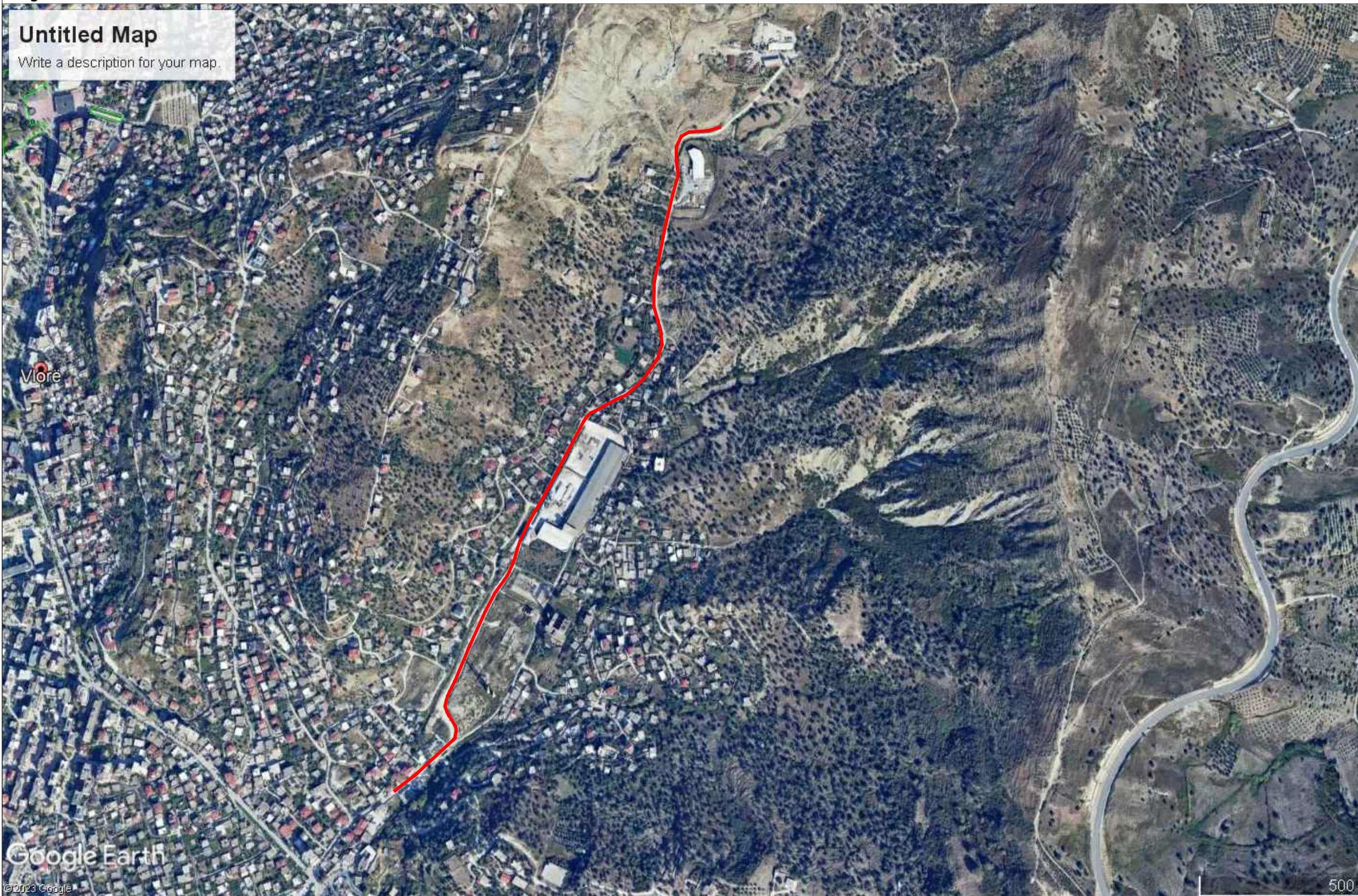

Punoi:
Urb Erlind Kapaj
Drejtor:
Ark Klaudio Mehmetaj



BASHKIA VLORE

DREJTORIA E
PLANIFIKIMIT DHE
KONTROLLIT TË
ZHVILLIMIT

PROJEKT: RIKUALIFIKIM I RRUGËS TE FABRIKA E ÇIMENTOS LOT 1

VLORE 2024

PLANIMETRI E RRUGËS "EDUARD LIR"

A-13

Gjatësia = 1474 m



Punoi:
Urb Erlind Kapaj
Drejtör:
Ark Klaudio Mehmetaj



BASHKIA VLORË

DREJTORIA E
PLANIFIKIMIT DHE
KONTROLLIT TË
ZHVILLIMIT



Punoi:
Urb Erlind Kapaj
Drejtor:
Ark Klaudio Mehmetaj



BASHKIA VLORE

DREJTORIA E
PLANIFIKIMIT DHE
KONTROLLIT TË
ZHVILLIMIT

PROJEKT: RIKUALIFIKIM I RRUGËS TE FABRIKA E ÇIMENTOS LOT 1
SH 1:500

PLANIMETRI E RRUGËS "EDUARD LIR"

VLORE 2024

A-15



Punoi:
Urb Erlind Kapaj
Drejtor:
Ark Klaudio Mehmetaj



BASHKIA VLORË

DREJTORIA E
PLANIFIKIMIT DHE
KONTROLLIT TË
ZHVILLIMIT

PROJEKT: RIKUALIFIKIM I RRUGËS TE FABRIKA E ÇIMENTOS LOT 1
SH 1:500

VLORE 2024

PLANIMETRI E RRUGËS "EDUARD LIR"

A-16



Punoi:
 Urb Erlind Kapaj
 Drejtor:
 Ark Klaudio Mehmetaj



BASHKIA VLORE

DREJTORIA E
 PLANIFIKIMIT DHE
 KONTROLLIT TË
 ZHVILLIMIT

PROJEKT: RIKUALIFIKIM I RRUGËS TE FABRIKA E ÇIMENTOS LOT 1
 SH 1:500

VLORE 2024

A-17

PLANIMETRI E RRUGËS "EDUARD LIR"



Punoi:
Urb Erlind Kapaj
Drejtor:
Ark Klaudio Mehmetaj



BASHKIA VLORË

DREJTORIA E
PLANIFIKIMIT DHE
KONTROLLIT TË
ZHVILLIMIT

PROJEKT: RIKUALIFIKIM I RRUGËS TE FABRIKA E ÇIMENTOS LOT 1
SH 1:500

PLANIMETRI E RRUGËS "EDUARD LIR"

VLORE 2024

A-18

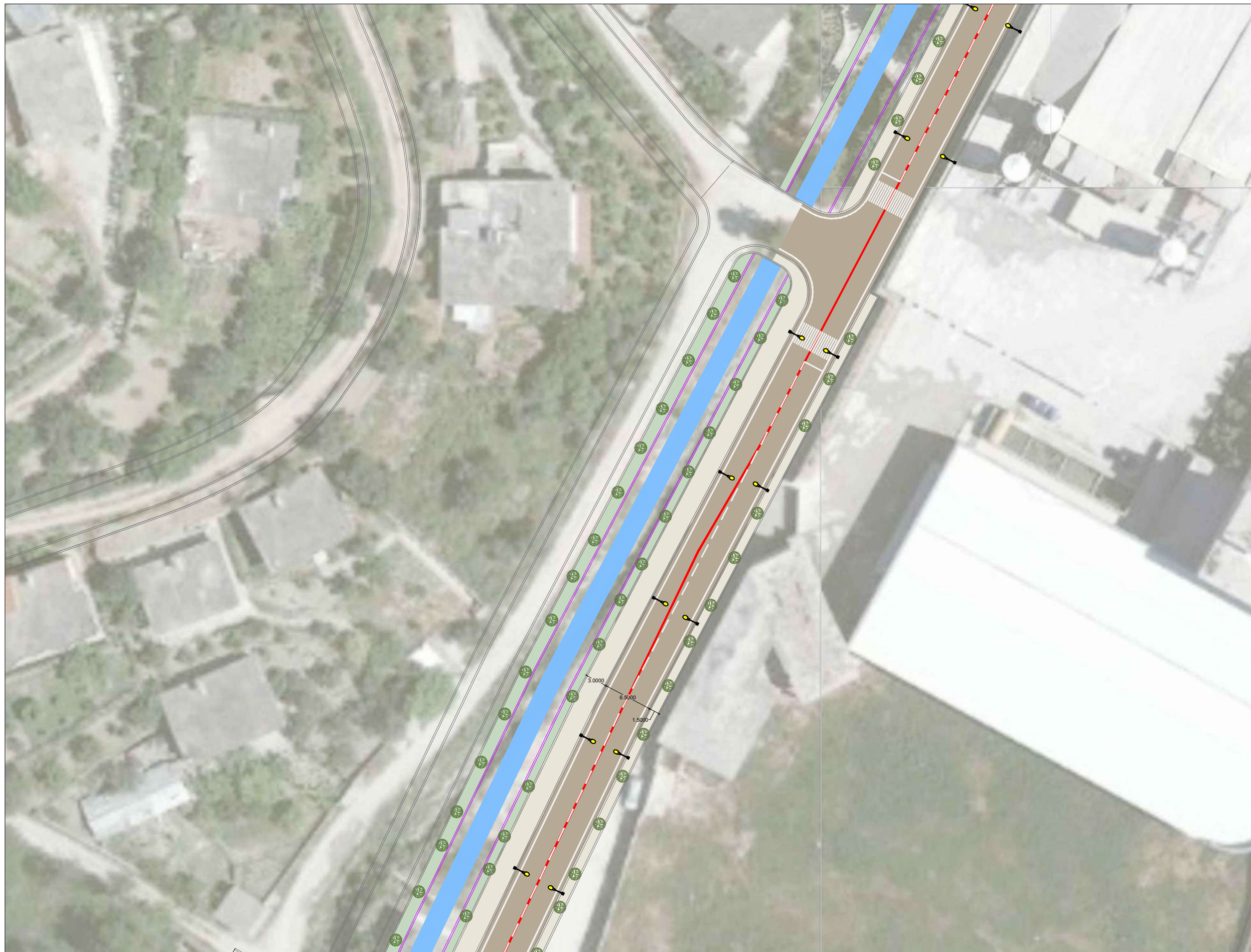

Punoi:
Urb Erlind Kapaj
Drejtor:
Ark Klaudio Mehmetaj



BASHKIA VLORË

DREJTORIA E
PLANIFIKIMIT DHE
KONTROLLIT TË
ZHVILLIMIT

PROJEKT: RIKUALIFIKIM I RRUGËS TE FABRIKA E ÇIMENTOS LOT 1
SH 1:500

VLORE 2024

A-19

PLANIMETRI E RRUGËS "EDUARD LIR"

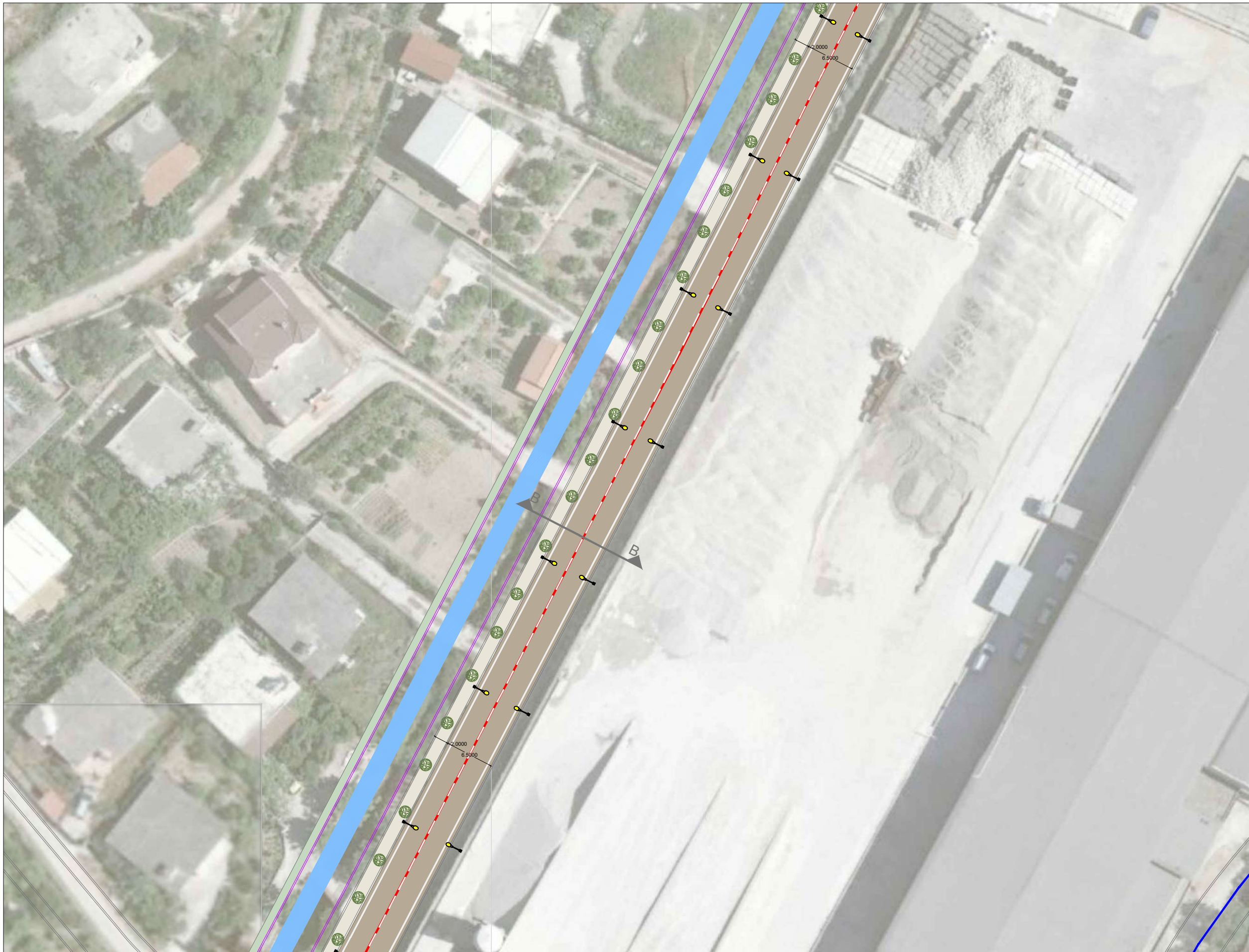

Punoi:
Urb Erlind Kapaj
Drejtor:
Ark Klaudio Mehmetaj



BASHKIA VLORË

DREJTORIA E
PLANIFIKIMIT DHE
KONTROLLIT TË
ZHVILLIMIT

PROJEKT: RIKUALIFIKIM I RRUGËS TE FABRIKA E ÇIMENTOS LOT 1
SH 1:500

VLORE 2024

PLANIMETRI E RRUGËS "EDUARD LIR"

A-20

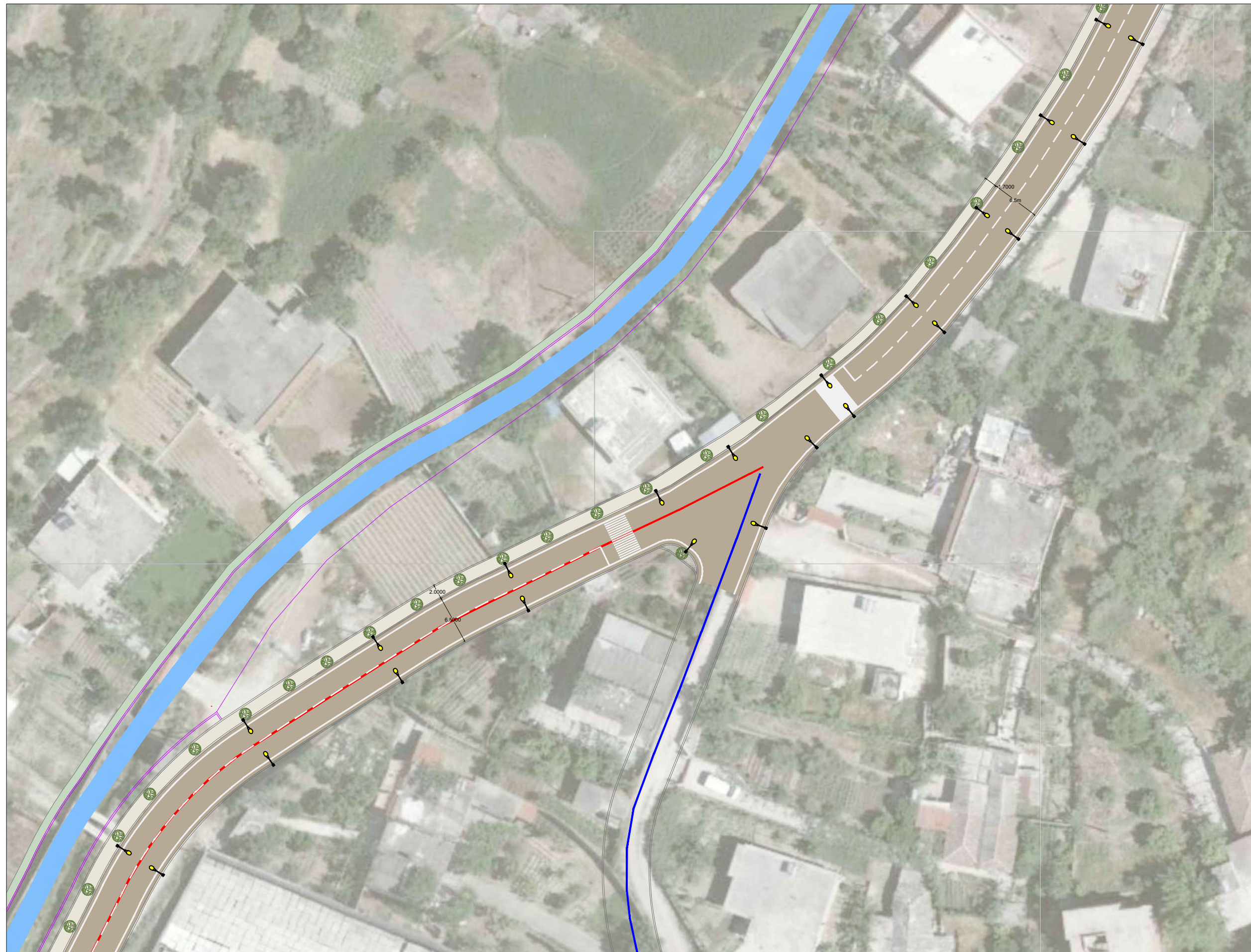

Punoi:
Urb Erlind Kapaj
Drejtor:
Ark Klaudio Mehmetaj



BASHKIA VLORE

DREJTORIA E
PLANIFIKIMIT DHE
KONTROLLIT TË
ZHVILLIMIT

PROJEKT: RIKUALIFIKIM I RRUGËS TE FABRIKA E ÇIMENTOS LOT 1
SH 1:500

VLORE 2024

A-21

PLANIMETRI E RRUGËS "EDUARD LIR"



Punoi:
Urb Erlind Kapaj
Ark Klaudio Mehmetaj



BASHKIA VLORË

DREJTORIA E
PLANIFIKIMIT DHE
KONTROLLIT TË
ZHVILLIMIT

PROJEKT: RIKUALIFIKIM I RRUGËS TE FABRIKA E ÇIMENTOS LOT 1
SH 1:500

VLORE 2024

A-22

PLANIMETRI E RRUGËS "EDUARD LIR"



Punoi:
Urb Erlind Kapaj
Drejtor:
Ark Klaudio Mehmetaj



BASHKIA VLORË

DREJTORIA E
PLANIFIKIMIT DHE
KONTROLLIT TË
ZHVILLIMIT

PROJEKT: RIKUALIFIKIM I RRUGËS TE FABRIKA E ÇIMENTOS LOT 1
SH 1:500

VLORE 2024

PLANIMETRI E RRUGËS "EDUARD LIR"

A-23



Punoi:
Urb Erlind Kapaj
Drejtor:
Ark Klaudio Mehmetaj



BASHKIA VLORE

DREJTORIA E
PLANIFIKIMIT DHE
KONTROLLIT TË
ZHVILLIMIT

PROJEKT: RIKUALIFIKIM I RRUGËS TE FABRIKA E ÇIMENTOS LOT 1
SH 1:500

VLORE 2024

PLANIMETRI E RRUGËS "EDUARD LIR"

A-24

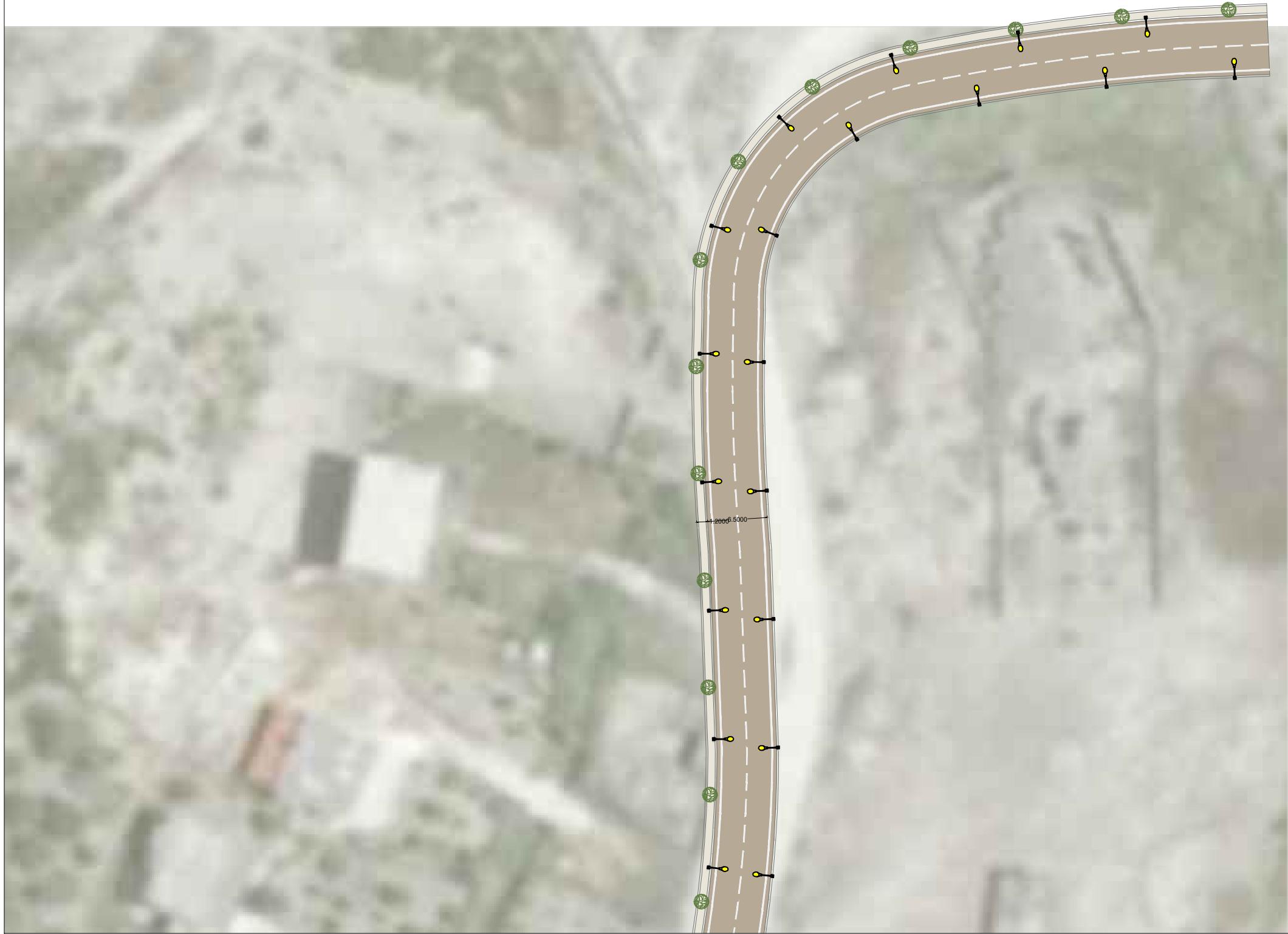

Punoi:
Urb Erlind Kapaj
Drejtor:
Ark Klaudio Mehmetaj



BASHKIA VLORË

DREJTORIA E
PLANIFIKIMIT DHE
KONTROLLIT TË
ZHVILLIMIT

PROJEKT: RIKUALIFIKIM I RRUGËS TE FABRIKA E ÇIMENTOS LOT 1
SH 1:500

VLORE 2024

PLANIMETRI E RRUGËS "EDUARD LIR"

A-25

Seksion A-A i rrugës Eduart Ilir

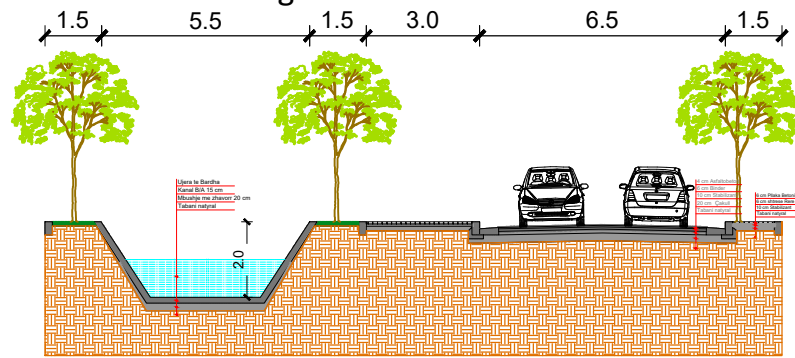

Seksion B-B i rrugës Eduart Ilir

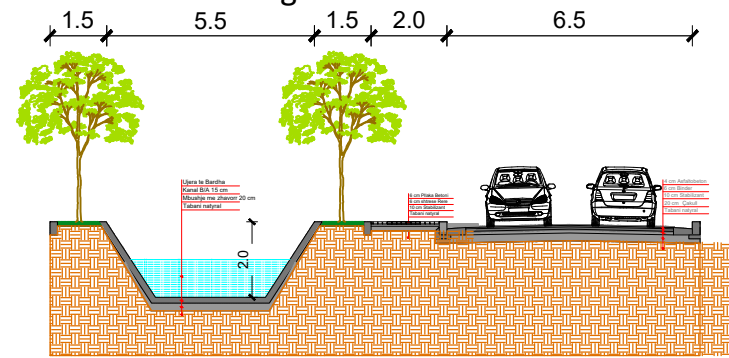

Seksion C-C i rrugës Eduart Ilir

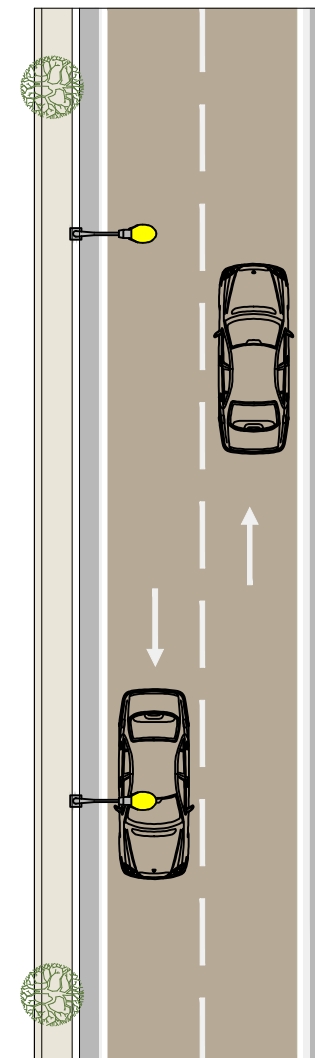
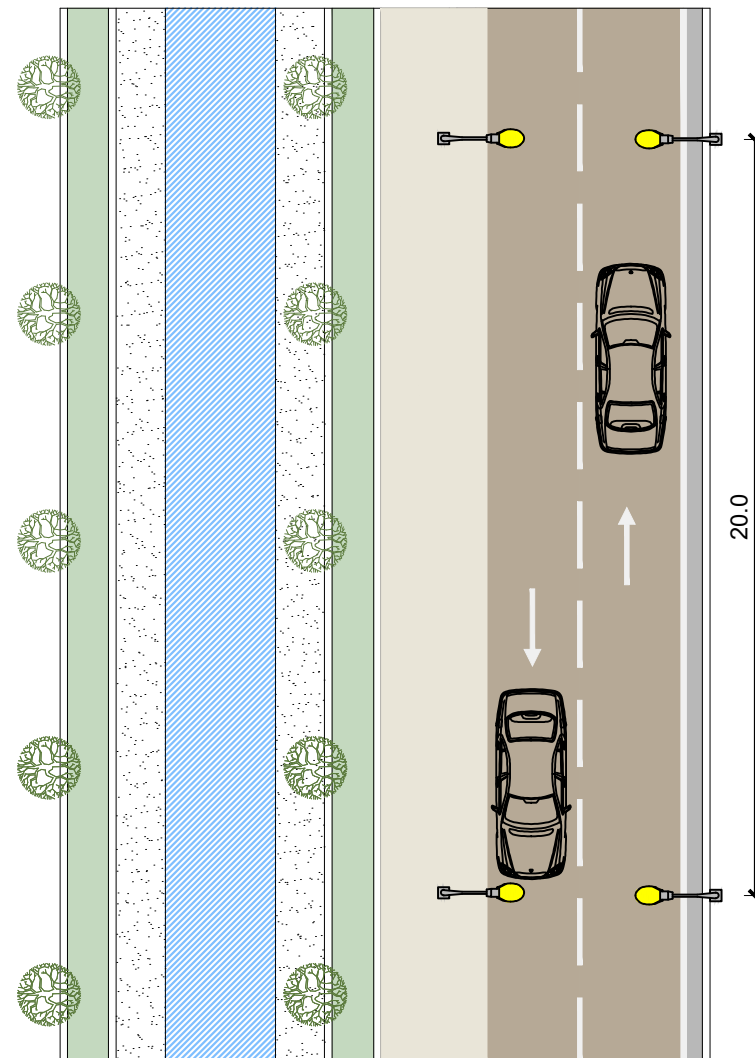
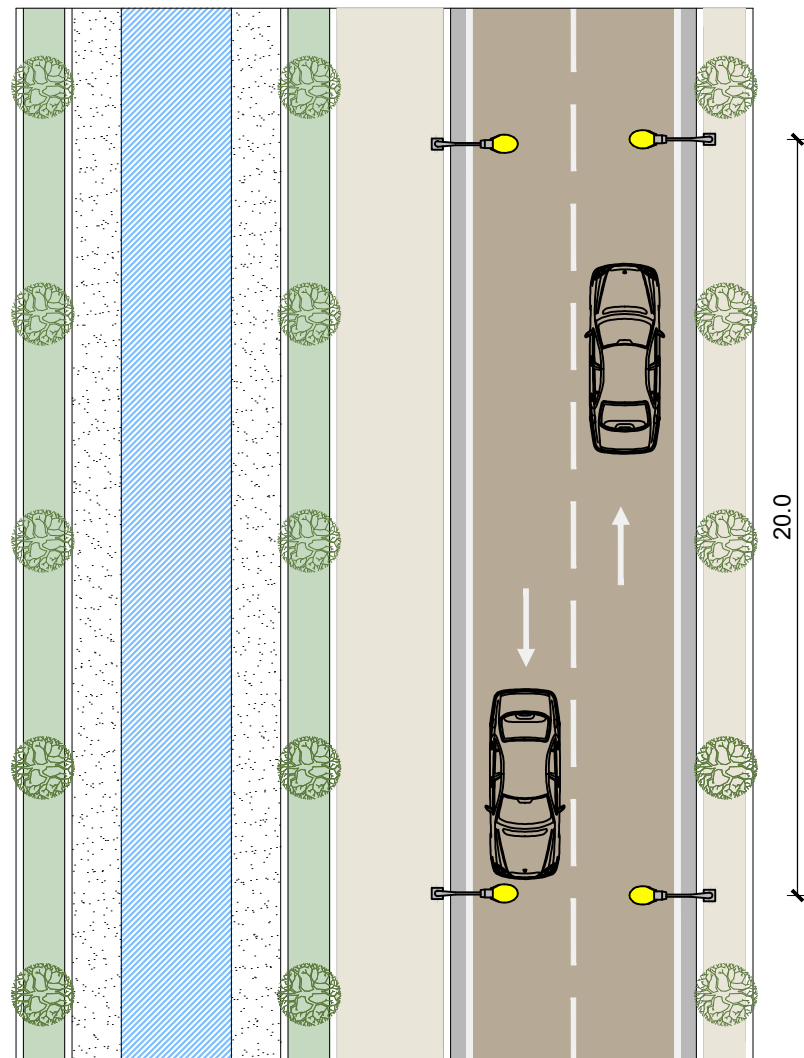
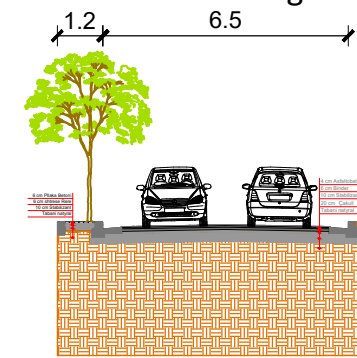

Punoi:
Urb Erlind Kapaj
Drejtor:
Ark Klaudio Mehmetaj



BASHKIA VLORE

DREJTORIA E
PLANIFIKIMIT DHE
KONTROLLIT TË
ZHVILLIMIT

DETAJ TROTUARI

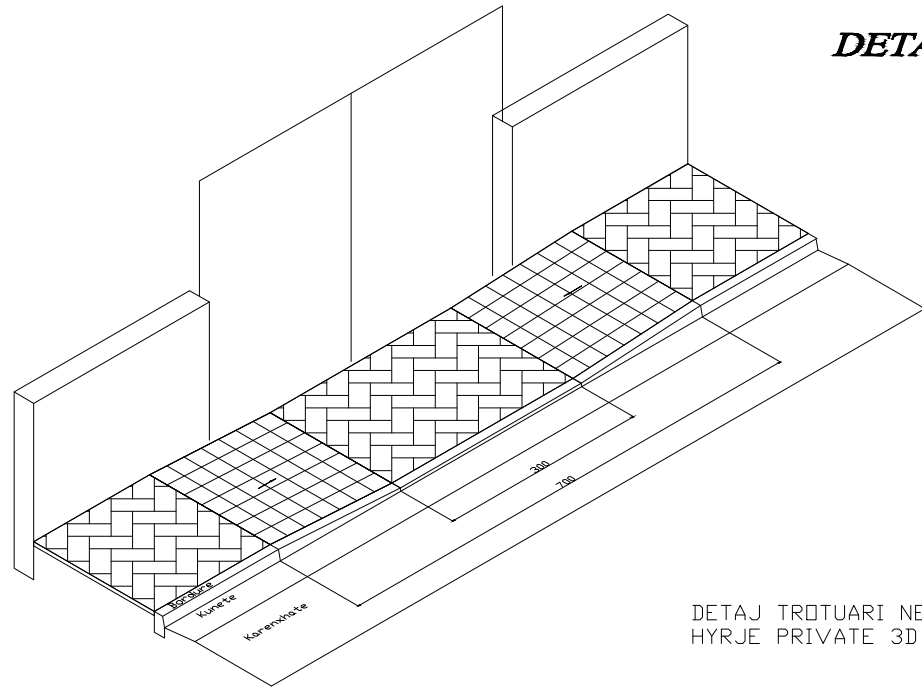

DETAJ TROTUARI NE HYRJE PRIVATE 3D

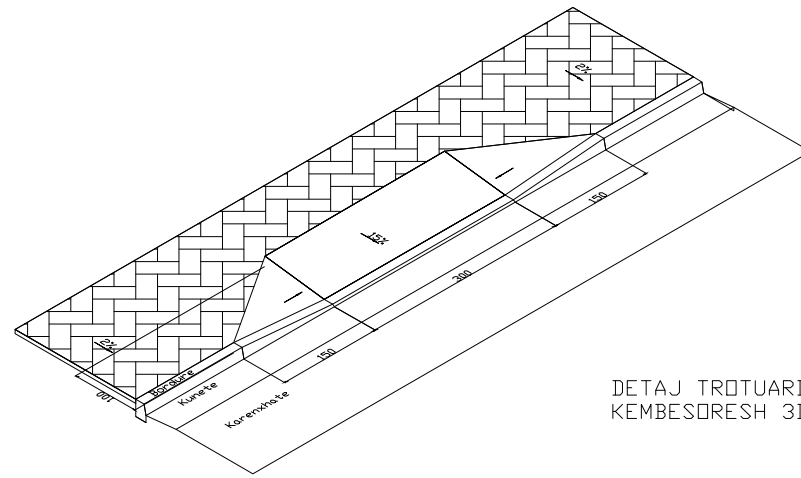

DETAJ TROTUARI NE VENDKALIM KEMBESDRESH 3D

PAMJE BALLORE

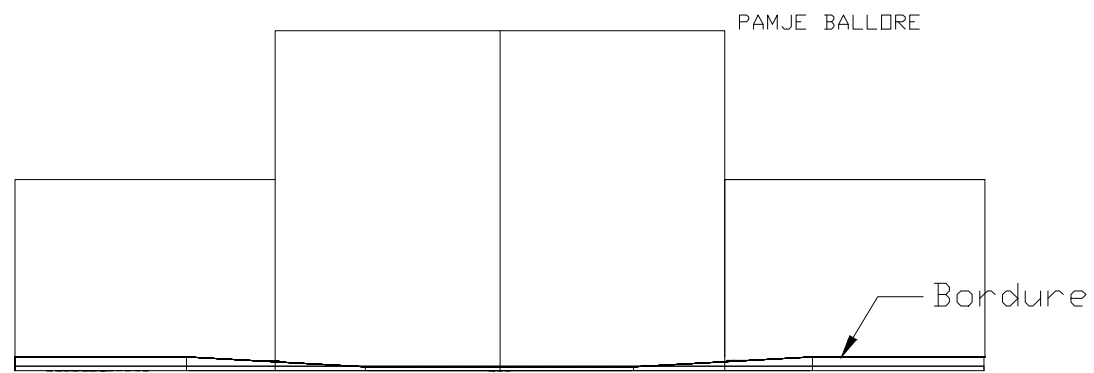

PAMJE BALLORE

PLAN

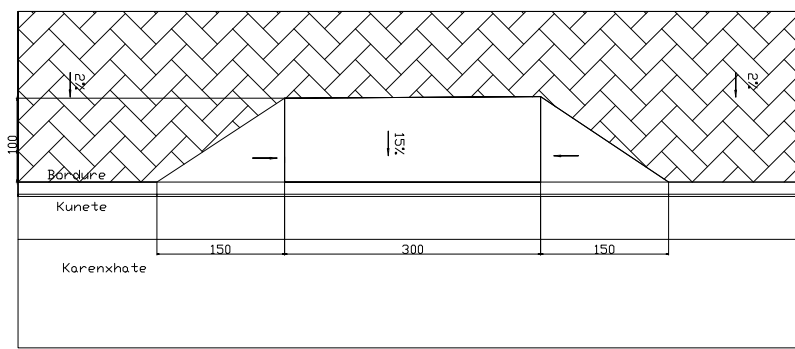
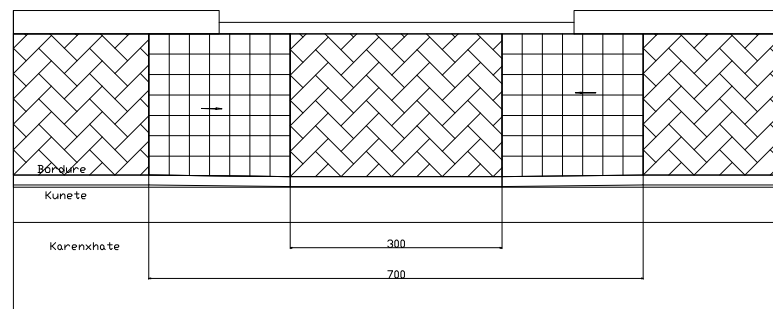

PLAN

Punoi:
Urb Erlind Kapaj
Drejtor:
Ark Klaudio Mehmetaj



BASHKIA VLORE

DREJTORIA E
PLANIFIKIMIT DHE
KONTROLLIT TË
ZHVILLIMIT

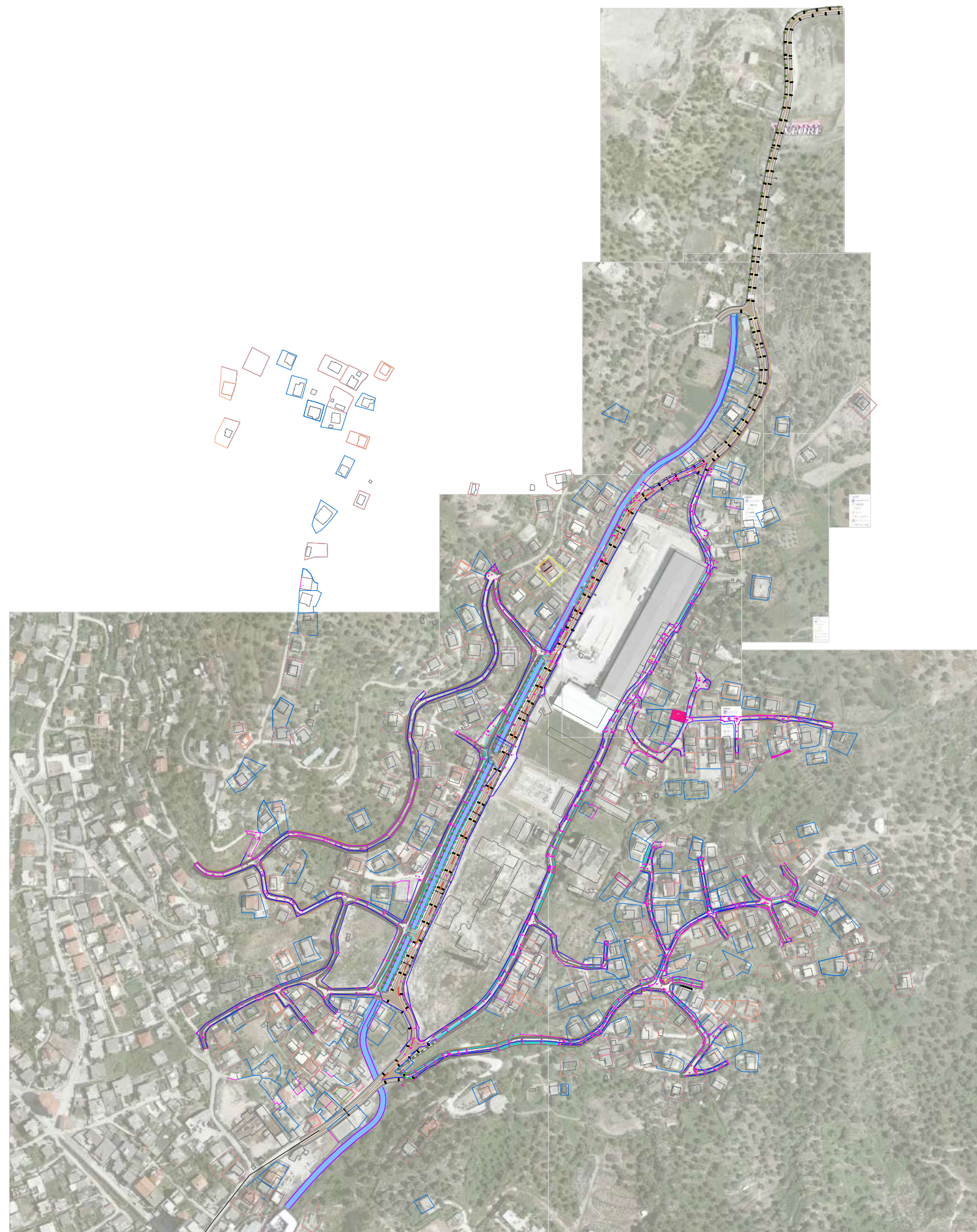

Punoi:
Urb Erlind Kapaj
Drejtör:
Ark Klaudio Mehmetaj



BASHKIA VLORË

DREJTORIA E
PLANIFIKIMIT DHE
KONTROLLIT TË
ZHVILLIMIT

PROJEKT: RIKUALIFIKIM I RRUGËS TE FABRIKA E ÇIMENTOS LOT 1

VLORE 2024

PLANIMETRIA E PRISHJEVE

A-28



Punoi:
Urb Erlind Kapaj
Drejtore:
Ark Klaudio Mehmetaj



BASHKIA VLORE

DREJTORIA E
PLANIFIKIMIT DHE
KONTROLLIT TË
ZHVILLIMIT

PROJEKT: RIKUALIFIKIM I RRUGËS TE FABRIKA E ÇIMENTOS LOT 1
Sh 1:100

PLANIMETRIA E PRISHJEVE

VLORE 2024

A-29

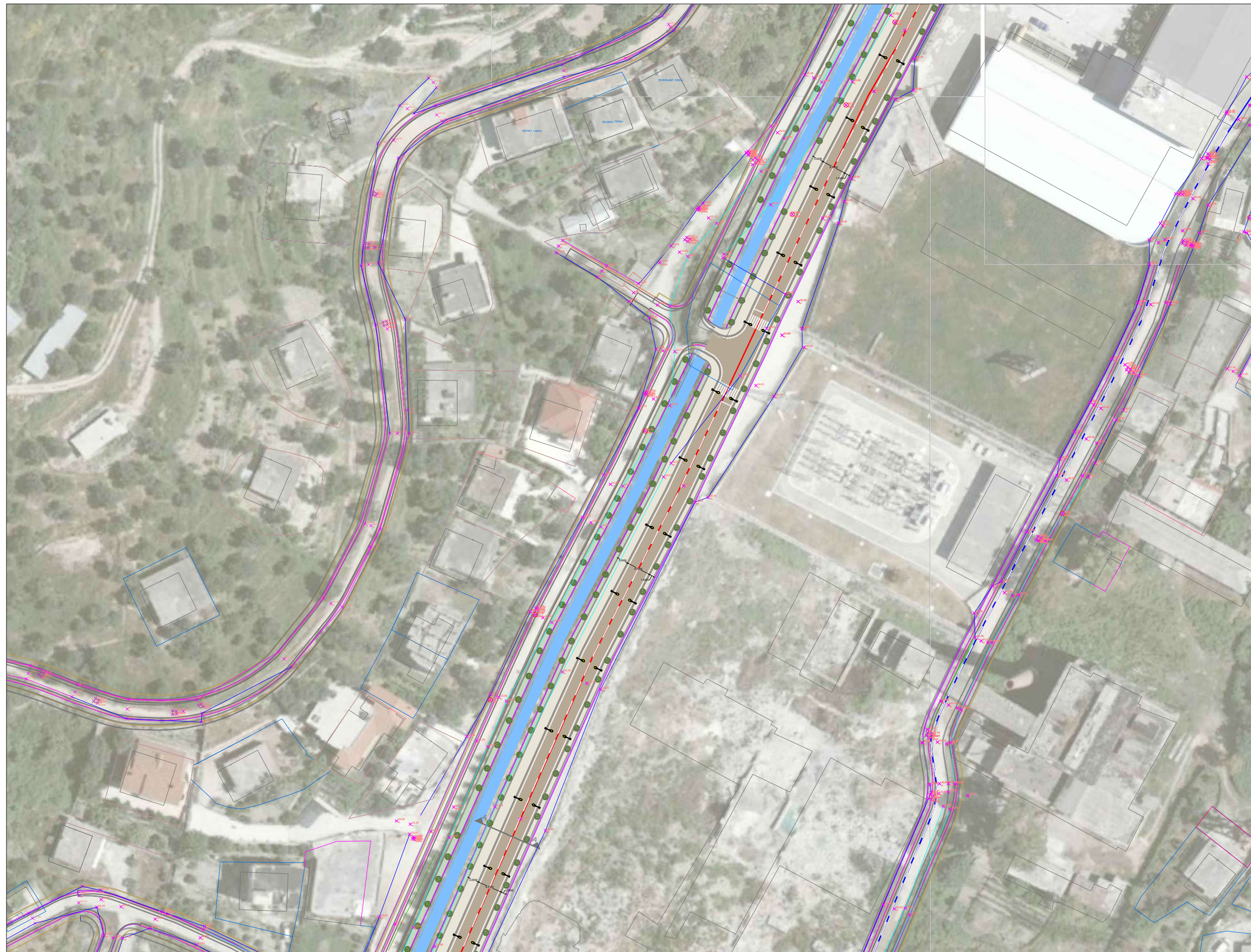

Punoi:
Urb Erlind Kapaj
Drejtör:
Ark Klaudio Mehmetaj



BASHKIA VLORE

DREJTORIA E
PLANIFIKIMIT DHE
KONTROLLIT TË
ZHVILLIMIT

PROJEKT: RIKUALIFIKIM I RRUGËS TE FABRIKA E ÇIMENTOS LOT 1
Sh 1:100

PLANIMETRIA E PRISHJEVE

VLORE 2024

A-30

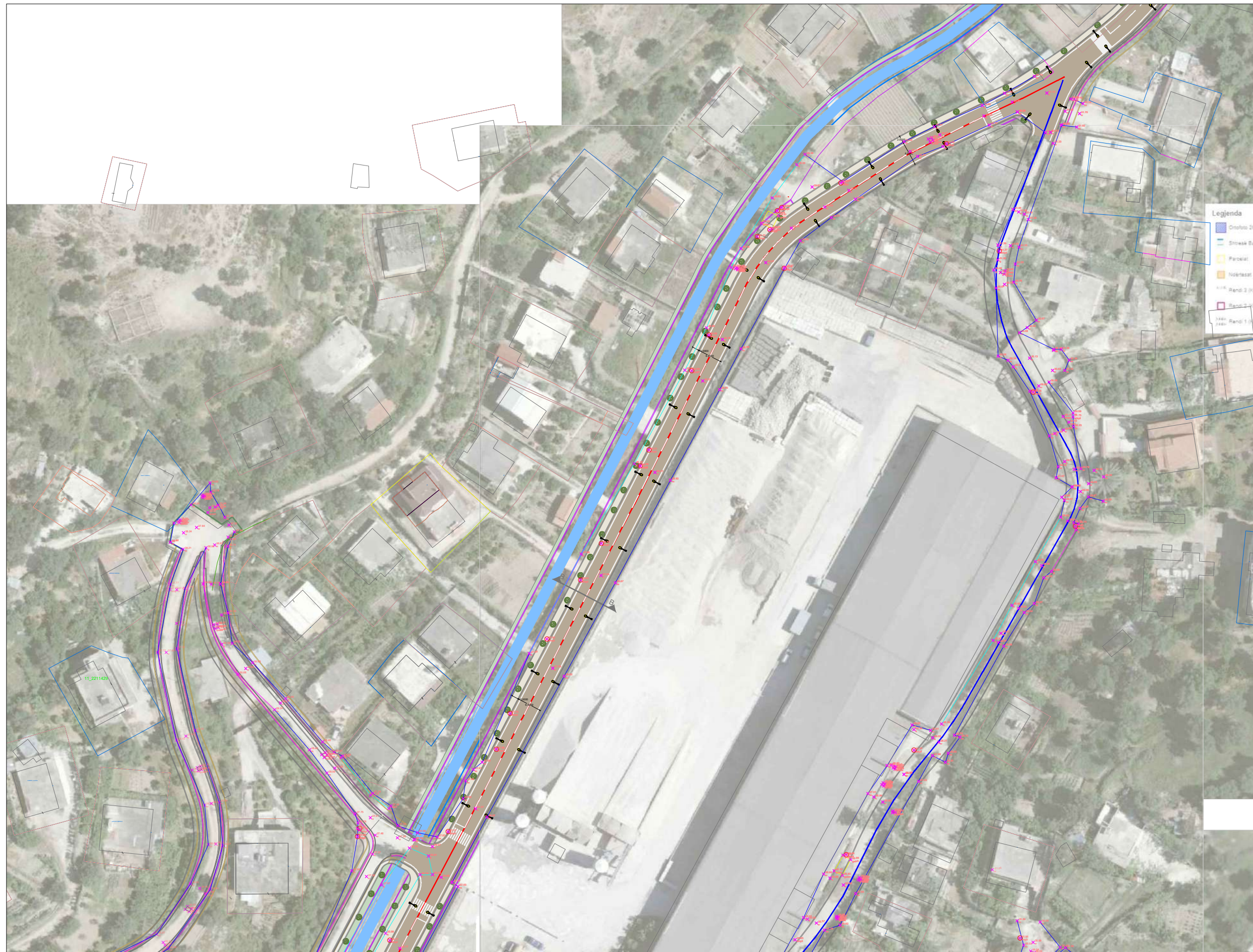

- Legjenda**
- Oroloji 2016
 - Sheshtja Baza
 - Parcelat
 - Nivellat
 - Rendi 3 (fut)
 - Rendi 2 (fut)
 - Rendi 1 (fut)

Punoi:
 Urb Erlind Kapaj
 Drejtor:
 Ark Klaudio Mehmetaj

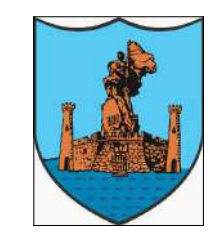

BASHKIA VLORE

DREJTORIA E
 PLANIFIKIMIT DHE
 KONTROLLIT TË
 ZHVILLIMIT

PROJEKT: RIKUALIFIKIM I RRUGËS TE FABRIKA E ÇIMENTOS LOT 1
 Sh 1:100

PLANIMETRIA E PRISHJEVE

VLORE 2024



Punoi:
Urb Erlind Kapaj
Drejtor:
Ark Klaudio Mehmetaj



BASHKIA VLORË

DREJTORIA E
PLANIFIKIMIT DHE
KONTROLLIT TË
ZHVILLIMIT

PROJEKT: RIKUALIFIKIM I RRUGËS TE FABRIKA E ÇIMENTOS LOT 1
Sh 1:100

PLANIMETRIA E PRISHJEVE

VLORE 2024

A-32