

PROJEKTI FOTOVOLTAIK

OBJEKTI: "Info Kulla godina Nr.2"

PROGRAMI: "Projektimi i Sistemit Fotovoltaik 15.64 kWp"

MBESHTETES: IPA II Cross Border Cooperation Programme for Albania- Kosovo

PERFITUES: Bashkia Mirditë



ZENIT&CO

Tiranë 2026



BASHKIA MIRDITE

PLANIMETRI E PËRGJITHËSHME E OBJEKTIT

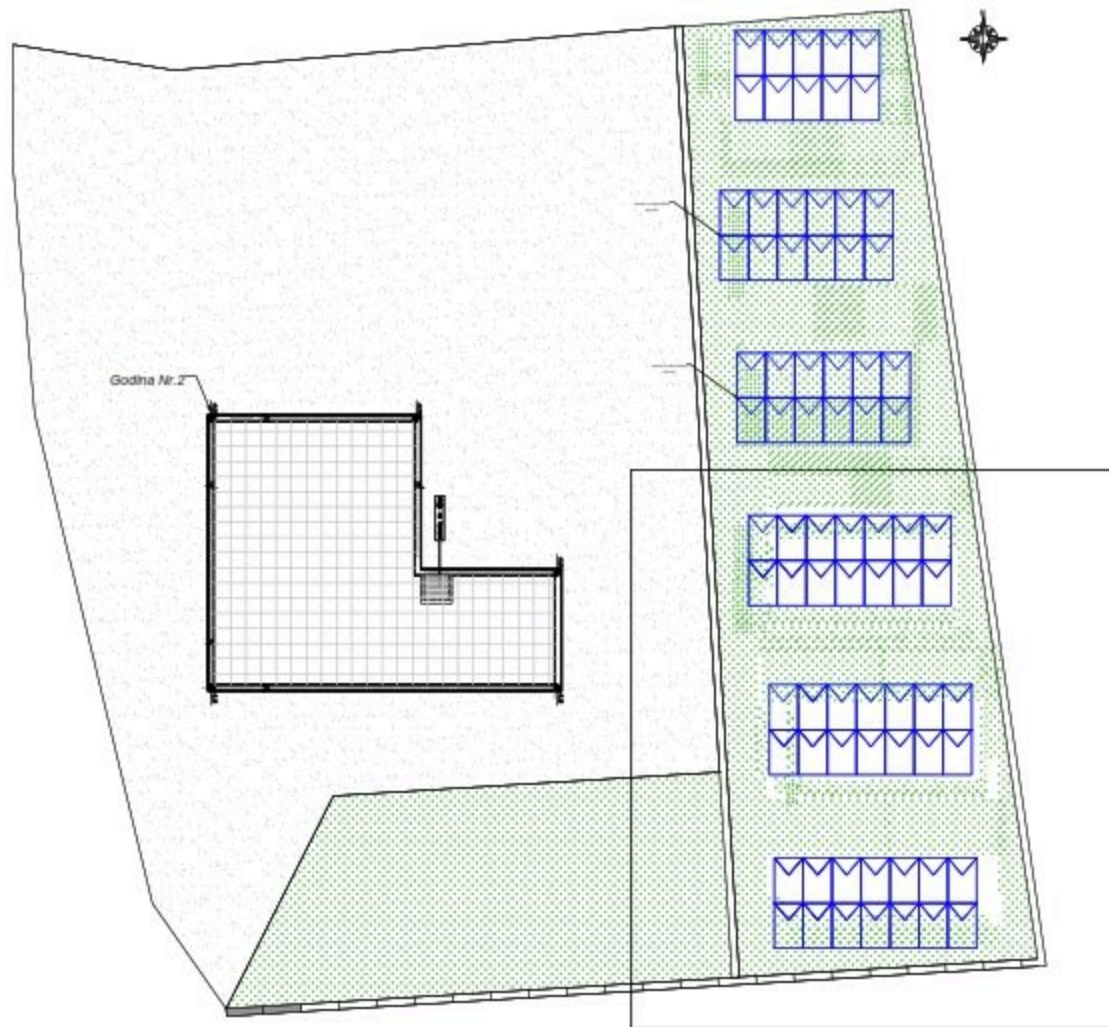

PROJEKTI: 13.007



BASHKIA E MIRDITËS

KONSAJLIERI / CONSULTANT



ZENIT/CC
Z. Ahmeti, T. Topi, B. Topi
Z. Ahmeti@zenitcc.com

SHKURIME / TECHNICAL NOTES

PROJEKTI / PROJECT NAME

**"INSTALIMI I SISTEMIT
FOTOVOLTAIK"**

ZONA / LOCATION

BASHKIA E MIRDITËS

FASHA E PROJEKTI / PROJECT PHASE

**PROJEKT ZBATIM /
IMPLEMENTATION DESIGN**

PROJEKTI ARCHITETUROR / ARCHITECTURAL DESIGN

Ark. Rigonda MYDRELLARI

06.11.2022

06.11.2022

PROJEKTI INZHINIEROR / STRUCTURAL DESIGN

Ing. Rishap TAPDA

06.11.2022

PROJEKTI NIVELOR / MEASUREMENT AND COORDINATES

Ing. Ardit PEPI

06.11.2022

PROJEKTI INZHINIEROR / MECHANICAL DESIGN

Ing. Merita MESHU

06.11.2022

PROJEKTI INZHINIEROR / ELECTRICAL DESIGN

Ing. Kristaq ZHURA

06.11.2022

SHKURIME / LIST OF DESIGN

PLANIMETRI E PËRGJITHËSHME

SHKALLA

1:1000

SHKURTY 2022

SHKURTY / SIGNATURE

A-01

VLAKA / STAMP

PLANVENDOSJA E MODULEVE

Sistemi fotovoltaik i
godinës Nr.2

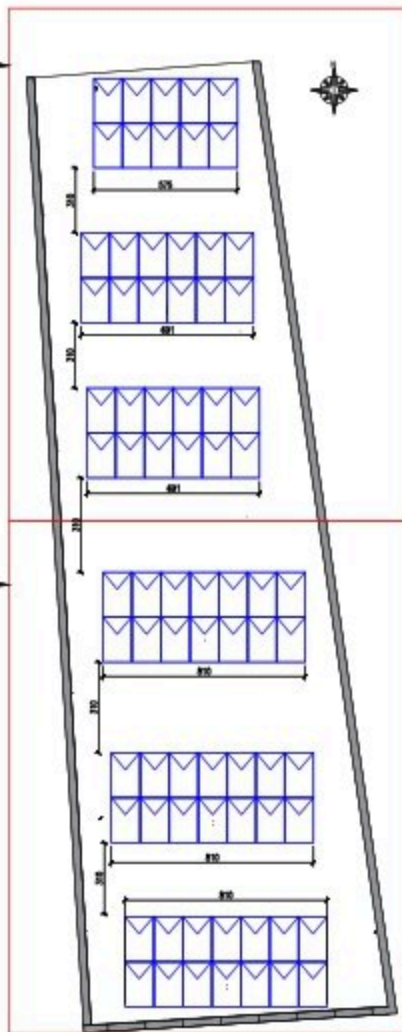

Sistemi fotovoltaik i
Info Kullës

Sistemi fotovoltaik i
godinës Nr.2

Sistemi fotovoltaik i
Info Kullës



BASHKIA E MIRDITËS

KONSOLEJTI / CONSULTANT



SHËRBIMET / SERVICES / TECHNICAL NOTES

Sipërfaqja e Sheshit 2023 m²
Sipërfaqja e gjatësisë së shkollës 620.5 m²
Sipërfaqja e lloj gjëra perandron 1207 m²
Sipërfaqja e lloj gjëra perpara shkollës 940 m²

PROJECT / PROJECT NAME

"INSTALIMI I SISTEMIT
FOTOVOLTAIK"

FORM / LOCATION

BASHKIA E MIRDITËS

PHASE / PROJECT / PROJECT PHASE

PROJEKT ZBATIM
IMPLEMENTATION OF DESIGN

PROJECT ARCHITECTURE / ARCHITECTURAL DESIGN

Ark. Rajmonda MYDRELLARI

PHASE / PROJECT / PROJECT PHASE

Ing. Rishap TAPIDA

PHASE / PROJECT / PROJECT PHASE

Ing. Arqipe PEPI

PHASE / PROJECT / PROJECT PHASE

Ing. Merita MEGRI

PHASE / PROJECT / PROJECT PHASE

Ing. Kristaq ZHURPA

PHASE / PROJECT / PROJECT PHASE

PHASE / PROJECT / PROJECT PHASE

PHASE / PROJECT / PROJECT PHASE

PHASE / PROJECT / PROJECT PHASE

PHASE / PROJECT / PROJECT PHASE

PHASE / PROJECT / PROJECT PHASE

PHASE / PROJECT / PROJECT PHASE

PHASE / PROJECT / PROJECT PHASE

PHASE / PROJECT / PROJECT PHASE

PHASE / PROJECT / PROJECT PHASE

PHASE / PROJECT / PROJECT PHASE

PHASE / PROJECT / PROJECT PHASE

PHASE / PROJECT / PROJECT PHASE

PHASE / PROJECT / PROJECT PHASE

PHASE / PROJECT / PROJECT PHASE

PHASE / PROJECT / PROJECT PHASE

PHASE / PROJECT / PROJECT PHASE

PHASE / PROJECT / PROJECT PHASE

PHASE / PROJECT / PROJECT PHASE

PHASE / PROJECT / PROJECT PHASE

PHASE / PROJECT / PROJECT PHASE

PHASE / PROJECT / PROJECT PHASE

PHASE / PROJECT / PROJECT PHASE

PHASE / PROJECT / PROJECT PHASE

SHKALLA

SCHEMATIC

SHKURT 2025

SCALE / STAMP

SHKURT / SHORT

SCALE / STAMP

SCALE / STAMP

SCALE / STAMP

SCALE / STAMP

SCALE / STAMP

SCALE / STAMP

SCALE / STAMP

SCALE / STAMP

SCALE / STAMP

SCALE / STAMP

SCALE / STAMP

A-02

PLANVENDOSJA E MODULEVE

Sistemi fotovoltaik i
godinës Nr.2

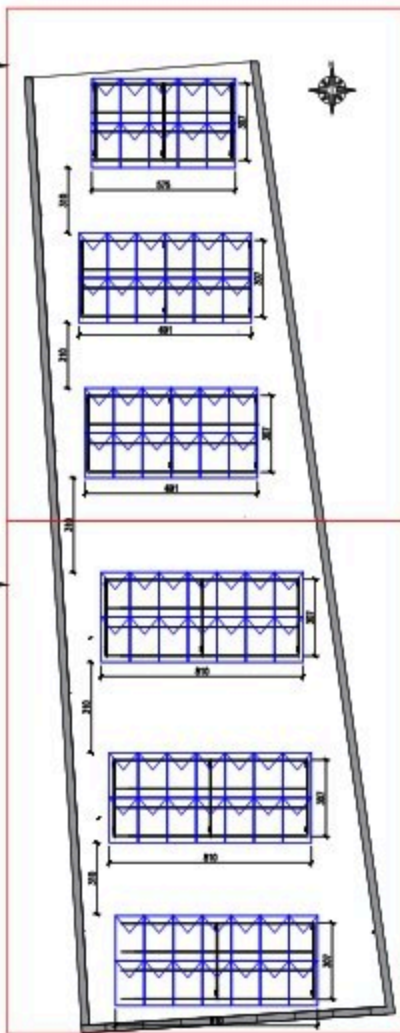

Sistemi fotovoltaik i
Info Kullës

Sistemi fotovoltaik i
godinës Nr.2

Sistemi fotovoltaik i
Info Kullës



BASHKIA E MIRDITËS

KONKALISTI / CONSULTANT



SHKURTIM / TECHNICAL NOTES

Sipërfaqja e Sheshit 2023 m²
Sipërfaqja e gjatësisë së shkollës 620.5 m²
Sipërfaqja e lloj gjëra perendimore 1207 m²
Sipërfaqja e lloj gjëra perpara shkollës 940 m²

PROJECT / PROJECT NAME

"INSTALIMI I SISTEMIT
FOTOVOLTAIK"

FORM / LOCATION

BASHKIA E MIRDITËS

PHASE / PROJECT / PROJECT PHASE

PROJEKT ZBATIM
IMPLEMENTATION OF DESIGN

PROJECT ARCHITECTURE / ARCHITECTURAL DESIGN

Ark. Rajmonda MYDRELLARI

06.11.2023

06.11.2023

PROJECT STRUCTURE / STRUCTURAL DESIGN

Ing. Rishap TAPIDA

06.11.2023

PROJECT MECHANICAL / MECHANICAL DESIGN

Ing. Arqipe PEPI

06.11.2023

PROJECT ELECTRICAL / ELECTRICAL DESIGN

Ing. Merita MEGYI

06.11.2023

PROJECT PLANNING / PLANNING DESIGN

Ing. Kristaq ZHURPA

06.11.2023

PROJECT / PROJECT / FIELD OF DESIGN

PLANVENDOSJA E MODULEVE

SHKALLA

1:1000

SHKURTY 2023

REVIZIONI / REVISIONS

A-03

VLKA / STAMP

PLANVENDOSJA E MODULEVE

Sistemi fotovoltaik i
godinës Nr.2

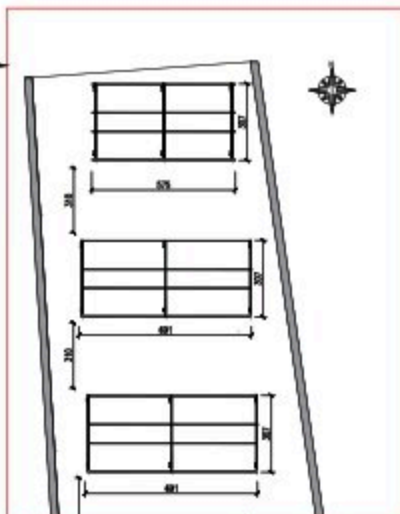

Sistemi fotovoltaik i
Info Kullës

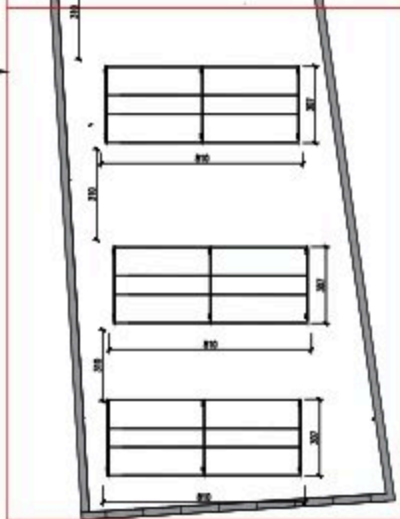

Sistemi fotovoltaik i
godinës Nr.2

Sistemi fotovoltaik i
Info Kullës



REPUBLIKA SHQIPTARE

KONSTRUKTIV / CONSULTANT



SHKËMBI / TECHNICAL NOTES

Sipërfaqja e Shprehë 2023 m²
Sipërfaqja e gjatës së shkollës 620.5 m²
Sipërfaqja e lloj gjëra perandron 1207 m²
Sipërfaqja e lloj gjëra përpara shkollës 940 m²

PROJECT / PROJECT NAME

"INSTALIMI I SISTEMIT
FOTOVOLTAIK"

ZONE / LOCATION

ZASHKËIA MRODITE

PHASE / PROJECT / PROJECT PHASE

PROJEKT ZBATIM
IMPLEMENTATION OF DESIGN

PROJECT ARCHITECTURE / ARCHITECTURAL DESIGN

Ark. Rajmonda MYDRELLARI

PROJEKTI ARCHITECTURE / ARCHITECTURAL DESIGN

Ing. Rashap TAPIDA

PROJEKTI INGENIERIA / STRUCTURAL DESIGN

Ing. Arqipe PEJTI

PROJEKTI INGENIERIA / MECHANICAL DESIGN

Ing. Merita MEGYI

PROJEKTI INGENIERIA / ELECTRICAL DESIGN

Ing. Kristaq ZHURPA

PROJEKTI INGENIERIA / FIELD OF DESIGN

PLANVENDOSJA E MODULEVE

SHKALLA

1:1000

SHKURT 2020

SHKURT / SHORT

A-04

VLKA / STAMP

PLANVENDOSJA E MODULEVE

Sistemi fotovoltaik i
godinës Nr.2

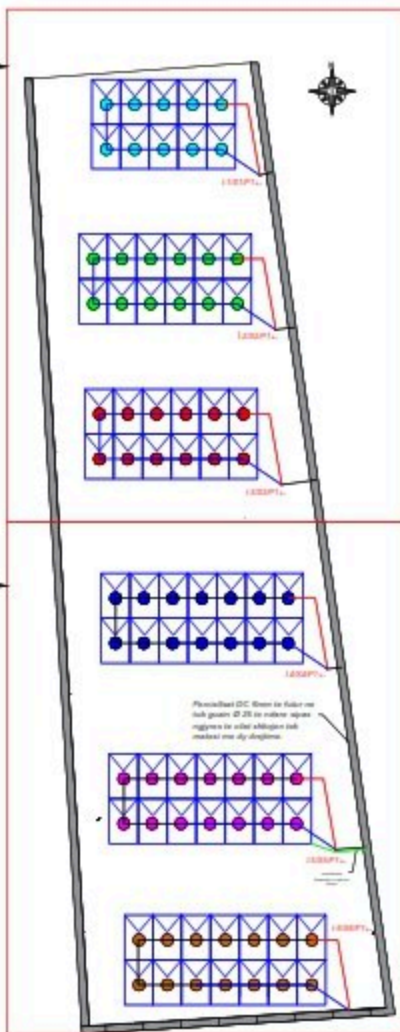

Sistemi fotovoltaik i
Info Kullës

Sistemi fotovoltaik i
godinës Nr.2

Sistemi fotovoltaik i
Info Kullës

Stringu 1,2,3 përbëhet nga 10,12,12 module fotovoltaike secili me fuqi nominale 450 W secili, me fuqi totale të instaluar 15,64 kWp. Këtu shtrihet dhe fi bashkëngjitur inverterit nr. 2, me fuqi 15 kVA, i cili i përkulit godinës nr. 2.

Stringu 4,5,6, secili i përbëhet nga 14 module me fuqi 450 W, me fuqi totale prej 13,32 kWp, dhe fi bashkëngjitur inverterit nr. 1, me fuqi20kVA, i cili i përkulit godinës së Info Kullës



BASHKIA E RRETHIT TË PËRFQËSUA

KONSTRUKTIV / CONSULTANT



SHKURORT / TECHNICAL NOTES

Sipërfaqja e Shprehjes 2023 m²
Sipërfaqja e gjatësisë së shkëlqimit 620.5 m²
Sipërfaqja e llojit të përdorimit 1207 m²
Sipërfaqja e llojit të përdorimit shkëlqimit 940 m²

PROJECT / PROJECT NAME

"INSTALIMI I SISTEMIT FOTOVOLTAIK"

ZONE / LOCATION

BASHKIA E RRETHIT TË PËRFQËSUA

PHASE / PROJECT / PROJECT NAME

PROJEKT ZBATIM / IMPLEMENTATION OF DESIGN

PROJECT ARCHITECTURE / ARCHITECTURAL DESIGN

Ark. Rajmonda MYDRELLARI

06.11.2023

06.11.2023

PROJECT STRUCTURE / STRUCTURAL DESIGN

Ing. Rishap TAPIDA

06.11.2023

PROJECT MECHANICAL / MECHANICAL DESIGN

Ing. Ardit PEPI

06.11.2023

PROJECT ELECTRICAL / ELECTRICAL DESIGN

Ing. Merita MEGRI

06.11.2023

PROJECT ELECTRICAL / ELECTRICAL DESIGN

Ing. Kristaq ZHURPA

06.11.2023

PHASE / PHASE / TYPE OF DESIGN

PLANVENDOSJA E MODULEVE

SHKILLA

06.11.2023

06.11.2023

REVIZIONI / REVISIONS

A-05

VLAK / STAMP

SKEMA ELEKTRIKE AC

PROJEKTI - 12897



BAŠKIJA MERIŠTE, PERIPIŠTICE

CONSULTANT

ZENITACCI
CONSULTING
d.o.o.
Bosanska Tur (b) 19. aprila 1000
t: 051 4411111
e: info@zenitaccci.com

DRUGIŠTVO: TEHNIŠKI / TECHNICAL NOTES

PROJECT / PROJECT NAME

"INSTALIMI I SISTEMIT FOTOVOLTAIK"

ZONE / LOCATION

BAŠKIJA MERIŠTE

PHASE / PROJECT / PROJECT PHASE

PROJEKT ZBATMIJ /
IMPLEMENTATION OF DESIGN

PROJECT ARCHITECTURE / ARCHITECTURAL DESIGN

Arh. Rajmond MVDINELARI
Bosna i Hercegovina
Bosna i Hercegovina

PROJECT ARCHITECTURE / STRUCTURAL DESIGN

Ing. Rascep TARDA
Bosna i Hercegovina

PROJECT ARCHITECTURE / MECHANICAL DESIGN

Ing. Anđeo PEVIĆ
Bosna i Hercegovina

PROJECT ARCHITECTURE / ELECTRICAL DESIGN

Ing. Merita MEGVIĆ
Bosna i Hercegovina

PROJECT ARCHITECTURE / ELECTRICAL DESIGN

Ing. Kristina ŽILJICA
Bosna i Hercegovina

PROJECT ARCHITECTURE / FIELD OF DESIGN

SKEMA ELEKTRIKE AC

SKEMALA

SKEMALA

SKEMALA

SKEMALA

SKEMALA

SKEMALA

A-06

SKEMA / STAMP

Skema Elektrike AC-DC Info Kulla nr 2

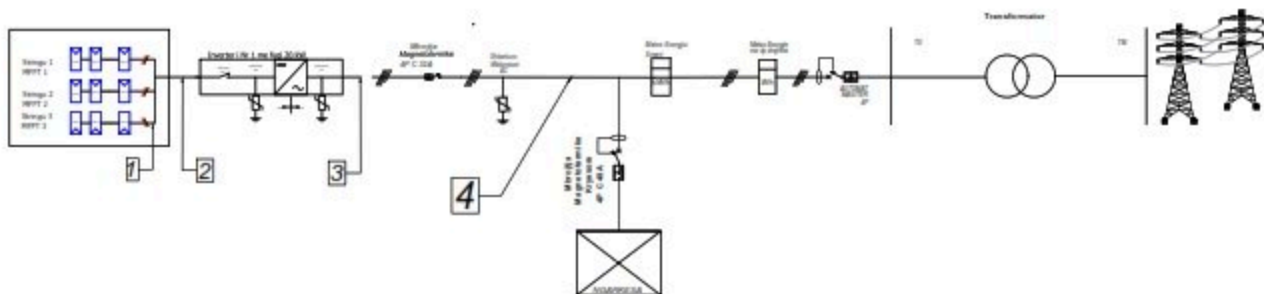

SKEMA E SISTEMIT TE MATJES

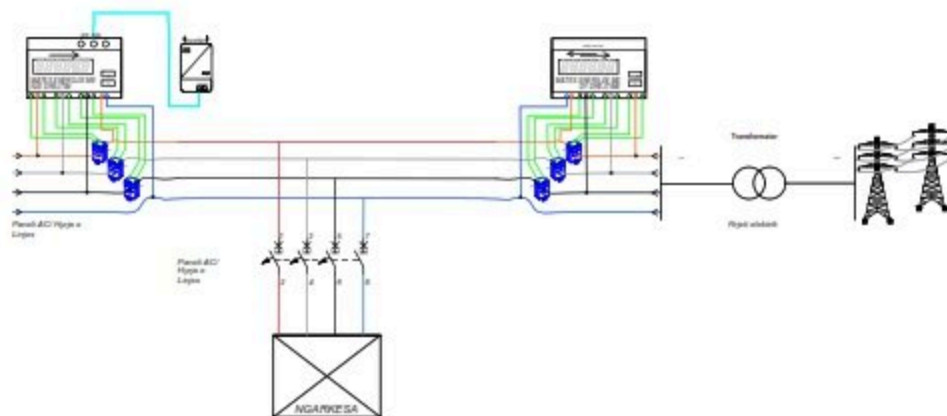

LEGJENDE	
	Inverter
	Transformator
	Shkëmbim Shpirtor
	Rrethi Shpirtor
	Main Design Legend
	Transformator 10/0.4
	Rrethi Shpirtor
	Ngarkese Objekt

PROJEKTI - 13487



BASHKIA MBRODITE

KONSULENT - KONSULANT



ZENITBCC
CONSULTING

SHKËMBIM TËRREZOR - TECHNICAL DESIGN

PROJEKTI - PROJECT NAME

"INSTALIMI I SISTEMIT
FOTOVOLTAIK"

ZONA - LOCATION

BASHKIA MBRODITE

PAGJE E PROJEKTI - PROJECT PAGE

PROJEKTI ZBATIM
IMPLEMENTATION DESIGN

PROJEKTI ARCHITETUROR - ARCHITECTURAL DESIGN

Ark. Rajmonda MYDRELLARI

Ng. 11.4.2012

Ngarkese Objekt

PROJEKTI KONSTRUKTIV - STRUCTURAL DESIGN

Ing. Rashap TAPDA

Ngarkese Objekt

PROJEKTI MASHINORIE - MEK. PROJ. AND COOLING

Ing. Arqipe PEPI

Ngarkese Objekt

PROJEKTI INZHINIERIMOR - MECHANICAL DESIGN

Ing. Merita MEGYI

Ngarkese Objekt

PROJEKTI ELEKTRIK - ELECTRICAL DESIGN

Ing. Kristaq ZHURPA

Ngarkese Objekt

PROJEKTI MASHINORIE - MEK. PROJ. AND COOLING

Ngarkese Objekt

SHKALLA

1:1

SHKURT 2008

SHKËMBIM TËRREZOR

A-07

VLAK / STAMP

SKEMA ELEKTRIKE AC



BASHKIA MIRDITE, PESHKËPISË

CONSULTANT



DESCRIPTION: TECHNICAL DRAWING

PROJECT: PROJECT NAME

"INSTALIMI I SISTEMIT FOTOVOLTAIK"

JOB: LOCATION

BASHKIA MIRDITE

PAGE: PROJECT / PROJECT PAGE

PROJEKT ZBATIM /
IMPLEMENTATION DESIGN

PROJECT ARCHITECTURE - ARCHITECTURAL DESIGN

Ark. Rajmonda MYDRELLARI

Rr. 19.04.1955
Bashkia Mirdite, Shqipëri

PROJECT ARCHITECTURE - STRUCTURAL DESIGN

Ing. Rashap XARDA

Rr. 19.04.1955

PROJECT ARCHITECTURE - MECHANICAL DESIGN

Ing. Ardit PEJLI

Rr. 19.04.1955

PROJECT ARCHITECTURE - ELECTRICAL DESIGN

Ing. Merita MEGJI

Rr. 19.04.1955

PROJECT ARCHITECTURE - ELECTRICAL DESIGN

Ing. Kristaq ZHURJA

Rr. 19.04.1955

PROJECT ARCHITECTURE - FIELD OF DESIGN

20000 SURFING AC

SKEMA

SCHEMATIC

SHORT CODE

REVISION / CORRECTION

A-08

SCALE / STAMP

Skema Elektrike AC-DC Info Kulla

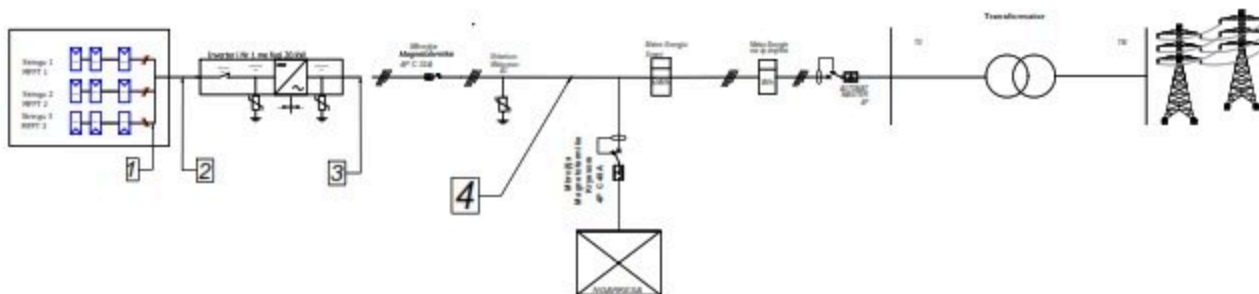

PROJEKTI FOTOVOLTAIK

OBJEKTI: "Bashkia Mirditë"

PROGRAMI: "Projektimi i Sistemit Fotovoltaik 113.62 kWp"

MBESHTETES: IPA II Cross Border Cooperation Programme for Albania- Kosovo

PERFITUES: Bashkia Mirditë



PLANIMETRI E PËRGJITHËSHME E OBJEKTEVE

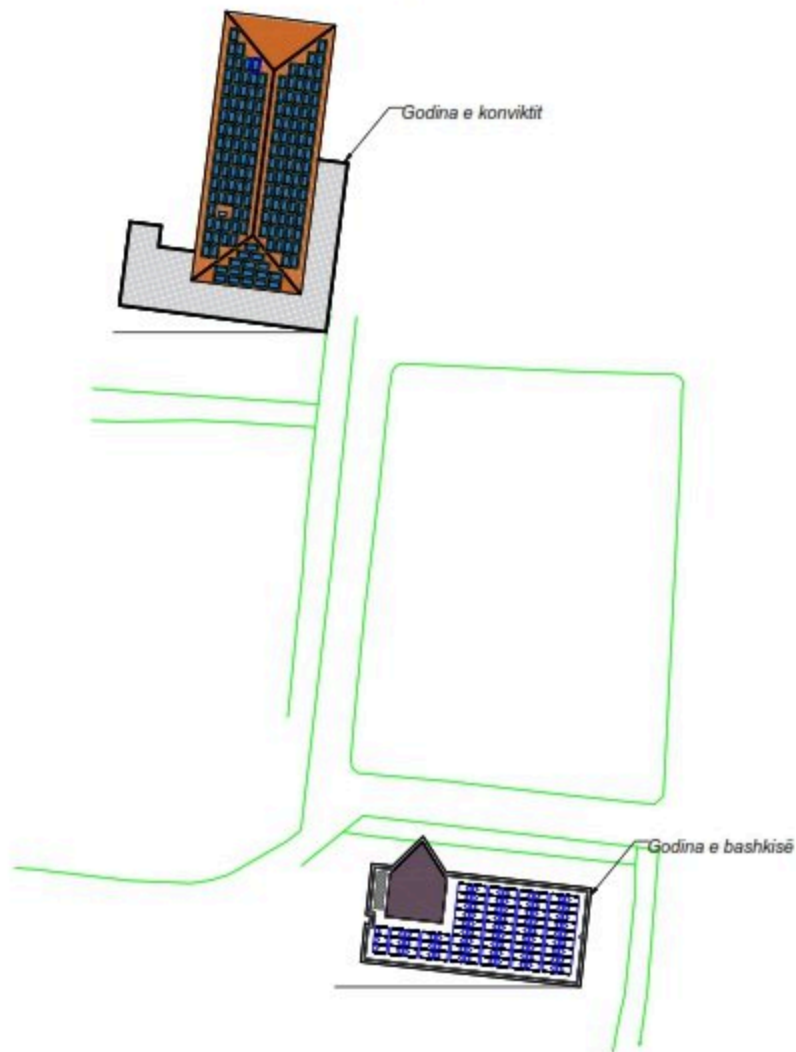

PROJEKTI: 13-007



BASHKIA E RREZIT, PËRQYFJE

KONSOLEJTI / CONSULTANT



SHËRBIMET TËRHEQËSE / TECHNICAL SERVICES

PROJEKTI / PROJECT NAME

"INSTALIMI I SISTEMIT FOTOVOLTAIK"

ZONA / LOCATION

BASHKIA E RREZIT

FASË E PROJEKTI / PROJECT PHASE

PROJEKT ZBATIM / IMPLEMENTATION OF DESIGN

PROJEKTI ARCHITETUROR / ARCHITECTURAL DESIGN

Ark. Rigjonda MYDRELLARI

06.11.2022

06.11.2022

PROJEKTI INZHINIEROR / STRUCTURAL DESIGN

Ing. Rishap TAPDA

06.11.2022

PROJEKTI INZHINIEROR / MECHANICAL DESIGN

Ing. Arqif PEPI

06.11.2022

PROJEKTI INZHINIEROR / ELECTRICAL DESIGN

Ing. Merita MEGRI

06.11.2022

PROJEKTI INZHINIEROR / ELECTRICAL DESIGN

Ing. Kristaq ZHURA

06.11.2022

INSTRUM. / FIELD OF DESIGN

PLAN / REALIZIMET / OBRITVE

SHKALLA

1:1000

SHKURT 2022

SHËRBIMET TËRHEQËSE

06.11.2022

06.11.2022

A-01

VLKA / STAMP

DIMENSIONET E SIPERFAQES KU DO TE VENDOSEN PANELET FOTOVOLTAIKE

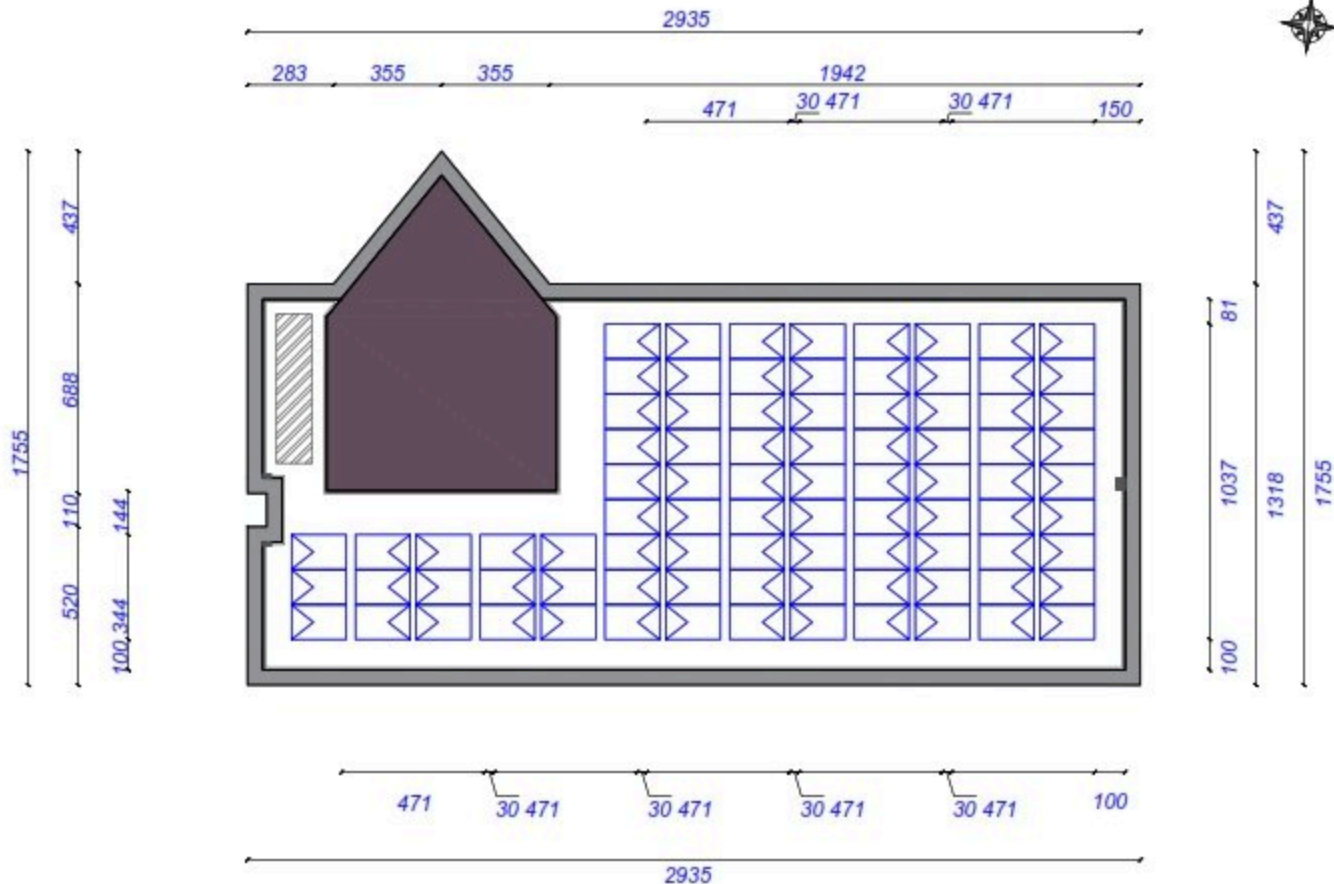

PROJEKTI 2023 - 12.04.2023



KONSULTANT / KONSULTANT



SHKURIME TËRHEQUR / TECHNICAL NOTES

PROJEKTI / PROJECT NAME

"INSTALIMI I SISTEMIT FOTOVOLTAIK"

ZONA / LOCATION

BASHKIA MIRCITE

FASHA E PROJEKTI / PROJECT PHASE

PROJEKT ZBATIM / IMPLEMENTATION DESIGN

PROJEKTI ARCHITETUROR / ARCHITECTURAL DESIGN

Ark. Rigonda MYDRELLARI

PROJEKTI INZHINIEROR / STRUCTURAL DESIGN

Ing. Rashap TAPDA

PROJEKTI SHPËRBLIMOR / MECHANICAL DESIGN

Ing. Ardit PEPI

PROJEKTI SHPËRBLIMOR / ELECTRICAL DESIGN

Ing. Merita MEGRI

PROJEKTI SHPËRBLIMOR / CIVIL DESIGN

Ing. Kristaq ZHURRA

SHKURIME TËRHEQUR / TECHNICAL NOTES

SHKURIME TËRHEQUR / TECHNICAL NOTES

SHKURIME TËRHEQUR / TECHNICAL NOTES

SHKURIME TËRHEQUR / TECHNICAL NOTES

SHKURIME TËRHEQUR / TECHNICAL NOTES

SHKURIME TËRHEQUR / TECHNICAL NOTES

SHKURIME TËRHEQUR / TECHNICAL NOTES

SHKURIME TËRHEQUR / TECHNICAL NOTES

SHKURIME TËRHEQUR / TECHNICAL NOTES

SHKURIME TËRHEQUR / TECHNICAL NOTES

SHKURIME TËRHEQUR / TECHNICAL NOTES

SHKURIME TËRHEQUR / TECHNICAL NOTES

SHKURIME TËRHEQUR / TECHNICAL NOTES

SHKURIME TËRHEQUR / TECHNICAL NOTES

SHKURIME TËRHEQUR / TECHNICAL NOTES

SHKURIME TËRHEQUR / TECHNICAL NOTES

SHKURIME TËRHEQUR / TECHNICAL NOTES

SHKURIME TËRHEQUR / TECHNICAL NOTES

A-02

DIMENSIONET E SIPERFAQES KU DO TE VENDOSEN PANELET FOTOVOLTAIKE

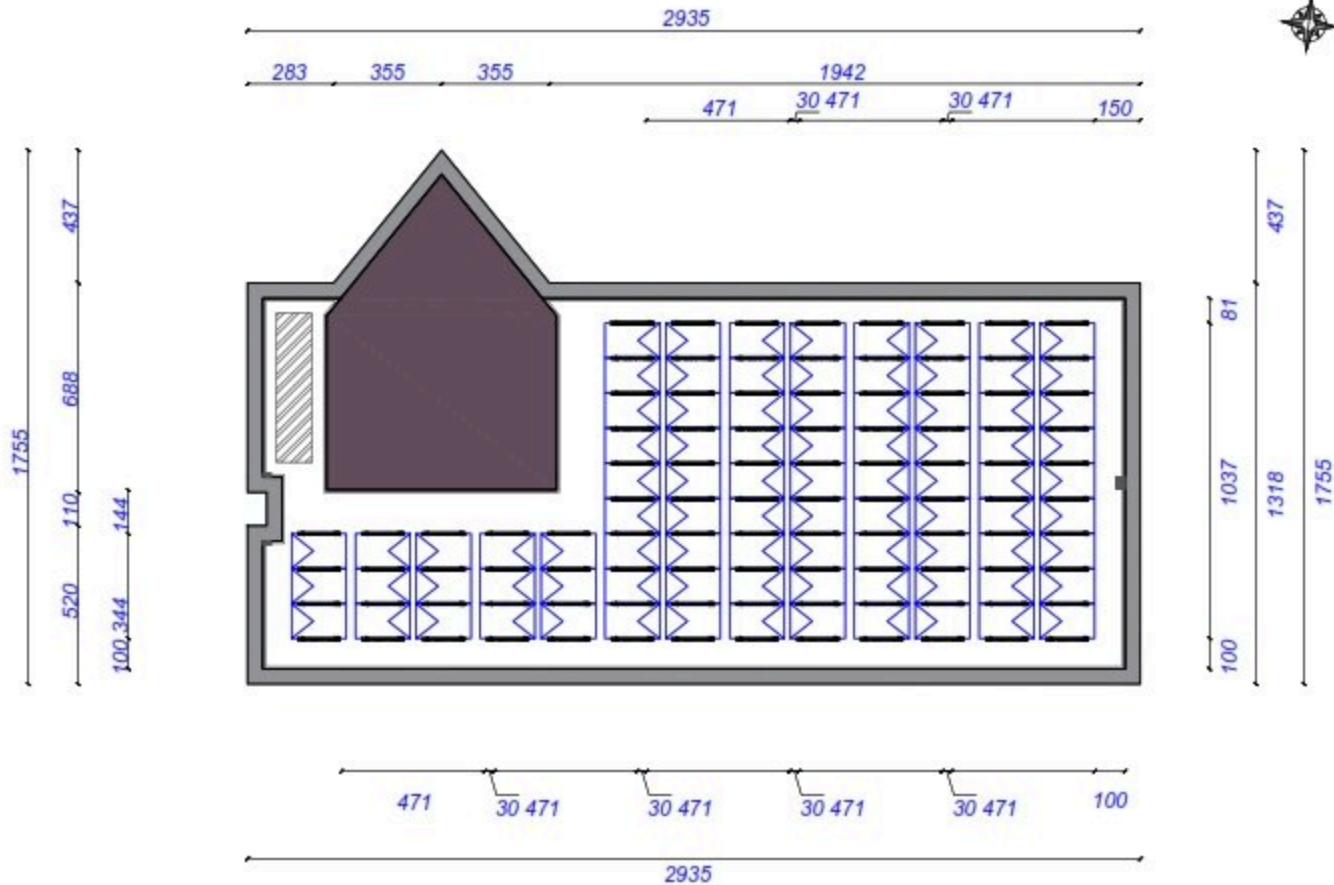

PROJEKTORE / CLASS



BASHKIA MIRDITE, PRRYPITURE

KONSULTANT / CONSULTANT



ZENIT/CCO

Prillimitar, Tiranë (Rr. 19 Aprilit, 1002)

068 440 1012

z.enit@ccco.com

SHKURIME / TECHNICAL NOTES

PROJEKTI / PROJECT NAME

"INSTALIMI I SISTEMIT FOTOVOLTAIK"

ZONA / LOCATION

BASHKIA MIRDITE

FAZA E PROJEKTI / PROJECT PHASE

PROJEKT ZBATIM / IMPLEMENTATION DESIGN

PROJEKTI ARCHITETURE / ARCHITECTURAL DESIGN

Ark. Rajmonda MYDRELLARI

Rr. 19 Aprilit 1002

068 440 1012

PROJEKTI INZHINIERI / STRUCTURAL DESIGN

Ing. Rishap TAPDA

Rr. 19 Aprilit 1002

PROJEKTI SHPURTOR / MECHANICAL DESIGN

Ing. Ardit PEPI

Rr. 19 Aprilit 1002

PROJEKTI HETEROGJENIT / ELECTRICAL DESIGN

Ing. Merita MEGRI

Rr. 19 Aprilit 1002

PROJEKTI SHPURTOR / ELECTRICAL DESIGN

Ing. Kristaq ZHURRA

Rr. 19 Aprilit 1002

FAZA E PROJEKTI / TITLE OF DESIGN

DOKUMENTI SHPURTOR KU DO TE VENDOSEN PANELI

SHKALLA / SCALE

1:100

SHKURT 2020

SHKURIME / TECHNICAL NOTES

A-03

VLKA / STAMP



Struktura e vendosjes se paneleve fotovoltaike

Pamja anësore

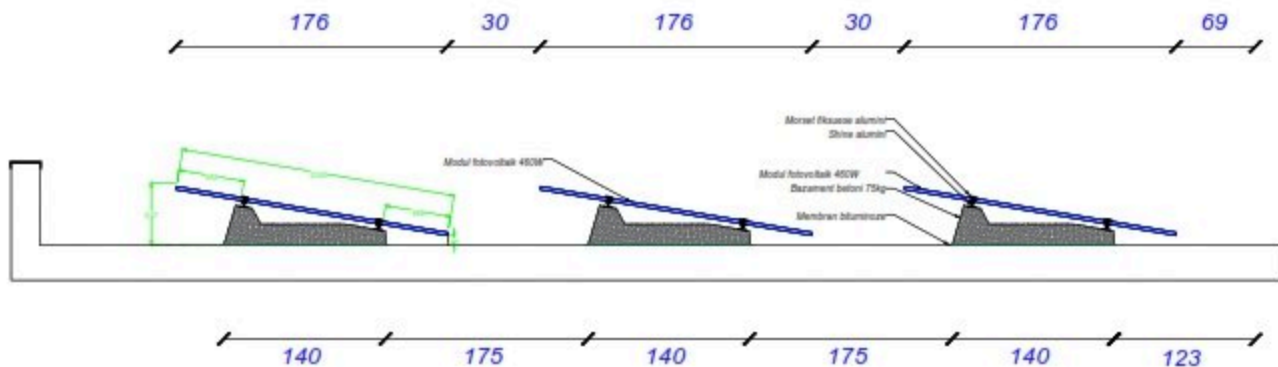

"INSTALIMI I SISTEMIT
FOTOVOLTAIK"

BASHKIA MIRDITE

PROJEKT ZBATIMI
IMPLEMENTATION DESIGN

Ark. Rajmonda MYDRELLARI
Sh. G. Sh. 0103
Sh. Rr. Shkollës Tuzi (Sh. Kështjorës 302)

Ing. Pashkop TARSA
Sh. G. Sh. 0103

Ing. Ardit PEHU
Sh. G. Sh. 0103

Ing. Merita MEGRI
Sh. G. Sh. 0103

Ing. Kristaq ZHURA
Sh. G. Sh. 0103

SHENIME TEKNIKE

1:100

A-04

DIMENSIONET E SIPERFAQES KU DO TE VENDOSEN PANELET FOTOVOLTAIKE



BASHKIA E RRETHIT FERIZAJ

KONSULLANT / CONSULTANT



SHKURIME TENDERE / TECHNICAL NOTES

PROJEKT / PROJECT NAME

"INSTALIMI I SISTEMIT FOTOVOLTAIK"

ZONA / LOCATION

BASHKIA E RRETHIT FERIZAJ

FASJA E PROJEKTIT / PROJECT PHASE

PROJEKT ZBATIM / IMPLEMENTATION DESIGN

PROJEKTI ARCHITETONIK / ARCHITECTURAL DESIGN

Ark. Rajmonda MYDRELLARI

PROJEKTI INZHINIERI / STRUCTURAL DESIGN

Ing. Rashap TAPDA

PROJEKTI SHPALLOR / MEK PROJEKTI / MEK PROJECT

Ing. Anxhel PERI

PROJEKTI SHPALLOR / SHPALLOR PROJECT

Ing. Merita MEGRI

PROJEKTI SHPALLOR / ELECTRICAL DESIGN

Ing. Kishiq ZHURA

FAZJA E PROJEKTIT / FIELD OF DESIGN

DREZHEVITET E SHPALLORIT KU DO TE VENDOSEN PANELET

SHKALLA / SCALE

1:100

SHIFRA E DOKUMENTIT / DOCUMENT NUMBER

A-05

VLAKA / STAMP

PLANIMETRIA E CATISE SE GODINES SE KONVIKTIT

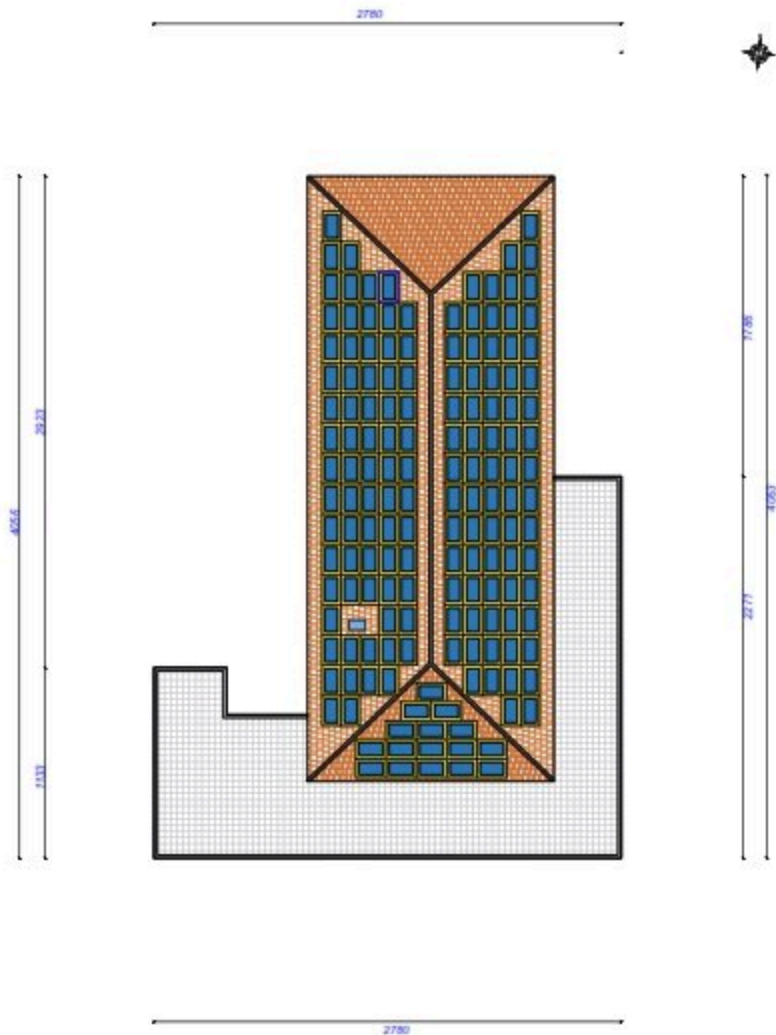

PROJEKTORE / DISEIGNER



BASHKIA MBRODITE, PARRUTIS

KONSTRUKT / CONSULTANT



ZENITSCO
ZEMBEJANES

16 Mbrodit, Turr (Nr. 19) qyteza, 1002
t.zeni@zenit.co

SHKURIME / DRAWING / TECHNICAL NOTES

PROJEKTI / PROJECT NAME

**"INSTALIMI I SISTEMIT
FOTOVOLTAIK"**

ZONA / LOCATION

BASHKIA MBRODITE

FASHA E PROJEKTTIT / PROJECT PHASE

**PROJEKT ZBATIM
IMPLEMENTATION OF DESIGN**

PROJEKTI ARKITEKTUROR / ARCHITECTURAL DESIGN

Ark. Rigjonda MYDRELLAP

16-11-0-02/102

16/04/2020 10:04:17:00

PROJEKTI KONSTRUKTIV / STRUCTURAL DESIGN

Ing. Rashap XARDA

16/04/2020

PROJEKTI MASHINORIE / MECHANICAL AND COOLING

Ing. Arqipe PEPI

16/04/2020

PROJEKTI HEDHEMBRITJE / MUNICIPAL DESIGN

Ing. Merita MEGRI

16/04/2020

PROJEKTI ELEKTRIK / ELECTRICAL DESIGN

Ing. Kristaq ZHURPA

16/04/2020

EMENDIM / ALTERS / FIELD OF DESIGN

LANIMIMI E CATISE SE GODINES SE KONVIKTIT

SHKALLA

1:100

SHKURTI 2020

SHKURTI / DRAWING NO.

A-06

VLKA / STAMP

PLANVENDOSJA E MODULEVE MBI CATI

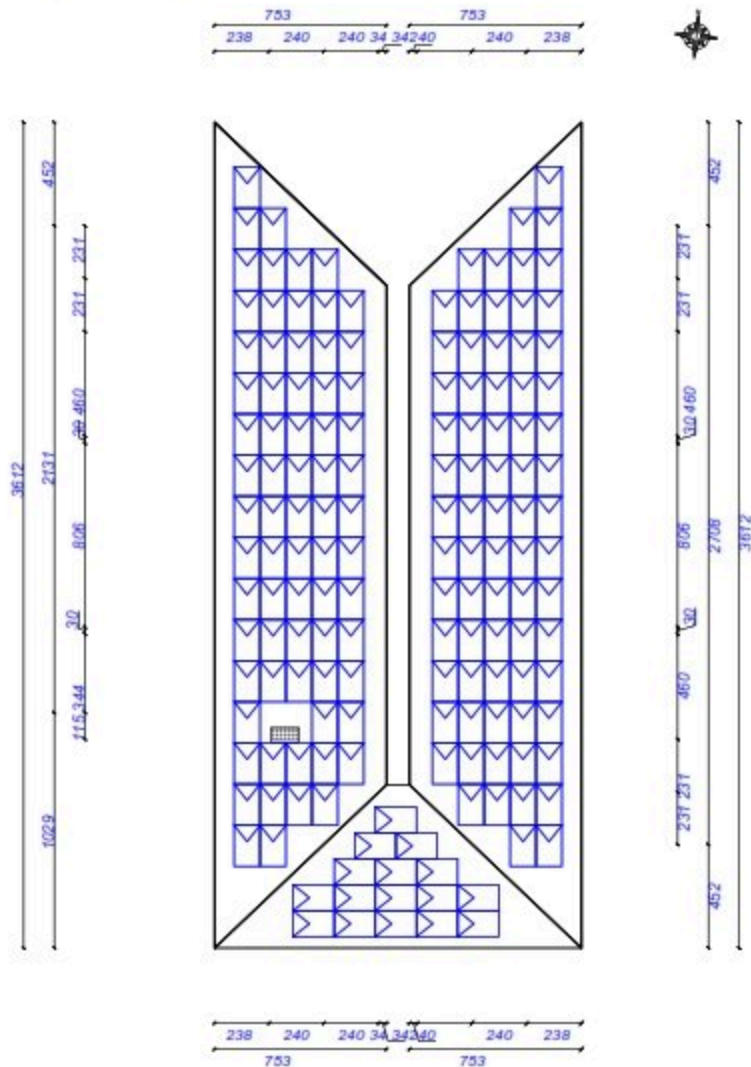

PROJEKTI: 13.007



BASHKIA MBRODITE, PERIPYRJE

KONSULENT: KONSULANT



SHKURIME TENDRE / TECHNICAL NOTES

PROJEKTI: PROJECT NAME

"INSTALIMI I SISTEMIT FOTOVOLTAIK"

ZONA / LOCATION

BASHKIA MBRODITE

FASHE E PROJEKTI: PROJECT PHASE

PROJEKTI ZBATIM / IMPLEMENTATION OF SIGN

PROJEKTI ARCHITETURE / ARCHITECTURAL DESIGN

Ark. Rajmonda MYDRELLARI

06.11.2022

06.11.2022

PROJEKTI INZHINIERI / STRUCTURAL DESIGN

Ing. Rishap TAPDA

06.11.2022

PROJEKTI SHPËRIMOR / ME PROJEKTIM

Ing. Arqipe PEPI

06.11.2022

PROJEKTI INZHINIERI / PRINCIPAL DESIGN

Ing. Merita MESHU

06.11.2022

PROJEKTI ELIMTRIK / ELECTRICAL DESIGN

Ing. Kristaq ZHURPA

06.11.2022

SHUMËSI E PLETËS / FIELD OF DESIGN

PLANVENDOSJE E MODULEVE MBI CATI

SHKALLA

1:100

SHKURT 2022

SHUMËSI E PLETËS

06.11.2022

06.11.2022

A-07

VLAK / STAMP

PLANVENDOSJA E STRINGAVE

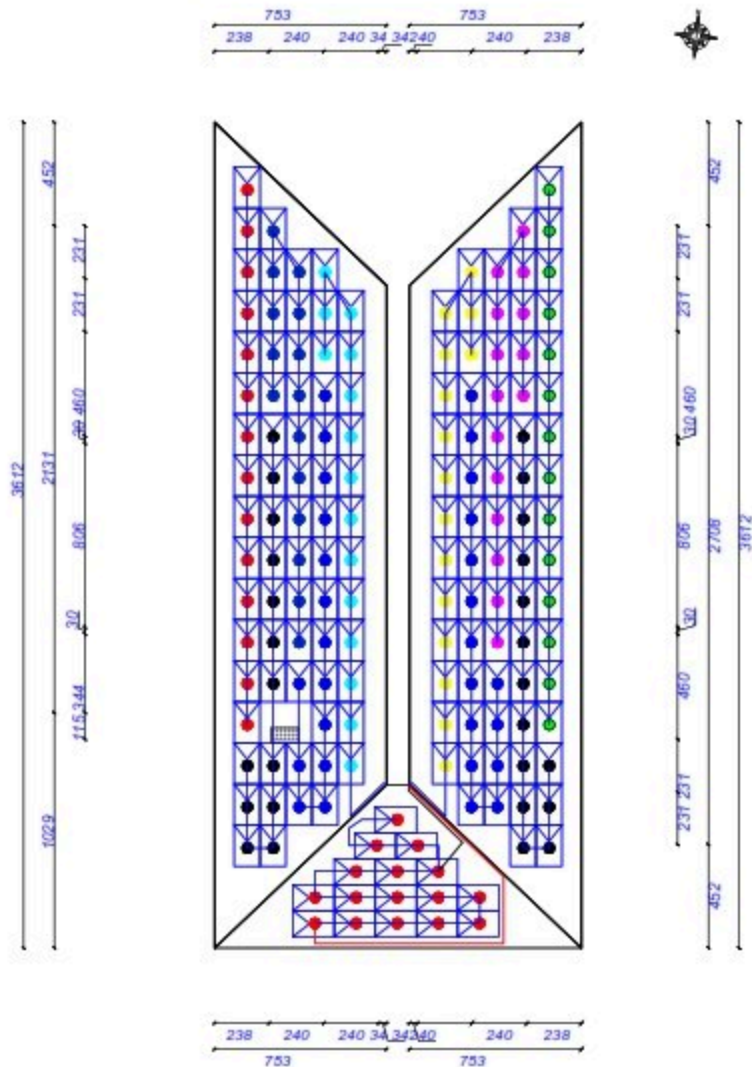

FORMIDULO: 100000



ASHOKA MRODITE, PRISTINE

KONSULLANT: KONSULLANT



SHKURIME: TENDERO / TECHNICAL NOTICE

PROJEKTI: PROJECT NAME

"INSTALIMI I SISTEMIT FOTOVOLTAIK"

ZONA / LOCATION

ZASHOKIA MRODITE

FASJA E PROJEKTI / PROJECT PHASE

PROJEKTI ZBATIM / IMPLEMENTATION OF SIGN

PROJEKTI ARCHITETONIK / ARCHITECTURAL DESIGN

Ark. Rigjonda MYDRELLARI

06.11.2022

ASHOKA MRODITE 04.07.2022

PROJEKTI INZHINIERI / STRUCTURAL DESIGN

Ing. Rashap TAPDA

06.11.2022

PROJEKTI SHPUNIMOR / MEK PROJEKTI / MEK DESIGN

Ing. Arqipe PEPI

06.11.2022

PROJEKTI INZHINIERI / PRINCIPAL DESIGN

Ing. Merita MESIRI

06.11.2022

PROJEKTI INZHINIERI / ELECTRICAL DESIGN

Ing. Kristaq ZHURPA

06.11.2022

SHKURIME / CHECK / FILE OF DESIGN

PLANVENDOSJA E MODULIT FOTOVOLTAIK

SHKALLA

1:1000

SHKURIMI 2022

SHKURIMI / CHECK / FILE

A-08

VLAK / STAMP

PLANVENDOSJA E INVERTERIT NR.3 NE DHOMEN TEKNIKE TE BASHKISE

Kaneline metalike 50 mm me kapak zinku ku kalojne perciellsat AC

Panel elektrik 24M jashte muri

Kaneline metalike 50 mm me kapak zinku ku kalojne perciellsat DC 6mm

Inverter 40kWp

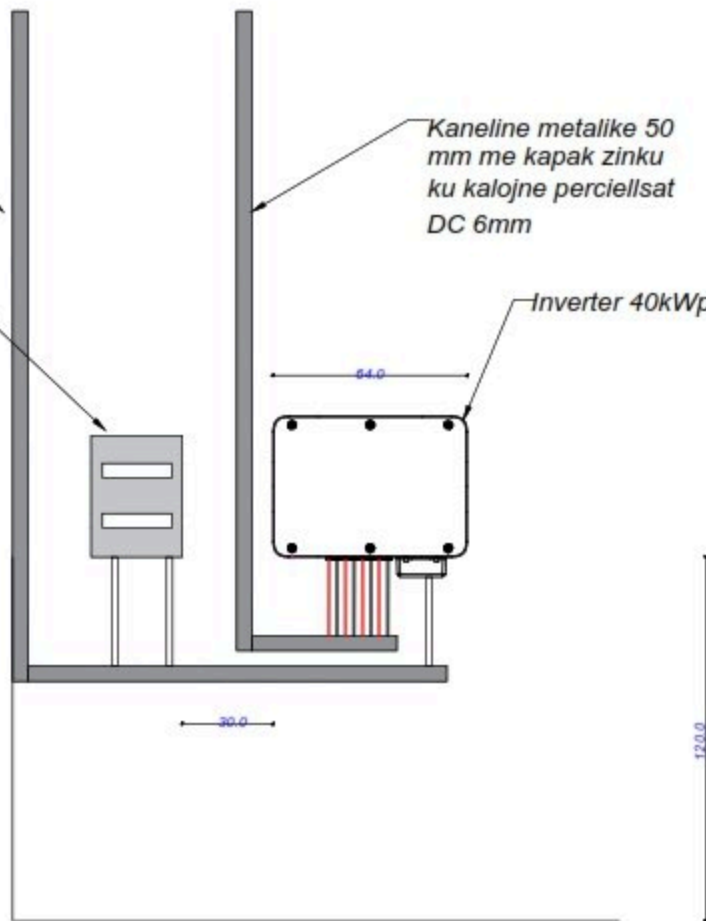

PROJEKTI: 13.0817



BASHKIA MIRDITE, PESHKËPISHT

KONSOLEJTI / CONSULTANT



SHKËMBI TËRBUK / TECHNICAL NOTES

PROJECT / PROJECT NAME

"INSTALIMI I SISTEMIT FOTOVOLTAIK"

ZONE / LOCATION

BASHKIA MIRDITE

PHASE / PROJECT / PROJECT PHASE

PROJEKT ZBATIM / IMPLEMENTATION OF DESIGN

PROJECT ARCHITECTURE / ARCHITECTURAL DESIGN

Ark. Rajmonda MYDRELLARI

PROJEKT KONSULTANT / STRUCTURAL DESIGN

Ing. Rashap TAPDA

PROJEKT SHKËMBI / MEK. PROJ. AND COOLING

Ing. Arqipe PEPI

PROJEKT INZHINIERI / PRINCIPAL DESIGN

Ing. Merita MESHU

PROJEKT ELEKTRIK / ELECTRICAL DESIGN

Ing. Kristaq ZHURPA

PHASES / PHASES / FIELD OF DESIGN

PLANIMETRIK / IMPLEMENTATION

SHKALLA

1:100

SHKËMBI 2025

SHKËMBI / CONSULTANT

A-09

VLAK / STAMP

SKEMA ELEKTRIKE AC

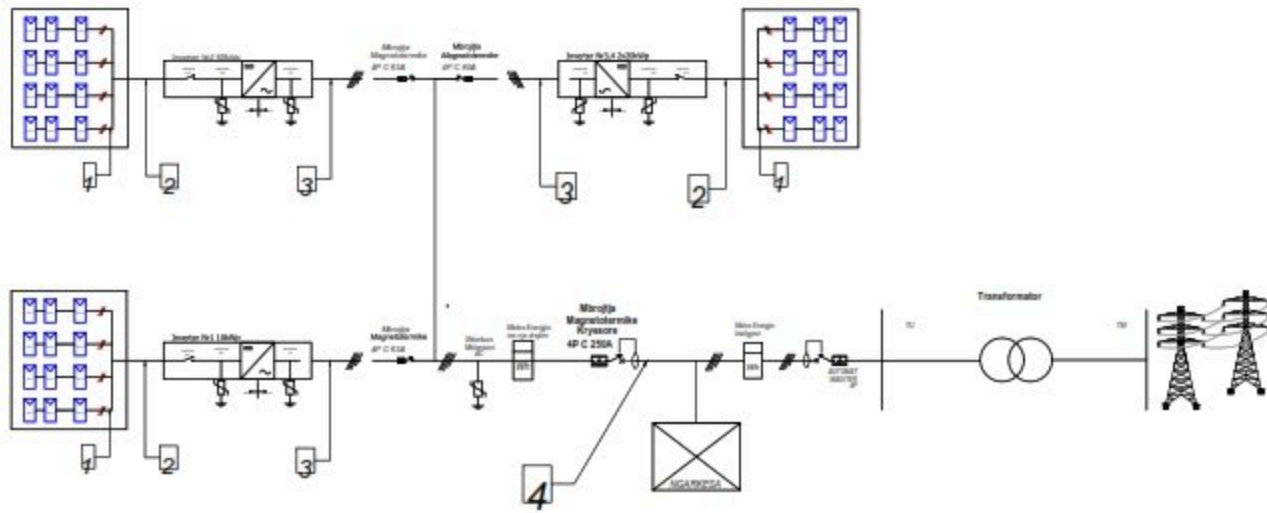

PROJEKT: 13-087



BASHKIA MRODITE, REPUBLIC OF

CONSULTANT:



DESIGN: TECHNICAL DRAWING

PROJECT: PROJECT NAME

"INSTALIMI I SISTEMIT FOTOVOLTAIK"

JOB: LOCATION

BASHKIA MRODITE

PAGE: PROJECT: PROJECT PAGE

PROJEKT ZBATIMI / IMPLEMENTATION DESIGN

PROJECT ARCHITECTURE / ARCHITECTURAL DESIGN

Ark. Rajmonda MYDRELLARI

PROJECT STRUCTURE / STRUCTURAL DESIGN

Ing. Rishap TAPDA

PROJECT MECHANICAL / MECHANICAL DESIGN

Ing. Arqipe PEPI

PROJECT ELECTRICAL / ELECTRICAL DESIGN

Ing. Merita MEGRI

PROJECT ELECTRICIAN / ELECTRICAL DESIGN

Ing. Kristaq ZHURPA

CLIENT: CLIENT / TITLE OF DESIGN

800M BASHKIA AC

SCALE:

PROJECT 2024

APPROVED / STAMP:

A-10

SCALE / STAMP

DIMENSIONET E INVERTERIT

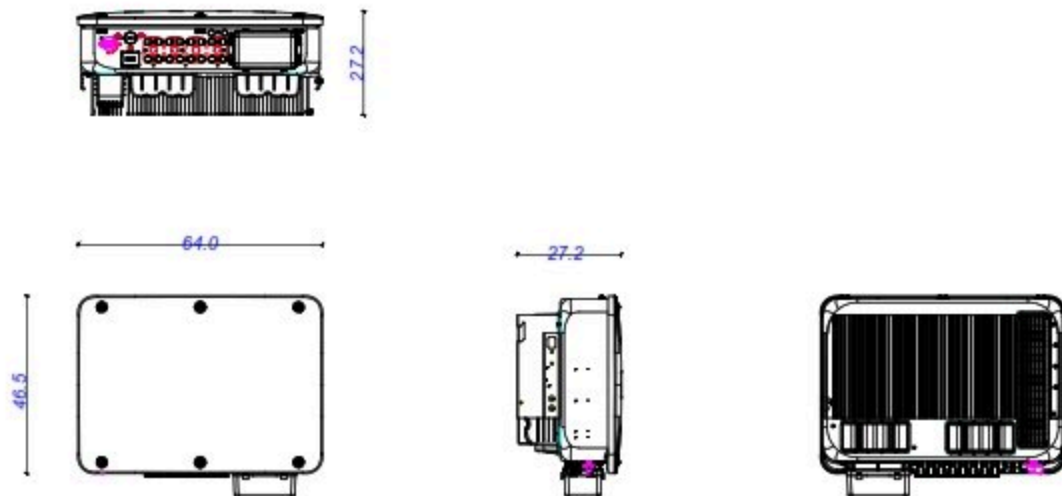

PROJEKTO: 13.08.17



BASHKIA MIRDIË, PESHKËPISË

KONSULLENT / CONSULTANT



ZENITSCO
ZEMËRREJTI I SHËRBUJTEVE
SHËRBUJTI I SHËRBUJTEVE

16 Nëntor, Turrpik Nr. 19, Shkup, 5500
T. 020 2000000
E. info@zenitso.com

SHËRBUJTI / SERVICE / TECHNICAL NOTES

PROJEKTI / PROJECT NAME

**"INSTALIMI I SISTEMIT
FOTOVOLTAIK"**

ZONA / LOCATION

BASHKIA MIRDIË

FAZA E PROJEKTI / PROJECT PHASE

**PROJEKT ZBATIM
IMPLEMENTATION DESIGN**

PROJEKTI ARCHITETUROR / ARCHITECTURAL DESIGN

Ark. Rajmonda MYDRELLARI

16.11.2017
16.11.2017

PROJEKTI INZHINIEROR / STRUCTURAL DESIGN

Ing. Rishap TAPIDA

16.11.2017

PROJEKTI SHËRBUJTE / ME PROJEKTIM DHE SHËRBUJTI

Ing. Arqipe PEPI

16.11.2017

PROJEKTI INZHINIEROR / PRINCIPAL DESIGN

Ing. Merita MEGRI

16.11.2017

PROJEKTI ELEKTRIKOR / ELECTRICAL DESIGN

Ing. Kristaq ZHURPA

16.11.2017

FAZA E PROJEKTI / TITLE OF DESIGN

DIMENSIONET E INVERTERIT

SHKALLA

1:1

SHKURT 2016

SHËRBUJTI / SERVICE

A-11

VLAK / STAMP

PLANVENDOSJA E INVERTERAVE 1 DHE 2 NE GODINEN E KONVIKTIT

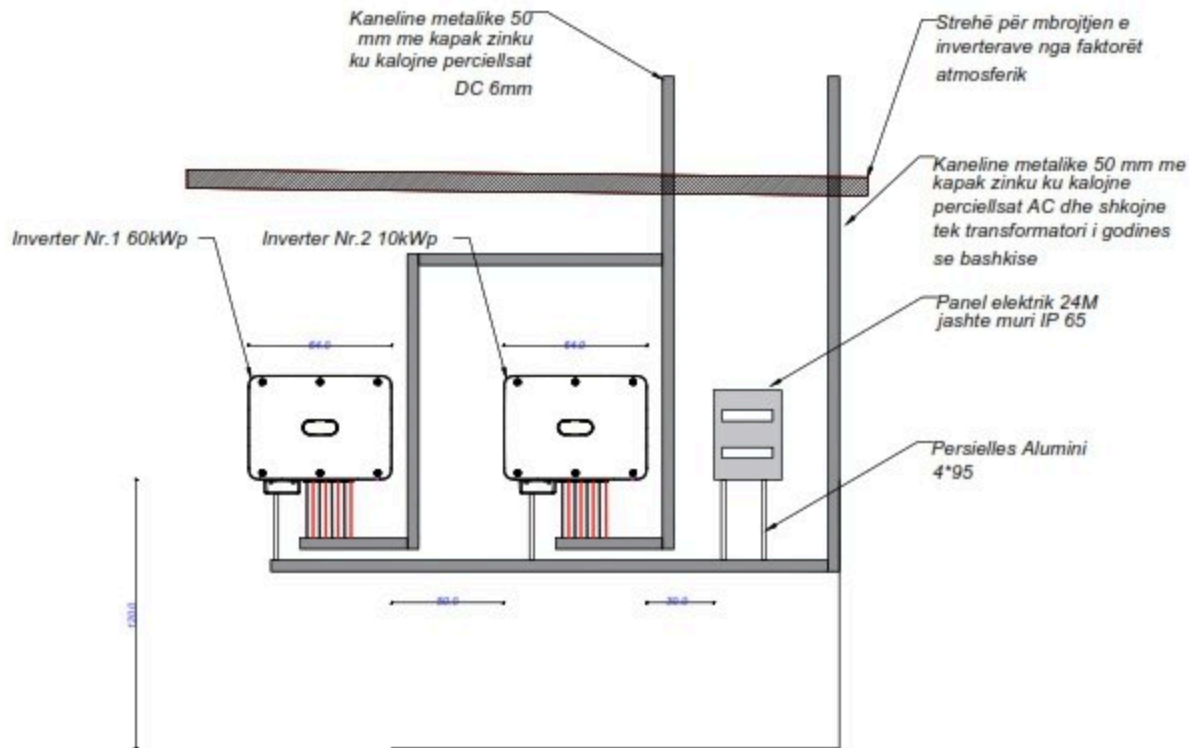

PROJEKTI: 13.007



BASHKIA E PRIZRENIT

KONSTRUKTIV / CONSULTANT



SHKURIME / SYMBOLS / TECHNICAL NOTES

PROJEKT / PROJECT NAME

"INSTALIMI I SISTEMIT FOTOVOLTAIK"

FORMA / LOCATION

BASHKIA E PRIZRENIT

FASJA E PROJEKTI / PROJECT PHASE

PROJEKT ZBATIM / IMPLEMENTATION OF SIGN

PROJEKTI ARCHITETUROR / ARCHITECTURAL DESIGN

Ark. Rigonda MYDRELLARI

PROJEKTI KONSTRUKTIV / STRUCTURAL DESIGN

Ing. Rashap TAPDA

PROJEKTI MASHINORIE / MEK. PROJ. AND COOLING

Ing. Ardit PEPI

PROJEKTI HEDRIMOR / PRINCIPAL DESIGN

Ing. Merita MEGRI

PROJEKTI ELEKTRIK / ELECTRICAL DESIGN

Ing. Kristaq ZHURPA

SHUMËSI / LISTS / TITLE OF DESIGN

PLANVENDOSJE E INVERTERAVE 1 DHE 2

SHKALLA / SCALE

SHKURT 2008

SHUMËSI / LISTS / TITLE OF DESIGN

A-12

VLAKA / STAMP

PLANVENDOSJA E INVERTERAVE 1 DHE 2 NE GODINEN E KONVIKTIT

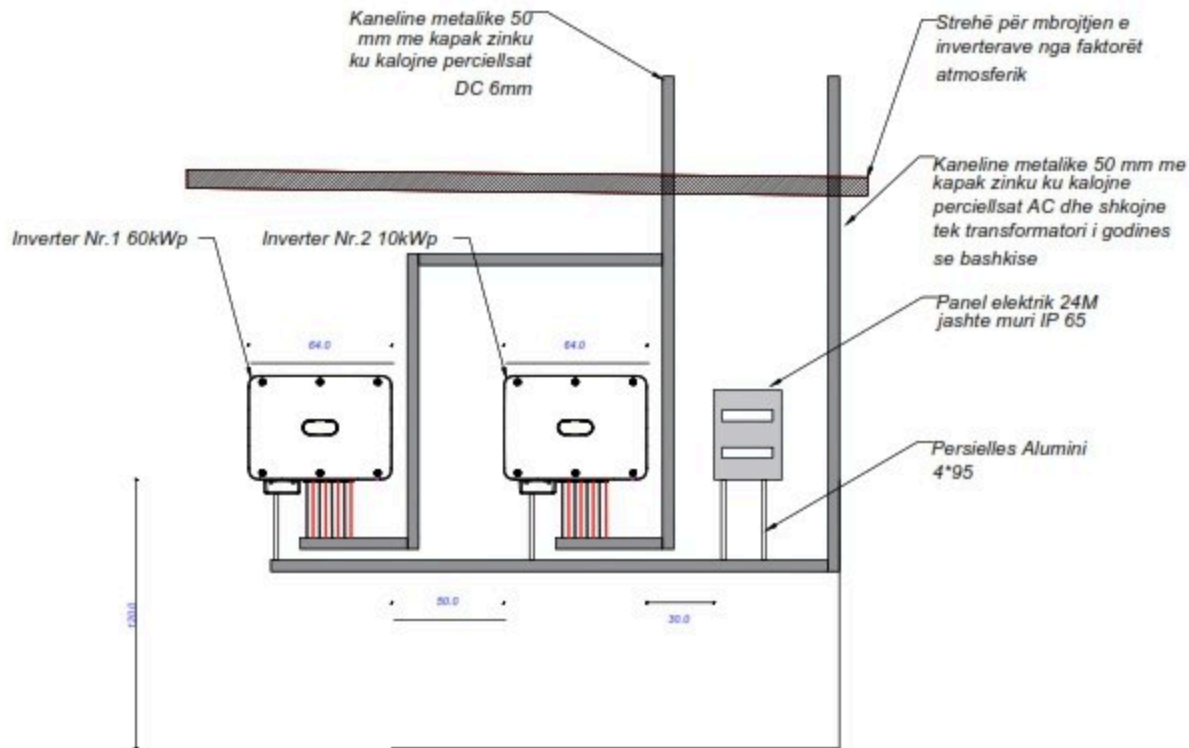

PROJEKTI: 13.007



BASHKIA E RRETHIT TË PRIZRENIT

KONSTRUKT: CONSULTANT



SHKURIM: TECHNICAL DRAWING

PROJEKT: PROJECT NAME

"INSTALIMI I SISTEMIT FOTOVOLTAIK"

FORMA: LOCATION

BASHKIA E RRETHIT TË PRIZRENIT

FASHA E PROJEKTTIT: PROJECT PHASE

PROJEKT ZBATIM / IMPLEMENTATION OF SIGN

PROJEKTI ARCHITETUROR: ARCHITECTURAL DESIGN

Ark. Rajmonda MYDRELLARI

06.11.2023

06.11.2023

PROJEKTI KONSTRUKTIV: STRUCTURAL DESIGN

Ing. Rashad XAPDA

06.11.2023

PROJEKTI MASHINORIE: MEK. PROJ. AND COOLING

Ing. Ardit PEPI

06.11.2023

PROJEKTI INZHINIERI: MECHANICAL DESIGN

Ing. Merita MEGRI

06.11.2023

PROJEKTI ELEKTRIK: ELECTRICAL DESIGN

Ing. Kristaq ZHURPA

06.11.2023

SHKURIMI: SHEETS / TITLE OF DESIGN

PLANVENDOSJE E INVERTERAVE 1 DHE 2

06.11.2023

06.11.2023

06.11.2023

06.11.2023

06.11.2023

06.11.2023

06.11.2023

06.11.2023

06.11.2023

06.11.2023

06.11.2023

06.11.2023

06.11.2023

06.11.2023

06.11.2023

06.11.2023

06.11.2023

06.11.2023

06.11.2023

SHKALLA

1:100

SHKURIT 2023

06.11.2023

06.11.2023

06.11.2023

06.11.2023

06.11.2023

06.11.2023

06.11.2023

06.11.2023

06.11.2023

06.11.2023

SHKURITI: CONSULTANT

06.11.2023

06.11.2023

06.11.2023

06.11.2023

06.11.2023

06.11.2023

06.11.2023

06.11.2023

06.11.2023

06.11.2023

06.11.2023

06.11.2023

A-13

VLAJ / STAMP

SKEMA E SISTEMIT TE MATJES

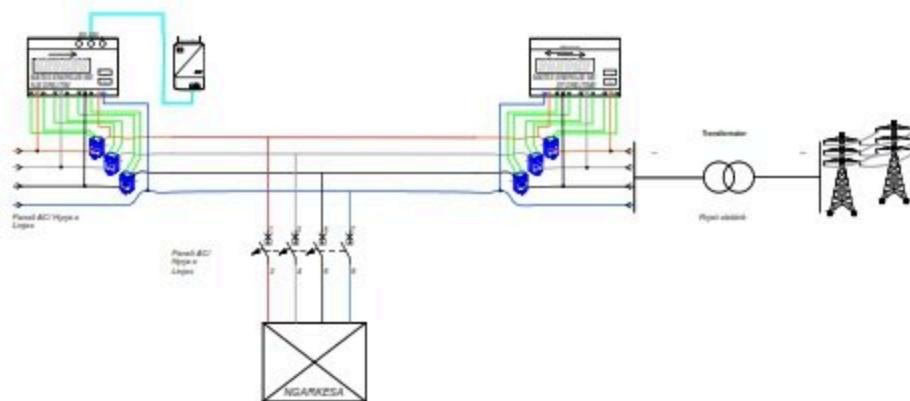

LEGJENDE	
	Inxhinjer
	Transformator Tipi
	Shërbues i Mirënjohur
	Aktues i Regjistruar
	Shërbues Energji Ndihmës
	Transformator T276
	April 2020
	Ngarkesa e Dëgjues

PROJEKTI: 13.007



BASHKIA E PRIZRËNIT

KONSULLENT / CONSULTANT



ZENIT/CCO
Z. M. KALLI
Rr. Shkurtari, Nr. 15, Prizren, Kosovo
T: +383 45 211 111
E: info@zenit.com

SHËRBUESI: TËRBUKUR / TECHNICAL SERVICE

PROJEKTI / PROJECT NAME

"INSTALIMI I SISTEMIT
FOTOVOLTAIK"

ZONA / LOCATION

BASHKIA E PRIZRËNIT

FAZJA E PROJEKTI / PROJECT PHASE

PROJEKTI ZBATIM /
IMPLEMENTATION DESIGN

PROJEKTI ARCHITETUR / ARCHITECTURAL DESIGN

Ark. Rajmonda MYDRELLARI
Rr. U. D. BEU
Prizren, Kosovo

PROJEKTI INZHINIERI / STRUCTURAL DESIGN

Ing. Rashap TAPDA
Prizren, Kosovo

PROJEKTI MASHINOR / MEK. PROJ. AND COOLING

Ing. Arqife PEPI
Prizren, Kosovo

PROJEKTI INZHINIERI / MUNICIPAL DESIGN

Ing. Merita MESHU
Prizren, Kosovo

PROJEKTI INZHINIERI / ELECTRICAL DESIGN

Ing. Kristaq ZHURPA
Prizren, Kosovo

SHËRBUESI / CLIENT / TITLE OF DESIGN

ARRANDE DREKTIVE TE MATJES

SHKALLA

1:1

SHKURT 2020

SHËRBUESI / CONSULTANT

A-14

VLKA / STAMP

PROJEKTI FOTOVOLTAIK

OBJEKTI: "Çerdhja Rubik"

PROGRAMI: "Projektimi i Sistemit Fotovoltaik"

MBESHTETES: IPA II Cross Border Cooperation Programme for Albania- Kosovo

PERFITUES: Bashkia Mirditë



ZENIT&CO

Tiranë 2026



BASHKIA MIRDITE

PLANIMETRI E PËRGJITHËSHME E OBJEKTIT

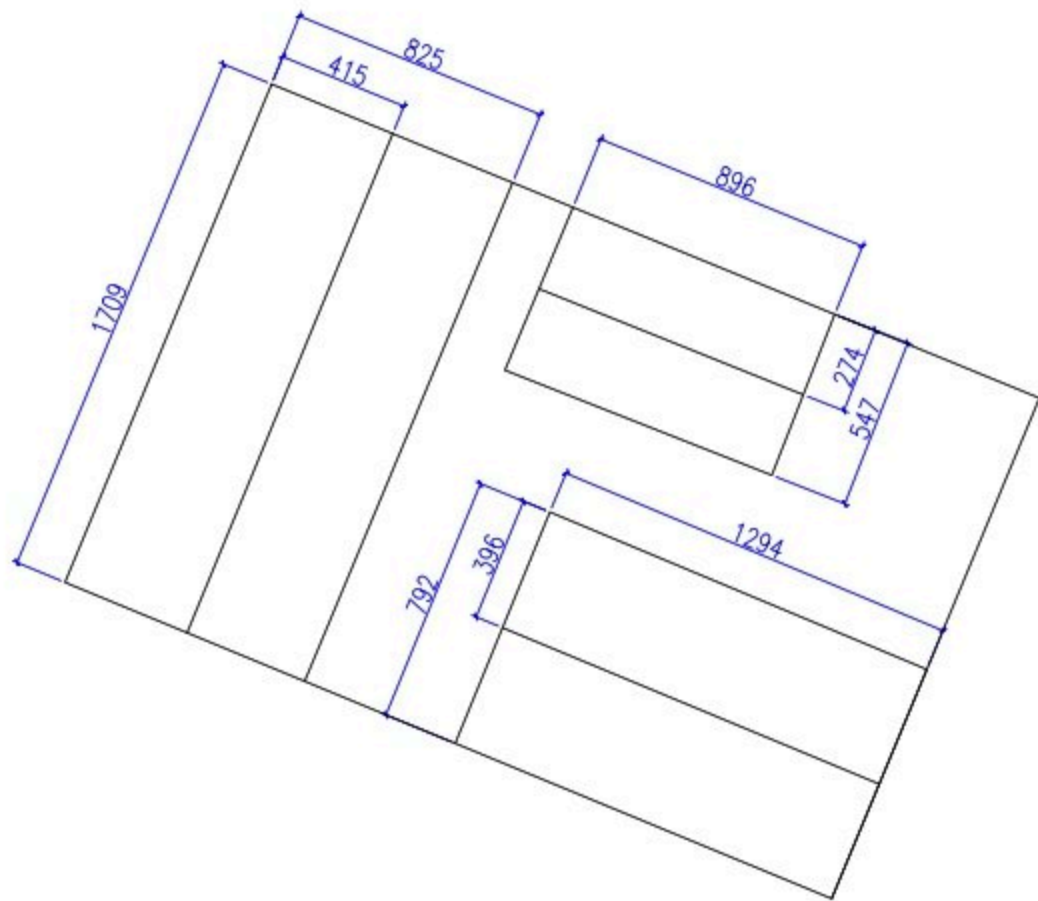

REPUBLICA E SHqipërisë

CONSULTANT



TECHNICAL NOTES

PROJECT / PROJECT NAME

"INSTALIMI I SISTEMIT FOTOVOLTAIK"

ZONE / LOCATION

ZASHKIA MRODITE

PAGE / PROJECT / PROJECT NAME

PROJEKT ZBATIM /
IMPLEMENTATION DESIGN

PROJECT ARCHITECTURE / ARCHITECTURAL DESIGN

Ark. Rigjonda MYDRELLARI

06.11.2022

06.11.2022

PROJECT ARCHITECTURE / STRUCTURAL DESIGN

Ing. Rishap TAPDA

06.11.2022

PROJECT ARCHITECTURE / MECHANICAL DESIGN

Ing. Ardit PEPI

06.11.2022

PROJECT ARCHITECTURE / ELECTRICAL DESIGN

Ing. Merita MEGRI

06.11.2022

PROJECT ARCHITECTURE / ELECTRICAL DESIGN

Ing. Kristaq ZHURJA

06.11.2022

PROJECT ARCHITECTURE / FIELD OF DESIGN

PLANNING AND DESIGN

PROJECT ARCHITECTURE / FIELD OF DESIGN

PLANNING AND DESIGN

PROJECT ARCHITECTURE / FIELD OF DESIGN

PLANNING AND DESIGN

PROJECT ARCHITECTURE / FIELD OF DESIGN

PLANNING AND DESIGN

PROJECT ARCHITECTURE / FIELD OF DESIGN

PLANNING AND DESIGN

PROJECT ARCHITECTURE / FIELD OF DESIGN

PLANNING AND DESIGN

PROJECT ARCHITECTURE / FIELD OF DESIGN

PLANNING AND DESIGN

PROJECT ARCHITECTURE / FIELD OF DESIGN

PLANNING AND DESIGN

PROJECT ARCHITECTURE / FIELD OF DESIGN

PLANNING AND DESIGN

PROJECT ARCHITECTURE / FIELD OF DESIGN

PLANNING AND DESIGN

PROJECT ARCHITECTURE / FIELD OF DESIGN

PLANNING AND DESIGN

PROJECT ARCHITECTURE / FIELD OF DESIGN

PLANNING AND DESIGN

SKALLA

1:100

SKILLI 2022

06.11.2022

06.11.2022

06.11.2022

06.11.2022

06.11.2022

06.11.2022

06.11.2022

06.11.2022

06.11.2022

06.11.2022

06.11.2022

REVISIONS / COMMENTS

A-01

06.11.2022

06.11.2022

06.11.2022

06.11.2022

06.11.2022

06.11.2022

06.11.2022

06.11.2022

06.11.2022

06.11.2022

PLANIMETRI E PËRGJITHËSHME E OBJEKTIT

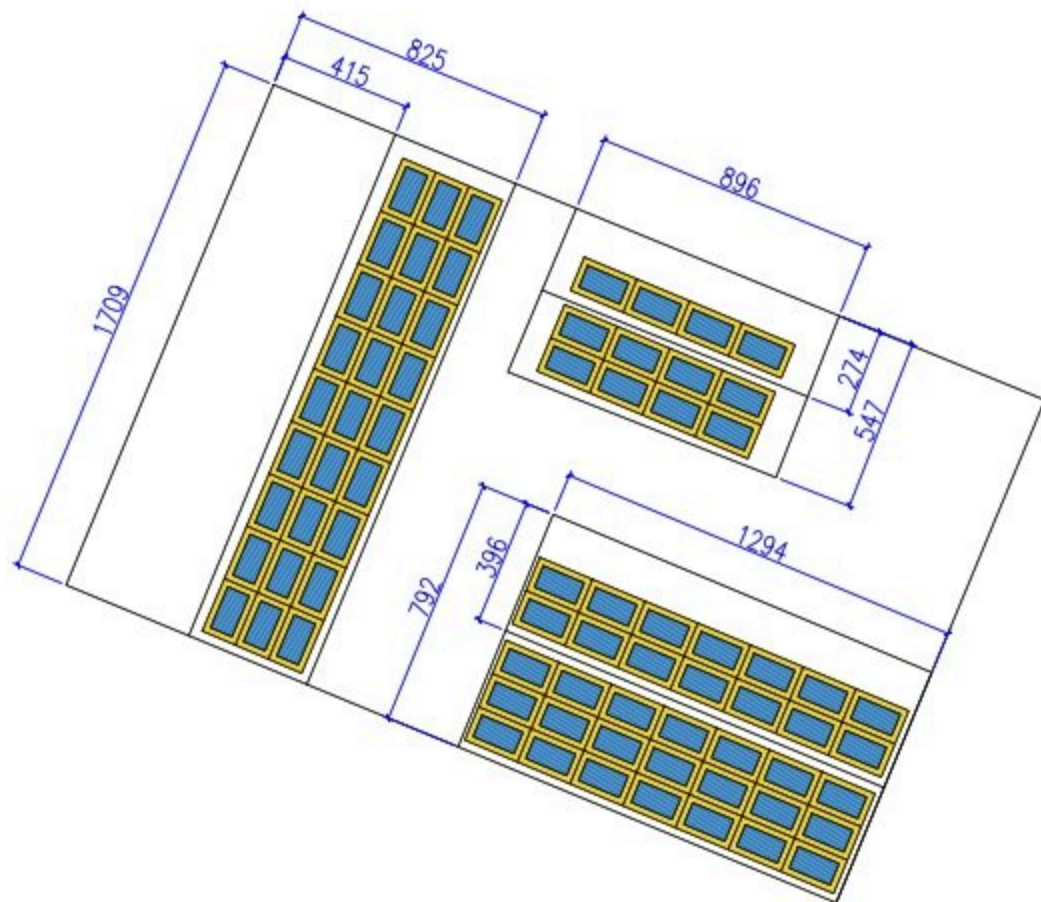

FORUMETRA - TIRANË



SHALLA ARKITEKTORE, PRINTEPIS

KONSTRUKTIV - CIVILIZIM



"SHALLA"
ARKITEKTORE, PRINTEPIS

Pr. Sheshit Tash (2), Sheshi nr. 1001
E-Mail: shalla@shalla.com

SHKEMBI TËRIMOR / TECHNICAL NOTES

PROJEKTI / PROJECT NAME

"INSTALIMI I SISTEMIT
FOTOVOLTAIK"

ZONA / LOCATION

BASHKËIA ARMËRITË

FASË E PROJEKTI / PROJECT PHASE

PROJEKTI ZBAJTIMI
IMPLEMENTATION DESIGN

PROJEKTI ARKITEKTORE / ARCHITECTURAL DESIGN

Ark. Rajmonda MYDINLLARI

SHALLA 01/192

SHALLA 01/192

PROJEKTI INZHINIERI / STRUCTURAL DESIGN

Ing. Rishaj TAPSA

SHALLA 01/192

PROJEKTI INZHINIERI - NËNJËSI DHE SHËRIMOR

Ing. Ardit PIRI

SHALLA 01/192

PROJEKTI INZHINIERI - MËDHEPISIA

Ing. Merita MEGRI

SHALLA 01/192

PROJEKTI ELEKTRIK / ELECTRICAL DESIGN

Ing. Kristaq ZHUPA

SHALLA 01/192

SHKEMBI TËRIMOR - TITULLI E SHËRIMOR

PLAN / PERLUTIMET / COLOUR

SHALLA

SHALLA

SHALLA 01/192

SHALLA - TIRANË

A-02

SHALLA / STEP

PLANIMETRI E PËRGJITHËSHME E OBJEKTIT

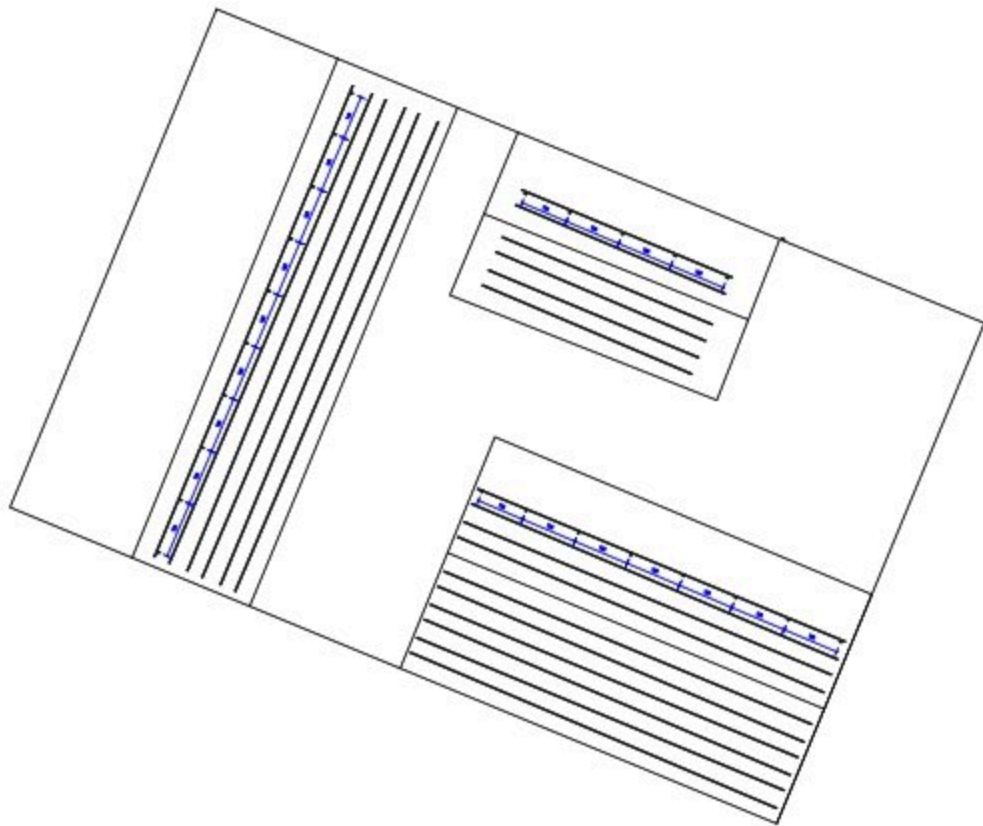

BASHKIA E PRIZRINIT

KONSULENT / CONSULTANT



ZENIT/CCO

Prizren, Tjetër Nr. 19, Apriq, 1000
t.045 441111
e.045 zenit@ccco.com

DOKUMENTI / TECHNICAL DRAWING

PROJEKT / PROJECT NAME

**"INSTALIMI I SISTEMIT
FOTOVOLTAIK"**

ZONA / LOCATION

BASHKIA E PRIZRINIT

FASZË / PROJECT / PROJECT NAME

**PROJEKT ZBATIM
IMPLEMENTATION DESIGN**

PROJEKTI ARCHITETUROR / ARCHITECTURAL DESIGN

Ark. Rigonda MYDRELLARI

Nr. 11-0-01/10
Prizren, Bashkia e Prizrenit

PROJEKTI KOSHTETOR / STRUCTURAL DESIGN

Ing. Rashap TAPDA

Nr. 11-0-01/10

PROJEKTI SHPËRTHYER / ME PROJEKTIMIN

Ing. Arqipe PEPI

Nr. 11-0-01/10

PROJEKTI INZHINIEROR / MEKANIKA

Ing. Merita MESHU

Nr. 11-0-01/10

PROJEKTI ELEKTRIK / ELECTRICAL DESIGN

Ing. Kristaq ZHURRA

Nr. 11-0-01/10

SHËNIMET / NOTES / FIELD OF DESIGN

PLANIMETRI I OBJEKTIT

SHALLA

01/10

PROJEKT 2020

SHALLA / SHALLA

A-03

VLAKA / STAMP

PLANIMETRI E STRINGAVE

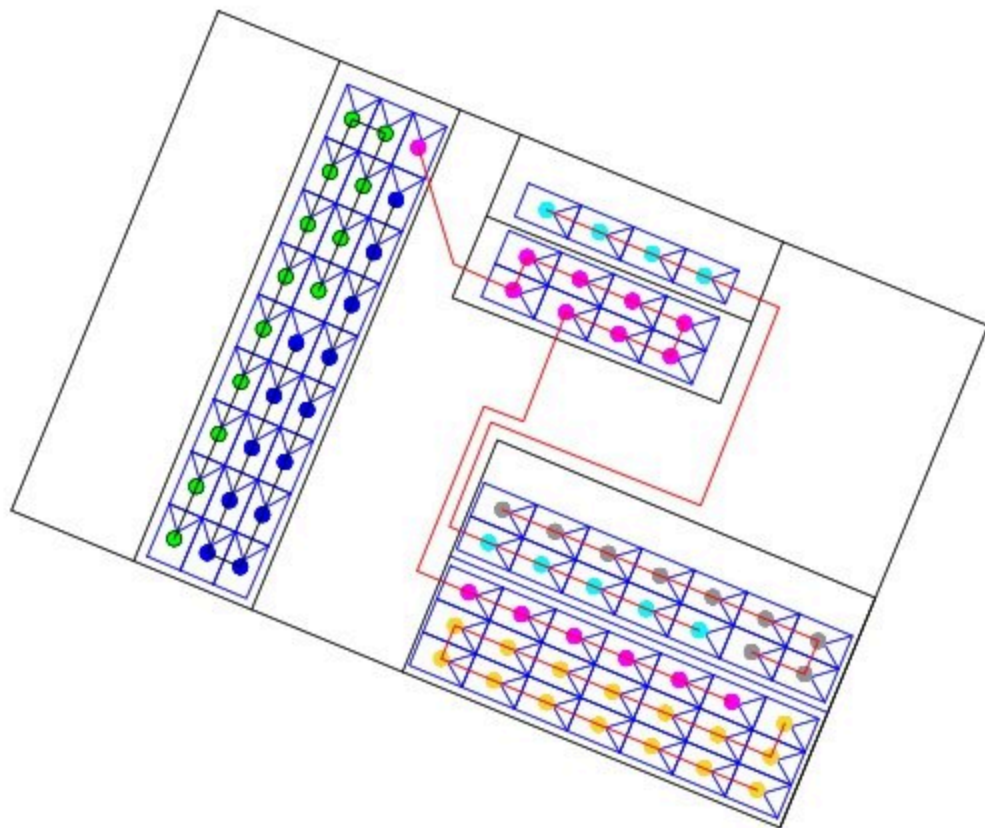

PROJETTO / CLIENT



BASHQA MIROITE - PRONTI/SA

CONSULENT / CONSULTANT



DESCRIZIONE / TECHNICAL NOTES

PROGETTO / PROJECT NAME

"INSTALLAZIONE E SISTEMI
FOTOVOLTAICI"

ZONA / LOCATION

BASHQA MIROITE

FASE E PROGETTO / PROJECT PHASE

PROGETTO ZSATSIS
IMPLEMENTATION DESIGN

PROGETTO ARCHITETTURA / ARCHITECTURAL DESIGN

Ark.Rajmonda MYDINELLARI
In L. 4.07/2012
MILANO/MIROITE/ITALY

PROGETTO INGEGNERIA / STRUCTURAL DESIGN

Ing. Massimo TARZIA
Milano/MIROITE

PROGETTO MONTAGNA / MOUNTING AND COILING

Ing. Angelo PERE
Milano/MIROITE

PROGETTO INGEGNERIA / MECHANICAL DESIGN

Ing. Andrea MEGGI
Milano/MIROITE

PROGETTO ELETTRICA / ELECTRICAL DESIGN

Ing. Kristian ZHURPA
Milano/MIROITE

DESCRIZIONE / FILETS / TITLE OF DESIGN

PLAN/REALIZATION/DATE

DISEGNO /

PROGETTO /

PROGETTO /

PROGETTO /

PROGETTO /

PROGETTO /

A-04

VERBA / STAMP

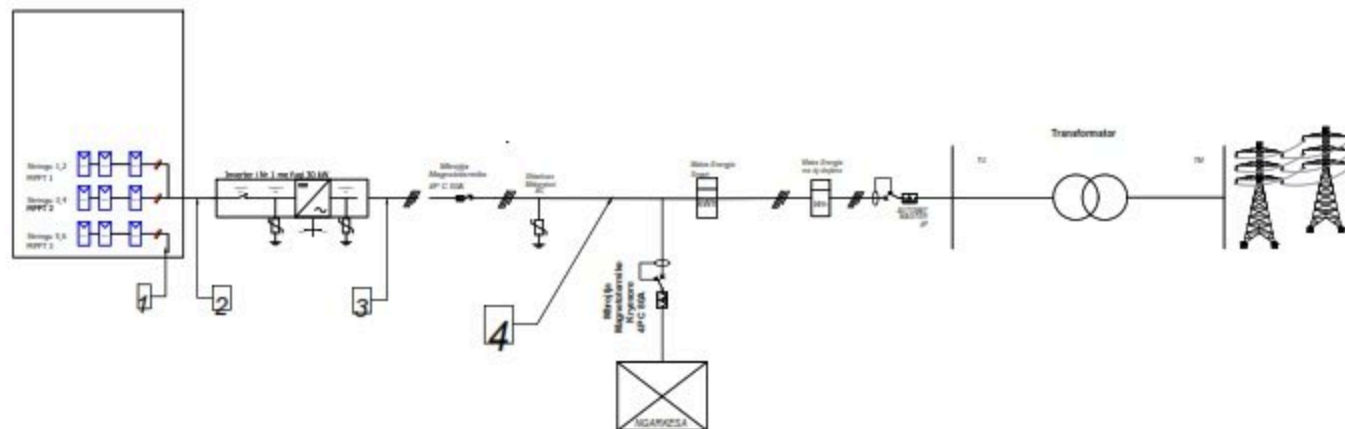

PROJEKTNO - LIST 01



БАНКА ЗА ЕНЕРГИЯ И ОКОЛНА СРЕДИНА

CONSULTANT



TECHNICAL NOTES

PROJECT - PROJECT NAME

"INSTALIMI I SISTEMIT FOTOVOLTAIK"

JOB - LOCATION

БАНКА ЗА ЕНЕРГИЯ И ОКОЛНА СРЕДИНА

PAGE # PROJECT - PROJECT NAME

PROJEKT ZBATMI I IMPLEMENTATION DESIGN

PROJECT ARCHITECTURE - ARCHITECTURAL DESIGN

Arch. Rajmond AYDINLARI

PROJECT ARCHITECTURE - STRUCTURAL DESIGN

Ing. Rashap TAPDA

PROJECT MECHANICAL - MECHANICAL DESIGN

Ing. Anjel PEVI

PROJECT ELECTRICAL - ELECTRICAL DESIGN

Ing. Merita MEGEV

PROJECT ELECTRICAL - ELECTRICAL DESIGN

Ing. Kristof ZHUPA

PROJECT MECHANICAL - MECHANICAL DESIGN

INGENIERSHIP

SCALE

PROJECT 2024

APP. / DATE

A-05

SCALE / STAMP

SKEMA E SISTEMIT TE MATJES

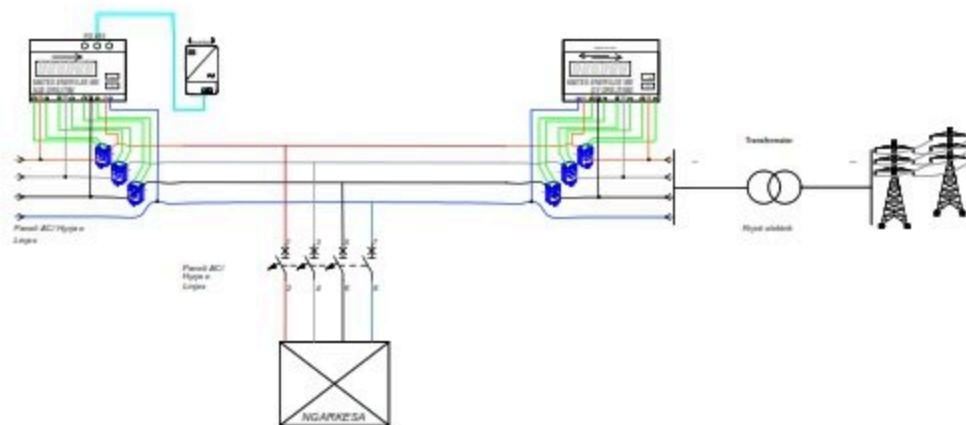

LEGJENDE	
	Shpreh
	Transformator
	Shpreh Mbrojtës
	Aktivitet
	Paneli Fotovoltaj
	Transformator
	Ngarkesë
	Ngarkesë

PROJEKTI: 13.04.2018



BASHKIA E PRISHTINËS

KONSULLANT: KONSULLANT



SHKURIM: TIRANE - TECHNICAL NOTES

PROJEKTI: PROJECT NAME

"INSTALIMI I SISTEMIT FOTOVOLTAIK"

JOZE: LOCATION

BASHKIA E PRISHTINËS

FAZJA: PROJECT / PROJECT PHASE

PROJEKTI ZBATIM / IMPLEMENTATION OF SIGN

PROJEKTI: ARCHITECTURE - ARCHITECTURAL DESIGN

Ark. Rajmonda MYDRELLARI

PROJEKTI: ARCHITECTURE - STRUCTURAL DESIGN

Ing. Rashap TAPDA

PROJEKTI: MECHANICAL - MECHANICAL DESIGN

Ing. Arqipe PEPI

PROJEKTI: ELECTRICAL - ELECTRICAL DESIGN

Ing. Merita MEGRI

PROJEKTI: ELECTRICAL - ELECTRICAL DESIGN

Ing. Kristaq ZHURPA

PROJEKTI: ELECTRICAL - ELECTRICAL DESIGN

SHKURIM: TIRANE

SHKURIM: TIRANE

SHKURIM: TIRANE

SHKURIM: TIRANE

A-06

SHKURIM: TIRANE

PROJEKTI FOTOVOLTAIK

OBJEKTI: "Future Mind Lufaj"

PROGRAMI: "Projektimi i Sistemit Fotovoltaik"

MBESHTETES: IPA II Cross Border Cooperation Programme for Albania- Kosovo

PERFITUES: Bashkia Mirditë



ZENIT&CO

Tiranë 2026



BASHKIA MIRDITE

PLANIMETRI E PËRGJITHËSHME E OBJEKTIT



PROJEKTI: 13.007



REPUBLIKA SHQIPTARE

KONKALISTI / CONSULTANT



ZENIT/CCO
ZEMËRIMET E SHËRIMIT
DHE PËRMBYETËSIA

10 Nëntori, Tiranë (Rr. Nr. 10, Apollonia 1000)
Tirane, Shqipëri
E-Mail: zenit@zenit.com

SHËNIMET / TECHNICAL NOTES

PROJEKTI / PROJECT NAME

**"INSTALIMI I SISTEMIT
FOTOVOLTAIK"**

FORMA / LOCATION

BAZHUKIA MRODITE

FASHA E PROJEKTI / PROJECT PHASE

**PROJEKTI ZBATIM
IMPLEMENTATION OF SIGN**

PROJEKTI ARCHITETUROR / ARCHITECTURAL DESIGN

Ark. Rajmonda MYDRELLARE

Rr. D. D. D. 10/2
BAZHUKIA MRODITE

PROJEKTI KONSOLIDIM / STRUCTURAL DESIGN

Ing. Rashap TAPDA

Rr. D. D. D. 10/2

PROJEKTI MARRËMIRË / ME PROJEKTIMIN

Ing. Arqipe PEPI

Rr. D. D. D. 10/2

PROJEKTI INDORENTOR / MECANICAL DESIGN

Ing. Merita MEGRI

Rr. D. D. D. 10/2

PROJEKTI ELEKTRIK / ELECTRICAL DESIGN

Ing. Kristaq ZHURPA

Rr. D. D. D. 10/2

SHËNIMET / NOTES / FIELD OF DESIGN

PLANIMETRI I SHËNIMIT

SHKALLA

1:100

SHKURTY 2006

SHËNIMET / NOTES

A-01

VLAKA / STAMP

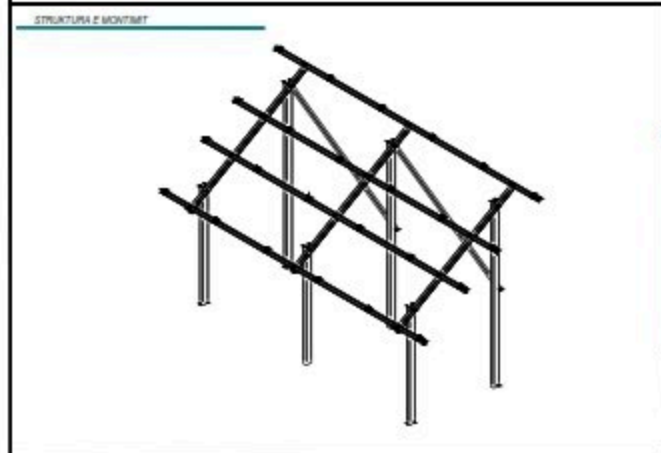
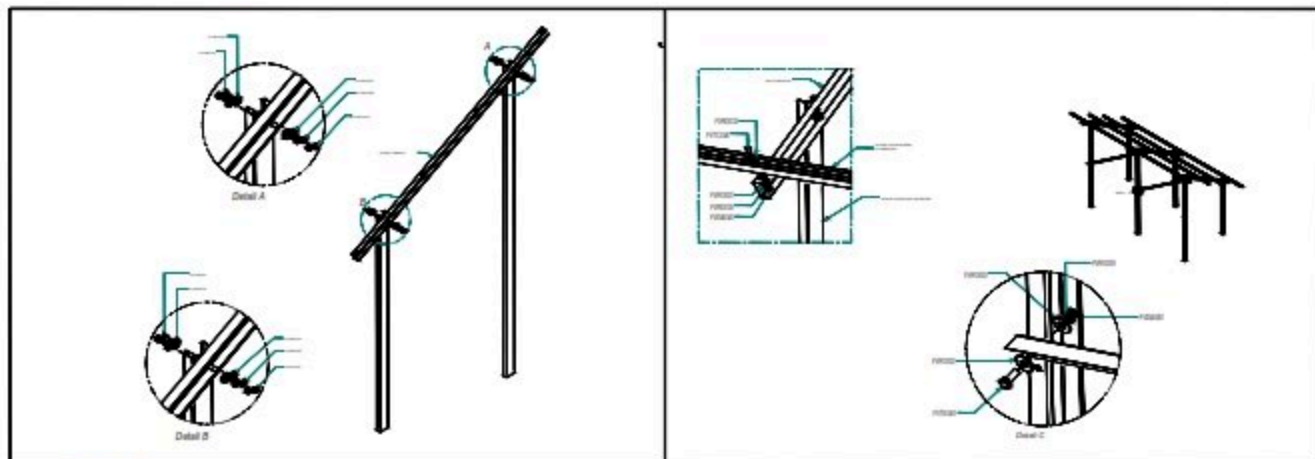

MATERIALI		MATERIALI	



BASHKIA E MIRDITES

KONSTRUKTIV - CONSULTANT



ZENITSCO

Str. Naim Frashëri, Nr. 15, Shkollë e Vjetër, Mirditë

Tel: +355 37 421 1111

Email: zenit@zenit.co

SHKURIM: TIRANE - TECHNICAL ARCHIVE

PROJECT / PROJECT NAME

"INSTALIMI I SISTEMIT FOTOVOLTAIK"

ZONE / LOCATION

BASHKIA E MIRDITES

PAGE / PROJECT / PROJECT NAME

PROJEKT ZBATIM / IMPLEMENTATION OF DESIGN

PROJECT ARCHITECTURE / ARCHITECTURAL DESIGN

Ark. Rajmonda MYDRELLARI

06-11-4-02-102

06-11-4-02-102

PROJECT ARCHITECTURE / STRUCTURAL DESIGN

Ing. Rishard XARDA

06-11-4-02-102

PROJECT ARCHITECTURE / MECHANICAL DESIGN

Ing. Ardit PEJTI

06-11-4-02-102

PROJECT ARCHITECTURE / ELECTRICAL DESIGN

Ing. Merita MESHU

06-11-4-02-102

PROJECT ARCHITECTURE / ELECTRICAL DESIGN

Ing. Kristaq ZHURTA

06-11-4-02-102

CLIENT'S NAME / TITLE OF DESIGN

KLIENTI E STRUKTURES METALIK

SHKALLA

1:100

SHKURT 2025

REVIZIONE / REVISIONS

A-02

SCALE / STAMP

STRUKTURA METALIKE

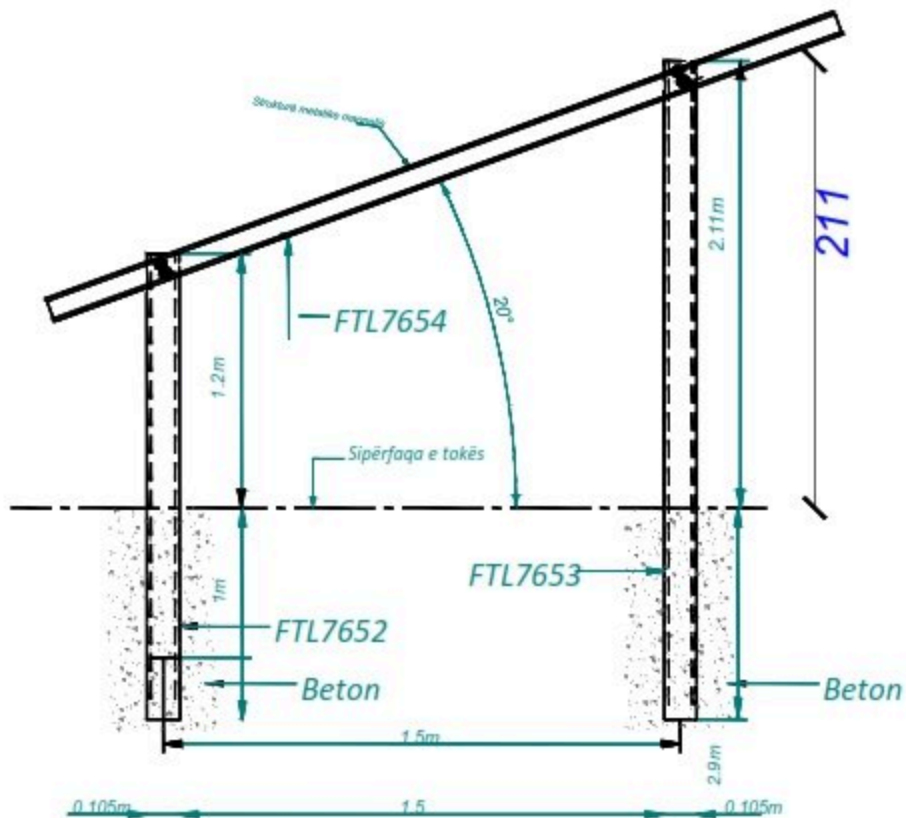

PROJEKTS: 13487



ENERĢĒTIKA ĪPAŠNĪBĀS

KONSULTĀNTS: KONSULTANTS



TEHNISKAIS ZĪMĒJUMS: TECHNICAL DRAWING

PROJEKTS: PROJECT NAME

"INSTALĪMI I SISTĒMIT FOTOVOLTAIKI"

VIETA: LOCATION

BAŠKIJA ĪPAŠNĪBĀS

FAZĒS: PROJECT / PROJECT PHASE

PROJEKTA ZĪMĒJUMS
IMPLEMENTATION DESIGN

PROJEKTA ARHITEKTONS: ARCHITECTURAL DESIGN

Arh. Rīgasnoda ĀRVIDREĻA
Rēģ. Nr. 14.02.02
Arh. Nr. 2015.04.01.02

PROJEKTA INĒINĒJUMS: STRUCTURAL DESIGN

Ing. Rihards TARDA
Rēģ. Nr. 2004

PROJEKTA MĀKŠINĀS: MECHANICAL DESIGN

Ing. Anrījs PEIŠIS
Rēģ. Nr. 2011

PROJEKTA INĒINĒJUMS: ELECTRICAL DESIGN

Ing. Māris MEGIŅIS
Rēģ. Nr. 2008

PROJEKTA INĒINĒJUMS: FIELD OF DESIGN

Ing. Kristaps ZHURBA
Rēģ. Nr. 2008

STRUKTŪRA METĀLIKA

SHĀLLA

SCHEMATIC

SHĀLLA

SHĀLLA

SHĀLLA

SHĀLLA

SHĀLLA

SHĀLLA

A-03

VIETA: STAMP

SKEMA ELEKTRIKE AC

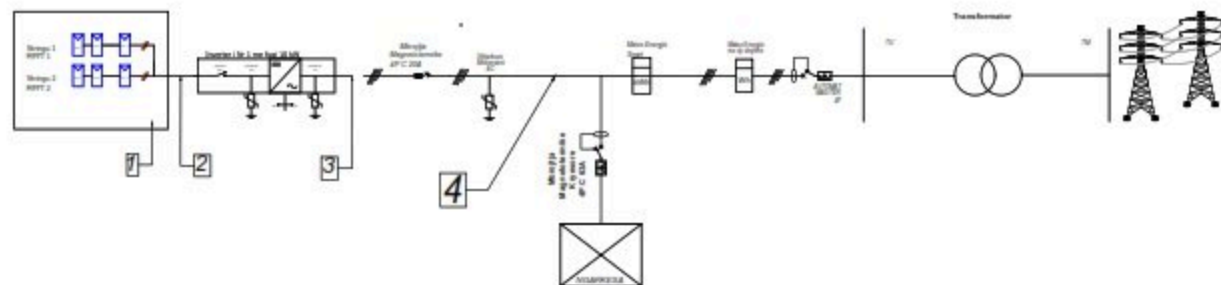

PROJEKCIJSKI LISTAR



BASHKIA MRODITE, REPUBLIC OF SERBIA

CONSULTANT



TECHNICAL NOTES

PROJECT / PROJECT NAME

"INSTALIMI I SISTEMIT FOTOVOLTAIK"

JOB / LOCATION

BASHKIA MRODITE

PHASE / PROJECT / PROJECT PHASE

PROJEKT ZBATMI / IMPLEMENTATION DESIGN

PROJECT ARCHITECTURE / ARCHITECTURAL DESIGN

Ark.Rajmonda MYDRELLARI

PROJECT ARCHITECTURE / STRUCTURAL DESIGN

Ing. Rashap TAPDA

PROJECT ARCHITECTURE / MECHANICAL DESIGN

Ing. Arqife PEJTI

PROJECT ARCHITECTURE / ELECTRICAL DESIGN

Ing. Merita MEGJVI

PROJECT ARCHITECTURE / FIELD OF DESIGN

Ing. Kiroq ZHUPA

PROJECT ARCHITECTURE / FIELD OF DESIGN

Ing. Kiroq ZHUPA

PROJECT ARCHITECTURE / FIELD OF DESIGN

Ing. Kiroq ZHUPA

PROJECT ARCHITECTURE / FIELD OF DESIGN

Ing. Kiroq ZHUPA

PROJECT ARCHITECTURE / FIELD OF DESIGN

Ing. Kiroq ZHUPA

PROJECT ARCHITECTURE / FIELD OF DESIGN

Ing. Kiroq ZHUPA

PROJECT ARCHITECTURE / FIELD OF DESIGN

Ing. Kiroq ZHUPA

PROJECT ARCHITECTURE / FIELD OF DESIGN

Ing. Kiroq ZHUPA

PROJECT ARCHITECTURE / FIELD OF DESIGN

Ing. Kiroq ZHUPA

PROJECT ARCHITECTURE / FIELD OF DESIGN

Ing. Kiroq ZHUPA

PROJECT ARCHITECTURE / FIELD OF DESIGN

Ing. Kiroq ZHUPA

PROJECT ARCHITECTURE / FIELD OF DESIGN

Ing. Kiroq ZHUPA

PROJECT ARCHITECTURE / FIELD OF DESIGN

Ing. Kiroq ZHUPA

PROJECT ARCHITECTURE / FIELD OF DESIGN

Ing. Kiroq ZHUPA

PROJECT ARCHITECTURE / FIELD OF DESIGN

Ing. Kiroq ZHUPA

PROJECT ARCHITECTURE / FIELD OF DESIGN

Ing. Kiroq ZHUPA

SCALE

SCALE

SCALE

SCALE

SCALE

SCALE

SCALE

SCALE

SCALE

SCALE

SCALE

SCALE

SCALE

SCALE

SCALE

SCALE

SCALE

SCALE

SCALE

SCALE

SCALE

SCALE

SCALE

SCALE

SCALE

SCALE

SCALE

SCALE

A-04

SCALE

SCALE

SCALE

SCALE

SCALE

SCALE

SCALE

SCALE

SCALE

SCALE

SKEMA E SISTEMIT TE MATJES

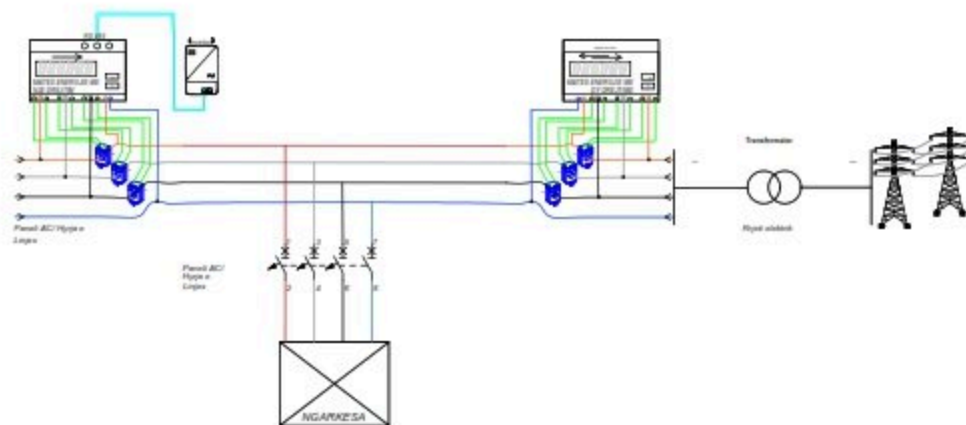

LEGJENDE	
	Panel
	Transformator
	Shkëmb Mbrojtës
	Axhoni Shpërndarës
	Stacion Energji Ndërkohor
	Transformator
	Rreth 0.4/10 KV
	Rreth 0.4/10 KV
	Rreth 0.4/10 KV

PROJEKTI: 13.04.2017



BASHKIA E RRETHIT, PRIZREN

KONSOLEJTI / CONSULTANT



ZENITBCC

Prizren, Tjetër (Nr. 10, qyteti i Prizrenit)

Tel: +383 45 311 111

E-Mail: zenitb@zenitb.com

SHKËMBI / TECHNICAL NOTES

PROJEKTI / PROJECT NAME

"INSTALIMI I SISTEMIT FOTOVOLTAIK"

POSHTA / LOCATION

BASHKIA E RRETHIT

FASHA E PROJEKTI / PROJECT PHASE

PROJEKTI ZBATIM / IMPLEMENTATION OF DESIGN

PROJEKTI ARCHITETUROR / ARCHITECTURAL DESIGN

Ark. Rajmonda MYDRELLARI

Nr. 11-02/102

Datë: 08.02.2017

PROJEKTI KONSTRUKTIV / STRUCTURAL DESIGN

Ing. Rashap TAPDA

Nr. 11-02/102

PROJEKTI MËRIMOR / MEASUREMENT AND CHECKING

Ing. Arqipe PEPI

Nr. 11-02/102

PROJEKTI INDORENTOR / MUNICIPAL DESIGN

Ing. Merita MEGRI

Nr. 11-02/102

PROJEKTI ELEKTRIK / ELECTRICAL DESIGN

Ing. Kristaq ZHURPA

Nr. 11-02/102

SHKËMBI / NOTES / FIELD OF DESIGN

SHKËMBI / NOTES / FIELD OF DESIGN

SHKALLA

1:1

SHKËMBI / NOTES

SHKËMBI / NOTES

A-05

VLAKA / STAMP

PROJEKTI FOTOVOLTAIK

OBJEKTI: "Kopshti i Gjinnazi Rrëshen"

PROGRAMI: "Projektimi i Sistemit Fotovoltaik 16.65 kWp"

MBESHTETES: IPA II Cross Border Cooperation Programme for Albania- Kosovo

PERFITUES: Bashkia Mirditë



ZENIT&CO



BASHKIA MIRDITE

Tiranë 2026

PLANIMETRI E PËRGJITHËSHME E OBJEKTIT

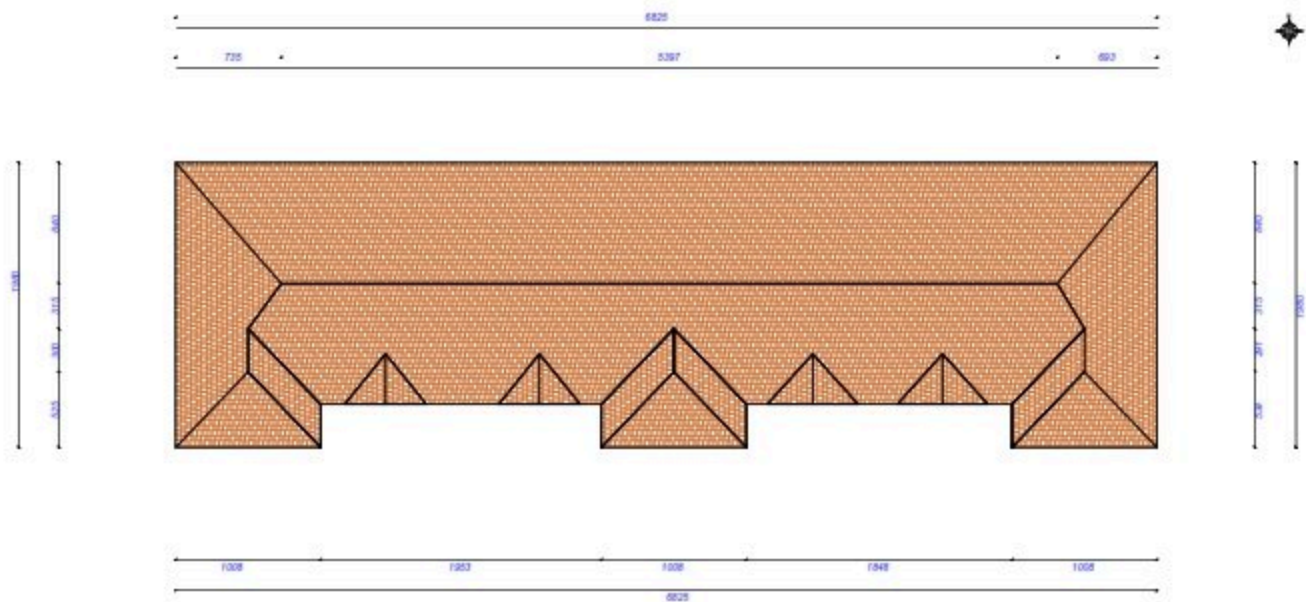

PROJEKTI - 13.007



BASHKIA E PRIZRENIT

KONSULENT - CONSULTANT



ZENITSCO
Zemë e Re
P.O. Box 100, Prizren, Kosovo
T: +383 45 210 000
E: info@zenit.co

SHKËMBIM TËRISHT - TECHNICAL NOTES

PROJEKT - PROJECT NAME

"INSTALIMI I SISTEMIT FOTOVOLTAIK"

ZONA - LOCATION

BASHKIA E PRIZRENIT

FASË E PROJEKTI - PROJECT PHASE

PROJEKT ZBATIM / IMPLEMENTATION OF SIGN

PROJEKTI ARCHITETUROR - ARCHITECTURAL DESIGN

Ark. Rigonda MYDRELLARI
P.O. Box 100 Prizren

PROJEKTI KONSOLIDIM / STRUCTURAL DESIGN

Ing. Rashap TAPDA
P.O. Box 100 Prizren

PROJEKTI SHPËRTHIM / MECHANICAL DESIGN

Ing. Arifë PEPI
P.O. Box 100 Prizren

PROJEKTI SHPËRTHIM / ELECTRICAL DESIGN

Ing. Merita MESHU
P.O. Box 100 Prizren

PROJEKTI SHPËRTHIM / FIELD OF DESIGN

Ing. Kërdiq ZHURPA
P.O. Box 100 Prizren

SHKALLA

1:1000

SHKËMBIM TËRISHT

SHKËMBIM TËRISHT

A-01

VLAKA / STAMP

PLANIMETRI E PËRGJITHËSHME E OBJEKTIT

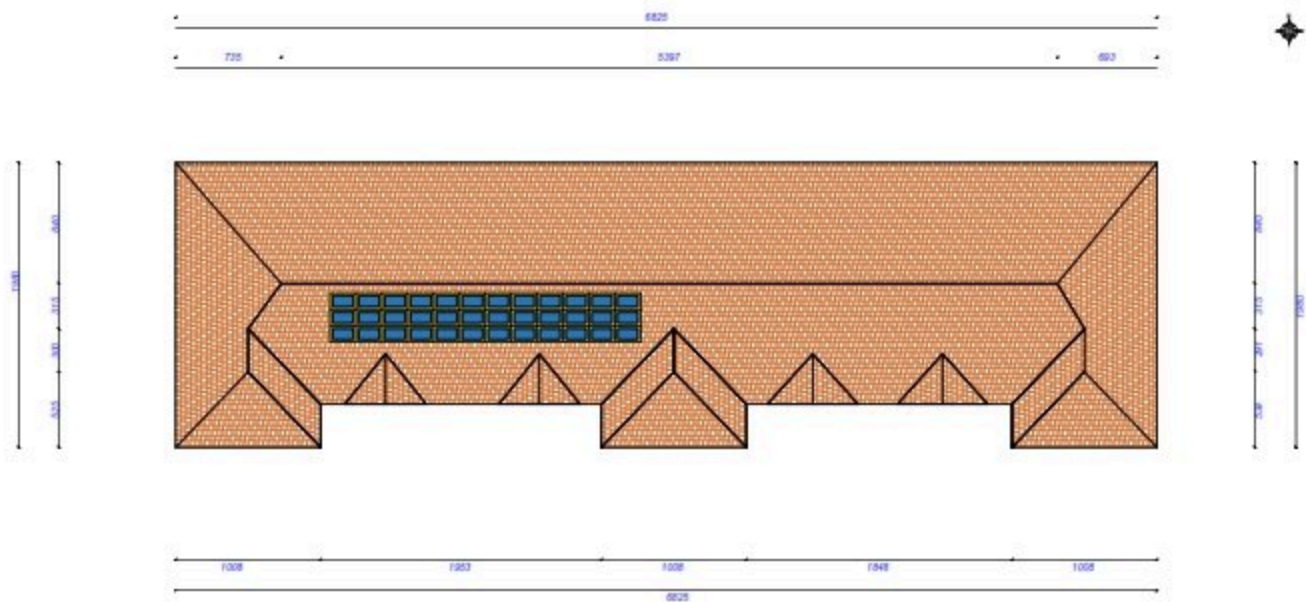

PROJEKTI - 13.04.2017



BASHKIA E PRISHTINES

KONSULENT - KONSULANT



SHKURTYE TEKNIKE - TECHNICAL NOTES

PROJEKTI - PROJECT NAME

"INSTALIMI I SISTEMIT FOTOVOLTAIK"

FORMA - LOCATION

BASHKIA E PRISHTINES

FASHA E PROJEKTIUT - PROJECT PHASE

PROJEKT ZBATIM / IMPLEMENTATION OF SIGN

PROJEKTI ARHITEKTONIK - ARCHITECTURAL DESIGN

Ark. Rigonda MYDRELLARI
06-11-02-1012
06-11-02-1012

PROJEKTI INZHINIERI - STRUCTURAL DESIGN

Ing. Rishap TAPDA
06-11-02-1012

PROJEKTI SHPËRTHYER - ME PËRIMARRJE

Ing. Arqife PEPI
06-11-02-1012

PROJEKTI INZHINIERI - MECANIKAL DESIGN

Ing. Merita MESHU
06-11-02-1012

PROJEKTI INZHINIERI - ELEKTRIKAL DESIGN

Ing. Kristaq ZHURPA
06-11-02-1012

PROJEKTI INZHINIERI - FIZIKAL DESIGN

Ing. Kristaq ZHURPA
06-11-02-1012

SHKALLA

1:1000

SHKURTYE 2006

SHKURTYE - SYMBOLS

A-02

VLAKA / STAMP

PLANIMETRI E PËRGJITHËSHME E OBJEKTIT

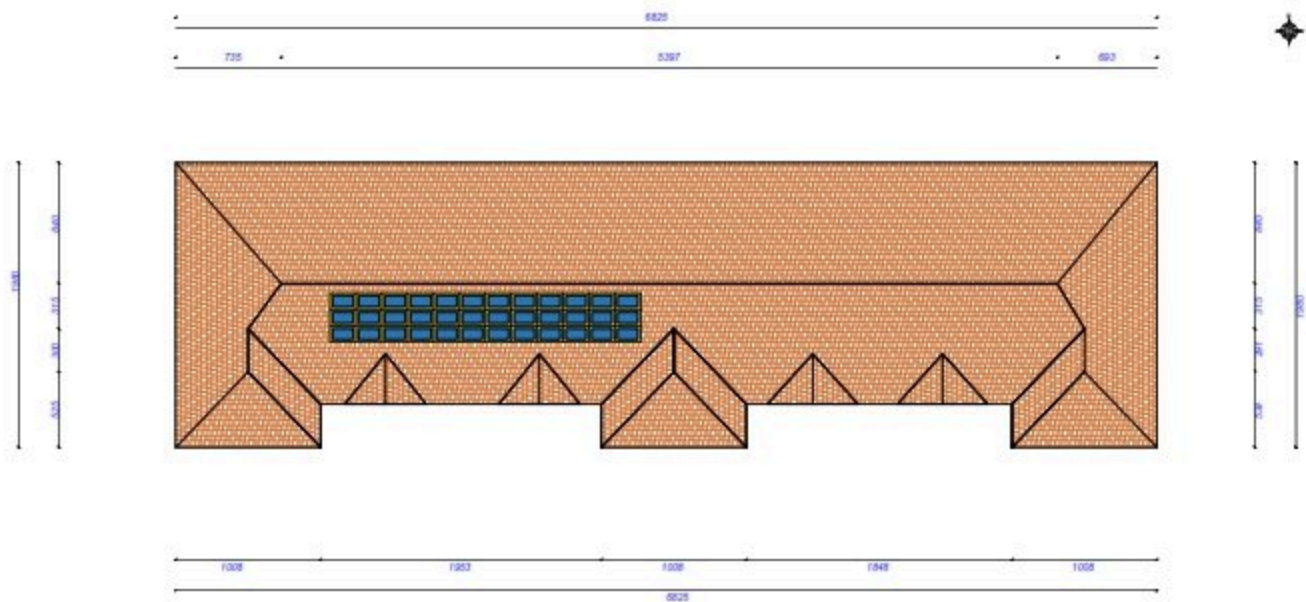

PROJEKTI - 13.08.17



BASHKIA MBRODITE, PRRYPITUR

KONSULENT - KONSULANT



ZENITSCO

16 Shkurtorë, Tiranë (Rr. 19 Aprilit, 1002)

Tel: +355 67 800 000

E-Mail: zenit@zenit.com

SHKURIME TËRHEQUR - TECHNICAL NOTES

PROJEKTI - PROJECT NAME

"INSTALIMI I SISTEMIT FOTOVOLTAIK"

ZONA - LOCATION

BASHKIA MBRODITE

FASHA E PROJEKTI - PROJECT PHASE

PROJEKT ZBATIM / IMPLEMENTATION DESIGN

PROJEKTI ARCHITETUROR - ARCHITECTURAL DESIGN

Ark. Rigjonda MYDRELLARI

Rr. 19 Aprilit 1002

Bashkia Mbrodite, Tiranë

PROJEKTI INZHINIEROR - STRUCTURAL DESIGN

Ing. Rishap TAPDA

Bashkia Mbrodite

PROJEKTI SHPËRTHYER - ME PROJEKTIM DHE KULLIM

Ing. Arqipe PEPI

Bashkia Mbrodite

PROJEKTI INZHINIEROR - MEKANIKAL DESIGN

Ing. Merita MESHU

Bashkia Mbrodite

PROJEKTI INZHINIEROR - ELEKTRIKAL DESIGN

Ing. Kristaq ZHURPA

Bashkia Mbrodite

SHKURIME TËRHEQUR / FIELD OF DESIGN

PLANIMETRI I PËRGJITHËSH

SHKALLA

1:1000

SHKURIMI 2020

SHKURIMI / DRAWING NO.

A-02

VLKA / STAMP

DIMENSIONET E SIPERFAQES KU DO TE VENDOSEN PANELET FOTOVOLTAIKE

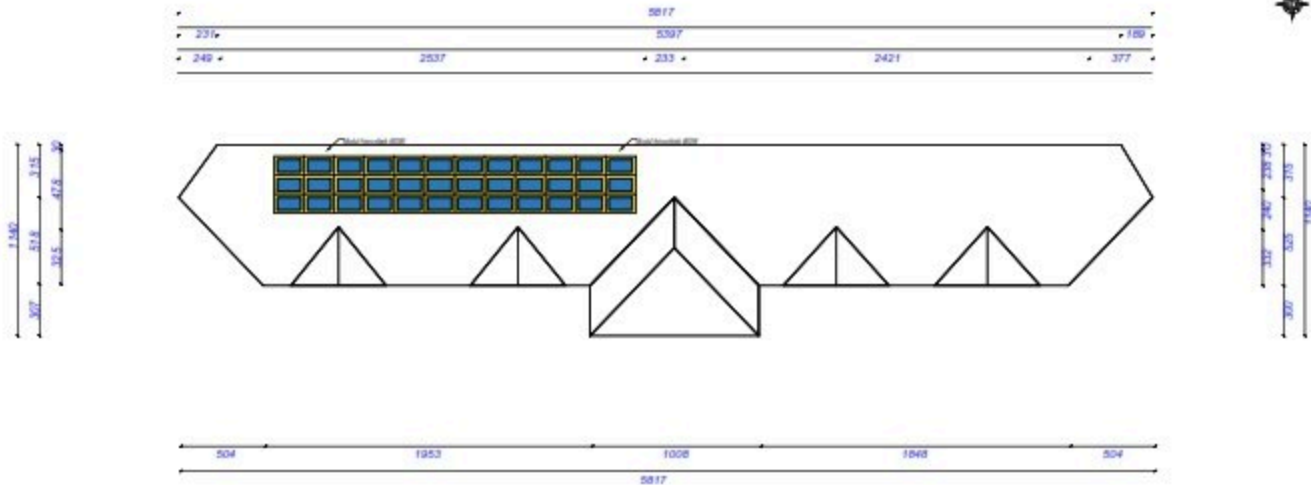

PROJEKTI: 13.007



BASHKIA MBRODITE, PRRYPITUR

KONSOLEJTI: KONSOLEJANT



ZENITSCO
 ZENIT CONSULTING
 16 Mbrodit, Tuzi (Rr. 19 qersori, 1002)
 T. 030 460000
 E. info.zenit@ze.com

DOKUMENTI: TIRAZHIM / TECHNICAL NOTES

PROJEKTI: PROJECT NAME

"INSTALIMI I SISTEMIT FOTOVOLTAIK"

ZONA / LOCATION

BASHKIA MBRODITE

FASHA E PROJEKTI: PROJECT PHASE

PROJEKT ZBATIM / IMPLEMENTATION DESIGN

PROJEKTI: ARCHITECTURE - ARCHITECTURAL DESIGN

Ark. Rajmonda MYDRELLARI

Rr. D. D. 102

Bashkia Mbrodite, Tuzi

PROJEKTI: ARCHITECTURE - STRUCTURAL DESIGN

Ing. Rashap TAPDA

Rr. D. D. 102

PROJEKTI: ARCHITECTURE - MECHANICAL DESIGN

Ing. Arqipe FERI

Rr. D. D. 102

PROJEKTI: ARCHITECTURE - ELECTRICAL DESIGN

Ing. Merita MEGRI

Rr. D. D. 102

PROJEKTI: ELECTRICIAN / ELECTRICAL DESIGN

Ing. Kristaq ZHURPA

Rr. D. D. 102

EMRYTETI I PLETES / FIELD OF DESIGN

DARËSHIMI E SHËRBUESI KU DO TE VENDOSEN PANELET

SHKALLA

1:100

SHKURT 2020

SHËRBUESI / CONSULTANT

A-03

VLAJE / STAMP

DIMENSIONET E SIPERFAQES KU DO TE VENDOSEN PANELET FOTOVOLTAIKE

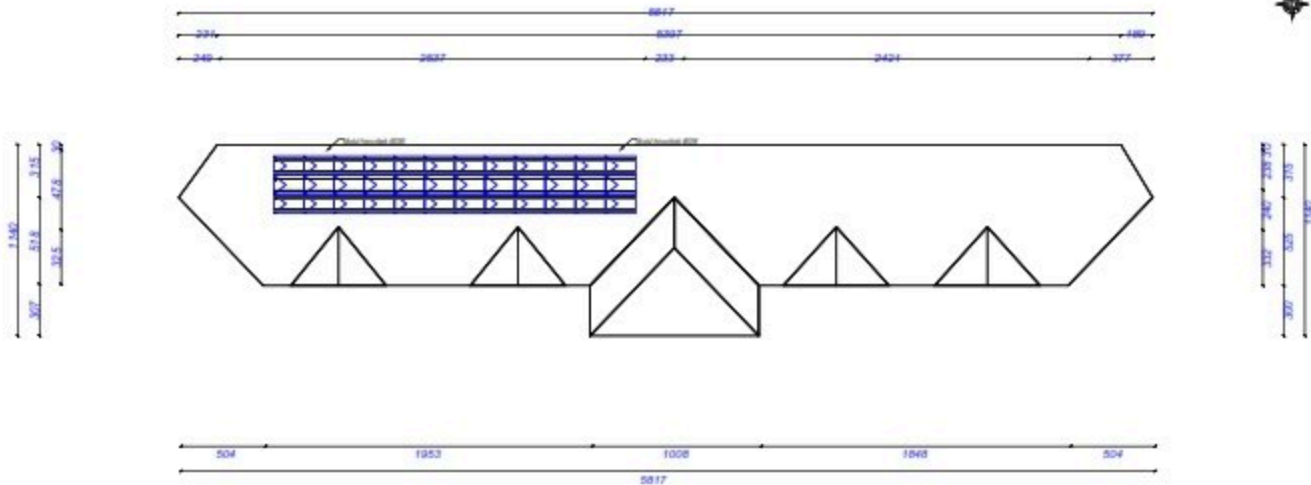

PROJEKTI: 13.007



BASHKIA MIRDITE, PRRYPITJE

KONSULENT: KONSULANT



DOKUMENTI: TENDERO / TECHNICAL NOTES

PROJECT: PROJECT NAME

"INSTALIMI I SISTEMIT FOTOVOLTAIK"

FORM: LOCATION

BASHKIA MIRDITE

PHASE: PROJECT / PROJECT PHASE

PROJEKT ZBATIM / IMPLEMENTATION DESIGN

PROJECT ARCHITECTURE / ARCHITECTURAL DESIGN

Ark. Rajmonda MYDRELLARI

Rr. 19 qershorit, 1002

030 4400000

PROJECT ARCHITECTURE / STRUCTURAL DESIGN

Ing. Rashap XARDA

Rr. 19 qershorit, 1002

030 4400000

PROJECT ARCHITECTURE / MECHANICAL DESIGN

Ing. Ardit PEJ

Rr. 19 qershorit, 1002

030 4400000

PROJECT ARCHITECTURE / ELECTRICAL DESIGN

Ing. Merita MEGRI

Rr. 19 qershorit, 1002

030 4400000

PROJECT ARCHITECTURE / FIELD OF DESIGN

DIMENSIONET E SIPERFAQES KU DO TE VENDOSEN PANELET FOTOVOLTAIKE

030 4400000

030 4400000

030 4400000

030 4400000

030 4400000

030 4400000

030 4400000

030 4400000

030 4400000

030 4400000

030 4400000

030 4400000

030 4400000

030 4400000

030 4400000

030 4400000

030 4400000

030 4400000

030 4400000

030 4400000

030 4400000

030 4400000

SHALLA

SHALLA

SHALLA

SHALLA

SHALLA

SHALLA

SHALLA

SHALLA

SHALLA

SHALLA

SHALLA

SHALLA

SHALLA

SHALLA

SHALLA / SHALLA

SHALLA / SHALLA

SHALLA / SHALLA

SHALLA / SHALLA

SHALLA / SHALLA

SHALLA / SHALLA

SHALLA / SHALLA

SHALLA / SHALLA

SHALLA / SHALLA

SHALLA / SHALLA

SHALLA / SHALLA

SHALLA / SHALLA

SHALLA / SHALLA

SHALLA / SHALLA

A-04

SHALLA / STAMP

DIMENSIONET E SIPERFAQES KU DO TE VENDOSEN PANELET FOTOVOLTAIKE

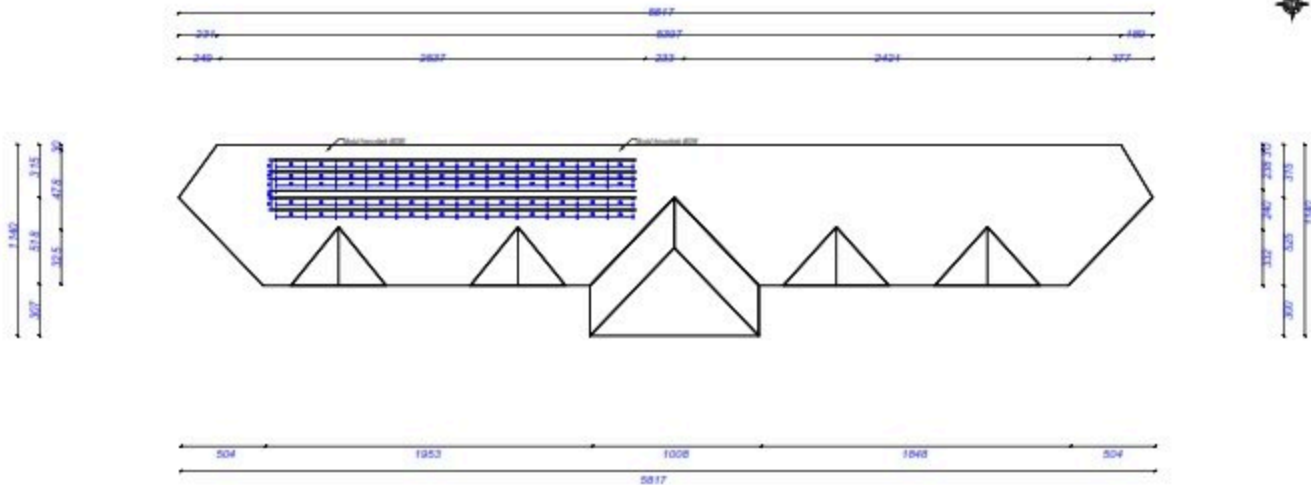

PROJEKTI: 13.007



BASHKIA E RRETHIT TË PRIZRINIT

KONSOLEJTI / CONSULTANT



SHKREBI TËRBUJËR / TECHNICAL NOTES

PROJEKTI / PROJECT NAME

"INSTALIMI I SISTEMIT FOTOVOLTAIK"

FORMA / LOCATION

BASHKIA E RRETHIT TË PRIZRINIT

FASJA E PROJEKTI / PROJECT PHASE

PROJEKT ZBATIM / IMPLEMENTATION DESIGN

PROJEKTI ARCHITETUROR / ARCHITECTURAL DESIGN

Ark. Rajmonda MYDRELLARI

PROJEKTI INZHINIEROR / STRUCTURAL DESIGN

Ing. Rashap TAPDA

PROJEKTI SHKURIMOR / ME PROJEKTIM DHE KULLIMOR

Ing. Arqipe FERIS

PROJEKTI INZHINIEROR / PRINCIPAL DESIGN

Ing. Merita MEGRI

PROJEKTI ELEKTRIKOR / ELECTRICAL DESIGN

Ing. Kristaq ZHURPA

FAZJA E ANALIZËS / FIELD OF DESIGN

DIMENSIONET E SIPERFAQES KU DO TE VENDOSEN PANJELET

SHKALLA

SHKURT 2020

SHKURT / DRAWING NO.

A-05

VLAKA / STAMP

SKEMA ELEKTRIKE AC

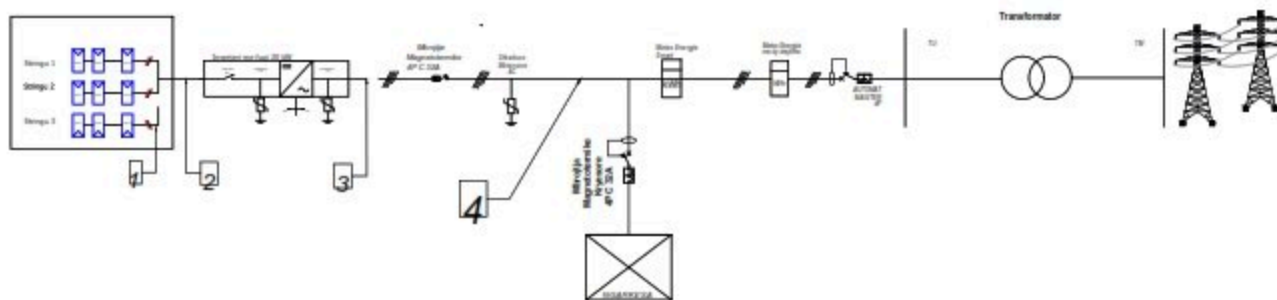

PROJEKTOVALNA



BASHKIA MIRDITE, REPUBLIKË

KONSULTANT / CONSULTANT



ZENITECO
Rr. Shën Kollit Nr. 13, Apollon, Mirdite
t.036 440000
e.zeniteco@gmail.com

SHKURIM: TIRAZH / TECHNICAL NOTES

PROJEKTI / PROJECT NAME

"INSTALIMI I SISTEMIT
FOTOVOLTAIK"

QARË / LOCATION

BASHKIA MIRDITE

FASË E PROJEKTI / PROJECT PHASE

PROJEKT ZBATIM
IMPLEMENTATION DESIGN

PROJEKTI ARCHITETUROR - ARCHITECTURAL DESIGN

Ark. Rajmonda MYDRELLARI

Rr. Shën Kollit Nr. 13, Apollon, Mirdite

PROJEKTI KONSTRUKTIV - STRUCTURAL DESIGN

Ing. Rashap TAPDA

Rr. Shën Kollit Nr. 13, Apollon, Mirdite

PROJEKTI SHPËRIMOR - HEAT INSULATION DESIGN

Ing. Argjesh PEXH

Rr. Shën Kollit Nr. 13, Apollon, Mirdite

PROJEKTI HEDHËSITËR - MUNICIPAL DESIGN

Ing. Merita MEGRI

Rr. Shën Kollit Nr. 13, Apollon, Mirdite

PROJEKTI ELEKTRIK / ELECTRICAL DESIGN

Ing. Kristaq ZHURJA

Rr. Shën Kollit Nr. 13, Apollon, Mirdite

EMËRTIM I ALBËSIT / TITLE OF DESIGN

SHKURIM ELEKTRIK AC

SHKALLA

1:1000

SHKURT 2025

SHKURIM / CONSULTANT

A-06

VLK / STAMP

DIMENSIONET E INVERTERIT

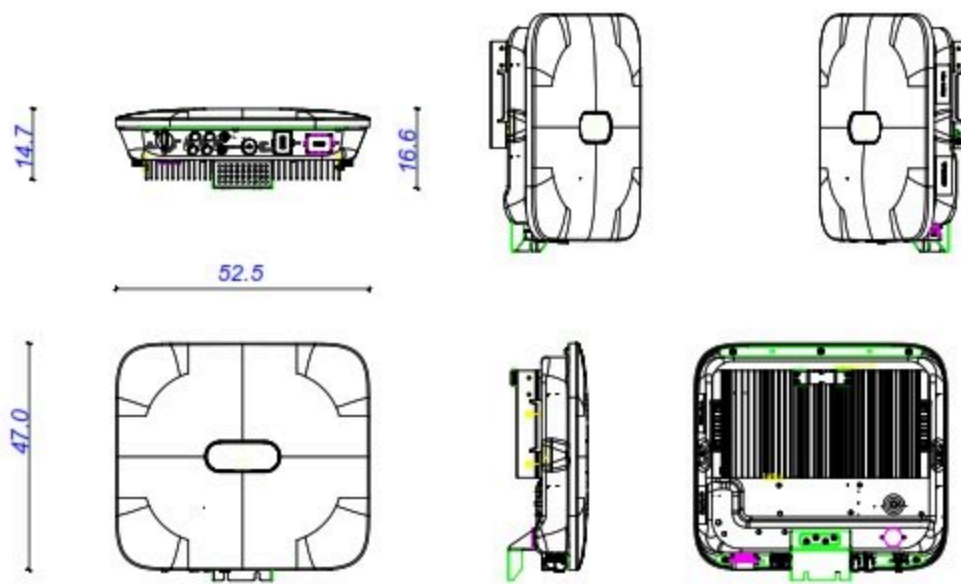

BASHKIA MIRODITE, REPUBLIKË E SHqipërisë

KONSULLANT / CONSULTANT



SHKËMBIM TËRBUJËR / TECHNICAL NOTES

PROJEKTI / PROJECT NAME

"INSTALIMI I SISTEMIT FOTOVOLTAIK"

ZONA / LOCATION

BASHKIA MIRODITE

FASË E PROJEKTI / PROJECT PHASE

PROJEKTI ZBATIM / IMPLEMENTATION DESIGN

PROJEKTI ARCHITETONIK / ARCHITECTURAL DESIGN

Ark. Rajmonda MYDRELLARI
Nr. 11-4, 02 TIRË
Bashkia MIRODITE, SHqipëria

PROJEKTI INZHINIERI / STRUCTURAL DESIGN

Ing. Rishap TAPIDA
Bashkia MIRODITE

PROJEKTI SHPËRIMOR / MEK. PROJ. AND COOLING

Ing. Arqipe PEPI
Bashkia MIRODITE

PROJEKTI INZHINIERI / ELECTRICAL DESIGN

Ing. Merita MEGYI
Bashkia MIRODITE

PROJEKTI INZHINIERI / ELECTRICAL DESIGN

Ing. Kristaq ZHURPA
Bashkia MIRODITE

INZHINIERI / ARCHIT. / TITLE OF DESIGN

DIAMONDIT & SHPARTORI

SHKALLA

1:1

SHKALLA / SCALE

SHKËMBIM TËRBUJËR

A-07

VLAKA / STAMP

SKEMA E SISTEMIT TE MATJES

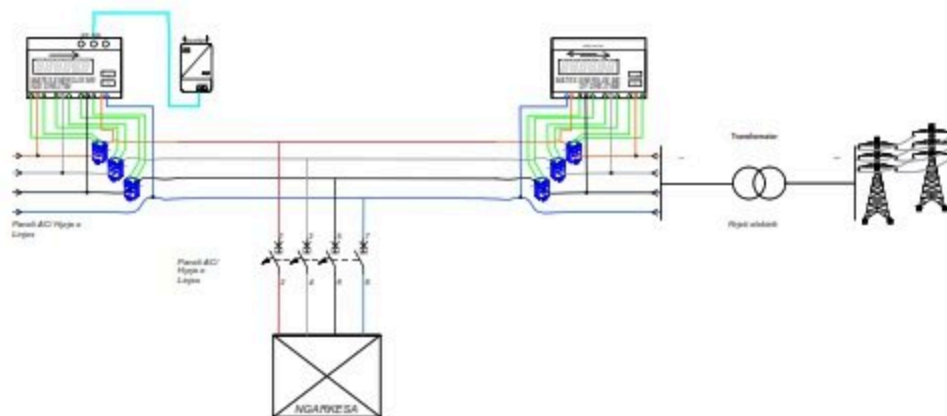

LEGJENDE	
	Inverter
	Transformator
	Rregullues Elektrik
	Paneli AC/ Faza e Lajzes
	Ngarkesa
	Transformator
	Rregullues Elektrik

PROJEKTI: 12487



BASHKIA E RRETHIT TË PRIZRENIT

KONKALISTI: KONKALISTI



SHKURIME: SHKURIME - TECHNICAL NOTES

PROJEKTI: PROJECT NAME

"INSTALIMI I SISTEMIT FOTOVOLTAIK"

ZONE: LOCATION

BASHKIA E RRETHIT TË PRIZRENIT

PAGE E PROJEKTI: PROJECT PAGE

PROJEKTI ZBATIM / IMPLEMENTATION OF SIGN

PROJEKTI ARCHITECTONIK / ARCHITECTURAL DESIGN

Ark. Rajmonda MYDRELLARI

06.11.2022

06.11.2022

PROJEKTI KONSTRUKTIV / STRUCTURAL DESIGN

Ing. Rashap TAPDA

06.11.2022

PROJEKTI MASHINORIE / MEK. PROJ. AND COOLING

Ing. Arqipe PEPI

06.11.2022

PROJEKTI HEDHMBARTES / MUNICIPAL DESIGN

Ing. Merita MEGRI

06.11.2022

PROJEKTI ELEKTRIK / ELECTRICAL DESIGN

Ing. Kristaq ZHURPA

06.11.2022

SHKURIME: SHKURIME / TABLE OF CONTENT

SHKURIME: SHKURIME

SHKALLA

SHKURIME

SHKURIME

SHKURIME: SHKURIME

A-08

VELA / STAMP

PLANVENDOSJA E INVERTERIT

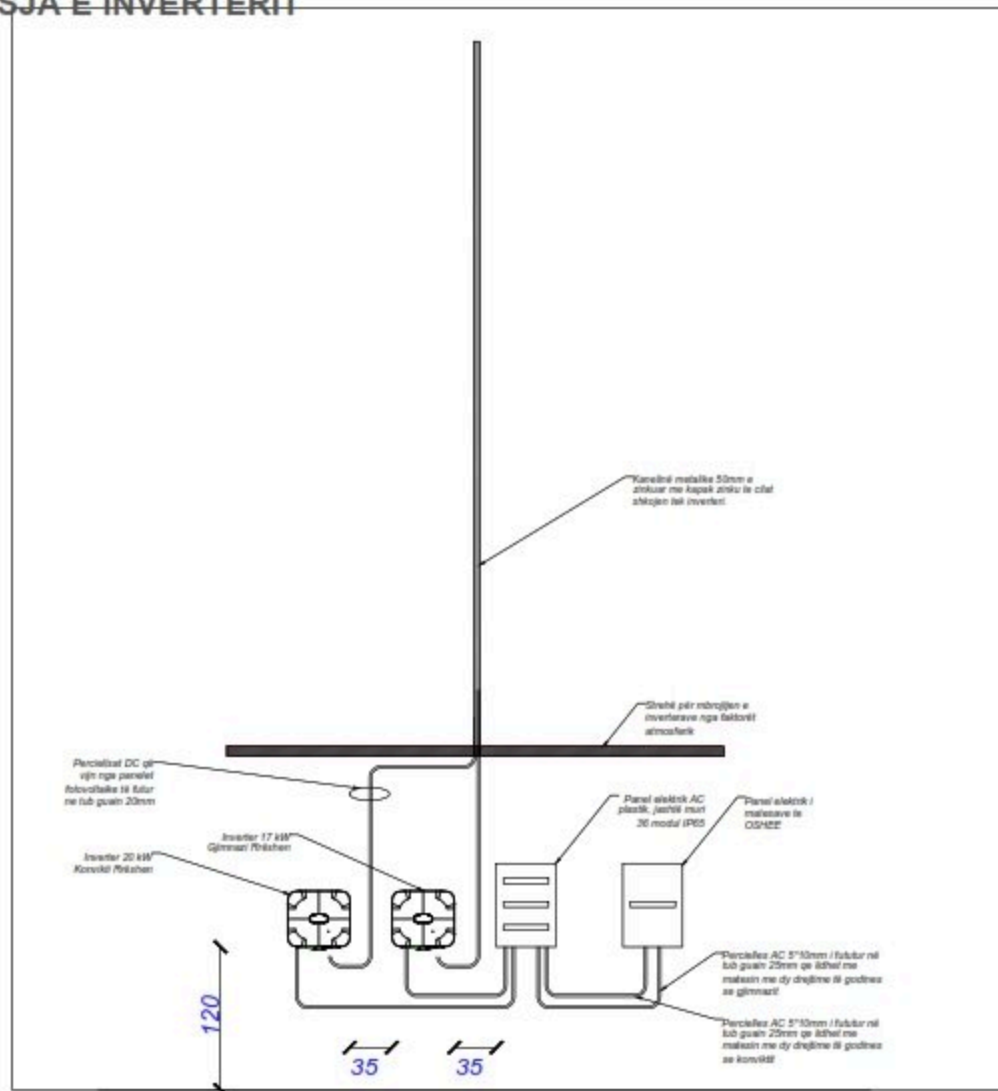

PROJEKTI 13-08/17



BASHKIA E PRIZRINIT

KONSOLEJTI / CONSULTANT



SHKREMBE / DRAWING - TECHNICAL NOTICE

PROJECT / PROJECT NAME

"INSTALIMI I SISTEMIT FOTOVOLTAIK"

ZONE / LOCATION

BASHKIA E PRIZRINIT

PAGE / PROJECT / PROJECT PHASE

PROJEKT ZBATIM / IMPLEMENTATION OF DESIGN

PROJECT ARCHITECTURE / ARCHITECTURAL DESIGN

Ark. Rigonda MYDRELLARI

06.11.2017

06.11.2017

PROJECT ARCHITECTURE / STRUCTURAL DESIGN

Ing. Rashap TAPDA

06.11.2017

PROJECT ARCHITECTURE / MECHANICAL DESIGN

Ing. Ardit PEPI

06.11.2017

PROJECT ARCHITECTURE / ELECTRICAL DESIGN

Ing. Merita MEGRI

06.11.2017

PROJECT ARCHITECTURE / ELECTRICAL DESIGN

Ing. Kristaq ZHURPA

06.11.2017

PROJECT ARCHITECTURE / FIELD OF DESIGN

PLANIMETRIJA E SHKREMBES

SHKALLA

1:100

SHKURTY 2016

06.11.2017

REVIZIONI / REVISION

A-09

VLAK / STAMP

PROJEKTI FOTOVOLTAIK

OBJEKTI: "Info Kulla"

PROGRAMI: "Projektimi i Sistemit Fotovoltaik 19.32kWp"

MBESHTETES: IPA II Cross Border Cooperation Programme for Albania- Kosovo

PERFITUES: Bashkia Mirditë



ZENIT&CO

Tiranë 2026



BASHKIA MIRDITE

PLANIMETRI E PËRGJITHËSHME E OBJEKTIT

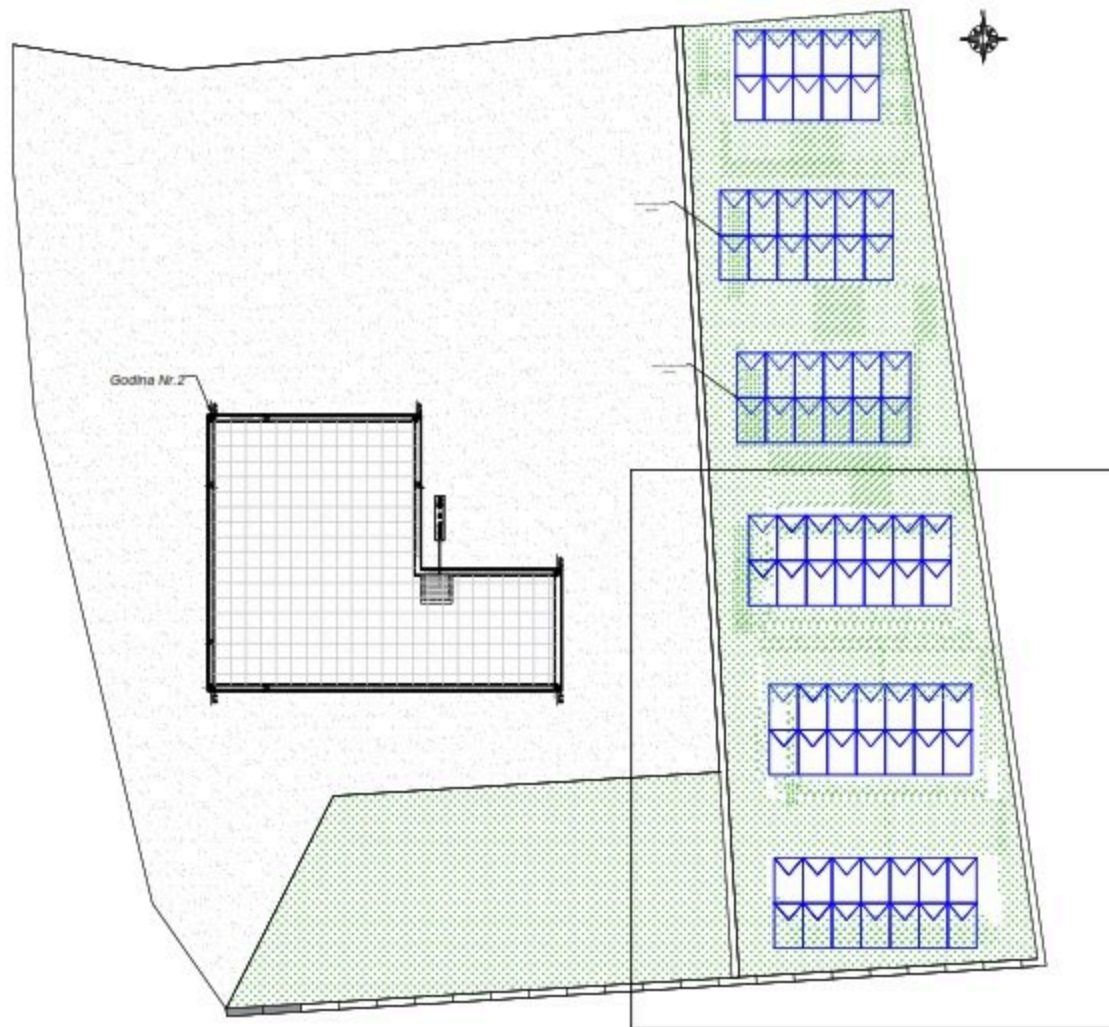

PROJEKTI: 13.007



REPUBLICA SHQIPTARE, PËRQYKË

KONSOLEJTI / CONSULTANT



SHËRBIM: TËRBUKË / TECHNICAL SERVICE

PROJEKTI / PROJECT NAME

"INSTALIMI I SISTEMIT FOTOVOLTAIK"

ZONA / LOCATION

BASHKËIA MRODITZ

FASË E PROJEKTI / PROJECT PHASE

PROJEKT ZBATIM / IMPLEMENTATION DESIGN

PROJEKTI ARCHITETUROR / ARCHITECTURAL DESIGN

Ark. Rajmonda MYDRELLARI

06.11.2023

06.11.2023

PROJEKTI INZHINIEROR / STRUCTURAL DESIGN

Ing. Rishap TAPDA

06.11.2023

PROJEKTI MASHINOR / MECHANICAL DESIGN

Ing. Arqipe PEPI

06.11.2023

PROJEKTI INZHINIEROR / ELECTRICAL DESIGN

Ing. Merita MESHU

06.11.2023

PROJEKTI INZHINIEROR / ELECTRICAL DESIGN

Ing. Kristaq ZHURRA

06.11.2023

SHËRBIM: TËRBUKË / TECHNICAL SERVICE

06.11.2023

SHËRBIM

06.11.2023

06.11.2023

SHËRBIM: TËRBUKË / TECHNICAL SERVICE

A-01

SHËRBIM

PLANVENDOSJA E MODULEVE

Sistemi fotovoltaik i
godinës Nr.2

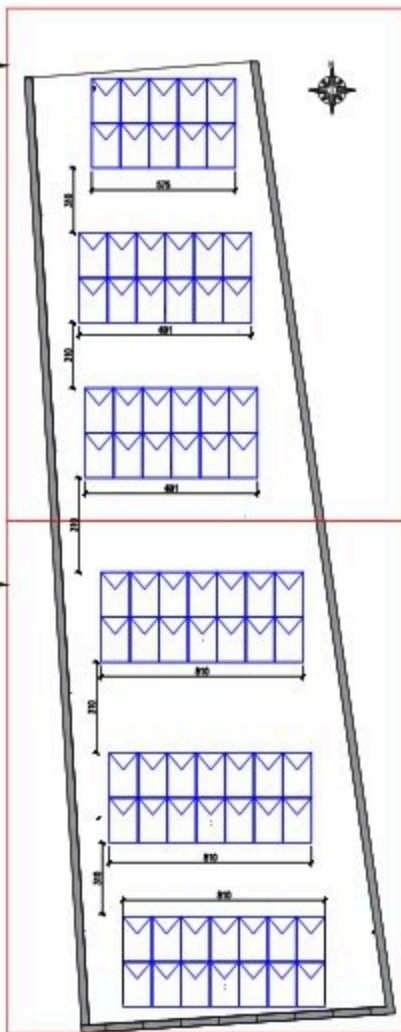

Sistemi fotovoltaik i
Info Kullës

Sistemi fotovoltaik i
godinës Nr.2

Sistemi fotovoltaik i
Info Kullës



BAJZHAKIA BRICETE, PËRMETI

KONSTRUKTIV / CONSULTANT



DOKUMENTI / TECHNICAL NOTES

Sipërfaqja e Sheshit 2023 m²
Sipërfaqja e gjatësisë së shkollës 620.5 m²
Sipërfaqja e lloj gjëra parandron 1207 m²
Sipërfaqja e lloj gjëra përpara shkollës 940 m²

PROJECT / PROJECT NAME

"INSTALIMI I SISTEMIT
FOTOVOLTAIK"

PROJECT LOCATION

BAJZHAKIA BRICETE

PHASE / PROJECT / PROJECT PHASE

PROJEKT ZBATIM
IMPLEMENTATION OF DESIGN

PROJECT ARCHITECTURE / ARCHITECTURAL DESIGN

Ark. Rajmonda MYDRELLARI

06.11.2023

06.11.2023

06.11.2023

06.11.2023

PROJECT STRUCTURE / MECHANICAL DESIGN

Ing. Rashap TAPIDA

06.11.2023

PROJECT STRUCTURE / MECHANICAL DESIGN

Ing. Arqipe PEPI

06.11.2023

PROJECT ELECTRICAL / ELECTRICAL DESIGN

Ing. Kristaq ZHURPA

06.11.2023

PROJECT ARCHITECTURE / ARCHITECTURAL DESIGN

PLANVENDOSJA E MODULEVE

SKEMA

06.11.2023

06.11.2023

06.11.2023

06.11.2023

06.11.2023

06.11.2023

06.11.2023

06.11.2023

06.11.2023

06.11.2023

06.11.2023

06.11.2023

06.11.2023

06.11.2023

06.11.2023

A-02

06.11.2023

06.11.2023

06.11.2023

06.11.2023

06.11.2023

06.11.2023

06.11.2023

06.11.2023

06.11.2023

PLANVENDOSJA E MODULEVE

Sistemi fotovoltaik i
godinës Nr.2

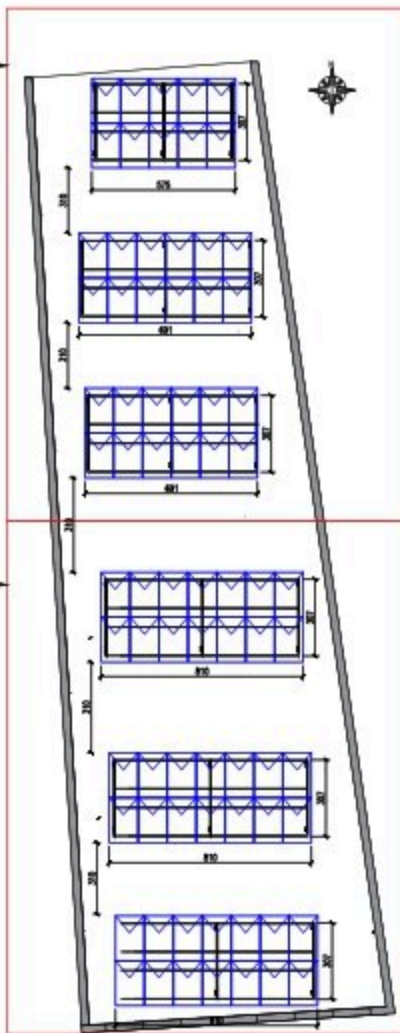

Sistemi fotovoltaik i
Info Kullës

Sistemi fotovoltaik i
godinës Nr.2

Sistemi fotovoltaik i
Info Kullës



BASHKIA E MIRDITËS

KONSOLEJTI / CONSULTANT



SHËNIMET / TECHNICAL NOTES

Sipërfaqja e Sheshit 2023 m²
Sipërfaqja e gjatësisë së shkollës 620.5 m²
Sipërfaqja e lloj gjëra parandron 1207 m²
Sipërfaqja e lloj gjëra para shkollës 940 m²

PROJECT / PROJECT NAME

"INSTALIMI I SISTEMIT
FOTOVOLTAIK"

FORM / LOCATION

BASHKIA E MIRDITËS

PHASE / PROJECT / PROJECT PHASE

PROJEKT ZBATIM
IMPLEMENTATION OF DESIGN

PROJECT ARCHITECTURE / ARCHITECTURAL DESIGN

Ark. Rajmonda MYDRELLARI

06.11.2023

06.11.2023

PROJECT STRUCTURE / STRUCTURAL DESIGN

Ing. Rashap TAPIDA

06.11.2023

PROJECT MECHANICAL / MECHANICAL DESIGN

Ing. Arqipe PEPI

06.11.2023

PROJECT ELECTRICAL / ELECTRICAL DESIGN

Ing. Merita MEGYI

06.11.2023

PROJECT ELECTRICAL / ELECTRICAL DESIGN

Ing. Kristaq ZHURPA

06.11.2023

PHYSICAL / PHYSICAL / FIELD OF DESIGN

PLANIMETRIJA E MODULEVE

SHKALLA

1:1000

SHKURT 2023

REVIZIONI / REVISIONS

A-03

VLKA / STAMP

PLANVENDOSJA E MODULEVE

Sistemi fotovoltaik i
godinës Nr.2

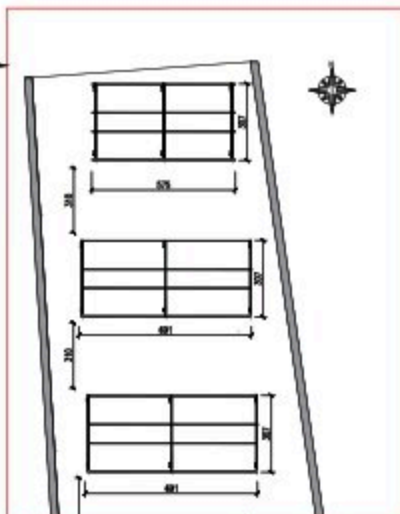

Sistemi fotovoltaik i
Info Kullës

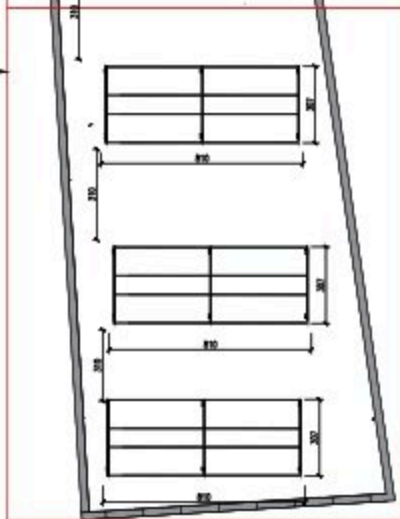

Sistemi fotovoltaik i
godinës Nr.2

Sistemi fotovoltaik i
Info Kullës



REPUBLIKA E SHQIPËRIE

KONSTRUKTIV / CONSULTANT



SHËRBIMET E SHËRBIMIT / TECHNICAL SERVICE

Sipërfaqja e Shërbimit 2023 m²
Sipërfaqja e gjatësisë së shërbimit 620.5 m²
Sipërfaqja e lartësisë së shërbimit 1207 m²
Sipërfaqja e lartësisë së shërbimit 940 m²

PROJEKTI / PROJECT NAME

"INSTALIMI I SISTEMIT
FOTOVOLTAIK"

JEKË / LOCATION

ZASHKËIA MRODITE

FASË E PROJEKTTIT / PROJECT PHASE

PROJEKT ZBATIM
IMPLEMENTATION OF DESIGN

PROJEKTI ARCHITETUROR / ARCHITECTURAL DESIGN

Ark. Rajmonda MYDRELLARI

06.11.2023

06.11.2023

PROJEKTI KONSTRUKTIV / STRUCTURAL DESIGN

Ing. Rishap TAPIDA

06.11.2023

PROJEKTI MARRËMËRIE / ME PROJEKTIM DHE SHËRBIM

Ing. Arqipe PEPI

06.11.2023

PROJEKTI INZHINIERI / PRINCIPAL DESIGN

Ing. Merita MEGRI

06.11.2023

PROJEKTI ELIMANTOR / ELECTRICAL DESIGN

Ing. Kristaq ZHURPA

06.11.2023

EMËRTIMI / ALTES / TITLE OF DESIGN

PLANVENDOSJA E MODULEVE

SHKALLA

1:1000

SHKURT 2023

SHËRBIMET / CONSULTANT

A-04

VLAJE / STAMP

PLANVENDOSJA E MODULEVE

Sistemi fotovoltaik i
godinës Nr.2

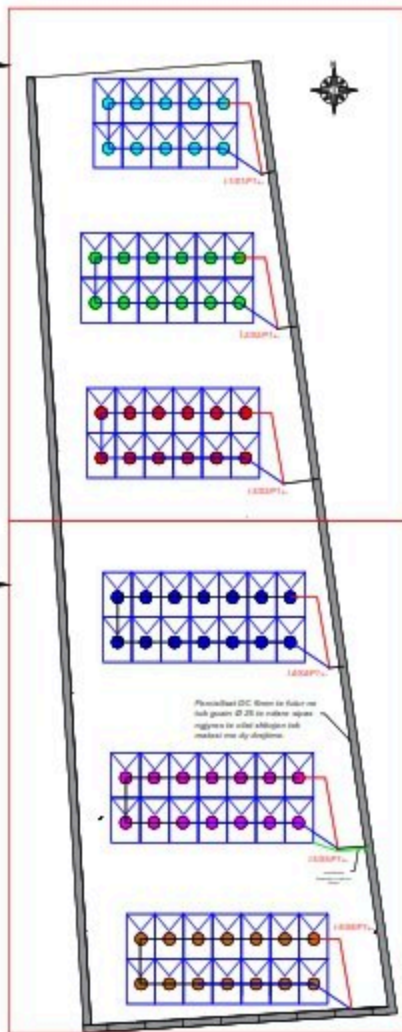

Sistemi fotovoltaik i
Info Kullës

Sistemi fotovoltaik i
godinës Nr.2

Sistemi fotovoltaik i
Info Kullës

Sistemi 1.2.3 përbëhet nga 10.12.12 module fotovoltaike secili me fuqi nominale 450 W secili, me fuqi totale të instaluar 15.64 kWp. Këtu shtrihet do të bashkohësit invertor nr. 2, me fuqi 15 kVA, i cili i përkulë godinës nr. 2.

Sistemi 4.5.6, secili i përbëhet nga 14 module me fuqi 450 W, me fuqi totale prej 13.32 kWp, do të bashkohësit invertor nr. 1, me fuqi 20kVA, i cili i përkulë godinës së Info Kullës.



BASHKIA E RRETHIT TË PËRBËRËS

KONKALISTI / CONSULTANT



SHËRBIM TËRBUKUR / TECHNICAL SERVICE

Sipërfaqja e Shprehjes 2023 m²
Sipërfaqja e gjatësisë së shprehjes 620.5 m²
Sipërfaqja e lartësisë së shprehjes 1207 m²
Sipërfaqja e lartësisë së shprehjes 940 m²

PROJECT / PROJECT NAME

"INSTALIMI I SISTEMIT FOTOVOLTAIK"

FORM / LOCATION

BASHKIA E RRETHIT TË PËRBËRËS

PHASE / PROJECT / PROJECT NAME

PROJEKT ZBATIM / IMPLEMENTATION OF DESIGN

PROJECT ARCHITECTURE / ARCHITECTURAL DESIGN

Ark. Rajmonda MYDRELLARI
06-11-0-01-1012
06-11-0-01-1012

PROJECT STRUCTURE / STRUCTURAL DESIGN

Ing. Rishap TAPIDA
06-11-0-01-1012

PROJECT MECHANICAL / MECHANICAL DESIGN

Ing. Arjan PEPI
06-11-0-01-1012

PROJECT ELECTRICAL / ELECTRICAL DESIGN

Ing. Merita MEGRI
06-11-0-01-1012

PROJECT ELECTRICAL / ELECTRICAL DESIGN

Ing. Kristaq ZHURPA
06-11-0-01-1012

PHASE / PHASE / TYPE OF DESIGN

PLANVENDOSJA E MODULEVE

SHALLA

06-11-0-01-1012

SHKURT 2020

APPROVED / APPROVED BY

06-11-0-01-1012

06-11-0-01-1012

SCALE / STAMP

A-06

SKEMA ELEKTRIKE AC



BASHKIA MIRDIË, PESHKËPISË

CONSULTANT



CONSULTING - TECHNICAL SERVICES

PROJECT / PROJECT NAME

"INSTALIMI I SISTEMIT FOTOVOLTAIK"

JOB / LOCATION

BASHKIA MIRDIË

PHASE / PROJECT / PROJECT PHASE

PROJEKT ZBATIM / IMPLEMENTATION OF DESIGN

PROJECT ARCHITECTURE - ARCHITECTURAL DESIGN

Ark. Rajmonda MYDRELLARI

06.11.2022

06.11.2022

PROJECT ARCHITECTURE / STRUCTURAL DESIGN

Ing. Rashap XARDA

06.11.2022

PROJECT MECHANICAL / MECHANICAL DESIGN

Ing. Ardit PEPI

06.11.2022

PROJECT MECHANICAL / MECHANICAL DESIGN

Ing. Merita MEGRI

06.11.2022

PROJECT ELECTRICAL / ELECTRICAL DESIGN

Ing. Kristaq ZHURPA

06.11.2022

PROJECT ELECTRICAL / ELECTRICAL DESIGN

06.11.2022

SKEMA

06.11.2022

06.11.2022

06.11.2022

A-07

06.11.2022

Skema Elektrike AC-DC Info Kulla

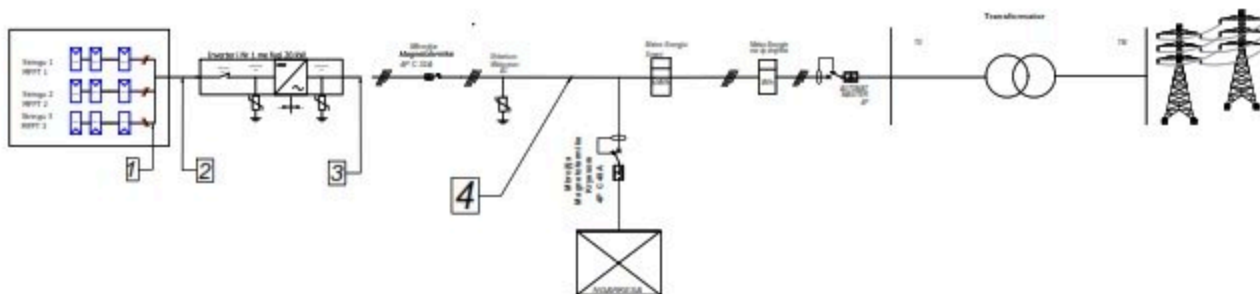

SKEMA E SISTEMIT TE MATJES

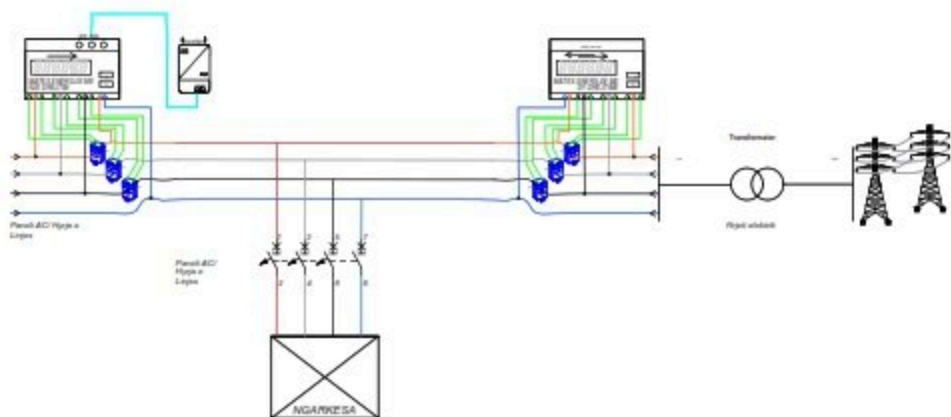

LEGJENDE	
	Inverter
	Breaker Ripe
	Drejtim Mbrojtës
	Paneli AC Fijte e Lajme
	Transformator
	Rregulluesi
	Torre
	Kabllo

PROJEKTI: 12487



BASHKIA E MIRDITËS

KONSULENTI / CONSULTANT



DOKUMENTI: TENDERE / TECHNICAL NOTES

PROJEKTI / PROJECT NAME

"INSTALIMI I SISTEMIT FOTOVOLTAIK"

ZONA / LOCATION

BASHKIA E MIRDITËS

PAGJE E PROJEKTI / PROJECT PAGE

PROJEKTI ZBATIM / IMPLEMENTATION DESIGN

PROJEKTI ARCHITETONIK / ARCHITECTURAL DESIGN

Ark. Rajmonda MYDRELLARI

06.04.2012

0204 4000000

PROJEKTI KONSOLIDIM / STRUCTURAL DESIGN

Ing. Rashap TAPDA

06.04.2012

PROJEKTI HAPËRSHËRIS / HEAT PRO AND COOLING

Ing. Arqipe PEPI

06.04.2012

PROJEKTI HAPËRSHËRIS / MUNICIPAL DESIGN

Ing. Merita MEGRI

06.04.2012

PROJEKTI ELIMETRIK / ELECTRICAL DESIGN

Ing. Kristaq ZHURPA

06.04.2012

PROJEKTI HAPËRSHËRIS / FILL OF DESIGN

PROJEKTI HAPËRSHËRIS / FILL OF DESIGN

SHKALLA

1:1

SHKURT 2002

PROJEKTI / CONSULTANT

A-08

VLAK / STAMP

PROJEKTI FOTOVOLTAIK

OBJEKTI: "Konvikti Rrëshen""

PROGRAMI: "Projektimi i Sistemit Fotovoltaik 20.24 kWp"

MBESHTETES: IPA II Cross Border Cooperation Programme for Albania- Kosovo

PERFITUES: Bashkia Mirditë



ZENIT&CO

Tiranë 2026



BASHKIA MIRDITE

PLANIMETRI E PËRGJITHËSHME E OBJEKTIT

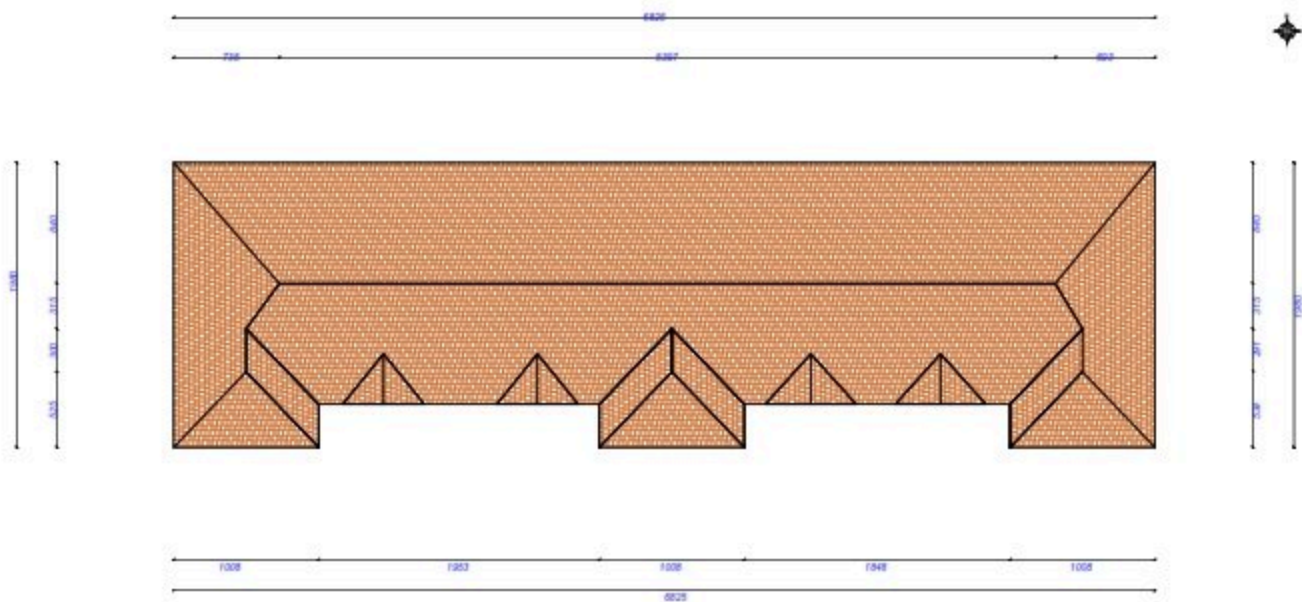

PROJEKTI - 13/2021



BASHKIA E RRETHIT TË PRIZRINIT

KONSULLANT / CONSULTANT



ZENITSCO
ZEMËRIMET TË INZHINIERISË

Prizren, Tjet. Nr. 19, Prizren, 1700
E-Mail: zenit@zenit.com

SHKËMBIM TËRISHTËR / TECHNICAL NOTES

PROJEKTI / PROJECT NAME

**"INSTALIMI I SISTEMIT
FOTOVOLTAIK"**

ZONA / LOCATION

BASHKIA E RRETHIT TË PRIZRINIT

FASË E PROJEKTI / PROJECT PHASE

**PROJEKT ZBATIM
IMPLEMENTATION OF SIGN**

PROJEKTI ARCHITETONIK / ARCHITECTURAL DESIGN

Ark. Rigonda MYDRELLARI

Nr. 14-02/102
Bashkia e Rrethit të Prizrenit

PROJEKTI INZHINIERI / STRUCTURAL DESIGN

Ing. Rashap TAPDA

Nr. 14-02/102

PROJEKTI INZHINIERI / MEK. AND COOLING

Ing. Arqife PEPI

Nr. 14-02/102

PROJEKTI INZHINIERI / MUNICIPAL DESIGN

Ing. Merita MESHU

Nr. 14-02/102

PROJEKTI INZHINIERI / ELECTRICAL DESIGN

Ing. Kristaq ZHURPA

Nr. 14-02/102

SHKËMBIM TËRISHTËR / FIELD OF DESIGN

PLANIMETRI I OBJEKTIT

SHKALLA

1:100

SHKËMBIM TËRISHTËR

SHKËMBIM TËRISHTËR

A-01

VLKA / STAMP

PLANIMETRI E PËRGJITHËSHME E OBJEKTIT

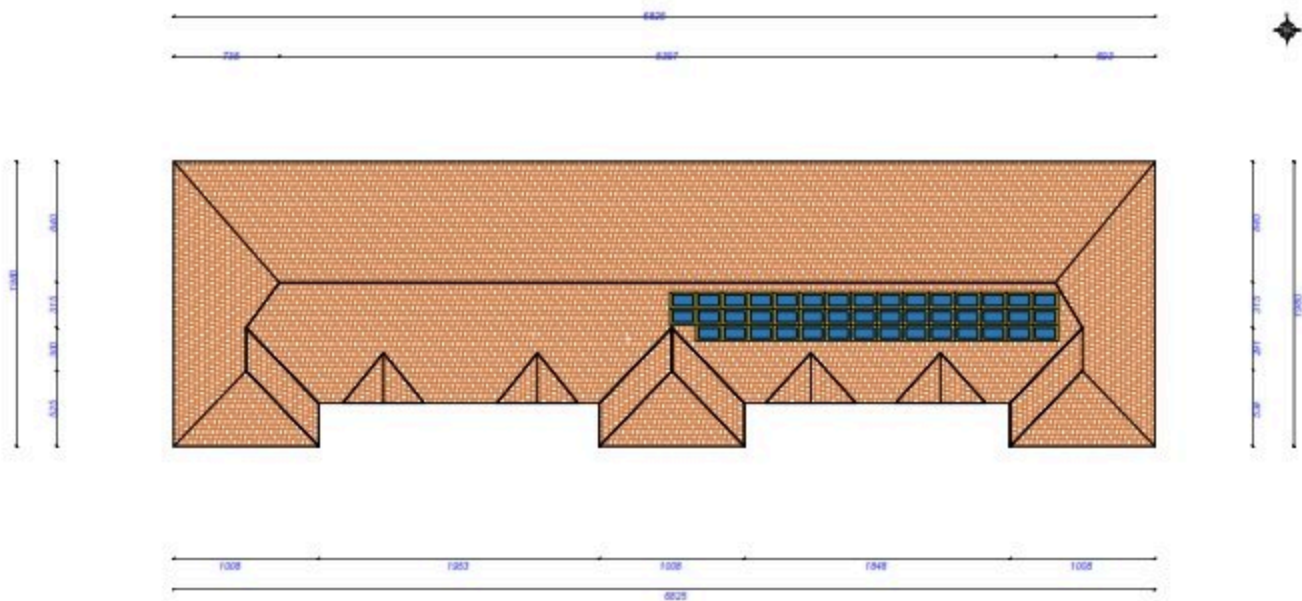

PROJEKTOI - 12891



BASHKIA E PRISHTINES

KONSULENTI - KONSULANT



SHKËMBI TËROR - TECHNICAL NOTES

PROJEKTI - PROJECT NAME

"INSTALIMI I SISTEMIT FOTOVOLTAIK"

ZONA - LOCATION

BASHKIA E PRISHTINES

FASË E PROJEKTI - PROJECT PHASE

PROJEKT ZBATIM / IMPLEMENTATION DESIGN

PROJEKTI ARCHITETUROR - ARCHITECTURAL DESIGN

Ark. Rigonda MYDRELLARI

06.11.2022

06.11.2022

PROJEKTI INZHINIEROR - STRUCTURAL DESIGN

Ing. Rishap TAPDA

06.11.2022

PROJEKTI TËROR - ME PROJEKTIM

Ing. Arqif PEPI

06.11.2022

PROJEKTI INZHINIEROR - MEKANIKA

Ing. Merita MESHU

06.11.2022

PROJEKTI INZHINIEROR - ELEKTRIKAL

Ing. Kristaq ZHURPA

06.11.2022

SHKËMBI TËROR - TËROR

06.11.2022

SHKËLLA

06.11.2022

SHKËMBI TËROR

SHKËMBI TËROR

A-02

VLKA / STAMP

DIMENSIONET E SIPERFAQES KU DO TE VENDOSEN PANELET FOTOVOLTAIKE

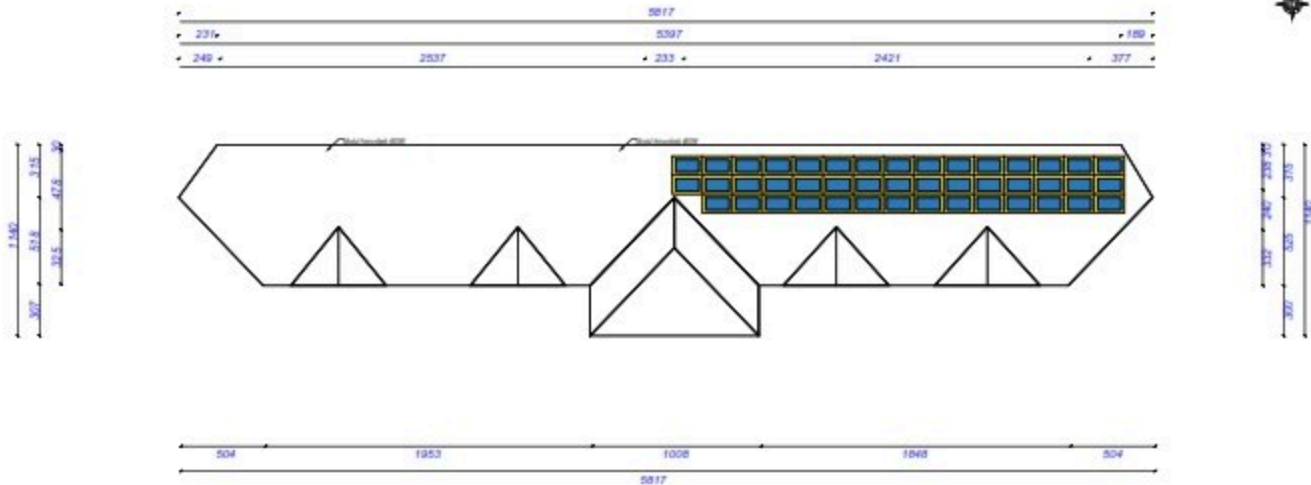

PROJEKTO: 13.03.07



BASHKIA MBRODITE, PRRYPITURE

KONSULLENT: KONSULLANT



ZENITSCO
 ZENIT CONSULTING
 16 Mjeshit, Tjet 06/10, Gjirafa, 1001
 T. 061 4401000
 E. 061 4401000

DOKUMENTI: TENDERO / TECHNICAL NOTES

PROJECT: PROJECT NAME

"INSTALIMI I SISTEMIT FOTOVOLTAIK"

ZONE: LOCATION

BASHKIA MBRODITE

PHASE: PROJECT / PROJECT PHASE

PROJEKT ZBATIM /
 IMPLEMENTATION DESIGN

PROJECT ARCHITECTURE: ARCHITECTURAL DESIGN

Ark. Rajmonda MYDRELLARI
 06/14-02/102
 06/14-02/102

PROJECT ARCHITECTURE: STRUCTURAL DESIGN

Ing. Rashap TAPDA
 06/14-02/102

PROJECT ARCHITECTURE: MECHANICAL DESIGN

Ing. Arqipe FERI
 06/14-02/102

PROJECT ARCHITECTURE: ELECTRICAL DESIGN

Ing. Merita MEGRI
 06/14-02/102

PROJECT ARCHITECTURE: ELECTRICAL DESIGN

Ing. Kristaq ZHURPA
 06/14-02/102

PROJECT ARCHITECTURE: FIELD OF DESIGN

DIMENSIONET E SIPERFAQES KU DO TE VENDOSEN PANELET FOTOVOLTAIKE

SHALLA

SHALLA

SHALLA

SHALLA

SHALLA

SHALLA

SHALLA

SHALLA

A-03

VLAK / STAMP

DIMENSIONET E SIPERFAQES KU DO TE VENDOSEN PANELET FOTOVOLTAIKE

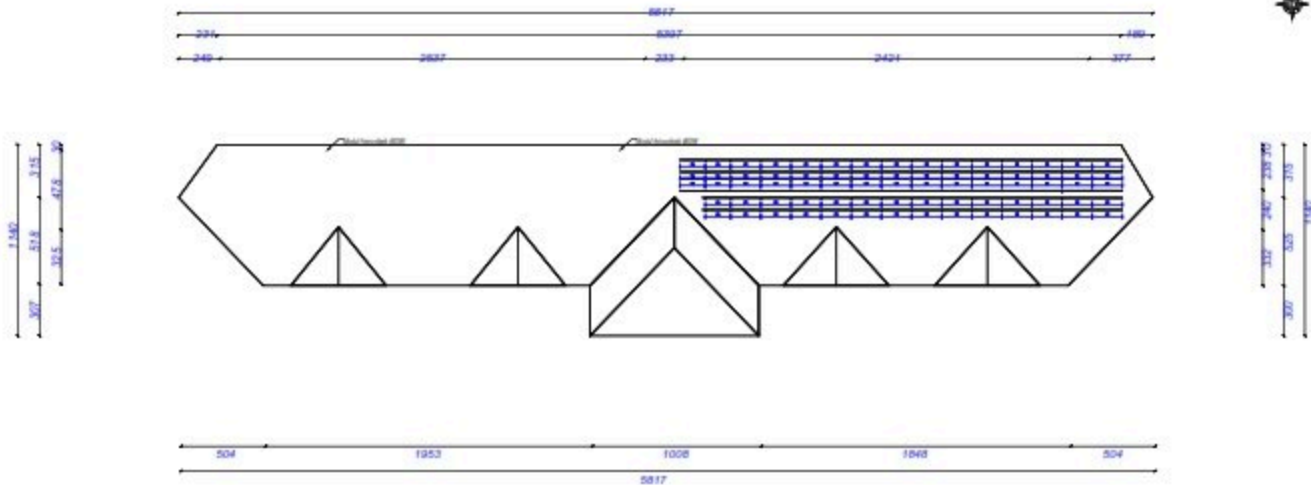

PROJEKTI: 12.03.07



REPUBLIKA E SHQIPËRIE

KONSOLENT / CONSULTANT



ZENITSCO
 ZENIT CONSULTING
 16 Shkurtorë, Turrpik, 10000
 TIRANE, SHQIPËRI
 E-Mail: zenit@zenit.com

SHKËMBIM: TËRBUJËR / TECHNICAL NOTES

PROJEKTI / PROJECT NAME

"INSTALIMI I SISTEMIT
 FOTOVOLTAIK"

FORMA / LOCATION

ZASHKIA MRDITE

FASË E PROJEKTI / PROJECT PHASE

PROJEKT ZBATIM /
 IMPLEMENTATION DESIGN

PROJEKTI ARCHITETUROR / ARCHITECTURAL DESIGN

Ark. Rajmonda MYDRELLARI
 Nr. 14-02/102
 16 SHKURTORË 2022

PROJEKTI INZHINIEROR / STRUCTURAL DESIGN

Ing. Rashap TAPDA
 Nr. 14-02/102

PROJEKTI SHPËRTHYER / ME PROJEKTIM DËSHOR

Ing. Arqipe PEPI
 Nr. 14-02/102

PROJEKTI INZHINIEROR / PRINCIPAL DESIGN

Ing. Merita MEGRI
 Nr. 14-02/102

PROJEKTI INZHINIEROR / ELECTRICAL DESIGN

Ing. Kristaq ZHURPA
 Nr. 14-02/102

SHËMBIM: ANALIZË / FIELD OF DESIGN

DIMENSIONET E SIPERFAQES KU DO TE VENDOSEN
 PANJELT

SHKALLA

SHKURT 2022

SHËMBIM: SHËMBIM /

A-05

VLKA / STAMP

SKEMA E SISTEMIT TE MATJES

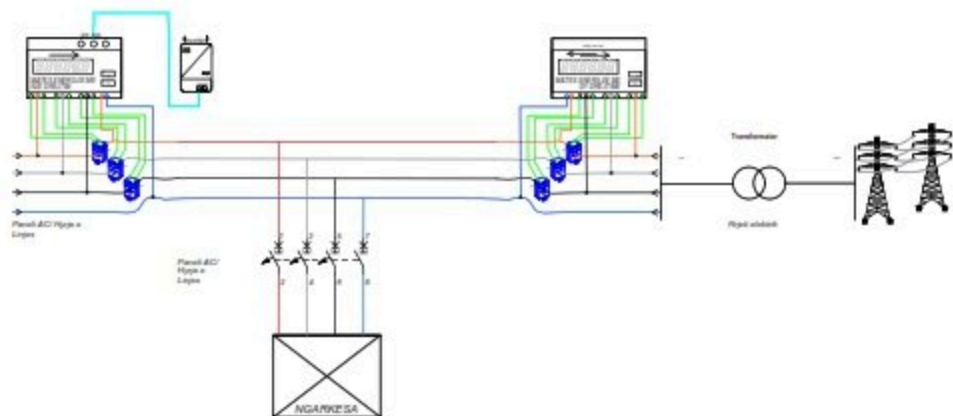

LEGJENDE	
	Inverter
	Transformator Tipi
	Shkëmbim Mbrojtës
	Access Equipment
	Main-Design Inverter
	Transformator TWT
	Rrept Ombi
	Ngarkesa Ombi

PROJEKTOI: LINDRI



BASHKIA MBRODITE

KONSULENTI: KONSULANT



ZENITBCC CONSULTING
 26 Shkurtorë, Tjetër (Rr. 19 Aprilin, 2002)
 030 4401000
 z.bcc@zenitbcc.com

SHKËMBIM: TËRBUJËR / TECHNICAL NOTES

PROJEKTI: PROJECT NAME

"INSTALIMI I SISTEMIT FOTOVOLTAIK"

ZONA / LOCATION

BASHKIA MBRODITE

PAGJE E PROJEKTIUT / PROJECT PAGE

PROJEKTI ZBATIM / IMPLEMENTATION DESIGN

PROJEKTI ARCHITETONIK / ARCHITECTURAL DESIGN

Ark. Rajmonda MYDRELLARI

Rr. 19.04.2002

Shk. Bashkia Mbrodite

PROJEKTI KONSTRUKTIV / STRUCTURAL DESIGN

Ing. Rashap TAPDA

Shk. Bashkia Mbrodite

PROJEKTI MËRMBURJE / MEH PRO AND COOLING

Ing. Arqipe PEPI

Shk. Bashkia Mbrodite

PROJEKTI MËRMBURJE / MUNICIPAL DESIGN

Ing. Merita MEGYI

Shk. Bashkia Mbrodite

PROJEKTI ELIMANTER / ELECTRICAL DESIGN

Ing. Kristaq ZHURPA

Shk. Bashkia Mbrodite

PROJEKTI MËRMBURJE / FIELD OF DESIGN

PROJEKTI ZBATIM / IMPLEMENTATION DESIGN

SHKËMBIM: TËRBUJËR / TECHNICAL NOTES

SHKËMBIM: TËRBUJËR / TECHNICAL NOTES

SHKËMBIM: TËRBUJËR / TECHNICAL NOTES

SHKËMBIM: TËRBUJËR / TECHNICAL NOTES

SHKËMBIM: TËRBUJËR / TECHNICAL NOTES

SHKËMBIM: TËRBUJËR / TECHNICAL NOTES

SHKËMBIM: TËRBUJËR / TECHNICAL NOTES

SHKËMBIM: TËRBUJËR / TECHNICAL NOTES

SHKËMBIM: TËRBUJËR / TECHNICAL NOTES

SHKËMBIM: TËRBUJËR / TECHNICAL NOTES

SHKËMBIM: TËRBUJËR / TECHNICAL NOTES

SHKËMBIM: TËRBUJËR / TECHNICAL NOTES

SHKËMBIM: TËRBUJËR / TECHNICAL NOTES

SHKËMBIM: TËRBUJËR / TECHNICAL NOTES

SHKËMBIM: TËRBUJËR / TECHNICAL NOTES

SHKËMBIM: TËRBUJËR / TECHNICAL NOTES

SHKËMBIM: TËRBUJËR / TECHNICAL NOTES

SHKËMBIM: TËRBUJËR / TECHNICAL NOTES

SHKËMBIM: TËRBUJËR / TECHNICAL NOTES

SHKËMBIM: TËRBUJËR / TECHNICAL NOTES

SHKËMBIM: TËRBUJËR / TECHNICAL NOTES

SHKËMBIM: TËRBUJËR / TECHNICAL NOTES

SHKËLLA

SHKËLLA

SHKËLLA

SHKËLLA

SHKËLLA

SHKËLLA

SHKËLLA

SHKËLLA

SHKËLLA

SHKËLLA

SHKËLLA

SHKËLLA

SHKËLLA

SHKËLLA

SHKËMBIM: TËRBUJËR / TECHNICAL NOTES

SHKËMBIM: TËRBUJËR / TECHNICAL NOTES

SHKËMBIM: TËRBUJËR / TECHNICAL NOTES

SHKËMBIM: TËRBUJËR / TECHNICAL NOTES

SHKËMBIM: TËRBUJËR / TECHNICAL NOTES

SHKËMBIM: TËRBUJËR / TECHNICAL NOTES

SHKËMBIM: TËRBUJËR / TECHNICAL NOTES

SHKËMBIM: TËRBUJËR / TECHNICAL NOTES

SHKËMBIM: TËRBUJËR / TECHNICAL NOTES

SHKËMBIM: TËRBUJËR / TECHNICAL NOTES

SHKËMBIM: TËRBUJËR / TECHNICAL NOTES

SHKËMBIM: TËRBUJËR / TECHNICAL NOTES

SHKËMBIM: TËRBUJËR / TECHNICAL NOTES

SHKËMBIM: TËRBUJËR / TECHNICAL NOTES

A-09

SHKËMBIM: TËRBUJËR / TECHNICAL NOTES

SHKËMBIM: TËRBUJËR / TECHNICAL NOTES

SHKËMBIM: TËRBUJËR / TECHNICAL NOTES

SHKËMBIM: TËRBUJËR / TECHNICAL NOTES

SHKËMBIM: TËRBUJËR / TECHNICAL NOTES

SHKËMBIM: TËRBUJËR / TECHNICAL NOTES

SHKËMBIM: TËRBUJËR / TECHNICAL NOTES

SHKËMBIM: TËRBUJËR / TECHNICAL NOTES

SHKËMBIM: TËRBUJËR / TECHNICAL NOTES

PLANVENDOSJA E INVERTERIT

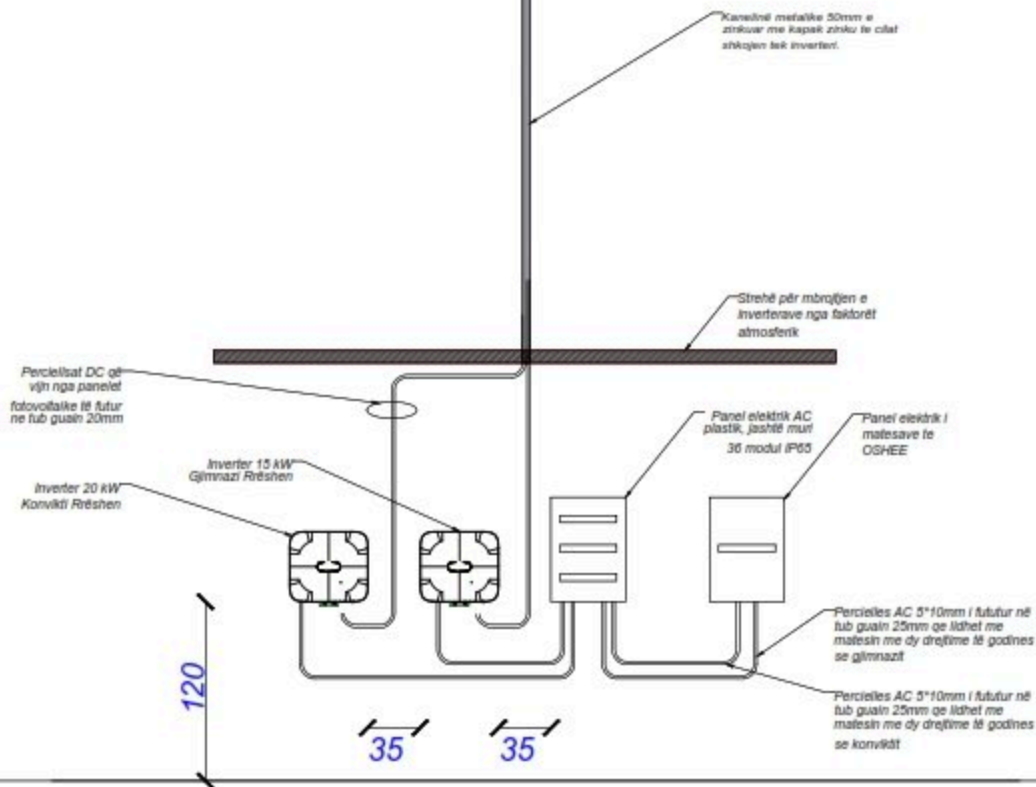

PROJEKTI - 13.007



BASHKIA E RRËSHENIT

KONSTRUKT - CONSULTANT



SHËRBIM: TËRBUJËR / TECHNICAL SERVICE

PROJEKTI - PROJECT NAME

"INSTALIMI I SISTEMIT FOTOVOLTAIK"

QASIM / LOCATION

BASHKIA E RRËSHENIT

FAZJA E PROJEKTI - PROJECT PHASE

PROJEKTI ZBATIM / IMPLEMENTATION OF DESIGN

PROJEKTI ARCHITETUROR / ARCHITECTURAL DESIGN

Ark. Rigonda MYDRELLARI

PROJEKTI KONSTRUKTIV / STRUCTURAL DESIGN

Ing. Rishap TAPDA

PROJEKTI MASHINORË / MEK. PROJ. AND COLLING

Ing. Arqilo PEPI

PROJEKTI HEDRIMOR / ELECTRICAL DESIGN

Ing. Merita MESIPI

PROJEKTI DREJTIMOR / CIVIL DESIGN

Ing. Kristaq ZHURPA

PROJEKTI TËRBUJËR / TOTAL OF DESIGN

PLANIMORË E SHËRBIMIT

SHALLA

SHËRBIM 2020

SHËRBIM / CONSULTANT

A-10

VLAK / STAMP

PROJEKTI FOTOVOLTAIK

OBJEKTI: "Kopshti i Ri Rrëshen 21.16 kWp"

PROGRAMI: "Projektimi i Sistemit Fotovoltaik"

MBESHTETES: IPA II Cross Border Cooperation Programme for Albania- Kosovo

PERFITUES: Bashkia Mirditë



ZENIT&CO

Tiranë 2026



BASHKIA MIRDITE

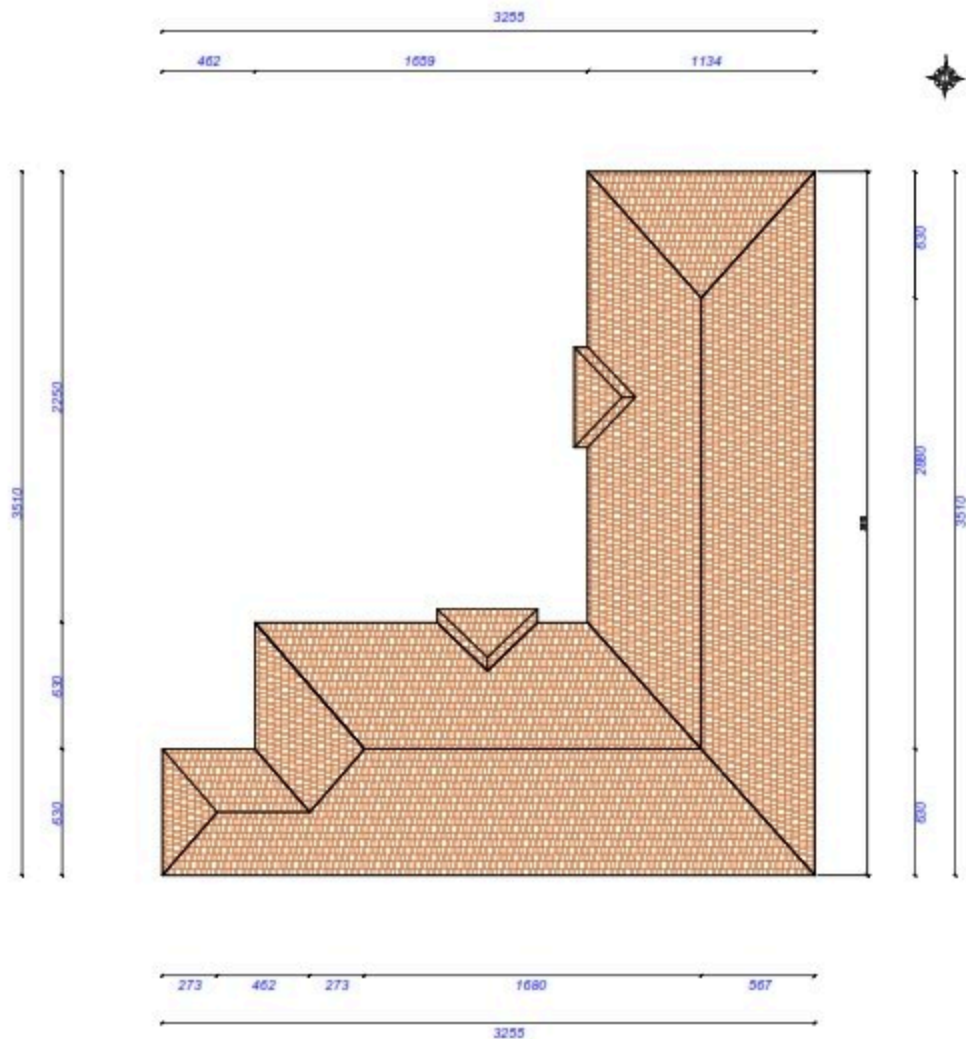

REPUBLIKA SRBIJA, BEOGRAD

KONSULTANT - KONZULTANT



VRSTU: TEHNIČKI - TEHNIČKI LIST

PROJEKT - PROJECT NAME

"INSTALIMI I SISTEMIT
FOTOVOLTAIK"

PROJEKT - LOCATION

BASHKIA MRODITE

PAGE # PROJEKTIT - PROJECT PAGE

PROJEKT ZBATIM
IMPLEMENTATION DESIGN

PROJEKTI ARCHITETURA - ARCHITECTURAL DESIGN

Ark. Rajmonda MYDRELLARI

06.11.2022
06.11.2022

PROJEKTI KONSTRUKCIV - STRUCTURAL DESIGN

Ing. Rashap TAPDA

06.11.2022

PROJEKTI MASHINERIE - MECHANICAL DESIGN

Ing. Anqelo PERI

06.11.2022

PROJEKTI HIDROTEHNIKE - MUNICIPAL DESIGN

Ing. Merita MESHU

06.11.2022

PROJEKTI ELEKTRIKI - ELECTRICAL DESIGN

Ing. Kristaq ZHURPA

06.11.2022

VRSTU: PLANI - TITLE OF DESIGN

PLANIMETRIJA IZ OBLASTI

SKALA

1:1000

PROJEKT 2022

PROJEKTI - CONSULTANT

A-01

VELIK. STAMP



REPUBLIKA E KOSOVES

KONSULLIST / CONSULTANT



SHKURIME / TECHNICAL NOTES

PROJEKT / PROJECT NAME

"INSTALIMI I SISTEMIT FOTOVOLTAIK"

ZONA / LOCATION

ZASHKIA MRODITE

FASHA E PROJEKTT / PROJECT PHASE

PROJEKT ZBATIM / IMPLEMENTATION OF SIGN

PROJEKTI ARCHITETURE / ARCHITECTURAL DESIGN

Ark. Rajmonda MYDRELLARI

06-11-4-02-102

06-11-4-02-102

PROJEKTI INZHINIERI / STRUCTURAL DESIGN

Ing. Rashap XAPDA

06-11-4-02-102

PROJEKTI SHPALLJE / MEK PROJEKTI / MEK PROJEKTI

Ing. Arqipe FERIS

06-11-4-02-102

PROJEKTI INZHINIERI / MEK PROJEKTI / MEK PROJEKTI

Ing. Merita MESHU

06-11-4-02-102

PROJEKTI INZHINIERI / ELECTRICAL DESIGN

Ing. Kristaq ZHURPA

06-11-4-02-102

SHKURIME / TECHNICAL NOTES

SHKURIME / TECHNICAL NOTES

SHKURIME / TECHNICAL NOTES

SHKURIME / TECHNICAL NOTES

SHKURIME / TECHNICAL NOTES

SHKURIME / TECHNICAL NOTES

SHKURIME / TECHNICAL NOTES

SHKURIME / TECHNICAL NOTES

SHKURIME / TECHNICAL NOTES

SHKURIME / TECHNICAL NOTES

SHKURIME / TECHNICAL NOTES

SHKURIME / TECHNICAL NOTES

SHKURIME / TECHNICAL NOTES

SHKURIME / TECHNICAL NOTES

SHKURIME / TECHNICAL NOTES

SHKURIME / TECHNICAL NOTES

SHKURIME / TECHNICAL NOTES

SHKURIME / TECHNICAL NOTES

SHKURIME / TECHNICAL NOTES

SHKURIME / TECHNICAL NOTES

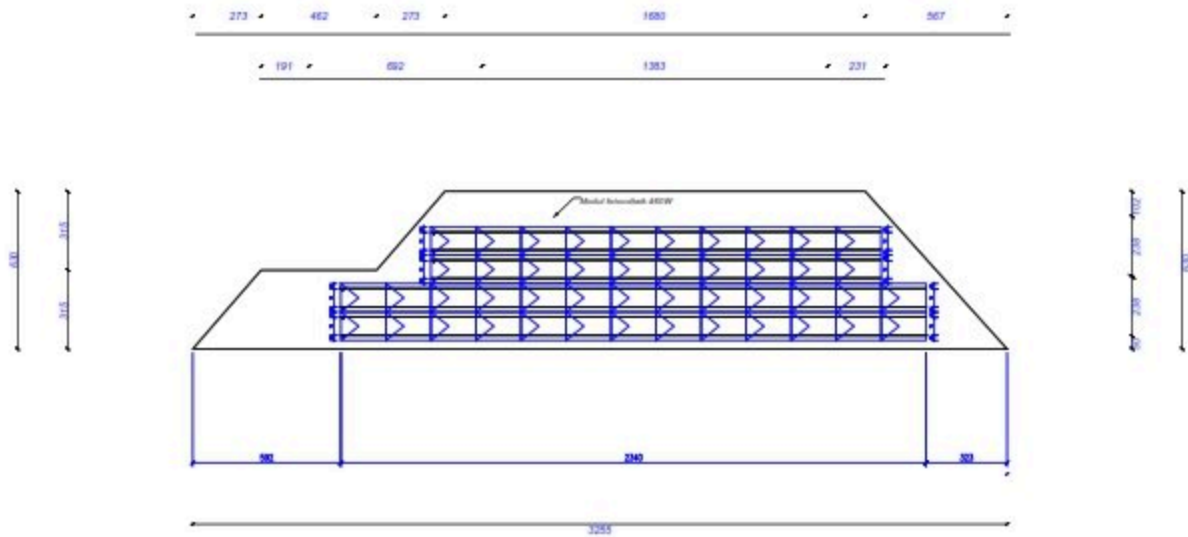

SHKALLA / SCALE

1:100

SHKURIME / TECHNICAL NOTES

SHKURIME / TECHNICAL NOTES

SHKURIME / TECHNICAL NOTES

SHKURIME / TECHNICAL NOTES

SHKURIME / TECHNICAL NOTES

SHKURIME / TECHNICAL NOTES

SHKURIME / TECHNICAL NOTES

SHKURIME / TECHNICAL NOTES

SHKURIME / TECHNICAL NOTES

SHKURIME / TECHNICAL NOTES

SHKURIME / TECHNICAL NOTES

SHKURIME / TECHNICAL NOTES

SHKURIME / TECHNICAL NOTES

SHKURIME / TECHNICAL NOTES

SHKURIME / TECHNICAL NOTES

SHKURIME / TECHNICAL NOTES

SHKURIME / TECHNICAL NOTES

SHKURIME / TECHNICAL NOTES

SHKURIME / TECHNICAL NOTES

SHKURIME / TECHNICAL NOTES

SHKURIME / TECHNICAL NOTES

SHKURIME / TECHNICAL NOTES

A-03

SHKURIME / TECHNICAL NOTES

SHKURIME / TECHNICAL NOTES

SHKURIME / TECHNICAL NOTES

SHKURIME / TECHNICAL NOTES

SHKURIME / TECHNICAL NOTES

SHKURIME / TECHNICAL NOTES

SHKURIME / TECHNICAL NOTES

SHKURIME / TECHNICAL NOTES

DIMENSIONET E STRUKTURES MBAJTESE



REPUBLIKA E KOSOVES, PRAPYRITURE

KONSULLANT - CONSULTANT



DOKUMENTI TENDERO - TECHNICAL NOTES

PROJEKTI - PROJECT NAME

"INSTALIMI I SISTEMIT FOTOVOLTAIK"

ZONA - LOCATION

ZASHKIA MRODITE

FASHA E PROJEKTTIT - PROJECT PHASE

PROJEKT ZBATIM /
IMPLEMENTATION DESIGN

PROJEKTI ARCHITETURE - ARCHITECTURAL DESIGN

Ark. Rajmonda MYDRELLARI
Rr. U. K. D. 102
ZASHKIA MRODITE

PROJEKTI INZHINIERI STRUKTURE - STRUCTURAL DESIGN

Ing. Rashap TAPDA
Rr. U. K. D. 102

PROJEKTI INZHINIERI NEJ PROJEKTI COELING

Ing. Arqipe FEMO
Rr. U. K. D. 102

PROJEKTI INZHINIERI PRINCIPAL DESIGN

Ing. Merita MEGRI
Rr. U. K. D. 102

PROJEKTI INZHINIERI ELEKTRIKAL DESIGN

Ing. Kristaq ZHURPA
Rr. U. K. D. 102

SHENJESHA / NOTES / TYPE OF DESIGN

DIMENSIONETA STRUKTURE ANALIZE

SHALLA

SHIFRA / CODE

SHIFRA / CODE

SHIFRA / CODE

A-04

VLLE / STAMP

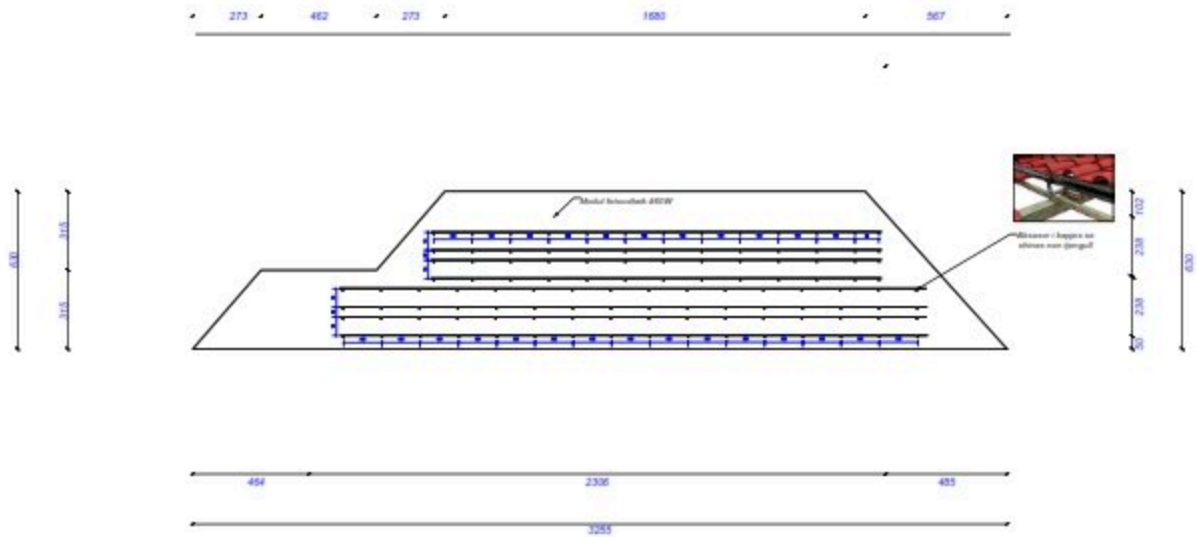

SKEMA E KONFIGURIMIT DC

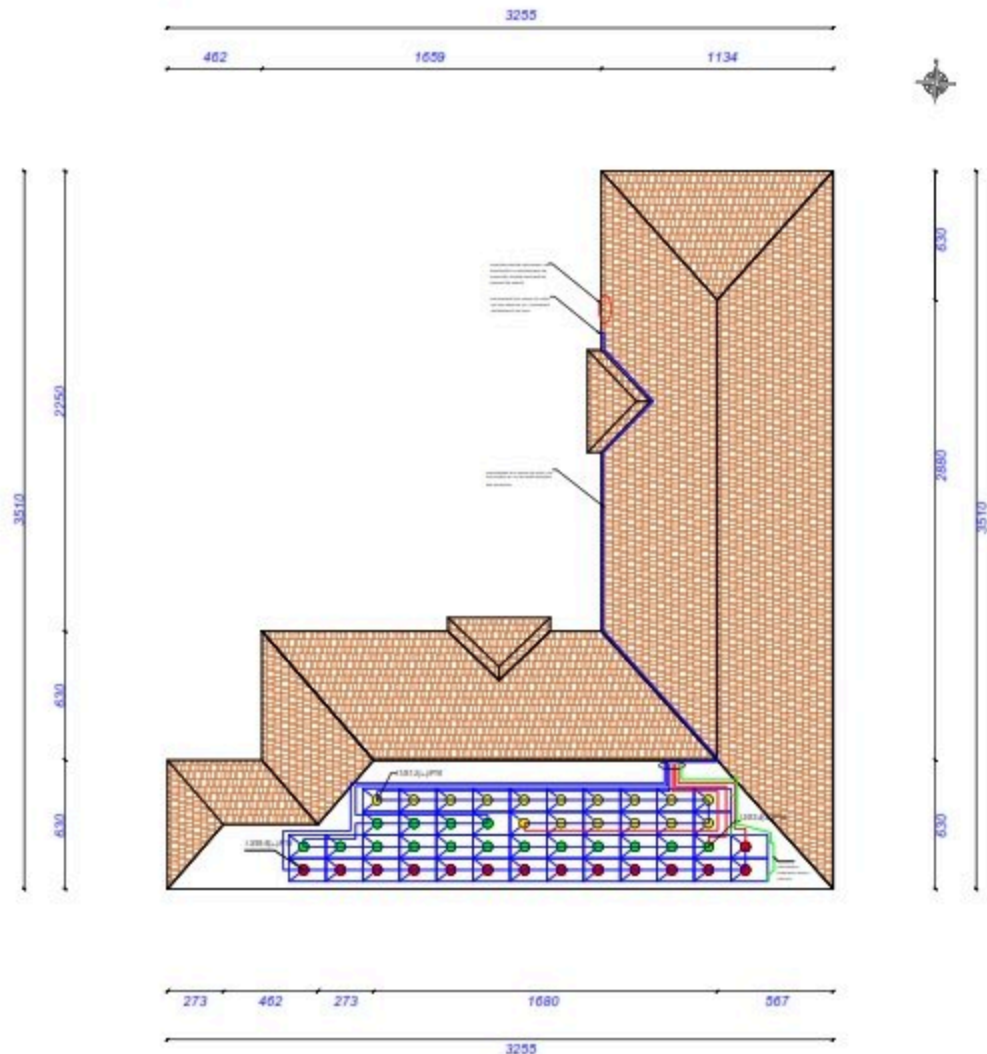

BASHKIA MIRDITE, PERIPIKURE

KONSULLENT / CONSULTANT



SHKURIME TENDERO / TECHNICAL NOTES

PROJECT / PROJECT NAME

"INSTALIMI I SISTEMIT FOTOVOLTAIK"

ZONE / LOCATION

BASHKIA MIRDITE

PAGE # PROJECT / PROJECT PAGE

PROJEKT ZBATIM / IMPLEMENTATION OF SIGN

PROJECT ARCHITECTURE / ARCHITECTURAL DESIGN

Ark. Rajmonda MYDRELLARI

PROJECT ARCHITECTURE / STRUCTURAL DESIGN

Ing. Rashap XARDA

PROJECT ARCHITECTURE / MECHANICAL DESIGN

Ing. Ardit PEPI

PROJECT ARCHITECTURE / ELECTRICAL DESIGN

Ing. Merita MESHU

PROJECT ARCHITECTURE / ELECTRICAL DESIGN

Ing. Kristaq ZHURPA

PROJECT ARCHITECTURE / FIELD OF DESIGN

SKEMA E KONFIGURIMIT DC

SHKALLA

SCHEMATIC

SHKURIT 2024

REVIZIONE / REVISIONS

A-05

VELA / STAMP

SKEMA ELEKTRIKE AC

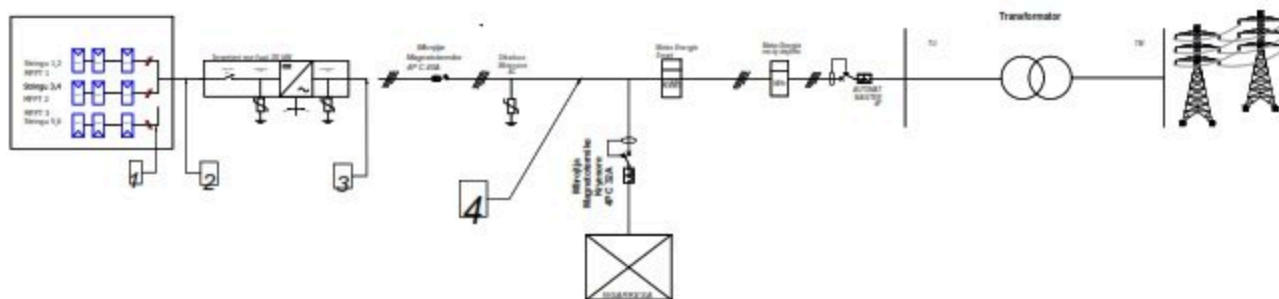

PROJEKT - 13.08.17



BASHKIA MRODITE, REPUBLIC OF MOLDOVA

CONSULTANT



TECHNICAL NOTES

PROJECT - PROJECT NAME

"INSTALIMI I SISTEMIT FOTOVOLTAIK"

JOB - LOCATION

BASHKIA MRODITE

PHASE - PROJECT / PROJECT PHASE

PROIEKT ZBATAWI
IMPLEMENTATION DESIGN

PROJECT ARCHITECTURE - ARCHITECTURAL DESIGN

Arh. Răzvană MYDINELARU

PROJECT ARCHITECTURE - STRUCTURAL DESIGN

Ing. Răzvan TAPDA

PROJECT ARCHITECTURE - MECHANICAL DESIGN

Ing. Andrei PEIȘ

PROJECT ARCHITECTURE - ELECTRICAL DESIGN

Ing. Mircea MEGHIN

PROJECT ARCHITECTURE - CIVIL DESIGN

Ing. Răzvan ZHURBA

PROJECT ARCHITECTURE - OTHER DESIGN

ING. RĂZVAN ZHURBA

PROJECT ARCHITECTURE - OTHER DESIGN

ING. RĂZVAN ZHURBA

PROJECT ARCHITECTURE - OTHER DESIGN

ING. RĂZVAN ZHURBA

PROJECT ARCHITECTURE - OTHER DESIGN

ING. RĂZVAN ZHURBA

PROJECT ARCHITECTURE - OTHER DESIGN

ING. RĂZVAN ZHURBA

PROJECT ARCHITECTURE - OTHER DESIGN

ING. RĂZVAN ZHURBA

PROJECT ARCHITECTURE - OTHER DESIGN

ING. RĂZVAN ZHURBA

PROJECT ARCHITECTURE - OTHER DESIGN

ING. RĂZVAN ZHURBA

PROJECT ARCHITECTURE - OTHER DESIGN

ING. RĂZVAN ZHURBA

PROJECT ARCHITECTURE - OTHER DESIGN

ING. RĂZVAN ZHURBA

PROJECT ARCHITECTURE - OTHER DESIGN

ING. RĂZVAN ZHURBA

PROJECT ARCHITECTURE - OTHER DESIGN

ING. RĂZVAN ZHURBA

SCALE

1:1

DATE

2017

NO.

06

DATE

2017

NO.

06

DATE

2017

SCALE

1:1

DATE

2017

NO.

06

DATE

2017

NO.

06

DATE

2017

SCALE

1:1

DATE

2017

NO.

06

DATE

2017

SCALE

1:1

DATE

2017

NO.

06

DATE

2017

NO.

06

DATE

2017

DIMENSIONET E INVERTERIT

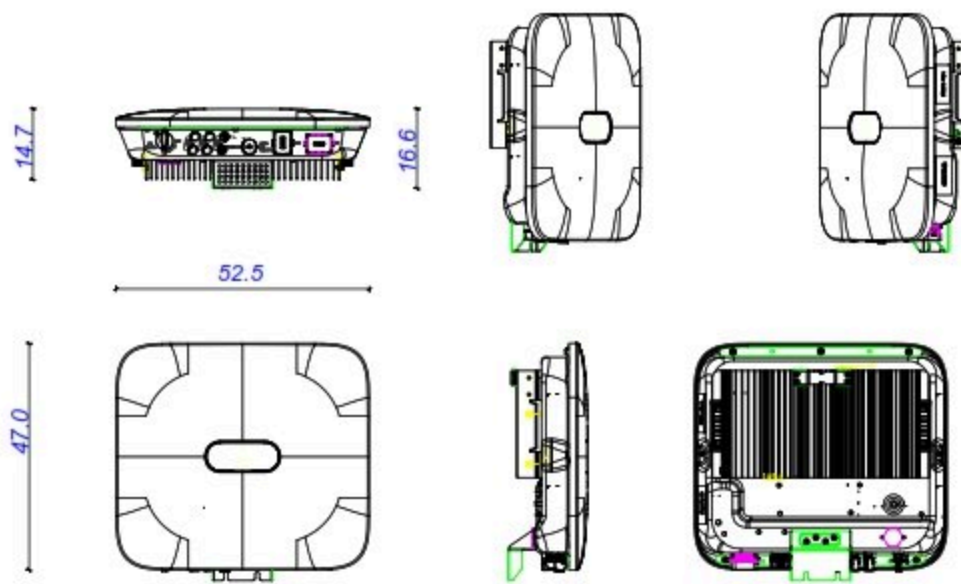

BASHKIA MIRODITE, PESHKUPIE

KONSULLENT / CONSULTANT



ZENITSCO
Peshkopi, Tuzi (Rr. 19 qersori, 1002)
E-Mail: zenit@zenit.com

SHKURIME / THANKS / TECHNICAL NOTES

PROJECT / PROJECT NAME

"INSTALIMI I SISTEMIT FOTOVOLTAIK"

ZONE / LOCATION

BASHKIA MIRODITE

PHASE / PROJECT / PROJECT NAME

PROJEKT ZBATIM / IMPLEMENTATION DESIGN

PROJECT ARCHITECTURE / ARCHITECTURAL DESIGN

Ark. Rajmonda MYDRELLARI
Rr. D. K. 1012
Bashkia Mirodite, Peshkopi

PROJECT ARCHITECTURE / STRUCTURAL DESIGN

Ing. Rishap TAPIDA
Bashkia Mirodite

PROJECT ARCHITECTURE / MECHANICAL DESIGN

Ing. Ardit PEPI
Bashkia Mirodite

PROJECT ARCHITECTURE / ELECTRICAL DESIGN

Ing. Merita MEGRI
Bashkia Mirodite

PROJECT ARCHITECTURE / ELECTRICAL DESIGN

Ing. Kristaq ZHURPA
Bashkia Mirodite

PROJECT ARCHITECTURE / ELECTRICAL DESIGN

SHKURIME / THANKS / TECHNICAL NOTES

SHKURIME / THANKS / TECHNICAL NOTES

SHKURIME / THANKS / TECHNICAL NOTES

SHKURIME / THANKS / TECHNICAL NOTES

A-07

SHKURIME / THANKS / TECHNICAL NOTES

SHKURIME / THANKS / TECHNICAL NOTES

SKEMA E SISTEMIT TE MATJES

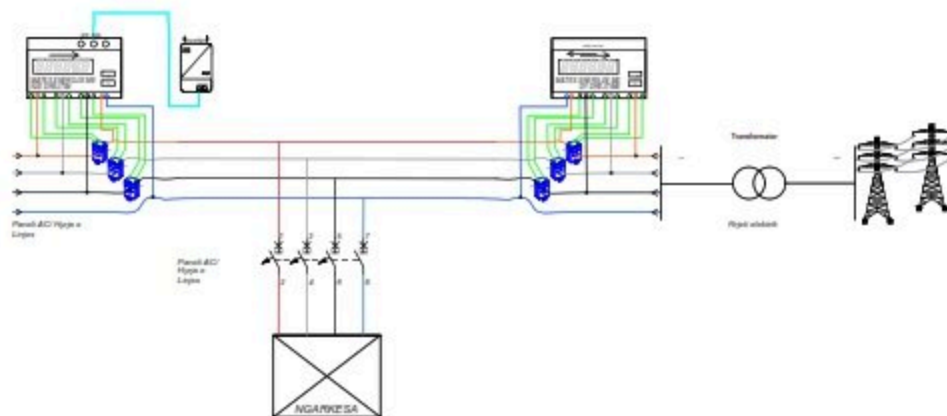

LEGJENDE	
	Inverter
	Transformator Tipi
	Shkëmbim Mbrojtës
	Access Equipment
	Main-Charge Inverter
	Transformator TWT
	Rrethi shpirtor
	Ngarkuesi Objekt

PROJEKTI: 13487



BASHKIA E MBRODITË

KONJULLEKT: CONSULTANT



ZENITBCC CONSULTING
16 Shkurtorë, Tjetër (Rr. 19 April 2002)
E-Mail: zenitb@zcc.com

SHKËMBIM: TËRBUJËR - TECHNICAL NOTES

PROJEKTI: PROJECT NAME

"INSTALIMI I SISTEMIT FOTOVOLTAIK"

ZONA: LOCATION

BASHKIA E MBRODITË

PAGJE E PROJEKTI: PROJECT PAGE

PROJEKTI ZBATIM / IMPLEMENTATION OF SIGN

PROJEKTI ARCHITECTONIK: ARCHITECTURAL DESIGN

Ark. Rajmonda MYDRELLARI

Rr. 19 April 2002

Shk. Bashkia e Mbroditë

PROJEKTI KONSTRUKTIV: STRUCTURAL DESIGN

Ing. Rashap TAPDA

Shk. Bashkia e Mbroditë

PROJEKTI MËRMBURJE: MEA PRO AND COOLING

Ing. Arqipe PEPI

Shk. Bashkia e Mbroditë

PROJEKTI INDORENTIER: MUNICIPAL DESIGN

Ing. Merita MEGYI

Shk. Bashkia e Mbroditë

PROJEKTI ELIMANTIK: ELECTRICAL DESIGN

Ing. Kristaq ZHURPA

Shk. Bashkia e Mbroditë

SHKËMBIM: SHKËMBIM / TABLE OF DESIGN

SHKËMBIM E SHKËMBIMIT: TABLE OF DESIGN

SHKËMBIM

SHKËMBIM 2020

SHKËMBIM 2020

SHKËMBIM: CONSULTANT

A-08

VLAK / STAMP

PLANVENDOSJA E INVERTERIT

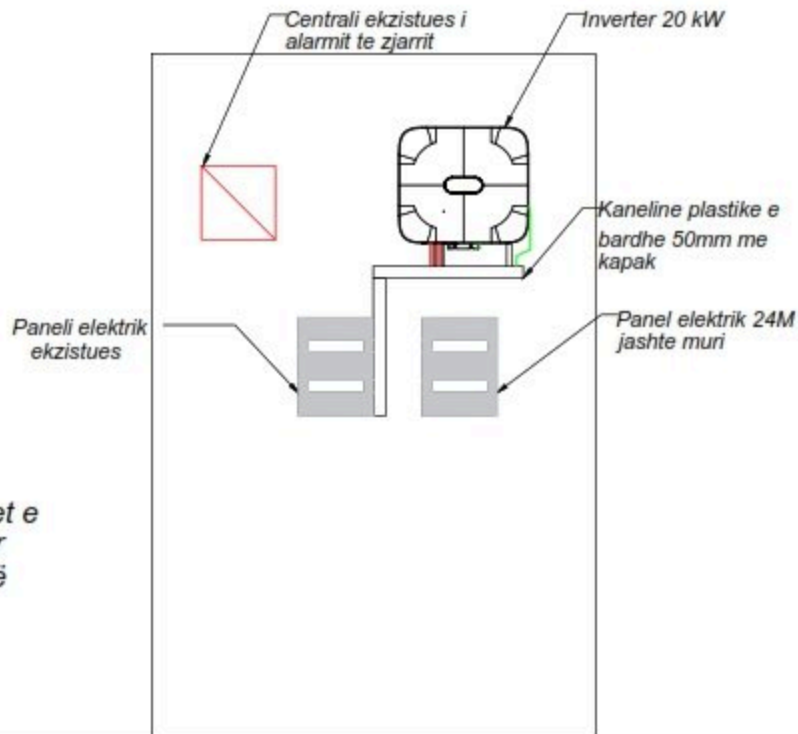

Inverteri do të vendosen në ambientet e brendshme tek muri ku janë instaluar paneli elektrik dhe centrali i alarmit të zjarrit.

PROJEKTI: 13.0487



BASHKIA E PRIZRINIT

KONSOLENT / CONSULTANT



SHKËMBI TËRBUK / TECHNICAL NOTES

PROJECT / PROJECT NAME

"INSTALIMI I SISTEMIT FOTOVOLTAIK"

JOB / LOCATION

BASHKIA E PRIZRINIT

PAGE / PROJECT / PROJECT NAME

PROJEKT ZBATIM / IMPLEMENTATION DESIGN

PROJECT ARCHITECTURE / ARCHITECTURAL DESIGN

Ark. Rigonda MYDRELLARI
04-04-02-102
Bashkia e Prizrenit

PROJECT ARCHITECTURE / STRUCTURAL DESIGN

Ing. Rashap TAPDA
04-04-02-102

PROJECT ARCHITECTURE / MECHANICAL DESIGN

Ing. Ardit PEPI
04-04-02-102

PROJECT ARCHITECTURE / ELECTRICAL DESIGN

Ing. Merita MEGRI
04-04-02-102

PROJECT ARCHITECTURE / ELECTRICAL DESIGN

Ing. Kristaq ZHUPA
04-04-02-102

PROJECT ARCHITECTURE / FIELD OF DESIGN

PLANIMETRI E INVERTERIT

SHKALLA

1:100

SHKURT 2020

REVIZIONI / REVISION

A-09

VLKA / STAMP

PROJEKTI FOTOVOLTAIK

OBJEKTI: "Kopshti i Vjeter Rrëshen"

PROGRAMI: "Projektimi i Sistemit Fotovoltaik"

MBESHTETES: IPA II Cross Border Cooperation Programme for Albania- Kosovo

PERFITUES: Bashkia Mirditë



ZENIT&CO

Tiranë 2026



BASHKIA MIRDITE

PLANIMETRI E PËRGJITHËSHME E OBJEKTIT

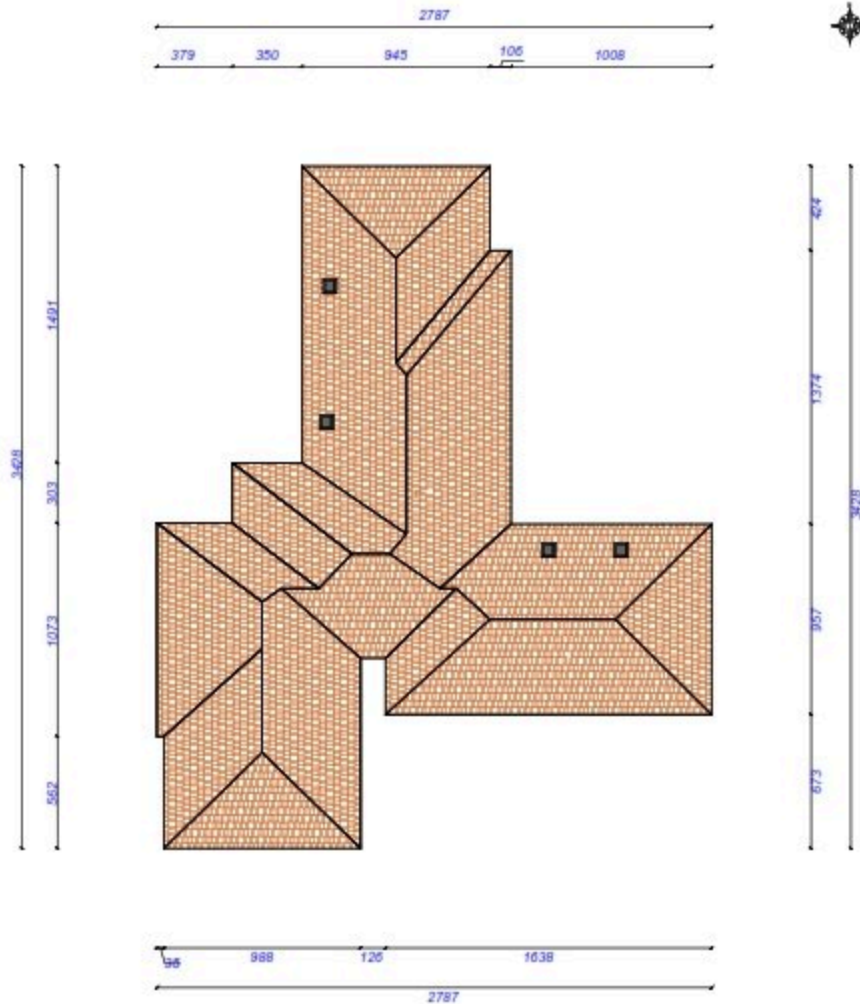

PROJEKTI: 13.04.87



BASHKIA E MIRDITËS

KONSULLENT / CONSULTANT



SHKURIM: TËRBUKUR / TECHNICAL NOTES

PROJEKTI / PROJECT NAME

"INSTALIMI I SISTEMIT FOTOVOLTAIK"

ZONA / LOCATION

BASHKIA E MIRDITËS

FASHA E PROJEKTI / PROJECT PHASE

PROJEKT ZBATIM / IMPLEMENTATION DESIGN

PROJEKTI ARCHITETUR / ARCHITECTURAL DESIGN

Ark. Rigonda MYDRELLARI
M. 11.4.2012
MIRANDA.MYDRELLARI@ZS.COM

PROJEKTI INZHINIERI / STRUCTURAL DESIGN

Ing. Rishap TAPDA
MIRANDA.MYDRELLARI@ZS.COM

PROJEKTI SHPËRTHYER / ME PUNË DHE KULLIM

Ing. Arqipe PEPI
MIRANDA.MYDRELLARI@ZS.COM

PROJEKTI INZHINIERI / PRINCIPAL DESIGN

Ing. Merita MESHU
MIRANDA.MYDRELLARI@ZS.COM

PROJEKTI ELIMTRIK / ELECTRICAL DESIGN

Ing. Kristaq ZHURPA
MIRANDA.MYDRELLARI@ZS.COM

SHKURIM: TËRBUKUR / TECHNICAL NOTES

SHKALLA

1:100

SHKURIM: 2008

SHKURIM: 2008

A-01

VLKA / STAMP

PLANIMETRI E PËRGJITHËSHME E OBJEKTIT

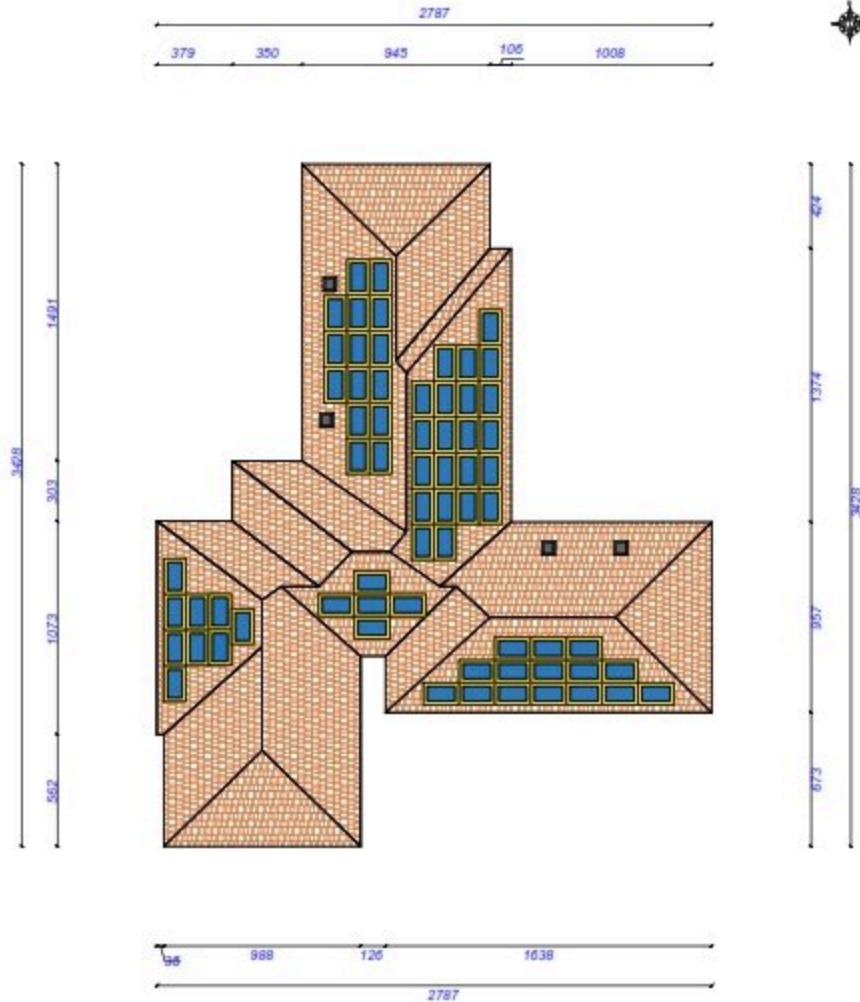

PROJEKTI: 13.047



BASHKIA MIRDITE, PESHKËPIE

KONSULLENT / CONSULTANT



SHKËMBIM TËRBUJËR / TECHNICAL NOTES

PROJEKTI / PROJECT NAME

"INSTALIMI I SISTEMIT FOTOVOLTAIK"

ZONA / LOCATION

BASHKIA MIRDITE

FASZË E PROJEKTI / PROJECT PHASE

PROJEKT ZBATIM /
IMPLEMENTATION OF DESIGN

PROJEKTI ARCHITETUROR / ARCHITECTURAL DESIGN

Ark. Rigjonda MYDRELLARI

Rr. 19 qershorit, 1002

02/04/2024 10:48:17

PROJEKTI INZHINIEROR / STRUCTURAL DESIGN

Ing. Rishap TAPDA

Rr. 19 qershorit, 1002

PROJEKTI MASHINOR / MECHANICAL DESIGN

Ing. Arqipe PEPI

Rr. 19 qershorit, 1002

PROJEKTI INZHINIEROR / ELECTRICAL DESIGN

Ing. Merita MESHU

Rr. 19 qershorit, 1002

PROJEKTI INZHINIEROR / ELECTRICAL DESIGN

Ing. Kristaq ZHURPA

Rr. 19 qershorit, 1002

SHKËMBIM TËRBUJËR / TECHNICAL NOTES

PLANI PËRGJITHËSHME E OBJEKTIT

SHKALLA

1:1000

SHKËMBIM TËRBUJËR

SHKËMBIM TËRBUJËR

A-02

VLKA / STAMP

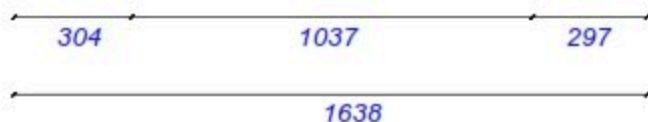
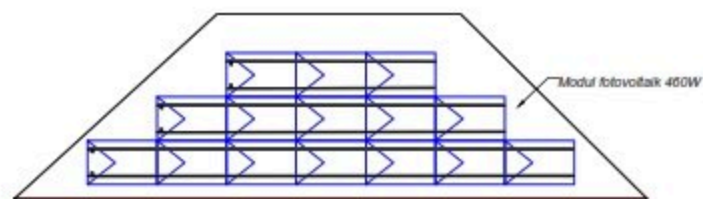
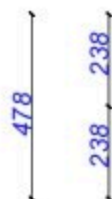
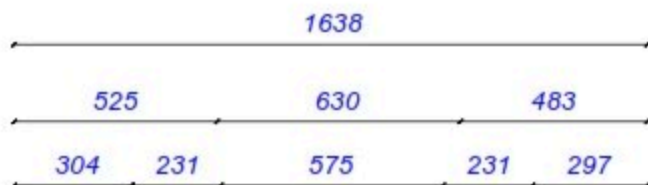

REPUBLIKA E KOSOVES

KONSULLANT / CONSULTANT



DOKUMENTI / DOCUMENT

PROJEKT / PROJECT NAME

"INSTALIMI I SISTEMIT FOTOVOLTAIK"

LOKA / LOCATION

BASHKIA MIRCITE

FASJA E PROJEKTTIT / PROJECT PHASE

PROJEKT ZBATIM / IMPLEMENTATION OF SIGN

PROJEKTI ARCHITETURE / ARCHITECTURAL DESIGN

Ark. Rajmonda MYDRELLARI

06.11.2012

06.11.2012

PROJEKTI INZHINIERI / STRUCTURAL DESIGN

Ing. Rashap TAPDA

06.11.2012

PROJEKTI MASHINORIE / MECHANICAL DESIGN

Ing. Arqife PEPI

06.11.2012

PROJEKTI INZHINIERI / PRINCIPAL DESIGN

Ing. Merita MESHU

06.11.2012

PROJEKTI INZHINIERI / ELECTRICAL DESIGN

Ing. Kiroq ZHURA

06.11.2012

SHENJETA / NOTES / FIELD OF DESIGN

DOKUMENTI E SHENJETA KU DO TE VENDOSEN / PART

SHKALLA / SCALE

SHKALLA / SCALE

SHKALLA / SCALE

SHENJETA / NOTES / FIELD OF DESIGN

A-03

VLAKA / STAMP



BASHKIA E PRISHTINES

KONSULLENT / CONSULTANT



SHKURIME TENDERE / TECHNICAL NOTES

PROJECT / PROJECT NAME

"INSTALIMI I SISTEMIT FOTOVOLTAIK"

ZONE / LOCATION

BASHKIA E PRISHTINES

FASE E PROJEKTTIT / PROJECT PHASE

PROJEKT ZBATIM / IMPLEMENTATION DESIGN

PROJEKTI ARCHITETUROR / ARCHITECTURAL DESIGN

Ark. Rajmonda MYDRELLARI

06.11.2022

06.11.2022

PROJEKTI KOSHTETIMOR / STRUCTURAL DESIGN

Ing. Rashap TAPDA

06.11.2022

PROJEKTI HAPORRITOR / ME PROJEKTIN E KOSHTIMIT

Ing. Arqipe PEJTI

06.11.2022

PROJEKTI INZHINIEROR / PRINCIPAL DESIGN

Ing. Merita MEGRI

06.11.2022

PROJEKTI ELEKTRIKOR / ELECTRICAL DESIGN

Ing. Kristaq ZHURPA

06.11.2022

SHKURIME TENDERE / TITLE OF DESIGN

DIMENSIONET E SIPERFAQES KU DO TE VENDOSEN PANELET FOTOVOLTAIKE

SHKALLA

1:100

SHKURIMI 2022

SHKURIMI / CONSULTANT

A-04

VLAKA / STAMP

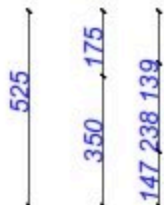
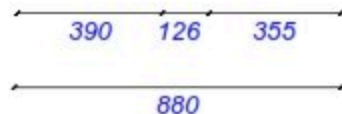
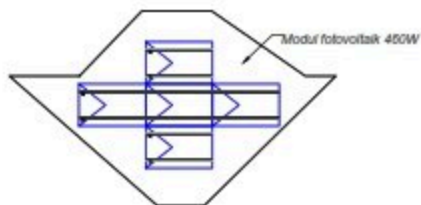

DIMENSIONET E SIPERFAQES KU DO TE VENDOSEN PANELET FOTOVOLTAIKE

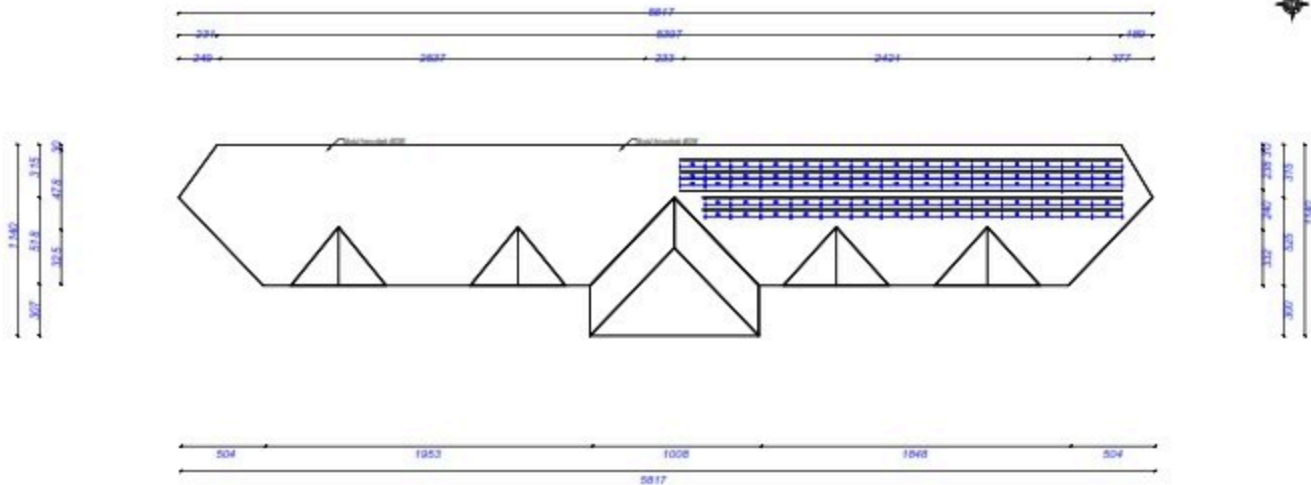

PROJEKTI: 12.007



BASHKIA MIRDIË, PESHKËPISË

KONSOLENT / CONSULTANT



SHKËMBIM: TËRBUJËR / TECHNICAL NOTES

PROJEKTI / PROJECT NAME

"INSTALIMI I SISTEMIT FOTOVOLTAIK"

FORMA / LOCATION

BASHKIA MIRDIË

FASË E PROJEKTI / PROJECT PHASE

PROJEKT ZBATIM / IMPLEMENTATION DESIGN

PROJEKTI ARCHITETUR / ARCHITECTURAL DESIGN

Ark. Rajmonda MYDRELLARI

16.11.2022

16.11.2022

PROJEKTI INZHINIERI / STRUCTURAL DESIGN

Ing. Rishap TAPKA

16.11.2022

PROJEKTI SHPËRNDARJE / ME PROJEKTIM DËRITJE

Ing. Anqel PEJVI

16.11.2022

PROJEKTI INZHINIERI / PRINCIPAL DESIGN

Ing. Merita MEGJI

16.11.2022

PROJEKTI ELEKTRIK / ELECTRICAL DESIGN

Ing. Kristaq ZHURPA

16.11.2022

SHËMBIM / SHEET / FIELD OF DESIGN

DIMENSIONET E SIPERFAQES KU DO TE VENDOSEN PANELET

SHKALLA

1:100

SHKËMBIM

2022

SHËMBIM / SHEET / FIELD OF DESIGN

A-05

VLAK / STAMP

SKEMA ELEKTRIKE AC

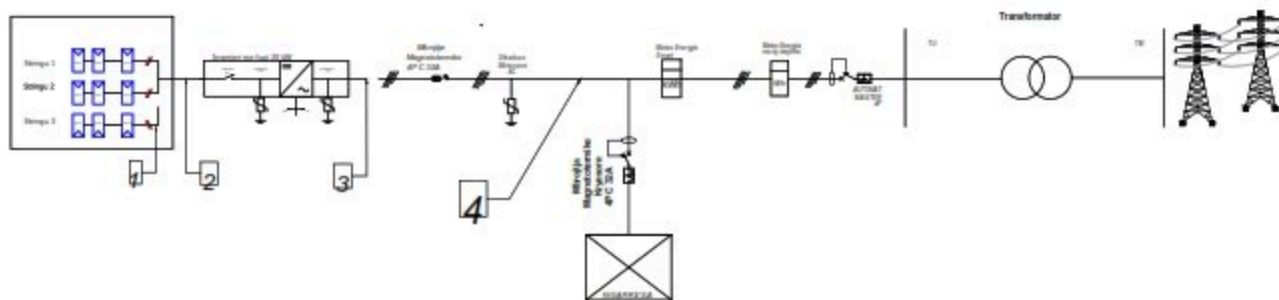

BASHKIA MIRDITE, REPUBLIKË

KONSULENT / CONSULTANT



ZENIT/CCO
Rr. Naim Frashëri Nr. 15, Shkup, MKD
t: 02 561 00 00
e: info.zenit@ccco.mk

SHKIMBI / EXCHANGE / TECHNICAL NOTES

PROJEKT / PROJECT NAME

"INSTALIMI I SISTEMIT
FOTOVOLTAIK"

JOZE / LOCATION

BASHKIA MIRDITE

FAZA E PROJEKTI / PROJECT PHASE

PROJEKT ZBATIM
IMPLEMENTATION DESIGN

PROJEKTI ARCHITETUROR / ARCHITECTURAL DESIGN

Ark. Rajmonda MYDRELLARE

Rr. Naim Frashëri Nr. 15, Shkup, MKD

t: 02 561 00 00

e: info.zenit@ccco.mk

PROJEKTI KONSTRUKTIV / STRUCTURAL DESIGN

Ing. Rishap TAPKA

Rr. Naim Frashëri Nr. 15, Shkup, MKD

t: 02 561 00 00

e: info.zenit@ccco.mk

PROJEKTI TERMOISOLACION / HEAT INSULATION DESIGN

Ing. Anjo PEVI

Rr. Naim Frashëri Nr. 15, Shkup, MKD

t: 02 561 00 00

e: info.zenit@ccco.mk

PROJEKTI IDENTIFIKACION / IDENTIFICATION DESIGN

Ing. Merita MEGHI

Rr. Naim Frashëri Nr. 15, Shkup, MKD

t: 02 561 00 00

e: info.zenit@ccco.mk

PROJEKTI ELEKTRIK / ELECTRICAL DESIGN

Ing. Kristiq ZHUPA

Rr. Naim Frashëri Nr. 15, Shkup, MKD

t: 02 561 00 00

e: info.zenit@ccco.mk

FAZA E PROJEKTI / PHASE OF DESIGN

SHKIMBI / EXCHANGE

SHKIMBI / EXCHANGE

SHKIMBI / EXCHANGE

SHKIMBI / EXCHANGE

SHKIMBI / EXCHANGE

SHKIMBI / EXCHANGE

SHKIMBI / EXCHANGE

SHKIMBI / EXCHANGE

SHKIMBI / EXCHANGE

SHKIMBI / EXCHANGE

SHKIMBI / EXCHANGE

SHKIMBI / EXCHANGE

SHKIMBI / EXCHANGE

SHKIMBI / EXCHANGE

SHKIMBI / EXCHANGE

SHKIMBI / EXCHANGE

SHKIMBI / EXCHANGE

SHKIMBI / EXCHANGE

SHKIMBI / EXCHANGE

SHKIMBI / EXCHANGE

SHKIMBI / EXCHANGE

SHKIMBI / EXCHANGE

SHKIMBI / EXCHANGE

SHKIMBI / EXCHANGE

SHKIMBI / EXCHANGE

SHKIMBI / EXCHANGE

SHKIMBI / EXCHANGE

SHKIMBI / EXCHANGE

A-06

SHKIMBI / EXCHANGE

DIMENSIONET E INVERTERIT

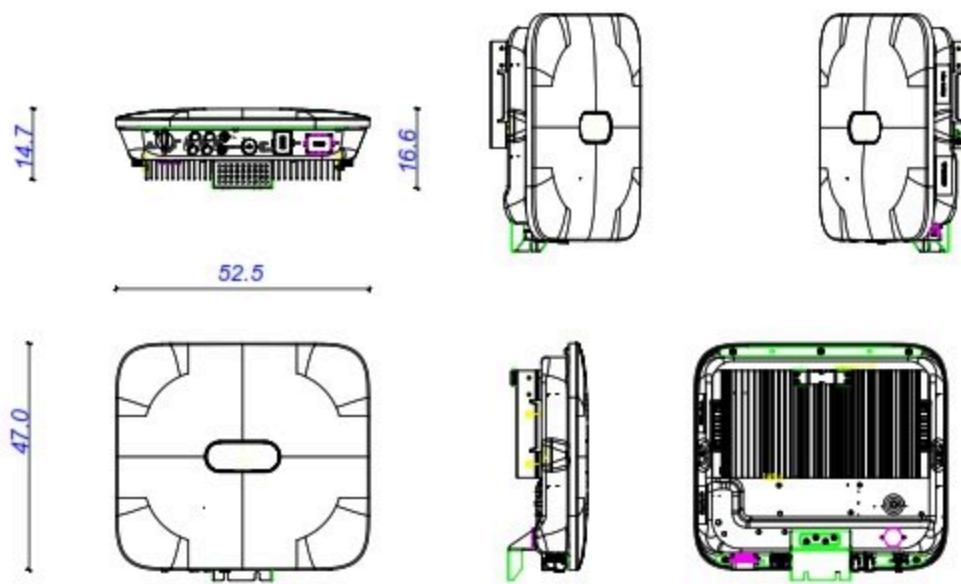

BASHKIA MIRODITE, PESHKËPISHTË

KONSULLENT / CONSULTANT



ZENITSCO CONSULTING

16 Shkurtorë, Tuzi (Rr. 19 qershorit, 1000)

Tel: +383 45 511 111

E-Mail: zenit@zenit.com

SHKËMBIM TËRBUJËR / TECHNICAL NOTES

PROJEKTI / PROJECT NAME

"INSTALIMI I SISTEMIT FOTOVOLTAIK"

ZONA / LOCATION

BASHKIA MIRODITE

FASË E PROJEKTI / PROJECT PHASE

PROJEKTI ZBATIM / IMPLEMENTATION DESIGN

PROJEKTI ARCHITETONIK / ARCHITECTURAL DESIGN

Ark. Rajmonda MYDRELLARI

Rr. D. R. 100

10000 MIRODITE

PROJEKTI INZHINIERI / STRUCTURAL DESIGN

Ing. Rashap XARDA

MIRODITE

PROJEKTI MASHINORIE / MECHANICAL DESIGN

Ing. Ardit PEPI

MIRODITE

PROJEKTI HEDHEMBIMTAR / ELECTRICAL DESIGN

Ing. Merita MESHU

MIRODITE

PROJEKTI DREJTIMOR / ELECTRICAL DESIGN

Ing. Kristaq ZHURPA

MIRODITE

EMËRTIMET / TITLE OF DESIGN

DIMENSIONET E INVERTERIT

SHKALLA

1:1

SHKËMBIMTAR

SHKËMBIMTAR

SHKËMBIMTAR / CONSULTANT

A-07

VLAKA / STAMP

SKEMA E SISTEMIT TE MATJES

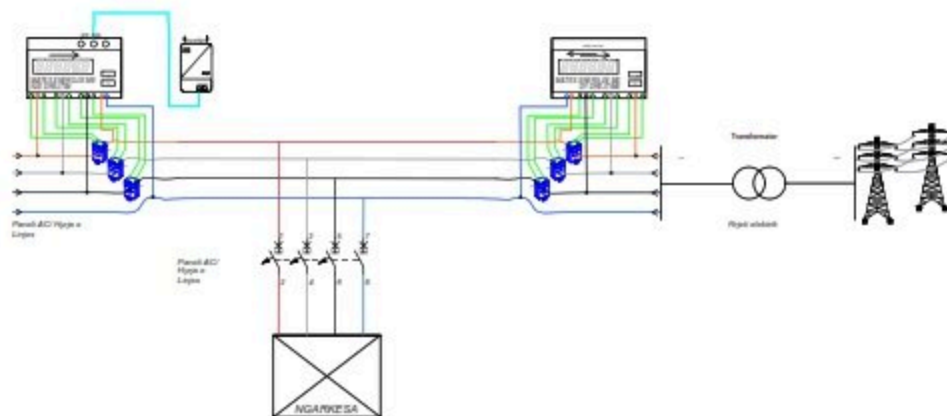

LEGJENDE	
	Inverter
	Transformator Flyge
	Shkëmbim Mbrojtës
	Axioni Ngjitur/ndarë
	Multi-Change Inverter
	Transformator TWT
	Rregullues
	Ngjiturja e Flyge

PROJEKTI: 12487



BASHKIA E MBRODITË

KONSULENTI / CONSULTANT



SHKËMBIM TËRBUKUR / TECHNICAL SERVICE

PROJEKTI / PROJECT NAME

"INSTALIMI I SISTEMIT FOTOVOLTAIK"

ZONA / LOCATION

BASHKIA E MBRODITË

FAZA E PROJEKTI / PROJECT PHASE

PROJEKTI ZBATIM / IMPLEMENTATION DESIGN

PROJEKTI ARCHITETONIK / ARCHITECTURAL DESIGN

Ark. Rajmonda MYDRELLARI

06.11.2022

06.11.2022

PROJEKTI INZHINIERI / STRUCTURAL DESIGN

Ing. Rashap TAPDA

06.11.2022

PROJEKTI MASHINORIE / MEK. PROJ. AND COOLING

Ing. Arqipe PEPI

06.11.2022

PROJEKTI INZHINIERI / MUNICIPAL DESIGN

Ing. Merita MEGYI

06.11.2022

PROJEKTI INZHINIERI / ELECTRICAL DESIGN

Ing. Kristaq ZHURPA

06.11.2022

PROJEKTI INZHINIERI / TABLE OF DESIGN

06.11.2022

PROJEKTI INZHINIERI / TABLE OF DESIGN

06.11.2022

PROJEKTI INZHINIERI / TABLE OF DESIGN

06.11.2022

PROJEKTI INZHINIERI / TABLE OF DESIGN

06.11.2022

PROJEKTI INZHINIERI / TABLE OF DESIGN

06.11.2022

PROJEKTI INZHINIERI / TABLE OF DESIGN

06.11.2022

PROJEKTI INZHINIERI / TABLE OF DESIGN

06.11.2022

PROJEKTI INZHINIERI / TABLE OF DESIGN

06.11.2022

PROJEKTI INZHINIERI / TABLE OF DESIGN

06.11.2022

PROJEKTI INZHINIERI / TABLE OF DESIGN

06.11.2022

PROJEKTI INZHINIERI / TABLE OF DESIGN

06.11.2022

PROJEKTI INZHINIERI / TABLE OF DESIGN

06.11.2022

SHKALLA

1:1

SHKURT 2022

06.11.2022

06.11.2022

06.11.2022

06.11.2022

06.11.2022

06.11.2022

06.11.2022

06.11.2022

06.11.2022

06.11.2022

06.11.2022

SHKALLA

1:1

SHKURT 2022

06.11.2022

06.11.2022

06.11.2022

06.11.2022

06.11.2022

06.11.2022

06.11.2022

06.11.2022

06.11.2022

06.11.2022

06.11.2022

A-09

VLAK / STAMP

PLANVENDOSJA E INVERTERIT

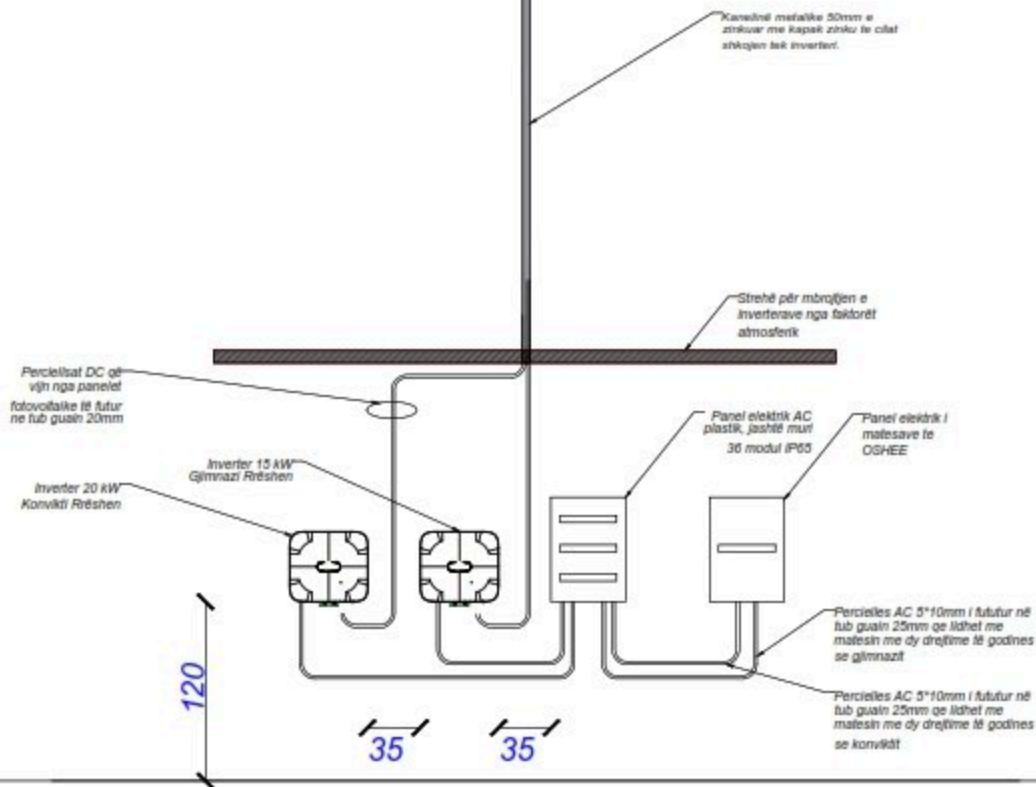

PROJEKTI - 13.007



BASHKIA E RRETHIT TË PËRFQËSUA

KONSTRUKT - CONSULTANT



SHKËMBIM TËNDRIM - TECHNICAL NOTES

PROJEKTI - PROJECT NAME

"INSTALIMI I SISTEMIT FOTOVOLTAIK"

QASIM - LOCATION

BASHKIA E RRETHIT TË PËRFQËSUA

FAZJA E PROJEKTI - PROJECT PHASE

PROJEKTI ZBATIM / IMPLEMENTATION OF DESIGN

PROJEKTI ARCHITETUROR - ARCHITECTURAL DESIGN

Ark. Rajmonda MYDRELLARI

PROJEKTI KONSTRUKTIV - STRUCTURAL DESIGN

Ing. Rishap TARDA

PROJEKTI MASHINORIE - MEK. PROJ. AND COLLING

Ing. Arqipe PEPI

PROJEKTI HEDRIMOR - MUNICIPAL DESIGN

Ing. Merita MESIRI

PROJEKTI ELEKTRIK - ELECTRICAL DESIGN

Ing. Kristaq ZHURRA

PROJEKTI VLERËSIME / VAL OF DESIGN

PLANIMORIE E SHKËMBIMIT

SHKALLA

SHKURT 2020

SHKALLA E SHKËMBIMIT

A-10

VLAK / STAMP

PROJEKTI FOTOVOLTAIK

OBJEKTI: "Kopshti i Ri Rrëshen 21.16 kWp"

PROGRAMI: "Projektimi i Sistemit Fotovoltaik"

MBESHTETES: IPA II Cross Border Cooperation Programme for Albania- Kosovo

PERFITUES: Bashkia Mirditë



ZENIT&CO

Tiranë 2026



BASHKIA MIRDITE

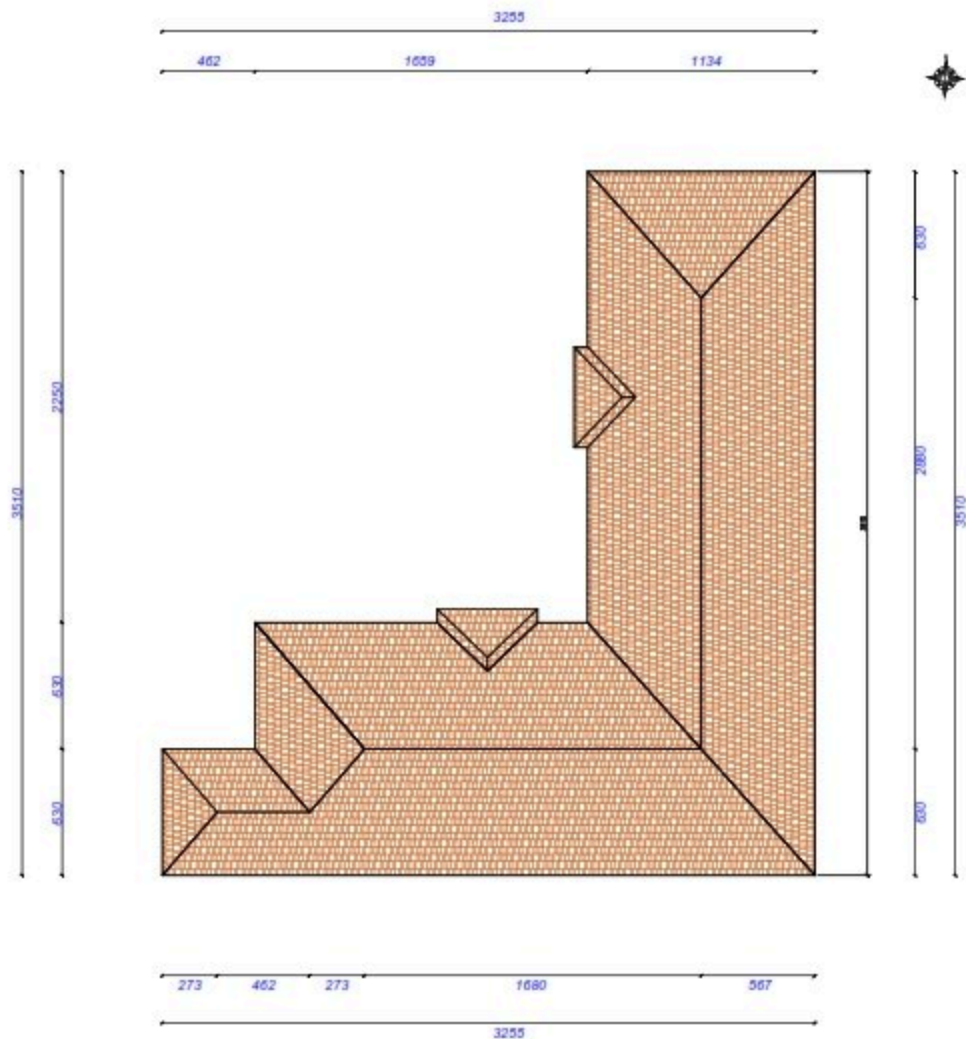

BASHKIA MIRDIË, REPUBLIKË

KONSOLENT / CONSULTANT



SHKËMBIM TËRBUJËR / TECHNICAL NOTES

PROJEKTI / PROJECT NAME

"INSTALIMI I SISTEMIT FOTOVOLTAIK"

ZONA / LOCATION

BASHKIA MIRDIË

FAZA E PROJEKTI / PROJECT PHASE

PROJEKT ZBATIM / IMPLEMENTATION DESIGN

PROJEKTI ARCHITETUROR / ARCHITECTURAL DESIGN

Ark. Rigjonda MYDRELLARI
 Nr. 14-02/102
 Bashkia Mirdite, Shqipëri

PROJEKTI INZHINJEROR / STRUCTURAL DESIGN

Ing. Rashap TAPDA
 Nr. 14-02/102

PROJEKTI SHKËMBIM TËRBUJËR / MEP AND COORDIN.

Ing. Arqipe PEPI
 Nr. 14-02/102

PROJEKTI INZHINJEROR / MUNICIPAL DESIGN

Ing. Merita MESHU
 Nr. 14-02/102

PROJEKTI INZHINJEROR / ELECTRICAL DESIGN

Ing. Kristaq ZHURPA
 Nr. 14-02/102

SHKËMBIM TËRBUJËR / FIELD OF DESIGN

PLANIMORALIVE SHKËMBIM TËRBUJËR

SHKALLA

1:1000

SHKËMBIM TËRBUJËR

SHKËMBIM TËRBUJËR

A-01

VLAKA / STAMP

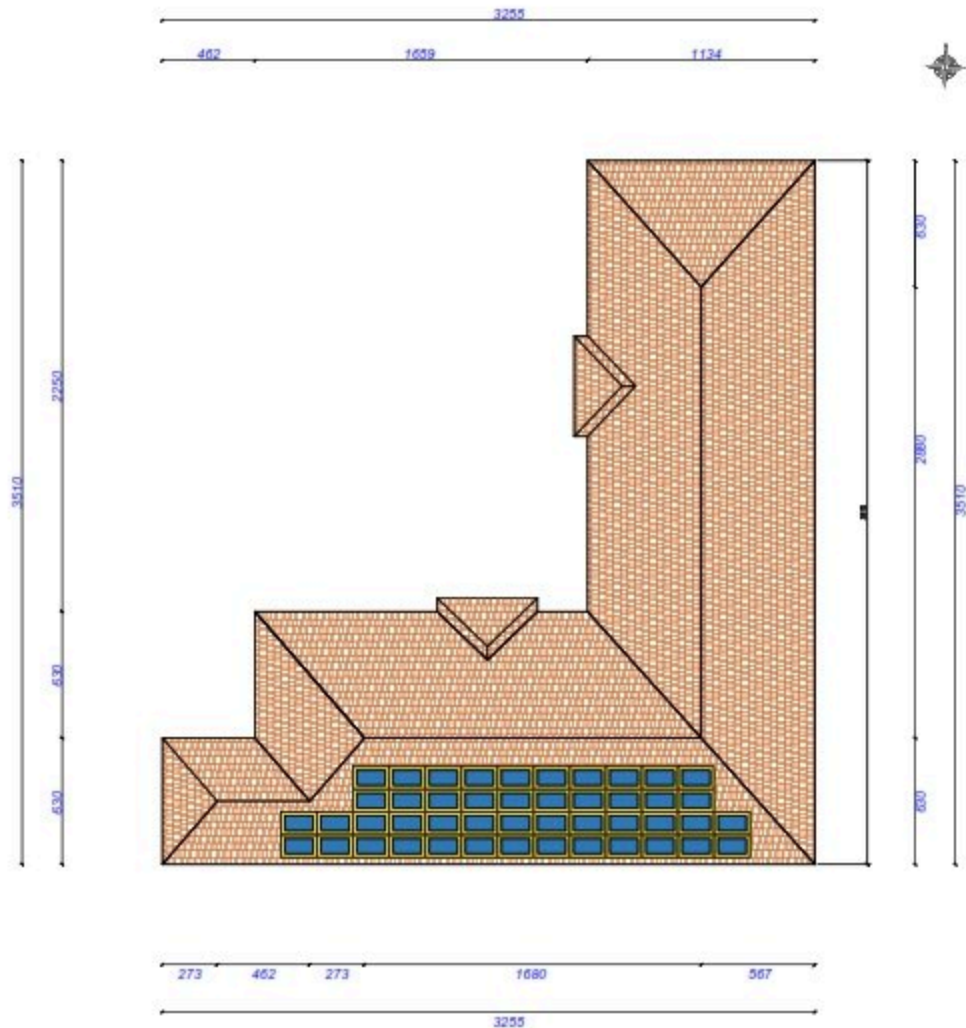

ZASHKIA MRODITE, PERIPHYDITE

KONSULTANT / CONSULTANT



ZENITBCCO
 ZENITBCCO
 16, Shkumbrii, Tiranë, Shqipëri
 TIRANË, Shqipëri
 Tel: +355 42 200 000
 E-Mail: zenitbcco@gmail.com

SHKËMBI / TECHNICAL NOTES

PROJECT / PROJECT NAME

"INSTALIMI I SISTEMIT FOTOVOLTAIK"

ZONE / LOCATION

ZASHKIA MRODITE

PAGE # PROJECT / PROJECT PAGE

PROJEKT ZBATIM / IMPLEMENTATION DESIGN

PROJECT ARCHITECTURE / ARCHITECTURAL DESIGN

Ark. Rigonda MYDRELLARI
 Nr. 11, Rr. D. BEJ
 ZASHKIA MRODITE, SHqipëri

PROJECT ARCHITECTURE / STRUCTURAL DESIGN

Ing. Rashap TAPDA
 Nr. 11, Rr. D. BEJ

PROJECT ARCHITECTURE / MECHANICAL DESIGN

Ing. Arqipe PEPI
 Nr. 11, Rr. D. BEJ

PROJECT ARCHITECTURE / ELECTRICAL DESIGN

Ing. Merita MESHU
 Nr. 11, Rr. D. BEJ

PROJECT ARCHITECTURE / ELECTRICAL DESIGN

Ing. Kristaq ZHURJA
 Nr. 11, Rr. D. BEJ

PROJECT ARCHITECTURE / FIELD OF DESIGN

PLANIMETRIE SHKËMBI

SHKËLLA

SCALE: 1:500

PROJECT 2025

APPROVED / APPROVED BY

A-02

SCALE / STAMP



REPUBLIKA E KOSOVES

KONSULLIST / CONSULTANT



SHKURIME TENDERE / TECHNICAL NOTES

PROJECT / PROJECT NAME

"INSTALIMI I SISTEMIT FOTOVOLTAIK"

ZONE / LOCATION

ZASHKIA MRODITE

PAGE / PROJECT / PROJECT NAME

PROJEKT ZBATIM / IMPLEMENTATION OF SIGN

PROJECT ARCHITECTURE / ARCHITECTURAL DESIGN

Ark. Rajmonda MYDRELLARI
BULEVARI 10
ZASHKIA MRODITE

PROJECT ARCHITECTURE / STRUCTURAL DESIGN

Ing. Rashap XAPDA
BULEVARI 10

PROJECT ARCHITECTURE / MECHANICAL DESIGN

Ing. Arqife FEMI
BULEVARI 10

PROJECT ARCHITECTURE / ELECTRICAL DESIGN

Ing. Merita MEGRI
BULEVARI 10

PROJECT ARCHITECTURE / ELECTRICAL DESIGN

Ing. Kristaq ZHURPA
BULEVARI 10

PROJECT ARCHITECTURE / FIELD OF DESIGN

DIMENSIONET E SIPERFAQES KU DO TE VENDOSEN PANJELET

SHKALLA

SCALE

SHKURIMI 2024

SHKURIMI / DRAWING NO.

A-03

VLAK / STAMP

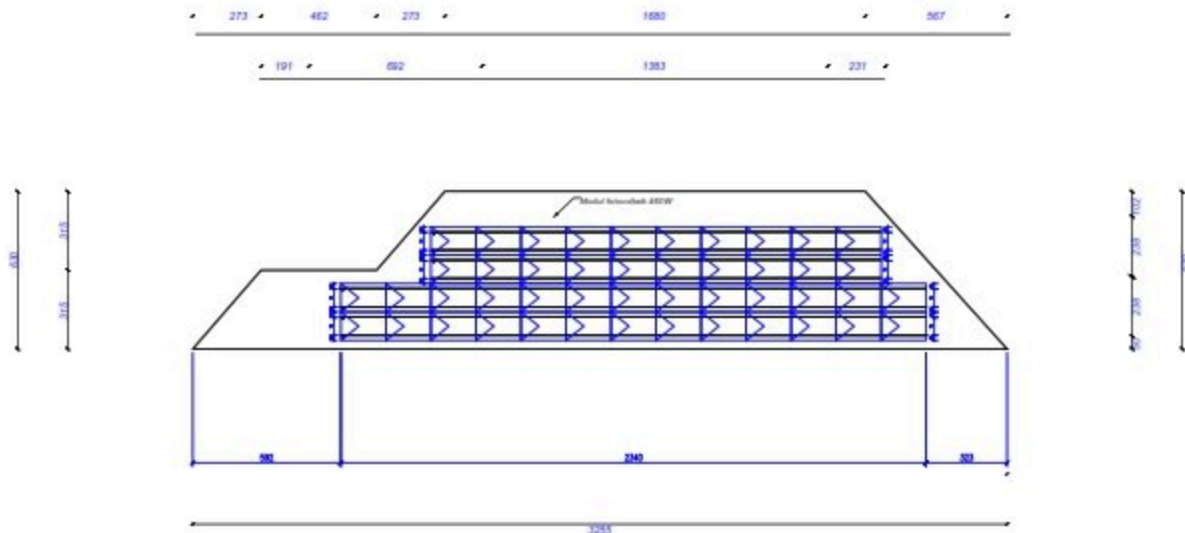

DIMENSIONET E STRUKTURES MBAJTESE



REPUBLIKA E KOSOVES, PRAPYRITURE

KONSULLANT - CONSULTANT



DOKUMENTI TËRISHTËR - TECHNICAL NOTES

PROJEKTI - PROJECT NAME

"INSTALIMI I SISTEMIT FOTOVOLTAIK"

ZONA - LOCATION

ZASHKIA MRODITE

FASHA E PROJEKTI - PROJECT PHASE

PROJEKT ZBATIM /
IMPLEMENTATION DESIGN

PROJEKTI ARCHITETUROR - ARCHITECTURAL DESIGN

Ark. Rajmonda MYDRELLARI
Rr. U. K. D. 102
ZASHKIA MRODITE

PROJEKTI INZHINIEROR I STRUKTURES - STRUCTURAL DESIGN

Ing. Rashap TAPDA
Rr. U. K. D. 102

PROJEKTI INZHINIEROR I NEJTRONIKES DHE KULES -
ELECTRICAL DESIGN

Ing. Arqipe PEPI
Rr. U. K. D. 102

PROJEKTI INZHINIEROR I PRAPYRITURE - MECHANICAL DESIGN

Ing. Merita MEGRI
Rr. U. K. D. 102

PROJEKTI INZHINIEROR I ELEKTRIKES - ELECTRICAL DESIGN

Ing. Kristaq ZHURPA
Rr. U. K. D. 102

SHKALLA / SCALE / TITLE OF DESIGN

DIMENSIONET E STRUKTURES MBAJTESE

SHKALLA / SCALE

PROJEKTI 2025

SHKALLA / SCALE

A-04

VLKA / STAMP

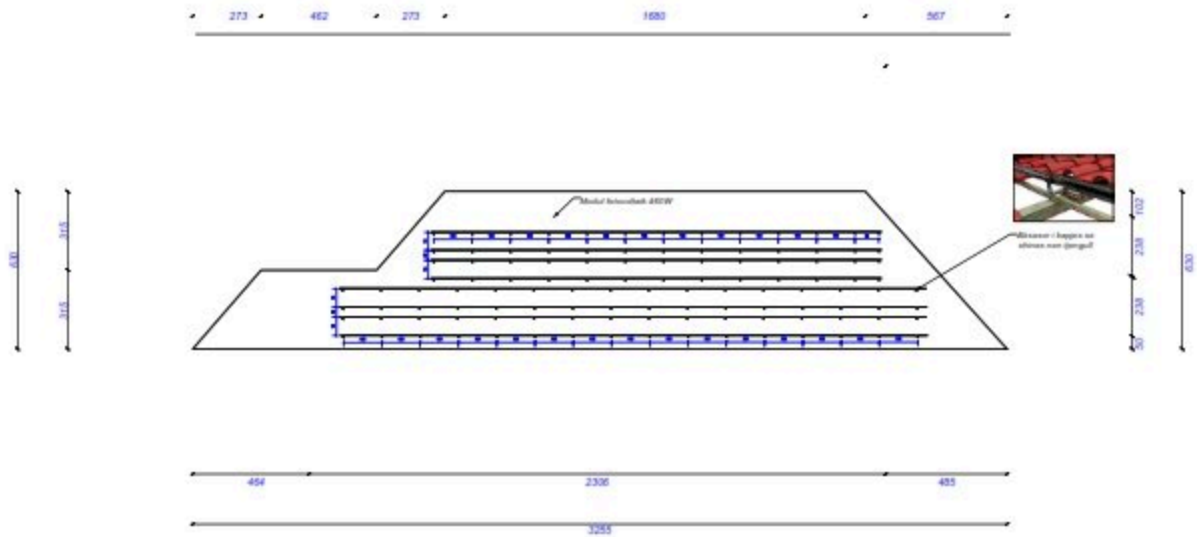

SKEMA E KONFIGURIMIT DC

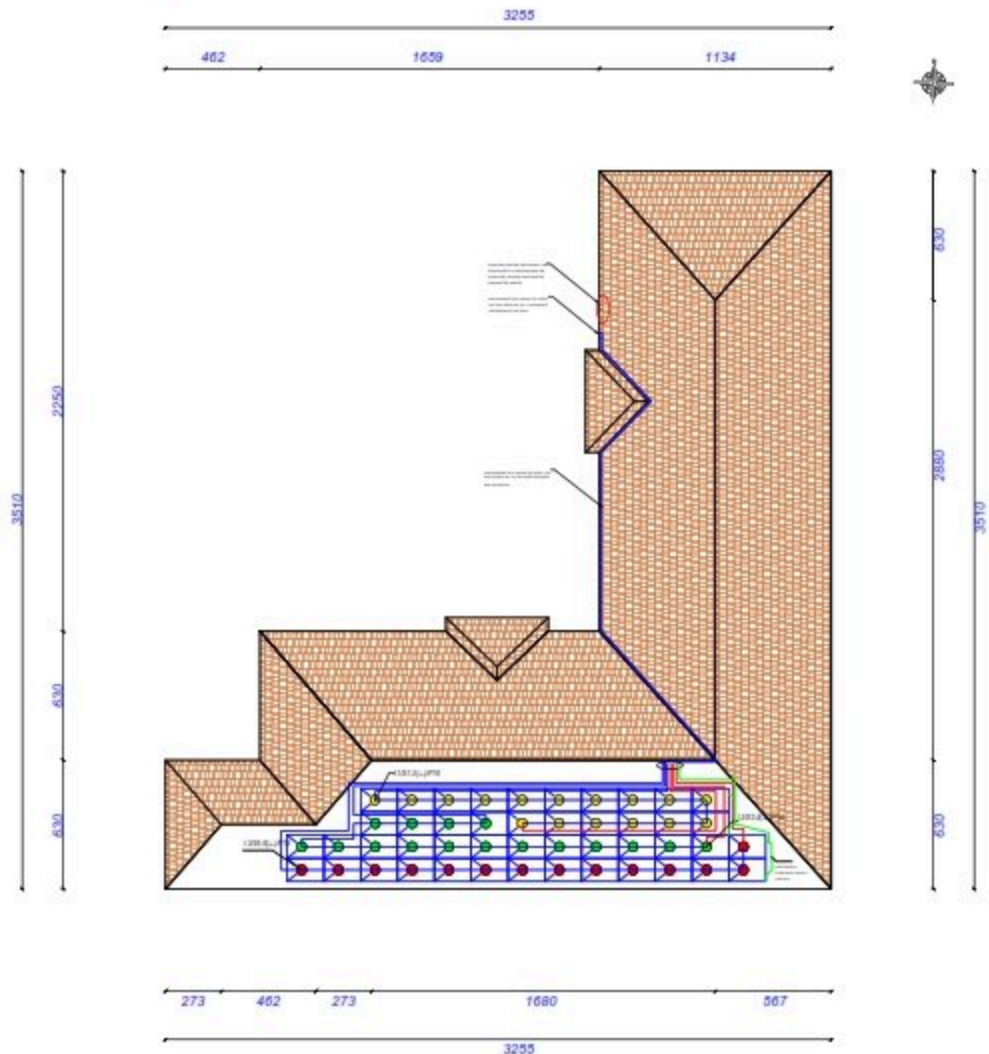

PROJEKTI: 13-0387



BASHKIA MIRDITE, PERIPIETURE

KONSTRUKT: KONSTRUKT



SHKURIME: TIRAZO - TECHNICAL NOTES

PROJEKTI: PROJECT NAME

"INSTALIMI I SISTEMIT FOTOVOLTAIK"

ZONA: LOCATION

BASHKIA MIRDITE

FASHE E PROJEKTI: PROJECT PHASE

PROJEKT ZBATIM / IMPLEMENTATION OF SIGN

PROJEKTI ARCHITETURE: ARCHITECTURAL DESIGN

Ark. Rajmonda MYDRELLARI

PROJEKTI KONSTRUKTIVE: STRUCTURAL DESIGN

Ing. Rishap XARDA

PROJEKTI MASHINORIE: MEK. PROJ. AND COOLING

Ing. Arqife PEJLI

PROJEKTI HEDRIMETRIE: MUNICIPAL DESIGN

Ing. Merita MESIRI

PROJEKTI SHTATIMORIE: ELECTRICAL DESIGN

Ing. Kristaq ZHURPA

PROJEKTI VALVET: FIELD OF DESIGN

SKEMA E KONFIGURIMIT DC

SHKALLA:

SHKURT 2020

SHKURT: DRAWING NO.

A-05

VLAK: STAMP

SKEMA ELEKTRIKE AC

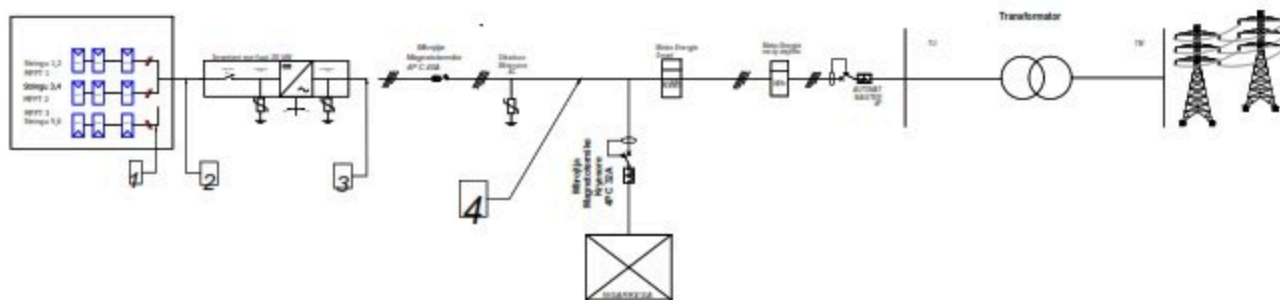

PROJEKTOV: 13.0007



BASHKIA MIRDIË, PESHKËPISË

KONSOLENT: KONSOLENT



ZENITSCO
Shërbime Tërëq. (Sh. Tërëq. Shërbime)
E-Mail: zenit@zenit.com

SHKURIME: TËRËQO / TECHNICAL NOTES

PROJEKTI: PROJECT NAME

"INSTALIMI I SISTEMIT FOTOVOLTAIK"

JOH: LOCATION

BASHKIA MIRDIË

FAJË E PROJEKTI: PROJECT PHASE

PROJEKTI ZBATIM /
IMPLEMENTATION DESIGN

PROJEKTI ARCHITETUROR - ARCHITECTURAL DESIGN

Ark. Rajmonda MYDRELLAR

Sh. 14.02.2012

Sh. 14.02.2012

PROJEKTI KOSMETIKO - STRUCTURAL DESIGN

Ing. Rashap TAPDA

Sh. 14.02.2012

PROJEKTI SHËRBIMOR - HEAT INSULATION DESIGN

Ing. Arqipe PEPI

Sh. 14.02.2012

PROJEKTI IDENTIFIKIMOR - MUNICIPAL DESIGN

Ing. Merita MEGRI

Sh. 14.02.2012

PROJEKTI ELEKTRIKOR - ELECTRICAL DESIGN

Ing. Kristaq ZHURPA

Sh. 14.02.2012

EMËRTIMI I FAJËS / TITLE OF DESIGN

SHKURIME ELEKTRIKE AC

SHKALLA

SHKURIMI

SHKURIMI

SHKURIMI / SHKURIMI

A-06

VELA / STAMP

DIMENSIONET E INVERTERIT

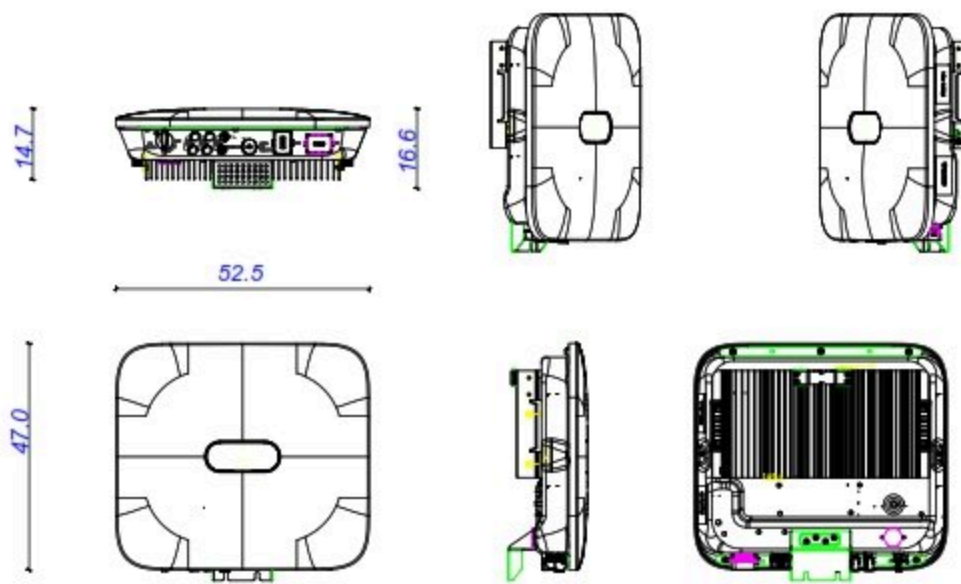

BASHKIA MIRODITE, REPUBLIKË E SHqipërisë

KONSULLANT / CONSULTANT



ZENITSCO
Rr. Shqipëri, Turrpik, 19000, Shqipëri
T: +355 69 22 22 22
E: info@zenitso.com

SHKËMBIM TËRBUJËR / TECHNICAL NOTES

PROJEKTI / PROJECT NAME

"INSTALIMI I SISTEMIT FOTOVOLTAIK"

ZONA / LOCATION

BASHKIA MIRODITE

FASË E PROJEKTI / PROJECT PHASE

PROJEKTI ZBATIM / IMPLEMENTATION DESIGN

PROJEKTI ARCHITETONIK / ARCHITECTURAL DESIGN

Ark. Rigjendra MYDRELLAP
Rr. D. K. D. 102
Bashkia Mirodite, Shqipëri

PROJEKTI INZHINIERI / STRUCTURAL DESIGN

Ing. Rishap TAPIDA
Bashkia Mirodite

PROJEKTI SHPËRTHYER / MEK. PROJ. AND COOLING

Ing. Ardit PEJVI
Bashkia Mirodite

PROJEKTI INZHINIERI / ELECTRICAL DESIGN

Ing. Merita MEGJVI
Bashkia Mirodite

PROJEKTI INZHINIERI / ELECTRICAL DESIGN

Ing. Kristaq ZHURPA
Bashkia Mirodite

FAZË TËRBUJËR / TITLE OF DESIGN

DIMENSIONET E INVERTERIT

SHKËLLA

SKALA / SCALE

SHKËMBIM TËRBUJËR

SHKËMBIM TËRBUJËR

A-07

VLAKA / STAMP

SKEMA E SISTEMIT TE MATJES

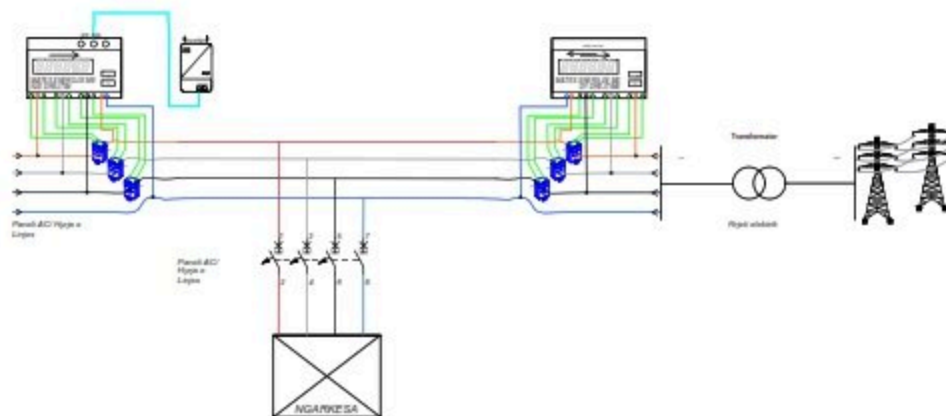

LEGJENDE	
	Shprehës
	Çelësi i Sigurisë
	Shpërthyes
	Siç është e nevojshme
	Transformator
	Rrethi shpirtor
	Paneli AC/ Fijta e Lajta



BASHKIA E PRISHTINËS

KONSULENT / CONSULTANT



SHKURTIMI: 202002 - TECHNICAL DRAWING

PROJEKT / PROJECT NAME

"INSTALIMI I SISTEMIT FOTOVOLTAIK"

JEKIM / LOCATION

BASHKIA E PRISHTINËS

FAJDE / PROJECT / PROJECT NAME

PROJEKT ZBATIM / IMPLEMENTATION OF SIGN

PROJEKTI ARCHITETUROR / ARCHITECTURAL DESIGN

Ark. Rajmonda MYDRELLARI

06.11.2020

06.11.2020

PROJEKTI INZHINIEROR / STRUCTURAL DESIGN

Ing. Rashap TAPDA

06.11.2020

PROJEKTI MASHINOR / MECHANICAL DESIGN

Ing. Ardit PEPI

06.11.2020

PROJEKTI INZHINIEROR / ELECTRICAL DESIGN

Ing. Merita MEGRI

06.11.2020

PROJEKTI INZHINIEROR / ELECTRICAL DESIGN

Ing. Kristaq ZHURPA

06.11.2020

PROJEKTI INZHINIEROR / ELECTRICAL DESIGN

PROJEKTI INZHINIEROR / ELECTRICAL DESIGN

06.11.2020

SHKALLA

1:1

SHKURIMI 2020

SHKURIMI / CONSULTANT

06.11.2020

06.11.2020

06.11.2020

06.11.2020

06.11.2020

06.11.2020

06.11.2020

06.11.2020

06.11.2020

06.11.2020

A-08

PLANVENDOSJA E INVERTERIT

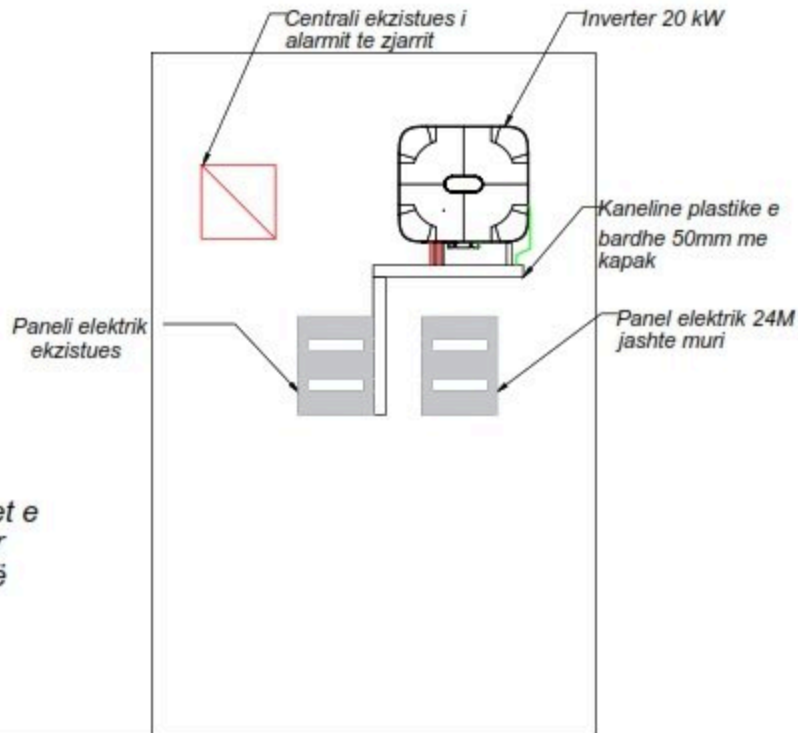

Inverteri do të vendosen në ambientet e brendshme tek muri ku janë instaluar paneli elektrik dhe centrali i alarmit të zjarrit.

PROJEKTI: 13.04.07



BASHKIA E PRIZRENIT

KONSULLANT / CONSULTANT



SHKËMBI TËRBUK / TECHNICAL NOTES

PROJEKTI / PROJECT NAME

"INSTALIMI I SISTEMIT FOTOVOLTAIK"

PAZI / LOCATION

BASHKIA E PRIZRENIT

FAZA E PROJEKTI / PROJECT PHASE

PROJEKT ZBATIM / IMPLEMENTATION DESIGN

PROJEKTI ARCHITETUROR / ARCHITECTURAL DESIGN

Ark. Rigonda MYDRELLARI

06.04.2012

06.04.2012

PROJEKTI KONSTRUKTIV / STRUCTURAL DESIGN

Ing. Rashap TAPDA

06.04.2012

PROJEKTI MONTAZH / MECHANICAL DESIGN

Ing. Arqif PEPI

06.04.2012

PROJEKTI MONTAZH / ELECTRICAL DESIGN

Ing. Merita MEGRI

06.04.2012

PROJEKTI MONTAZH / FIELD OF DESIGN

PLANIMETRI E BASHKIS

SHKALLA

1:100

SHKURT 2008

SHKURT / SHORT

A-09

VLKA / STAMP

PROJEKTI FOTOVOLTAIK

OBJEKTI: "Kopshti i Vjeter Rrëshen"

PROGRAMI: "Projektimi i Sistemit Fotovoltaik"

MBESHTETES: IPA II Cross Border Cooperation Programme for Albania- Kosovo

PERFITUES: Bashkia Mirditë



ZENIT&CO

Tiranë 2026



BASHKIA MIRDITE

PLANIMETRI E PËRGJITHËSHME E OBJEKTIT

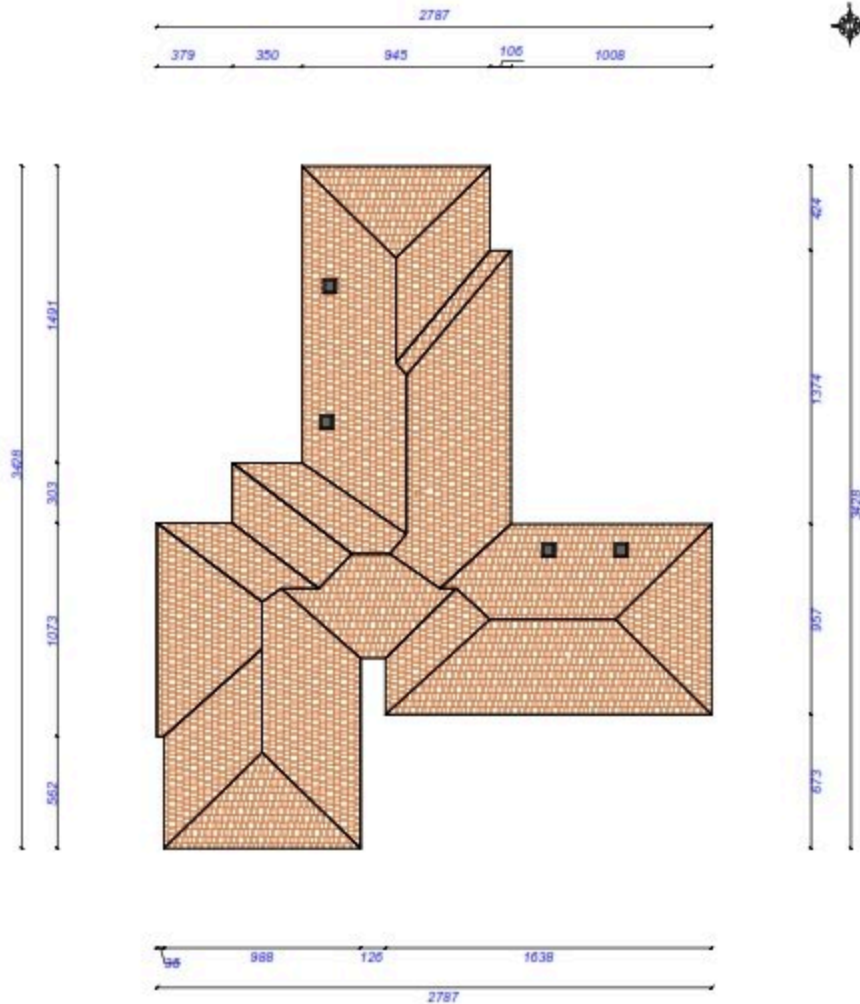

PROJEKTI: 13.04.87



BASHKIA MBRODITE

KONSULLENT / CONSULTANT



SHKURIME TËRHEQUR / TECHNICAL NOTES

PROJEKTI / PROJECT NAME

"INSTALIMI I SISTEMIT FOTOVOLTAIK"

ZONA / LOCATION

BASHKIA MBRODITE

FASHA E PROJEKTI / PROJECT PHASE

PROJEKT ZBATIM / IMPLEMENTATION DESIGN

PROJEKTI ARCHITETUROR / ARCHITECTURAL DESIGN

Ark. Rigonda MYDRELLARI

06.11.2012

06.11.2012

PROJEKTI INZHINIEROR / STRUCTURAL DESIGN

Ing. Rishap TAPDA

06.11.2012

PROJEKTI MARRËMOR / ME PROJEKTIM DËRHOJË

Ing. Arqipe PEPI

06.11.2012

PROJEKTI INZHINIEROR / PRINCIPAL DESIGN

Ing. Merita MESHU

06.11.2012

PROJEKTI ELIMETRIK / ELECTRICAL DESIGN

Ing. Kristaq ZHURPA

06.11.2012

SHKURIME TËRHEQUR / FIELD OF DESIGN

PLANIMETRI I OBJEKTIT

SHKALLA

1:100

SHKURIMI

2012

SHKURIMI / SIGNATURE

A-01

VLKA / STAMP

PLANIMETRI E PËRGJITHËSHME E OBJEKTIT

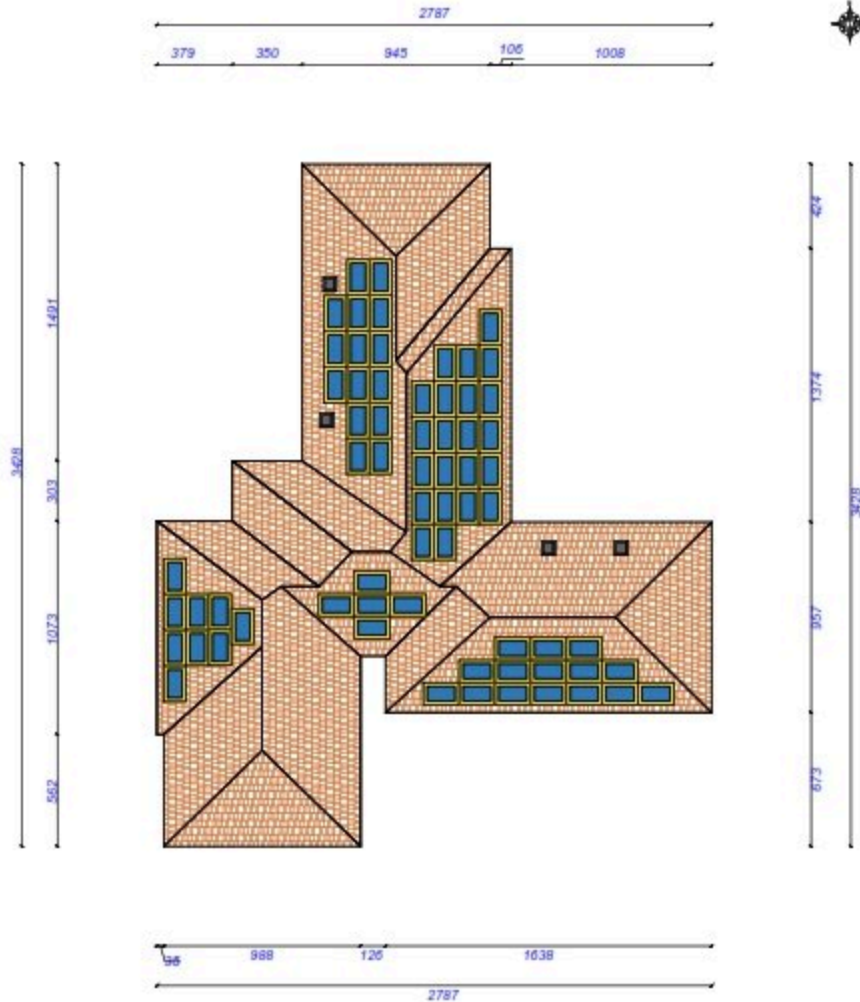

PROJEKTI: 13.047



BASHKIA E MIRDITËS

KONSULLENT / CONSULTANT



SHËRBIM TËRBUOR / TECHNICAL SERVICE

PROJEKTI / PROJECT NAME

"INSTALIMI I SISTEMIT FOTOVOLTAIK"

ZONA / LOCATION

BASHKIA E MIRDITËS

FASHA E PROJEKTI / PROJECT PHASE

PROJEKT ZBATIM / IMPLEMENTATION OF DESIGN

PROJEKTI ARCHITETUROR / ARCHITECTURAL DESIGN

Ark. Rigonda MYDRELLARI

06.11.2022

06.11.2022

PROJEKTI INZHINIEROR / STRUCTURAL DESIGN

Ing. Rishap TAPDA

06.11.2022

PROJEKTI SHËRBIMOR / ME PROJEKTIM DHE SHËRBIM

Ing. Arqipe PEPI

06.11.2022

PROJEKTI INZHINIEROR / PRINCIPAL DESIGN

Ing. Merita MESHU

06.11.2022

PROJEKTI SHTUAR / ELECTRICAL DESIGN

Ing. Kristaq ZHURPA

06.11.2022

SHËRBIM / SERVICE / FIELD OF DESIGN

PLANIMETRI I OBJEKTIT

SHALLA

SCHEMATIC

SHËRBIM 2022

SHËRBIMOR / SERVICE

A-02

VLKA / STAMP

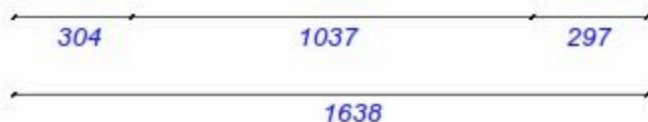
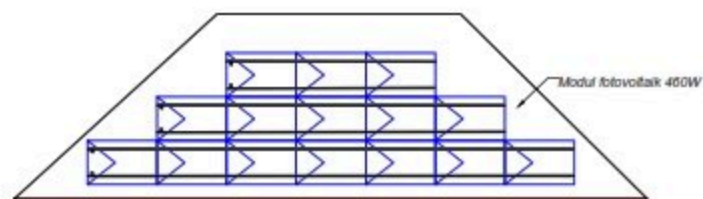
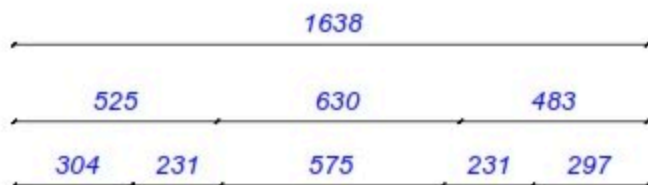

REPUBLIKA E KOSOVES

KONSULLANT / CONSULTANT



SHKIMBI TENDERS / TECHNICAL NOTES

PROJECT / PROJECT NAME

"INSTALIMI I SISTEMIT
FOTOVOLTAIK"

JOB / LOCATION

BASHKIA MIRCITE

PHASE / PROJECT / PROJECT PHASE

PROJEKT ZBATIM
IMPLEMENTATION OF SIGN

PROJECT ARCHITECTURE / ARCHITECTURAL DESIGN

Ark. Rajmonda MYDRELLARI
B-11-4-02-102
Bashkia Mircite, Kosova

PROJECT ARCHITECTURE / STRUCTURAL DESIGN

Ing. Rashap TAPDA
Bashkia Mircite

PROJECT ARCHITECTURE / MECHANICAL DESIGN

Ing. Arqife PEPI
Bashkia Mircite

PROJECT ARCHITECTURE / ELECTRICAL DESIGN

Ing. Merita MESHVI
Bashkia Mircite

PROJECT ARCHITECTURE / ELECTRICAL DESIGN

Ing. Kiroq ZHURA
Bashkia Mircite

PROJECT ARCHITECTURE / FIELD OF DESIGN

DESIGNER'S SIGNATURE AND TO VENDOR'S
REMARK

SKEMA

SKEMA 2024

REVIZIONE / REVISIONS

A-03

VLAK / STAMP



BASHKIA E PRISHTINES

KONSULLENT / CONSULTANT



SHKURIME TENDERE / TECHNICAL NOTES

PROJECT / PROJECT NAME

"INSTALIMI I SISTEMIT FOTOVOLTAIK"

JOB / LOCATION

BASHKIA E PRISHTINES

PAGE / PROJECT / PROJECT PAGE

PROJEKT ZBATIM / IMPLEMENTATION DESIGN

PROJECT ARCHITECTURE / ARCHITECTURAL DESIGN

Ark. Rajmonda MYDRELLARI

06-11-02-102
06-11-02-102

PROJECT ARCHITECTURE / STRUCTURAL DESIGN

Ing. Rashap TAPDA

06-11-02-102

PROJECT ARCHITECTURE / MECHANICAL DESIGN

Ing. Arqipe PEPI

06-11-02-102

PROJECT ARCHITECTURE / ELECTRICAL DESIGN

Ing. Merita MEGRI

06-11-02-102

PROJECT ARCHITECTURE / ELECTRICAL DESIGN

Ing. Kristaq ZHURPA

06-11-02-102

PROJECT ARCHITECTURE / TITLE OF DESIGN

IMPLEMENTATION DESIGN FOR PHOTOVOLTAIC

SHKALLA

1:100

SHKURTI 2020

REVIZIONE / REVISIONS

A-04

VLKA / STAMP

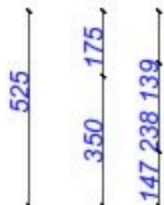
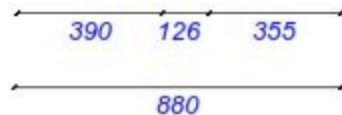
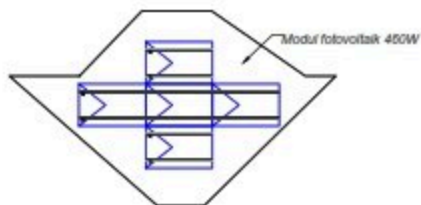

DIMENSIONET E SIPERFAQES KU DO TE VENDOSEN PANELET FOTOVOLTAIKE

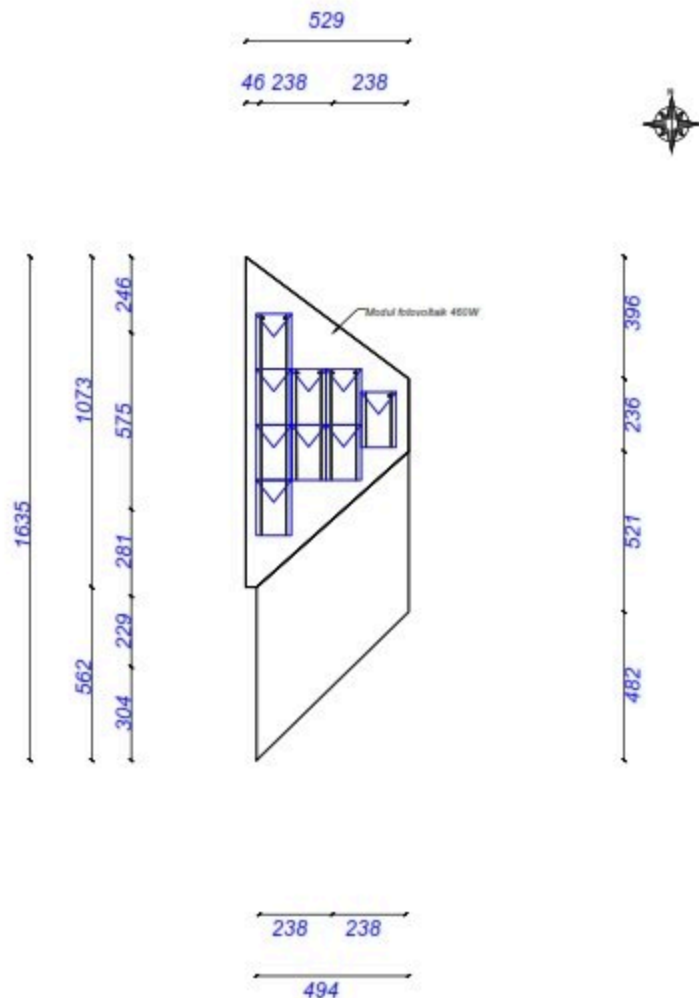

PROJEKTI / CLASH



REPUBLIKA E KOSOVES / REPUBLIC OF KOSOVO

KONSOLENT / CONSULTANT



DOKUMENTI / TECHNICAL DRAWING

PROJEKTI / PROJECT NAME

"INSTALIMI I SISTEMIT FOTOVOLTAIK"

ZONA / LOCATION

ZASHKUA MRODITE

FASJA E PROJEKTI / PROJECT PHASE

PROJEKT ZBATIM / IMPLEMENTATION OF SIGN

PROJEKTI ARCHITETONIK / ARCHITECTURAL DESIGN

Ark. Rajmonda MYDRELLARI

06.11.2022

06.11.2022

PROJEKTI INZHINIERI / STRUCTURAL DESIGN

Ing. Rashap TAPDA

06.11.2022

PROJEKTI MARRIMOR / MECHANICAL DESIGN

Ing. Arqife PEPI

06.11.2022

PROJEKTI INZHINIERI / ELECTRICAL DESIGN

Ing. Merita MEGRI

06.11.2022

PROJEKTI INZHINIERI / ELECTRICAL DESIGN

Ing. Kristaq ZHURPA

06.11.2022

EMRYTJA / TITLE / TITLE OF DESIGN

DIMENSIONET E SIPERFAQES KU DO TE VENDOSEN PANELET FOTOVOLTAIKE

SHALLA

SHKURT 2022

06.11.2022

SHALLA / SHEET NO.

A-05

VLKA / STAMP

PROJEKTI / CLASH

DIMENSIONET E SIPERFAQES KU DO TE VENDOSEN PANELET FOTOVOLTAIKE

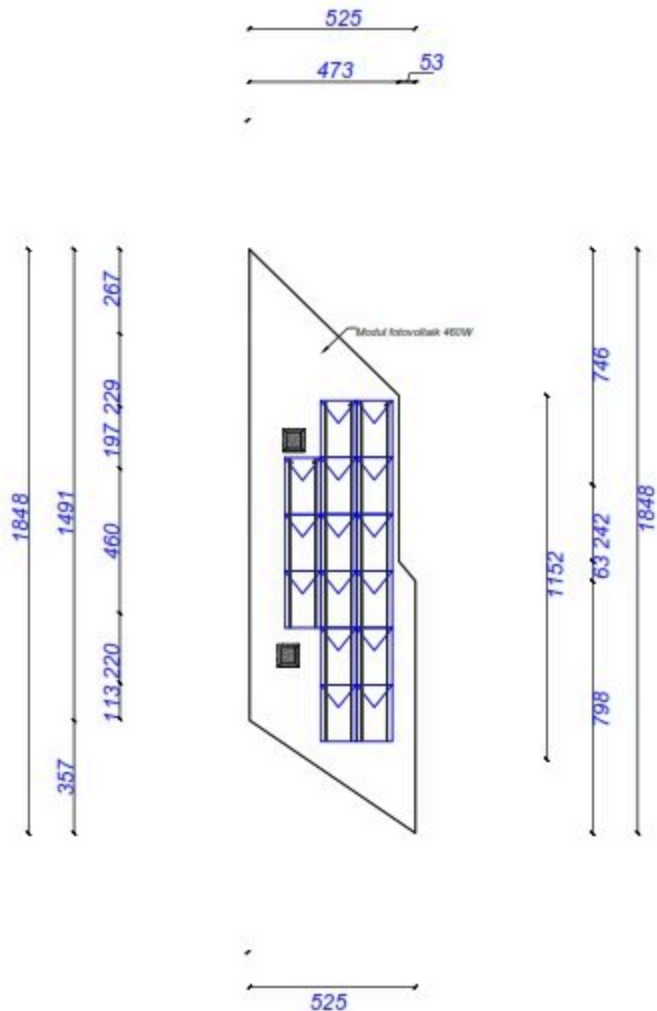

BASHKIA MIRODITE, REPUBLIKË

KONSULLANT / CONSULTANT



SHKËMBIM TËRBUJËR / TECHNICAL NOTES

PROJEKT / PROJECT NAME

"INSTALIMI I SISTEMIT FOTOVOLTAIK"

ZONA / LOCATION

BASHKIA MIRODITE

FASË E PROJEKTTË / PROJECT PHASE

PROJEKT ZBATIM / IMPLEMENTATION OF DESIGN

PROJEKTI ARKITEKTURIK / ARCHITECTURAL DESIGN

Ark. Rigjendra MYDRELLARI

06.11.2022

06.11.2022

PROJEKTI INZHINIERIK / STRUCTURAL DESIGN

Ing. Rashap TAPDA

06.11.2022

PROJEKTI SHPËRBUJËR / MEP AND COOLING

Ing. Arqipe PEPI

06.11.2022

PROJEKTI IDENTIFIKUES / MUNICIPAL DESIGN

Ing. Merita MEGRI

06.11.2022

PROJEKTI ELIKTRIK / ELECTRICAL DESIGN

Ing. Kristaq ZHURPA

06.11.2022

SHKËMBIM TËRBUJËR / TITLE OF DESIGN

DIMENSIONËT E SIPERFAQES KU DO TE VENDOSEN PANELET FOTOVOLTAIKE

SHKALLA

1:100

SHKËMBIM TËRBUJËR

06.11.2022

SHKËMBIM TËRBUJËR

A-06

VLËKË / STAMP

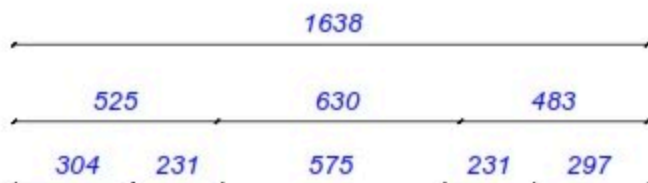

Aksesor / kqepës së ahies nën (përgjith)

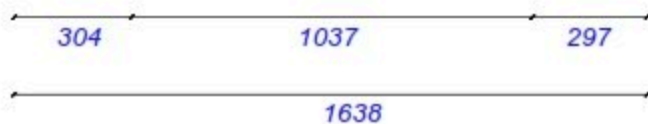
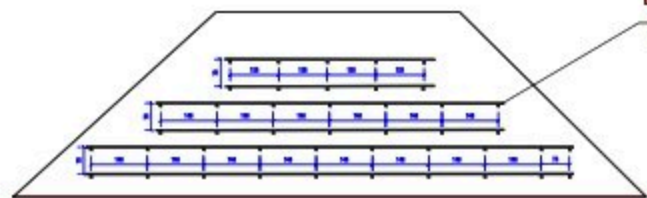
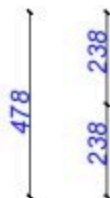

BASHKIA E MIRDITËS

KONSULLANT / CONSULTANT



SHKREMBË TËRBUJËR / TECHNICAL NOTES

PROJEKT / PROJECT NAME

"INSTALIMI I SISTEMIT FOTOVOLTAIK"

POSHTA / LOCATION

BASHKIA E MIRDITËS

FASZË / PROJECT / PROJECT NAME

PROJEKT ZBATIM / IMPLEMENTATION OF DESIGN

PROJEKTI ARCHITETUR / ARCHITECTURAL DESIGN

Ark. Rigjendra MYDRELLARI

06.11.2022

06.11.2022

PROJEKTI INZHINIERI / STRUCTURAL DESIGN

Ing. Rishap TAPDA

06.11.2022

PROJEKTI SHPËRTHYKËS / ME PROJEKTIN E SHPËRTHYKËS

Ing. Arqipe PEPI

06.11.2022

PROJEKTI INZHINIERI / PRINCIPAL DESIGN

Ing. Merita MESHU

06.11.2022

PROJEKTI INZHINIERI / ELECTRICAL DESIGN

Ing. Kristaq ZHURPA

06.11.2022

SHKREMBËT / LIST OF DESIGN

DIMENSIONET E SIPERFAQES KU DO TE VENDOSEN PANELET

PROJEKTI

06.11.2022

06.11.2022

06.11.2022

06.11.2022

06.11.2022

06.11.2022

06.11.2022

06.11.2022

06.11.2022

06.11.2022

06.11.2022

06.11.2022

06.11.2022

06.11.2022

06.11.2022

06.11.2022

06.11.2022

06.11.2022

SHKALLA

1:100

06.11.2022

06.11.2022

06.11.2022

06.11.2022

06.11.2022

06.11.2022

06.11.2022

06.11.2022

06.11.2022

06.11.2022

SHKALLA / SCALE

1:100

06.11.2022

06.11.2022

06.11.2022

06.11.2022

06.11.2022

06.11.2022

06.11.2022

06.11.2022

06.11.2022

06.11.2022

A-07

06.11.2022

06.11.2022

06.11.2022

06.11.2022

06.11.2022

06.11.2022

06.11.2022

06.11.2022



BASHKIA MIRDIË, PESHKËPISË

KONSULLANT / CONSULTANT



SHKËMBI TËRHOJE / TECHNICAL NOTES

PROJECT / PROJECT NAME

"INSTALIMI I SISTEMIT FOTOVOLTAIK"

ZONE / LOCATION

BASHKIA MIRDIË

PAGE / PROJECT / PROJECT PAGE

PROJEKT ZBATIM / IMPLEMENTATION DESIGN

PROJECT ARCHITECTURE / ARCHITECTURAL DESIGN

Ark. Rajmonda MYDRELLARI

06.04.2022

06.04.2022

PROJECT STRUCTURE / STRUCTURAL DESIGN

Ing. Rashap TAPDA

06.04.2022

PROJECT SERVICES / MEASUREMENTS

Ing. Arqipe PEPI

06.04.2022

PROJECT MECHANICAL / MECHANICAL DESIGN

Ing. Merita MEGRI

06.04.2022

PROJECT ELECTRICAL / ELECTRICAL DESIGN

Ing. Kristaq ZHURPA

06.04.2022

OWNER / CLIENT / TITLE OF DESIGN

ORGANIZIMI I QYRIMIT DHE TËRHOJES SË PANELEVE FOTOVOLTAIKE

SHKALLA

1:100

SHKURT 2022

REVIZIONE / REVISIONS

A-08

VLKA / STAMP

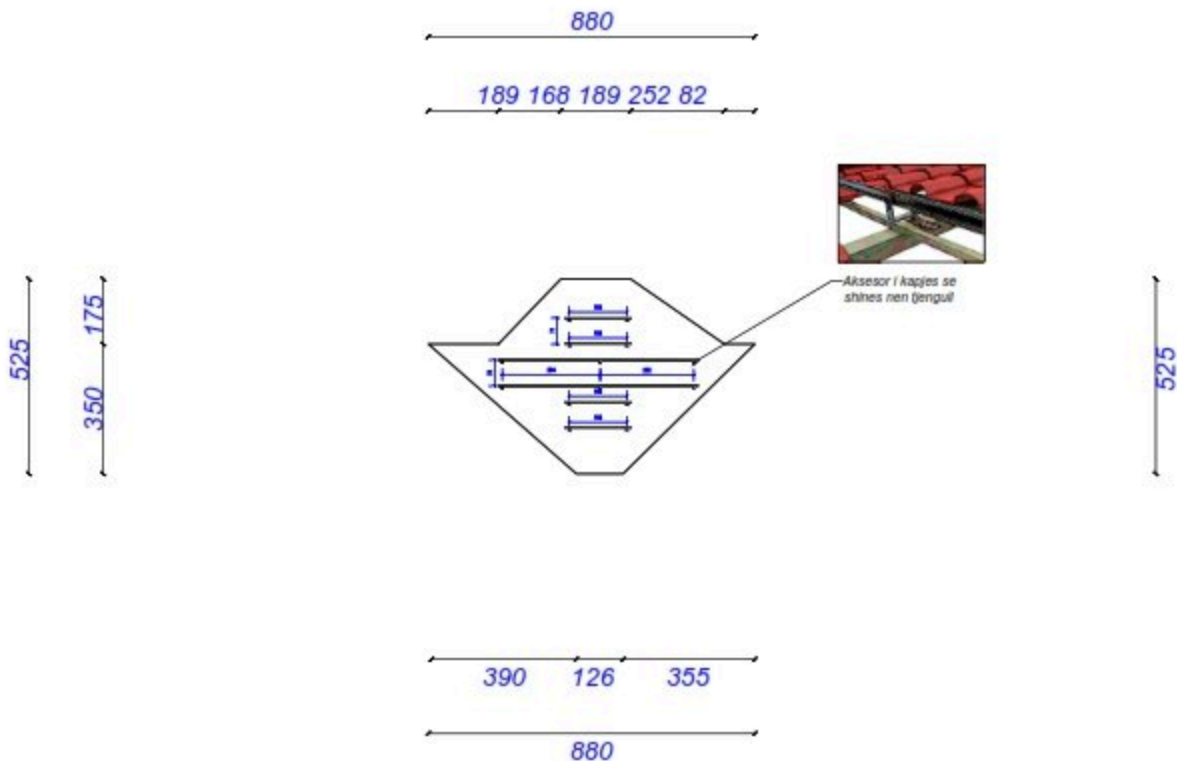

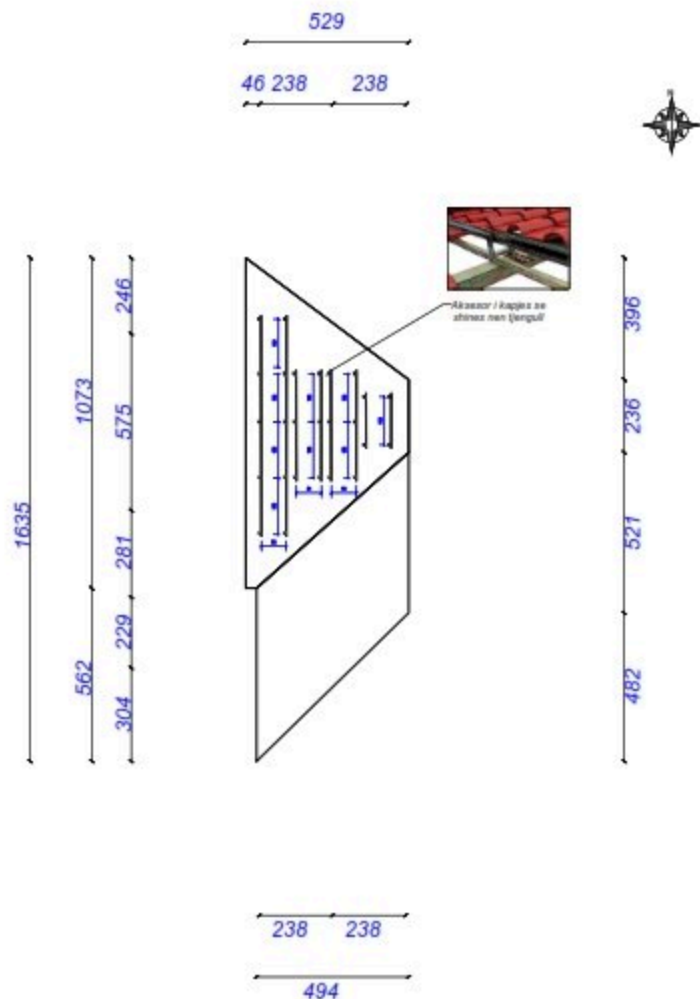

ARMENIA BREEDS, PERMITTED

CONSULTANT



DESIGN: TECHNICAL DRAWING

PROJECT: PROJECT NAME

"INSTALIMI I SISTEMIT FOTOVOLTAIK"

FORM: LOCATION

ZASHKIA MRODITE

PAGE: PROJECT / PROJECT NAME

PROJEKT ZBATIMI
IMPLEMENTATION DESIGN

PROJECT ARCHITECTURE / ARCHITECTURAL DESIGN

Ark. Ragnhilda MYDRELLARE

06.11.2023

06.11.2023

PROJECT ARCHITECTURE / STRUCTURAL DESIGN

Ing. Rishap TARDA

06.11.2023

PROJECT ARCHITECTURE / MECHANICAL DESIGN

Ing. Arpine PERE

06.11.2023

PROJECT ARCHITECTURE / ELECTRICAL DESIGN

Ing. Meris MEGH

06.11.2023

PROJECT ARCHITECTURE / ELECTRICAL DESIGN

Ing. Kristaq ZHURPA

06.11.2023

PROJECT ARCHITECTURE / TYPE OF DESIGN

CONSTRUCTION AND IMPLEMENTATION OF PHOTOVOLTAIC

SCALE

PROJECT 2023

06.11.2023

PROJECT: PROJECT NAME

A-09

SCALE / STAMP

DIMENSIONET E SIPERFAQES KU DO TE VENDOSEN PANELET FOTOVOLTAIKE

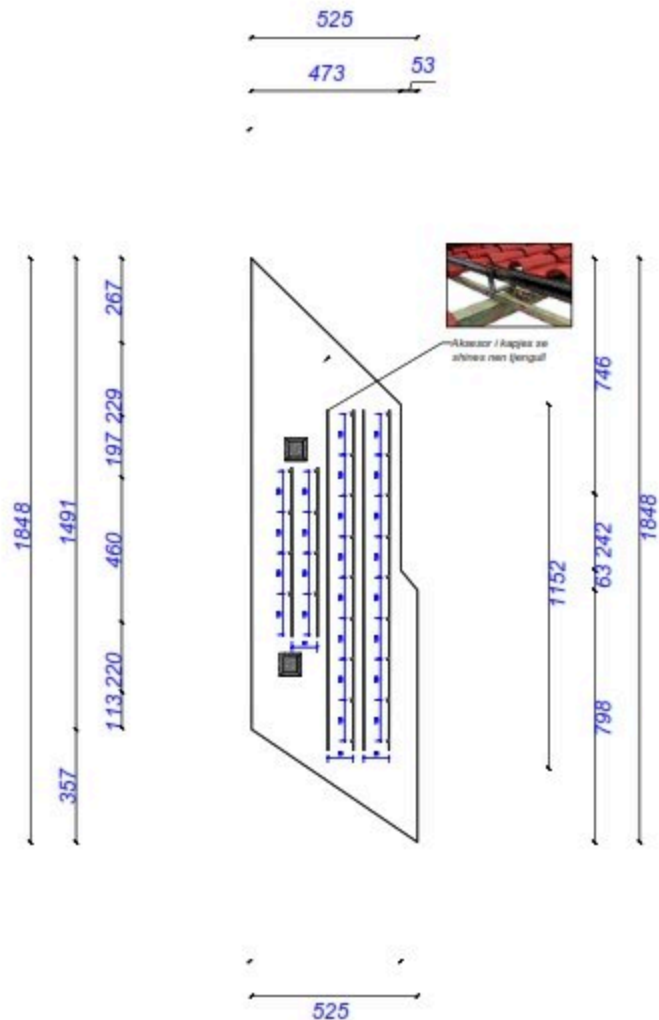

BASHKIA E PRIZRENIT

KONSULTANT / CONSULTANT



SHËRBIMET E INZHINIERISË / TECHNICAL SERVICES

PROJEKT / PROJECT NAME

"INSTALIMI I SISTEMIT FOTOVOLTAIK"

ZONA / LOCATION

BASHKIA E PRIZRENIT

FASZ / PROJECT / PROJECT NAME

PROJEKT ZBATIM / IMPLEMENTATION OF DESIGN

PROJEKTI ARKITEKTUROR / ARCHITECTURAL DESIGN

Ark. Rigonda MYDRELLARI

PROJEKTI INZHINIEROR / STRUCTURAL DESIGN

Ing. Rashap TAPDA

PROJEKTI SHËRBIMOR / ME PROJEKTIM DHE KALIM

Ing. Arqife PEPI

PROJEKTI INZHINIEROR / MUNICIPAL DESIGN

Ing. Merita MEGRI

PROJEKTI ELEKTRIKOR / ELECTRICAL DESIGN

Ing. Kiroq ZHURA

EMËRTIM I FALCIS / TITLE OF DESIGN

DIMENSIONET E SIPERFAQES KU DO TE VENDOSEN PANELET FOTOVOLTAIKE

SHKALLA / SCALE

SHKALLA 200%

SHËRBIMET E INZHINIERISË

A-10

VLKA / STAMP

KONFIGURIMI ELEKTRIK I LIDHJES DC

2787

379 350 945 106 1008

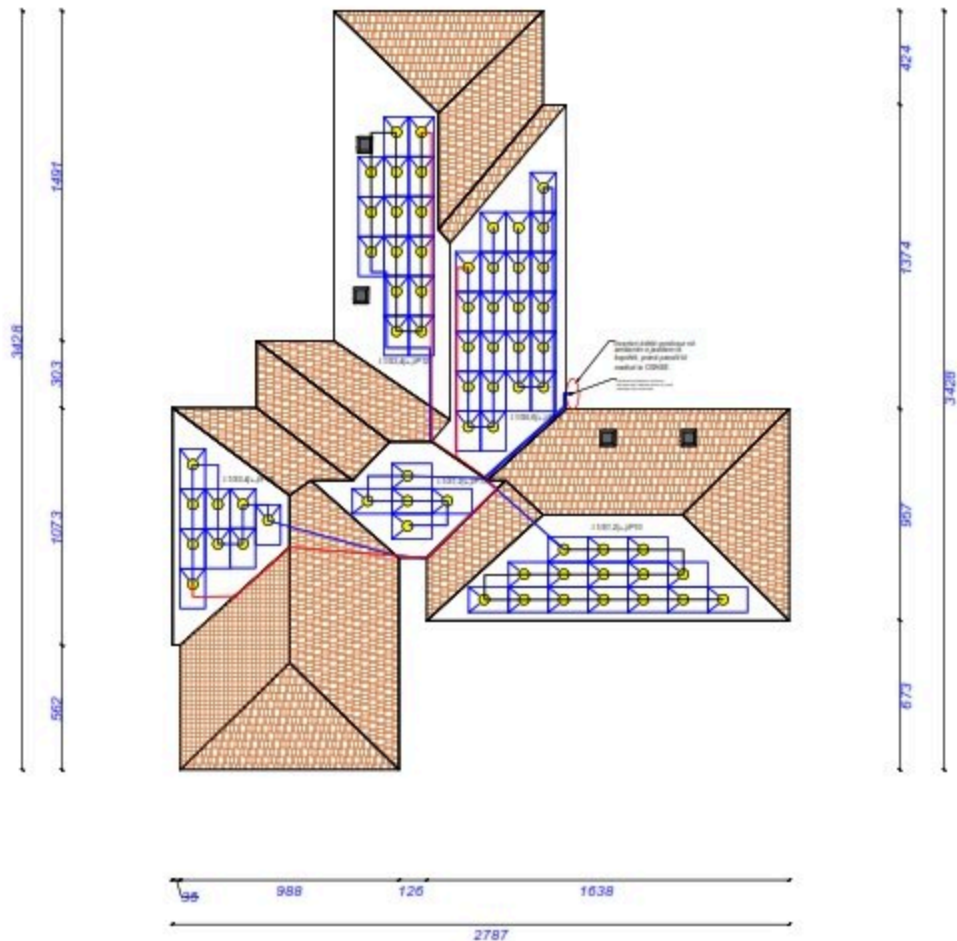

PROJEKTI: 13487



BASHKIA E MIRDITËS

KONSOLENT / CONSULTANT



SHËRBIMET TËNDRËSHORË / TECHNICAL SERVICES

PROJEKTI / PROJECT NAME

"INSTALIMI I SISTEMIT FOTOVOLTAIK"

FORMA / LOCATION

BASHKIA E MIRDITËS

FAZJA E PROJEKTI / PROJECT PHASE

PROJEKT ZBATIM / IMPLEMENTATION DESIGN

PROJEKTI ARCHITETUR / ARCHITECTURAL DESIGN

Ark. Rigonda MYDRELLARI

PROJEKTI INZHINIERI / STRUCTURAL DESIGN

Ing. Rishap TAPDA

PROJEKTI TËRHEQËS / ME PROJEKTIM

Ing. Ardit PEPI

PROJEKTI INZHINIERI / ELECTRICAL DESIGN

Ing. Merita MEGRI

PROJEKTI INZHINIERI / ELECTRICAL DESIGN

Ing. Kristaq ZHURPA

FAZJA E PROJEKTI / TYPE OF DESIGN

KONSULENCA ELEKTRIK LIDHJES DC

SHALLA

SHKURT 2025

SHËRBIMET TËNDRËSHORË

A-11

VLAK / STAMP

SKEMA E SISTEMIT TE MATJES

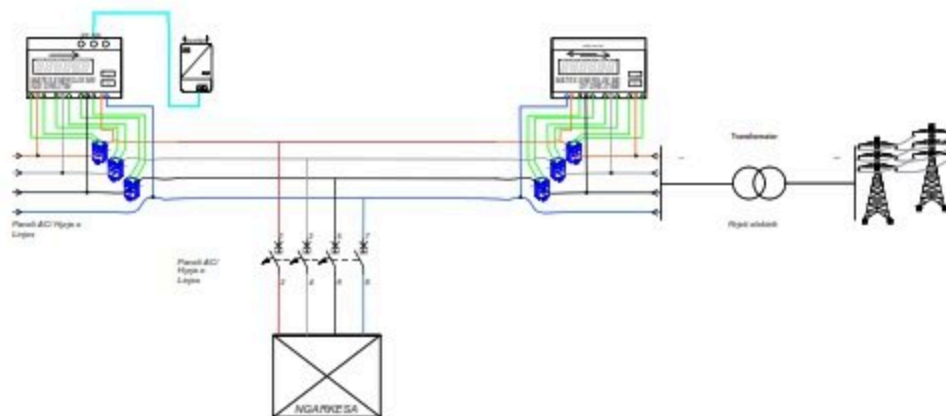

LEGJENDE	
	Invertor
	Transformator Fijte
	Shkëmbim Mbrojtës
	Paneli AC Fijte e Lajme
	Paneli AC Fijte e Lajme
	Transformator
	Rregulluesi
	Ngarkesa



BASHKIA E PRIZRINIT

KONSULENT / CONSULTANT
ZENITBCC
 16 Shkurtorë, Tjetër (Prizren), Prizren
 080 4600000
 z.bcc@zibcc.com

DOKUMENTI / DOCUMENT: TECHNICAL DRAWING

PROJEKT / PROJECT NAME

"INSTALIMI I SISTEMIT FOTOVOLTAIK"

NR. / LOCATION

BASHKIA E PRIZRINIT

PAGJA E PROJEKTIT / PROJECT PAGE

PROJEKT ZBATIM / IMPLEMENTATION DESIGN

PROJEKTI ARCHITETONIK / ARCHITECTURAL DESIGN

Ark. Rajmonda MYDRELLARI

PROJEKTI INZHINIERI / STRUCTURAL DESIGN

Ing. Rashap TAPDA

PROJEKTI MASHINORIE / MEK. PROJ. AND COOLING

Ing. Ardit PEPI

PROJEKTI INZHINIERI / MEK. PROJ. AND COOLING

Ing. Merita MEGYI

PROJEKTI ELEKTRIK / ELECTRICAL DESIGN

Ing. Kristaq ZHURPA

PROJEKTI MASHINORIE / MEK. PROJ. AND COOLING

PROJEKTI MASHINORIE / MEK. PROJ. AND COOLING

PROJEKTI MASHINORIE / MEK. PROJ. AND COOLING

PROJEKTI MASHINORIE / MEK. PROJ. AND COOLING

PROJEKTI MASHINORIE / MEK. PROJ. AND COOLING

PROJEKTI MASHINORIE / MEK. PROJ. AND COOLING

PROJEKTI MASHINORIE / MEK. PROJ. AND COOLING

PROJEKTI MASHINORIE / MEK. PROJ. AND COOLING

PROJEKTI MASHINORIE / MEK. PROJ. AND COOLING

SHKALLA / SCALE: 1:100

SHKURT 2020

SHKURT / SHORT

SHKURT 2020

SHKURT / SHORT

SHKURT 2020

SHKURT / SHORT

SHKURT 2020

SHKURT / SHORT

SHKURT 2020

A-13

SHKURT / SHORT

SHKURT 2020

SHKURT / SHORT

SHKURT 2020

SHKURT / SHORT

SHKURT 2020

PLANVENDOSJA E INVERTERIT

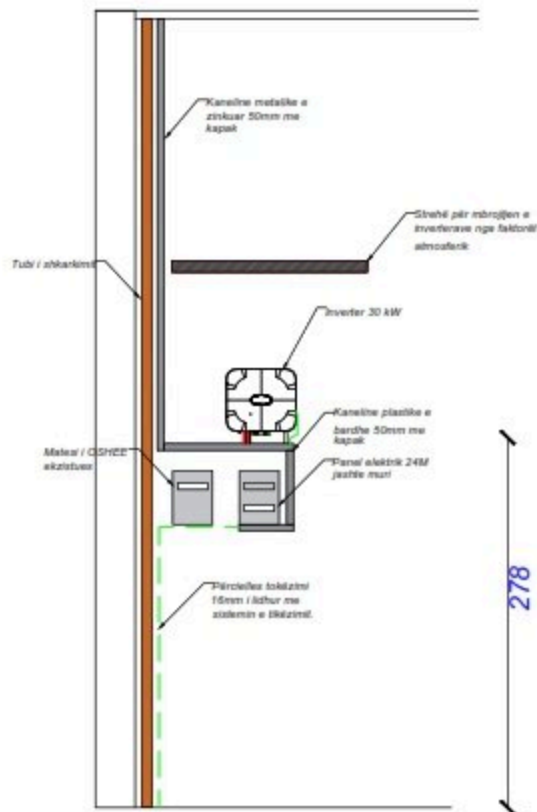

PROJEKTI: 13.04.17



BASHKIA E MIRDITËS

KONKALISTI / CONSULTANT



ZENITBEOI
Zëvendësues i punës
16 Shkurt 2016 Nr. 13 (qendra, 1000) adresa
E-Mail: zenit@zeoi.com

SHKËMBIM: TËRBUJËR / TECHNICAL NOTES

PROJEKTI / PROJECT NAME

"INSTALIMI I SISTEMIT FOTOVOLTAIK"

ZONA / LOCATION

BASHKIA E MIRDITËS

FAZJA E PROJEKTI / PROJECT PHASE

PROJEKTI ZBATIM /
IMPLEMENTATION OF SIGN

PROJEKTI ARCHITETUROR / ARCHITECTURAL DESIGN

Ark. Rajmonda MYDRELLARI

16.11.2016 Nr. 13

16.11.2016 Nr. 13

PROJEKTI INZHINIEROR / STRUCTURAL DESIGN

Ing. Rashap TAPDA

16.11.2016

PROJEKTI SHPËRBLIMOR / MEK PRO AND COOLING

Ing. Arqipe PEPI

16.11.2016

PROJEKTI INZHINIEROR / PRINCIPAL DESIGN

Ing. Merita MEGRI

16.11.2016

PROJEKTI ELEKTRIK / ELECTRICAL DESIGN

Ing. Kristaq ZHURPA

16.11.2016

SHKËMBIM: TËRBUJËR / FILE OF DESIGN

LANDSHOCKUP NUMBER

SHKALLA

1:100

SHKËMBIM: TËRBUJËR

SHKËMBIM: TËRBUJËR

SHKËMBIM: TËRBUJËR

SHKËMBIM: TËRBUJËR

SHKËMBIM: TËRBUJËR

SHKËMBIM: TËRBUJËR

A-14

VLKA / STAMP

PROJEKTI FOTOVOLTAIK

OBJEKTI: "Ndriçimi Reps"

PROGRAMI: "Projektimi i Sistemit Fotovoltaik"

MBESHTETES: IPA II Cross Border Cooperation Programme for Albania- Kosovo

PERFITUES: Bashkia Mirditë



ZENIT&CO

Tiranë 2026



BASHKIA MIRDITE

PLANIMETRI E PËRGJITHËSHME E OBJEKTIT

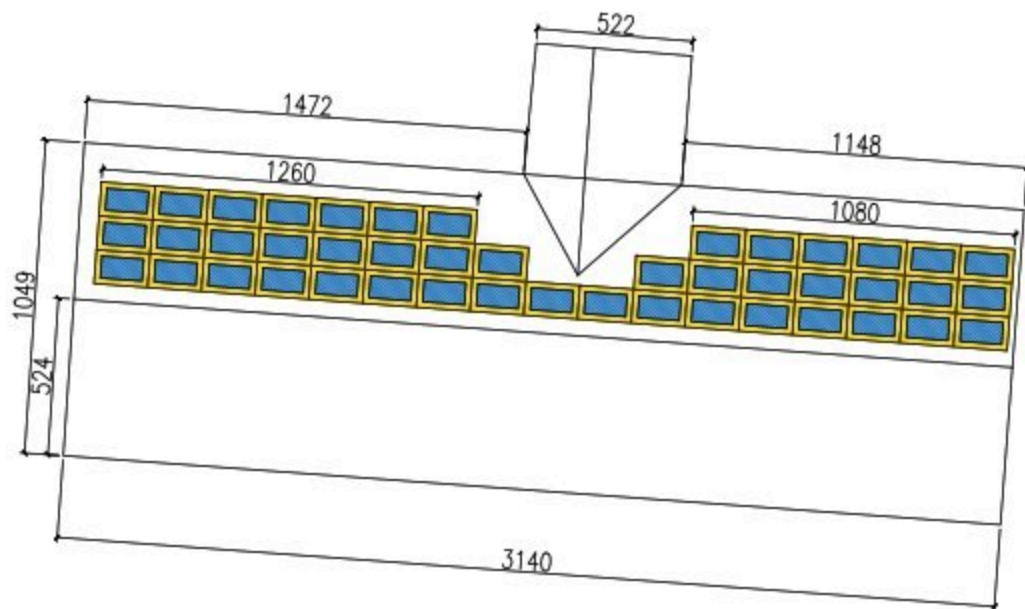

PROJEKTI: 13487



BASHKIA E PRIZRENIT

KONSULENT: KONSULANT



SHKËMBI TËROR - TECHNICAL NOTES

PROJEKT: PROJECT NAME

"INSTALIMI I SISTEMIT FOTOVOLTAIK"

ZONA: LOCATION

BASHKIA E PRIZRENIT

FASË E PROJEKTIT: PROJECT PHASE

PROJEKT ZBATIM /
IMPLEMENTATION DESIGN

PROJEKTI ARCHITETUROR - ARCHITECTURAL DESIGN

Ark. Rigonda MYDRELLARI

06.11.2022

06.11.2022

PROJEKTI INZHINIERI - STRUCTURAL DESIGN

Ing. Rashap TAPDA

06.11.2022

PROJEKTI MASHINORIE - MEK. PROJ. AND COOLING

Ing. Arqife PEPI

06.11.2022

PROJEKTI INZHINIERI - MUNICIPAL DESIGN

Ing. Merita MEGRI

06.11.2022

PROJEKTI INZHINIERI - ELECTRICAL DESIGN

Ing. Kristaq ZHURPA

06.11.2022

SHKËMBI TËROR - FIELD OF DESIGN

PLANIMETRI I OBJEKTIT

SHKALLA

1:1000

SHKËMBI TËROR

SHKËMBI TËROR

A-01

VLAKA / STAMP

PLANIMETRI E PËRGJITHËSHME E STRUKTURES

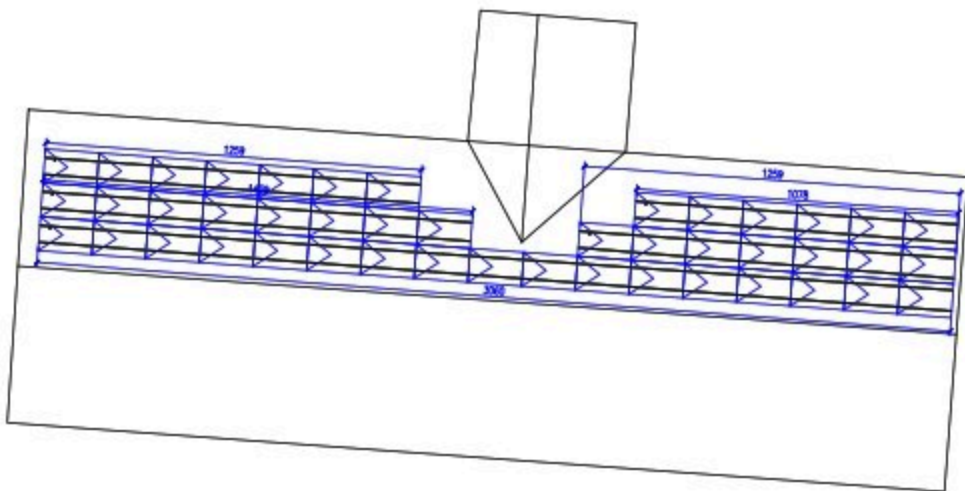

PROJEKTI: 13.007



BASHKIA E PRISHTINES

KONSULENTI / CONSULTANT



ZENITBCC

Prishtine, Tjet (Nr. 19, qyteti i vjetër)
t.045 4600000
e.045 zenitbcc.com

DOKUMENTI: TENDERO / TECHNICAL NOTES

PROJEKTI: PROJECT NAME

**"INSTALIMI I SISTEMIT
FOTOVOLTAIK"**

ZONA / LOCATION

BASHKIA E PRISHTINES

FASHA E PROJEKTI / PROJECT PHASE

**PROJEKT ZBATIMI
IMPLEMENTATION OF DESIGN**

PROJEKTI ARCHITETUROR / ARCHITECTURAL DESIGN

Ark. Rigonda MYDRELLARI

06.04.2022

045/2022-04-07/2022

PROJEKTI INZHINIERIMOR / STRUCTURAL DESIGN

Ing. Rashap TAPIDA

06.04.2022

PROJEKTI INZHINIERIMOR / MEK. PROJEKTIM I KULLIMIT

Ing. Arqipe PEJTI

06.04.2022

PROJEKTI INZHINIERIMOR / PRINCIPAL DESIGN

Ing. Merita MEGRI

06.04.2022

PROJEKTI INZHINIERIMOR / ELECTRICAL DESIGN

Ing. Kristaq ZHURPA

06.04.2022

PROJEKTI INZHINIERIMOR / FIELD OF DESIGN

PLANIMETRI I PËRGJITHËSH

SHKALLA

1:100

SHKURTY 2022

SHKURTY / ABBREVIATIONS

A-02

VLKA / STAMP

PLANIMETRI E PËRGJITHËSHME E STRINGAVE

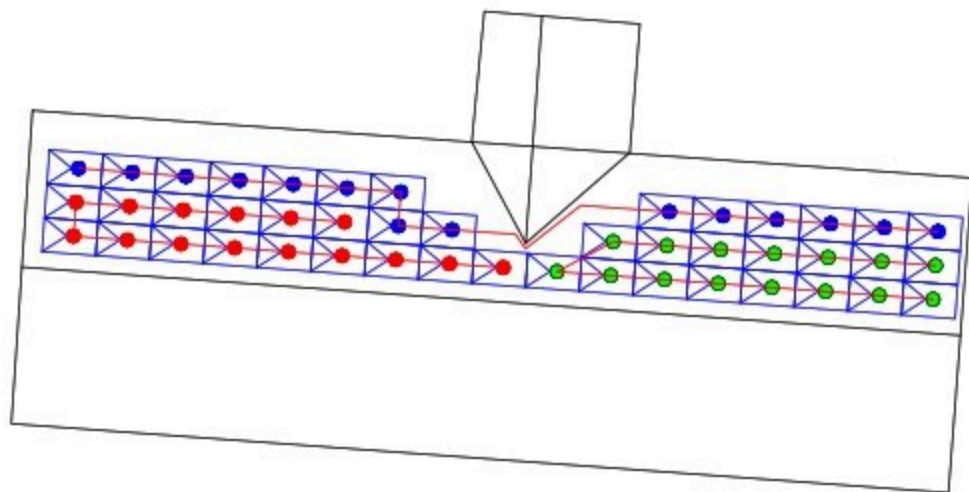

PROJEKTI - TITULLI



BASHKIA E REJTËS, PËRNYTË

KONSOLEJTI / CONSULTANT



ZENITBCC
ZEMËRIMET E BASHKËPËRITUR
PË SHËRBIMIN E QYTYRIT
P.O. Box 100, 10000 Prishtinë
T: +383 45 211 111
E: info@zenitbcc.com

SHKËMBI / SHEETS - TECHNICAL NOTES

PROJEKTI / PROJECT NAME

**"INSTALIMI I SISTEMIT
FOTOVOLTAIK"**

QYRJA / LOCATION

BASHKIA E REJTËS

FASJA E PROJEKTI / PROJECT PHASE

**PROJEKT ZBATIMI
IMPLEMENTATION DESIGN**

PROJEKTI ARCHITETUROR / ARCHITECTURAL DESIGN

Ark. Rigonda MYDRELLARI

06.11.2022
06.11.2022

PROJEKTI INZHINIERI / STRUCTURAL DESIGN

Ing. Rashap TAPDA

06.11.2022

PROJEKTI MASHINORIE / MECHANICAL DESIGN

Ing. Arqife PEVI

06.11.2022

PROJEKTI INZHINIERI / ELECTRICAL DESIGN

Ing. Merita MEGRI

06.11.2022

PROJEKTI INZHINIERI / ELECTRICAL DESIGN

Ing. Kristaq ZHURPA

06.11.2022

SHËMBI / SHEETS / TITLE OF SHEET

PLANIMETRI I PËRGJITHËSH

SHKALLA

1:1000

SHKURT 2022

SHËMBI / SHEETS / TITLE OF SHEET

A-03

VLAKA / STAMP

SKEMA ELEKTRIKE AC

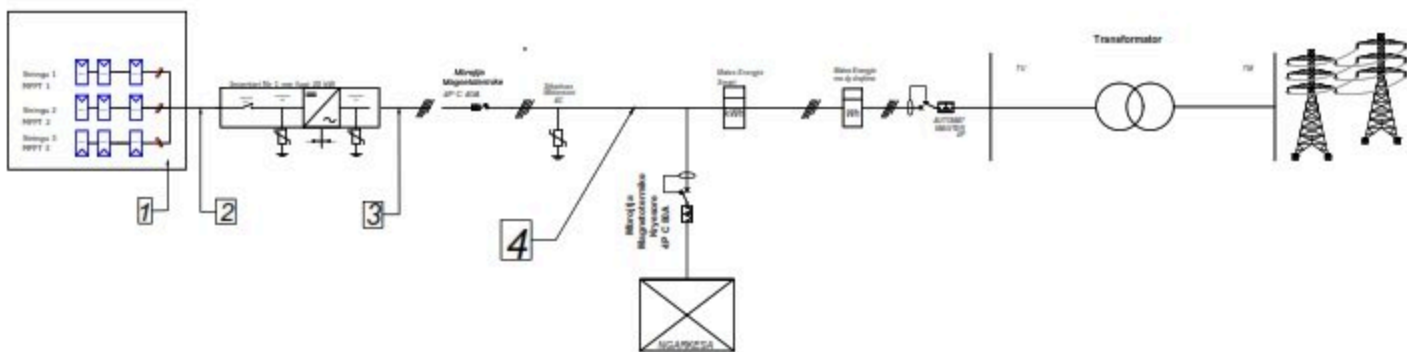

PROJEKTOVALNA ŠIFRA



BASHKIA MIRDITE, PESHKËPIS

KONJALLET / CONSULTANT



SHKURIME TËRHEQUR / TECHNICAL NOTES

PROJEKT / PROJECT NAME

"INSTALIMI I SISTEMIT FOTOVOLTAIK"

FORMA / LOCATION

BASHKIA MIRDITE

FAZA E PROJEKTTIT / PROJECT PHASE

PROJEKT ZBATIM / IMPLEMENTATION DESIGN

PROJEKTI ARCHITETUROR / ARCHITECTURAL DESIGN

Ark. Rajmonda MYDRELLARI

PROJEKTI KONSTRUKTIV / STRUCTURAL DESIGN

Ing. Rashap TAPDA

PROJEKTI MASHINORIE / MECHANICAL DESIGN

Ing. Argjir PEXH

PROJEKTI INZHINIERIMOR / ELECTRICAL DESIGN

Ing. Merita MEGHVI

PROJEKTI ELEKTRIK / ELECTRICAL DESIGN

Ing. Kristaq ZHURPA

SHKURIME TËRHEQUR / FIELD OF DESIGN

SHKURIME TËRHEQUR / FIELD OF DESIGN

SHKALLA

SHKURT 2020

SHKURIME TËRHEQUR / FIELD OF DESIGN

SHKURT 2020

SHKURIME TËRHEQUR / FIELD OF DESIGN

SHKURT 2020

SHKURIME TËRHEQUR / FIELD OF DESIGN

SHKURT 2020

SHKURIME TËRHEQUR / FIELD OF DESIGN

SHKURT 2020

A-04

SKEMA ELEKTRIKE E SISTEMIT TE MATJES

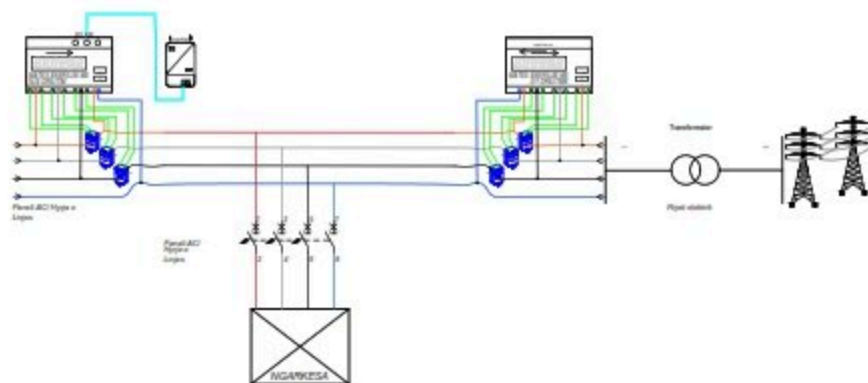

LEGJENDE	
	Inverter
	Shkëmbim Rrym
	Shkëmbim Rrym
	Paneli Fotovoltaj
	Shkëmbim Rrym
	Shkëmbim Rrym
	Shkëmbim Rrym
	Shkëmbim Rrym

FORMA 001 - 01/2017



BASHKIA E RRETHIT TË PRIZRINIT

KONSULENT / CONSULTANT



SHKËMBIM RRYM / TECHNICAL NOTICE

PROJEKT / PROJECT NAME

"INSTALIMI I SISTEMIT FOTOVOLTAIK"

FORMA / LOCATION

BASHKIA E RRETHIT TË PRIZRINIT

FAZJA E PROJEKTIT / PROJECT PHASE

PROJEKT ZBATIM / IMPLEMENTATION OF SIGN

PROJEKTI ARCHITETUROR / ARCHITECTURAL DESIGN

Ark. Rajmonda MYDRELLARI

06.11.2017

06.11.2017

PROJEKTI KONSTRUKTIV / STRUCTURAL DESIGN

Ing. Rashap TAPDA

06.11.2017

PROJEKTI MASHINORIE / MECHANICAL DESIGN

Ing. Ardit PEPI

06.11.2017

PROJEKTI HEDHMBRITJE / ELECTRICAL DESIGN

Ing. Merita MEGRI

06.11.2017

PROJEKTI ELEKTRIK / ELECTRICAL DESIGN

Ing. Kristaq ZHURPA

06.11.2017

SHKËMBIM RRYM / TECHNICAL NOTICE

FORMA / LOCATION

SHKËMBIM RRYM

PROJEKT ZBATIM

06.11.2017

SHKËMBIM RRYM

PROJEKT ZBATIM

06.11.2017

A-05

SHKËMBIM RRYM

PROJEKTI FOTOVOLTAIK

OBJEKTI: "Ndriçimi Rrugor Rrëshen"

PROGRAMI: "Projektimi i Sistemit Fotovoltaik"

MBESHTETES: IPA II Cross Border Cooperation Programme for Albania- Kosovo

PERFITUES: Bashkia Mirditë



ZENIT&CO

Tiranë 2026



BASHKIA MIRDITE

PLANIMETRI E PËRGJITHËSHME E OBJEKTIT

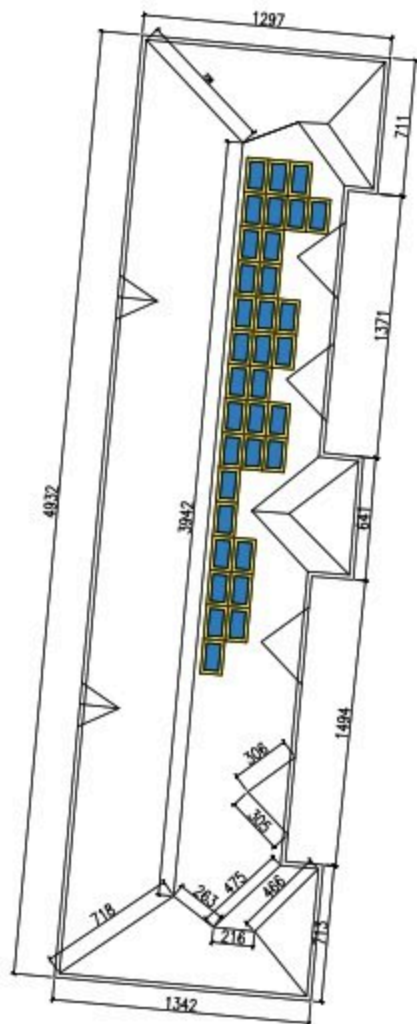

PROJEKTI: 13.007



BASHKIA E PRIZRINIT

KONSAJLLET / CONSULTANT



SHKËMBI TËROR / TECHNICAL NOTES

PROJEKTI / PROJECT NAME

"INSTALIMI I SISTEMIT
FOTOVOLTAIK"

ZONA / LOCATION

BASHKIA E PRIZRINIT

FASË E PROJEKTI / PROJECT PHASE

PROJEKTI ZBATIM
IMPLEMENTATION OF SIGN

PROJEKTI ARCHITETUROR / ARCHITECTURAL DESIGN

Ark. Rajmonda MYDRELLARI

06.11.2023

06.11.2023

PROJEKTI INZHINIERI / STRUCTURAL DESIGN

Ing. Rishap TAPDA

06.11.2023

PROJEKTI MASHINORIE / MECHANICAL DESIGN

Ing. Arqipe PEPI

06.11.2023

PROJEKTI INZHINIERI / PRINCIPAL DESIGN

Ing. Merita MESHU

06.11.2023

PROJEKTI ELEKTRIK / ELECTRICAL DESIGN

Ing. Kristaq ZHURPA

06.11.2023

PROJEKTI / TITLE OF DESIGN

PLANIMETRI I OBJEKTIT

SHKALLA

1:100

SHKURT 2023

SHKËMBI TËROR / TECHNICAL NOTES

A-01

VLKA / STAMP

PLANIMETRI E PËRGJITHËSHME E STRUKTURES

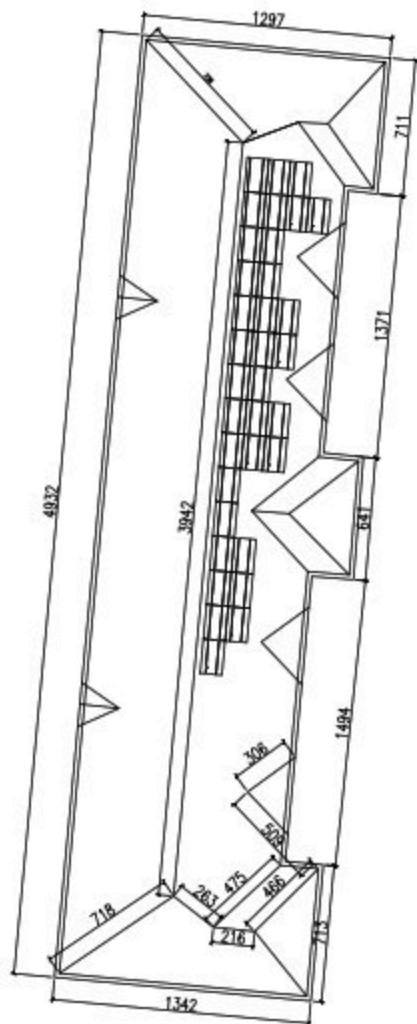

PROJEKTI: 13.007



BASHKIA MBRODITE, PRISHTINE

KONSAJLLET / CONSULTANT



ZENIT/CC
Zemë e Re

Pastrimit Top (Rr. 19 Aprilit, 1000) Prishtine
t.045 4611000
e.045 zenit@ze.com

SHKURIME / TECHNICAL NOTES

PROJEKTI / PROJECT NAME

"INSTALIMI I SISTEMIT FOTOVOLTAIK"

ZONA / LOCATION

BASHKIA MBRODITE

FASHA E PROJEKTI / PROJECT PHASE

PROJEKT ZBATIM /
IMPLEMENTATION OF DESIGN

PROJEKTI ARCHITETUROR / ARCHITECTURAL DESIGN

Ark. Rajmonda MYDRELLARI

Rr. D. D. R. 102

Prishtine MBRODITE, Q. 1000

PROJEKTI INZHINIERI / STRUCTURAL DESIGN

Ing. Rashap TAPDA

Rr. D. D. R. 102

Prishtine MBRODITE, Q. 1000

PROJEKTI MASHINORIE / MEK. PROJ. AND COOLING

Ing. Arqife PEJTI

Rr. D. D. R. 102

Prishtine MBRODITE, Q. 1000

PROJEKTI INZHINIERI / MEK. PROJ. AND COOLING

Ing. Merita MEGRI

Rr. D. D. R. 102

Prishtine MBRODITE, Q. 1000

PROJEKTI ELEKTRIK / ELECTRICAL DESIGN

Ing. Kristaq ZHURPA

Rr. D. D. R. 102

Prishtine MBRODITE, Q. 1000

PROJEKTI INZHINIERI / MEK. PROJ. AND COOLING

Ing. Arqife PEJTI

Rr. D. D. R. 102

Prishtine MBRODITE, Q. 1000

SHKALLA

1:100

SHKURTY 2006

SHKURTY / CONSULTANT

A-01

VLLE / STAMP

PLANIMETRI E PËRGJITHËSHME E MODULEVE

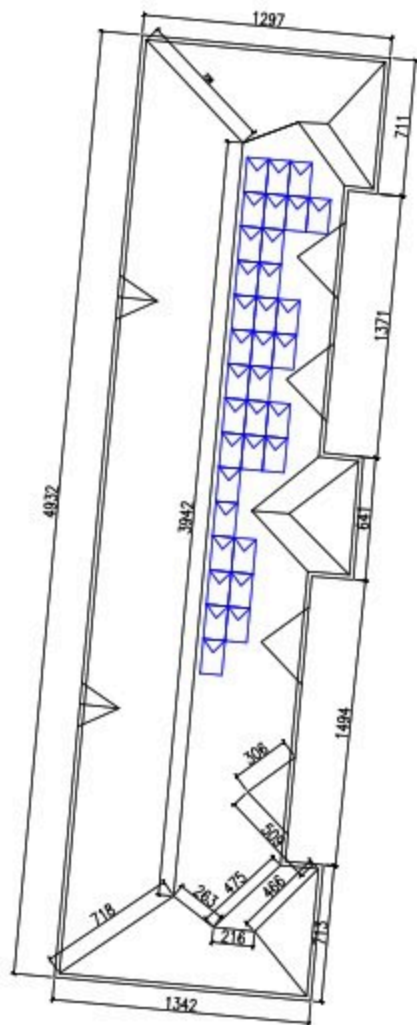

PROJEKTI: 13-007



BASHKIA E RRETHIT TË POGRADE

KONSAJLIERI / CONSULTANT



SHKURIME TËRHEQUR / TECHNICAL NOTES

PROJEKTI / PROJECT NAME

"INSTALIMI I SISTEMIT FOTOVOLTAIK"

ZONA / LOCATION

BASHKIA E RRETHIT TË POGRADE

FASHA E PROJEKTI / PROJECT PHASE

PROJEKTI ZBATIM / IMPLEMENTATION OF DESIGN

PROJEKTI ARCHITETUROR / ARCHITECTURAL DESIGN

Ark. Rigonda MYDRELLARI

06.11.2012

06.11.2012

PROJEKTI INZHINIERI / STRUCTURAL DESIGN

Ing. Rishap TAPDA

06.11.2012

PROJEKTI INZHINIERI / MECHANICAL DESIGN

Ing. Arqif PEPI

06.11.2012

PROJEKTI INZHINIERI / ELECTRICAL DESIGN

Ing. Merita MEGRI

06.11.2012

PROJEKTI INZHINIERI / ELECTRICAL DESIGN

Ing. Kristaq ZHURPA

06.11.2012

PROJEKTI INZHINIERI / FIELD OF DESIGN

PLANIMETRI I PËRGJITHËSH

SHKALLA

1:100

SHKURTY 2008

SHKURTY / CONSULTANT

A-03

VLKA / STAMP

PLANIMETRI E PËRGJITHËSHME E STRINGAVE

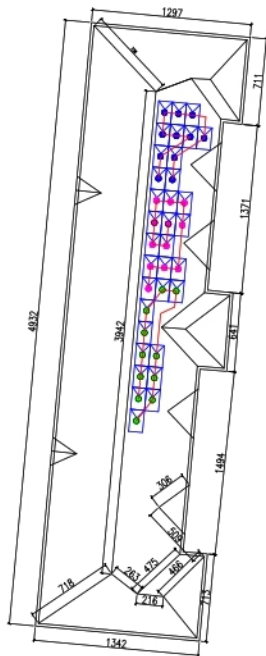

MINISTRI I ENJGJIERIS

ARCHITECT / CONSULTANT



ZENTECO
ARCHITECTURE & ENGINEERING
No. 10, Bulevardi 2005
T. 06 4444444

OWNER / FINANCER / TECHNICAL NOTES

PROJECT / PROJECT NAME

"INSTALIMI I SISTEMIT
FOTOVOLTAIK"

ZONE / LOCATION

BASHKIA MIRETIT

PHASE OF PROJECT / PROJECT PHASE

PROJEKT ZBATIM
IMPLEMENTATION DESIGN

PROJECT ARCHITECTURE / ARCHITECTURAL DESIGN

Ing. Rigbert MËYDËLLARI
No. 14, 0712
Bashkia Miretiti

PROJECT ARCHITECTURE / STRUCTURAL DESIGN

Ing. Nexhap TARDA
No. 4, 1004

PROJECT MECHANICAL / HEATING AND COOLING

Ing. Ardit PEPI
No. 10, 1011

PROJECT MECHANICAL / MUNICIPAL DESIGN

Ing. Merita MEGRI
No. 14, 1011

PROJECT ELECTRICAL / ELECTRICAL DESIGN

Ing. Kristaq ZHURIA
No. 4, 1004

SYSTEM CREATED / TITLE OF DESIGN

PLAN / PERLATAJE SHI / GATIM

SCALE / DRAWING

SCALE / DRAWING

SCALE / DRAWING

SCALE / DRAWING

SCALE / DRAWING

SCALE / DRAWING

A-04

SKEMA ELEKTRIKE AC

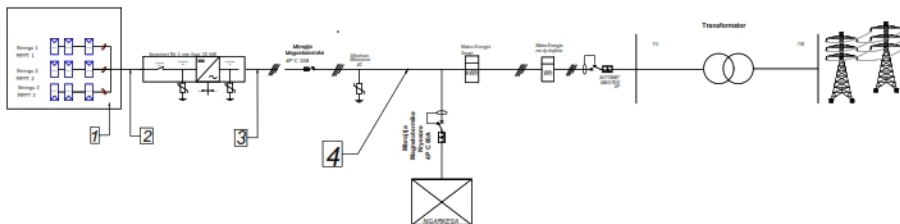

FAKULTET INŽENJERINGA
UNIVERSITET U NOVI SADI

ARHITEKTURA I KONSTRUKCIJA
"ZENTRICO"
PROJEKTOVANJE I KONSTRUKCIJA
BEOGRAD, BULEVAR VOJVODE VUKOBRADINOVIĆA 111
TEL: +381 11 252 12 34
WWW.ZENTRICO.BG

POSREDOVANJE U PROMETU NEKRETNIM PRAVIMA
POSREDOVANJE U PROMETU NEKRETNIM PRAVIMA
POSREDOVANJE U PROMETU NEKRETNIM PRAVIMA
POSREDOVANJE U PROMETU NEKRETNIM PRAVIMA

PROJEKT / PROJECT NAME
"INSTALACIJA I SISTEM FOTOVOLTAIK"

ADRESA / LOCATION
BASKIJA BRDITZE

FAZA I PROJEKTA / PROJECT PHASE
PROJEKT ZAŠTITNE
IMPLEMENTATION DESIGN

PROJEKTOVANJE I KONSTRUKCIJA
ARHITEKTURA I KONSTRUKCIJA
ARHITEKTURA I KONSTRUKCIJA
ARHITEKTURA I KONSTRUKCIJA

PROJEKTOVANJE I KONSTRUKCIJA
Ing. Nebojša TARDJA
BEOGRAD, 2024

PROJEKTOVANJE I KONSTRUKCIJA
Ing. Anđelko PERIĆ
BEOGRAD, 2024

PROJEKTOVANJE I KONSTRUKCIJA
Ing. Marko MEGRO
BEOGRAD, 2024

PROJEKTOVANJE I KONSTRUKCIJA
Ing. Kristina ŽELJKA
BEOGRAD, 2024

PROJEKTOVANJE I KONSTRUKCIJA
BASKIJA BRDITZE, TITLE OF DESIGN
BASKIJA BRDITZE, AC

PROJEKTOVANJE I KONSTRUKCIJA
PROJEKT 2024
A-05

PROJEKTOVANJE I KONSTRUKCIJA
BASKIJA BRDITZE

PROJEKTI FOTOVOLTAIK

OBJEKTI: "Njësia Administrative Rubik"

PROGRAMI: "Projektimi i Sistemit Fotovoltaik"

MBESHTETES: IPA II Cross Border Cooperation Programme for Albania- Kosovo

PERFITUES: Bashkia Mirditë



ZENIT&CO

Tiranë 2026



BASHKIA MIRDITE

PLANIMETRI E PËRGJITHËSHME E OBJEKTIT

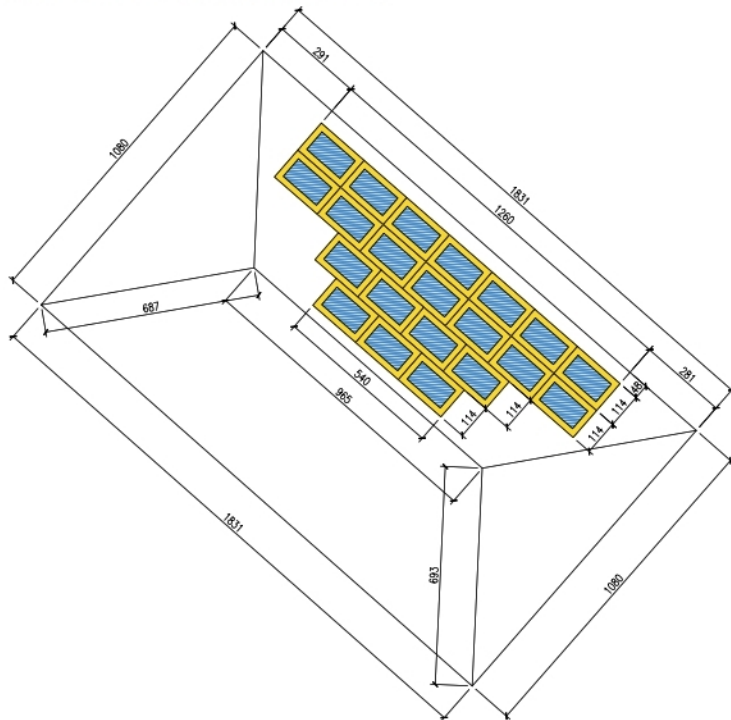

SHKURTYRË - CLASIF



SHKURTYRË - PËRSHKË

ARCHITECT / CONSULTANT



ZENTACO
ARCHITECTURE

10 Shënollari, Nr. 10, Ap. Nr. 1005
T. 069 448392
E-Mail: zentaco@zentaco.com

SHKURTYRË - TECHNICAL NOTES

PROJECT / PROJECT NAME

"INSTALIMI I SISTEMIT
FOTOVOLTAIK"

ZONE / LOCATION

BASHKËIA APODITË

PHASE OF PROJECT / PROJECT PHASE

PROJECT ZONING
IMPLEMENTATION DESIGN

PROJECT ARCHITECTURE / ARCHITECTURAL DESIGN

Ing. Rigberti MYDINDILLARI
SHALLA 07/02
SHALLA 07/02/2024

PROJECT ARCHITECTURE / STRUCTURAL DESIGN

Ing. Flakëp TARDA
SHALLA 07/02

PROJECT ARCHITECTURE / HEATING AND COOLING

Ing. Argjil PEPI
SHALLA 07/02

PROJECT ARCHITECTURE / MUNICIPAL DESIGN

Ing. Merita BERGRI
SHALLA 07/02

PROJECT ARCHITECTURE / ELECTRICAL DESIGN

Ing. Kristaq ZHURBA
SHALLA 07/02

PROJECT TITLE / TITLE OF DESIGN

PLAN / PERLINDJE SHALLA

SHALLA 07/02

SHALLA 07/02

SHALLA 07/02

SHALLA 07/02

SHALLA 07/02

SHALLA 07/02

A-01

SHALLA 07/02

SHALLA 07/02

SHALLA 07/02

SHALLA 07/02

SHALLA 07/02

SHALLA 07/02

SHALLA 07/02

SHALLA 07/02

SHALLA 07/02

PLANIMETRI E PËRGJITHËSHME E MODULEVE

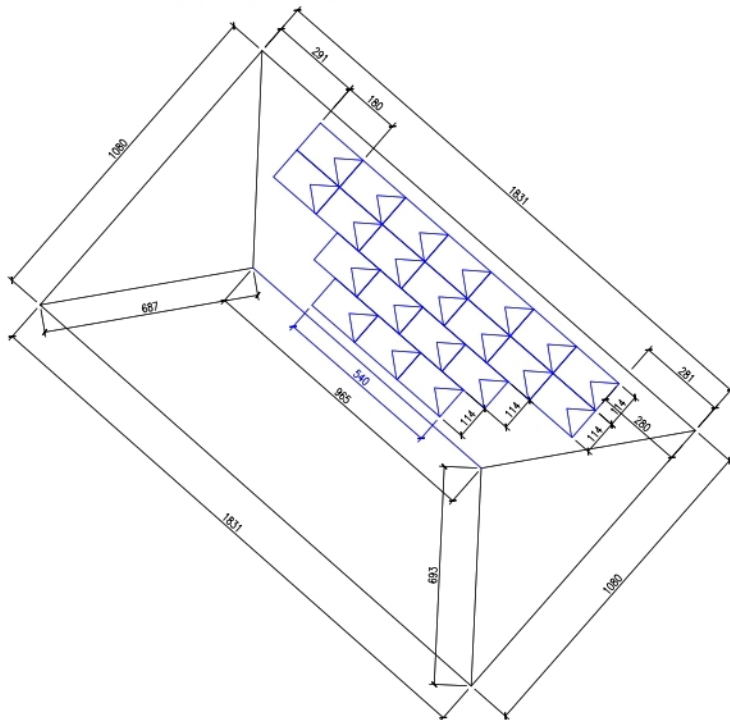

BASHKIA E PRIZRINIT

ARCHITECT CONSULTANT



BASHKIA E PRIZRINIT - TECHNICAL NOTES

PROJECT / PROJECT NAME

"INSTALIMI I SISTEMIT FOTOVOLTAIK"

ZONE / LOCATION

BASHKIA E PRIZRINIT

PHASE OF PROJECT / PROJECT PHASE

PROJECT DESIGN IMPLEMENTATION DESIGN

PROJECT ARCHITECTURE / ARCHITECTURAL DESIGN

Ing. Rigelinda MYDINLLARI
BULEVARI D. DUKAKI 101
PRIZREN 38000 KOSOVO

PROJECT STRUCTURE / STRUCTURAL DESIGN

Ing. Nexhap TARDA
BULEVARI D. DUKAKI 101
PRIZREN 38000 KOSOVO

PROJECT MECHANICAL / HEATING AND COOLING

Ing. Argjesh PERI
BULEVARI D. DUKAKI 101
PRIZREN 38000 KOSOVO

PROJECT MECHANICAL / MUNICIPAL DESIGN

Ing. Merita BERGRI
BULEVARI D. DUKAKI 101
PRIZREN 38000 KOSOVO

PROJECT ELECTRICAL / ELECTRICAL DESIGN

Ing. Kristaq ZHURIA
BULEVARI D. DUKAKI 101
PRIZREN 38000 KOSOVO

SYSTEM TITLE / TITLE OF DESIGN

PLANI PËRGJITHËSHME E MODULIT

SCALE / DRAWING

DATE / YEAR

PROJECT 2025

SCALE / DRAWING

PROJECT 2025

A-02

SCALE / DRAWING

PLANIMETRI E PËRGJITHËSHME E STRUKTURËS

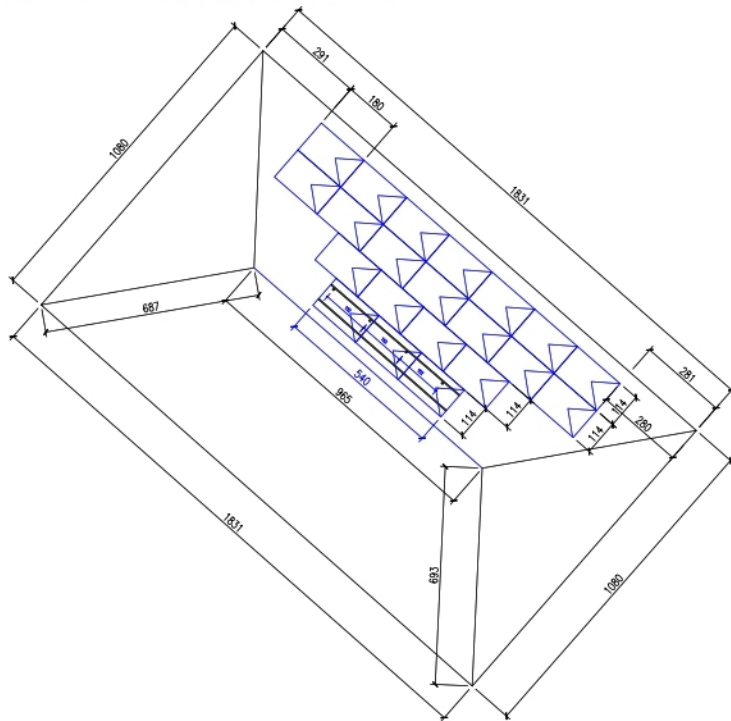

BASHKIA E PRISHTINES

ARCHITECT / CONSULTANT
ZENTBEO
 ARCHITECTURE
 Prishtine, Str. 28. Nëntori 2005
 T: 045 4400000

DATE / ISSUE: TECHNICAL NOTES

PROJECT / PROJECT NAME
"INSTALIMI I SISTEMIT FOTOVOLTAIK"

ZONE / LOCATION
BASHKIA E PRISHTINES

PHASE OF PROJECT / PROJECT PHASE
 PROJECT DESIGN /
 IMPLEMENTATION DESIGN

PROJECT ARCHITECT / ARCHITECTURAL DESIGN
 Ing. Rigelinda MYDRI
 045 4400000

PROJECT STRUCTURE / STRUCTURAL DESIGN
 Ing. Nexhëp TARDI
 045 4400000

PROJECT HEAT / HEATING AND COOLING
 Ing. Argjël PERI
 045 4400000

PROJECT MECHANICAL / MECHANICAL DESIGN
 Ing. Merita BERGRI
 045 4400000

PROJECT ELECTRICAL / ELECTRICAL DESIGN
 Ing. Kristaq ZHURIA
 045 4400000

SYSTEM TITLE / TITLE OF DESIGN
 PHOTOVOLTAIC SYSTEM

SCALE / DRAWING
 SHEET NO. **A-03**

SKEMA E SISTEMIT TE MATJES

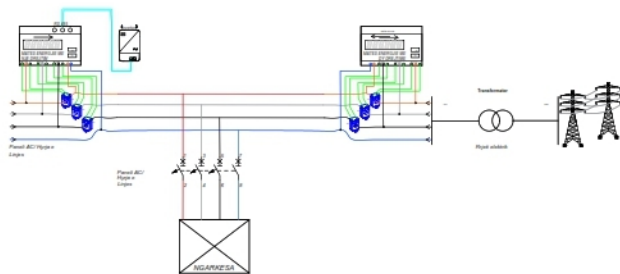

LEGJENDE	
	Hapje
	Transformator Hapje
	Relajon Mbrojtës
	AC/1 Hapje + Lajpa
	Pajis Shtetë
	Transformator
	Pajis AC/1 Hapje + Lajpa
	Ngarresa



MINISTRI I ENJERISË DHE INFRASTRUKTURËS

AGJENCIA E CONSULTIMIT

ZENTRICO
AGJENCIA E CONSULTIMIT
P.O. Box 100, 11000 Shkollëz, Tiranë
T: 06 4444444

NUMERI I DOKUMENTIT / TECHNICAL NOTES

PROJEKTI / PROJECT NAME

"INSTALIMI I SISTEMIT FOTOVOLTAIK"

STADI / LOCATION

BASHKIA MIRDITË

FAZA E PROJEKTI / PROJECT PHASE

PROJEKTI ZBATIM
IMPLEMENTATION DESIGN

PROJEKTI ARCHITETONIK / ARCHITECTURAL DESIGN

Ing. Rishonda MYDALLARU
06.04.2022
06.04.2022

PROJEKTI INZHINIERI / STRUCTURAL DESIGN

Ing. Nexhap TARSA
06.04.2022

PROJEKTI INZHINIERI / HEATING AND COOLING

Ing. Ardit PEPI
06.04.2022

PROJEKTI INZHINIERI / MUNICIPAL DESIGN

Ing. Merita MEGRI
06.04.2022

PROJEKTI ELIMTRIK / ELECTRICAL DESIGN

Ing. Kristaq ZHURBA
06.04.2022

NUMERI I DOKUMENTIT / TITLE OF DESIGN

DOKUMENTI 02/2022

SHALLA / SHEET

SHALLA / SHEET

SHALLA / SHEET

A-06

NUMERI I DOKUMENTIT / TITLE OF DESIGN

PROJEKTI FOTOVOLTAIK

OBJEKTI: "Shkolla 9-Vjeçare Nënë Tereza"

PROGRAMI: "Projektimi i Sistemit Fotovoltaik 29.9 kWp"

MBESHTETES: IPA II Cross Border Cooperation Programme for Albania- Kosovo

PERFITUES: Bashkia Mirditë



ZENIT&CO

Tiranë 2026



BASHKIA MIRDITE

DIMENSIONET E SIPERFAQES KU DO TE VENDOSEN PANELET FOTOVOLTAIKE

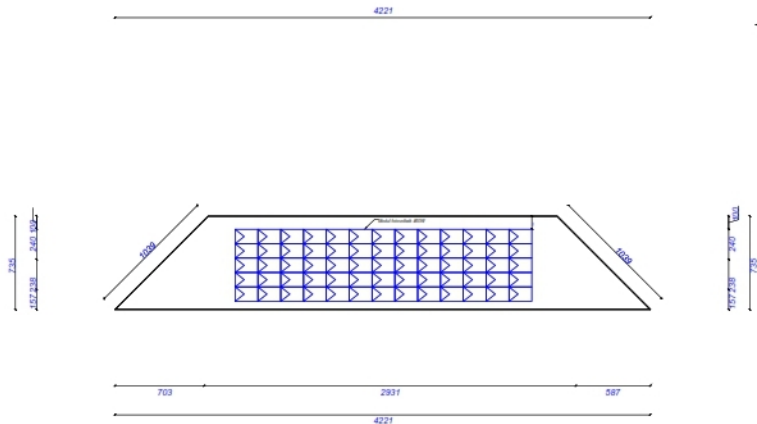

BASHKIA E MIRDITËSË

ARCHITECT / CONSULTANT
ZENTBEO
 ARCHITECTURE
 16 Shkurtorë, Nr. 10, Kap. Lezhë 1005
 T. 068 444333
 E. info@zentbeo.com

DATE: 15.03.2024
 SHEMËRI I SHËMBËRISË: 1:1000
 TITULLI I SHËMBËRISË: 1:1000

PROJEKTI / PROJECT NAME
"INSTALIMI I SISTEMIT FOTOVOLTAIK"

ZONE / LOCATION
BASHKIA E MIRDITËSË

FAZA E PROJEKTI / PROJECT PHASE
**PROJEKTI ZBATIM
 IMPLEMENTATION DESIGN**

PROJEKTI ARCHITETORIAL / ARCHITECTURAL DESIGN
 Ing. Rimgjergji MYDINLLARI
 Nr. 114-07/12
 Shkurtorë 2024

PROJEKTI INZHINIERIMOR / STRUCTURAL DESIGN
 Ing. Nexhat TARDA
 Shkurtorë 2024

PROJEKTI INZHINIERIMOR / HEATING AND COOLING
 Ing. Ardit PERI
 Shkurtorë 2024

PROJEKTI INZHINIERIMOR / MUNICIPAL DESIGN
 Ing. Merita MEGRI
 Shkurtorë 2024

PROJEKTI ELIMOR / ELECTRICAL DESIGN
 Ing. Kristaq ZHURIA
 Shkurtorë 2024

SHËMBËRITJA E SHËMBËRISË / TITLE OF DESIGN
 DIMENSIONET E SIPERFAQES KU DO TE VENDOSEN PANELET FOTOVOLTAIKE

SHALLA / SCALE: 1:1000
 SHKURT 2024

SHALLA / SCALE: 1:1000
A-02

SHALLA / SCALE: 1:1000

DIMENSIONET E SIPERFAQES KU DO TE VENDOSEN PANELET FOTOVOLTAIKE



BASHKIA E MIRDITËS, PESHKËP

ARCHITECT / CONSULTANT



DESIGNER / DESIGNER - TECHNICAL NOTES

PROJECT / PROJECT NAME

"INSTALIMI I SISTEMIT FOTOVOLTAIK"

ZONE / LOCATION

BASHKIA E MIRDITËS

PHASE OF PROJECT / PROJECT PHASE

PROJECT ZBATIM
IMPLEMENTATION DESIGN

PROJECT ARCHITECTURE / ARCHITECTURAL DESIGN

Ing. Rigelinda MYDALLARU
BULEVARI D'ALBA
SHKALLA 10000

PROJECT STRUCTURE / STRUCTURAL DESIGN

Ing. Nexhat TARSA
SHKALLA 10000

PROJECT MECHANICAL / HEATING AND COOLING

Ing. Argjesh PERI
SHKALLA 10000

PROJECT MECHANICAL / MECHANICAL DESIGN

Ing. Merita BERGRI
SHKALLA 10000

PROJECT ELECTRICAL / ELECTRICAL DESIGN

Ing. Kristaq ZHURBA
SHKALLA 10000

DESIGNER / DESIGNER - TITLE OF DESIGN

COMMISSIONER'S & APPROVED AS TO THE VENDOR'S RESULT

DATE / DATE

08/07/2025

SCALE / SCALE

A-03

SCALE / SCALE

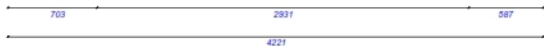
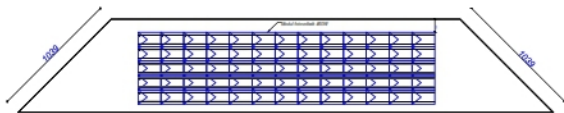

DIMENSIONET E SIPERFAQES KU DO TE VENDOSEN PANELET FOTOVOLTAIKE



BASHKIA MPDITË, PESHKËPISIA

ARCHITECT / CONSULTANT
ZENTRICO
 ARCHITECTURE
 Peshkëpisi, Nr. 16, Kap. 1006 1005
 T: 049 4474340
 E: info@zentrico.com

DATE: 06/06/2025
 SHEMËRJE: 01/01/2025
 PROJECT: 01/01/2025

PROJECT / PROJECT NAME
"INSTALIMI I SISTEMIT FOTOVOLTAIK"

ZONE / LOCATION
BASHKIA MPDITË

PHASE / PROJECT PHASE
 PROJECT ZONING
 IMPLEMENTATION DESIGN

PROJECT ARCHITECTURE / ARCHITECTURAL DESIGN
 Ing. Rigberta MYDALLARI
 Nr. 16, Kap. 1006 1005
 Peshkëpisi, Shqipëri

PROJECT ARCHITECTURE / STRUCTURAL DESIGN
 Ing. Nexhat TARSA
 Nr. 16, Kap. 1006 1005

PROJECT ARCHITECTURE / HEATING AND COOLING
 Ing. Ardit PERI
 Nr. 16, Kap. 1006 1005

PROJECT ARCHITECTURE / MUNICIPAL DESIGN
 Ing. Merita BERGRI
 Nr. 16, Kap. 1006 1005

PROJECT ELECTRICAL / ELECTRICAL DESIGN
 Ing. Kristaq ZHURIA
 Nr. 16, Kap. 1006 1005

PROJECT OWNER / TITLE OF DESIGN
 COMMISSIONER'S & APPROVED AS TO BE VENDOR'S PROJECT

SCALE / DRAWING
 SHEET 2025
A-04

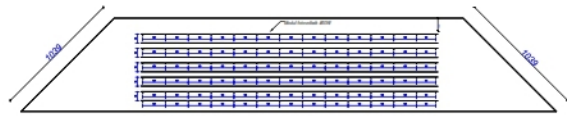
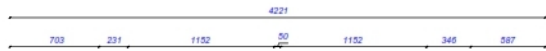

DIMENSIONET E SIPERFAQES KU DO TE VENDOSEN PANELET FOTOVOLTAIKE

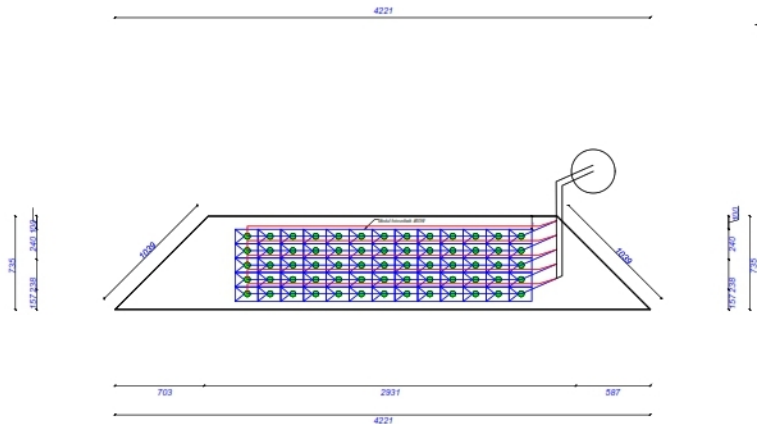

BASHKIA E MIRDITËSË

AGJENCIA E SHËRIMTARË
ZENTRICO
 SHËRIMTARË
 Sh. Dëshmorit Nr. 10, Kap. 10005
 T. 068 4447000
 E. info@zentrico.com

NUMERI I TËRANËS / TECHNICAL NOTES

PROJEKTI / PROJECT NAME
"INSTALIMI I SISTEMIT FOTOVOLTAIK"

ZONA / LOCATION
BASHKIA E MIRDITËSË

FAZA E PROJEKTI / PROJECT PHASE
**PROJEKTI ZBATIM
 IMPLEMENTACION DESIGN**

PROJEKTI ARCHITETONIK / ARCHITECTURAL DESIGN
 Ing. Rigelinda MYDALLARI
 Sh. D. 10712
 Sh. Dëshmorit 10, Kap. 10005

PROJEKTI INZHINIERI / STRUCTURAL DESIGN
 Ing. Nexhat TARDA
 Sh. D. 10712

PROJEKTI NEKONSTRUKTIV / HEATING AND COOLING
 Ing. Ardit PERI
 Sh. D. 10712

PROJEKTI NEKONSTRUKTIV / MUNICIPAL DESIGN
 Ing. Merita MEGRI
 Sh. D. 10712

PROJEKTI ELIMTRIK / ELECTRICAL DESIGN
 Ing. Kristaq ZHURIA
 Sh. D. 10712

STATUSI I TËRANËS / TITLE OF DESIGN
 DISENYNI TËRANËS E SHËRIMTARËS KU DO TE VENDOSEN PANELET

SHKALLA / SCALE	SH. D. 10712 / COMMUNAL
SHKALLA / SCALE	A-05

NUMERI I TËRANËS / NUMBER

SKEMA ELEKTRIKE AC

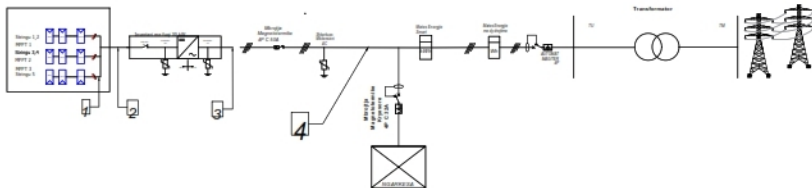

PROJEKTORI: GJESH



UNIVERSITETI I PRISHTINES

FACULTETI I INZHINJERISE



"GJESH" QENDRORE
UNIVERSITETI I PRISHTINES
FACULTETI I INZHINJERISE

SHKURIME TËMBAJTE / TECHNICAL NOTES

PROJEKTI / PROJECT NAME

"INSTALIMI I SISTEMIT
FOTOVOLTAIK"

LOKA / LOCATION

BASHKIA MIRDITË

FAZA E PROJEKUT / PROJECT PHASE

PROJEKT ZBATIM
IMPLEMENTATION DESIGN

PROJEKTI ARCHITETUR / ARCHITECTURAL DESIGN

Ark. Rrahmonde MYDRIJALLI

04-04-2023

04-04-2023

PROJEKTI KOSMETI / ELECTRICAL DESIGN

Ing. Rexhep TARDJA

04-04-2023

PROJEKTI Mekanik / MECHANICAL DESIGN

Ing. Ardit PEÇI

04-04-2023

PROJEKTI Hidroshpirtor / MUNICIPAL DESIGN

Ing. Merita MEÇI

04-04-2023

PROJEKTI Elektrik / ELECTRICAL DESIGN

Ing. Kristaq ZHURJA

04-04-2023

SHKURIME / NOTES / TITLE OF DESIGN

SKEMA ELEKTRIKE AC

SHKALLA / SCALE

1:100

SHKURIT 2023

NO. I DOKUMENTIT / NO.

A-06

FIG. A / DRAWING

DIMENSIONET E INVERTERIT

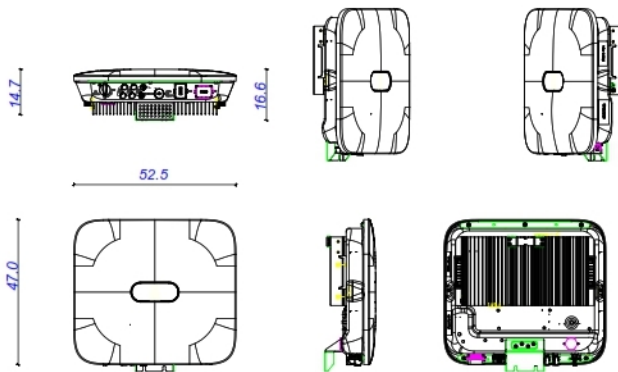

BASHKIA E PRISHTINES

ARCHITECT / CONSULTANT



SHKURIM TOSARI - TECHNICAL DESIGN

PROJECT / PROJECT NAME

"INSTALIMI I SISTEMIT FOTOVOLTAIK"

ZONE / LOCATION

BASHKIA E PRISHTINES

PHASE OF PROJECT / PROJECT PHASE

PROJECT DESIGN
IMPLEMENTATION DESIGN

PROJECT ARCHITECTURE / ARCHITECTURAL DESIGN

Ing. Rigelinda MYDOLLARI
044-47012
044-4701202

PROJECT ARCHITECTURE / STRUCTURAL DESIGN

Ing. Nexhë TARDJA
044-47012

PROJECT MATERIALS / HEATING AND COOLING

Ing. Ardit PEKO
044-47012

PROJECT ARCHITECTURE / MUNICIPAL DESIGN

Ing. Merita BERGU
044-47012

PROJECT ELECTRICAL / ELECTRICAL DESIGN

Ing. Kristaq ZHURJA
044-47012

SYSTEM CREATED / TITLE OF DESIGN

DESIGNING & INSTALLING

SHKALLA

SHKURT 2025

SHKALLA

SHKURT 2025

A-07

SKALA / STAMP

SKEMA E SISTEMIT TE MATJES

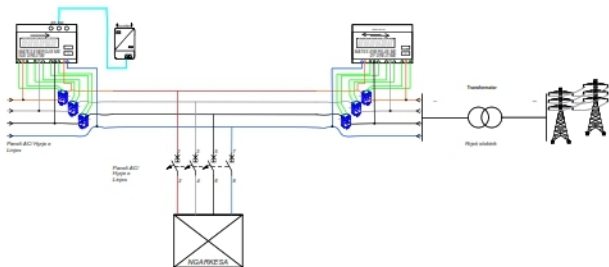

LEGJENDE	
	Inverter
	Transformator
	Mëtesor
	Adhesor
	Mëtesor Energji
	Transformator
	Rrjetje
	Ngarkesa



BASHKIA E REJTËS, PESHKËP

ARCHITECT / CONSULTANT
ZENTRICO
 ARCHITECTURE & ENGINEERING
 10, Sheshi i 18 Majit 2005, TIRANË
 T. 069 4470000

SHËRBIM TËRANSPIRENCIAL - TECHNICAL NOTES

PROJECT / PROJECT NAME
"INSTALIMI I SISTEMIT FOTOVOLTAIK"

ZONE / LOCATION
BASHKIA REJTËSE

PHASE OF PROJECT / PROJECT PHASE
PROJECT SYSTEM IMPLEMENTATION DESIGN

PROJECT ARCHITECTURE / ARCHITECTURAL DESIGN
 Ing. Rishmende MYDALLARU
 06.04.2022
 06.04.2022

PROJECT ARCHITECTURE / STRUCTURAL DESIGN
 Ing. Nexhap TARSA
 06.04.2022

PROJECT ARCHITECTURE / HEATING AND COOLING
 Ing. Argjil PEPI
 06.04.2022

PROJECT ARCHITECTURE / MUNICIPAL DESIGN
 Ing. Merita AMGRI
 06.04.2022

PROJECT ELECTRICAL / ELECTRICAL DESIGN
 Ing. Kristaq ZHURJA
 06.04.2022

SYSTEM STATUS / TITLE OF DESIGN
 DESIGN & SYSTEM IN PARTS

SKEMA E MATJES	REVIZIONI / COMMENTS
SHKURT 2022	A-08

SCALE / STAMP

PLANVENDOSJA E INVERTERIT

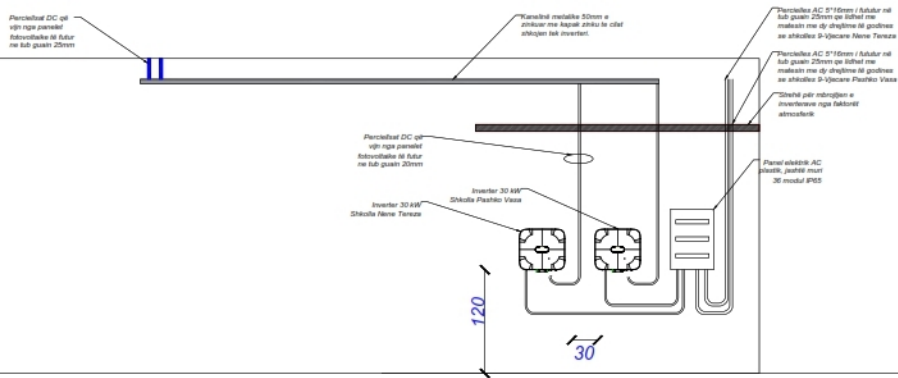

MINISTRI E DREKTORATI PËR SHIKIMIN E VEPRIMEVE

ARCHITECT / CONSULTANT

ZENTECO
ARCHITECTURE & ENGINEERING

16 Sheshiun "16 Tetor" Nr. 10, 1101000 TIRANë

Tel: +355 42 222 1111

SHKURIM: TIRANë - TECHNICAL NOTES

PROJECT / PROJECT NAME

"INSTALIMI I SISTEMIT FOTOVOLTAIK"

ZONE / LOCATION

BASHKIA MPRIDITË

PHASE / PROJECT / PROJECT PHASE

PROJECT SYSTEM IMPLEMENTATION DESIGN

PROJECT ARCHITECTURE / ARCHITECTURAL DESIGN

Ing. Rigonda MYDALLARU
SHALLA 01/2012

PROJECT STRUCTURE / STRUCTURAL DESIGN

Ing. Nexhip TARDA
SHALLA 01/2012

PROJECT HEATING / HEATING AND COOLING

Ing. Ardit PERI
SHALLA 01/2012

PROJECT LANDSCAPE / LANDSCAPE DESIGN

Ing. Merita MEGRI
SHALLA 01/2012

PROJECT ELECTRICAL / ELECTRICAL DESIGN

Ing. Kristaq ZHURBA
SHALLA 01/2012

SYSTEM CREATED / TITLE OF DESIGN

PLANIMETRIKAL E SHKURIMIT

SHALLA / SCALE: 1:500

SHKURIM 2025

SHALLA / SCALE: 1:500

A-09

SHALLA / SCALE: 1:500

PROJEKTI FOTOVOLTAIK

OBJEKTI: "Shkolla 9-vjecare "Pashko Vasa"

PROGRAMI: "Projektimi i Sistemit Fotovoltaik"

MBESHTETES: IPA II Cross Border Cooperation Programme for Albania- Kosovo

PERFITUES: Bashkia Mirditë



ZENIT&CO

Tiranë 2026



BASHKIA MIRDITE

PLANIMETRI E PËRGJITHËSHME E OOBJEKTIT

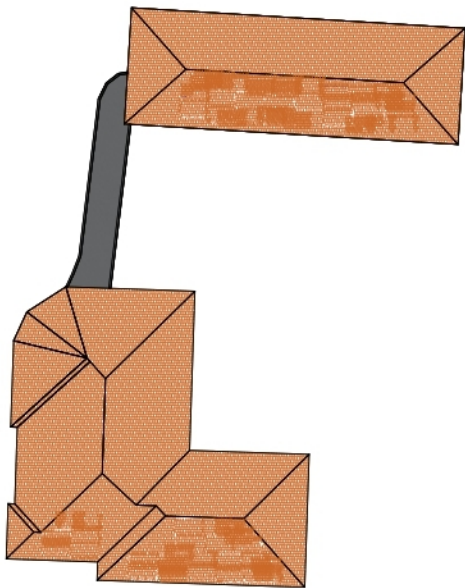

MINISTRI I INFRASTRUKTURËS

ARCHITECT / CONSULTANT
ZENTRICO
ARCHITECTURE
Rr. Shën Kollin, Nr. 18, Tiranë, 5400
T: 06 4444444
www.zenticoco.com

DATE: 15.05.2024
SCALE: 1:500
PROJECT: 2024/05/15

PROJECT / PROJECT NAME
"INSTALIMI I SISTEMIT FOTOVOLTAIK"

ZONE / LOCATION
BASHKIA MIRDITË

PHASE OF PROJECT / PROJECT PHASE
**PROJEKT ZBATIM
IMPLEMENTATION DESIGN**

PROJECT ARCHITECTURE / ARCHITECTURAL DESIGN
Ing. Rigbert MYSHOLLARI
Rr. Shën Kollin, Nr. 18, Tiranë, 5400

PROJECT STRUCTURE / STRUCTURAL DESIGN
Ing. Nexhat TARRA
Rr. Shën Kollin, Nr. 18, Tiranë, 5400

PROJECT MECHANICAL / HEATING AND COOLING
Ing. Ardit PIRI
Rr. Shën Kollin, Nr. 18, Tiranë, 5400

PROJECT MECHANICAL / MECHANICAL DESIGN
Ing. Merita MEGRI
Rr. Shën Kollin, Nr. 18, Tiranë, 5400

PROJECT ELECTRICAL / ELECTRICAL DESIGN
Ing. Kristaq ZHURIA
Rr. Shën Kollin, Nr. 18, Tiranë, 5400

DESIGNER / TITLE OF DESIGN
PLANIMETRI I OOBJEKTIT

SCALE / DRAWING
A-01

PLANIMETRI E PËRGJITHËSHME E OOBJEKTIT

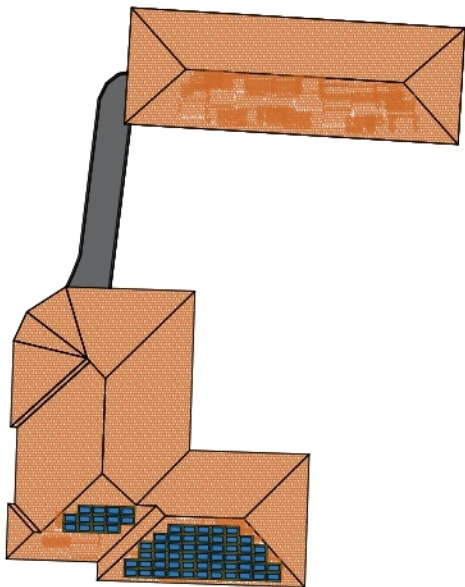

MINISTRI I ENJGJIERIS, PËRPUTHUR

ARCHITECT / CONSULTANT



SHËRBIM TËRANË - TECHNICAL SERVICE

PROJECT / PROJECT NAME

"INSTALIMI I SISTEMIT FOTOVOLTAIK"

ZONE / LOCATION

BASHKIA MIRDITË

PHASE OF PROJECT / PROJECT PHASE

PROJEKT ZBATIM
IMPLEMENTATION DESIGN

PROJECT ARCHITECTURE / ARCHITECTURAL DESIGN

Ing. Rigberta MYDRIJARI
SHALLA 07/12
SHALLA 07/12/17

PROJECT ARCHITECTURE / STRUCTURAL DESIGN

Ing. Nexhap TARDA
SHALLA 07/12

PROJECT MATERIALS / HEATING AND COOLING

Ing. Ardit PEPI
SHALLA 07/12

PROJECT ARCHITECTURE / MUNICIPAL DESIGN

Ing. Merita MEGRI
SHALLA 07/12

PROJECT ELECTRICAL / ELECTRICAL DESIGN

Ing. Kristaq ZHURIA
SHALLA 07/12

SYSTEM / CLIENT / TITLE OF DESIGN

PLANI/PËRPUTHURSHI/SHËRBIM

SHALLA 07/12

SHALLA 07/12

SHALLA 07/12

SHALLA 07/12

SHALLA 07/12

SHALLA 07/12

A-02

SHALLA 07/12



REPUBLIKË E KOSOVËS

AGJENCIA E KOSOVËS

AGJENCIA E KOSOVËS

AGJENCIA E KOSOVËS

AGJENCIA E KOSOVËS

AGJENCIA E KOSOVËS

AGJENCIA E KOSOVËS

AGJENCIA E KOSOVËS

AGJENCIA E KOSOVËS

AGJENCIA E KOSOVËS

AGJENCIA E KOSOVËS

AGJENCIA E KOSOVËS

AGJENCIA E KOSOVËS

AGJENCIA E KOSOVËS

AGJENCIA E KOSOVËS

AGJENCIA E KOSOVËS

AGJENCIA E KOSOVËS

AGJENCIA E KOSOVËS

AGJENCIA E KOSOVËS

AGJENCIA E KOSOVËS

AGJENCIA E KOSOVËS

AGJENCIA E KOSOVËS

AGJENCIA E KOSOVËS

AGJENCIA E KOSOVËS

AGJENCIA E KOSOVËS

AGJENCIA E KOSOVËS

AGJENCIA E KOSOVËS

AGJENCIA E KOSOVËS

AGJENCIA E KOSOVËS

AGJENCIA E KOSOVËS

AGJENCIA E KOSOVËS

AGJENCIA E KOSOVËS

AGJENCIA E KOSOVËS

AGJENCIA E KOSOVËS

AGJENCIA E KOSOVËS

AGJENCIA E KOSOVËS

AGJENCIA E KOSOVËS

AGJENCIA E KOSOVËS

AGJENCIA E KOSOVËS

AGJENCIA E KOSOVËS

AGJENCIA E KOSOVËS

AGJENCIA E KOSOVËS

AGJENCIA E KOSOVËS

AGJENCIA E KOSOVËS

AGJENCIA E KOSOVËS

AGJENCIA E KOSOVËS

AGJENCIA E KOSOVËS

AGJENCIA E KOSOVËS

AGJENCIA E KOSOVËS

AGJENCIA E KOSOVËS

AGJENCIA E KOSOVËS

AGJENCIA E KOSOVËS

AGJENCIA E KOSOVËS

AGJENCIA E KOSOVËS

AGJENCIA E KOSOVËS

AGJENCIA E KOSOVËS

AGJENCIA E KOSOVËS

AGJENCIA E KOSOVËS

AGJENCIA E KOSOVËS

AGJENCIA E KOSOVËS

AGJENCIA E KOSOVËS

AGJENCIA E KOSOVËS

AGJENCIA E KOSOVËS

AGJENCIA E KOSOVËS

AGJENCIA E KOSOVËS

AGJENCIA E KOSOVËS

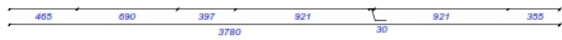
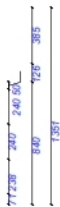
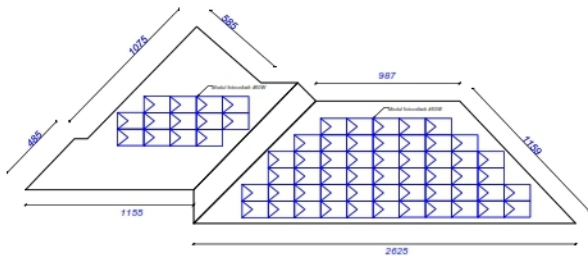
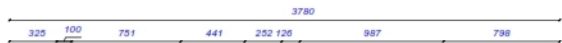

PROJEKTI / PROJECT NAME

"INSTALIMI I SISTEMIT FOTOVOLTAIK"

FORM / LOCATION

BASHKIA MEDITË

FAZA E PROJEKTIT / PROJECT PHASE

PROJEKT ZBATIM
IMPLEMENTATION DESIGN

PROJEKT/ARCHITECTURE / ARCHITECTURAL DESIGN

Ing. Rishanë MYDRI
BULEVARDI
BULEVARDI

PROJEKT/CONSTRUCTION / STRUCTURAL DESIGN

Ing. Nexhë TARSA
BULEVARDI

PROJEKT/MECHANICAL / HEATING AND COOLING

Ing. Ardit PERI
BULEVARDI

PROJEKT/MECHANICAL / MUNICIPAL DESIGN

Ing. Merita MERRI
BULEVARDI

PROJEKT/ELECTRICAL / ELECTRICAL DESIGN

Ing. Kristaq ZHURIA
BULEVARDI

PROJEKT/OTHER / TITLE OF DESIGN

COMMISSIONER'S APPROVED AS TO THE VENDOR'S RESULT

SHALLA / DATE

SHKURT 2025

SHALLA / DATE

A-03

SKILL / STAMP



BASKPA ARHITEKT, PERTIWI

ARCHITECT / CONSULTANT



ZENTRICO

PT. ZENTRICO
Jl. Pemuda No. 10 Jakarta 10130
T. 021 44792100

SKALA / DRAWING: TECHNICAL NOTES

PROJEKSI / PROJECT NAME:

"INSTALASI SISTEM FOTOVOLTAIK"

LOKASI / LOCATION:

BASKPA APDITIZ

FASE / PROJECT / PROJECT PHASE:

PROJEKSI ZATIM
IMPLEMENTATION DESIGN

PROJEKSI ARSITEKTUR / ARCHITECTURAL DESIGN:

Ing. Reginonda MYDILLARI
No. 14-0712
Jl. Raya BSD Blok 17/17

PROJEKSI KONSTRUKSI / STRUCTURAL DESIGN:

Ing. Rishap TARSA
No. 14-0704

PROJEKSI MEKANIKA / HEATING AND COOLING:

Ing. Angko PERI
No. 14-0711

PROJEKSI MEKANIKA / MECHANICAL DESIGN:

Ing. Mella MEGRI
No. 14-0705

PROJEKSI ELAKTRIK / ELECTRICAL DESIGN:

Ing. Kristop ZHUBA
No. 14-0707

SKALA / TITLE: TITLE OF DESIGN

DISKUSI & DISKUSI / DISCUSSION AND DISCUSSION RESULT

SKALA / SCALE: 1:100

NO. / NO. DRAWING: DWG 2025

NO. / NO. DRAWING: A-04

SKALA / SCALE:

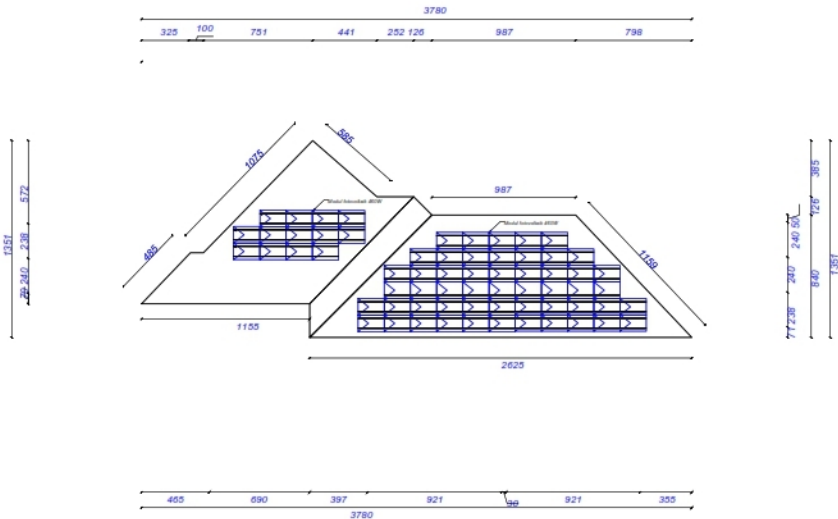

DIMENSIONET E SIPERFAQES KU DO TE VENDOSEN PANELET FOTOVOLTAIKE

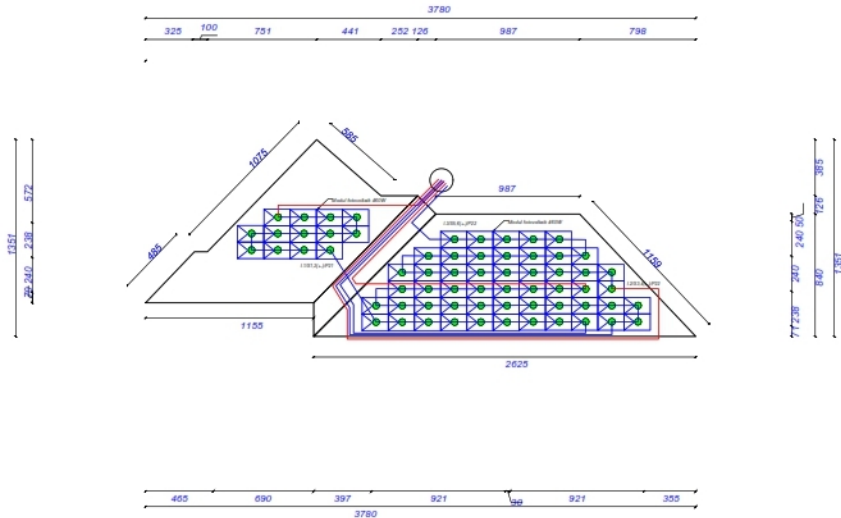

BASHKIA E PRIZRIT

ARCHITECT / CONSULTANT
ZENTRICO
 ARCHITECTURE
 Prizreni, Nr. 10, qyteti i Prizrenit
 T. 045 447000

SHKURTYM TËNDRIMOR / TECHNICAL NOTES

PROJEKT / PROJECT NAME

"INSTALIMI I SISTEMIT FOTOVOLTAIK"

STADI / LOCATION

BASHKIA E PRIZRIT

FAZA E PROJEKTIT / PROJECT PHASE

PROJEKTI ZGATIMOR
 IMPLEMENTATION DESIGN

PROJEKTANT/ARCHITECTUR / ARCHITECTURAL DESIGNER

Ing. Rigmunde MYDALLARI
 BULEVARI 1012
 PRIZREN 38000 KOSOVA

PROJEKTANT/INGENIER / STRUCTURAL DESIGNER

Ing. Nexhup TARSA
 BULEVARI 1012

PROJEKTANT/INGENIER / HEATING AND COOLING

Ing. Arqipe PERI
 BULEVARI 1012

PROJEKTANT/INGENIER / MUNICIPAL DESIGNER

Ing. Merita AMETRI
 BULEVARI 1012

PROJEKTANT/INGENIER / ELECTRICAL DESIGNER

Ing. Kristaq ZHURRA
 BULEVARI 1012

SHKURTYM TËNDRIMOR / TITLE OF DESIGN

SHKURTYM TËNDRIMOR / APPROVED AND GIVE TO VENDOSUR
 PROJECT

SHKALLA / SCALE

1:100

SHKURTYM / DATE

SHKURTYM / DATE

SHKALLA / SCALE

SHKALLA / SCALE

A-06

DIMENSIONET E INVERTERIT

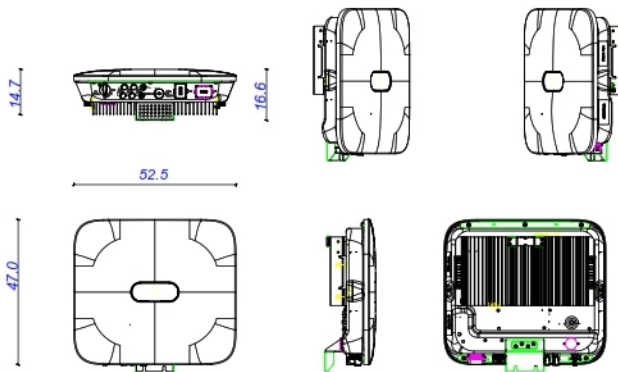

BASHKIA E PRISHTINES

ARCHITECT / CONSULTANT



ZENTECO
CONSULTING

Prishtine, Str. Nr. 18, Kq. Gazime 1000
T. 045 444333
E. info@zenteco.com

SHKURIM TARRA - TECHNICAL DESIGN

PROJECT / PROJECT NAME

"INSTALIMI I SISTEMIT
FOTOVOLTAIK"

ZONE / LOCATION

BASHKIA E PRISHTINES

PHASE OF PROJECT / PROJECT PHASE

PROJECT DESIGN
IMPLEMENTATION DESIGN

PROJECT ARCHITECTURE / ARCHITECTURAL DESIGN

Ing. Rigberta MYDRIELLARU
Sh. Nr. 4, Str. Nr. 18, Kq. Gazime 1000

PROJECT ARCHITECTURE / STRUCTURAL DESIGN

Ing. Nexhate TARRA
Sh. Nr. 4, Str. Nr. 18, Kq. Gazime 1000

PROJECT MATERIALS / HEATING AND COOLING

Ing. Ardit PEKO
Sh. Nr. 4, Str. Nr. 18, Kq. Gazime 1000

PROJECT ARCHITECTURE / MUNICIPAL DESIGN

Ing. Merita BERGU
Sh. Nr. 4, Str. Nr. 18, Kq. Gazime 1000

PROJECT ELECTRICAL / ELECTRICAL DESIGN

Ing. Kristaq ZHURBA
Sh. Nr. 4, Str. Nr. 18, Kq. Gazime 1000

SYSTEMS CREATED / TITLE OF DESIGN

IMPLEMENTATION & MAINTENANCE

SHKURIM TARRA

SHKURIM TARRA

SHKURIM TARRA

SHKURIM TARRA

SHKURIM TARRA

SHKURIM TARRA

SHKURIM TARRA

SHKURIM TARRA

SHKURIM TARRA

SHKURIM TARRA

SHKURIM TARRA

SHKURIM TARRA

SHKURIM TARRA

SHKURIM TARRA

SHKURIM TARRA

SHKURIM TARRA

SHKURIM TARRA

SHKURIM TARRA

SHKURIM TARRA

SHKURIM TARRA

SHKURIM TARRA

SHKURIM TARRA

SHKURIM TARRA

SHKURIM TARRA

SHKURIM TARRA

SHKURIM TARRA

SHKURIM TARRA

SHKURIM TARRA

SHKURIM TARRA

SHKURIM TARRA

A-08

SKEMA E SISTEMIT TE MATJES

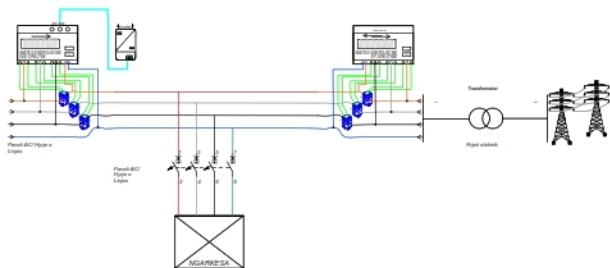

LEGJENDE	
	Inverter
	Transformator Rreptë
	Shprehje Mbrojtëse
	Adrestitë Shprehëse
	Mbrojtje Energji
	Transformator T/TT
	Rreptë Ushqim
	Shprehje / Objekt



BASHKIA E PRISHTINËS

ARCHITECT / CONSULTANT



SHKURIM TARRASIA - TECHNICAL DESIGN

PROJECT / PROJECT NAME

"INSTALIMI I SISTEMIT FOTOVOLTAIK"

ZONE / LOCATION

BASHKIA E PRISHTINËS

PHASE OF PROJECT / PROJECT PHASE

PROJECT ZBATIM
IMPLEMENTATION DESIGN

PROJECT ARCHITECTURE / ARCHITECTURAL DESIGN

Ing. Rishmende MYDOLLARI
045 44 0712
045 44 0713

PROJECT ARCHITECTURE / STRUCTURAL DESIGN

Ing. Nexhpet TARRA
045 44 0704

PROJECT MECHANICAL / HEATING AND COOLING

Ing. Argjesh PERI
045 44 0711

PROJECT MECHANICAL / MUNICIPAL DESIGN

Ing. Merita AMETRI
045 44 0703

PROJECT ELECTRICAL / ELECTRICAL DESIGN

Ing. Kristina ZHURIA
045 44 0707

PROJECT STATUS / TITLE OF DESIGN

BRINDJE E DOKUMENTIT NE SHKURT

SHKURILLA

SHKURT 2025

SHKURILLA

A-9

SKALA / SCALE

PLANVENDOSJE E INVERTERIT E INVERTERIT

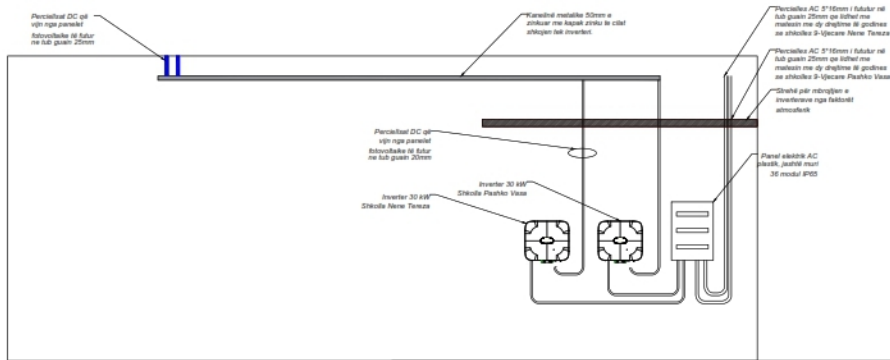

PROJEKTI-01/2023



BASHKIA E PRIZRINIT

ARCHITECT / CONSULTANT



ZENTRICO
ARCHITECTURE

Prizreni, Str. Dr. B. Kallaku 3003
T. 045 440000

STATUSI / TITULLI / TECHNICAL NOTES

PROJECT / PROJECT NAME

"INSTALIMI I SISTEMIT FOTOVOLTAIK"

ZONE / LOCATION

BASHKIA E PRIZRINIT

PHASE OF PROJECT / PROJECT PHASE

PROJECT SYSTEM IMPLEMENTATION DESIGN

PROJECT ARCHITECTURE / ARCHITECTURAL DESIGN

Ing. R. Hoxha

PROJECT STRUCTURE / STRUCTURAL DESIGN

Ing. F. Haxhiu

PROJECT MECHANICAL / HEATING AND COOLING

Ing. A. Peci

PROJECT ENVIRONMENTAL / MUNICIPAL DESIGN

Ing. M. Miro

PROJECT ELECTRICAL / ELECTRICAL DESIGN

Ing. K. Zhuba

SYSTEM UTILITIES / TITLE OF DESIGN

PLANNING AND MANAGEMENT & MAINTENANCE

SCALE

DATE

2023

SCALE / COMPARISON

A-10

SCALE / DRAW

PROJEKTI FOTOVOLTAIK

OBJEKTI: "Ujësjetllsi Bukmirë"

PROGRAMI: "Projektimi i Sistemit Fotovoltaik"

MBESHTETES: IPA II Cross Border Cooperation Programme for Albania- Kosovo

PERFITUES: Bashkia Mirditë



ZENIT&CO

Tiranë 2026



BASHKIA MIRDITE

PLANIMETRI E PËRGJITHËSHME E OBJEKTIT

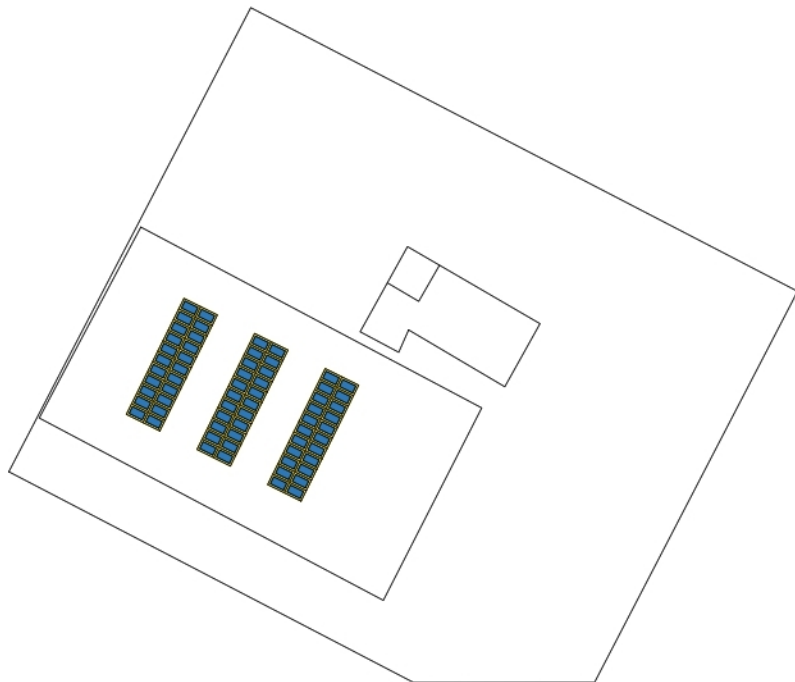

MINISTRI I ENJERIS

ARCHITECT / CONSULTANT

ZENTBEO
ARCHITECTURE
P.O. Box 100, 11000 Prishtine, Kosovo
T: +383 45 211 111
E: info@zentbeo.com

DATE: 10.05.2024 / TECHNICAL NOTES

PROJECT / PROJECT NAME

**"INSTALIMI I SISTEMIT
FOTOVOLTAIK"**

ZONE / LOCATION

BASHKIA MIRETË

PHASE / PROJECT / PROJECT PHASE

**PROJEKT ZBATIM
IMPLEMENTATION DESIGN**

PROJECT ARCHITECTURE / ARCHITECTURAL DESIGN

**Ing. Rigberta MYDRELLARI
BULEVARI
PRISTINE, KOSOVO**

PROJECT ARCHITECTURE / ARCHITECTURAL DESIGN

**Ing. Nexhip TARDA
BULEVARI**

PROJECT ARCHITECTURE / HEATING AND COOLING

**Ing. Arqife PERI
BULEVARI**

PROJECT ARCHITECTURE / MUNICIPAL DESIGN

**Ing. Merita MEGRI
BULEVARI**

PROJECT ARCHITECTURE / ELECTRICAL DESIGN

**Ing. Kristaq ZHURIA
BULEVARI**

SYSTEM CREATED / TITLE OF DESIGN

PLAN / PERLINDJE SHKURTIM

SCALE / DRAWING

**SHKALLA
1:1000**

**SHKALLA
2024**

SCALE / DRAWING

A-01

SCALE / DRAWING

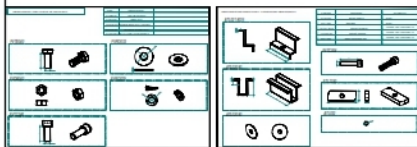
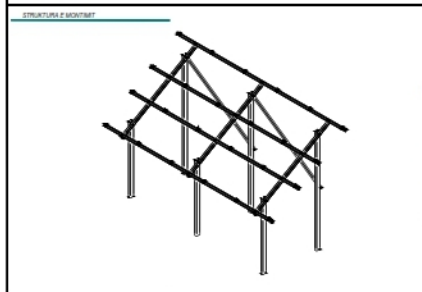
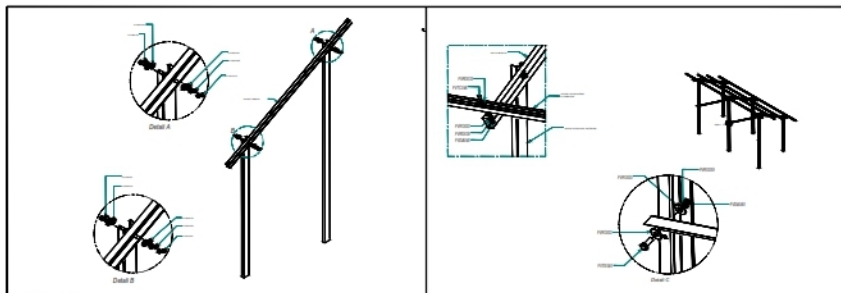

UNIVERSITETI I TIRANES

FAKULTETI I ARCHITECTURËS

UNIVERSITETI I TIRANES
FAKULTETI I ARCHITECTURËS
Rr. Dëshmorët e Kombit, Tiranë
T. 06 4720000
E. 06 4720000

PROJEKTI TITULLI - TECHNICAL NOTES

PROJEKTI - PROJECT NAME

"INSTALIMI I SISTEMIT
FOTOVOLTAIK"

SIEMI - LOCATION

BASHKËSI APODITE

FAZI I PROJEKTI - PROJECT PHASE

PROJEKTI ZBATIM
IMPLEMENTATION DESIGN

PROJEKTI ARCHITECTONIK - ARCHITECTURAL DESIGN

Ark. Rigonda MYDALLARU
06.04.2022
06.04.2022

PROJEKTI INZHINIERI - STRUCTURAL DESIGN

Ing. Klodian TARDA
06.04.2022

PROJEKTI INZHINIERI - HEATING AND COOLING

Ing. Ardit PERI
06.04.2022

PROJEKTI INZHINIERI - MECHANICAL DESIGN

Ing. Merita BERGU
06.04.2022

PROJEKTI ELIMTRIK - ELECTRICAL DESIGN

Ing. Kristin ZHURA
06.04.2022

SIEMI - CLIENT - TITLE OF DESIGN

SIEMI - STRUCTURED MODEL

SHALLA

SCALE

SMART 2022

NO. ILLUSTRACIONE

A-02

SIEMI - STAMP

STRUKTURA METALIKE

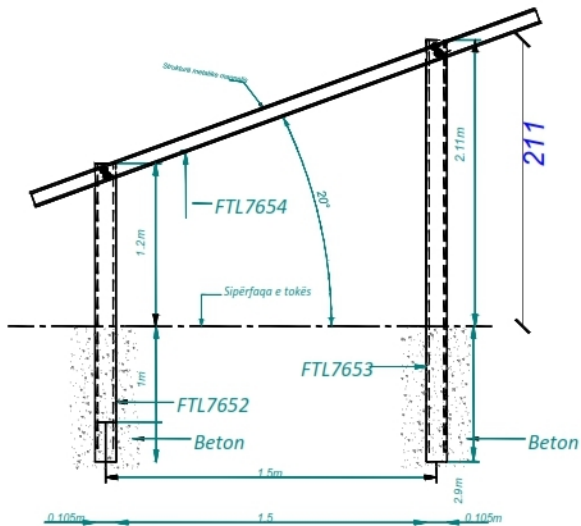

PROJEKTUESI - KLASHT



MINISTRI I INFRASTRUKTURËS

ARCHITECT / CONSULTANT



SHËRBIM TËRANË - TECHNICAL DESIGN

PROJECT / PROJECT NAME

"INSTALIMI I SISTEMIT FOTOVOLTAIK"

ZONE / LOCATION

BASHKIA MIRDITË

PHASE / PROJECT / PROJECT PHASE

PROJEKT ZBATIM
IMPLEMENTATION DESIGN

PROJECT ARCHITECTURE / ARCHITECTURAL DESIGN

Ing. Rigbertina MYDINLLARI
06.04.07.02
06.04.07.02

PROJECT STRUCTURE / STRUCTURAL DESIGN

Ing. Nexhip TARSA
06.04.07.02

PROJECT MECHANICAL / HEATING AND COOLING

Ing. Ardit PEPI
06.04.07.02

PROJECT MECHANICAL / MECHANICAL DESIGN

Ing. Merita BERGU
06.04.07.02

PROJECT ELECTRICAL / ELECTRICAL DESIGN

Ing. Kristaq ZHURIA
06.04.07.02

SYSTEM / TITLE / TITLE OF DESIGN

STRUKTURA METALIKE

SCALE / SCALE

SCALE 2025

SCALE / SCALE

A-03

SCALE / SCALE

SKEMA E SISTEMIT TE MATJES

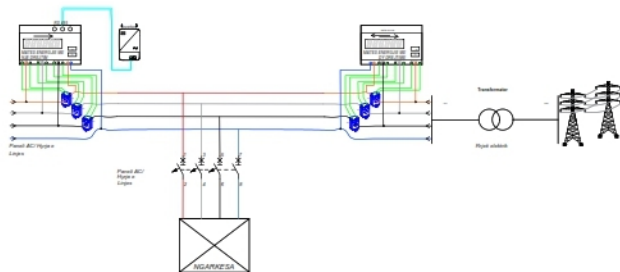

LEGJENDE	
	Person
	Transformator Tipi
	Shprehës Mikrorrjet
	Rrjet e ndërtimit
	Blloku Energji Integruar
	Transformator T0/T0
	Rrjet e ndërtimit
	Rrjet e ndërtimit



MINISTRI I ENJGJIERIS

ZENTRICO
 CONSULTING
 16 Sheshi "19 Tetor" 2005
 T. 021 4441111
 E-Mail: info@zentrico.com

SHENIM: TIRAZHI - TECHNICAL NOTES

PROJECT / PROJECT NAME
"INSTALIMI I SISTEMIT FOTOVOLTAIK"

ZONA / LOCATION
BASHKIA MPRITËZ

PHASE / PROJECT PHASE
**PROJEKT ZBATIM
 IMPLEMENTATION DESIGN**

PROJECT ARCHITECTURE / ARCHITECTURAL DESIGN
Ing. Rishtrikës MËYDULLARU
 Sh. Nr. 1, 10110
 TIRAZHI, REPUBLICA E ALBANI

PROJECT STRUCTURE / STRUCTURAL DESIGN
Ing. Nexhë TARRA
 Sh. Nr. 10004

PROJECT MECHANICAL / HEATING AND COOLING
Ing. Argjël PEËR
 Sh. Nr. 10011

PROJECT MECHANICAL / MUNICIPAL DESIGN
Ing. Merita MEGRI
 Sh. Nr. 10010

PROJECT ELECTRICAL / ELECTRICAL DESIGN
Ing. Kristaq ZHURBA
 Sh. Nr. 10007

DESIGN TITLE / TITLE OF DESIGN
SHKEMA E ZBATIMIT TE MATJES

SHEMALLA / SCALE: 1:1000
 SHKURT 2025

SHEMALLA / SCALE: 1:1000
A-05

DATA / DATE:

PROJEKTI FOTOVOLTAIK

OBJEKTI: "Ujesjellsi Lufaj"

PROGRAMI: "Projektimi i Sistemit Fotovoltaik"

MBESHTETES: IPA II Cross Border Cooperation Programme for Albania- Kosovo

PERFITUES: Bashkia Mirditë



ZENIT&CO

Tiranë 2026



BASHKIA MIRDITE

PLANIMETRI E PËRGJITHËSHME E OBJEKTIT

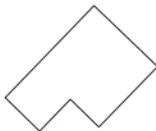

BASHKIA E MIRDITËS

ARCHITECT / CONSULTANT



ZENTRICO

16 Shkurtorë, Nr. 16, qyteti i Mirditës

NUMERI I TËRANËS / TECHNICAL NOTES

PROJEKTI / PROJECT NAME

"INSTALIMI I SISTEMIT
FOTOVOLTAIK"

ZONA / LOCATION

BASHKIA E MIRDITËS

FAZA E PROJEKTI / PROJECT PHASE

PROJEKTI ZBATIM
IMPLEMENTATION DESIGN

PROJEKTI ARCHITETONIK / ARCHITECTURAL DESIGN

Ing. Rigel Hoxha MYPONILLARI
SH. S.A. 07/12
SH. S.A. 07/12

PROJEKTI INZHINIERI / STRUCTURAL DESIGN

Ing. Nexhip TARSA
SH. S.A. 07/12

PROJEKTI INZHINIERI / HEATING AND COOLING

Ing. Argjesh PERI
SH. S.A. 07/12

PROJEKTI INZHINIERI / MUNICIPAL DESIGN

Ing. Merita MEGRI
SH. S.A. 07/12

PROJEKTI ELIMTRIK / ELECTRICAL DESIGN

Ing. Kristaq ZHURIA
SH. S.A. 07/12

NUMERI I TËRANËS / TITLE OF DESIGN

PLANI PËRGJITHËSH I OBJEKTIT

SHKALLA

1:1000

SHKURT 2025

SHKALLA

1:1000

SHKURT 2025

A-01

SKALA / STAMP

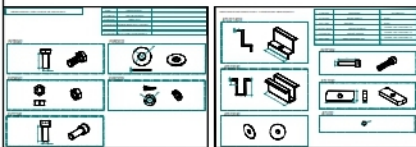
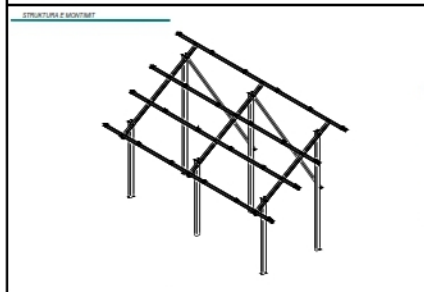
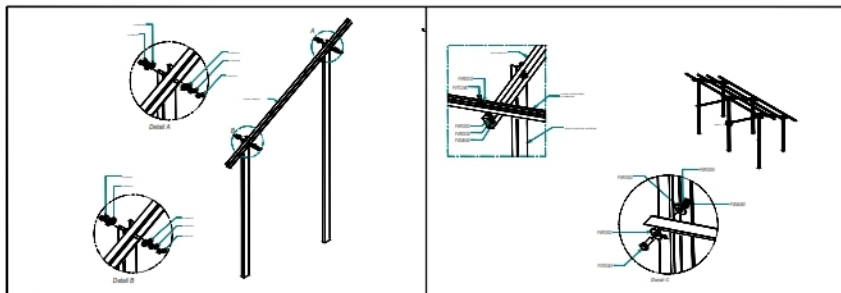

BAHUKUA ARIQDITE, PAFITUTUR

ARCHITECT CONSULTANT

"CENTRICO"
ARCHITECTURE
P.O. Box 100, 11000 Prishtine
T: 049 4441000
E: info@centrico.com

PROJEKTUIM TARRASHE - TECHNICAL DRAWING

PROJEKTUIM - PROJECT NAME

"INSTALIMI I SISTEMIT
FOTOVOLTAIK"

STADI - LOCATION

BAHUKUA ARIQDITE

FAZA E PROJEKTUIMIT - PROJECT PHASE

PROJEKTUIM ZBATIM
IMPLEMENTATION DESIGN

PROJEKTUIM ARCHITETONIK - ARCHITECTURAL DESIGN

Ark. Rigelinda MYDRIALLARI

SKALA 1:1000

DATA 2023

PROJEKTUIM STRUKTURAL - STRUCTURAL DESIGN

Ing. Fleketa TARDA

SKALA 1:1000

PROJEKTUIM TARRASHE - HEATING AND COOLING

Ing. Arqita PERI

SKALA 1:1000

PROJEKTUIM TARRASHE - MECHANICAL DESIGN

Ing. Merita BERGRI

SKALA 1:1000

PROJEKTUIM ELIMTRIK - ELECTRICAL DESIGN

Ing. Kristina ZHURA

SKALA 1:1000

STADIUMI TARRASHE - TITLE OF DESIGN

ELIMTRIK I STRUKTURES METALIKE

SHALLA

SHALLA

SHALLA

SHALLA

SHALLA

SHALLA

SHALLA

SHALLA

SHALLA

A-02

STRUKTURA METALIKE

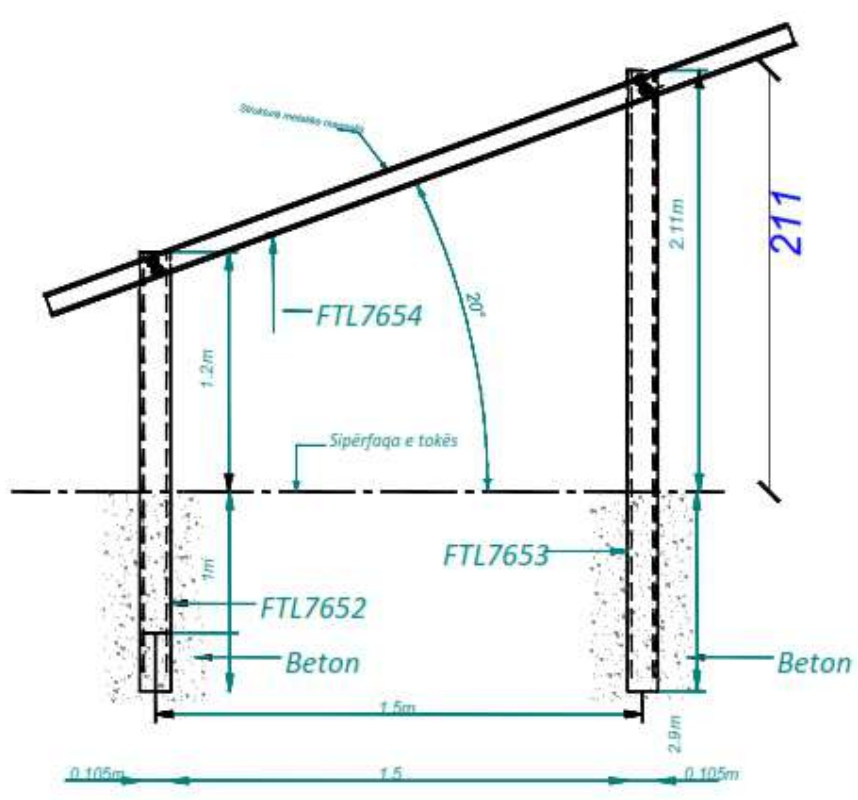

	
	
PROJECT / PROJECT NAME "INSTALIMI I SISTEMIT FOTOVOLTAIK"	
ZONA / LOCATION BASHKIA MIRONI	
NAME PROJECT / PROJECT NAME PROJEKT ZBATIM / IMPLEMENTATION DESIGN	
PROJECT ARCHITECTURE / ARCHITECTURE DESIGN Ark. Rajmonda MYDALLARI Nr. 4/2019 Data: 08/02/2019	
PROJECT STRUCTURE / STRUCTURE DESIGN Ing. Reshat TUKER Nr. 4/2019	
PROJECT MECHANICAL / MECHANICAL DESIGN Ing. Ardit FCO Nr. 4/2019	
PROJECT ELECTRICAL / ELECTRICAL DESIGN Ing. Almir METO Nr. 4/2019	
PROJECT CIVIL ENGINEERING / CIVIL ENGINEERING DESIGN Ing. Ardit ZHURJA Nr. 4/2019	
SHEET NO. / TITLE OF SHEET STRUKTURA METALIKE	
SHEET NO. 1/10	SHEET TITLE A-03
SHEET SCALE	

SKEMA ELEKTRIKE AC

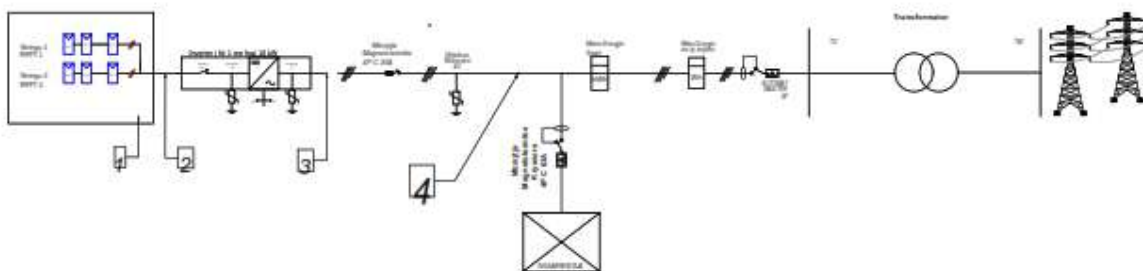

 <p>AZERBAIJAN REPUBLIC</p>	
 <p>ZENTACO Engineering & Design Bakinskaya Str. 21, Baku, AZ 1000 T: +994 12 461 00 00 E: info@zentaco.az</p>	
<p>PROJECT / PROJECT NAME</p> <p>"INSTALIMI I SISTEMIT FOTOVOLTAIK"</p>	
<p>PROJECT LOCATION</p> <p>BASHKHA MINGOZE</p>	
<p>BASE PROJECT / PROJECT PHASE</p> <p>PROJECT ZSATHI IMPLEMENTATION DESIGN</p>	
<p>PROJECT ARCHITECTURE / ARCHITECTURAL DESIGN</p> <p>Ark. Rajabovda MYDOLLARI No. 4-02/101 Baku, AZ 1000</p>	
<p>PROJECT STRUCTURE / STRUCTURAL DESIGN</p> <p>Ing. Rashad TURDI No. 4-02/101</p>	
<p>PROJECT MECHANICAL / MECHANICAL DESIGN</p> <p>Ing. Arifur FICHI No. 4-02/101</p>	
<p>PROJECT ELECTRICAL / ELECTRICAL DESIGN</p> <p>Ing. Akhmed MINGI No. 4-02/101</p>	
<p>PROJECT ELECTRICAL / ELECTRICAL DESIGN</p> <p>Ing. Akhmed ZHURIA No. 4-02/101</p>	
<p>PROJECT TITLE / TITLE OF DESIGN</p> <p>INSTALLATION DESIGN</p>	
<p>SCALE</p> <p>1:100</p> <p>DATE</p> <p>2023.05.05</p>	<p>PROJECT NUMBER</p> <p>A-04</p>
<p>SCALE STRIP</p>	

SKEMA E SISTEMIT TE MATJES

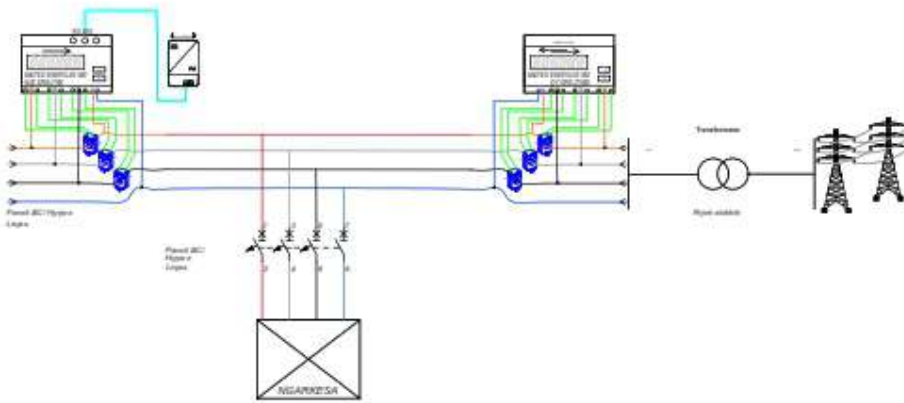

LEGJENDE	
	Person
	Technician Role
	Technical Material
	Special Requirement
	Work Design/Design
	Transformer 10/0.4
	App 10/0.4
	Signature/Stamp

<p>PROJECT / PROJECT NAME</p> <p>"INSTALIMI I SISTEMIT FOTOVOLTAIK"</p>	
<p>PROJECT LOCATION</p> <p>BASHKIA MIRONDE</p>	
<p>DATE PROJECT / PROJECT PHASE</p> <p>PROJECT ZBATIM / IMPLEMENTATION DESIGN</p>	
<p>PROJECT ARCHITECTURE / ARCHITECTURAL DESIGN</p> <p>Ark. Ridvanida MYDALLARI</p>	
<p>PROJECT STRUCTURE / STRUCTURAL DESIGN</p> <p>Ing. Besheq TURDI</p>	
<p>PROJECT ELECTRICAL / ELECTRICAL DESIGN</p> <p>Ing. Ardit FCO</p>	
<p>PROJECT MECHANICAL / MECHANICAL DESIGN</p> <p>Ing. Albert METO</p>	
<p>PROJECT SYSTEM / ELECTRICAL DESIGN</p> <p>Ing. Ridvan ZHURJA</p>	
<p>PROJECT SCALE / TITLE OF DRAWING</p> <p>SHKALLA 20000 / 10000</p>	
<p>SHKALLA</p> <p>SHKALLA</p> <p>SHKALLA</p>	<p>NO. OF SHEETS</p> <p>A-05</p>
<p>PROJECT SIGNATURE</p>	

PROJEKTI FOTOVOLTAIK

OBJEKTI: "Zyrat e bashkisë Mirditë"

PROGRAMI: "Projektimi i Sistemit Fotovoltaik"

MBESHTETES: IPA II Cross Border Cooperation Programme for Albania- Kosovo

PERFITUES: Bashkia Mirditë



ZENIT&CO

Tiranë 2026



BASHKIA MIRDITE

PLANIMETRI E PËRGJITHËSHME E OBJEKTIT

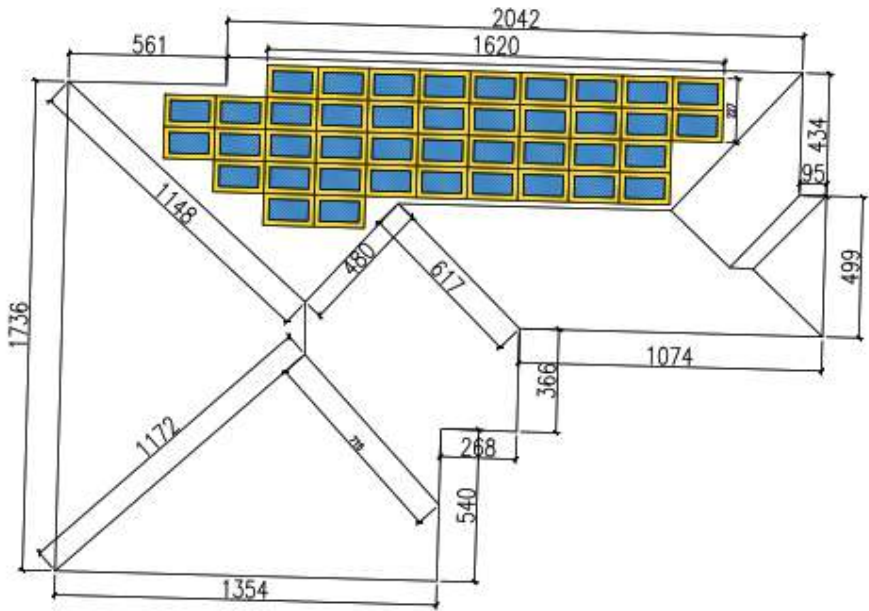

	
	
PROJECT LOCATION BASHKIA MIRONDE	
PROJECT TITLE "INSTALIMI I SISTEMIT FOTOVOLTAIK"	
PROJECT PHASE PROJEKT ZBATIM / IMPLEMENTATION DESIGN	
PROJECT ARCHITECT / ARCHITECTURAL DESIGNER Ark. Rigberta MYDALLARI	
PROJECT STRUCTURE / STRUCTURAL DESIGNER Ing. Reshat TURESI	
PROJECT ELECTRICAL / ELECTRICAL DESIGNER Ing. Ardit FERI	
PROJECT MECHANICAL / MECHANICAL DESIGNER Ing. Almir MIRONI	
PROJECT CIVIL / CIVIL DESIGNER Ing. Ardit ZHURJA	
SHEET TITLE OF DESIGN / IMPLEMENTATION DESIGN	
SHEET NO. 001/01	SHEET TOTAL A-01

PLANIMETRI E PËRGJITHËSHME E STRUKTURES

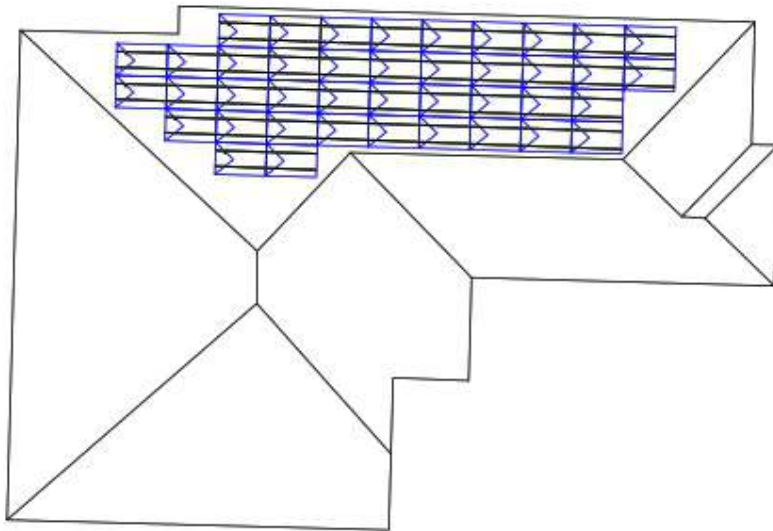

PROJEKTI / CLIENT  ADRESA SHKURTË / ADDRESS	
PROJEKTI / COMPANY  ZENITACO P.O. BOX 100 / TIRANA 1000 TIRANA / ALBANIA TEL: +355 42 222 222	
PROJEKTI / PROJECT NAME "INSTALIMI I SISTEMIT FOTOVOLTAIK"	
PROJEKTI / PROJECT TYPE BASHKËSI SHKURTË	
PROJEKTI / PROJECT PHASE PROJEKT ZBATIM / IMPLEMENTATION DESIGN	
PROJEKTI / PROJECT LOCATION BASHKËSI SHKURTË	
PROJEKTI / PROJECT ARCHITECT Ark. Rigonda MYDALLARI Rr. Nr. 4 / TIRANA TEL: +355 42 222 222	
PROJEKTI / PROJECT STRUCTURAL ENGINEER Ing. Besmir TURDI Rr. Nr. 4 / TIRANA	
PROJEKTI / PROJECT MECHANICAL ENGINEER Ing. Ardit FLORI Rr. Nr. 4 / TIRANA	
PROJEKTI / PROJECT ELECTRICAL ENGINEER Ing. Albin METO Rr. Nr. 4 / TIRANA	
PROJEKTI / PROJECT CIVIL ENGINEER Ing. Ardit ZHURJA Rr. Nr. 4 / TIRANA	
PROJEKTI / PROJECT TITLE OF DESIGN IMPLEMENTATION DESIGN	
SHALLA / SHEET NO. 001/01	SHALLA / SHEET TITLE A-02
SHALLA / SHEET DATE 01/01/2024	

PLANIMETRI E PËRGJITHËSHME E STRINGAVE

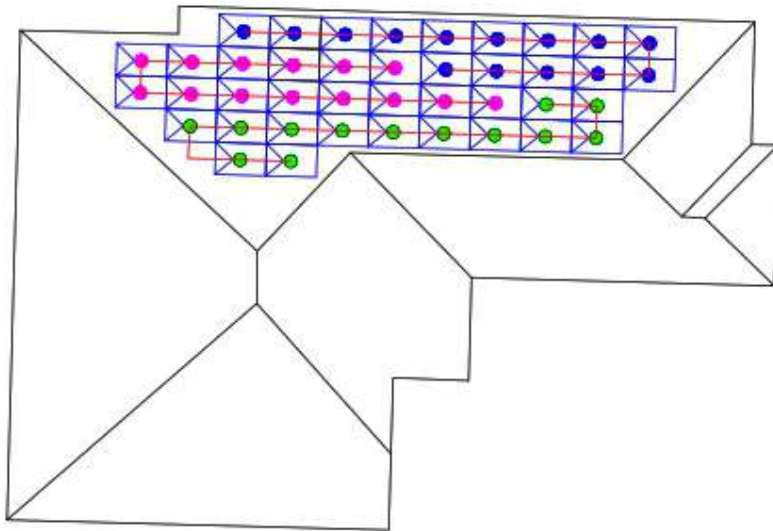

 <p>ADRESA WEB: www.zentaco.com</p>	
 <p>TEKNIKË TË REZISTENCËS PËR SHKËMBIMIN E ENERGJISË</p>	
<p>NUMER I DOKUMENTIT: _____</p>	
<p>PROJEKTI / PROJECT NAME</p> <p>"INSTALIMI I SISTEMIT FOTOVOLTAIK"</p>	
<p>LOKA / LOCATION</p> <p>BASHKIA MIRONDE</p>	
<p>EMER I PROJEKTI / PROJECT NAME</p> <p>PROJEKTI ZBATIM / IMPLEMENTATION DESIGN</p>	
<p>PROJEKTANT/DESIGNER - ARCHITECTURAL DESIGN</p> <p>Ark. Rigberta MYDALLARI Sh.Nr. 4/2019 Sh.K. 00000000000000000000</p>	
<p>PROJEKTANT/DESIGNER - STRUCTURAL DESIGN</p> <p>Ing. Besheq TUREN Sh.Nr. 4/2019</p>	
<p>PROJEKTANT/DESIGNER - MECHANICAL DESIGN</p> <p>Ing. Ardit FCO Sh.Nr. 4/2019</p>	
<p>PROJEKTANT/DESIGNER - ELECTRICAL DESIGN</p> <p>Ing. Almir MIRON Sh.Nr. 4/2019</p>	
<p>PROJEKTANT/DESIGNER - CIVIL DESIGN</p> <p>Ing. Ardit ZHURJA Sh.Nr. 4/2019</p>	
<p>EMER I PROJEKTI / TITLE OF DESIGN</p> <p>IMPLEMENTATION DESIGN</p>	
<p>SHKALLA / SCALE</p> <p>1:100</p>	<p>SHIFRAT / CODES</p> <p>A-03</p>
<p>EMER I STRIPIT / STRIP NAME</p>	

SKEMA ELEKTRIKE AC

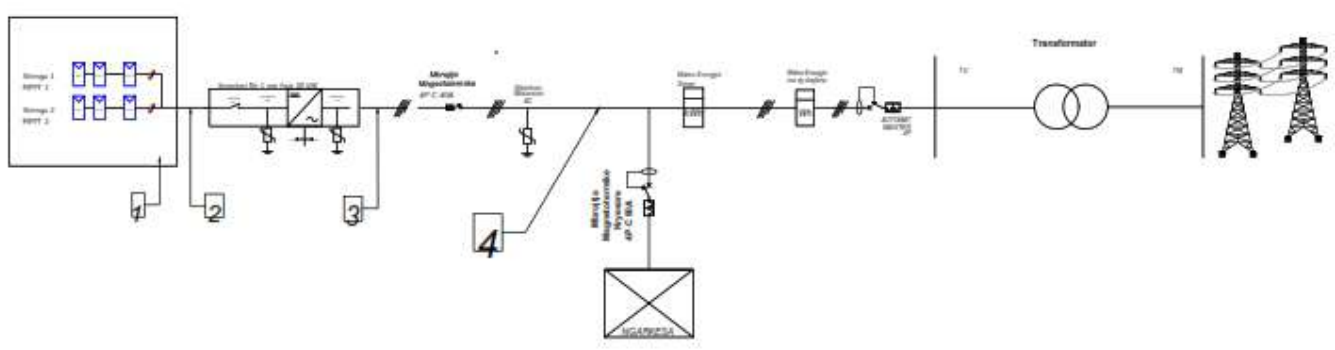

	
	
<p>PROJECT / PROJECT NAME</p> <p>"INSTALIMI I SISTEMIT FOTOVOLTAIK"</p>	
<p>PROJECT LOCATION</p> <p>SASHKHA MINDITZ</p>	
<p>PROJECT CONTRACTOR / PROJECT OWNER</p> <p>PROJEKT ZSATHI IMPLEMENTATION DESIGN</p>	
<p>PROJECT ARCHITECT / PROJECT ARCHITECTURE DESIGNER</p> <p>Ark. Haykondz MYDOLLARI</p>	
<p>PROJECT STRUCTURAL ENGINEER</p> <p>Ing. Vachag TURZH</p>	
<p>PROJECT ELECTRICAL ENGINEER</p> <p>Ing. Arayk FCR</p>	
<p>PROJECT MECHANICAL ENGINEER</p> <p>Ing. Albert MIGNI</p>	
<p>PROJECT ELECTRICAL PROJECT DESIGNER</p> <p>Ing. Vachag ZHURIA</p>	
<p>PROJECT TITLE / TITLE OF DESIGN</p> <p>SKEMA ELEKTRIKE AC</p>	
<p>SCALE</p> <p>1:100</p>	<p>PROJECT NUMBER</p> <p>A-04</p>
<p>DATE</p>	

SKEMA ELEKTRIKE E SISTEMIT TE MATJES

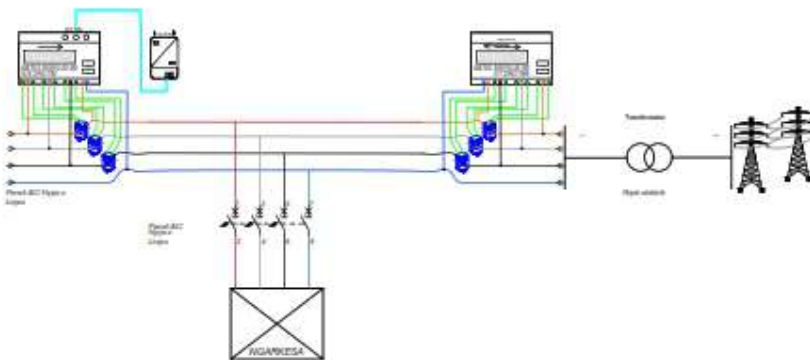

LEGJENDE	
	Inverter
	Transformer
	Distributimi
	Linja e Energjis
	Paneli Fotovoltaj
	Shprehja e Tokës
	Air Switch
	Shprehja e Tokës



ADRESA WEB: www.enr.al



SHKURIMET E SHKENCËVE SHKENCËR

PROJEKTI / PROJECT NAME
"INSTALIMI I SISTEMIT FOTOVOLTAIK"

ADRESA / LOCATION
BASHKIA MIRONDE

EMRI I PROJEKTI / PROJECT NAME
PROJEKTI ZBATIM I MBLERIMIT TË SHKENCËR

PROJEKTORESI / ARCHITECTURAL DESIGN
Ark. Ridvan MYDALLARI
 Nr. 4/2019
 Shk. 00000000000000000000

PROJEKTORESI / STRUCTURAL DESIGN
Ing. Rishaj TURDI
 Nr. 4/2019

PROJEKTORESI / MECHANICAL DESIGN
Ing. Arif FERI
 Nr. 4/2019

PROJEKTORESI / ELECTRICAL DESIGN
Ing. Almir MIRONI
 Nr. 4/2019

PROJEKTORESI / ELECTRICAL DESIGN
Ing. Rishaj ZHURIA
 Nr. 4/2019

EMRI I SHKENCËRIT / TITLE OF DESIGNER
SHKENCËRIT I SHKENCËRIT TË SHKENCËR

SHKURIMI / NUMBER
SHKURIMI

SHKURIMI / NUMBER
A-05

SHKURIMI / NUMBER
SHKURIMI

PROJEKTI FOTOVOLTAIK

OBJEKTI: "Ndriçimi Rruga Katund i Vjetër"

PROGRAMI: "Projektimi i Sistemit Fotovoltaik"

MBESHTETES: IPA II Cross Border Cooperation Programme for Albania- Kosovo

PERFITUES: Bashkia Mirditë



ZENIT&CO

Tiranë 2026



BASHKIA MIRDITE

PLANIMETRI E PËRGJITHËSHME E OBJEKTIT DHE STRUKTURES

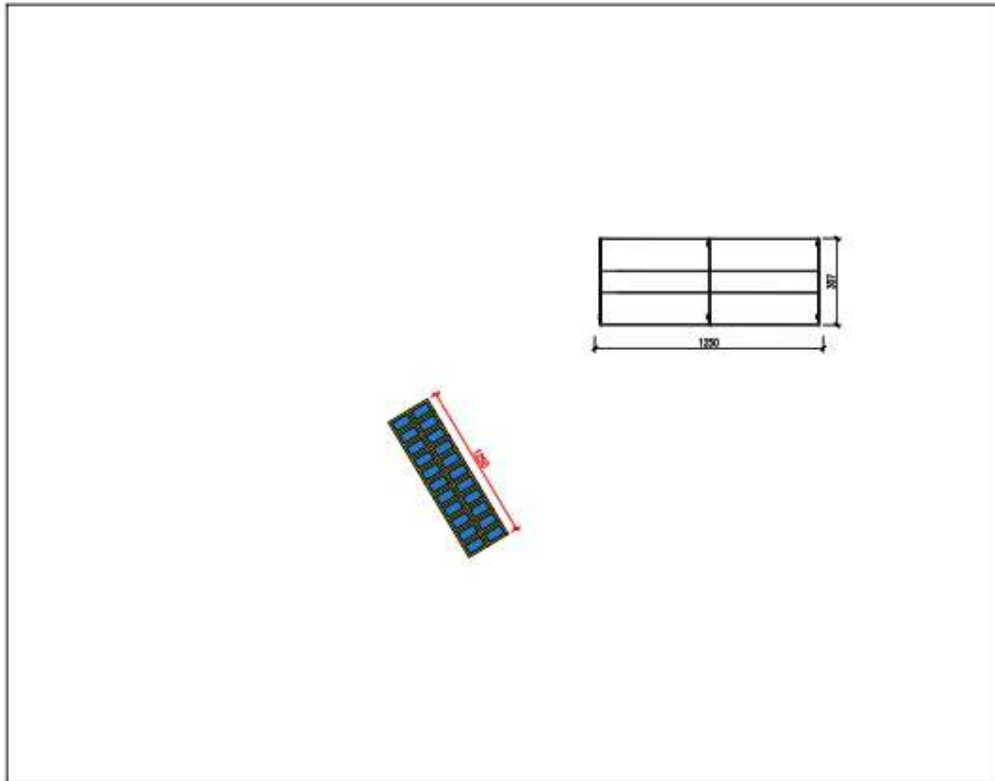

PROJEKTI I BASHKËPISË



ADRESA E OBJEKTIT: "PËRITËSIA"

PROJEKTI I BASHKËPISË



PROJEKTI I BASHKËPISË

PROJEKTI I BASHKËPISË

PROJEKTI I BASHKËPISË

PROJEKTI I BASHKËPISË

"INSTALIMI I SISTEMIT FOTOVOLTAIK"

PROJEKTI I BASHKËPISË

ADRESA E OBJEKTIT: "PËRITËSIA"

PROJEKTI I BASHKËPISË

PROJEKTI I BASHKËPISË

PROJEKTI I BASHKËPISË

PROJEKTI I BASHKËPISË

PROJEKTI I BASHKËPISË

PROJEKTI I BASHKËPISË

PROJEKTI I BASHKËPISË

PROJEKTI I BASHKËPISË

PROJEKTI I BASHKËPISË

PROJEKTI I BASHKËPISË

PROJEKTI I BASHKËPISË

PROJEKTI I BASHKËPISË

PROJEKTI I BASHKËPISË

PROJEKTI I BASHKËPISË

PROJEKTI I BASHKËPISË

PROJEKTI I BASHKËPISË

PROJEKTI I BASHKËPISË

PROJEKTI I BASHKËPISË

PROJEKTI I BASHKËPISË

PROJEKTI I BASHKËPISË

PROJEKTI I BASHKËPISË

PROJEKTI I BASHKËPISË

PROJEKTI I BASHKËPISË

PROJEKTI I BASHKËPISË

PROJEKTI I BASHKËPISË

PROJEKTI I BASHKËPISË

PROJEKTI I BASHKËPISË

PROJEKTI I BASHKËPISË

PROJEKTI I BASHKËPISË

PROJEKTI I BASHKËPISË

PROJEKTI I BASHKËPISË

PROJEKTI I BASHKËPISË

PROJEKTI I BASHKËPISË

PROJEKTI I BASHKËPISË

PROJEKTI I BASHKËPISË

PROJEKTI I BASHKËPISË

PROJEKTI I BASHKËPISË

PROJEKTI I BASHKËPISË

PROJEKTI I BASHKËPISË

PROJEKTI I BASHKËPISË

PROJEKTI I BASHKËPISË

PROJEKTI I BASHKËPISË

PROJEKTI I BASHKËPISË

PROJEKTI I BASHKËPISË

PROJEKTI I BASHKËPISË

PROJEKTI I BASHKËPISË

PROJEKTI I BASHKËPISË

PROJEKTI I BASHKËPISË

PROJEKTI I BASHKËPISË

PROJEKTI I BASHKËPISË

PROJEKTI I BASHKËPISË

PROJEKTI I BASHKËPISË

PROJEKTI I BASHKËPISË

PROJEKTI I BASHKËPISË

PROJEKTI I BASHKËPISË

PROJEKTI I BASHKËPISË

PROJEKTI I BASHKËPISË

PROJEKTI I BASHKËPISË

PROJEKTI I BASHKËPISË

PROJEKTI I BASHKËPISË

PLANIMETRI E PËRGJITHËSHME E STRINGAVE

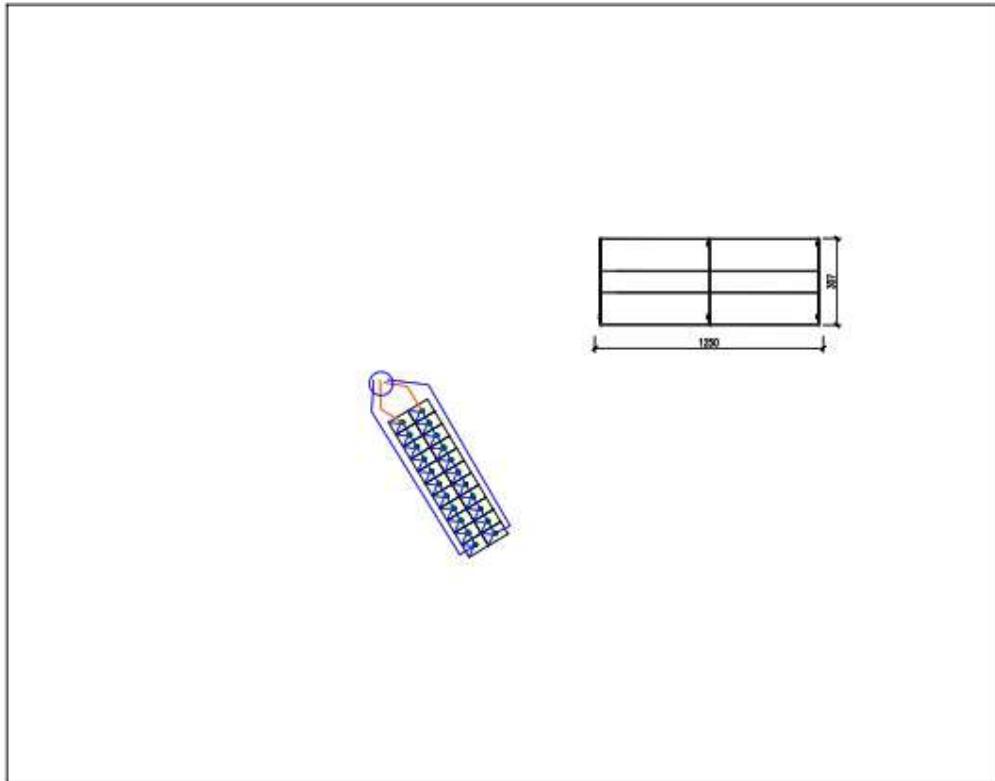

PROJEKTI I BASHKËPISHTET



ADRESA SHKURTË: PRISTINE

PROJEKTI I BASHKËPISHTET



PROJEKTI I BASHKËPISHTET

PROJEKTI I BASHKËPISHTET

PROJEKTI I BASHKËPISHTET

PROJEKTI I BASHKËPISHTET

"INSTALIMI I SISTEMIT FOTOVOLTAIK"

PROJEKTI I BASHKËPISHTET

BASHKËPISHTET

PROJEKTI I BASHKËPISHTET

PROJEKTI I BASHKËPISHTET

PROJEKTI I BASHKËPISHTET

PROJEKTI I BASHKËPISHTET

PROJEKTI I BASHKËPISHTET

PROJEKTI I BASHKËPISHTET

PROJEKTI I BASHKËPISHTET

PROJEKTI I BASHKËPISHTET

PROJEKTI I BASHKËPISHTET

PROJEKTI I BASHKËPISHTET

PROJEKTI I BASHKËPISHTET

PROJEKTI I BASHKËPISHTET

PROJEKTI I BASHKËPISHTET

PROJEKTI I BASHKËPISHTET

PROJEKTI I BASHKËPISHTET

PROJEKTI I BASHKËPISHTET

PROJEKTI I BASHKËPISHTET

PROJEKTI I BASHKËPISHTET

PROJEKTI I BASHKËPISHTET

PROJEKTI I BASHKËPISHTET

PROJEKTI I BASHKËPISHTET

PROJEKTI I BASHKËPISHTET

PROJEKTI I BASHKËPISHTET

PROJEKTI I BASHKËPISHTET

PROJEKTI I BASHKËPISHTET

PROJEKTI I BASHKËPISHTET

PROJEKTI I BASHKËPISHTET

PROJEKTI I BASHKËPISHTET

PROJEKTI I BASHKËPISHTET

STRUKTURA METALIKE

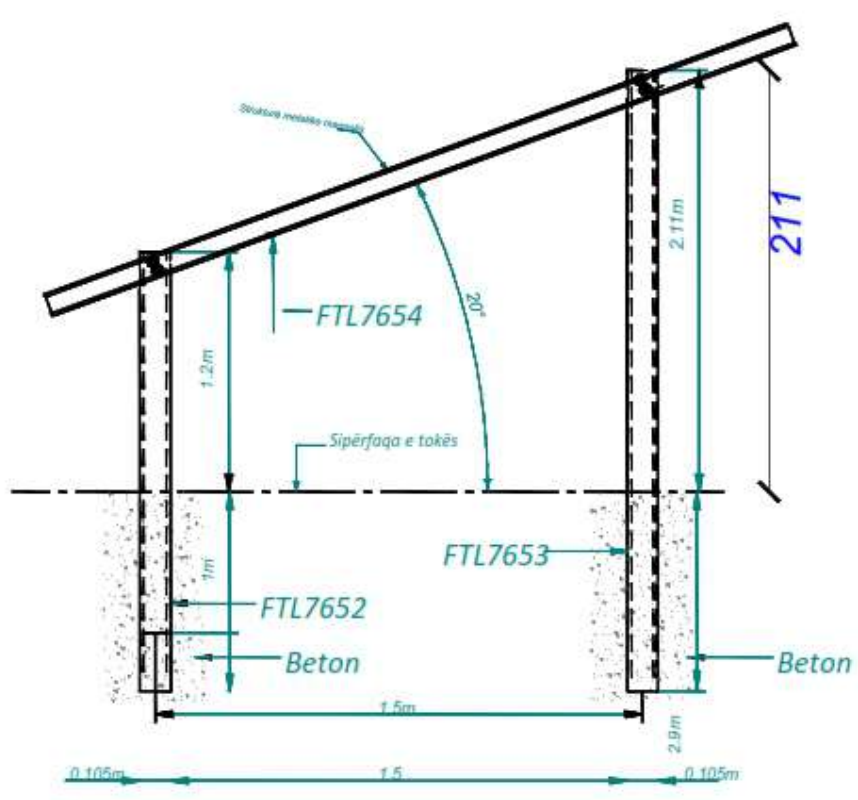

	
	
PROJECT / PROJECT NAME "INSTALIMI I SISTEMIT FOTOVOLTAIK"	
ZONË / LOCATION BASHKIA MIRONITË	
TITULLI I PROJEKTIT / PROJECT TITLE PROJEKT ZBATIM / IMPLEMENTATION DESIGN	
PROJEKTANT / ARCHITECTURAL DESIGNER Ark. Rajmonda MYDALLARI Nr. 4/2019	
PROJEKTANT / STRUCTURAL DESIGNER Ing. Reshat TUKER Nr. 4/2019	
PROJEKTANT / MECHANICAL DESIGNER Ing. Ardit FERI Nr. 4/2019	
PROJEKTANT / ELECTRICAL DESIGNER Ing. Almir MIRONI Nr. 4/2019	
PROJEKTANT / CIVIL DESIGNER Ing. Ardit ZHURJA Nr. 4/2019	
SHprehjet / TITLE OF DESIGN STRUKTURA METALIKE	
SHIFRA / CODE 0101	SHIFRA / CODE A-04
SHIFRA / CODE 0101	

SKEMA ELEKTRIKE AC

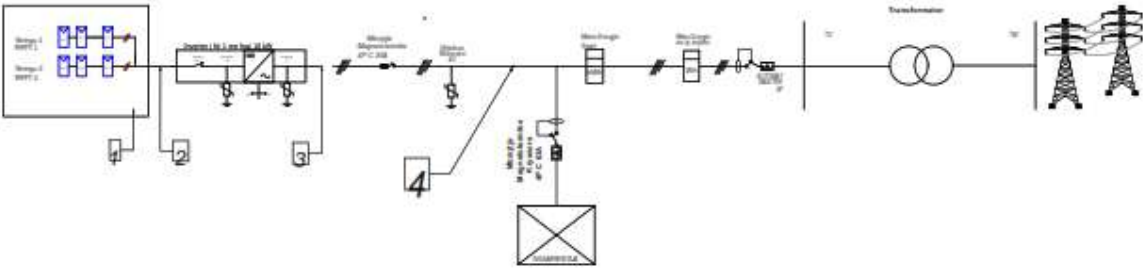

 <p>ARMENIA</p>	
 <p>ZENITACO</p>	
<p>PROJECT / PROJECT NAME</p> <p>"INSTALIMI I SISTEMIT FOTOVOLTAIK"</p>	
<p>TYPE / LOCATION</p> <p>BASHKIA MARDITZ</p>	
<p>DATE / PROJECT / PROJECT NAME</p> <p>PROJECT ZS/18/1</p> <p>IMPLEMENTATION DESIGN</p>	
<p>PROJECT ARCHITECTURE / ARCHITECTURAL DESIGN</p> <p>Ark. Nalbanda MYDOLLARI</p> <p>01.11.2018</p>	
<p>PROJECT STRUCTURE / STRUCTURAL DESIGN</p> <p>Ing. Vahag TURSI</p> <p>01.11.2018</p>	
<p>PROJECT MECHANICAL / MECHANICAL DESIGN</p> <p>Ing. Arayr FCSI</p> <p>01.11.2018</p>	
<p>PROJECT ELECTRICAL / ELECTRICAL DESIGN</p> <p>Ing. Albert MIGNI</p> <p>01.11.2018</p>	
<p>PROJECT ELECTRICAL / ELECTRICAL DESIGN</p> <p>Ing. Vahag ZHURIA</p> <p>01.11.2018</p>	
<p>PROJECT ELECTRICAL / ELECTRICAL DESIGN</p> <p>01.11.2018</p>	
<p>SCALE</p> <p>1:100</p>	<p>NO. OF SHEETS</p> <p>A-05</p>
<p>DATE</p> <p>01.11.2018</p>	
<p>PROJECT NAME</p> <p>"INSTALIMI I SISTEMIT FOTOVOLTAIK"</p>	

