



BASHKIA
TIRANË

DREJTORIA E PERGJITHSHME E PUNEVE PUBLIKE

PROJEKT - ZBATIM

PROJEKTI I RRJETIT TE K.U.B



PALMA CONSTRUCTION shpk
Projektim, mbikëqyrje dhe kolaudim punimesh ndertimi
Arkitekture, Struktura, Impiante dhe Infrastruktura

TIRANE 2019

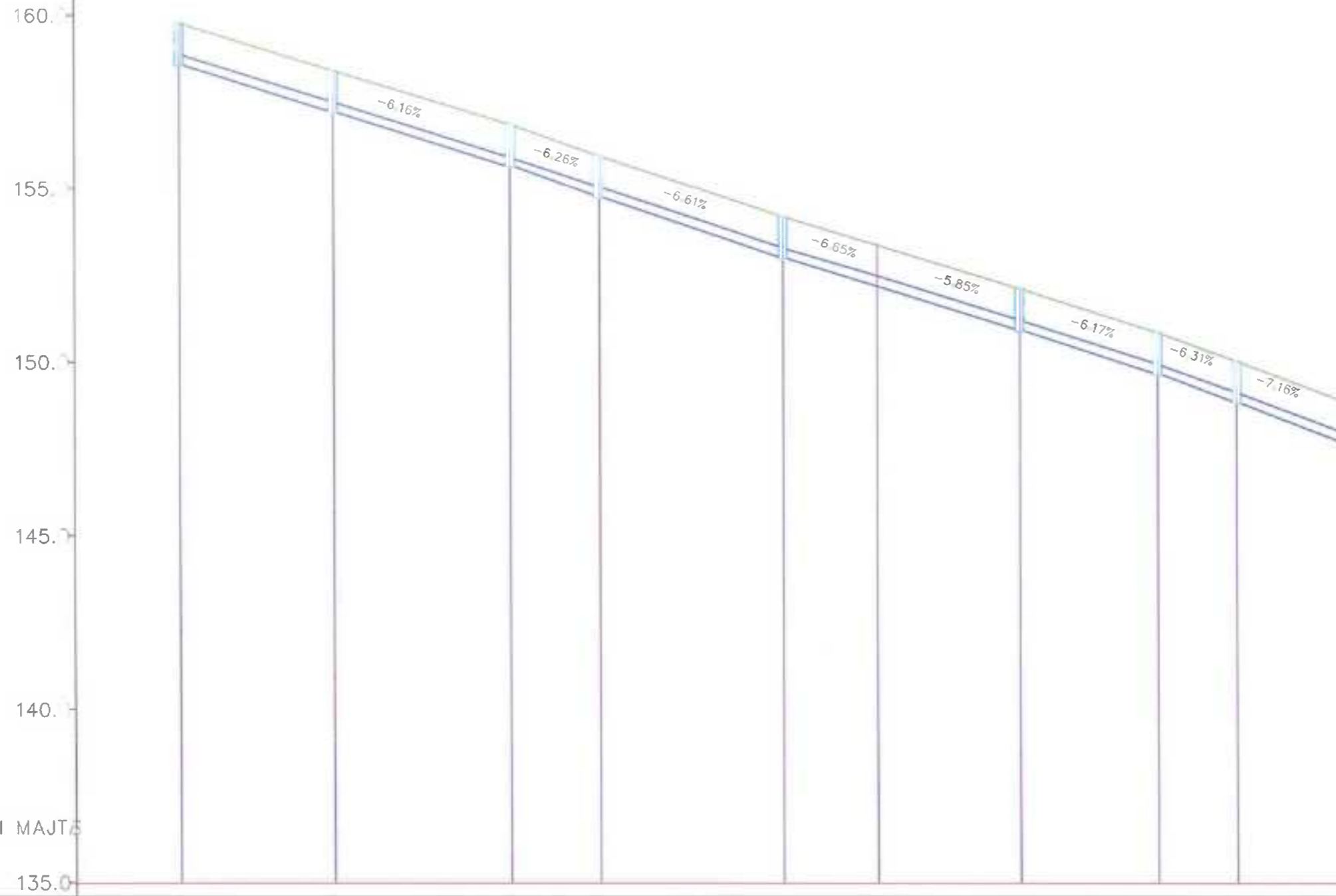

NUMERI PROFILIEVE	+017 Sc-2	+03 Sc-3	+06 Sc-4	+07 Sc-5	+104 Sc-6	+11 Sc-7	+13 Sc-8	+15 Sc-9	+17 Sc-1	
DISTANCA PROGRESIVE										
DISTANCA PJESORE	17,03	22,24	25,50	12,97	26,55	13,62	20,73	19,97	11,46	17,48
KUOTA E PROJEKTIT	58.5	57.2	55.6	54.7	52.9	52.1	50.9	49.6	48.8	
KUOTA E TERENIT	59.7	58.4	56.8	55.9	54.1	53.3	52.1	50.8	50.0	
KILOMETRAZHI										

Porosites	 BASHKIA E TIRANES DREJTORIA E PËRGJITHSHME E PUNEVE PUBLIKE	Vula
Projektues	 HE & SK 11 consulting company	Vula
Ing. Nd. A. VOGLI	Ing. Nd. M. MURTAJ	Ing. Nd. E. MURTAJ
Ing. Nd. M. MURTAJ	Ing. Nd. M. MURTAJ	Ing. Nd. M. MURTAJ
Projektues	 PALMA COSTRUCTION shpk Për krijimin, ndërtimin dhe mirëmbajtjen e infrastrukturës të rrugëve, ujësjellësve, kanalizimeve dhe telekomunikimit	Vula
Ing. Nd. V. GRUDA		

PROJEKTI: Rehabilitimi i rrugëve të bilokut që kufizohet nga rrugët "I eandro Zoto" - "Mari Kraja" - "Disha" - "Sadik Petrela"	EMERTIMI I FLETËS: Projekt-Zbatim Prerje Gjatesore KUB Rruga "Violeta Manushi" Majtas
Shkalla: 1:200	Numri i fletës: F-1

160.
155.
150.
145.
140.
135.0

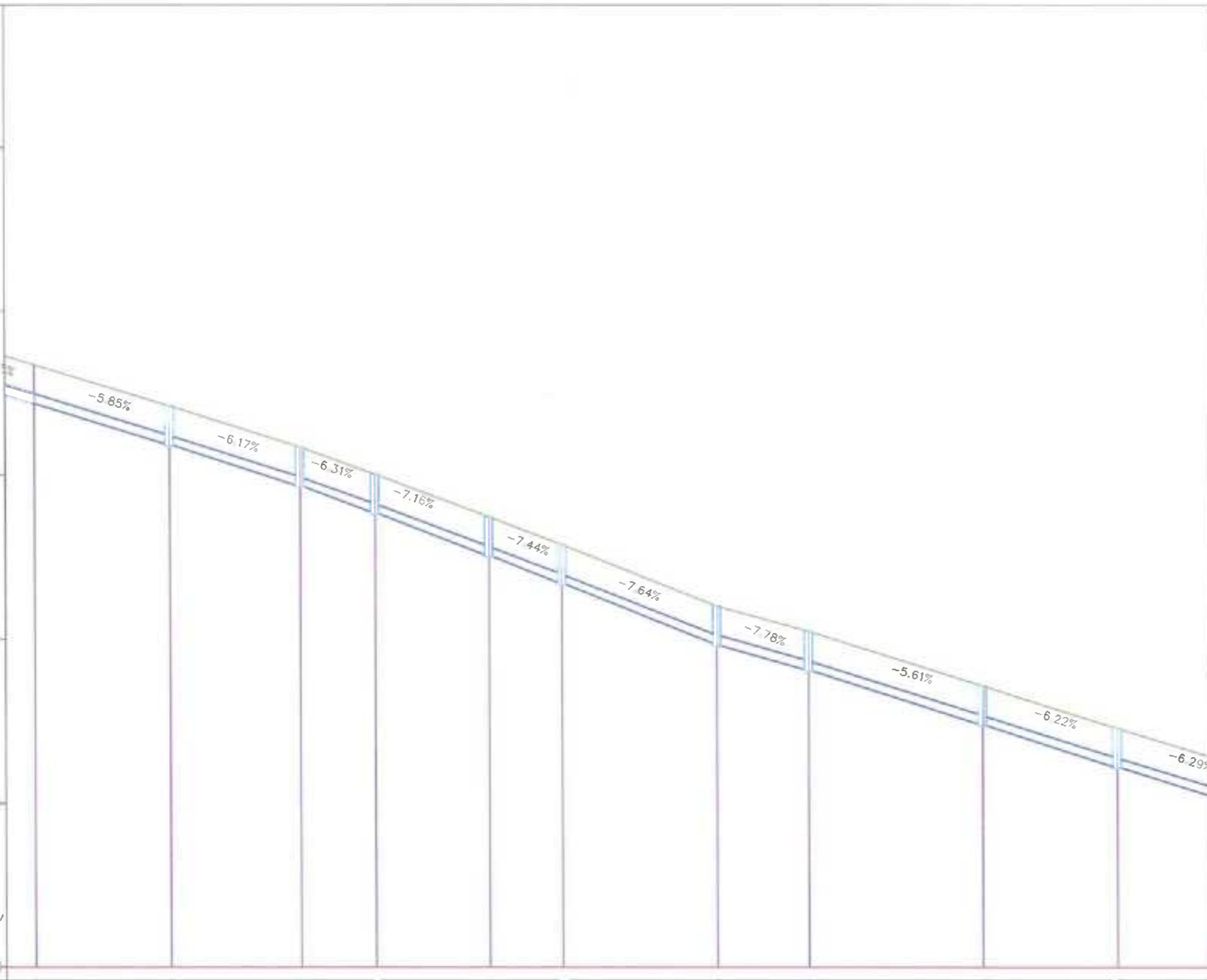

Profili : VIOLETA MANUSHI MAJT,
Shkalla : 1000:200
Kuota Ref : 135.00

NUMERI PROFILIEVE	Sc-7	Sc-8	Sc-9	Sc-10	Sc-11	Sc-12	Sc-13	Sc-14	Sc-15	Sc-16
DISTANCA PROGRESIVE	+118	+13	+15	+17	+18	+19	+22	+23	+26	+28
DISTANCA PJESORE	20,73	19,97	11,46	17,48	11,12	23,74	14,13	26,70	20,63	20,85
KUOTA E PROJEKTIT	52.1	50.9	49.6	48.8	47.5	46.6	44.8	44.0	42.3	41.0
KUOTA E TERENIT	53.3	52.1	50.8	50.0	48.7	47.8	46.0	45.2	43.5	42.3
KILOMETRAZHI										

Porosites	 BASHKIA E TIRANËS DREJTORIA E PËRQJITISIMIT E PUNEVE PUBLIKE	Vula	
Projektues	 HE & SK 11 consulting company	Vula	
Ing. Nd:	A VOGLI	Ing. Top:	F. BREGASI
Ing. Nd:	A. REFAJ	Ing. Mpk:	E. MUCAJ
Ing. Nd:	M. BEAJ	Ing. Elita N:	D. MANAJ
Projektues	 PALMA CONSTRUCTION shpk Arkitekturi, Shkollë, Transport, Mbrojtja e mjedisit	Vula	
Ing. Nd:	V. GRUDA		
PROJEKTI:	Rehabilitimi i rrugëve të bllokut që kufizohet nga rrugët "Leandio Zoto" - "Mari Kraja" - "Disha" - "Sadik Petrela"	EMËRTIMI I FLETËS:	Projekt-Zbatim Përje Gjatësore KUB Rruga "Violeta Manushi" Majtas
		Shkalla:	Numri i fletës:
		1:200	F-2

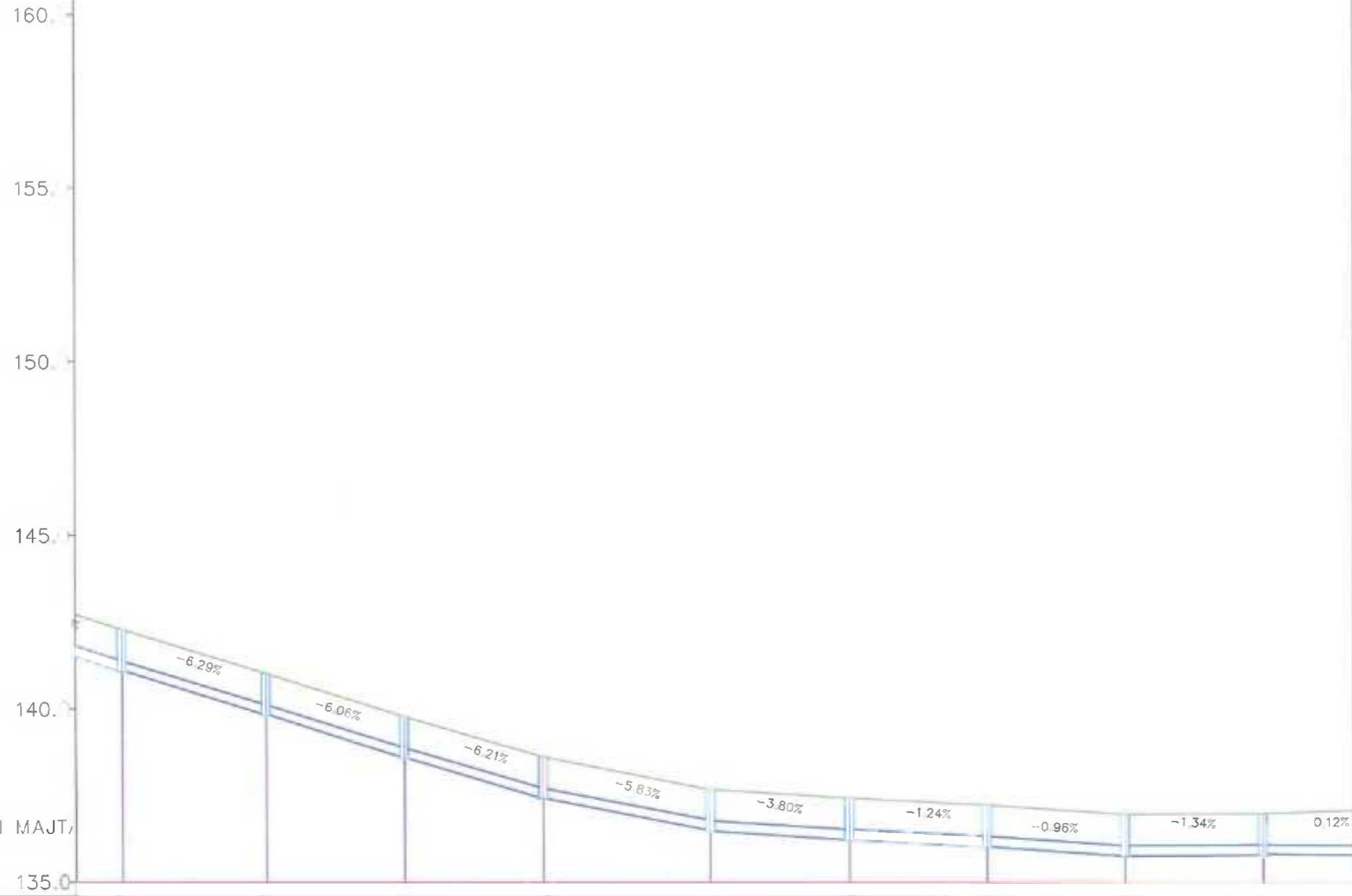

NUMERI PROFILIEVE	+28	+30	+32	+34	+36	+38	+40	+42	+44	
DISTANCA PROGRESIVE	16	17	18	19	20	21	22	23	24	
DISTANCA PJESORE		20,85	20,00	20,01	24,18	20,18	19,99	19,99	20,00	20,00
KUOTA E PROJEKTIT	141.0	139.8	138.5	137.4	136.5	136.2	136.0	135.7	135.8	
KUOTA E TERENIT	142.3	141.0	139.7	138.6	137.6	137.4	137.2	136.9	137.0	
KILOMETRAZHI										

<p>BASHKIA E TIRANES DREJTORIA E PERGJITHSHME E PUNIME PUBLIKE</p>		Vula
<p>HE & SK 11 consulting company</p>		Vula
Ing. Nd. A. VOGLI	Ing. Topi F. BREGASI	
Ing. Nd. A. REFATHE	Ing. M. MUCAJ	
Ing. Nd. M. B. ...	Ing. Ele. K. BASHAJ	
<p>PALMA CONSTRUCTION shpk Projektim, ndërtim dhe shërbime të bashkuara Arhitektura, Struktura, Inxhinjeri dhe Infrastrukturë</p>		Vula
Ing. Nd. V. GRUDA		
PROJEKTI: Rehabilitimi i rrugëve të bllokut që kufizohet nga rrugët "Leandro Zoto" - "Mari Kraja" - "Disha" - "Sadik Petrela"		EMERTIMI I FLETES: Projekt-Zbatim Përje Gjatesore KUB Rruga "Violeta Manushi" Majtas
Shkalla: 1:200		Numri i fletes: F-3

160.0
155.0
150.0
145.0
140.0
135.0

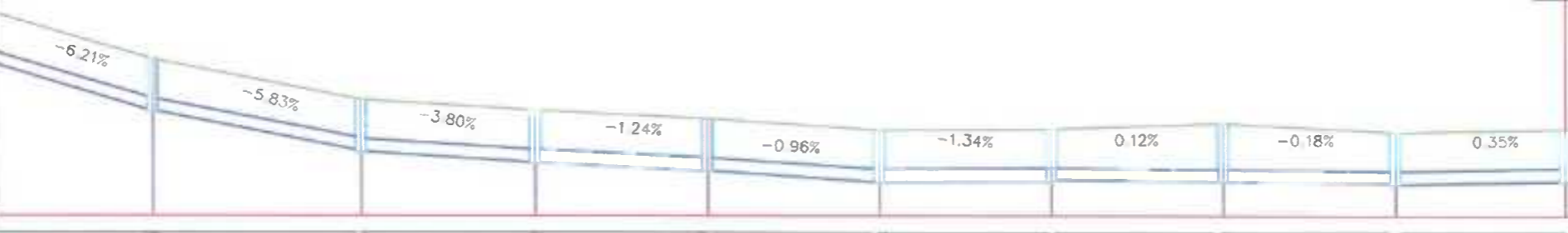

Profili : VIOLETA MANUSHI MAJT,
Shkalla : 1000:200
Kuota Ref : 135.00

NUMERI PROFILIEVE									
ISTANCA PROGRESIVE	+34	+36	+38	+40	+42	+44	+46	+48	
DISTANCA PJESORE	20,01	24,18	20,18	19,99	19,99	20,00	20,00	20,02	19,69
KUOTA E PROJEKTIT	37.4	36.5	36.2	36.0	35.7	35.8	35.7	35.7	
KUOTA E TERENIT	38.6	37.6	37.4	37.2	36.9	37.0	37.1	36.9	
KILOMETRAZHI									

Porosites	 BASHKIA E TIRANES DIREKTORIA E PERQUTITSHME E PUNEVE PUBLIKE		Vula
Projektues	 HE & SK 11 consulting company		Vula
Ing. Nd. A. VOGLI	Ing. Top. F. BREGASI		
Ing. Nd. A. REFATULLAJ	Ing. Mek. E. MOUJAJ		
Ing. Nd. M. ...	Ing. Elek. ...		
Projektues	 PALMA CONSTRUCTION shpk Projektim, inzheneri dhe kontraktim punimesh ndihmese Arkitekture, Struktura, Inzheneri dhe Infrastruktura		Vula
Ing. Nd. V. GRUDA			
PROJEKTI:	Reabilitimi i rruges te bllokut qe kufizohet nga rrugët "L. eandro Zoto" - "Mari Kraja" - "Disha" - "Sadik Petrela"		
EMERTIMI I FLETES:	Projekt-Zbatim Prerje Gjatesore KUB Rruga "Violeta Manushi" Mjtas		
	Shkalla: 1:200	Numri i fletes: F-4	

Profili : VIOLETA MANUSHI DJATHTAS
 Shkalla : 1000:200
 Kuota Ref : 130.00

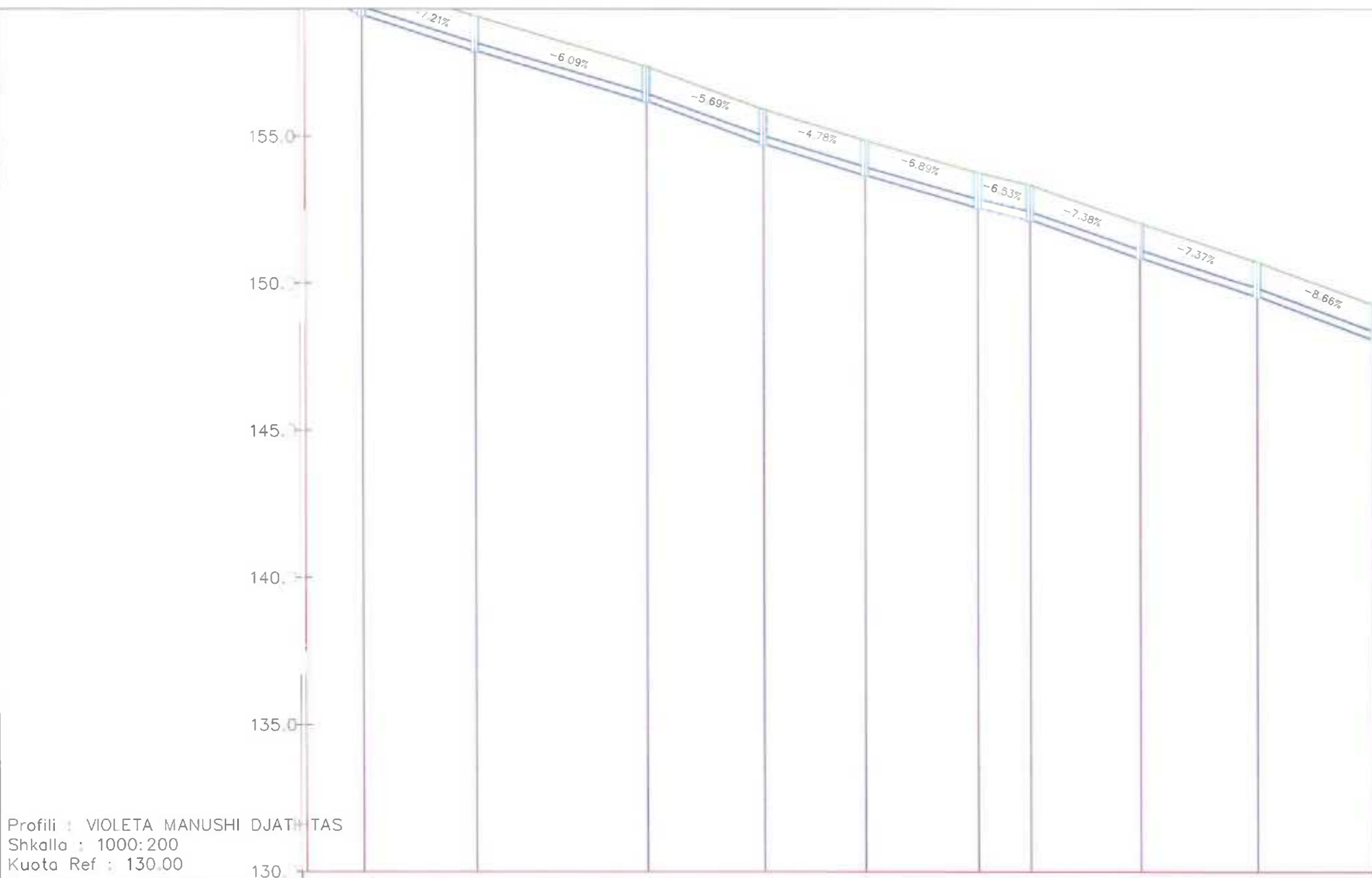

NUMERI PROFILIEVE	Sc-2										
DISTANCA PROGRESIVE	+01	+02	+05	+07	+09	+115	+124	+143	+163	+183	
DISTANCA PJESORE	9,81	19,29	29,14	19,98	17,27	19,32	8,97	18,83	20,00	20,00	
KUOTA E PROJEKTIT	59.1	57.8	56.1	54.7	53.6	52.5	52.1	50.8	49.5	48.0	
KUOTA E TERENIT	60.3	59.0	57.3	55.9	54.8	53.7	53.3	52.0	50.7	49.2	
KILOMETRAZHI	0										

Porosites	 BASHKIA E TIRANES DREJTORIA E PERQJITHISME E PUNEVE PUBLIKE		Vula
Projektues	 HE & SK 11 consulting company		Vula
Ing. Nd. A. V. GRUDA	Ing. Top. F. BR. GASI		
Ing. Nd. A. REFATLLARI	Ing. Mek. E. MU. AJ		
Ing. Nd. M. BE. AJ	Elek. M. ANAJ		
Projektues	 PALMA CONSTRUCTION shpk <small>Shkurtim i ndërtimit dhe kontraktimit të punëve të ndërtimit</small> <small>Adresa: Sh. "Aurora", Inq. "Dëshmorët e Kosovës"</small>		Vula
Ing. Nd. V. GRUDA			
PROJEKTI:	Rehabilitimi i rrugëve të bilokut që kufizohet nga rrugët "Leandro Zoto" - "Mari Kraja" - "Disha" - "Sadik Petrela"		
EMERTIMI I FLETES:	Projekt-Zbatim Prerje Gjatesore KUB Rruga "Violeta Manushi" Djathtas		
	Shkalla: 1:200	Numri i fletes: F-1	

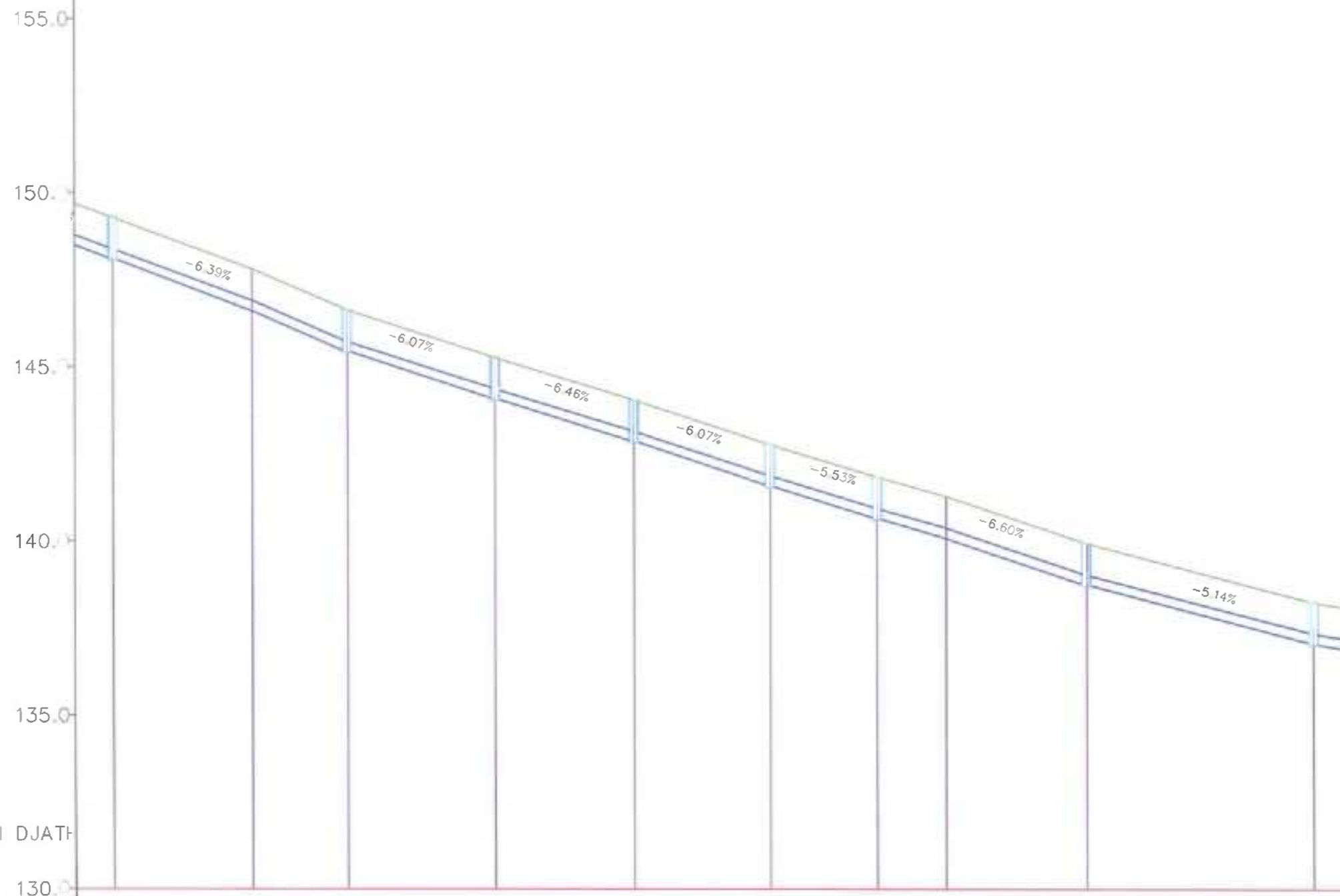

Profili : VIOLETA MANUSHI DJATH
 Shkalla : 1000:200
 Kuota Ref : 130.00

NUMERI PROFILIEVE	11	12	13	14	15	16	17	18	19	20
ISTANCA PROGRESIVE	+183	+203	+216	+233	+253	+277	+293	+303	+323	+353
DISTANCA PJESORE		20,00	13,76	21,28	19,99	19,64	15,45	10,01	20,36	32,77
KUOTA E PROJEKTIT	49.27	48.0	47.8	46.6	45.4	44.0	42.8	41.5	40.6	40.0
KUOTA E TERENIT	49.27	48.0	47.8	46.6	45.4	44.0	42.8	41.5	40.6	40.0
KILOMETRAZHI										

Porosites	 BASHKIA E TIRANES DREJTORIA E PERGJITHSHME E PUNEVE PUBLIKE		Vula
Projektues	 HE & SK 11 consulting company		Vula
Ing. Nd.	A. VOGLI	Ing. Top.	F. BREGASI
Ing. Nd.	A. REFATLLARI	Ing. Mek.	E. MURAJ
Ing. Nd.	M. BEDAJ	Ing. Kark.	N. DANAJ
Projektues	 PALMA CONSTRUCTION shpk <small>Flisim, Rr. D. Hoxha, Nr. 10, T. 1105, Sh. 11</small> <small>Adresa: Shkollor, rrethi i M. Kallmet</small>		Vula
Ing. Nd.	V. GRUDA		
PROJEKTI:	Rehabilitimi i rrugëve të bllokut që kufizohet nga rrugët "Leandro Zoto" - "Mari Kraja" - "Disha" - "Sadik Petrela"		EMERTIMI I FLETES:
			Projekt-Zbatim Prerje Gjatesore KUB Rruga "Violeta Manushi" Djathtas
	Shkalla:	1:200	Numri i fletes:
			F-2

155.0
150.0
145.0
140.0
135.0
130.0

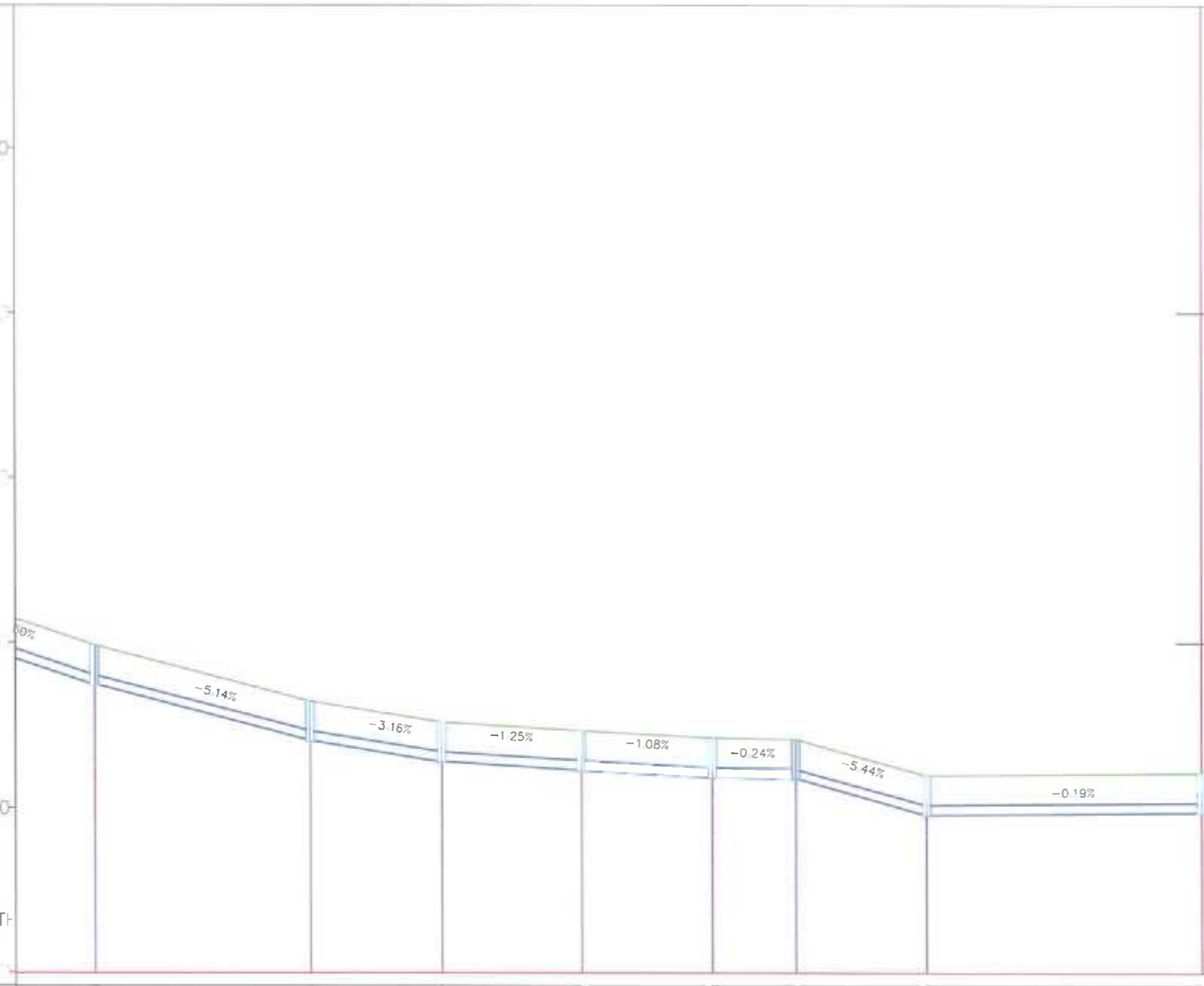

Profili : VIOLETA MANUSHI DJATHAS
Shkalla : 1000:200
Kuota Ref : 130.00

NUMERI PROFILIEVE	+32	+35	+37	+39	+41	+43	+45	
ISTANCA PROGRESIVE	c-1	c-2	c-2	c-2	c-2	c-2	c-2	
DISTANCA PJESORE	36	32,77	20,02	21,29	20,00	12,69	20,02	41,95
KUOTA E PROJEKTIT	38.7	37.0	36.4	36.1	35.9	35.8	34.7	
KUOTA E TERENIT	39.9	38.2	37.6	37.3	37.1	37.0	35.9	
KILOMETRAZHI								

Porosites BASHKIA E TIRANES DREJTORIA E PERCJITHSHME E PUNEVE PUBLIKE		Vula
Projektues HE & SK 11 consulting company		Vula
Ing. Nd: A. VOGLI	Ing. Top: F. BREGASI	
Ing. Nd: A. REFATLARI	Ing. Mek: E. MUCAJ	
Ing. Nd: M. BEDAJ	Ing. Elek: N. D. PAJ	
Projektues PALMA CONSTRUCTION shpk Projektim, inzhinjering, kontraktim, menaxhim, edukim, arkitektur, shkolle, organizim dhe infrastruktur		Vula
Ing. Nd: V. GRUDA		
PROJEKTI: Rehabilitimi i rrugëve të bllokut që kufizohet nga rrugët "Leandro Zoto" - "Mari Kraja" - "Disha" - "Sadik Petrela"		EMERTIMI I FLETES: Projekt-Zbatim Prerje Gjatesore KUB Rruga "Violeta Manushi" Djathas
Shkalla: 1:200		Numri i fletes: F-3

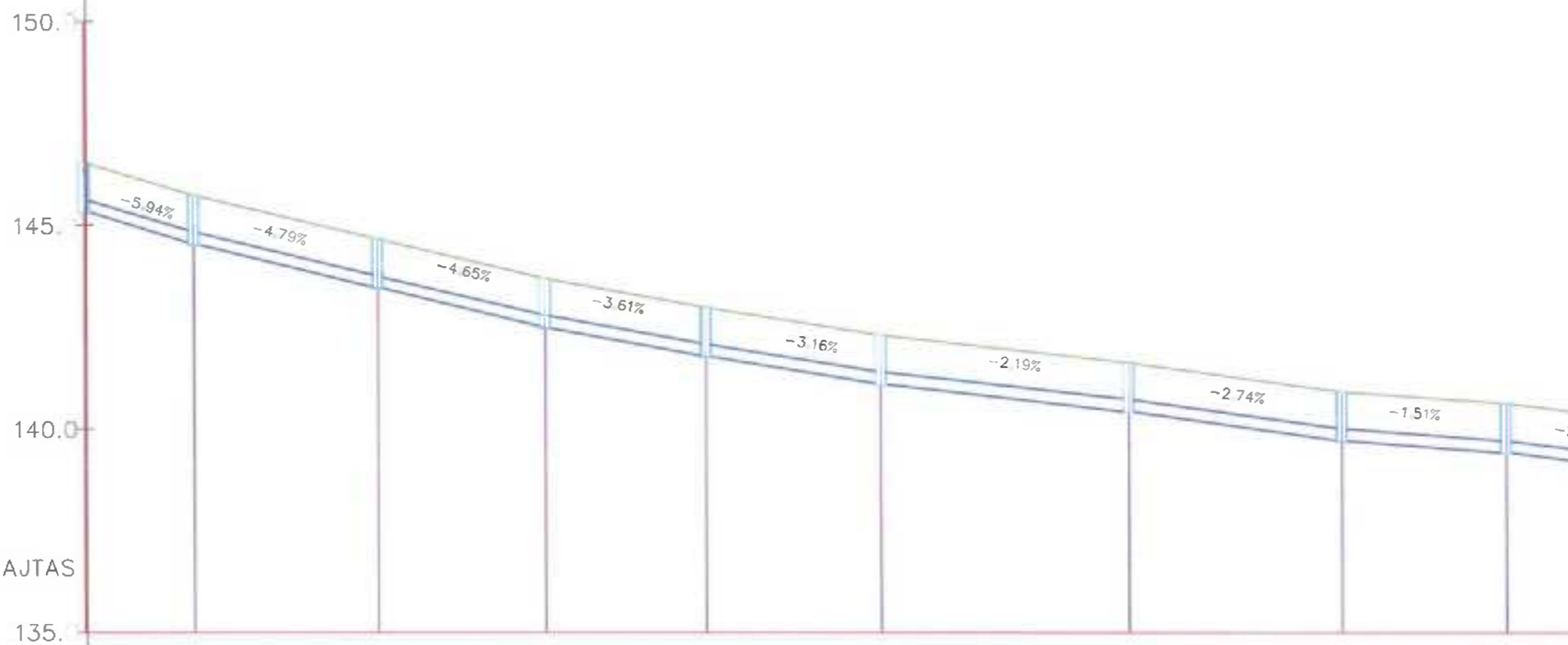

Profili : LEANDRO ZOTO MAJTAS
 Shkalla : 1000:200
 Kuota Ref : 135.00

NUMERI PROFILIEVE									
ISTANCA PROGRESIV	+01	+03	+05	+07	+09	+12	+15	+17	
DISTANCA PJESORE	13,40	22,69	20,58	19,77	21,64	30,63	26,25	20,31	2,00
KUOTA E PROJEKTIT	44.5	43.4	42.5	41.7	41.1	40.4	39.7	39.4	
KUOTA E TERENIT	45.7	44.6	43.7	42.9	42.3	41.6	40.9	40.6	
KILOMETRAZHI									

Porosites	 BASHKIA E TIRANËS DREJTORIA E PËRQIJTISHMË E TUNEVË PUBLIKE		Vula
Projektues	 HE & SK 11 consulting company		Vula
Ing. Nd. A. VOGLI	Ing. T. P. REGASI		
Ing. Nd. A. FEFATI	Ing. M. M. MUSA		
Ing. Nd. M. B. BASHA	Ing. Elek. H. H. HAJ		
Projektues	 PALMA CONSTRUCTION shpk Projektues, inzhinjeri dhe kontraktues punimesh ndërtimesh Arkitekture, Strukturore, Transport dhe Infrastrukturore		Vula
Ing. Nd. V. GRUDA			
PROJEKTI:	Reabilitimi i rrugeve të bllokut që kufizohet nga rrugët "Leandro Zoto" - "Mari Kraja" - "Disha" - "Sadik Petrela"		EMËRTIMI I FLETËS:
			Projekt-Zbatim Përje Gjatesore KUB Rruga "Leonard Zoto" Majtas
	Shkalla:	Numri i fletës:	
	1:200	F-1	

Profili : LEANDRO ZOTO MAJTAS
 Shkalla : 1000:200
 Kuota Ref : 135.00

150.
145.
140.0
135.

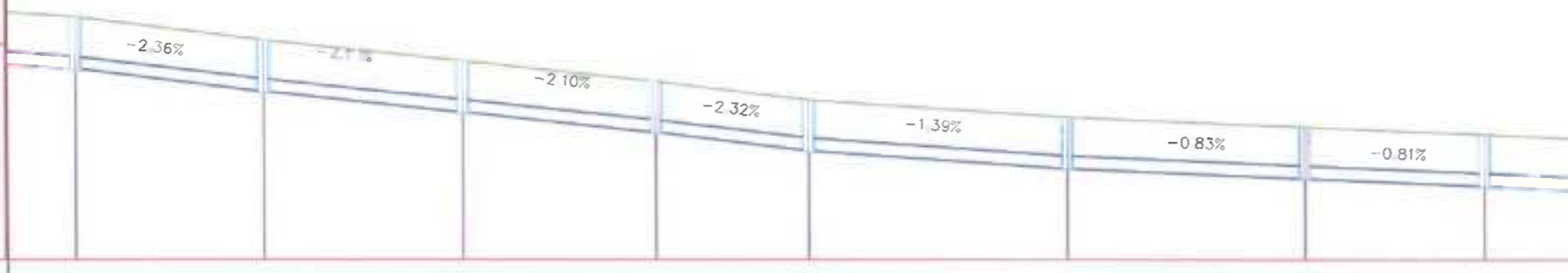

NUMERI PROFILIEVE	Sc-9	Sc-10	Sc-11	Sc-12	Sc-13	Sc-14	Sc-15	Sc-16
DISTANCA PROGRESIVE	+175	+197	+22	+24	+26	+29	+31	+34
DISTANCA PJESORE	21,94	23,27	22,52	17,90	30,31	27,77	21,03	
KUOTA E PROJEKTIT	39.4	38.9	38.4	37.9	37.5	37.1	36.8	36.7
KUOTA E TERENIT	40.6	40.1	39.6	39.1	38.7	38.3	38.0	37.9
KILOMETRAZHI								

Porosites	 BASHKIA E TIRANËS DREKTORIA E PËRQUTITSHMË E PUNËVE PUBLIKE		Vula
Projektues	 HE & SK 11 consulting company		Vula
Ing. Nd. A. VOGLI	Ing. Nd. A. BEFATLLARI	Ing. Mek. E. MOCANJ	REGASI
Ing. Nd. M. BEFATLLARI	Ing. Elek. N. DANAJ		
Projektues	 PALMA CONSTRUCTION shpk Projektim, ndërtim dhe mirëmbajtje të infrastrukturës Arkitekturë, Struktura, Inxhinjeri dhe Infrastukturë		Vula
Ing. Nd. V. GRUDA			
PROJEKTI:	Rehabilitimi i rrugëve të bllokut që kufizohet nga rrugët "Leandro Zoto" - "Mari Kraja" - "Disha" - "Sadik Petrela"		EMËRTIMI I FLETËS: Projekt-Zbatim Prerje Gjatesore KUB Rruga "Leonard Zoto" Majtas
	Shkalla: 1:200	Numri i fletës: F-2	

Profili : LEANDRO ZOTO MAJTAS
 Shkalla : 1000:200
 Kuota Ref : 135.00

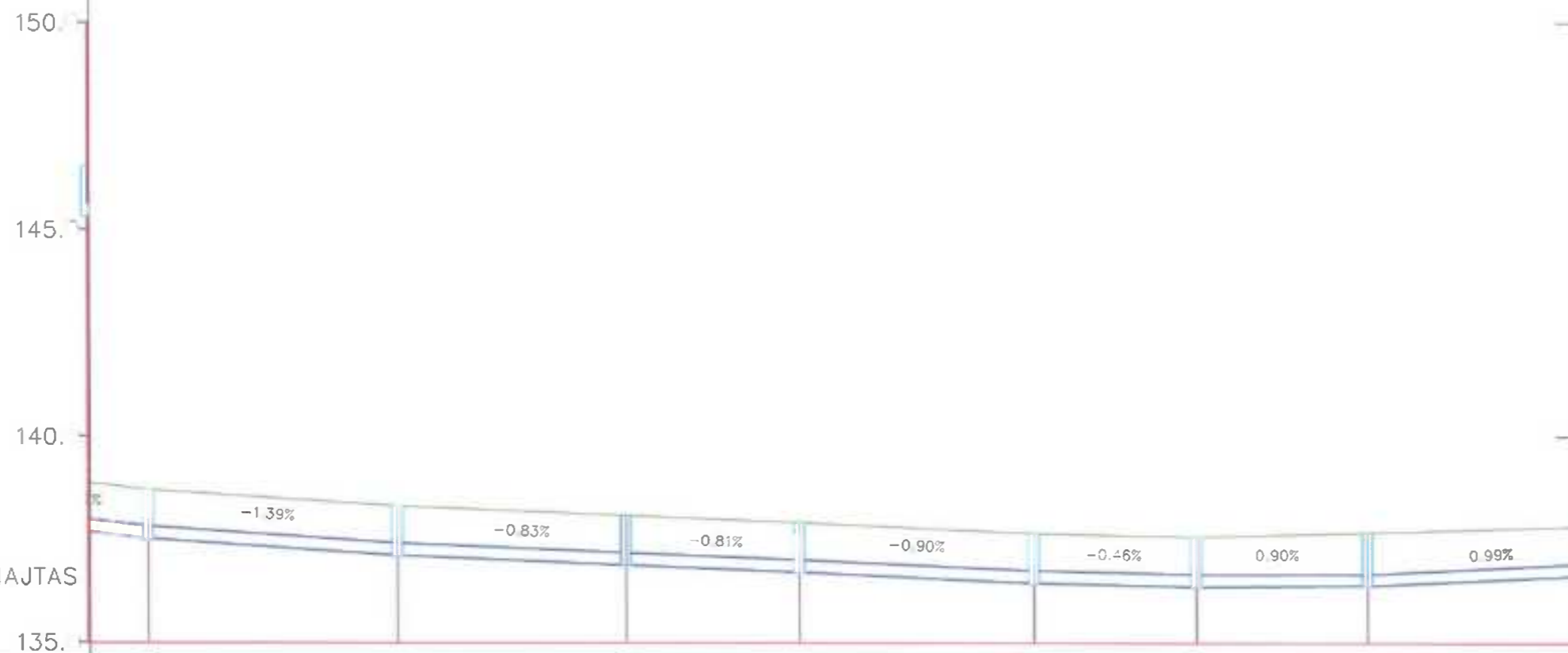

NUMERI PROFILIEVE	+26.31	+29.62	+31.13	+34.44	+36.34	+38.24	+40.15	
DISTANCA PROGRESIVE	0	26.31	55.92	90.36	126.70	164.94	205.09	
DISTANCA PJESORE	0	30,31	27,77	21,03	28,56	19,80	20,89	26,75
KUOTA E PROJEKTIT	137.5	137.1	136.8	136.7	136.4	136.3	136.3	136.3
KUOTA E TERENIT	138.7	138.3	138.0	137.9	137.6	137.5	137.6	137.6
KILOMETRAZHI	0	0.03	0.05	0.07	0.10	0.13	0.15	0.17

Porosites	 BASHKIA E TIRANËS DREJTORIA E PËRGJITHSHME E PUNËVE PUBLIKE		Vula
Projektues	 HE & SK 11 consulting company		Vula
Ing. Nd:	ING. G. G. G. G.	Ing. Top:	F. BREGASI
Ing. Nd:	A. R. FATLLARI	Ing. Mek:	E. MUJAJ
Ing. Nd:	M. BEDAJ	Ing. N. DANAJ	
Projektues	 PALMA CONSTRUCTION shpk Rruga "Leandro Zoto" Mahtas Tiranë, Shqipëri		Vula
Ing. Nd:	V. GRUDA		
PROJEKTI:	Rehabilitimi i rrugëve të bllokut që kufizohet nga rrugët "Leandro Zoto" - "Mari Kraja" - "Disha" - "Sadik Petrela"		EMËRTIMI I FLETËS:
			Projekt-Zbatim Prejje Gjatësore KUB Rruga "Leonard Zoto" Mahtas
	Shkalla:	1:200	Numri i fletës:
			F-3

Profili : ILIA SHYTI
 Shkalla : 1000:200
 Kuota Ref : 140.00

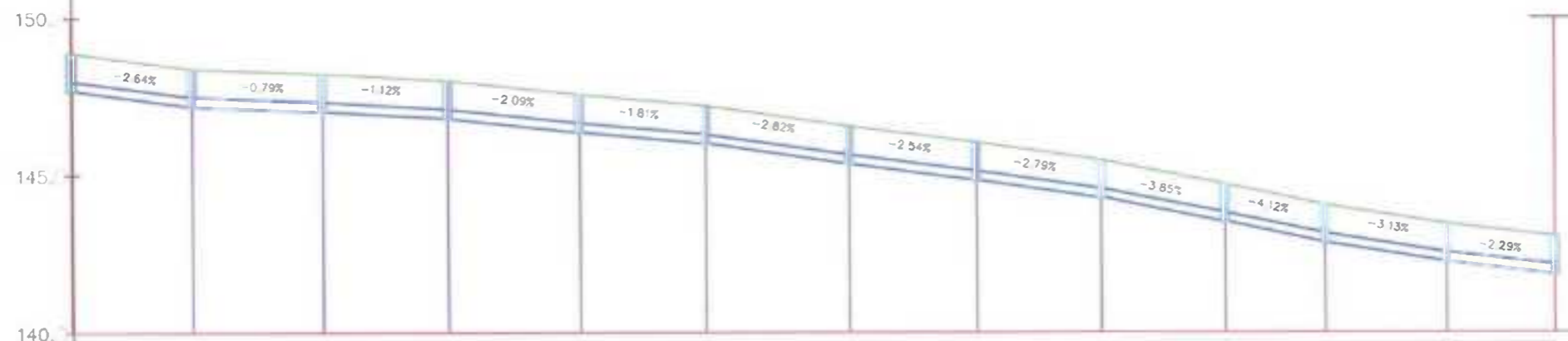

NUMERI PROFILIEVE		+01	+02	+03	+04	+05	+06	+07	+08	+09	+10	+11	+12	+13	+14	+15	+16	+17	+18	+19	+20	+21	
DISTANCA PROGRESIVE																							
DISTANCA PJESORE		18,98	20,72	19,95	20,90	20,02	22,78	20,33	19,80	19,85	15,90	19,27	17,31										
KUOTA E PROJEKTIT		47.1	47.0	46.8	46.3	46.0	45.3	44.8	44.2	43.5	42.8	42.2											
KUOTA E TERENIT		48.3	48.2	48.0	47.5	47.2	46.5	46.0	45.4	44.7	44.0	43.4											
KILOMETRAZHI																							

Porosites	 BASHKIA E TIRANES DREKTORIA E PERGJITHSIME E PUNEVE PUBLIKE		Vula
Projektues			Vula
Ing. Nd. A.V. BILI	Ing. To. ... REGASI		
Ing. N. ...	Ing. M. ... E. ... CAJ		
Ing. Nd. M. ...	Ing. E. ... DANAJ		
Projektues			Vula
Ing. Nd. V. GRUDA			
PROJEKTI: Rehabilitimi i rruges te bllokut qe kufizohet nga rrugët "Leandro Zoto" - "Miri Kraja" - "Disha" - "Sadik Petrela"		EMERTIMI I FLETES: Projekt-Zbatim Perje Gjatesore KUB Rruga "Ilia Shyti"	
		Shkalla: 1:275	Numri i fletes: F-1

Profili : ILIA SHYTI PJ-2
 Shkalla : 1000:200
 Kuota Ref : 140.00

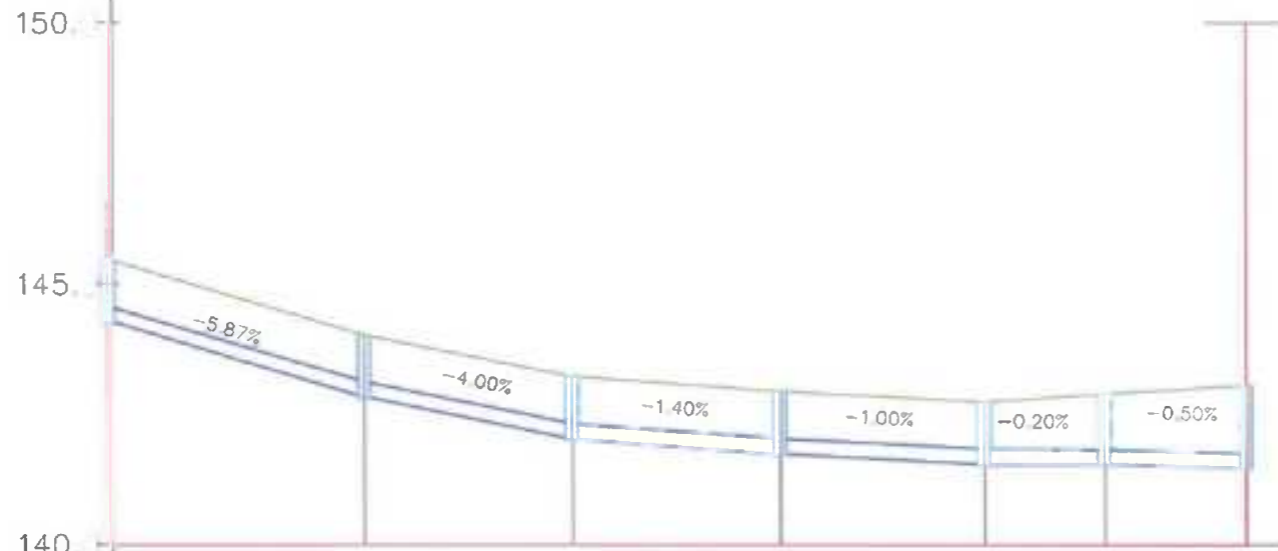

NUMERI PROFILIEVE						
DISTANCA PROGRESIV		+02.5 Sc-2	+04.5 Sc-3	+06.5 Sc-4	+08.4 Sc-5	+09.7 Sc-6
DISTANCA PJESORE	24,63	19,98	19,97	19,63	11,60	13,66
KUOTA E PROJEKTIT		42.8	42.0	41.7	41.5	41.5
KUOTA E TERENIT		44.0	43.2	42.9	42.7	42.9
KILOMETRAZHI						

Porosites	 BASHKIA E TIRANES DIREKTORIA E PËRGJITHSIME D. PUNEVE PUBLIKE		Vula
Projektues	 HE & SK 11 consulting company		Vula
Ing. Nd. A. VOGLM - IMPORT	Ing. F. F. REGASI		
Ing. Nd. A. REPELLA	Ing. M. K. E. MUCAJ		
Ing. Nd. M. E. TAJ	Ing. F. K. V. ANAJ		
Projektues	 PALMA CONSTRUCTION shpk Projektim, mbështetje dhe tu kuptim punimeve ndërtimore Arkitekture, Strukturë, Inxhinjeri dhe Inxhinjeri Urbanë		Vula
Ing. Nd. V. GRUDA			
PROJEKTI: Rehabilitimi i rrugëve të bllokut që kufizohet nga rrugët "Leandro Zoto" - "Mari Kraja" - "Disha" - "Sadik Petrela"	EMERTIMI I FLETES: Projekt-Zbatim Prerje Gjatesore KUB Rruga "Illa Shyti" Pj-2		
	Shkalla: 1:200	Numri i fletes: F-1	

Profili : VANGJUSH MIHO
 Shkalla : 1000/200
 Kuota Ref : 145.00

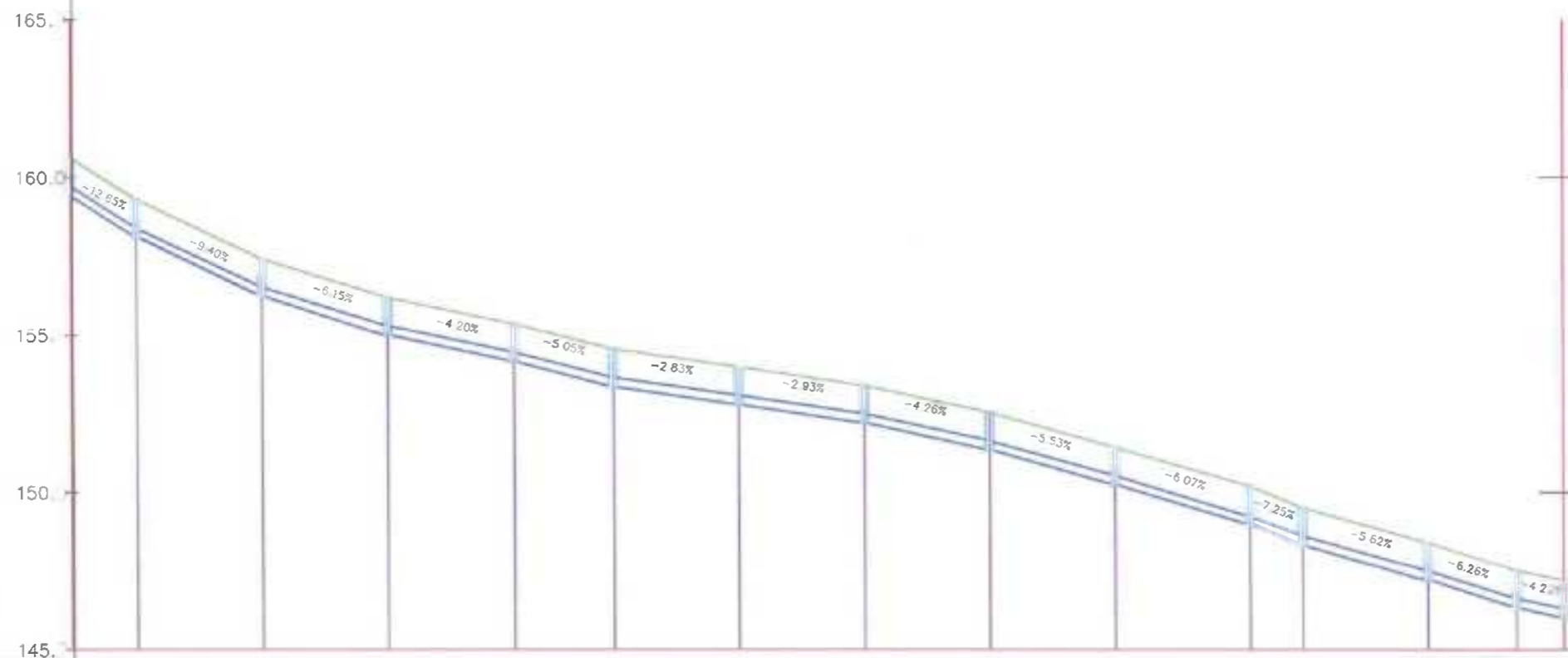

NUMERI PROFILIEVE	0+01	Sc-2	0+03	Sc-3	0+05	Sc-4	0+07	Sc-5	0+08	Sc-6	0+10	Sc-7	0+12	Sc-8	0+14	Sc-9	0+16	Sc-10	0+18	Sc-11	0+19	Sc-12	0+21	Sc-13	0+23	Sc-14	
DISTANCA PROGRESIV	0	10,52	19,99	20,00	20,00	15,85	19,99	19,95	20,00	20,00	21,57	8,38	20,00	14,10	7,57												
DISTANCA PJESORE		10,52	19,99	20,00	20,00	15,85	19,99	19,95	20,00	20,00	21,57	8,38	20,00	14,10	7,57												
KUOTA E PROJEKTIT		58.1	56.2	55.0	54.1	53.3	52.7	52.2	51.3	50.2	48.9	48.3	47.2	46.3													
KUOTA E TERENIT		59.3	57.4	55.2	55.3	54.5	54.0	53.4	52.5	51.4	50.2	49.5	48.4	47.5													
KILOMETRAZHI																											

Porosites	Vula
 BASHKIA E TIRANËS DREJTORIA E PËRCËFTISHMË E PUNËVE PUBLIKE	Vula
Projektues	Vula
 HE & SK 11 consulting company	Vula
Ing. Nd. A. REFATELLARI	Ing. T. MEGASI
Ing. Nd. M. EDIAJ	Ing. Mek. M. CAJ
Ing. Nd. M. EDIAJ	Ing. Elg. N. DANAJ
Projektues	Vula
 PALMA CONSTRUCTION shpk Pajtim dhe ndërtim civil dhe infrastrukturë	Vula
Ing. Nd. V. GRUDA	

PROJEKTI: Rehabilitimi i rrugëve të bllokut që kufizohet nga rrugët "I candro Zoto" - "Mari Kraja" - "Disha" - "Sadik Petrela"	EMERTIMI I FLETËS: Projekt-Zbatim Përre Gjatesore KUB Rruga "Vangjush Miho"
Shkalla: 1:275	Numri i fletës: F-1

Profil : NAMIK RESULI
Shkalla : 1000:200
Kuota Ref : 145.00

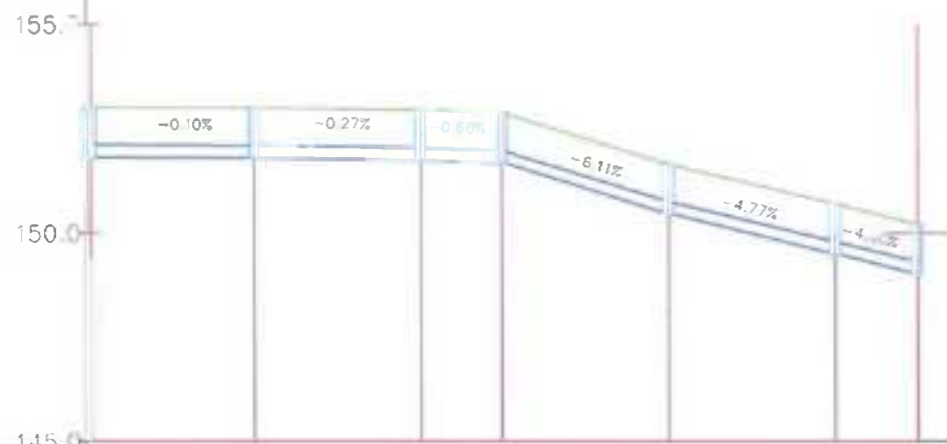

NUMERI PROFILIEVE						
DISTANCA PROGRESIV	+02	+04	+04	+06	+08	
DISTANCA PJESORE	19,65	20,05	9,72	20,00	20,00	9,98
KUOTA E PROJEKTIT	51.8	51.7	51.6	50.4	49.5	
KUOTA E TERENIT	53.0	52.9	52.8	51.6	50.7	
KILOMETRAZHI						

Profil : GENC LEKA
Shkalla : 1000:200
Kuota Ref : 145.00

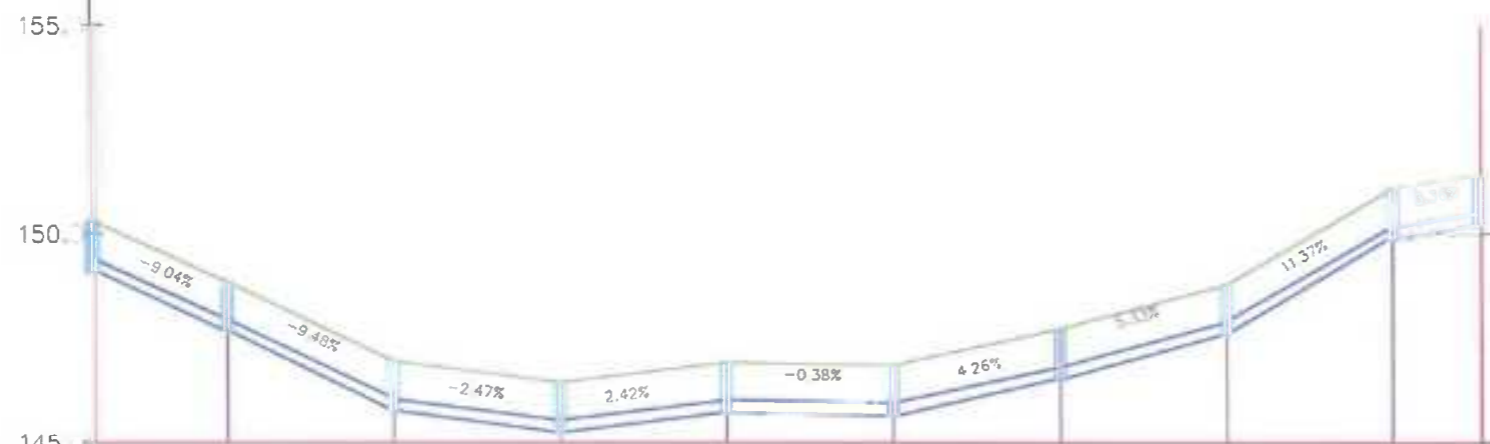

NUMERI PROFILIEVE									
DISTANCA PROGRESIV	+01	+03	+05	+07	+09	+11	+13	+15	
DISTANCA PJESORE	15,91	19,99	20,09	20,00	20,02	20,11	20,13	19,99	10,68
KUOTA E PROJEKTIT	47.6	45.7	45.2	45.7	45.6	46.5	47.6	49.8	
KUOTA E TERENIT	48.8	46.9	46.4	46.9	46.8	47.7	48.7	51.0	
KILOMETRAZHI									

 BASHKIA E TIRANES DREJTORIA E PERGJITHSIME E PUNEVE PUBLIKE	Vula
 HE & SK 11 consulting company	Vula
Ing. Nd: REGASI Ing. Nd: MUCAJ Ing. Nd: DANAJ	
 PALMA CONSTRUCTION shpk Projektimi i Enjere, Shpallje dhe Konsultime Arkitektura, Strukturale, Transport dhe Mjetet e Rrethimit	Vula
Ing. Nd: V. GRUDA	
PROJEKTI: Rehabilitimi i rrugëve të bllokut që kufizohet nga rrugët "Leandro Zoto" - "Mari Kraja" - "Disha" - "Sadik Petrela"	EMERTIMI I FLETES: Projekt-Zbatim Prejje Gjatesore KUB Rruga "Namik Resuli" dhe "Genc Leka"
Shkalla: 1:250	Numri i fletes: F-1

Profili : SALI CEKA
 Shkalla : 1000:200
 Kuota Ref : 145.00

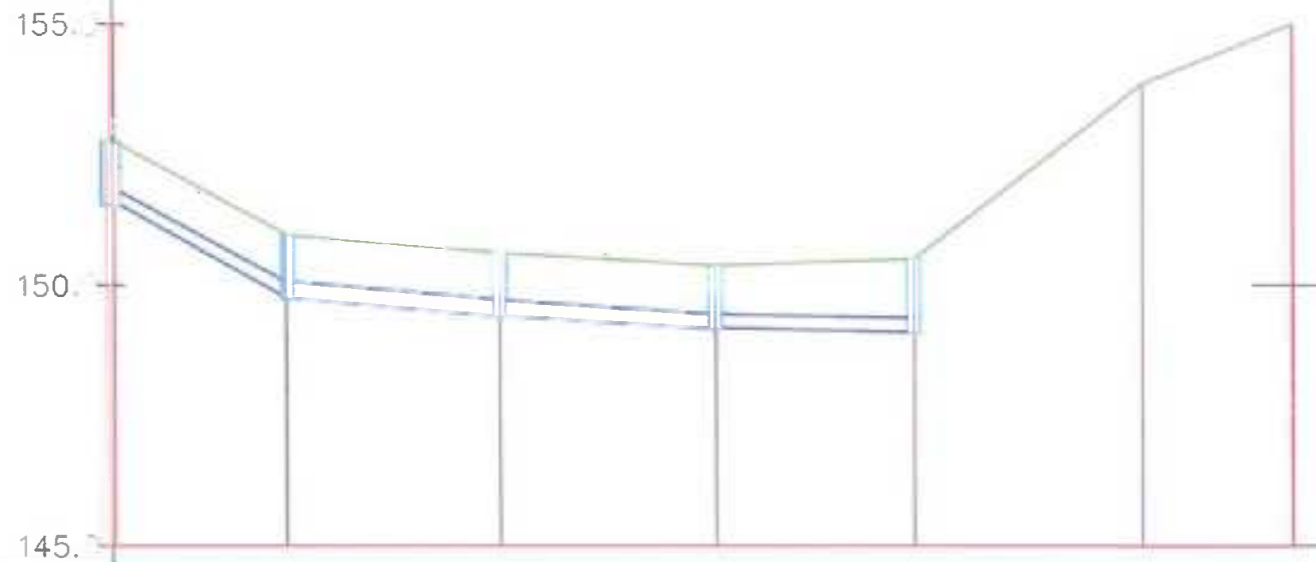

NUMERI PROFILIEVE		+017 Sc-2	+037 Sc-3	+057 Sc-4	+077 Sc-5	+097 Sc-6
DISTANCA PROGRESIV		+017	+037	+057	+077	+097
DISTANCA PJESORE	16,50	20,62	20,69	19,12	21,99	14,46
KUOTA E PROJEKTIT	149,7	149,4	149,15	149,5	149,8	150,1
KUOTA E TERENIT	150,9	150,6	150,3	150,5	150,8	153,8
KILOMETRAZHI						

 BASHKIA E TIRANËS DREKTORIA E PËRGRYFTESIME E PUNËVE PUBLIKE	Vula
 HE & SK 11 consulting company	Vula
Ing. Nd. A. V. GRUDA Ing. Nd. M. BEUTAJ Ing. Top. M. GASI Ing. M. M. MUJAJ Elektorik. ANAJ	
 PALMA CONSTRUCTION shpk Përkrahje teknologjike dhe teknike në projektimin dhe ndërtimin e infrastrukturës.	Vula
Ing. Nd. V. GRUDA	
PROJEKTI: Rehabilitimi i rrugëve të bllokut që kufizohet nga rrugët "Leandro Zoto" - "Mari Kraja" - "Disha" - "Sadik Petela"	EMËRTIMI I FLETËS: Projekt-Zbatim Prerje Gjatesore KUB Rruga "Sali Ceka"
Shkalla: 1:200	Numri i fletës: F-1

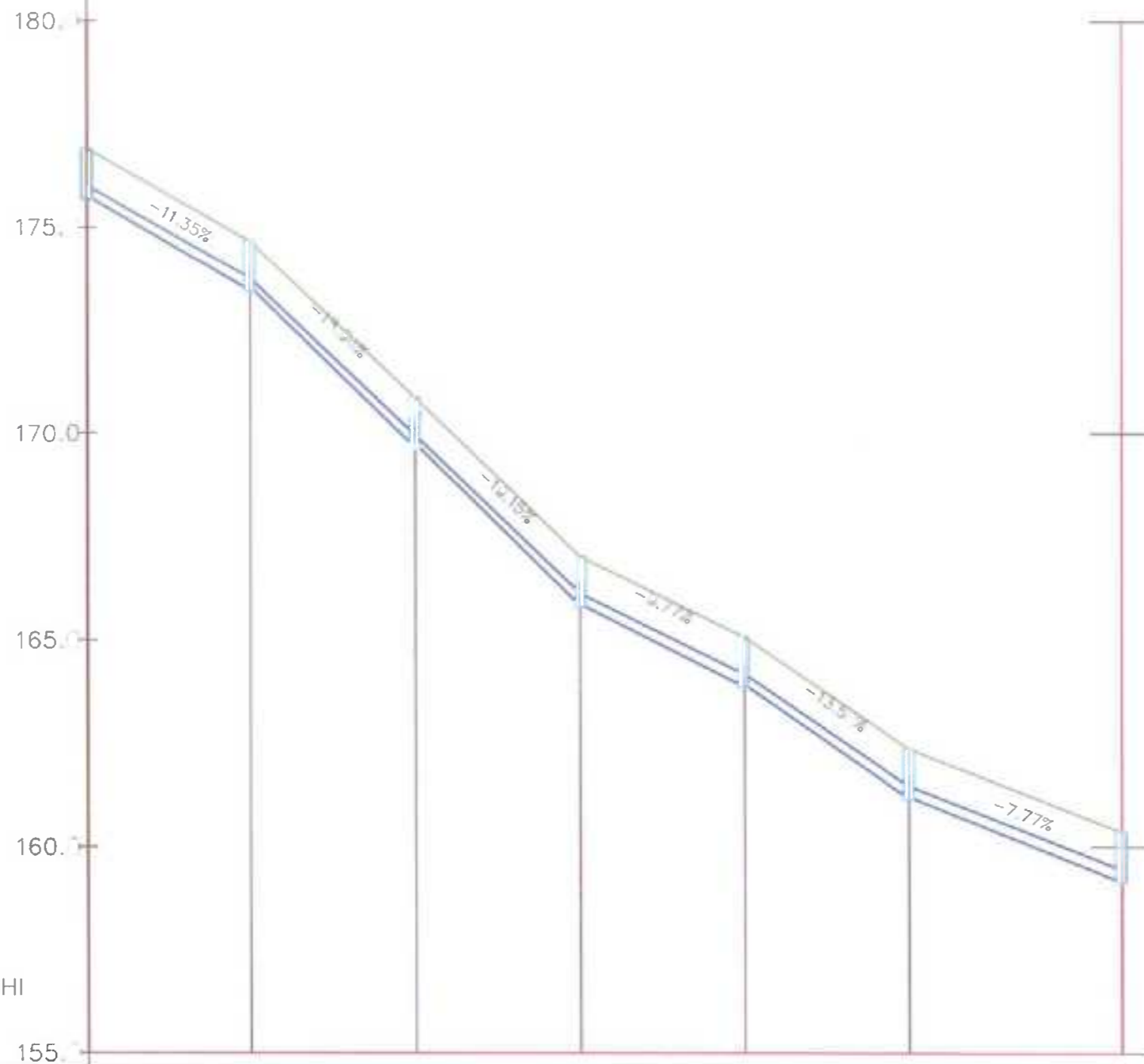

Profil : DEG 10 V MANUSHI
 Shkalla : 1000:200
 Kuota Ref : 155.00

NUMERI PROFILIEVE	Sc-2	Sc-3	Sc-4	Sc-5	Sc-6	
DISTANCA PROGRESIV	+02	+04	+06	+08	+10	
DISTANCA PJESORE	19,66	20,05	20,01	19,97	20,01	25,97
KUOTA E PROJEKTIT	173.4	169.6	165.8	163.8	161.1	
KUOTA E TERENIT	174.6	170.8	167.0	165.0	162.3	
KILOMETRAZHI						

Porosites	 BASHKIA E TIRANES DREJTORIA E PERGJITHSHME E PUNIVE PUBLIKE		Vula
Projektues	 HE & SK 11 consulting company		Vula
Ing. Nd: A. M. KULLIM - I. PORTO - E. M. BEGASI			
Ing. Nd: A. FERRELLI - E. M. CAJ			
Ing. Nd: M. REDA - N. DANAJ			
Projektues	 PALMA CONSTRUCTION shpk <small>Shp. Kt. Nr. 44 Zonë Industriale, Rr. "L. Biberaj" Nr. 11 Adresa: Shkup, Republika e Kosovës</small>		Vula
Ing. Nd: V. GRUDA			
PROJEKTI:	EMËRTIMI I FLETËS:		
Rehabilitimi i rrugëve të bllokut që kufizohet nga rrugët "Leandro Zoto" - "Mari Kraja" - "Disha" - "Sadik Petrela"	Projekt-Zbatim Prerje Gjatesore KUB Rruga "Deg 10 V Manushi"		
	Shkalla:	Numri i fletës:	
	1:200	F-1	

Profili : STERIO SPASE MAJTAS
Shkalla : 1000:200
Kuota Ref : 155.00

NUMERI PROFILIEVE								
DISTANCA PROGRESIVE	+02	+03	+05	+07	+10	+12	+14	
DISTANCA PJESORE	19,63	19,59	20,10	19,72	23,64	19,97	19,92	14,20
KUOTA E PROJEKTIT	63.0	62.4	62.0	61.5	61.2	60.9	60.6	
KUOTA E TERENIT	64.2	63.6	63.2	62.7	62.4	62.1	61.8	61.1
KILOMETRAZHI								

Profili : STERIO SPASE DJATHTAS
Shkalla : 1000:200
Kuota Ref : 160.00

NUMERI PROFILIEVE								
DISTANCA PROGRESIVE	+02	+03	+04	+06	+07	+10	+12	+14
DISTANCA PJESORE	19,65	19,64	9,00	13,44	13,48	26,14	20,45	19,95
KUOTA E PROJEKTIT	63.0	62.4	62.2	61.8	61.5	61.2	60.9	60.7
KUOTA E TERENIT	64.2	63.6	63.4	63.0	62.7	62.4	62.1	61.9
KILOMETRAZHI								

Porosites
 **BASHKIA E TIRANES**
DIREKTORIA E PERGJITHSIME
E PUNEVE PUBLIKE

Projektues
 **HE & SK 11**
CONSULTING

Ing. Nd. V. GRUDA
Ing. Nd. V. GRUDA
Ing. Top: F. GASI
Ing. Mek: E. M. CAJ
Ing. N. DANAJ

Projektues
 **PALMA CONSTRUCTION shpk**
Projektim dhe ndertim te objekteve te ndryshme te ndihme
Archi-tektonike, shkollore, te gjithe shprehjet e ndihme

Ing. Nd. V. GRUDA

PROJEKTI: Rehabilitimi i rrugëve të bilokut që kufizohet nga rrugët "Lcandro Zoto" - "Mari Kraja" - "Disha" - "Sadik Petrela"	EMËRTIMI I FLETËS: Projekt-Zbatim Prerje Gjatesore KUB Rruga "Sterio Spase" Majtas dhe Djathtas
Shkalla: 1:200	Numri i fletes: E-1

Profil : DEG 1 STERIO SPASE
 Shkalla : 1000:200
 Kuota Ref : 160.00



NUMERI PROFILIEVE	Sc-2	Sc-3	Sc-4	Sc-5
ISTANCA PROGRESIV	+00	+02	+04	+06
DISTANCA PJESORE	8,16	20,02	18,48	20,00
KUOTA E PROJEKTIT	64.5	64.4	64.3	64.2
KUOTA E TERENIT	65.8	65.9	65.8	65.7
KILOMETRAZHI				

Porosites	Vula	
 BASHKIA E TIRANËS DREJTORIA E PËRGJITHSHME E PUNEVE PUBLIKE		
Projektues	Vula	
		
Ing. Nd: A. V. GRUDA	Ing. T. M. MEGASI	
Ing. N. M. DEJAJ	Ing. M. E. DEJAJ	
Ing. Nd. M. DEJAJ	Ing. Elek. M. DEJAJ	
Projektues	Vula	
 PALMA CONSTRUCTION shpk <small>Projetim dhe ndërtim të objekteve të ndërtimit dhe infrastrukturës</small>		
Ing. Nd: V. GRUDA		
PROJEKTI: Rehabilitimi i rrugëve të bllokut që kufizohet nga rrugët "Leandro Zoto" - "Mari Kraja" - "Disha" - "Sadik Petrela"	EMËRTIMI I FLETES: Projekt-Zbatim Prejre Gjatesore KUB Rruga "Sterio Spase"	
Shkalla: 1:200	Numri i fletes: F-1	

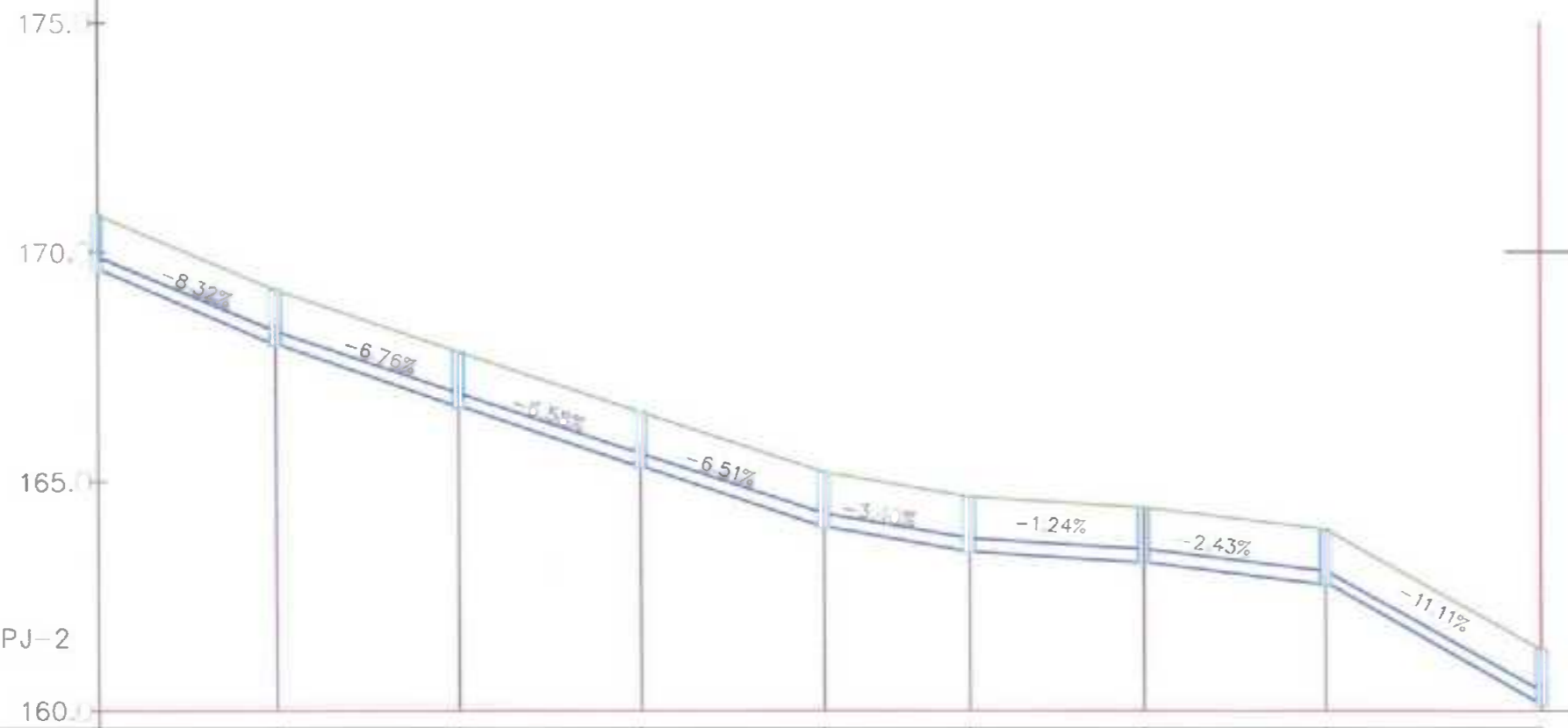

Profili : VANGJUSH MIHO PJ-2
 Shkalla : 1000:200
 Kuota Ref : 160.00

NUMERI PROFILIEVE		Sc-2	Sc-3	Sc-4	Sc-5	Sc-6	Sc-7	Sc-8
DISTANCA PROGRESIVE		+02	+04	+06	+08	+09	+115	+135
DISTANCA PJESORE	19,63	19,99	19,94	20,05	15,89	19,16	20,01	23,65
KUOTA E PROJEKTIT		67.9	66.6	65.3	64.0	63.4	63.2	62.7
KUOTA E TERENIT		69.1	67.8	66.5	65.2	64.6	64.4	63.9
KILOMETRAZHI								

Porosites	 BASHKIA E TIRANES DREJTORIA E PERGJITHISEME E PUNIME PUBLIKE		Vula
Projektues			Vula
Ing. Nd. A. VOGLI			
Ing. Nd. A. FALERI			
Ing. Nd. M. ...			
Projektues			Vula
Ing. Nd. V. GRUDA			
PROJEKTI:	Rehabilitimi i rrugëve të bilokut që kufizohet nga rrugët "Leandro Zoto" - "Mari Kraja" - "Disha" - "Sadik Petrela"		EMERTIMI I FLETES:
			Projekt-Zbatim Prerje Gjatesore KUB Rruga "Vangjush Miho"
	Shkalla:	Numri i fletes:	
	1:200	F-1	

Profil : ARJAN XHUMARI
Shkalla : 1000:200
Kuota Ref : 145.00

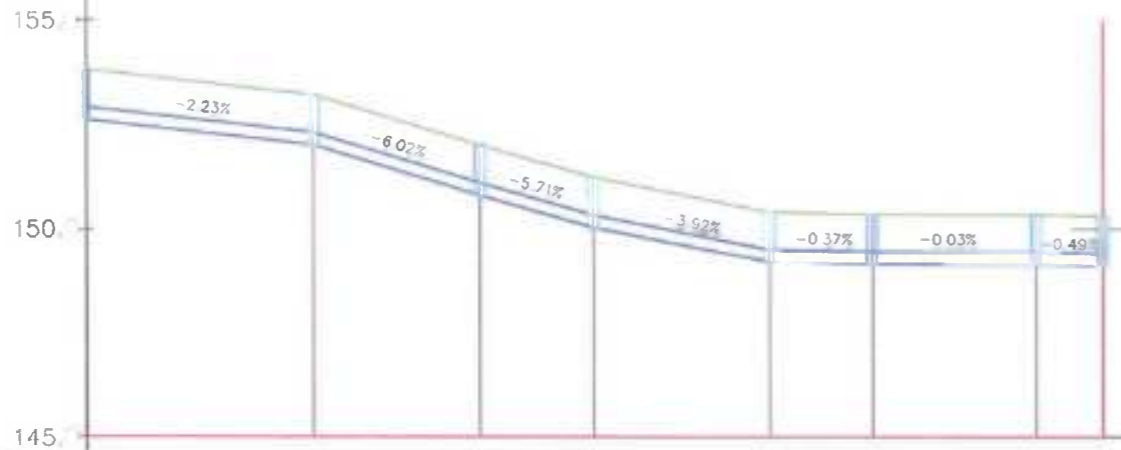

NUMERI PROFILIEVE							
DISTANCA PROGRESIV		+027	+04	+06	+08	+09	+114
DISTANCA PJESORE	27,48	20,02	13,60	21,12	12,39	19,66	8,04
KUOTA E PROJEKTIT		52.0	50.8	50.0	49.2	49.1	49.1
KUOTA E TERENIT		53.2	52.0	51.2	50.4	50.3	50.3
KILOMETRAZHI							

Profil : DEG 5 VIOLETA MANUSH
Shkalla : 1000:200
Kuota Ref : 150.00

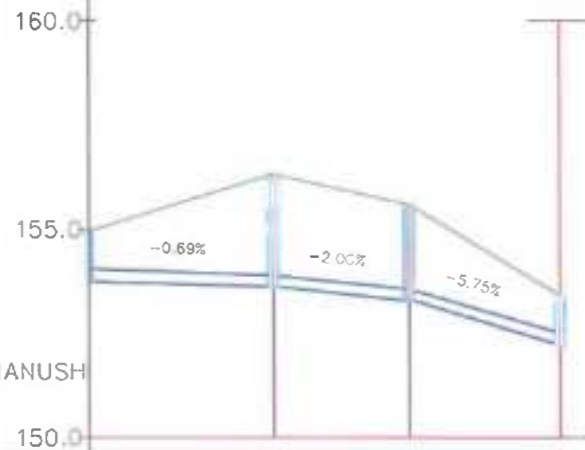

NUMERI PROFILIEVE			
DISTANCA PROGRESIV	+02	+03	
DISTANCA PJESORE	22,39	16,27	18,13
KUOTA E PROJEKTIT	53.6	53.2	
KUOTA E TERENIT	56.3	55.6	
KILOMETRAZHI			

 BASHKIA E TIRANES DREJTORIA E PERGJITHSHME E PUNEVE PUBLIKE	Vula
 HE & SK 11 consulting company	Vula
Ing. Nd. AVDOLLAJ Ing. Nd. A. REFATULLAJ Ing. Nd. M. AJAJ	Ing. T. BEGASI Ing. Meri E. MUJAJ Ing. Elieq. N. ANAJ
 PALMA CONSTRUCTION shpk Projektim dhe zbatim i veprave te ndertimit Arkitektura, Struktura, Inzhineri dhe Inzhineri	Vula
Ing. Nd: V. GRUDA	
PROJEKTI: Rehabilitimi i rrugëve të bllokut që kufizohet nga rrugët "Leandro Zoto" - "Mari Kraja" - "Disha" - "Sadik Petrela"	EMËRTIMI I FLETËS: Projekt-Zbatim Prerje Gjatesore KUB Rruga "Arjan Xhumari" dhe "Violeta Manushi"
Shkalla: 1:250	Numri i fletes: F-1

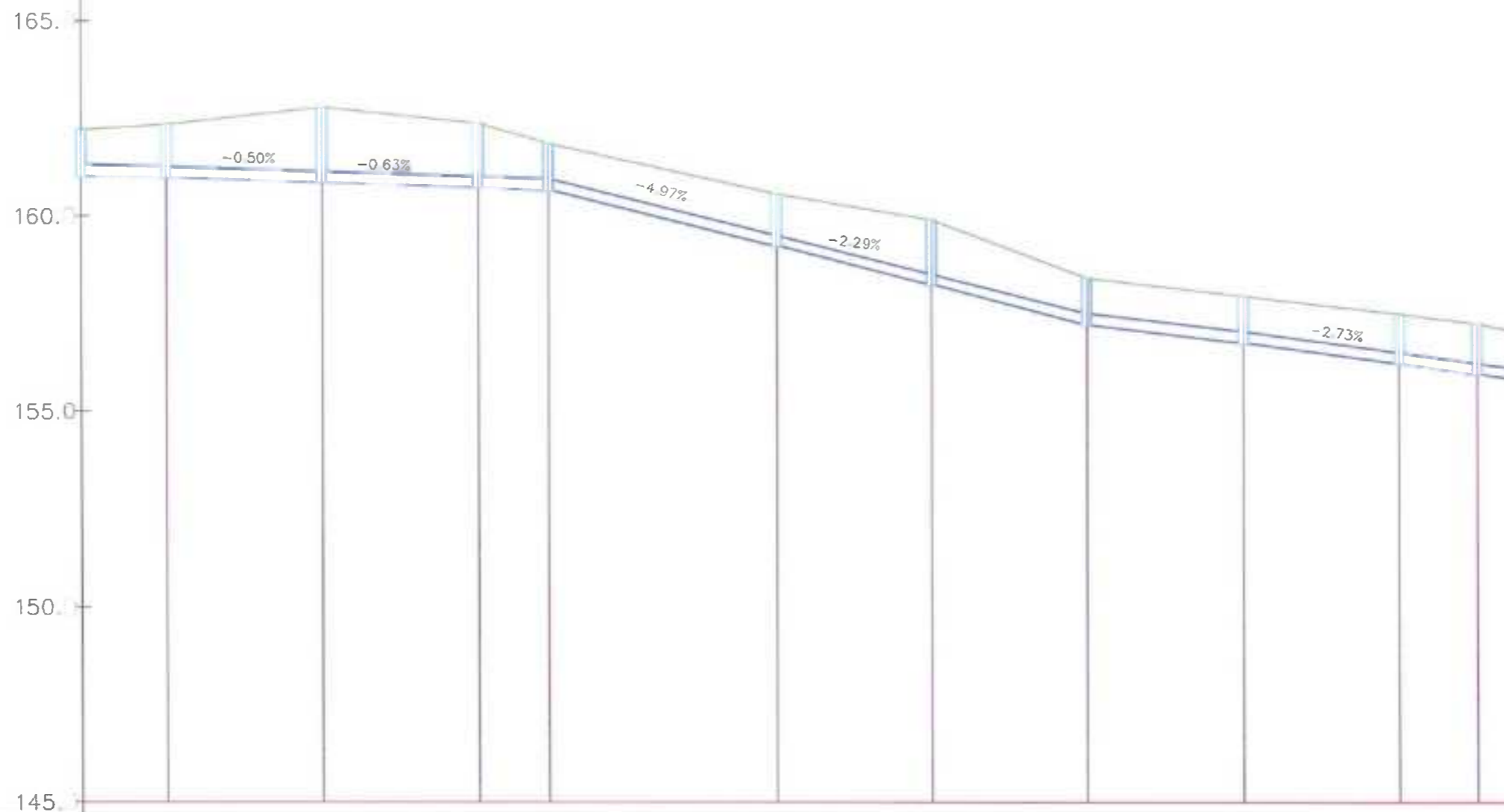

Profili : TONIN HARAPI
 Shkalla : 1000:200
 Kuota Ref : 145.00

NUMERI PROFILIEVE	Sc-2											
DISTANCA PROGRESIVE	+03											
DISTANCA PJESORE	10,97	19,98	19,99	9,06	29,21	20,00	20,00	20,16	20,03	10,08	9,06	
KUOTA E PROJEKTIT	160.9	160.8	160.7	160.6	159.2	158.2	157.2	156.7	156.2	155.9		
KUOTA E TERENIT	162.3	162.8	162.3	161.8	160.5	159.9	158.4	157.9	157.5	157.2		
KILOMETRAZHI	[Bar chart showing distance segments]											

Porosites	 BASHKIA E TIRANËS DREJTORIA E PËRCUITHSHMË E PUNËVE PUBLIKE		Vula
Projektues	 HE & SK 11 consulting company		Vula
Ing. Nd:	Ing. Tahir REGASI		
Ing. Nd:	REKATILAR	Ing. Nd: E. MICAJ	
Ing. Nd M:	EDAJ	Ing. Elek: N. DANAJ	
Projektues	 PALMA CONSTRUCTION shpk Shërbime të integruara dhe të bashkuara për sektorin e infrastrukturës		Vula
Ing. Nd: V. GRUDA			
PROJEKTI:	Rehabilitimi i rrugëve të bllokut që kufizohet nga rrugët "Leandro Zoto" - "Mari Kraja" - "Disha" - "Sadik Petrela"		
EMERTIMI I FLETES:	Projekt-Zbatim Prejje Gjatesore KUB Rruga "Tonin Harapi"		
	Shkalla: 1:200	Numri i fletes: F-1	

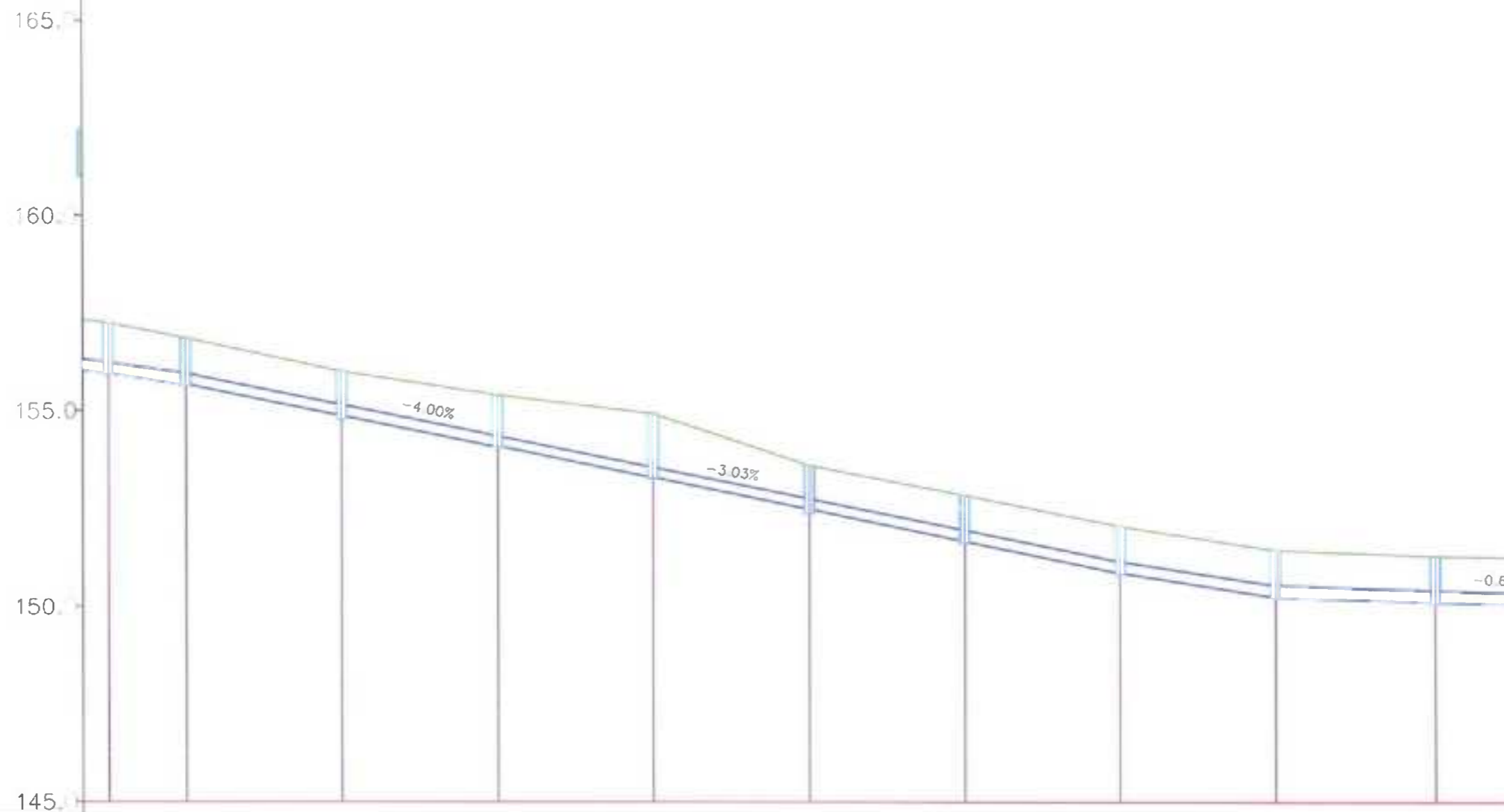

Profili : TONIN HARAPI
 Shkalla : 1000:200
 Kuota Ref : 145.00

NUMERI PROFILIEVE	17	18	20	22	24	26	28	30	33	35
DISTANCA PROGRESIVE	0+17	0+18	0+20	0+22	0+24	0+26	0+28	0+30	0+33	0+35
DISTANCA PJESORE	9,92	20,02	20,00	20,01	20,01	20,01	20,01	20,04	20,59	18,9
KUOTA E PROJEKTIT	55.9	55.6	54.8	54.0	53.2	52.4	51.6	50.8	50.2	50.1
KUOTA E TERENIT	57.2	56.8	56.0	55.4	54.9	53.6	52.8	52.0	51.4	51.3
KILOMETRAZHI	[Bar chart showing distance segments]									

Porosites	Vula
	BASHKIA E TIRANËS DREJTORIA E PËRQIJITSHMË E PUNËVE PUBLIKE
Projektues	Vula
	HE & SK 11 consulting company
Ing. Nd: A. V. GRUDA	Ing. Elek: E. BREGASI
Ing. Nd: A. REFAJANAJ	Ing. Nd: E. MUCAJ
Ing. Nd: M. ALI	Ing. Elek: M. ANAJ
Projektues	Vula
	PALMA CONSTRUCTION shpk A 30-kuqishit Strukturore, kompani dhe tërësi strukturore
Ing. Nd: V. GRUDA	

PROJEKTI: Rehabilitimi i rrugëve të bllokut që kufizohet nga rrugët "L. candio Zoto" - "Mari Kriaja" - "Disha" - "Sadik Petrela"	EMËRTIMI I FLETËS: Projekt-Zbatim Përje Gjatesore KUB Rruga "Tonin Harapi"
Shkalla: 1:200	Numri i fletës: F-2

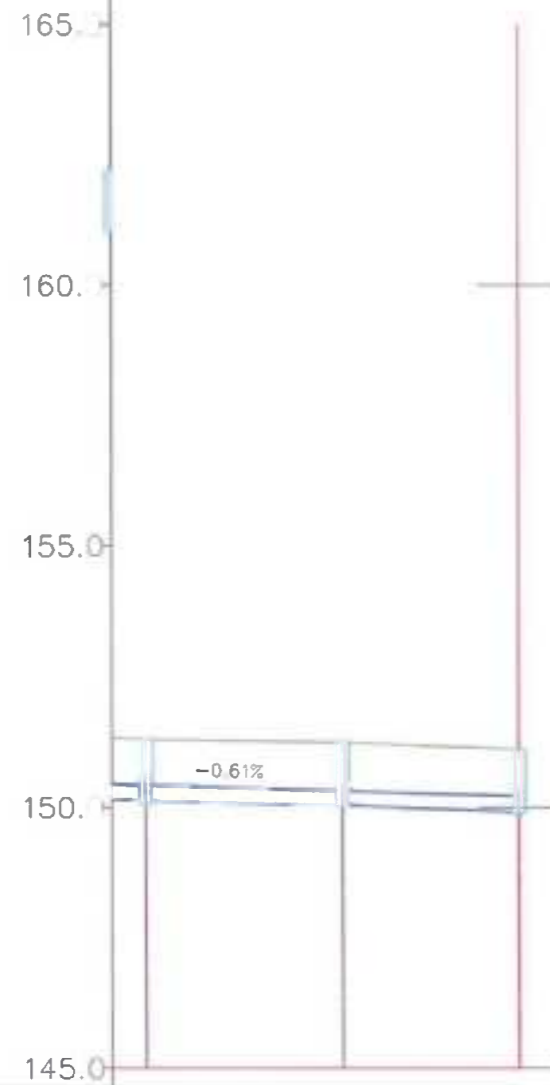

Profili : TONIN HARAPI
 Shkalla : 1000:200
 Kuota Ref : 145.00

NUMERI PROFILIEVE	0+35	0+36
DISTANCA PROGRESIVE	0+35	0+36
DISTANCA PJESORE	18,93	16,94
KUOTA E PROJEKTIT	150.1	150.0
KUOTA E TERENIT	149.3	151.2
KILOMETRAZHI		

Porosites	Vula	
	BASHKIA E TIRANES DIREKTORIA E PERGJITHSHE E PUNEVE PUBLIKE	
Projektues	Vula	
	HE & SK 11 consulting company	
Ing. Nd. A VOGLI	Ing. E. BREGASI	
Ing. Nd. A. ATHE	Ing. M. MUCAJ	
Ing. Nd. M. B. ...	Ing. Elek. N. ...	
Projektues	Vula	
	PALMA CONSTRUCTION shpk Projektor i ndaluar ne 4 shkalla te autorizimit ne 1997 Ani i kushtetimit dhe i ndaluar ne 4 shkalla te autorizimit	
Ing. Nd. V. GRUDA		
PROJEKTI: Rehabilitimi i rrugeve te blokut qe kufizohet nga rrugët "Leandro Zoto" - "Mari Kraja" - "Disha" - "Sadik Petrela"	EMERTIMI I FLETES: Projekt-Zbatim Prerje Gjatesore KUB Rruga "Tonin Harapi"	
	Shkalla: 1:200	Numri i fletes: F-3

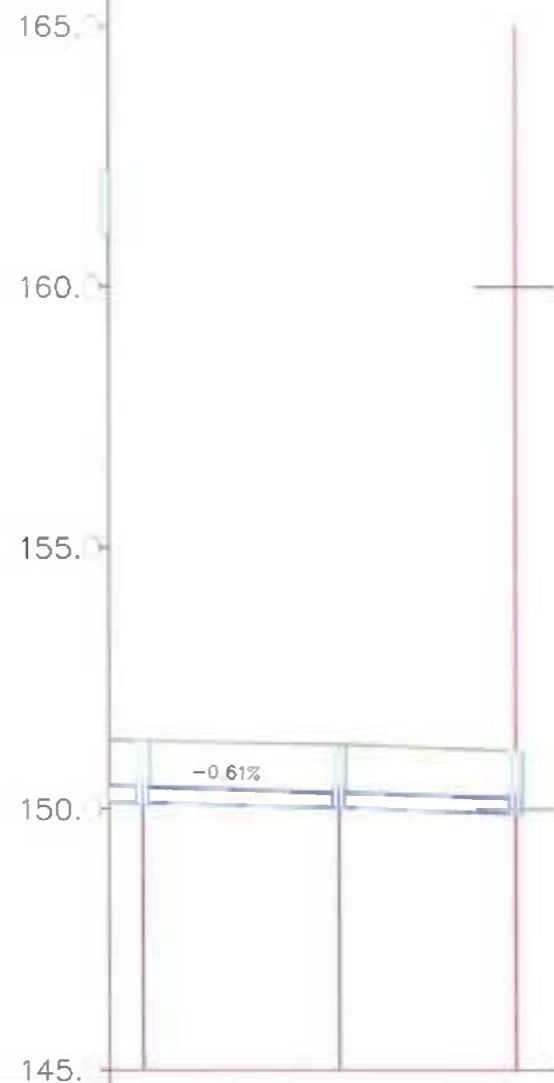

Profili : TONIN HARAPI
 Shkalla : 1000:200
 Kuota Ref : 145.00

NUMERI PROFILIEVE	Sc-2	Sc-2
DISTANCA PROGRESIVE	+35	+36
DISTANCA PJESORE	18,93	16,94
KUOTA E PROJEKTIT	150.13	150.0
KUOTA E TERENIT	151.3	151.2
KILOMETRAZHI		

Porosites	 BASHKIA E TIRANË DREKTORIA E PËRQJITJESHME E PUNEVE PUBLIKE		Vula
Projektues	 HE & SK 11 consulting company		Vula
Ing. Nd. A.V.	 Ing. Nd. A.V.	 Ing. Top. F. BREGASI	
Ing. Nd. A. REFATLLARI	 Ing. Nd. A. REFATLLARI	 Ing. Meksi MUÇAJ	
Ing. Nd. M.BEDRI	 Ing. Nd. M.BEDRI	 Ing. Elek. N. JANAJ	
Projektues	 PALMA CONSTRUCTION shpk <small>Fillimi i punës në 2014, kryeje dhe koordinimi i punës në ndërtim Aktiviteti: Shërbime Injenerim dhe Injenerizim</small>		Vula
Ing. Nd. V. GRUDA	 Ing. Nd. V. GRUDA		
PROJEKTI:	Rehabilitimi i rrugëve të bllokut që kufizohet nga rrugët "Leandro Zoto" - "Mari Kraja" - "Disha" - "Sadik Petrela"		EMERTIMI I FLETËS:
			Projekt-Zbatim Prerje Gjatesore KUB Rruga "Tonin Harapi"
	Shkalla:	Numri i fletës:	
	1:200	F-3	

Profili : PARO KITA
 Shkalla : 1000:200
 Kuota Ref : 145.00

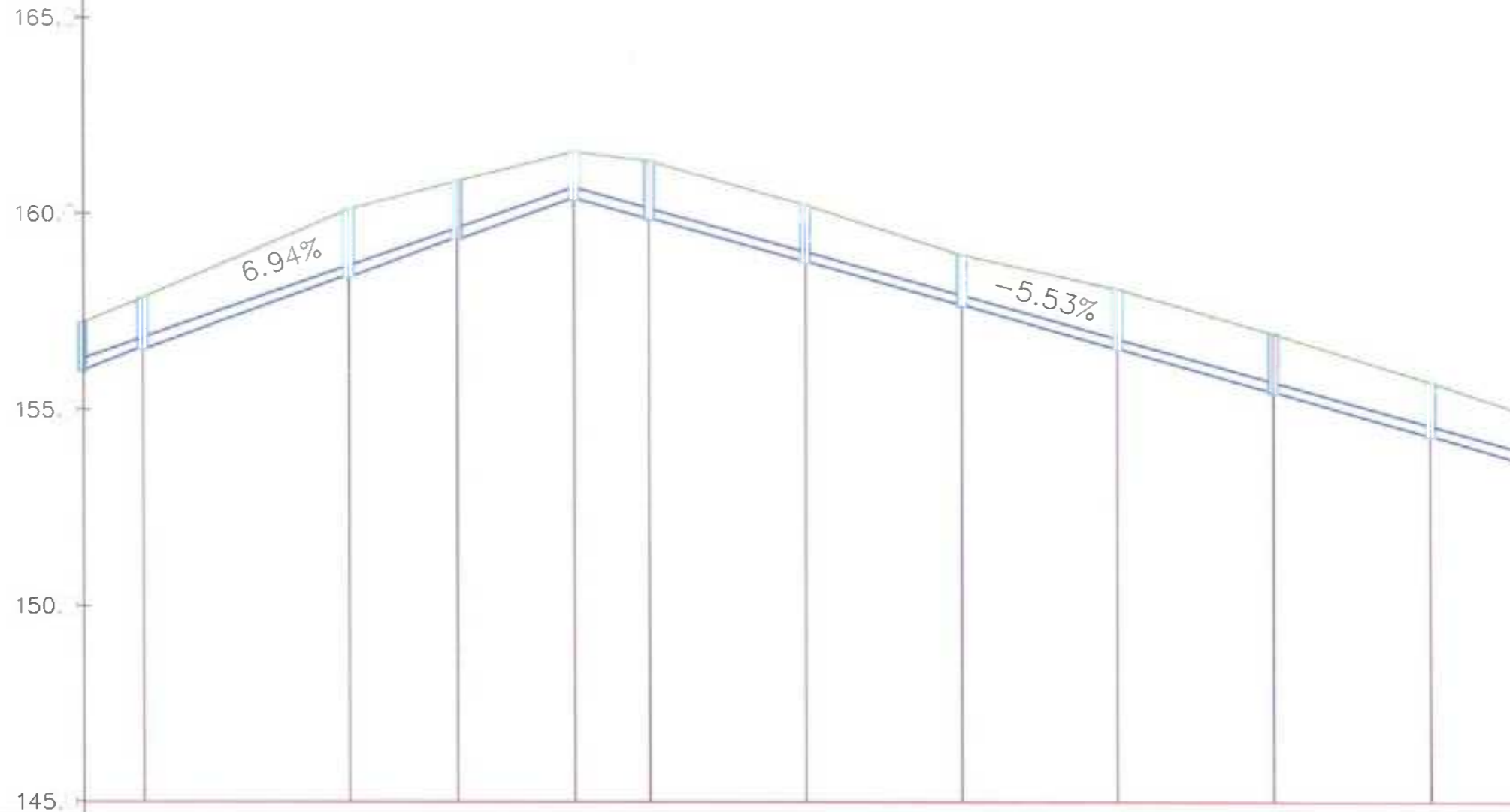

NUMERI PROFILIEVE	Sc-2	Sc-3	Sc-4	Sc-5	Sc-6	Sc-7	Sc-8	Sc-9	Sc-10	Sc-11	
DISTANCA PROGRESIVE	+00	+034	+04	+06	+07	+09	+11	+13	+13	+152	+17
DISTANCA PJESORE	7,81	26,34	13,82	14,94	9,62	20,00	20,03	19,97	19,97	20,15	20,0
KUOTA E PROJEKTIT	56.5	58.3	59.3	60.3	59.8	58.7	57.6	56.5	55.4	54.3	
KUOTA E TERENIT	57.8	60.1	60.8	61.5	61.3	60.2	58.9	58.0	56.9	55.7	
KILOMETRAZHI											

Porosites	 BASHKIA E TIRANES DREJTORIA E PERGJITHSHME E PUNEVE PUBLIKE		Vula
Projektues	 HE & SK 11 consulting company		Vula
Ing. Nd. A. VOGLI		Ing. Top: F. BREGASI	
Ing. Nd. A. HATILAJE		Ing. Elek: M. MUJAJ	
Ing. Nd. M. BERAJ		Ing. Elek: V. AVAJ	
Projektues	 PALMA CONSTRUCTION shpk Projektime, ndërtim, projektim dhe shërbime ndërtimore Aktiviteti: Shërbime projektimi dhe infrastrukturë		Vula
Ing. Nd. V. GRUDA			
PROJEKTI:	Rehabilitimi i rrugëve të bllokut që kufizohet nga rrugët "Leandro Zoto" - "Mari Kraja" - "Disha" - "Sadik Petrela"		EMERTIMI I FLETES:
			Projekt-Zbatim Prerje Gjatesore KUB Rruga "Paro Kita"
	Shkalla:	Numri i fletes:	
	1:200	F-1	

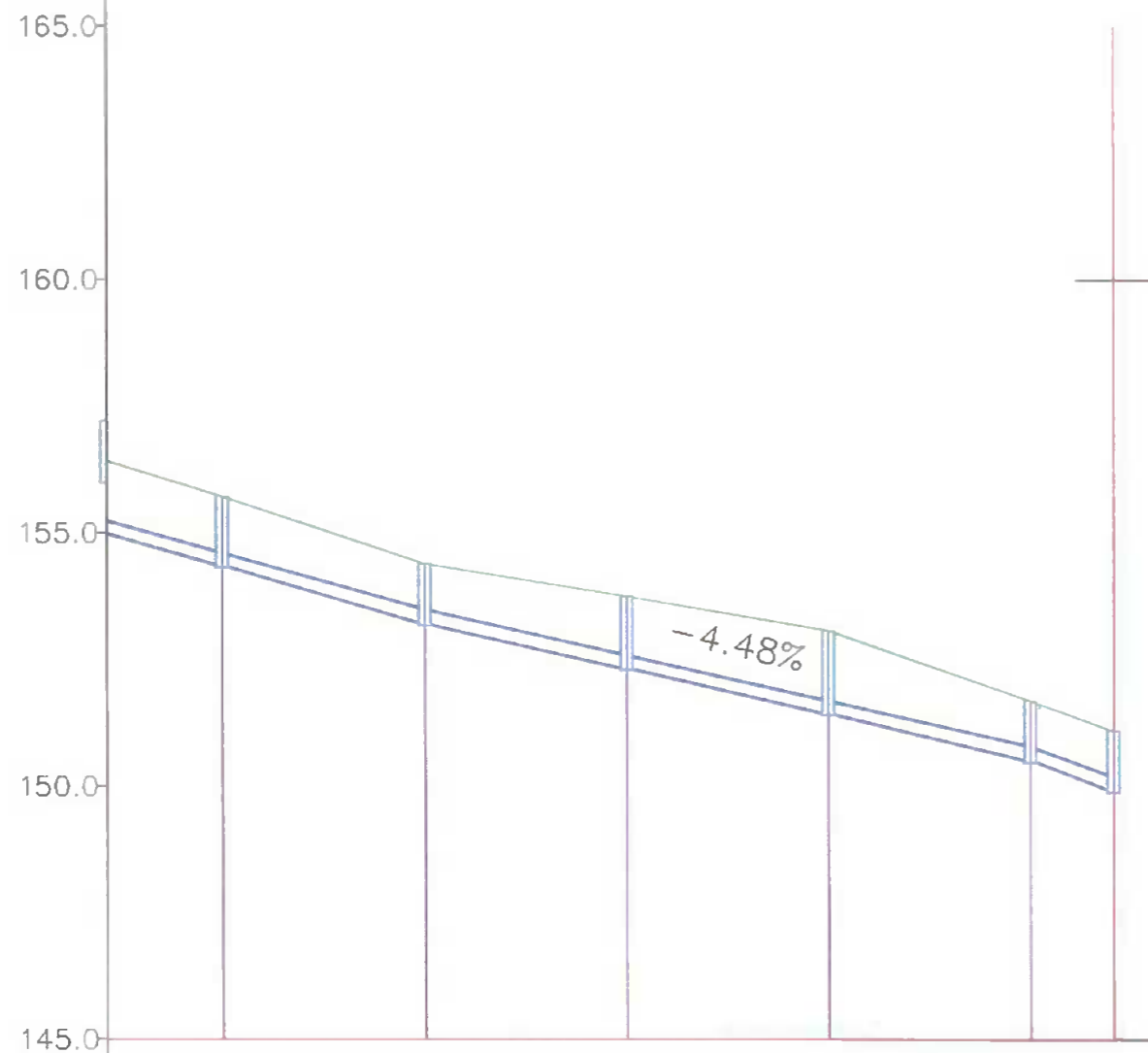

Profili : PARO KITA
 Shkalla : 1000:200
 Kuota Ref : 145.00

NUMERI PROFILIEVE	0+173Sc-11	0+193Sc-12	0+213Sc-13	0+233Sc-14	0+253Sc-15
DISTANCA PROGRESIVE	0,15	20,01	20,01	20,00	20,01
DISTANCA PJESORE	0,15	20,01	20,01	20,00	20,01
KUOTA E PROJEKTIT	154.30	153.19	152.29	151.40	150.50
KUOTA E TERENIT	155.72	154.39	153.76	153.08	151.70
KILOMETRAZHI					

Porosites	Vula
 BASHKIA E TIRANES DREJTORIA E PERQUTISHME E PUNEVE PUBLIKE	
Projektues	Vula
	
Ing. Nd. A. VOGLA	Ing. Toj. E. BREGASI
Ing. Nd. A. RUFATI	Ing. M. M. MUCAJ
Ing. Nd. M. B. ...	Ing. El. N. ...
Projektues	Vula
 PALMA CONSTRUCTION shpk Projektim, ndërtim dhe shërbime për sektorin e infrastrukturës Arkitektura, Shërbime, Injeneri dhe Infrastrukturë	
Ing. Nd. V. GRUDA	
PROJEKTI: Rehabilitimi i rrugëve të bllokut që kufizohet nga rrugët "Leandro Zoto" - "Mari Kraja" - "Disha" - "Sadik Petrela"	EMËRTIMI I FLETES: Projekt-Zbatim Prerje Gjatesore KUB Rruga "Paro Kita"
Shkalla: 1:200	Numri i fletës: F-2

Profili : PAROKITA PJ-1
Shkalla : 1000/200
Kuota Ref : 140.00

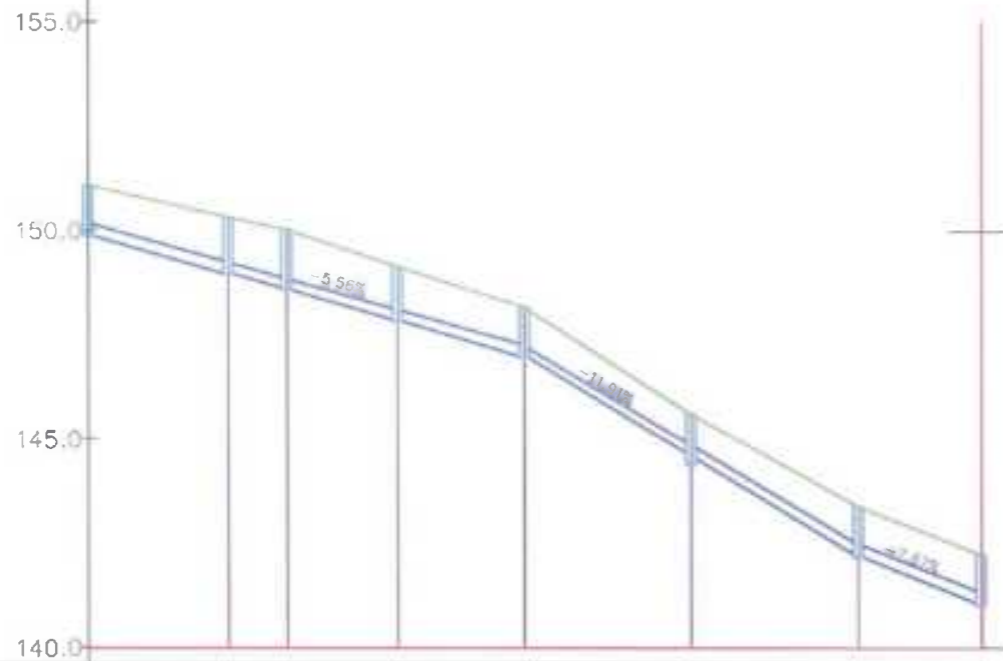

NUMERI PROFILIEVE												
DISTANCA PROGRESIVE	0+017	Sc-2	0+021	Sc-3	0+034	Sc-4	0+054	Sc-5	0+074	Sc-6	0+094	Sc-7
DISTANCA PJESORE	16,99	7,00	13,29	15,26	20,02	20,08	14,82					
KUOTA E PROJEKTIT	50.33	48.9	50.03	48.5	49.19	47.8	48.1	46.9	45.6	44.5	43.38	42.1
KUOTA E TERENIT												
KILOMETRAZHI												

Profili : DEG-1 PARO KITA
Shkalla : 1000/200
Kuota Ref : 140.00

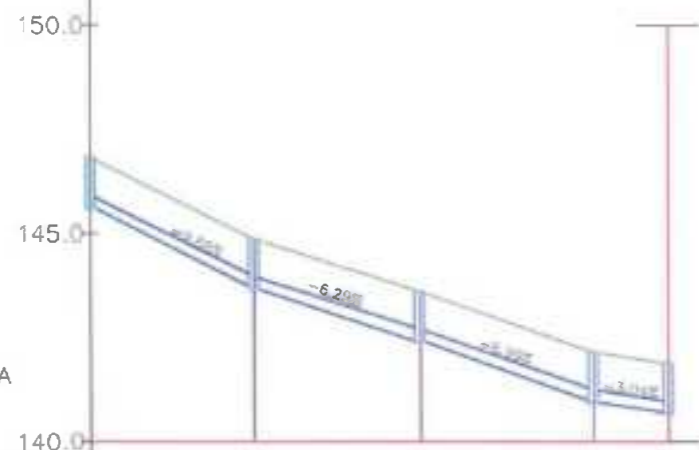

NUMERI PROFILIEVE						
DISTANCA PROGRESIVE	0+02	Sc-2	0+04	Sc-3	0+06	Sc-4
DISTANCA PJESORE	19,67	19,99	20,84	9,06		
KUOTA E PROJEKTIT	44.8	43.6	43.6	42.4	42.1	40.9
KUOTA E TERENIT						
KILOMETRAZHI						

 BASHKIA E TIRANËS DREJTORIA E PËRGJITHSHME E PUNËVE PUBLIKE	Vula
 HE & SK 11 consulting company	Vula
Ing. Nd. A. MBE  Ing. Nd. V. GRUDA 	Ing. Top. F. BREGASI Ing. Nd. A. KEFATLLARI Ing. Nd. M. BE... Ing. Nd. M. BE...
 PALMA CONSTRUCTION shpk Projektim, ndërtim dhe kërkime shkencore në fushën e Arkitekturës, Strukturës, Inxhinjerisë dhe Informatikës	Vula
PROJEKTI: Rehabilitimi i rrugëve të bllokut që kufizohet nga rrugët "I eandro Zoto" - "Mari Kraja" - "Disha" - "Sadik Petrela"	
EMËRTIMI I FLETËS: Projekt-Zbatim Prerje Gjatesore KUB Rruga "Paro Kita"	
Shkalla: 1:250	Numri i fletës: F-1

Profili : DEG-1 SADIK PETRELA
 Shkalla : 1000:200
 Kuota Ref : 145.00

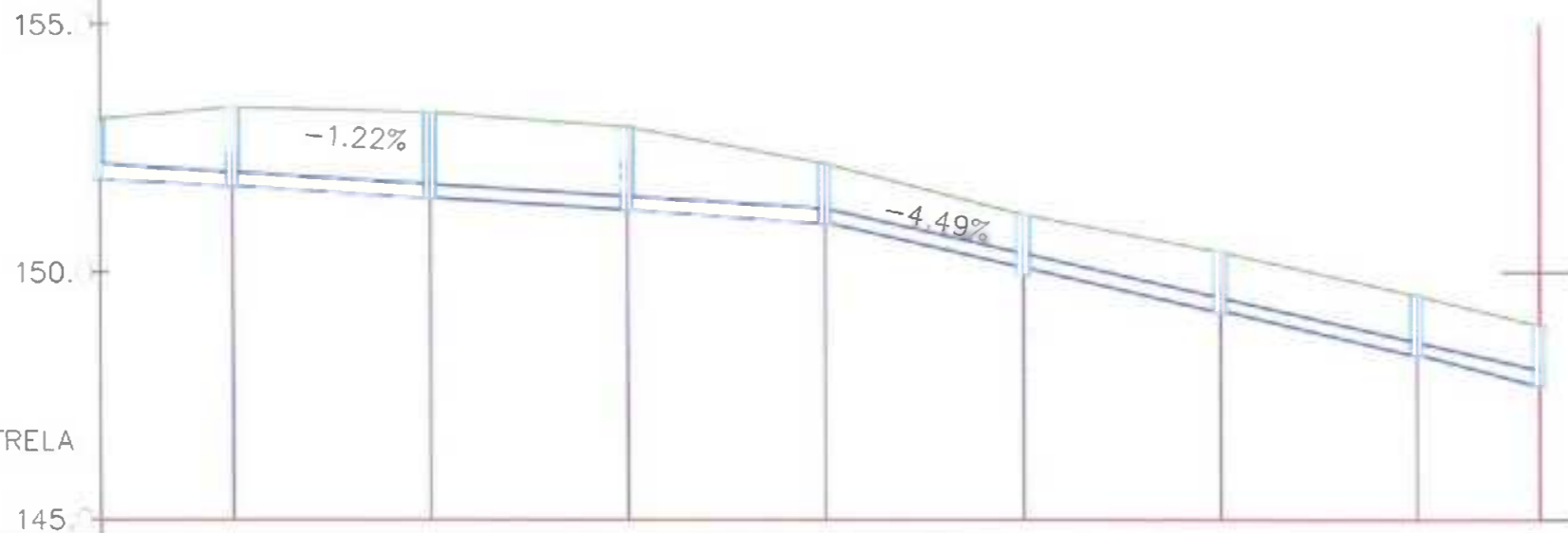

NUMERI PROFILIEVE								
DISTANCA PROGRESIVE	+01	+034	+054	+074	+09	+114	+134	
DISTANCA PJESORE	13,62	20,00	19,98	20,00	20,07	20,00	20,02	12,42
KUOTA E PROJEKTIT	51.7	51.4	51.2	50.9	50.0	49.1	48.2	
KUOTA E TERENIT	53.3	53.2	52.9	52.1	51.7	50.4	49.5	
KILOMETRAZHI								

Porosites	 BASHKIA E TIRANËS DREJTORIA E PËRGJITHSHME E PUNEVE PUBLIKE		Vula
Projektues	 HE & SK 11 consulting company		Vula
Ing. Nd. A. V.	 MEGASI		
Ing. Nd. A. DEFA	 DEFA		
Ing. Nd. M. ...	 ANAJ		
Projektues	 PALMA COSTRUCTION shpk Projektim, inzhineri dhe kaluarim punimeve ndihmese A. V. Kullës, Shkurtin, Tiranë, Republika e Shqipërisë		Vula
Ing. Nd. V. GRUDA			
PROJEKTI:	Rehabilitimi i rrugëve të bllokut që kufizohet nga rrugët "Leandro Zoto" - "Mari Kraja" - "Disha" - "Sadik Petrela"		EMERTIMI I FLETES:
			Projekt-Zbatim Prerje Gjatesore KUB Rruga "Sadik Petrela"
	Shkalla:	Numri i fletes:	
	1:200	F-1	

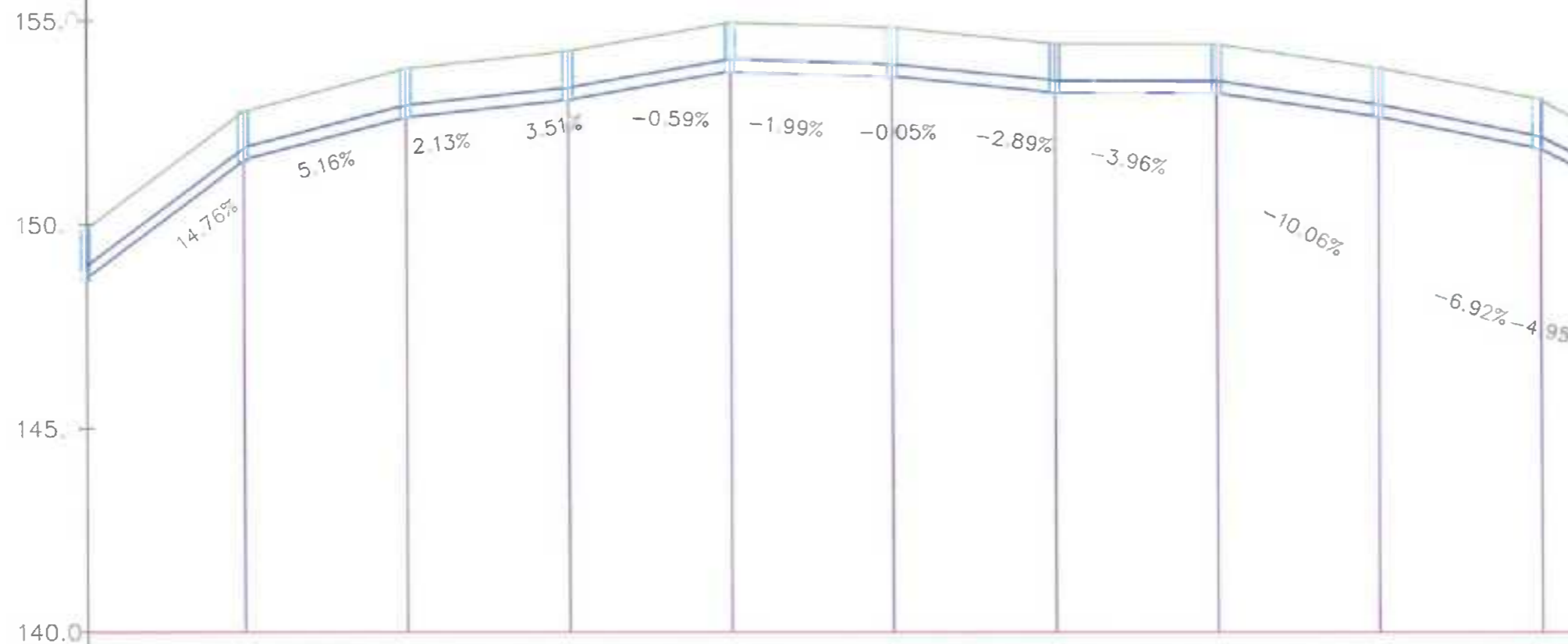

Profili : KADILLARI
 Shkalla : 1000:200
 Kuota Ref : 140.00

NUMERI PROFILIEVE	Sc-2	Sc-3	Sc-4	Sc-5	Sc-6	Sc-7	Sc-8	Sc-9	Sc-10	Sc-11	Sc-12	Sc-13
DISTANCA PROGRESIVE	+02	+04	+06	+08	+10	+12	+14	+16	+18	+20	+22	+24
DISTANCA PJESORE	19,64	19,98	20,00	20,00	20,02	20,05	20,00	20,00	20,01	20,01	20,01	20,01
KUOTA E PROJEKTIT	51.5	52.6	53.0	53.7	53.6	53.2	53.2	52.6	51.8	51.8	51.8	51.8
KUOTA E TERENIT	52.7	53.8	54.2	54.9	54.8	54.4	54.4	53.8	53.0	53.0	53.0	53.0
KILOMETRAZHI			00									

Porosites	Vula
 BASHKIA E TIRANËS DREJTORIA E PËRGJITHSIMIT E PUNËVE PUBLIKE	
Projektues	Vula
 HE & SK 11 consulting company	
Ing. Nd. A. VOGLI	Ing. Top. F. DEVLISI
Ing. Nd. A. BEFATLLARI	Ing. Mek. E. MUCKI
Ing. Nd. M. BEDR	Ing. Mek. N. DANAJ
Projektues	Vula
 PALMA CONSTRUCTION shpk Projektim, inzhineri dhe ndërtim infrastrukturash Arkitekturë, inzhineri, imazhi dhe infrastruktura	
Ing. Nd. V. GRUDA	
PROJEKTI: Rehabilitimi i rrugëve të bllokut që kufizohet nga rrugët "Leandro Zoto" - "Mari Kraja" - "Disha" - "Sadik Petrela"	EMERTIMI I FLETËS: Projekt-Zbatim Prerje Gjatesore KUB Rruga "Kadillari"
Shkalla: 1:200	Numri i fletës: F-1

Profili : KADILLARI
 Shkalla : 1000:200
 Kuota Ref : 140.00

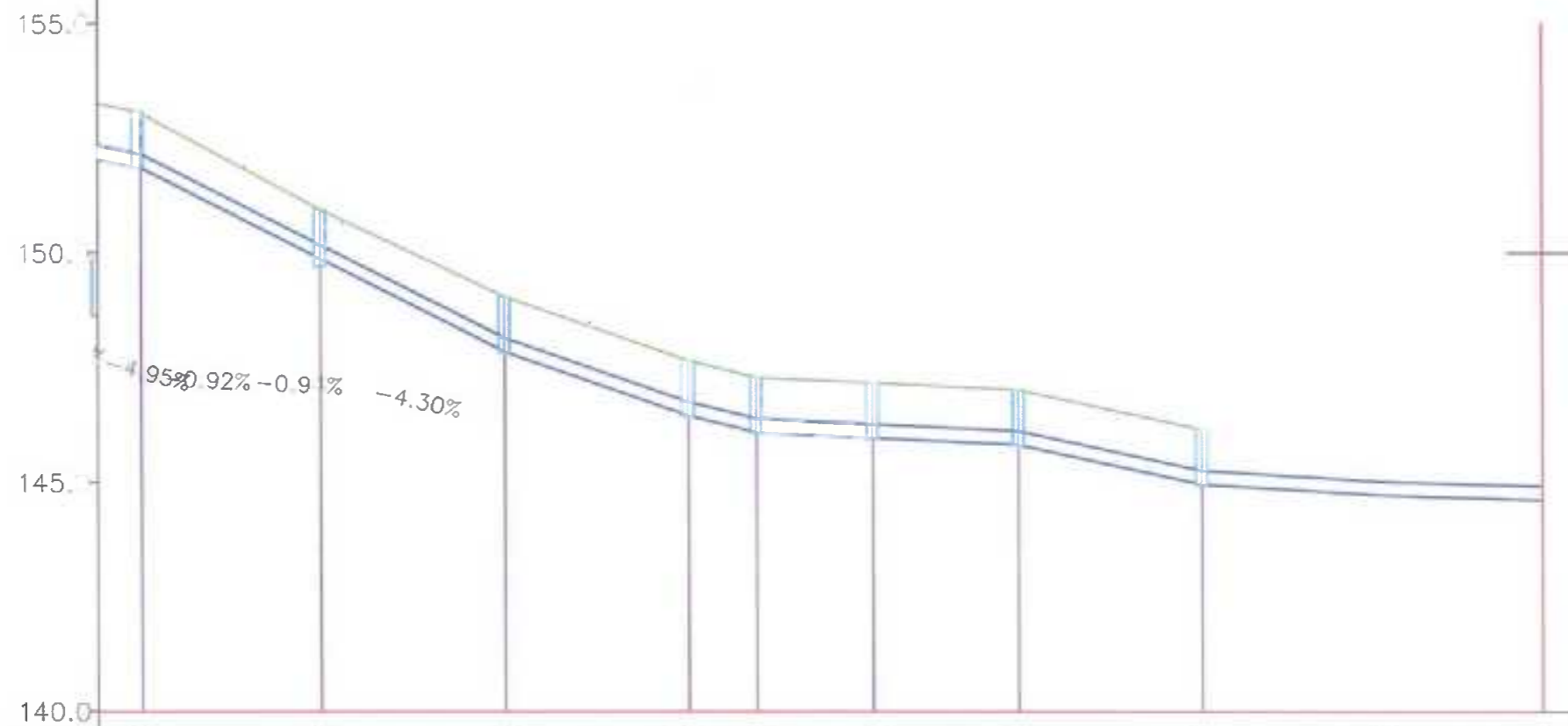

NUMERI PROFILIEVE	+18	+19	+21	+24	+24	+26	+27	+29	+31	
DISTANCA PROGRESIVE	18	19	21	24	24	26	27	29	31	
DISTANCA PJESORE		19,66	20,13	20,16	7,43	12,74	16,04	20,05	20,08	17,37
KUOTA E PROJEKTIT	51.8	49.8	47.8	46.4	46.0	45.9	45.8	44.9	44.7	
KUOTA E TERENIT	53.0	50.9	49.0	47.6	47.2	47.1	47.0	46.1	47.7	
KILOMETRAZHI										

Porosites	Vula
Projektaues	Vula
Ing. Nd: A. VOGLI	Ing. To: P. REGASI
Ing. Nd: A. FATLLARI	Ing. E. M. ...
Ing. Nd: ...	Ing. Ele: ...
Projektaues	Vula
Ing. Nd: V. GRUDA	

PROJEKTI: Rehabilitimi i rrugëve të bllokut që kufizohet nga rrugët "Leandro Zoto" - "Mari Kraja" - "Disha" - "Sadik Petrela"	EMËRTIMI I FLETËS: Projekt-Zbatim Prerje Gjatesore KUB Rruga "Kadillari"
Shkalla: 1:200	Numri i fletës: F-2

Profili : MUSTAFA MEHIDRI
 Shkalla : 1000:200
 Kuota Ref : 140.00

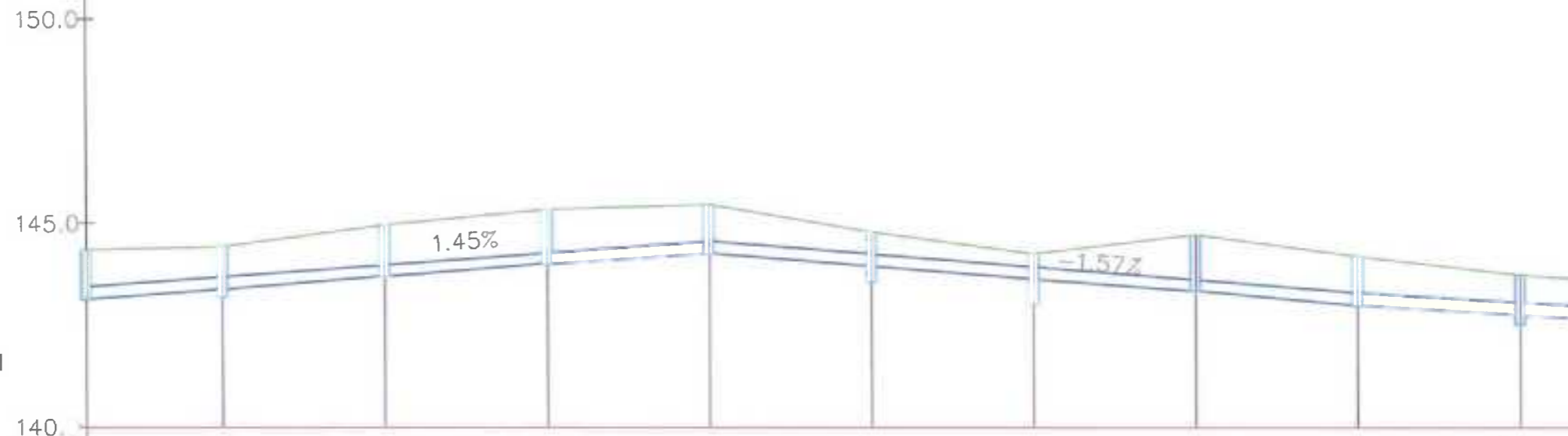

NUMERI PROFILIEVE											
DISTANCA PROGRESIV		+017	+037	+057	+077	+097	+117	+137	+157	+177	2
DISTANCA PJESORE	16,87	20,00	20,00	20,00	20,01	20,03	20,02	20,02	20,01		
KUOTA E PROJEKTIT	44.4	43.3	44.9	43.6	45.3	43.9	44.7	43.6	44.7	43.0	42.7
KUOTA E TERENIT				0	45.4	44.2	44.7	43.9	44.2	43.0	42.7
KILOMETRAZHI											

 BASHKIA E TIRANES DREKTORIA E PERKULLESEME E PUNEVE PUBLIKE		Vula
 HE & SK 11 consulting company		Vula
Ing. Nd: A VOGRRI Ing. Nd: A REFATERI Ing. Nd. M. ... 		
 PALMA CONSTRUCTION shpk Arkitektura, Shpirtore, Inxhinieri dhe Konsultime		Vula
Ing. Nd: V. GRUDA		
PROJEKTI: Rehabilitimi i rrugëve të bllokut që kufizohet nga rrugët "Leandro Zoto" - "Mari Kraja" - "Disha" - "Sadik Petrela"		EMËRTIMI I FLETES: Projekt-Zbatim Për një Gjatesore KUB Rruga "Mustafa Mehidri"
Shkalla: 1:200		Numri i fletes: F-1

Profili : MUSTAFA MEHIDRI
 Shkalla : 1000:200
 Kuota Ref : 140.00

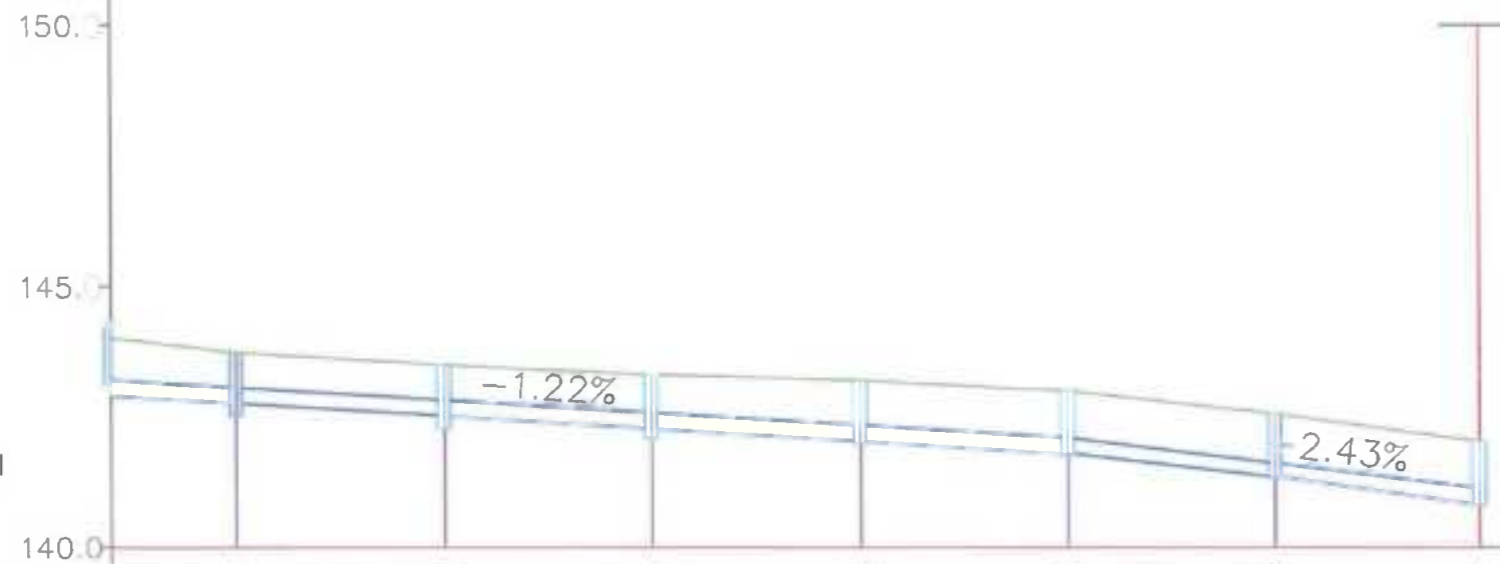

NUMERI PROFILIEVE							
DISTANCA PROGRESIVE	+177	+197	+217	+237	+257	+277	
DISTANCA PJESORE	0,01	20,00	20,01	20,00	20,00	19,99	19,72
KUOTA E PROJEKTIT	42.7	42.5	42.2	42.0	41.7	41.3	
KUOTA E TERENIT	43.7	43.5	43.3	43.2	42.9	42.5	
KILOMETRAZHI							

Porosites  BASHKIA E TIRANËS DREJTORIA E PËRGJITHSHME E PUNEVE PUBLIKE		Vula
Projektues  HE & SK 11 consulting company		Vula
Ing. Nd: A. Z. REZAI	Ing. To: P. MEGASI	
Ing. N: A. REZAI	Ing. Mek: E. MUCAJ	
Ing. Nd: M. BEDAJ	Ing. Elek: D. DANAJ	
Projektues  PALMA CONSTRUCTION shpk Projektim, mbartjeje dhe lidhjeje punimeve ndërtimore Arkitekture, Strukturë, Inxhinjeri dhe lehtësi strukturale		Vula
Ing. Nd: V. GRUDA		
PROJEKTI: Rehabilitimi i rrugëve të bllokut që kufizohet nga rrugët "Leandio Zoto" - "Mari Kraja" - "Disha" - "Sadik Petrela"		EMERTIMI I FLETËS: Projekt-Zbatim Prerje Gjatesore KUB Rruga "Mustafa Mehidi"
Shkalla: 1:200		Numri i fletës: F-2

Profili : DEG-1- TONIN HARAPI
Shkalla : 1000:200
Kuota Ref : 150.00

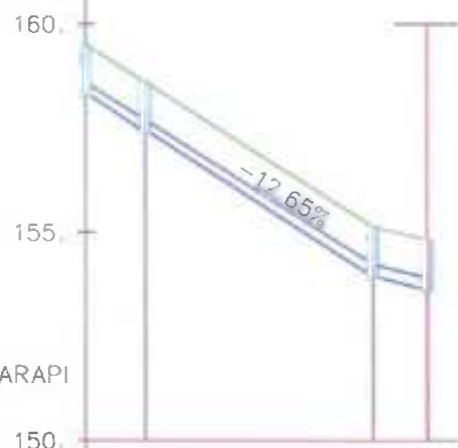

NUMERI PROFILIEVE	Sc-2		Sc-3
DISTANCA PROGRESIV	+00	+03	+03
DISTANCA PJESORE	7,23	27,37	3,57
KUOTA E PROJEKTIT	57.4	53.9	53.9
KUOTA E TERENIT	58.6	55.1	55.1
KILOMETRAZHI			

Profili : DEG-3- DISHA
Shkalla : 1000:200
Kuota Ref : 140.00

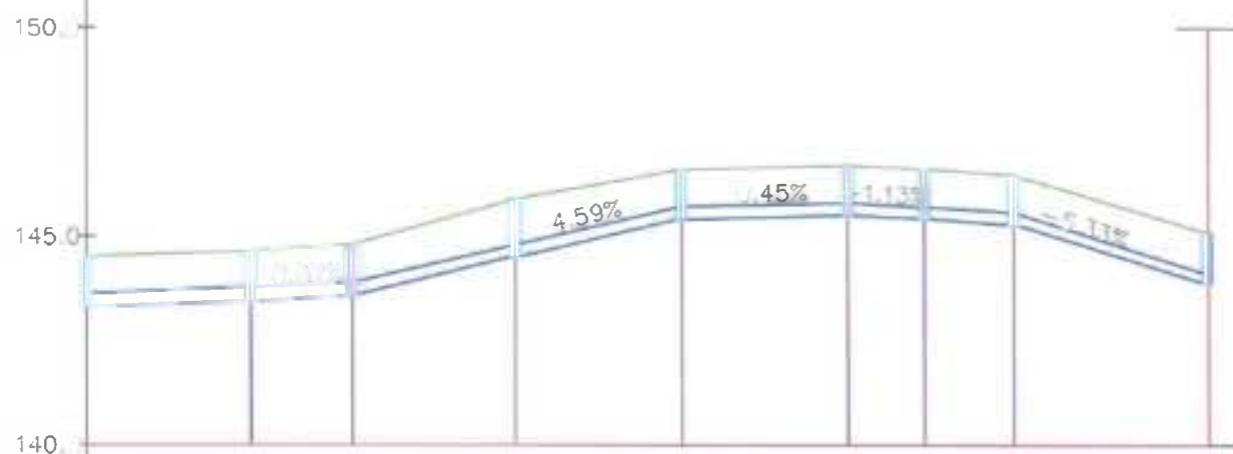

NUMERI PROFILIEVE	Sc-2		Sc-3	Sc-4	Sc-5	Sc-6	Sc-7	Sc-8
DISTANCA PROGRESIVE	+07	+03	+05	+07	+09	+101	+112	
DISTANCA PJESORE	19,65	12,23	19,65	19,97	19,99	9,23	10,81	23,43
KUOTA E PROJEKTIT	43.4	43.6	44.5	45.4	45.5	45.4	45.2	45.2
KUOTA E TERENIT	44.6	44.8	45.8	46.6	46.7	46.6	46.4	46.4
KILOMETRAZHI								

Porosites

BASHKIA E TIRANES
DREJTORIA E PERQJITHSIME
E PUNIVE PUBLIKE

Vula

Projektues

HE & SK 11
consulting company

Vula

Ing. Nd. A. MEGAJ

Ing. Nd. E. MEGAJ

Ing. Nd. M. BEGAJ

Ing. Fletk. N. MEGAJ

Projektues

PALMA CONSTRUCTION shpk
Projektim, ndërtim dhe mirëmbajtje e infrastrukturës
Arkitektura, Struktura, Inxhinjeri dhe Infrastruktura

Vula

Ing. Nd. V. GRUDA

PROJEKTI:
Rehabilitimi i rrugëve të bllokut që kufizohet nga rrugët "Leandio Zoto" - "Mari Kraja" - "Disha" - "Sadik Petrela"

EMËRTIMI I FLETËS:
Projekt-Zbatim
Përje Gjatesore KUB
Rruga "Tonin Harapi" dhe "Disha"

Shkalla: 1:250

Numri i fletës: F-1

Profili : DEG-2- FRANSUA PUKVIL
 Shkalla : 1000:200
 Kuota Ref : 140.00

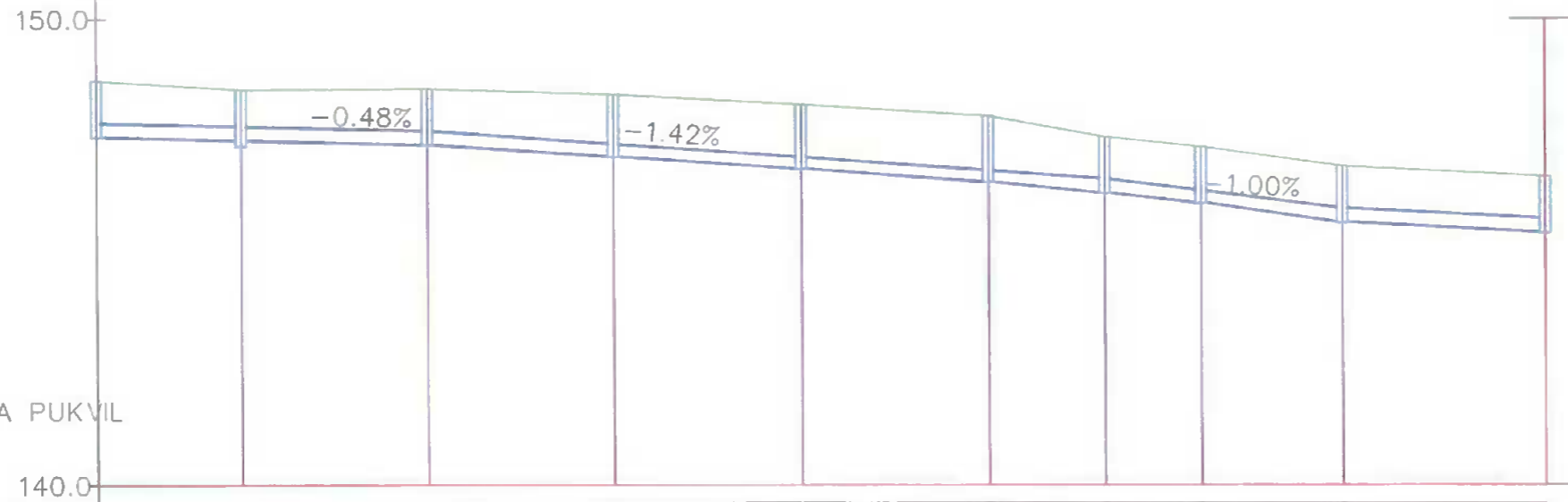

NUMERI PROFILIEVE										
DISTANCA PROGRESIVE	0+01	0+03	0+05	0+07	0+09	0+10	0+11	0+13		
DISTANCA PJESORE	15,59	19,99	19,99	20,21	20,11	12,54	10,38	15,27	21,85	
KUOTA E PROJEKTIT	148.49	148.51	148.39	148.16	147.92	147.47	147.26	146.85		
KUOTA E TERENIT	147.40	147.31	147.03	146.74	146.45	146.28	146.02	145.65		
KILOMETRAZHI			00		01				01	

 BASHKIA E TIRANES DREJTORIA E PERGJITHSIMIT E PUNEVE PUBLIKE	Vula
 HE & SK 11 consulting company	Vula
Ing. Nd. A. ... Ing. Nd. A. ... Ing. Nd. M. ...	Ing. Top. F. ... Ing. M. ... Ing. E. ...
 PALMA CONSTRUCTION shpk Projektim ndaluesqte shkolle dhe meqanorsh ndaluesqte Arkitektura, Shkollim dhe projektim infrastrukturash	Vula
Ing. Nd: V. GRUDA	
PROJEKTI: Rehabilitimi i rrugëve të bllokut që kufizohet nga rrugët "Leandro Zoto" - "Mari Kraja" - "Disha" - "Sadik Petrela"	EMERTIMI I FLETES Projekt-Zbatim Prerje Gjatesore KUB Rruga "Fransua Pukvil" Shkalla: 1:200 Numri i fletes: F-1

Profil : XHEMOLLARI
Shkalla : 1000:200
Kuota Ref : 140.00

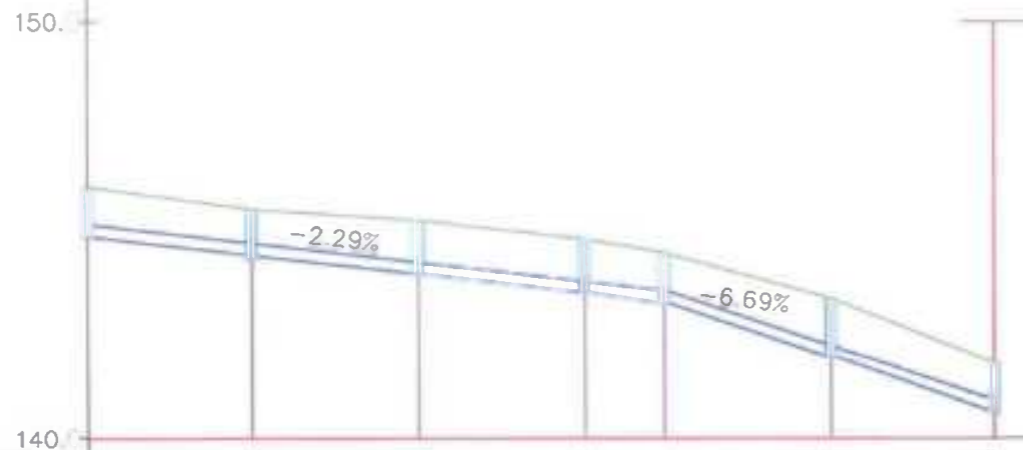

NUMERI PROFILIEVE						
DISTANCA PROGRESIVE	+02	+04	+06	+06	+08	
DISTANCA PJESORE	19,64	20,01	20,00	9,54	20,00	19,64
KUOTA E PROJEKTIT	44.3	43.9	43.4	43.2	41.9	
KUOTA E TERENIT	45.5	45.2	44.7	44.4	43.3	41.9
KILOMETRAZHI						

Profil : VANGJUSH MEKSI
Shkalla : 1000:200
Kuota Ref : 130.00

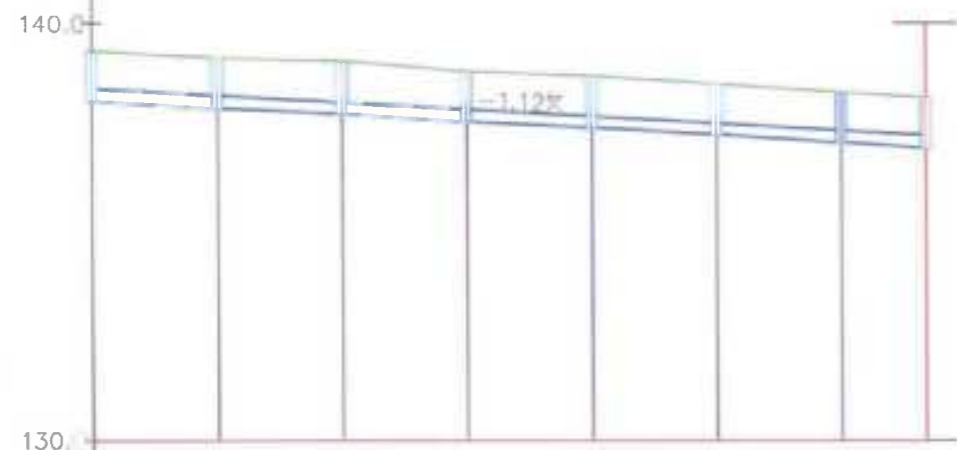

NUMERI PROFILIEVE						
DISTANCA PROGRESIVE	+01	+03	+04	+06	+07	+09
DISTANCA PJESORE	15,00	15,00	15,00	15,00	15,00	10,17
KUOTA E PROJEKTIT	39.1	39.1	38.8	38.7	38.5	38.3
KUOTA E TERENIT	39.1	39.1	38.8	38.7	38.5	38.3
KILOMETRAZHI						

Porosites



BASHKIA E TIRANËS
DREJTORIA E PËRGJITHSHME
E PUNEVE PUBLIKE

Vula

Projektues



HE & SK 11
consulting company

Vula

Ing. Nd. V. GRUDA

Ing. Top. E. MUSAJ

Ing. N. A. REFATLLANI

Ing. Nd. M. BEGAJ

Ing. Elg. N. DANAJ

Projektues



PALMA CONSTRUCTION shpk
Projektim, mbledhje dhe shërbime të punëve të ndërtimit
Aktiviteti: Shërbime të ndërtimit dhe mbledhje të informacionit

Vula

Ing. Nd. V. GRUDA

PROJEKTI:
Rehabilitimi i rrugëve të
bilokut që kufizohet nga
rrugët "Leandro Zoto" -
"Mari Kraja" - "Disha" -
"Sadik Petrela"

EMËRTIMI I FLETËS:
Projekt-Zbatim
Përje Gjatesore KUB
Rruga "Xhemollari" dhe
"Vangjush Meksi"

Shkalla:
1:200

Numri i fletës:
F-1

PRERJE TERTHORE E KANALIT PER TUB PLASTIK Ø 315 mm.

PRERJE TERTHORE E KANALIT PER TUB PLASTIK Ø 315 mm

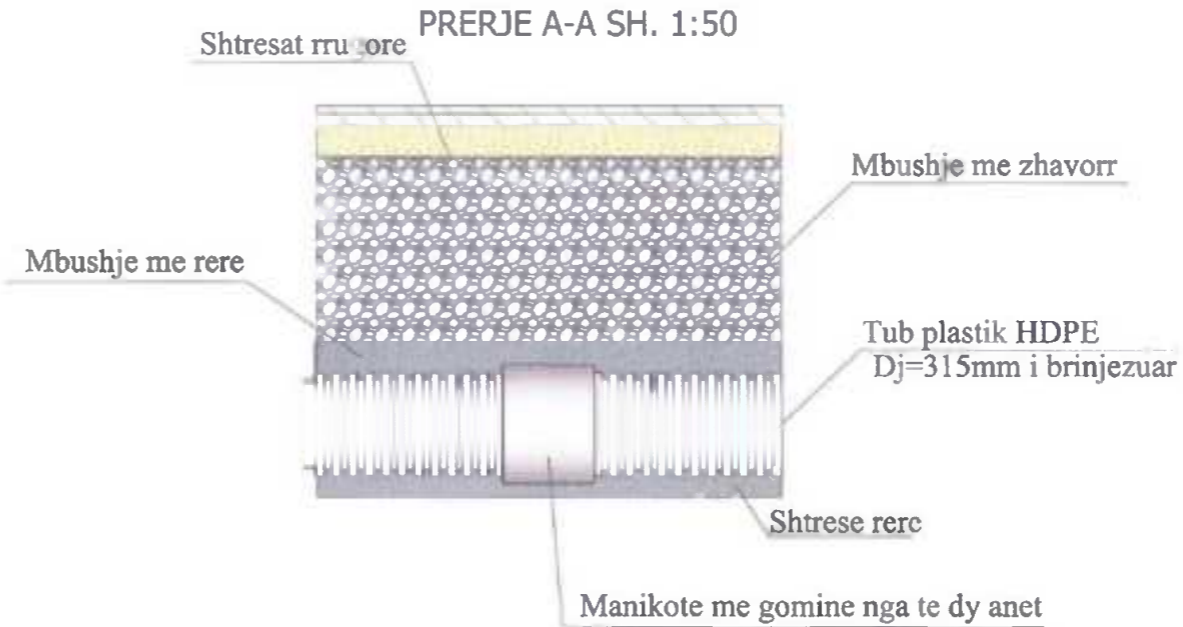
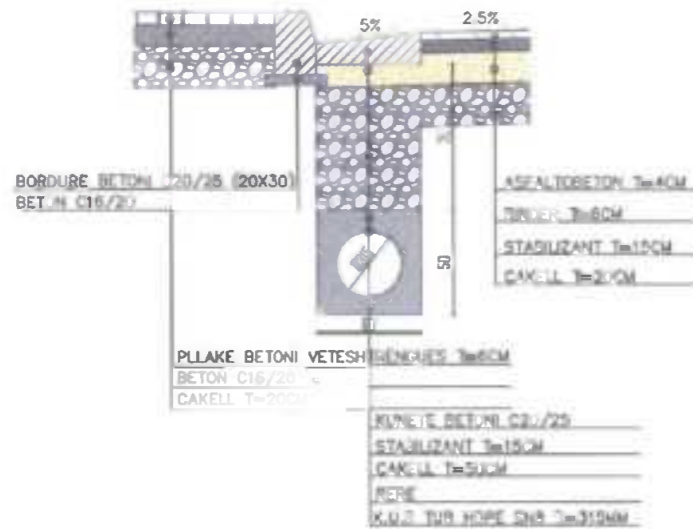

DETAJ I BASHKIMIT TE TUBAVE HDPE ME MANIKOTE SH. 1:50

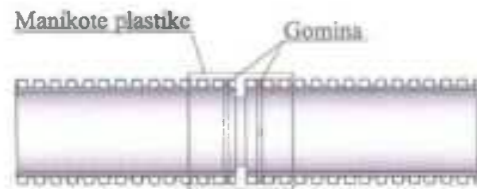

SHENIME TEKNIKE:

- NE KETE FLETE PROJEKTI ESHTË DHENË SEKSIONI MINIMAL PER GERMIMIN E KANALEVE PER KULLIMIN E UJRAVE TE SHIUT PER KATESISHT PER TUBA ME Dj=315 mm.

SHENIME:

- VOLUMET E DHENA NE TABELA JANE PER NJE THELLESI KANALI 1.2 ml DHE JANE LLOGARITUR PER NJE GJATESI KANALI PREJ 1 ml.
- VOLUMET E GERMIMIT DHE TE MBUSHJES ME ZHAVORR JANE LLOGARITUR DUKE ZBRITUR TRASHESINE E SHTRËSAVE RRUGORE, PER ARSYE SE ATO LLOGARITEN NE GERMIMET DHE NE MBUSHJET ME SHTRËSAVE RRUGORE
- PER THELLESI TE TJERA KANALI KA VOLUME TE TJERA

Nr.	EMERTIMI I PUNIMEVE	NJISIA	VOLUMET PER Ø TUBI
			Ø315mm
1	GERMIM DHEU PER KANAL	m ³	0.531
2	MBUSHJE ME RERE RRETH TUBIT	m ³	0.208
3	TUB PLASTIKE PHED, Dj =200,(315)(400)mm	ml	1.0
4	MANIKOTE PLASTIKE PHED, DN=400 mm	cope/ml	0.170
5	MBUSHJE ME ZHAVORR MBI TUB	m ³	0.243
6	TRANSPORT DHEU I TEPERT	m ³	0.531

<p>BASHKIA E TIRANËS DREJTORIA E PËRGJITHSHME E PUNËVE PUBLIKE</p>	Vula
<p>HE & SK 11 consulting company</p>	Vula
<p>Ing. Nd: A VOH Ing. Nd: A BEFATLARI Ing. Nd: M. BEDAJ</p>	<p>Ing. Top: F. SHKOCANI Ing. Mek: E. MUCAJ Ing. E. N. DAKAJ</p>
<p>PALMA CONSTRUCTION shpk Projektim, ndërtim dhe mbajtje e punimeve të ndërtimit. Arkitektura, Strukturat, impiante dhe mbajtje.</p>	Vula
<p>Ing. Nd: V. GRUDA</p>	
<p>PROJEKTI: Rehabilitimi i rrugëve të bllokut që kufizohet nga rrugët "Leandro Zoto" - "Mari Kraja" - "Disha" - "Sadik Petrela"</p>	<p>EMERTIMI I FLETËS: Projekt-Zbatim Prerje tertthore e kanalit per K.U.B</p>
<p>Shkalla:</p>	<p>Numri i fletes: F-</p>

DETAJ I NDERTIMIT TE Pusetes SE Mbledhjes TE Ujerve TE SHIUT

PLANIMETRIA SH. 1:20

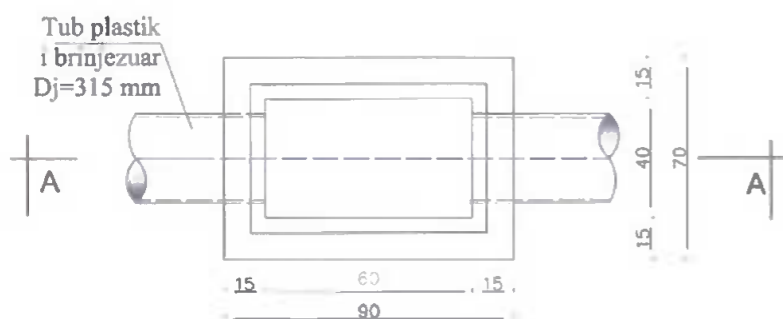

PRERJE B-B SH. 1:20

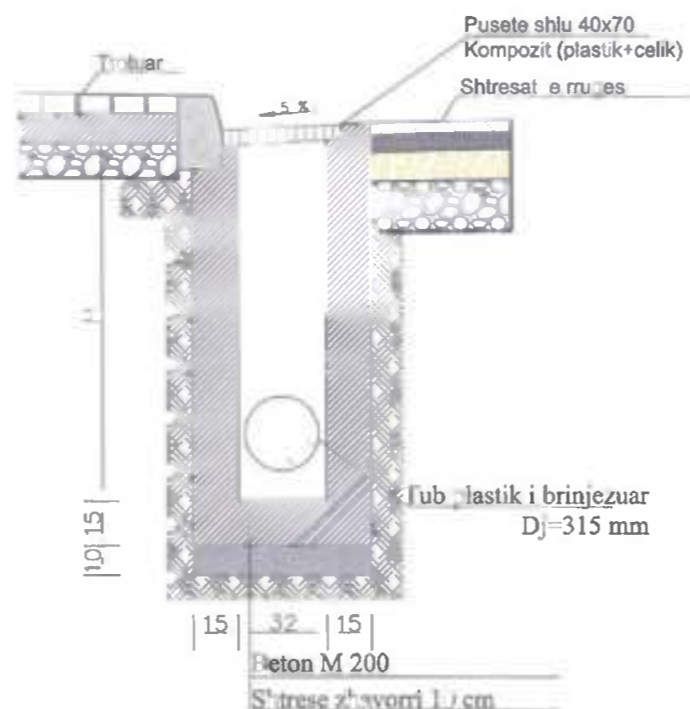

PLANIMETRIA SH. 1:20

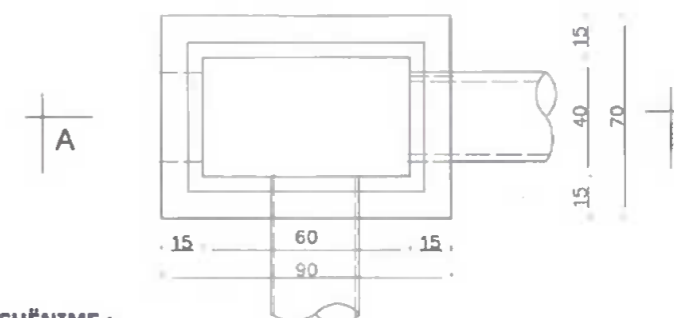

SHËNIME :

- 1.Muret e pusetes do te jene beton M-200 dhe me trashesi 15cm.
- 2.Telajo e kapakut do te jete prej material kompozit i inkastruar me brezin e betonit dhe i vendosur ne nivelin e mbaruar te rruges sipas projektit.
- 3.Fundi i tubit duhet te jete 10cm nga fundi i pusetes.
- 4.Diametri i tubit do te jete si ne planimetri.

PRERJE A-A SH. 1:20

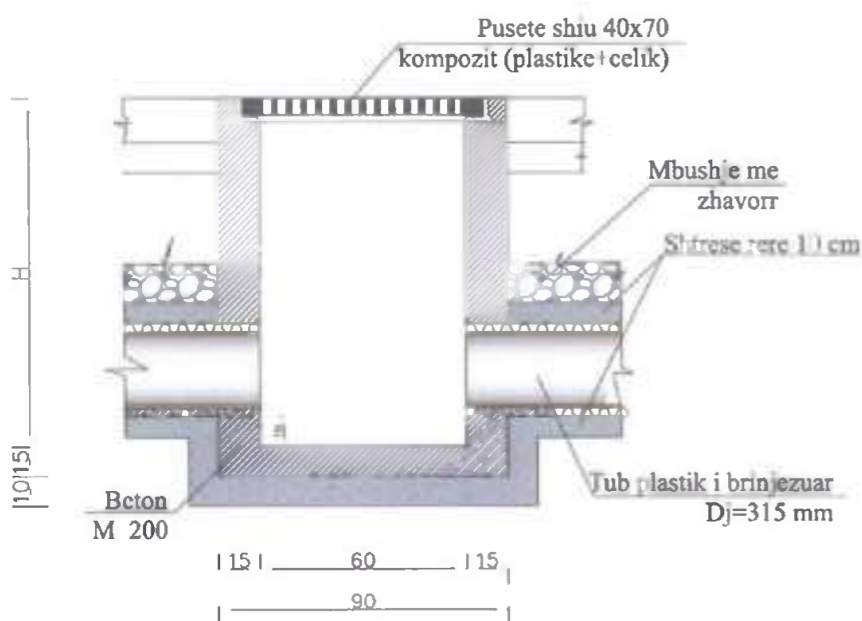

PLAN SH. 1:20

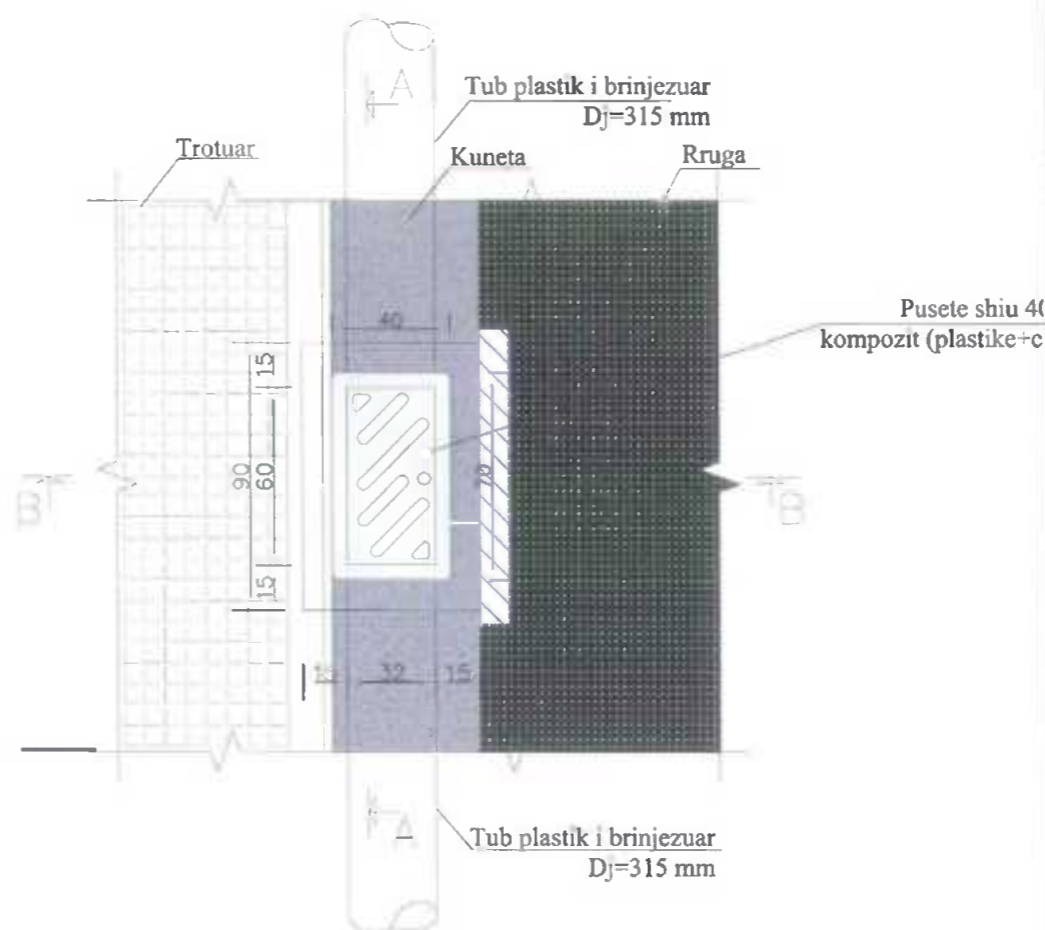

PAMJE NGA LART SH. 1:20

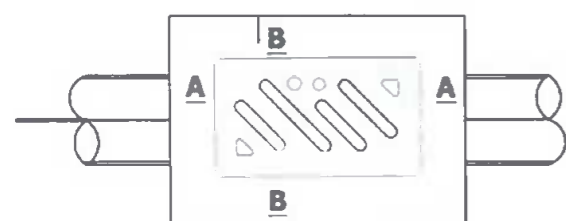

SHENIM:
 - NE KETE FLETE JANE PARAQITUR DETAJET E NDERTIMIT TE Pusetes SE Mbledhjes SE Ujerve TE SHIUT TIP 40 x70 cm ME ZGARE KOMPOZITE (PLASTIK+CELIK), TIPI P-1. KETO LLOJ Pusetash DO TE NDERTOHEN NE DISTANCEN SIKUNDER JEPET NE PLANIMETRINE E KANALIZIMIT TE Ujerve TE SHIUT DHE NE PROFILIN GJATESOR TE TYRE.

Porosites	Vula
 BASHKIA E TIRANËS DREKTORIA E PËRGJITHSHME E PUNEVE PUBLIKE	
Projektues	Vula
 HE & SK 11 consulting company	
Ing. Nd: A. VOGLI	Ing. Top: E. MUCALI
Ing. Nd: A. BEFATLEARI	Ing. Mek: E. MUCALI
Ing. Nd: M. BEDA	Ing. Fiek: N. KRAJA
Projektues	Vula
 PALMA CONSTRUCTION shpk Filiali i ndërtimit të rrugëve dhe infrastrukturës A & B Kuvendi i Shqipërisë, Kompleksi i Ministrive	
Ing. Nd: V. GRUDA	
PROJEKTI: Rehabilitimi i rrugëve të bllokut që kufizohet nga rrugët "Leandro Zoto" - "Mari Kraja" - "Disha" - "Sadik Petrela"	EMERTIMI I FLETES: Projekt-Zbatim Detaj i ndertimit te pusetes se mbledhjes se ujerave te shiut
Shkalla:	Numri i fletes:
	F-

DETAJ I NDERTIMIT TE Pusetes K.U.Z

PusetE TIP D=80cm

PRERJA 1-1 SHK.1:50

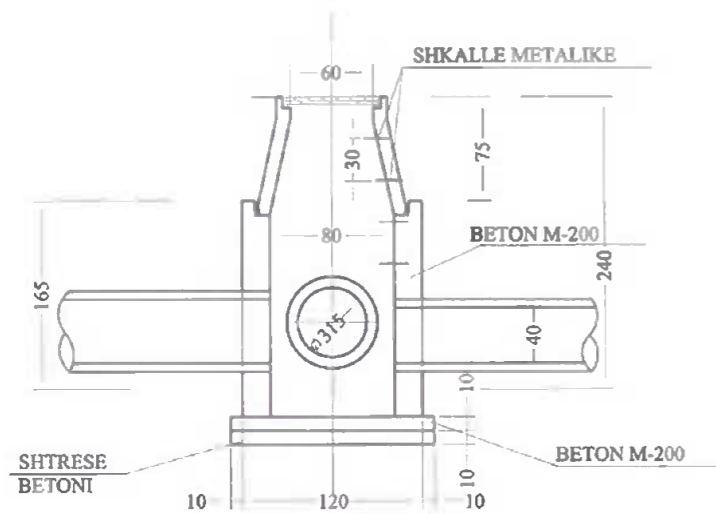

PRERJA 2-2 SHK.1:50

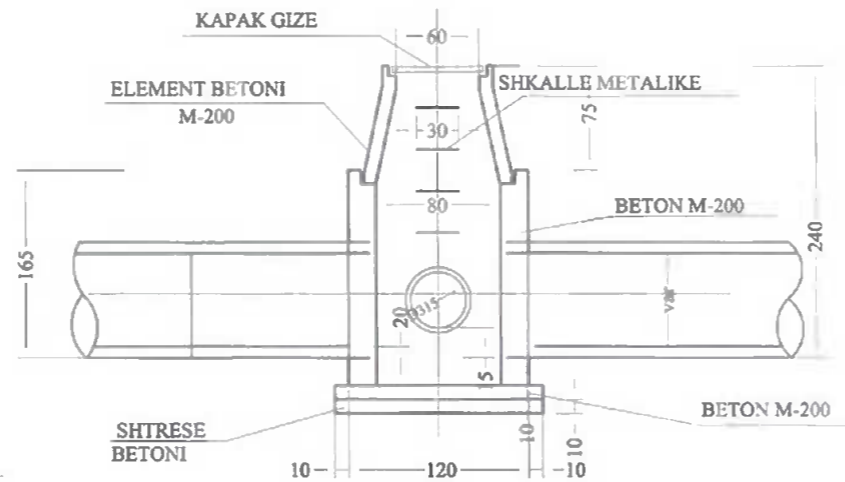

ELEMENT BETONI SHK.1:20

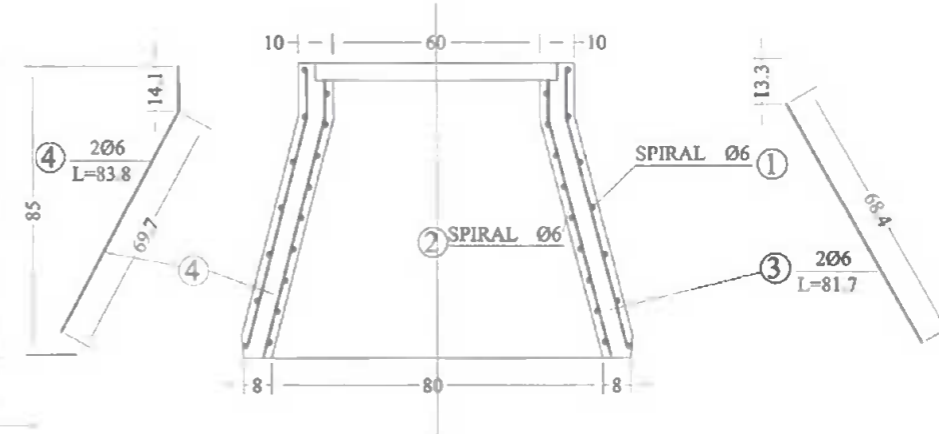

PLAN SHK.1:50

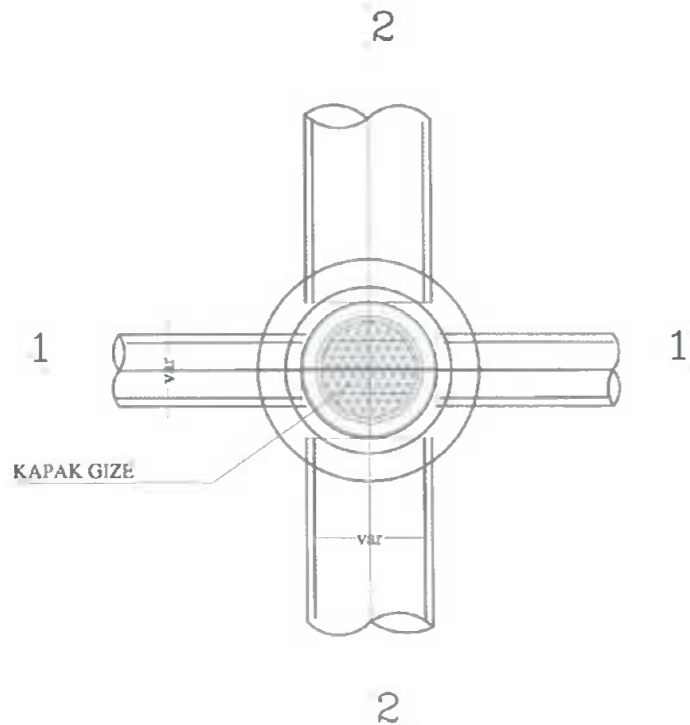

SPIRALI JASHEM SHK.1:20

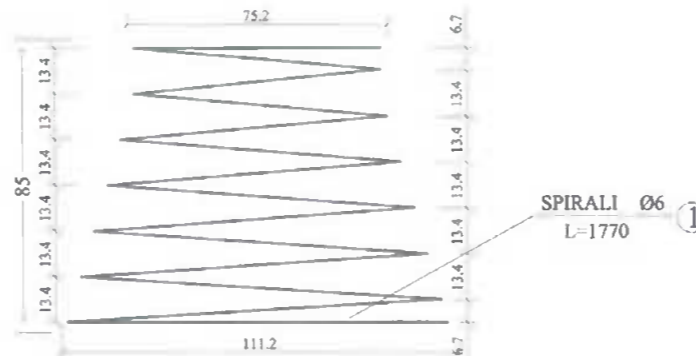

SPIRALI BRENDESHEM SHK.1:20

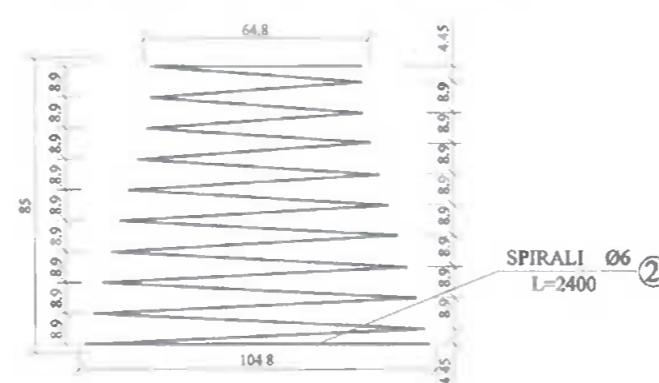

PLAN SHK.1:20

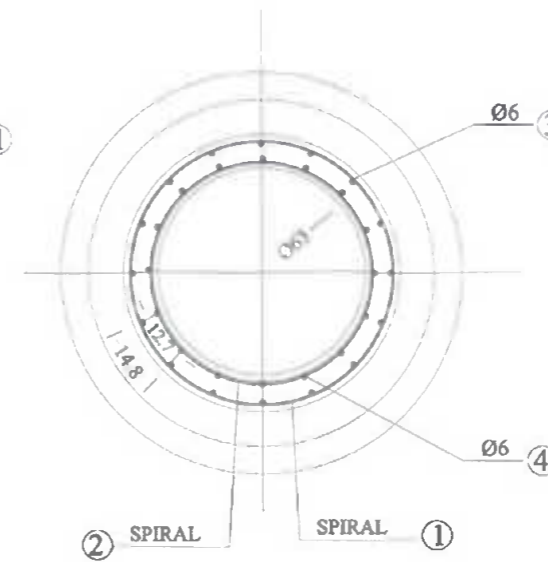

Porosites BASHKIA E TIRANËS DRËNJTORIA E PËRGJITHSIMIT E PUNËVE PUBLIKE	Vula
Projektues HE & SK 11 consulting company	Vula
Ing. Nd. A. V. GRUDA Ing. Nd. A. V. GRUDA Ing. Nd. M. DANAJ Ing. Nd. M. DANAJ	Vula
Projektues PALMA CONSTRUCTION shpk Projektim, inzhineri dhe bashkëpunim për ndërtim dhe infrastrukturë	Vula
Ing. Nd. V. GRUDA	Vula
PROJEKTI: Rehabilitimi i rrugëve të bllokut që kufizohet nga rrugët "Leandro Zoto" - "Mari Kraja" - "Disha" - "Sadik Petrela"	EMERTIMI I FLETES: Projekt-Zbatim Detaj i ndertimit te pusetes K.U.Z
Shkalla:	Numri i fletes: F-







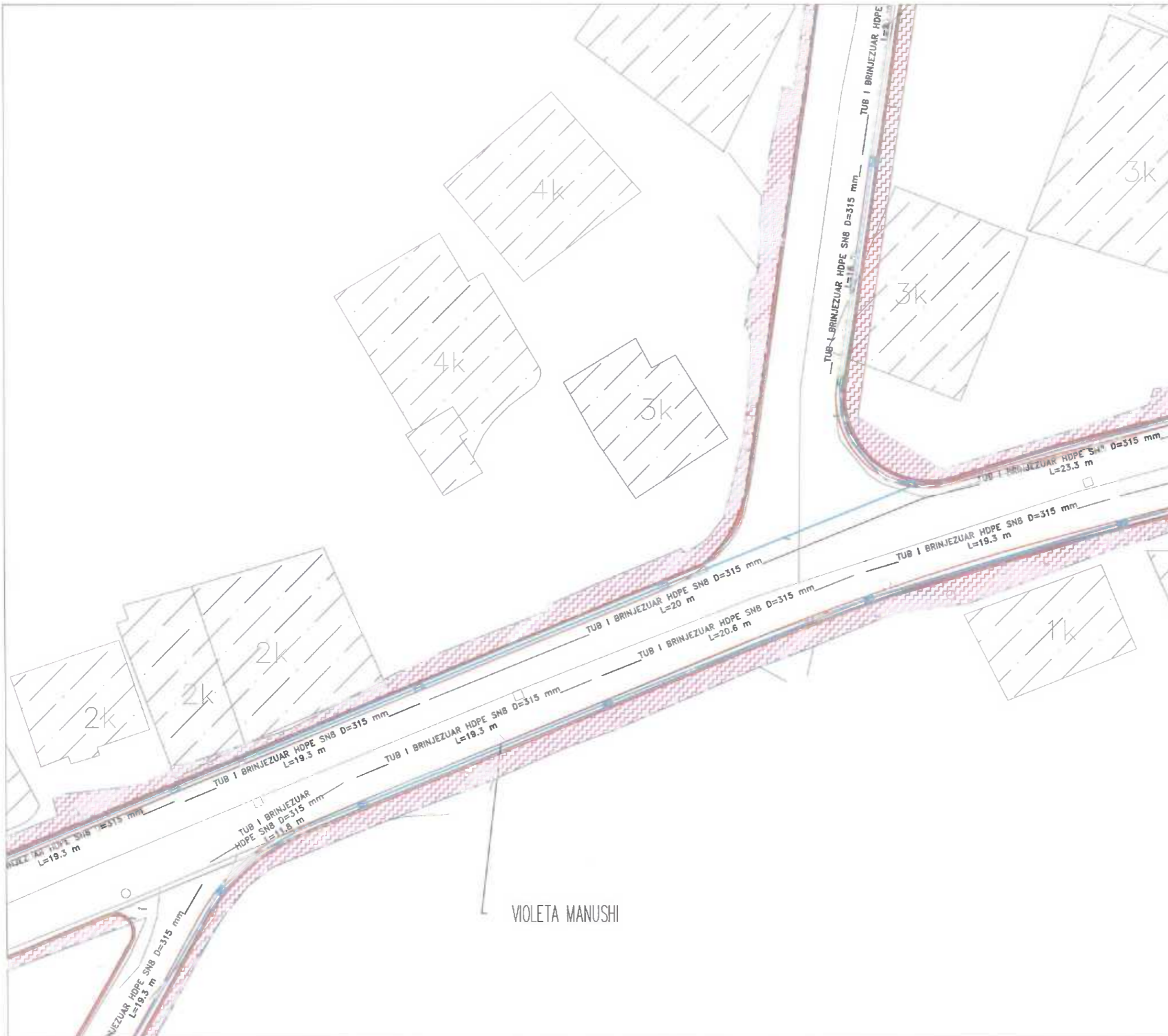

LEGJENDE

- BORDURE BETONI NE TROTUARIN E RI
- TROTUAR I RI
- KUNETE BETONI E RE
- RRUGE E SISTEMUAR
- NDERTESA EKZISTUESE
- PUSETE K.U.Z EKZISTUESE
- PUSETE K.U.SH 40 X 60 X 100 E RE

Porosites	 BASHKIA E TIRANËS DIREKTORIA E PËRGJITHSHME E PUNËVE PUBLIKE	Vula
BASHKIA TIRANË		
Projektues	 HE & SK 11 consulting company	Vula
Ing. Nd: A.V.	Ing. Top:	
Ing. Nd: A.	Ing. Mëk: E.	
Ing. Nd: M.	Ing. Elek: N.	
Projektues	 PALMA CONSTRUCTION shpk Projektues, mbajtëse dhe kopsullues i punimeve të ndërtimit Anëtarë të Shoqatës së Inxhinjerëve të Shqipërisë	Vula
Ing. Nd: V. GRUDA		
PROJEKTI: Rehabilitimi i rrugëve të bllokut që kufizohet nga rrugët "Leandro Zoto" - "Mari Kraja" - "Disha" - "Sadik Petrela"	EMËRTIMI I FLETËS: Projekt-Zbatim Planimetria e Përgjithshme K.U.B Rruga "Violeta Manushi" Degezimi I Rrugës "Violeta Manushi"	Shkalla: 1:75
		Numri i fletës: F-







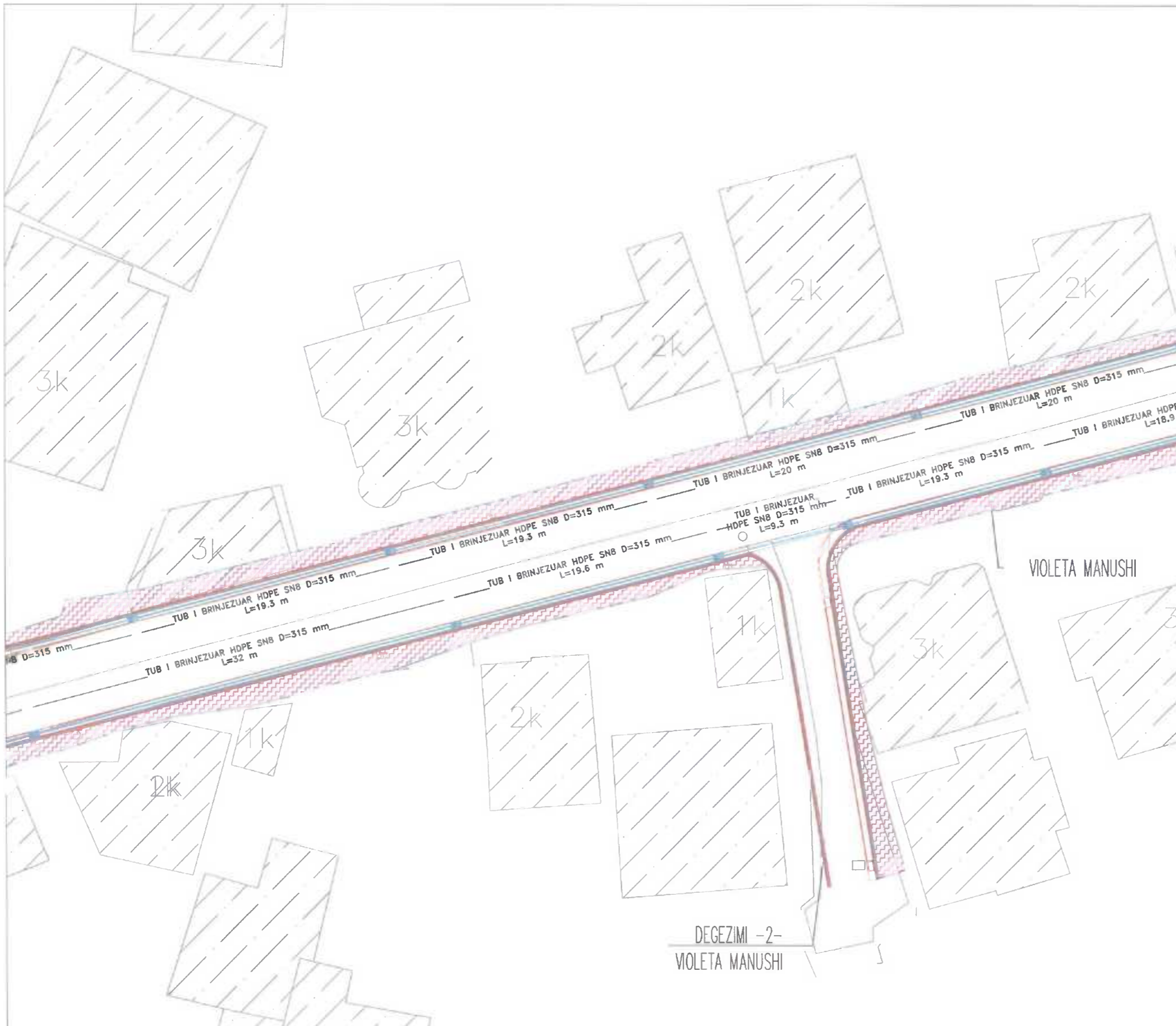

LEGJENDE

-  BORDURE BETONI NE TROTUARIN E RI
-  TROTUAR I RI
-  KUNETE BETONI E RE
-  RRUGE E SISTEMUAR
-  NDERTESA EKZISTUESE
-  PUSETE K.U.Z EKZISTUESE
-  PUSETE K.U.SH 40 X 60 X 100 E RE

 <p>BASHKIA E TIRANËS DREKTORIA E PËRQJESHTIME E PUNËVE PUBLIKE</p>		Vula
<p>BASHKIA TIRANË</p>		Vula
		Vula
Ing. Nd. V. GRUDA - IMP	Ing. Top. BREGASI	
Ing. Nd. R. ...	Ing. Mek. ...	
Ing. Nd. ...	Ing. Elek. ...	
		Vula
Ing. Nd. V. GRUDA		
<p>PROJEKTI: Rehabilitimi i rrugëve të bllokut që kufizohet nga rrugët "Leandro Zoto" - "Mari Kraja" - "Disha" - "Sadik Petrela"</p>		<p>EMËRTIMI I FLETES: Projekt-Zbatim Planimetria e Përgjithshme K.U.B Rruga "Violeta Manushi"</p>
Shkalla: 1:75		Numri i fletes: F-



LEGJENDE

-  BORDURE BETONI NE TROTUARIN E RI
-  TROTUAR I RI
-  KUNETE BETONI E RE
-  RRUGE E SISTEMUAR
-  NDERTESA EKZISTUESE
-  PUSETE K.U.Z EKZISTUESE
-  PUSETE K.U.SH 40 X 60 X 100 E RE

 <p>BASHKIA E TIRANËS DREJTORIA E PËRGJITHSHME E PUNËVE PUBLIKE</p>		Vula
<p>BASHKIA TIRANË</p>		Vula
		Vula
Ing. Nd: A.V. [Signature]	Ing. Top: F. PRECASI [Signature]	
Ing. Nd: A. BEKTELLARI [Signature]	Ing. Mer: E. MUKA [Signature]	
Ing. Nd: M. BEDI [Signature]	Ing. Mer: N. DHAJ [Signature]	
 <p>PALMA CONSTRUCTION shpk Projektim, mbalajtje dhe riparime punimesh industriale Arkitekturë, Struktura, impiante dhe infrastrukturë</p>		Vula
Ing. Nd: V. GRUDA [Signature]		
<p>PROJEKTI: Rehabilitimi i rrugëve të bllokut që kufizohet nga rrugët "Leandro Zoto" - "Mati Kraja" - "Disha" - "Sadik Petrela"</p>		<p>EMERTIMI I FLETES: Projekt-Zbatim Planimetria e Përgjithshme K.U.B Rruga "Violeta Manushi" Degezimi 2 Rruga "Violeta Manushi"</p>
Shkalla: 1:75		Numri i fletës: F-

DEGEZIMI -2-
VIOLETA MANUSHI



LEGJENDE

- BORDURE BETONI NE TROTUARIN E RI
- TROTUAR I RI
- KUNETE BETONI E RE
- RRUGE E SISTEMUAR
- NDERTESA EKZISTUESE
- PUSETE K.U.Z EKZISTUESE
- PUSETE K.U.SH 40 X 60 X 100 E RE





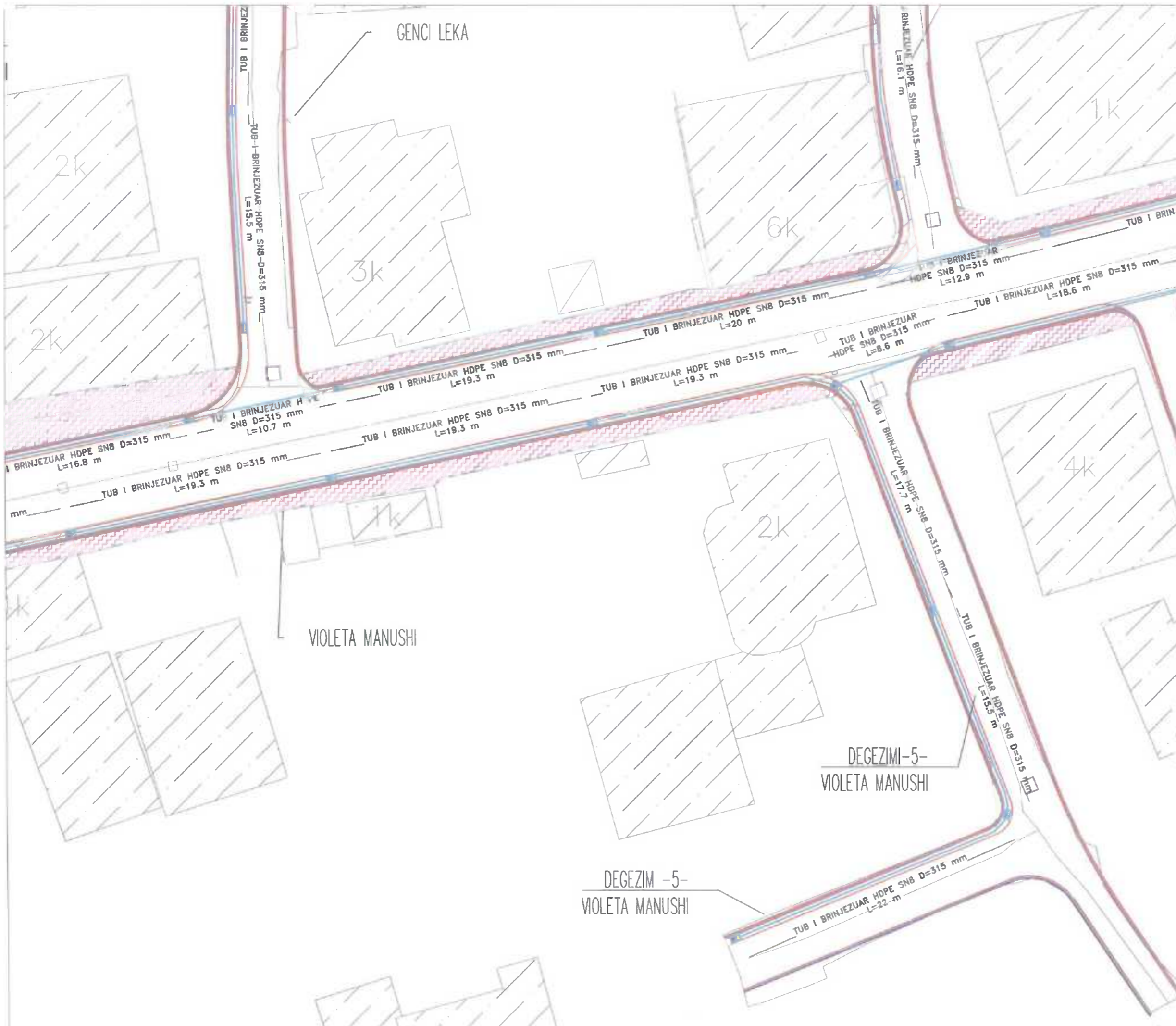

	BASHKIA E TIRANES <small>DREJTORIA E PERGJITHSHEME E PUNEVE PUBLIKE</small>	Vula
BASHKIA TIRANË		
	HE & SK 11 <small>consulting company</small>	Vula
Ing. Nd: A. VOCA	Ing. To: E. SREGASI	
Ing. Nd: A. REFATLLARI	Ing. Mek: E. MUCAJ	
Ing. Nd: M. BENAJ	Elek: N. ANAJ	
	PALMA CONSTRUCTION shpk <small>Projektim, ndërtim dhe këmbim i punëve të ndërtimit Arkitektura, strukturë, sipërfaqe dhe infrastrukturë</small>	Vula
Ing. Nd: V. GRUDA		

PROJEKTI: Rehabilitimi i rrugëve të bllokut që kufizohet nga rrugët "Leandro Zoto" - "Mari Kraja" - "Disha" - "Sadik Petrela"	EMËRTIMI I FLETES: Projekt-Zbatim Planimetria e Pergjithshme K.U.B Rruga "Violeta Manushi" Degezimi 4 Rruga "Violeta Manushi"
Shkalla: 1:75	Numri i fletes: F-

A MANUSHI









LEGJENDE

-  BORDURE BETONI NE TROTUARIN E RI
-  TROTUAR I RI
-  KUNETE BETONI E RE
-  RRUGE E SISTEMUAR
-  NDERTESA EKZISTUESE
-  PUSETE K.U.Z EKZISTUESE
-  PUSETE K.U.SH 40 X 60 X 100 E RE

 <p>BASHKIA E TIRANËS DIREKTORIA E PËRGJITHSHME E TËNËVE PUBLIKE</p>		Vula
		Vula
Ing. Nd: A VOGLI	Ing. Top: F. BRIGASI	
Ing. Nd: A. R. FATLLARI	Ing. Nd: E. M. CAJ	
Ing. Nd: M. BE...	Ing. Nd: N. PANAJ	
 <p>PALMA CONSTRUCTION shpk Projektim, ndërtim dhe shërbime ndërtimore Konsultime, strukturë, impiante dhe instalime</p>		Vula
Ing. Nd: V. GRUDA		
<p>PROJEKTI: Rehabilitimi i rrugëve të bllokut që kufizohet nga rrugët "Leandro Zoto" - "Mari Kraja" - "Disha" - "Sadik Petrela"</p>		<p>EMËRTIMI I FLETËS: Projekt-Zbatim Planimetria e Përgjithshme K.U.B Rruga "Violeta Manushi" Degezimi 5 Rruga "Violeta Manushi"</p>
Shkalla: 1:75		Numri i fletës: F-



LEGJENDE







-  BORDURE BETONI NE TROTUARIN E RI
-  TROTUAR I RI
-  KUNETE BETONI E RE
-  RRUGE E SISTEMUAR
-  NDERTESA EKZISTUESE
-  PUSETE K.U.Z EKZISTUESE
-  PUSETE K.U.SH 40 X 60 X 100 E RE

Porositës	 BASHKIA E TIRANËS DREJTORIA E PËRQËTISHMË E PUNËVE PUBLIKE	Vula
Projektues	 HE & SK 11 consulting company	Vula
Ing. Nd. PËRGLI	Ing. Top. BREGASI	
Ing. M. A. EFATLLARI SH.P.K	Ing. Mek. C. MUCAJ	
Ing. Nd. M. BEHAJ	Ing. Elek. N. DANAJ	
Projektues	 PALMA CONSTRUCTION shpk Projektim, ndërtim, riparim dhe mirëmbajtje e punëve publike Arhitektura, Struktura, Injeneria dhe Infrastruktura	Vula
Ing. Nd. V. GRUDA		

PROJEKTI: Rehabilitimi i rrugëve të bllokut që kufizohet nga rrugët "Leandro Zoto" - "Mari Krija" - "Disha" - "Sadik Petrela"	EMERTIMI I FLETES: Projekt-Zbatim Planimetria e PërqËtishmë e K.U.B Rruga "Violeta Manushi" Degezimi 6 Rruga "Violeta Manushi" Degezimi 7 Rruga "Violeta Manushi"
Shkalla: 1:75	Numri i fletës: F-



LEJJEDE







-  BORDURE BETONI NE TROTUARIN E RI
-  TROTUAR I RI
-  KUNETE BETONI E RE
-  RRUGE E SISTEMUAR
-  NDERTESA EKZISTUESE
-  PUSETE K.U.Z EKZISTUESE
-  PUSETE K.U.SH 40 X 60 X 100 E RE

 BASHKIA E TIRANËS DIREKTORIA E PËRGJITHSHME E PUNËVE PUBLIKE	Vula
Porositës	
Projektues 	Vula
Ing. Nd. A. VOJTIM - INGJERTIM - ING. T. GJ. BREGASI Ing. Nd. V. REFATI - ING. M. M. MUSAJ Ing. Nd. M. B. SAJ - ING. ELIK N. DANAJ	
Projektues  PALMA CONSTRUCTION shpk Projektim, rindërtim dhe rikonstruksionim për sektorin ndërtimtar Arkitekturi, Strukturë, Inxhinjeri dhe Informatikë	Vula
Ing. Nd. V. GRUDA	

PROJEKTI: Rehabilitimi i rrugëve të bllokut që kufizohet nga rrugët "Leandro Zoto" - "Mari Kraja" - "Disha" - "Sadik Petrela"	EMERTIMI I FLETES: Projekt-Zbatim Planimetria e Përgjithshme e K.U.B Rruga "Violeta Manushi" Degezimi 9 Rruga "Violeta Manushi"
Shkalla: 1:75	Numri i fletës: F-



LEGJENDE

-  BORDURE BETONI NE TROTUARIN E RI
-  TROTUAR I RI
-  KUNETE BETONI E RE
-  RRUGE E SISTEMUAR
-  NDERTESA EKZISTUESE
-  PUSETE K.U.Z EKZISTUESE
-  PUSETE K.U.SH 40 X 60 X 100 E RE





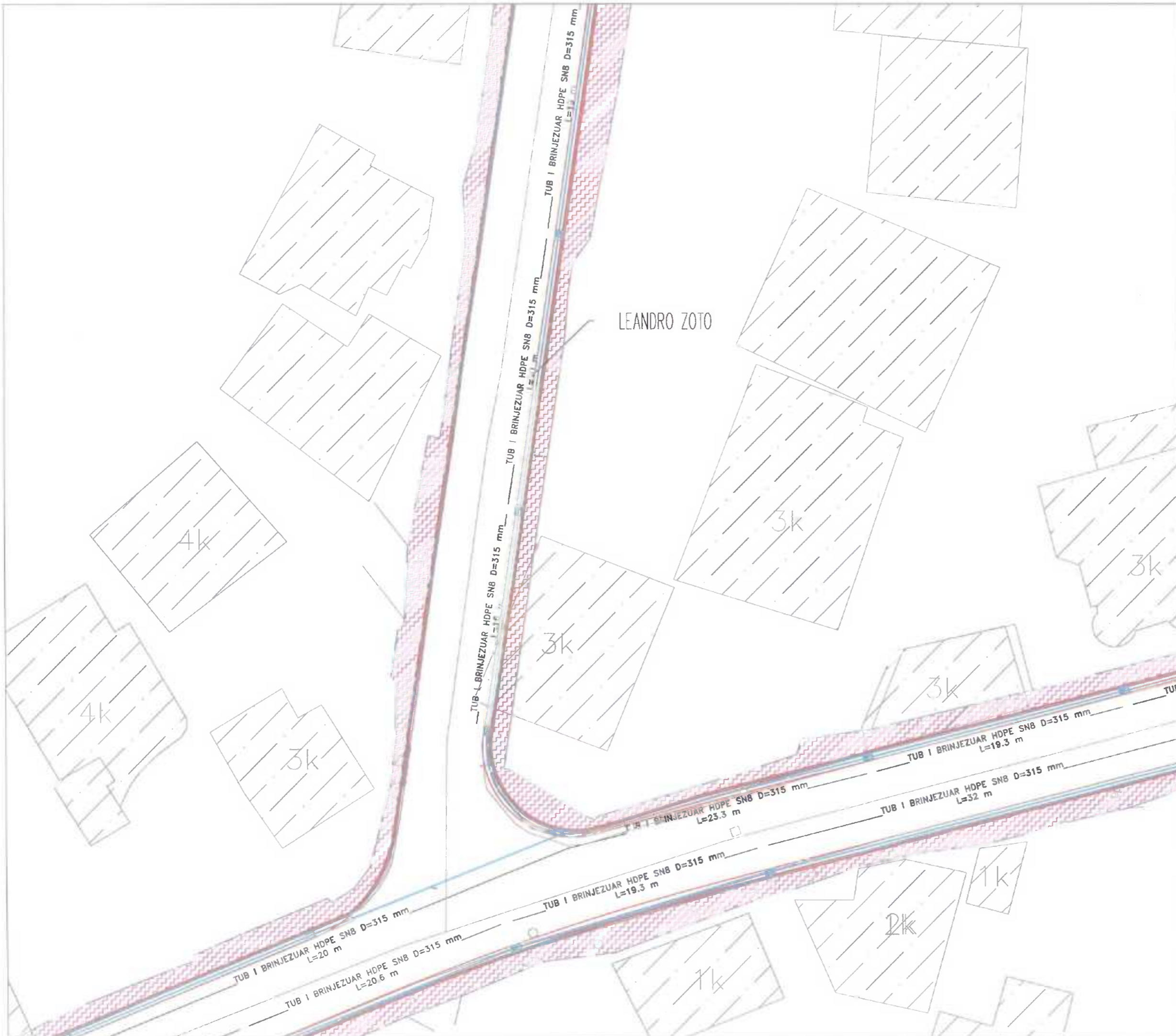

Porosites	 BASHKIA E TIRANËS DIREKTORIA E PËRGJITHSHME E PUNËVE PUBLIKE	Vula
Projektues	 HE & SK 11 consulting company	Vula
Ing. Nd. A. VOGLI	Ing. T. E. HEGASI	
Ing. Nd. A. BEFATHERI & SH. MIKE M. GJU		
Ing. Nd. M. ETIPI	Ing. El. K. T. RAJ	
Projektues	 PALMA CONSTRUCTION shpk Projektues, inzhinjere dhe kontraktorë të ndërtimit Arkitektura, strukturë, inxhinjeri dhe inf. sisteme	Vula
Ing. Nd. V. GRUDA		

PROJEKTI: Rehabilitimi i rrugëve të bllokut që kufizohet nga rrugët "Leandro Zoto" - "Miri Kraja" - "Disha" - "Sadik Petrela"	EMËRTIMI I FLETES: Projekt-Zbatim Planimetria e Përgjithshme e K.U.B Rruga "Violeta Manushi" Degezimi 10 Rruga "Violeta Manushi"
Shkalla: 1:75	Numri i fletës: F-



LEANDRO ZOTO

LEGENDE

-  BORDURE BETONI NE TROTUARIN E RI
-  TROTUAR I RI
-  KUNETE BETONI E RE
-  RRUGE E SISTEMUAR
-  NDERTESA EKZISTUESE
-  PUSETE K.U.Z EKZISTUESE
-  PUSETE K.U.SH 40 X 60 X 100 E RE

Porosites	 BASHKIA E TIRANËS DREJTORIA E PËRQIJITISHMË E PUNËVE PUBLIKE	Vula
Projektues	 HE & SK 11 consulting company	Vula
Ing. Nd. A. VOGLI	Ing. Top. F. BREGASI	
Ing. Nd. A. REFATLLARI	Ing. Mek. M. MLIKAJ	
Ing. Nd. M. BEDAJ	Ing. Elek. N. DANAJ	
Projektues	 PALMA CONSTRUCTION shpk Projektimi, ndërtimi dhe shërbime teknike Arkitektura, Shërbime Inxhinjerie dhe Infrastukturë	Vula
Ing. Nd. V. GRUDA		

PROJEKTI: Rehabilitimi i rrugëve të bilokut që kufizohet nga rrugët "Leandro Zoto" - "Mari Kraja" - "Disha" - "Sadik Petrela"	EMËRTIMI I FLETES: Projekt-Zbatim Planimetria e Përgjithshme K.U.B Rruga "Leandro Zoto"
Shkalla: 1:75	Numri i fletës: F-

LEANDRO ZOTO

TUB I BRINJEZUAR HDPE SNB D=315 mm

TUB I BRINJEZUAR HDPE SNB D=315 mm







TUB BRINJEZUAR HDPE SNB D=315 mm
L=18 m

TUB I BRINJEZUAR HDPE SNB D=315 mm
L=20 m

TUB I BRINJEZUAR HDPE SNB D=315 mm

DEGEZIMI-1-
LEANDRO ZOTO

LEGJENDE

-  BORDURE BETONI NE TROTUARIN E RI
-  TROTUAR I RI
-  KUNETE BETONI E RE
-  RRUGE E SISTEMUAR
-  NDERTESA EKZISTUESE
-  PUSETE K.U.Z EKZISTUESE
-  PUSETE K.U.SH 40 X 60 X 100 E RE

Porosites	Vula
 BASHKIA E TIRANËS DREJTORIA E PËRQJITSHMË E PUNËVE PUBLIKE BASHKIA TIRANË	

Projektues	Vula
	

Ing. Nd. A. V. ...	Ing. Top: F. ...
Ing. Nd. A. ...	Ing. Mërk. E. ...
Ing. Nd. M. ...	Ing. Elek. N. ...







Projektues	Vula
 PALMA CONSTRUCTION shpk Projektim, ndërtim dhe kërkime punimesh ndërtimore Arkitektura, Struktura, Impastat dhe Infrastruktura	

Ing. Nd. V. GRUDA

PROJEKTI: Rehabilitimi i rrugëve të bllokut që kufizohet nga rrugët "Leandro Zoto" - "Mari Kraja" - "Disha" - "Sadik Petrela"	EMËRTIMI I FLETËS: Projekt-Zbatim Planimetria e Përgjithshme K.U.B Rruga "Leandro Zoto" Degezimi I Rruga "Leandro Zoto"
Shkalla: 1:75	Numri i fletës: F-



LEGJENDE

-  BORDURE BETONI NE TROTUARIN E RI
-  TROTUAR I RI
-  KUNETE BETONI E RE
-  RRUGE E SISTEMUAR
-  NDERTESA EKZISTUESE
-  PUSETE K.U.Z EKZISTUESE
-  PUSETE K.U.SH 40 X 60 X 100 E RE

Porosites	Vula
 <p>BASHKIA E TIRANËS DIREKTORIA E PËRGJITHSHME E PUNËVE PUBLIKE</p>	
Projektues	Vula
	
Ing. Nd: A.V. ...	Ing. Nd: F. ...
Ing. Nd: A.Z. ...	Ing. Nd: M. ...
Ing. Nd: M. ...	Ing. Nd: N. ...
Projektues	Vula
 <p>PALMA CONSTRUCTION shpk Projektues dhe kontraktor i punëve publike Adresa: ...</p>	
Ing. Nd: V. GRUDA	

PROJEKTI: Rehabilitimi i rrugëve të bllokut që kufizohet nga rrugët "Leandro Zoto" - "Mari Kraja" - "Disha" - "Sadik Petrela"	EMËRTIMI I FLETES: Projekt-Zbatim Planimetria e Përgjithshme K.U.B Rruga "Leandro Zoto" Degezimi 2 Rruga "Leandro Zoto"
Shkalla: 1:75	Numri i fletës: F-



LEGJENDE

- BORDURE BETONI NE TROTUARIN E RI
- TROTUAR I RI
- KUNETE BETONI E RE
- RRUGE E SISTEMUAR
- NDERTESA EKZISTUESE
- PUSETE K.U.Z EKZISTUESE
- PUSETE K.U.SH 40 X 60 X 100 E RE

 BASHKIA E TIRANËS <small>DIREKTORIA E PËRZEMBEJESHËRISË E PUNËVE PUBLIKË</small> BASHKIA TIRANË		Vula
 HE & SK 11 <small>consulting company</small>		Vula
Ing. Nd: A. VOGLI Ing. Nd: E. REHAJ Ing. Nd: M. EDI	Ing. Top: F. BREGASI Ing. Mek: E. MUCAJ Ing. Elek: ANAJ	 ALBANIA
 PALMA CONSTRUCTION shpk <small>Shërbime dhe kontraste të ndërtimit dhe inxhinjeri</small>		Vula
Ing. Nd: V. GRUDA		
PROJEKTI: Rehabilitimi i rrugëve të bllokut që kufizohet nga rrugët "Leandro Zoto" - "Mari Kraja" - "Disha" - "Sadik Petrela"	EMËRTIMI I FLETËS: Projekt-7batim Planimetria e Përgjithshme K.U.B Rruga "Leandro Zoto"	
	Shkalla: 1:75	Numri i fletës: F-









LEGJENDE

- BORDURE BETONI NE TROTUARIN E RI
- TROTUAR I RI
- KUNETE BETONI E RE
- RRUGE E SISTEMUAR
- NDERTESA EKZISTUESE
- PUSETE K.U.Z EKZISTUESE
- PUSETE K.U.SH 40 X 60 X 100 E RE

 BASHKIA E TIRANËS DREKTORIA E PËRGJITHSHME E PUNËVE PUBLIKE BASHKIA TIRANË	Porosites Vula	
Projektues HE & SK 11 consulting company	Vula	
Ing. Nd: A. V. G. J. Ing. Nd: A. BEFATLLARI SH.P. Ing. Nd: M. BE D A J	Ing. Top: F. B. G. A S I Ing. Mek: M. CAJ Ing. Elék: N. DANA J	 Vula
Projektues PALMA CONSTRUCTION shpk Projektim, mbajtje, re dhe kaludim punimeve ndërtimore Arkitektura, Strukturë, Impante dhe infrastrukturë	Vula	
Ing. Nd: V. GRUDA		
PROJEKTI: Rehabilitimi i rrugëve të bllokut që kufizohet nga rrugët "Leandro Zoto" - "Mari Kraja" - "Disha" - "Sadik Petrela"	EMËRTIMI I FLETËS: Projekt-Zbatim Planimetria e Përgjithshme K.U.B Rruga "Leandro Zoto"	Shkalla: 1:75 Numri i fletës: F-



LEJGENDE

-  BORDURE BETONI NE TROTUARIN E RI
-  TROTUAR I RI
-  KUNETE BETONI E RE
-  RRUGE E SISTEMUAR
-  NDERTESA EKZISTUESE
-  PUSETE K.U.Z EKZISTUESE
-  PUSETE K.U.SH 40 X 60 X 100 E RE

 BASHKIA E TIRANËS DREJTORIA E PËRGRYETËSISË E PUNËVE PUBLIKË	Vula
 HE & SK 11 consulting company	Vula
Ing. Nd: A. VUJAN - IMP. T. F. REGASI Ing. Nd: A. REJA - IMP. T. F. REGASI Ing. Nd: M. D. J. - IMP. T. F. REGASI	Ing. Elek: V. ANAJ Ing. Elek: V. ANAJ
 PALMA CONSTRUCTION shpk Projektim, mbajtje dhe riparime punimesh ndërtimesh Rr. 1. Kren. Shkollorë, Tiranë, Republika e Kosovës	Vula
Ing. Nd: V. GRUDA	

PROJEKTI: Rehabilitimi i rrugëve të bllokut që kufizohet nga rrugët "Leandro Zoto" - "Mari Kraja" - "Disha" - "Sadik Petrela"	EMËRTIMI I FLETES: Projekt-Zbatim Planimetria e Përgjithshme K.U.B Rruga "Leandro Zoto" Degezimi 3 "Rruga 1 e Leandro Zoto"
Shkalla: 1:75	Numri i fletës: F-

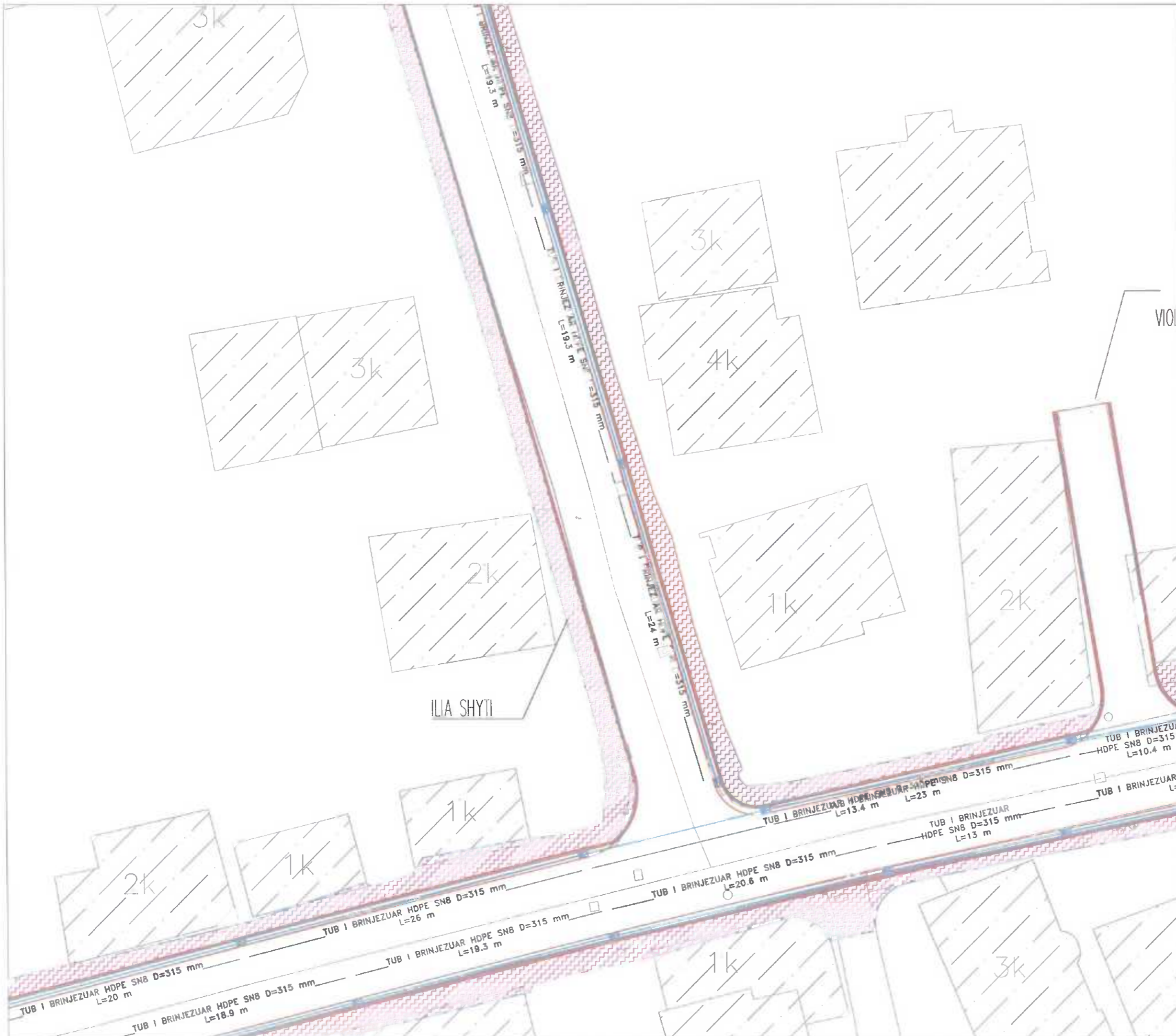







LEGJENDE

- BORDURE BETONI NE TROTUARIN E RI
- TROTUAR I RI
- KUNETE BETONI E RE
- RRUGE E SISTEMUAR
- NDERTESA EKZISTUESE
- PUSETE K.U.Z EKZISTUESE
- PUSETE K.U.SH 40 X 60 X 100 E RE

Porosites	BASHKIA E TIRANËS DREJTORIA E PËRQJITISHMIE E PUNËVE PUBLIKE	Vula
Projektues	HE & SK 11 consulting company	Vula
Ing. Nd. A VOGLI		REGASI
Ing. Nd. A BERTALLARI		Ing. Mek. E. M.
Ing. Nd. M. EDI		Ing. Elek. N. N. N.
Projektues	PALMA CONSTRUCTION shpk <small>Shërbime dhe kontraste të ndërtimit dhe inxhinjieri</small>	Vula
Ing. Nd. V. GRUDA		Vula
PROJEKTI:	Rehabilitimi i rrugëve të bllokut që kufizohet nga rrugët "Leandro Zoto" - "Mari Kraja" - "Disha" - "Sadik Petrela"	
EMËRTIMI I FLETËS:	Projekt-Zbatim Planimetria e Përgjithshme K.U.B Rruga "Ilia Shyti"	
	Shkalla: 1:75	Numri i fletës: 1-



LEGJENDE

-  BORDURE BETONI NE TROTUARIN E RI
-  TROTUAR I RI
-  KUNETE BETONI E RE
-  RRUGE E SISTEMUAR
-  NDERTESA EKZISTUESE
-  PUSETE K.U.Z EKZISTUESE
-  PUSETE K.U.SH 40 X 60 X 100 E RE

 <p>BASHKIA E TIRANËS DREJTORIA E PËRGJITHSHME E PUNËVE PUBLIKE</p>		Vula
 <p>HE & SK 11 consulting company</p>		Vula
Ing. Nd. A. VOGLI	Ing. Topi F. BREGASI	
Ing. Nd. A. REFA	Ing. Mek. E. MUGAJ	
Ing. Nd. M. BUDAJ	Ing. Elek. N. DANAJ	
 <p>PALMA CONSTRUCTION shpk Projektim, mbikëqim dhe kontrollim punimeve ndërtimore. Arkitektura, Shkëmbim, Inxhinieri dhe Infrastruktura</p>		Vula
Ing. Nd. V. GRUDA		
<p>PROJEKTI: Rehabilitimi i rrugëve të bllokut që kufizohet nga rrugët "Leandro Zoto" - "Mari Kraja" - "Disha" - "Sadik Petrela"</p>	<p>EMËRTIMI I FLETËS: Projekt-Zbatim Planimetria e Përgjithshme K.U.B Rruga "Ilia Shyti" Degezimi I Rruga "Ilia Shyti"</p>	
	Shkalla: 1:75	Numri i fletës: F-

EMERTIMI I FLETES:
 Projekti-Zhimm
 Planimetria e Përgjithshme K.U.B
 Dëgjimi i Kriqes "Sadik Petrela"
 "Marti Krata" - "Disha"
 "Sadik Petrela"
 PROJEKTI:
 Këmbitimi i rruges të
 rrugës "I. Andro Zoto"
 - "Disha"
 - "Sadik Petrela"
 Shkallë: 1:75
 Numri i fletës: F

Ing. Nd. V. GRUDA

Projektes
 PALMA CONSTRUCTION shpk
 Vula

Projektes
 Ing. Nd. A. MUKAJ
 Ing. Nd. M. DANAJ
 Ing. Nd. F. BREGASI

Projektes
 HE & SK 11
 consulting company
 Vula

Porosites
 BASHKIA E TIRANES
 DREKTORIA E PËRQYRTSIMIT
 BASHKIA E TIRANES
 Vula

LEGJENDE

-  BORDURE BETONI NE TROTUARIN E RI
-  TROTUAR I RI
-  KUNETE BETONI E RE
-  RRUQE E SISTEMUAR
-  NDERTESA EKZISTUESE
-  PUSETE K.U.Z EKZISTUESE
-  PUSETE K.U.SH 40 X 60 X 100 E RE



EMERTIMI I FLETES	Projekti/batim Planimetria e Përgjithshme K.1.B "Marti Krata" - "Disha" - "Sadik Petrela"	Shkalla: 1:75	Numbri i Fletes
-------------------	--	------------------	-----------------

Ing. Nd. V. GRUDA

Projektes
PALMA CONSTRUCTION shpk

Projektes
HE & SK 11
Ing. Nd. M. BREGASI

Projektes
HE & SK 11
consulting company

Postites
BASHKIA E TIRANES
BASHKIA E TIRANES

LEGJENDE

- BORDURE BETONI NE TROTUARIN E RI
- TROTUAR I RI
- KUNETE BETONI E RE
- BRUCE E SISTEMUAR
- NDERTESA EKZISTUESE
- PUSETE K.U.Z. EKZISTUESE
- PUSETE K.U.SH. 40 X 60 X 100 E RE



TONIN HARAPI

Projekti: "Sadik Petrela" - Rehabilitimi i rrugëve të rrugës "Lindore" dhe rrugës "Kujtim" në bashki të Sadik Petrela. Numri i Ndarjes: 1/75 Shkalla: 1:75	
Emri i Projektit: EMERTIMI I FLETES Autori: Projekti: Zbairim Planimetria dhe Projektimi i Bashkisë së Sadik Petrela	
Inj. Nr. V. GRUDA Inj. Nr. M. B. DANAJ Inj. Nr. M. K. M. DANAJ Inj. Nr. M. K. M. DANAJ Inj. Nr. M. K. M. DANAJ	Projekti: PALMA CONSTRUCTION shpk Projekti: HE & SK 11 Projekti: BASHKIA E TIRANË Projekti: BASHKIA E TIRANË
Inj. Nr. M. K. M. DANAJ Inj. Nr. M. K. M. DANAJ Inj. Nr. M. K. M. DANAJ Inj. Nr. M. K. M. DANAJ	

LEGJENDE

- BORDURË BETONI NE TROTUARIN E RI
- TROTUAR I RI
- KURËTE BETONI E RE
- RRUGË E SISTEMUAR
- NDERTESA EKZISTUESE
- PUSËTE K.U.Z EKZISTUESE
- PUSËTE K.U.SH 40 X 60 X 100 E RE



DEG

EMËRTIMI I FLETES:
 Projekti: Zbatim i planimetrisë dhe fergjithshme K. U. B. Kruga "Mustafa Mehidri"
 "Marti Kraka" - "Disha" -
 "Sadik Petrela"
 Projekti:
 Rehatimi i rrugëve të
 bllokut që kufizohet nga
 rrugët "Leandro Zoto" -
 "Sadik Petrela"
 Shkalla: 1:75
 Numri i fletës: R-

Ing. Nd. V. GRUDA

Projektes:
 Vula
 PALMA CONSTRUCTION shpk

Ing. Nd. M. D. DAJ
 Ing. E. E. N. DANAJ

Ing. N. A. REFALLARI
 Ing. M. K. E. M. J. CAJ
 Ing. Nd. V. GRUDA
 Ing. Nd. V. GRUDA

Projektes:
 Vula
 HE & SK 11
 consulting company

Porosites:
 Vula
 BASHKIA E TIRANË
 BASHKIA E TIRANË
 DREKTORIA E PROJEKTIMIT
 E PLANIT PËRIMTAR

LEGJENDE

	BORDURE BETONI NE TROTUARIN E RI
	TROTUAR I RI
	KUNTE BETONI E RE
	RRUGE E SISTEMUAR
	NDERTESA EKZISTUESE
	PUSETE K.U.Z. EKZISTUESE
	PUSETE K.U.SH. 40 X 60 X 100 E RE



EMERTIMI I FLETES	PROJEKTI:	Rehabilitimi i rrugeve te "Munt Kruga" - "Disha" - "Sadhik Petrela"
Projekt-zbatim Planimetria e Përgjithshme K.1.B Kryega "Mustafa Mehidi"	Projekti:	Rehabilitimi i rrugeve te "Munt Kruga" - "Disha" - "Sadhik Petrela"
Numri i fletes 1:75	Shkalla	

Ing. Nd. V. GRUDA

Projektes

PALMA CONSTRUCTION shpk

Ing. Nd. M. B. ...

Ing. Nd. M. B. ...

Ing. Nd. M. B. ...

Ing. Nd. M. B. ...

Projektes

HE & SK 11

Ing. Nd. M. B. ...

Ing. Nd. M. B. ...

Ing. Nd. M. B. ...

Ing. Nd. M. B. ...

Ing. Nd. M. B. ...

Ing. Nd. M. B. ...

Ing. Nd. M. B. ...

Ing. Nd. M. B. ...

Ing. Nd. M. B. ...

Ing. Nd. M. B. ...

Ing. Nd. M. B. ...

Ing. Nd. M. B. ...







Ing. Nd. M. B. ...

Ing. Nd. M. B. ...

Ing. Nd. M. B. ...

Ing. Nd. M. B. ...

Ing. Nd. M. B. ...

- LEGJENDE**
-  BORDURE BETONI NE TROTUARIN E RI
 -  TROTUAR I RI
 -  KUNETE BETONI E RE
 -  RRUGE E SISTEMUAR
 -  NDERTESA EKZISTUESE
 -  PUSETE K.U.Z. EKZISTUESE
 -  PUSETE K.U.SH 40 X 60 X 100 E RE



EMERTIMI I FLETES
 Projekti-Zbatim dhe Rregullimi i rrugëve të
 Rrugës "Mustafa Mehdiu"
 Planimetria e Përgjithshme K.U.B
 "Mati Krata" - "Disha"
 "Sadik Petela"
 Shkallë: 1:75
 Numri i Fletës

Ing. Nd. V. GRUDA

PALMA CONSTRUCTION shpk
 Projekti

Ing. Nd. M. FELAJ
 Ing. Elmi H. DANAU

Ing. Nd. Z. RIFLE
 Ing. Mek. B. MULLAJ







Ing. Nd. A. VOGLI
 BREGASI

HE & SK 11
 consulting company

BASHKIA E TIRANË
 DREKTORIA E PËRQUTITSHMË
 E PUNËS PUBLIKE
 POROSITËS

BASHKIA E TIRANË
 DREKTORIA E PËRQUTITSHMË
 E PUNËS PUBLIKE
 POROSITËS

LEGJENDE

-  BORDURË BETONI NE TROTUARIN E RI
-  TROTUAR I RI
-  KUNJETE BETONI E RE
-  RRUQE E SISTEMUAR
-  NDERTESA EKZISTUESE
-  PUSËTE K.U.Z EKZISTUESE
-  PUSËTE K.U.SH 40 X 60 X 100 E RE



EMERTIMI I FLETES:	Projekt-Zbatim Planimetria e Përgjithshme K.U.B Krye "Mustafa Mehdiu"	Shkalla 1:75	Numri i Fletes P-
PROJEKTI:	Rehabilitimi i rrugëve të në "Laudo Zoiu" - "Mati Krata" - "Disha" - "Sadik Peteha"		

Ing. Nd. V. GRUDA

PALMA CONSTRUCTION shpk
 "Për shërbime të ndërtimit dhe inxhinjerie"
 "Për shërbime të ndërtimit dhe inxhinjerie"

Projekues

Ing. Nd. M. ...

Ing. Nd. ...

Ing. Nd. ...

Ing. Nd. ...

Ing. Nd. ...

Ing. Nd. ...

Ing. Nd. ...

Ing. Nd. ...

Ing. Nd. ...

Ing. Nd. ...

Ing. Nd. ...

Ing. Nd. ...

Ing. Nd. ...

Ing. Nd. ...

Ing. Nd. ...

Ing. Nd. ...

Ing. Nd. ...

Ing. Nd. ...

Ing. Nd. ...

Ing. Nd. ...

Ing. Nd. ...

Ing. Nd. ...

Ing. Nd. ...

Ing. Nd. ...

Ing. Nd. ...

Ing. Nd. ...

Ing. Nd. ...

Ing. Nd. ...

Ing. Nd. ...

Ing. Nd. ...

Ing. Nd. ...

Ing. Nd. ...

Ing. Nd. ...

Ing. Nd. ...

Ing. Nd. ...

Ing. Nd. ...

Ing. Nd. ...

Ing. Nd. ...



Projekues

BASHKIA E TIRANË

DIREKTORIA E PËRCJELLSHMË
E FURNIMIT

BASHKIA E TIRANË

Porositës

Vula

Vula

Vula

Vula

Vula

Vula

Vula

Vula

Vula

Vula

Vula

Vula

Vula

Vula

Vula

Vula

LEGJENDE

- BORDURE BETONI NE TROTUARIN E RI
- TROTUAR I RI
- KUNETE BETONI E RE
- RRUGE E SISTEMUAR
- NDRRTESA EKZISTUESE
- PUSETE K.U.Z EKZISTUESE
- PUSETE K.U.SH 40 X 60 X 100 E RE

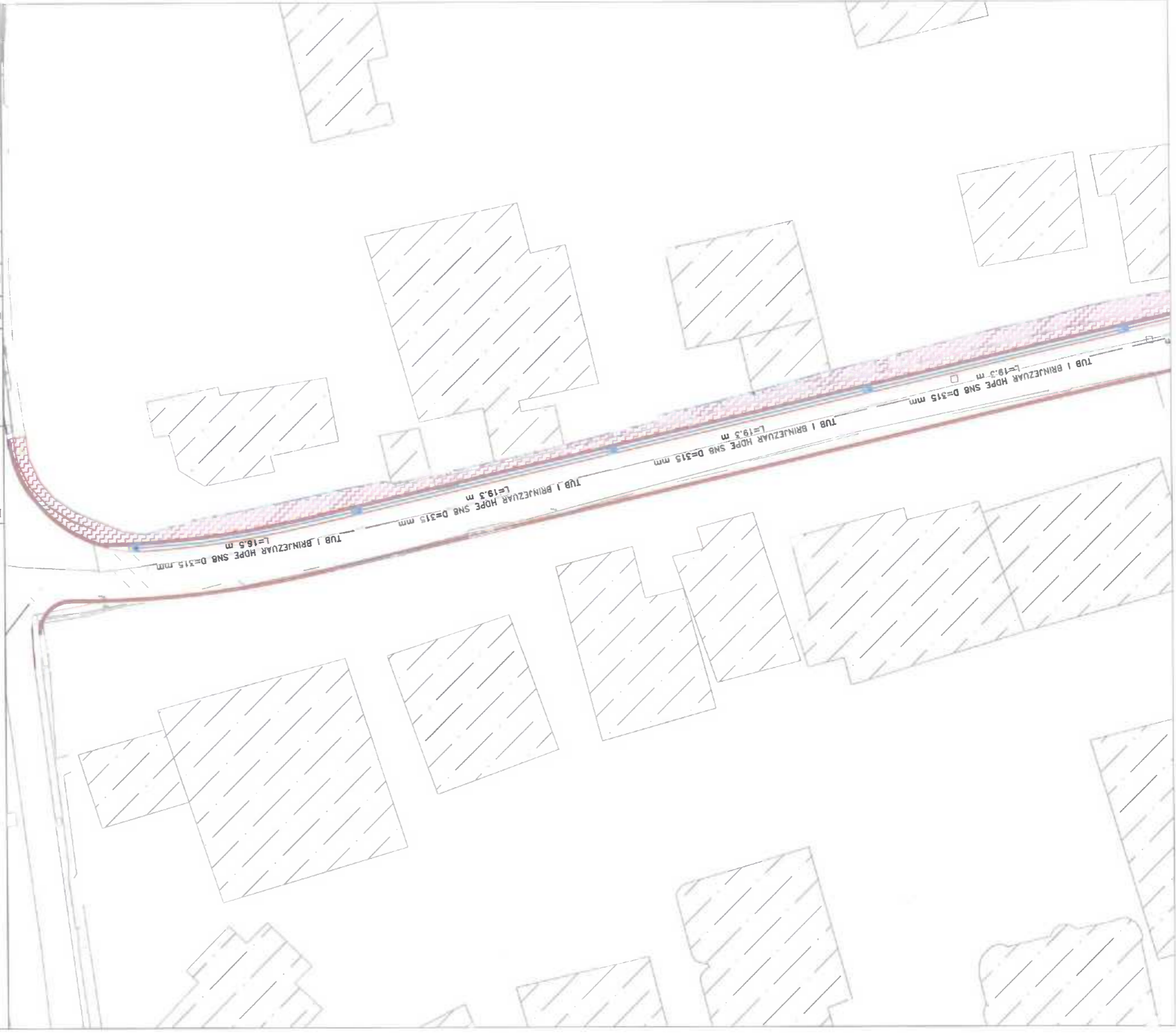

EMERTIMI I FLETES

PROJEKTI: Rikahitimi i rrugëve të "Muri Krafaj" - "Disha" - rrugët "Lcandro Zoto" - rrugët që kultivohet nga "Sadik Petrela"

Shkalla: 1:75

Numri i Fletes

Ing. Nd. V. GRUDA

Projekues

PALMA CONSTRUCTION shpk

Vula

Projekues

Ing. Nd. M. D. M. A. J.

Projekues

Ing. Nd. A. B. A. L. L. A. R. I.

Projekues

Ing. Nd. A. V. O. G. L. I.

Projekues

HE & SK 11

Vula

Projekues

BASHKIA TIRANE

Vula

Projekues

BASHKIA TIRANE

Vula

Projekues

BASHKIA TIRANE

Vula

Projekues

BASHKIA TIRANE

Vula

Projekues

BASHKIA TIRANE

Vula

Projekues

BASHKIA TIRANE

Vula

Projekues

BASHKIA TIRANE

Vula

Projekues

BASHKIA TIRANE

Vula

Projekues

BASHKIA TIRANE

Vula

Projekues

BASHKIA TIRANE

Vula

Projekues

BASHKIA TIRANE

Vula

Projekues

BASHKIA TIRANE

Vula

Projekues

BASHKIA TIRANE

Vula

Projekues

BASHKIA TIRANE

Vula

Projekues

BASHKIA TIRANE

Vula

Projekues

BASHKIA TIRANE

Vula

Projekues

BASHKIA TIRANE

Vula

Projekues







BASHKIA TIRANE

Vula

Projekues

BASHKIA TIRANE

Vula

- LEGJENDE**
-  BORDURE BETONI NE TROTUARIN E RI
 -  TROTUAR I RI
 -  KUNETE BETONI E RE
 -  RRUGE E SISTEMUAR
 -  NDERTESA EKZISTUESE
 -  PUSETE K.U.Z EKZISTUESE
 -  PUSETE K.U.SH 40 X 60 X 100 E RE



EMERTIMI I FLETES:	Projekt-Zbatim Planimetria e Përgjithshme K.U.B Rruga "Kadillari" Drejtimi I Rruga "Kadillari"	Shkalla: 1:75	Numri i Fletes: P-
PROJEKTI:	Rehabilitimi i rrugëve të bllokuve që kufizohen nga rrugët "L'andio Zoto" - "Mati Kraja" - "Disha" - "Sadik Petrela"		

Ing. Nd. V. GRUDA

PALMA CONSTRUCTION SHPK
 Projektes
 Vula

Ing. Nd. M. BETA
 Projektes
 Vula

Ing. Nd. A. FATILLARI SH.P. Ing. Mek. E. MUCAJ
 Projektes
 Vula

Ing. Nd. A. REGASI
 Projektes
 Vula

HE & SK 11
 consulting company
 Projektes
 Vula

BASHKIA E TIRANES
 DREJTORIA E REKRETTESHME
 E PUNIMEVE URBANE
 POROSITES
 Vula

LEGJENDE

- BORDURE BETONI NE TROTUARIN E RI
- TROTUAR I RI
- KUNETE BETONI E RE
- RRUGE E SISTEMUAR
- NDERTESA EKZISTUESE
- PUSETE K.U.Z EKZISTUESE
- PUSETE K.U.SH 40 X 60 X 100 E RE



EMERTIMI I FLETES:
 Projekti-Zbatim e Përgjithshme K.U.B
 Planimetria e Përgjithshme e Kruga "Kadillari"
 Numri i Fletes: 175
 Shkallë: P

Ing. Nd. V. GRUDA

PALMA CONSTRUCTION SHPK
 Projekti: "Rehabilitimi i rrugës dhe instalimi i sistemit të ujërave të ftohtëve në rrugën e Kadillari" - "Disha" - "Marti Kraja" - "Leandro Zoto" - "Rehabilitimi i rrugës dhe instalimi i sistemit të ujërave të ftohtëve në rrugën e Kadillari"

Projektes: Vula

Ing. Nd. M. B. ...
 Ing. Ele. H. DANAJ

Ing. Nd. A. ...
 Ing. Met. J. ...

Ing. Nd. A. VOGLI
 Ing. Top. E. BREGASI

HE & SK 11
 Projekti: "Rehabilitimi i rrugës dhe instalimi i sistemit të ujërave të ftohtëve në rrugën e Kadillari" - "Disha" - "Marti Kraja" - "Leandro Zoto" - "Rehabilitimi i rrugës dhe instalimi i sistemit të ujërave të ftohtëve në rrugën e Kadillari"

Projektes: Vula

BASHKIA E TIRANË
 DREKTORIA E PUNËVE PUBLIKE
 Projekti: "Rehabilitimi i rrugës dhe instalimi i sistemit të ujërave të ftohtëve në rrugën e Kadillari" - "Disha" - "Marti Kraja" - "Leandro Zoto" - "Rehabilitimi i rrugës dhe instalimi i sistemit të ujërave të ftohtëve në rrugën e Kadillari"

Porositës: Vula

- LEGJENDE**
- BORDURË BETONI NE TROTUARIN E RI
 - TROTUAR I RI
 - KUNNETE BETONI E RE
 - RRUGE E SISTEMUAR
 - NDERTESA EKZISTUESE
 - PUSETE K.U.Z EKZISTUESE
 - PUSETE K.U.SH 40 X 60 X 100 E RE



Skallat	1:75	Numri i Nives	
Projekti/zbam		Rehabilitimi i rruges te	
Planimetria e Përgjithshme K.U.B		"Mani Kraja" - "Disha" -	
Rruga "Vangush Meksi"		"Sadik Petrela"	
EMERTIMI I FLETES		PROJEKTI	

Ing. Nd. V. GRUDA

Projektes

PALMA CONSTRUCTION shpk

Aut. shpirtore, shpirtore dhe shpirtore

Projektes

Ing. Nd. M. BE...

Ing. Nd. A. ...

Ing. Nd. A. VOGLI

Ing. Top. ...

Projektes

HE & SK 11

consulting company

Porosites

BASHKIA E TIRANES

DIREKTORIA E PERQUTRISHME

TIRANE

LEGJENDE

- BORDURE BETONI NE TROTUARIN E RI
- TROTUAR I RI
- KUNETE BETONI E RE
- RRUGE E SISTEMUAR
- NDERTESA EKZISTUESE
- PUSETE K.U.Z. EKZISTUESE
- PUSETE K.U.SH 40 X 60 X 100 E RE



EMERTIMI I FLETES:
 Projekti-Zbatim
 Planimetria e Përgjithshme K.U.B
 Rruga "Vangjush Meksi"
 Shkalla: 1:75
 Numri i Fletes:

Ing. Nd. V. GRUDA

Projektes
 Vula
 PALMA CONSTRUCTION shpk







Ing. Nd. M. BEDA

Ing. Nd. A. HAFILLANI

Ing. Top. F. HEGASI

Projektes
 Vula
 HE & SK 11
 consulting company

Porositcs
 Vula
 BASHKIA E TIRANË
 DOKUMENTI I PËRQIETËSISE
 TIRANË

- LEGJENDE**
-  BORDURE BETONI NE TROTUARIN E RI
 -  TROTUAR I RI
 -  KUNETE BETONI E RE
 -  RRUGE E SISTEMUAR
 -  NDERTESA EKZISTUESE
 -  PUSËTE K.U.Z. EKZISTUESE
 -  PUSËTE K.U.SH 40 X 60 X 100 E RE



EMERTIMI I FLETES:
 Projekti-Zbatim
 Planimetria e Pergjithshme K.U.B
 Rruga "Xhemollari"
 rrugët "L. Gando Zoto" -
 "Marti Kralja" - "Disha" -
 "Sadik Petrela"
 Shkallë: 1:75
 Numri i Fletës: P-

Ing. Nd. V. GRUDA







Projektes
 Vula
 PALMA CONSTRUCTION shpk
 Projekti, realizimi dhe mbledhja e dokumenteve
 Arkivimi, Shërbimi, Sigurimi dhe Konsultime

Ing. Nd. M. BEDAJ

Projektes
 Vula
 HE & SK 11
 Ing. Nd. A. KETILLARI SH. Ing. Mek. E. MURRI
 Ing. Nd. A. GJ. Ing. Top. F. LEGASI

Projektes
 Vula
 HE & SK 11
 Konsultime dhe projektim

Porosites
 Vula
 BASHKIA E TIRANË
 DREKTORIA E PËRGJITHSHME
 E PUNËVE PUBLIKE
 BASHKIA TIRANË

- LEGENDE**
-  BORDURE BETONI NE TROTUARIN E RI
 -  TROTUAR I RI
 -  KUNETE BETONI E RE
 -  RRUGE E SISTEMUAR
 -  NDERTESA EKZISTUESE
 -  PUSETE K.U.Z EKZISTUESE
 -  PUSETE K.U.SH 40 X 60 X 100 E RE

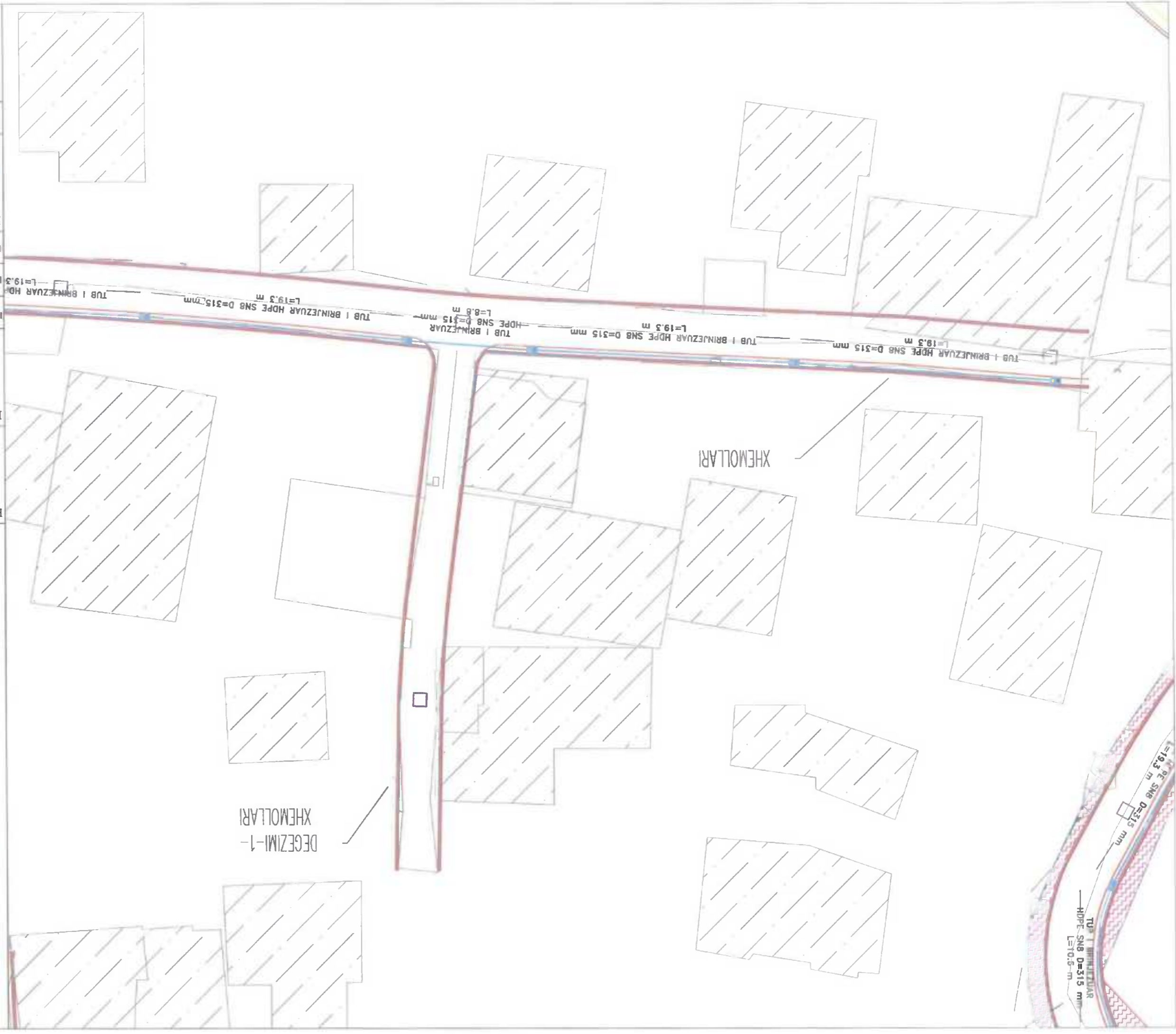

HE & SK 11
 Ing. Nd. A. GJ. Ing. Top. F. LEGASI

EMERTIMI I FLETES:
 Projekti-Zbatim
 Planimetria e Përgjithshme K.U.B
 Kruga "Xhemollari"
 Shkalla: 1:75
 Numri i fletes: P.

PROJEKTI:
 Reabilitimi i rrugëve të
 rrugët "Leandro Zoto"
 - "Marti Kraja"
 - "Sadik Petrela"

Ing. Nd V. GRUDA

PALMA CONSTRUCTION shpk
 Projektes
 Vula

Ing. Nd M. ...
 Ing. Nd A. ...
 Ing. Nd A. ...

HE & SK 11
 Projektes
 Vula

BASHKIA E TIRANË
 DREKTORIA E PËRGJITHSHME
 E PUNËVE PUBLIKE
 Projektes
 Vula

Porositës

LEGJENDE

BORDURE BETONI NE TROTUARIN E RI
 TROTUAR I RI
 KUNETE BETONI E RE
 RRUGE E SISTEMUAR
 NDRERTESA EKZISTUESE
 PUSETE K.U.Z EKZISTUESE
 PUSETE K.U.SH 40 X 60 X 100 E RE

DEGEZIM-3-
 DSHA

XHEMOLLARI

EGEZIMI-1-
 XHEMOLLARI

TUB I BRINJEUAR HDPE SN8 D=315 mm
 L=19.3 m

TUB I BRINJEUAR HDPE SN8 D=315 mm
 L=19.3 m

TUB I BRINJEUAR HDPE SN8 D=315 mm
 L=19.3 m

TUB I BRINJEUAR HDPE SN8 D=315 mm
 L=19.3 m

TUB I BRINJEUAR HDPE SN8 D=315 mm
 L=19.3 m

TUB I BRINJEUAR HDPE SN8 D=315 mm
 L=19.3 m

TUB I BRINJEUAR HDPE SN8 D=315 mm
 L=19.3 m

TUB I BRINJEUAR HDPE SN8 D=315 mm
 L=19.3 m

TUB I BRINJEUAR HDPE SN8 D=315 mm
 L=19.3 m

TUB I BRINJEUAR HDPE SN8 D=315 mm
 L=19.3 m

TUB I BRINJEUAR HDPE SN8 D=315 mm
 L=19.3 m

TUB I BRINJEUAR HDPE SN8 D=315 mm
 L=19.3 m

TUB I BRINJEUAR HDPE SN8 D=315 mm
 L=19.3 m

TUB I BRINJEUAR HDPE SN8 D=315 mm
 L=19.3 m

TUB I BRINJEUAR HDPE SN8 D=315 mm
 L=19.3 m

TUB I BRINJEUAR HDPE SN8 D=315 mm
 L=19.3 m



DEGEZIMI-1-
XHEMOLLARI

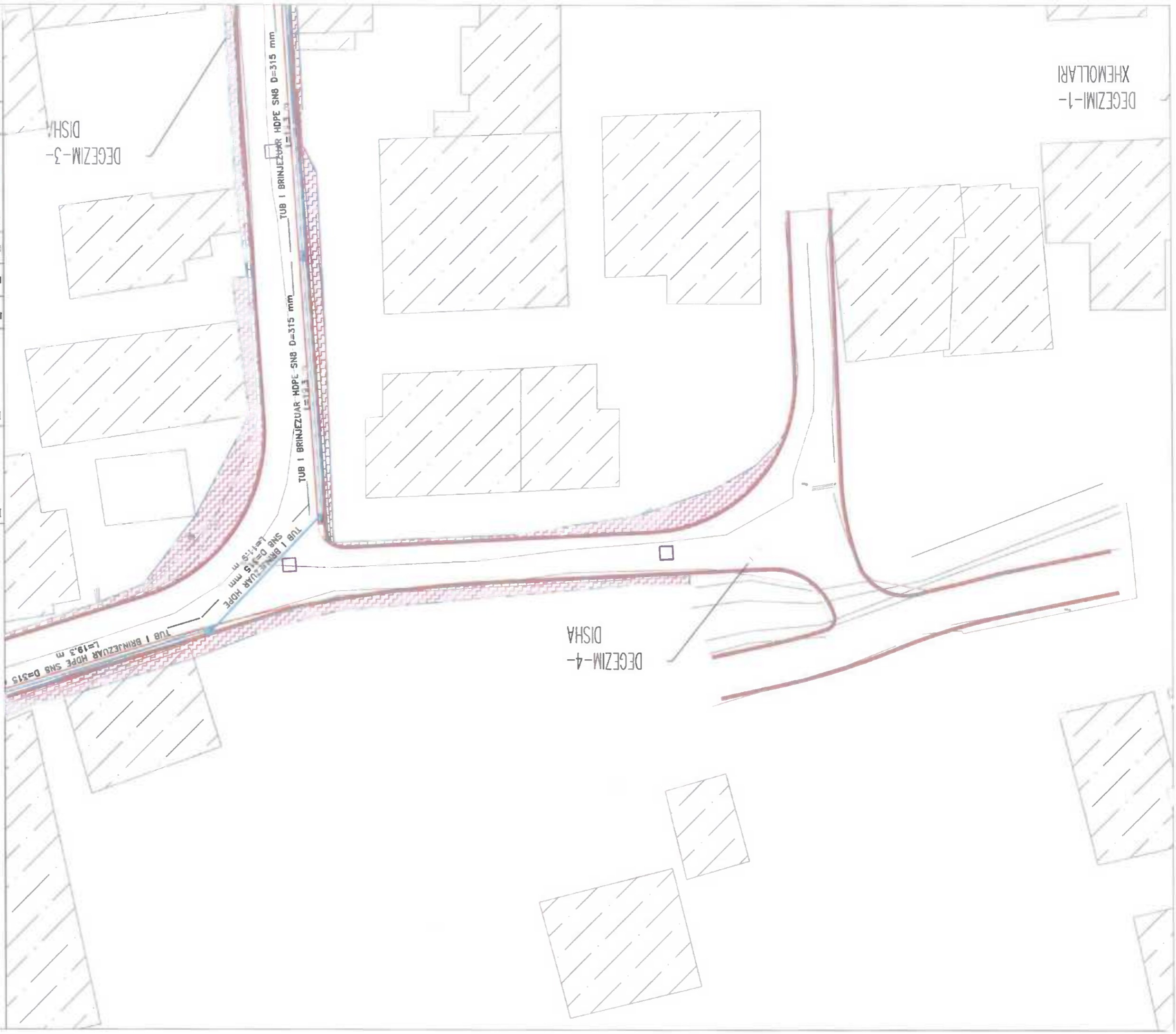





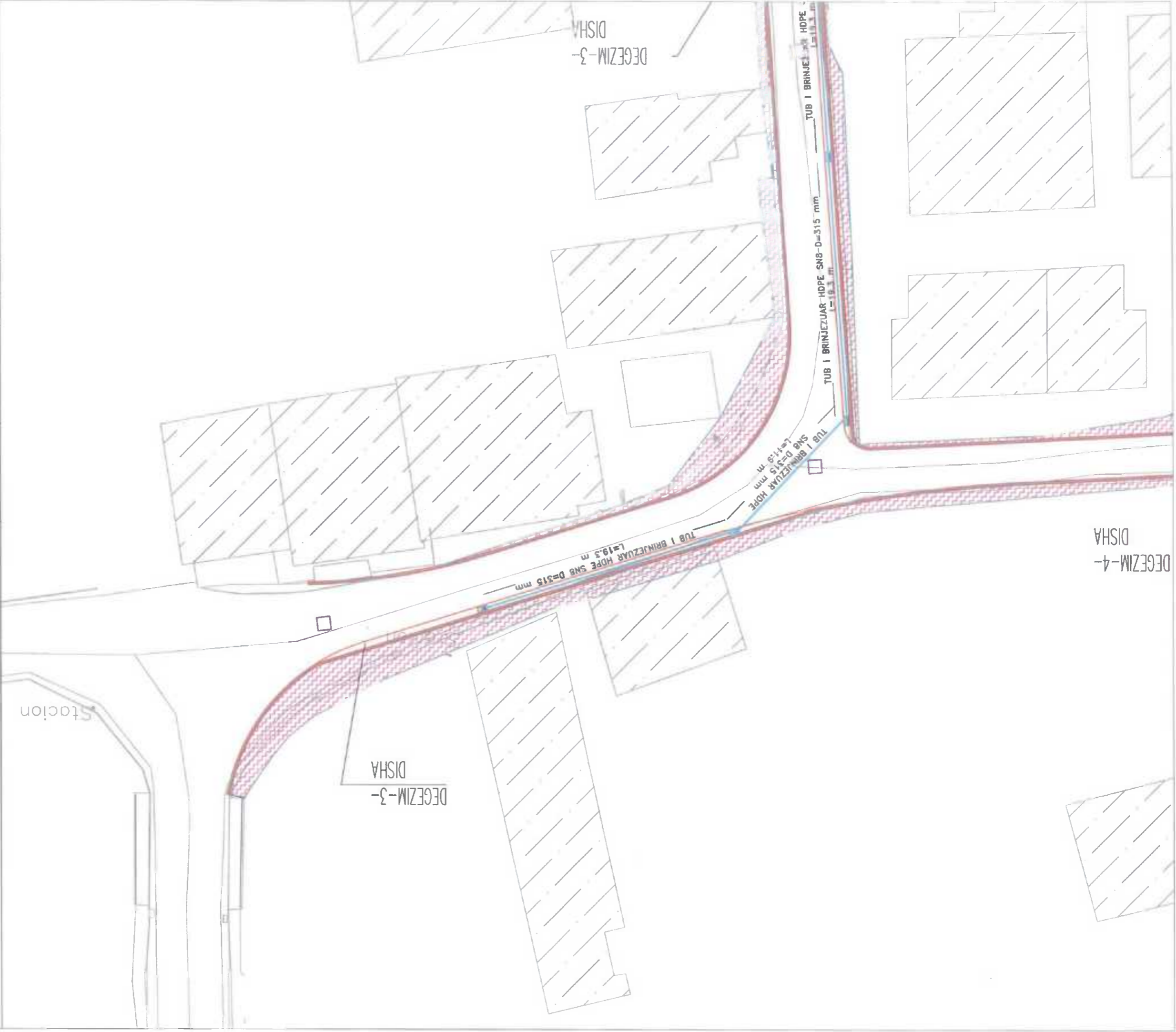

- LEGJENDE**
- BORDURE BETONI NE TROTUARIN E
 - TROTUAR I RI
 - KUNEFTE BETONI E RE
 - RRUGE E SISTEMUAR
 - NDERTESA EKZISTUESE
 - PUSETE K.U.Z EKZISTUESE
 - PUSETE K.U.SH 40 X 60 X 100 E RE







<p>PROJEKTI: Rehabilitimi i rrugëve të rrugët "L. candro Zoto" - "Marti Krupa" - "Disha" - "Sadik Petrela"</p>		<p>Shkalla 1:75</p>	<p>Numri i fletës</p>
<p>EMERTIMI I FLETES Projekt-Zbatim Planimetria e Përgjithshme K.U.B Degezimi 4 Rruga "Disha"</p>			
<p>Ing. Nd. V. GRUDA</p>			
<p>Projekues PALMA CONSTRUCTION shpk</p>			
<p>Ing. Nd. M. BEDI</p>			
<p>Ing. Nd. A. BEALLARI</p>			
<p>Ing. Nd. A. V. GASI</p>			
<p>Projekues HE & SK 11 consulting company</p>			
<p>Porosites BASHKIA E TIRANES DIREKTORIA E PUNES PUBLIKE TIRANE</p>			



LEGJENDE

-  BORDURE BETONI NE TROTUARIN E RI
-  TROTUAR I RI
-  KUNJTE BETONI E RE
-  RRUGE E SISTEMUAR
-  NDRERTESA EKZISTUESE
-  PUSETE K.U.Z EKZISTUESE
-  PUSETE K.U.SH 40 X 60 X 100 E RE

<p>Projektes</p> <p>BASHKIA E TIRANË</p> <p>DRE. TORJA B. PËRQJITSHME E PËNËVE POJLINE</p>		<p>Projektes</p> <p>HE & SK 11</p> <p>consulting company</p>	
<p>Vula</p>		<p>Vula</p>	
<p>Porosites</p>		<p>Projektes</p>	
<p>Ing. Nd. A. BREGASI</p>		<p>Ing. Nd. M. B. ...</p>	
<p>Ing. Nd. A. ...</p>		<p>Ing. Nd. M. ...</p>	
<p>Projektes</p> <p>PALMA CONSTRUCTION shpk</p>		<p>Projektes</p> <p>HE & SK 11</p>	
<p>Vula</p>		<p>Vula</p>	
<p>Ing. Nd. V. GRUDA</p>		<p>Ing. Nd. M. ...</p>	
<p>PROJEKTI</p> <p>Rehabilitimi i rrugëve të rrugët "Leandro Zoto" - "Mati Kraja" - "Disha" - "Sadik Petrela"</p>		<p>PROJEKTI</p> <p>Rehabilitimi i rrugëve të rrugët "Leandro Zoto" - "Mati Kraja" - "Disha" - "Sadik Petrela"</p>	
<p>EMERTIMI I FLETES</p> <p>Projekt-Zbatim</p> <p>Planimetria e Përgjithshme K.U.B Degezimi 3 "Rruga Disha"</p>		<p>EMERTIMI I FLETES</p> <p>Projekt-Zbatim</p> <p>Planimetria e Përgjithshme K.U.B Degezimi 3 "Rruga Disha"</p>	
<p>Shkalla: 1:75</p>		<p>Numri i Fletes</p>	

- LEGJENDE**
-  BORDURE BETONI NE TROTUARIN E RI
 -  TROTUAR I RI
 -  KUNJETE BETONI E RE
 -  RRUGE E SISTEMUAR
 -  NDERTESA EKZISTUESE
 -  PUSETE K.U.Z EKZISTUESE
 -  PUSETE K.U.SH 40 X 60 X 100 E RE

Vula

Porositës



BASHKIA E TIRANËS
DREKTORATI I PËRQUTIMIT

BASHKIA TIRANË

Projektes



HE & SK 11
consulting company

Projektes

Ing. Nd. M. BRANA
Ing. Nd. M. BRANA
Ing. Nd. M. BRANA
Ing. Nd. M. BRANA

Projektes



PALMA CONSTRUCTION SHPK
Projektim, ndërtim dhe lehtësi në punën e ndërtimit

Ing. Nd. V. GRUDA

PROJEKTI	Rehabilitimi i rrugëve të bllokut që kufizohet nga rrugët "L. eandro Zoto" - "Marti Kraja" - "Disha" - "Sadik Petrela"
EMERTIMI I FLETËS:	Projekt-zbatim i Planimetria e Përgjithshme K.U.B. Degezimi 3 Rruga "Disha"
Shkalla:	1:75
Numri i fletës:	

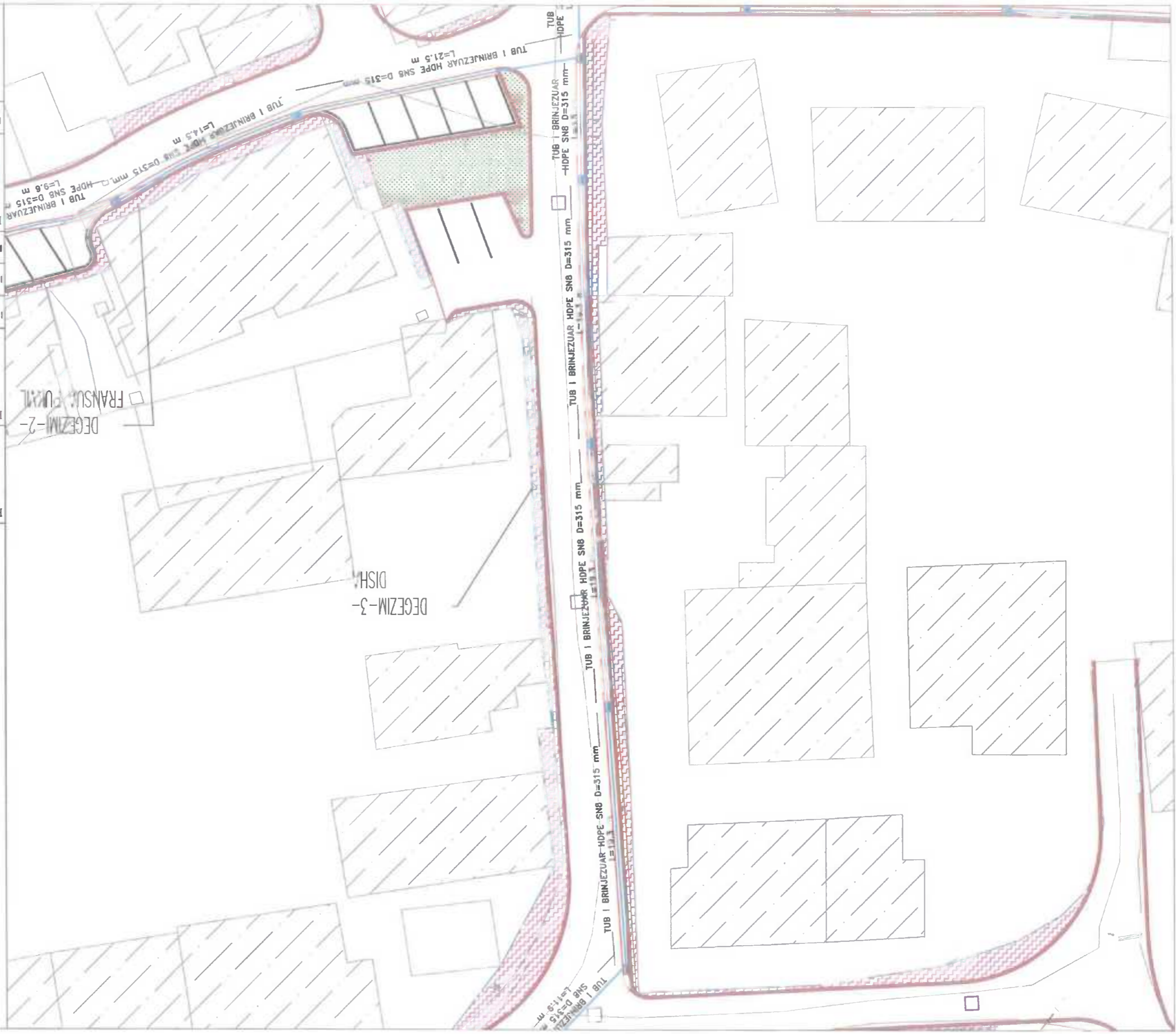

EMERTIMI I FLETES:
 Projekti-Zbatim
 Planimetria e Përgjithshme K. U. B.
 Dëgjimi 3 Rruga "Disha"
 "Marr Krasta" - "Disha" -
 rrugët "Leandro Zoto" -
 bllokut që kufizohet nga
 Rehabitimi i rrugëve të
 "Sadik Petrela"
 Shkalla: 1:75
 Numri i Fletes:

Ing. Nd. V. GRUDA

Projektes
 PALMA CONSTRUCTION shpk
 Projekti në mënyrë të përbashkët me:
 Anëtarë: Shkëlqim Durrës, Indira
 Vula

Projektes
 Ing. Nd. M. BE
 Ind. Elmi: N. DANAJ

Projektes
 Ing. Nd. A. BEATRIAN SH
 SH & SR 11 MUAJ







Projektes
 Ing. Nd. A. V. BREGASI

Projektes
 Ing. Topi: BREGASI

Projektes
 HE & SK 11
 consulting company
 Vula

Porositës
 BASHKIA E TIRANË
 DREKTORIA E PËRGJITHSHME
 E PUNËVE PUBLIKE
 BASHKIA E TIRANË
 Vula

LEGJENDE

-  BORDURE BETONI NE TROTUARIN E RI
-  TROTUAR I RI
-  KUNETE BETONI E RE
-  RRUGE E SISTEMUAR
-  NDERTESA EKZISTUESE
-  PUSETE K.U.Z EKZISTUESE
-  PUSETE K.U.SH 40 X 60 X 100 E RE



EMERTIMI I FLETES:
 Projekt/baum
 blokut qe kultivohet nga
 Planimetria e Pergjithshme K. II B
 rruget "Leandro Zoto" -
 "Mari Krifa" - "Disha" -
 Degezimi 3 Rruga "Ali Shefqet"
 Shkalla: 1:25
 Numri i Fletes

PROJEKTI:
 Rchabilitimi i rruges te
 Ing. Nd. V. GRUDA

Projekues:
 Vula
 PALMA CONSTRUCTION shpk
 A kështu si strukturë impune dhe në strukturë

Projekues:
 Vula
 Ing. Nd. M. BREGASI
 Ing. Nd. M. BREGASI
 Ing. Nd. M. BREGASI
 Ing. Nd. M. BREGASI

Projekues:
 Vula
 HE & SK 11
 consulting company

Porositës:
 Vula
 BASHKIA E TIRANES
 DREKTORIA E PERGJITHSHME
 TIRANE
 BASHKIA E TIRANES
 DREKTORIA E PERGJITHSHME
 TIRANE

- LEGJENDE
- BORDURE BETONI NE TROTUARIN E RI
 - TROTUAR I RI
 - KUNETE BETONI E RE
 - BRUCE E SISTEMUAR
 - NDERTESA EKZISTUESE
 - PUSETE K.U.Z EKZISTUESE
 - PUSETE K.U.SH 40 X 60 X 100 E RE

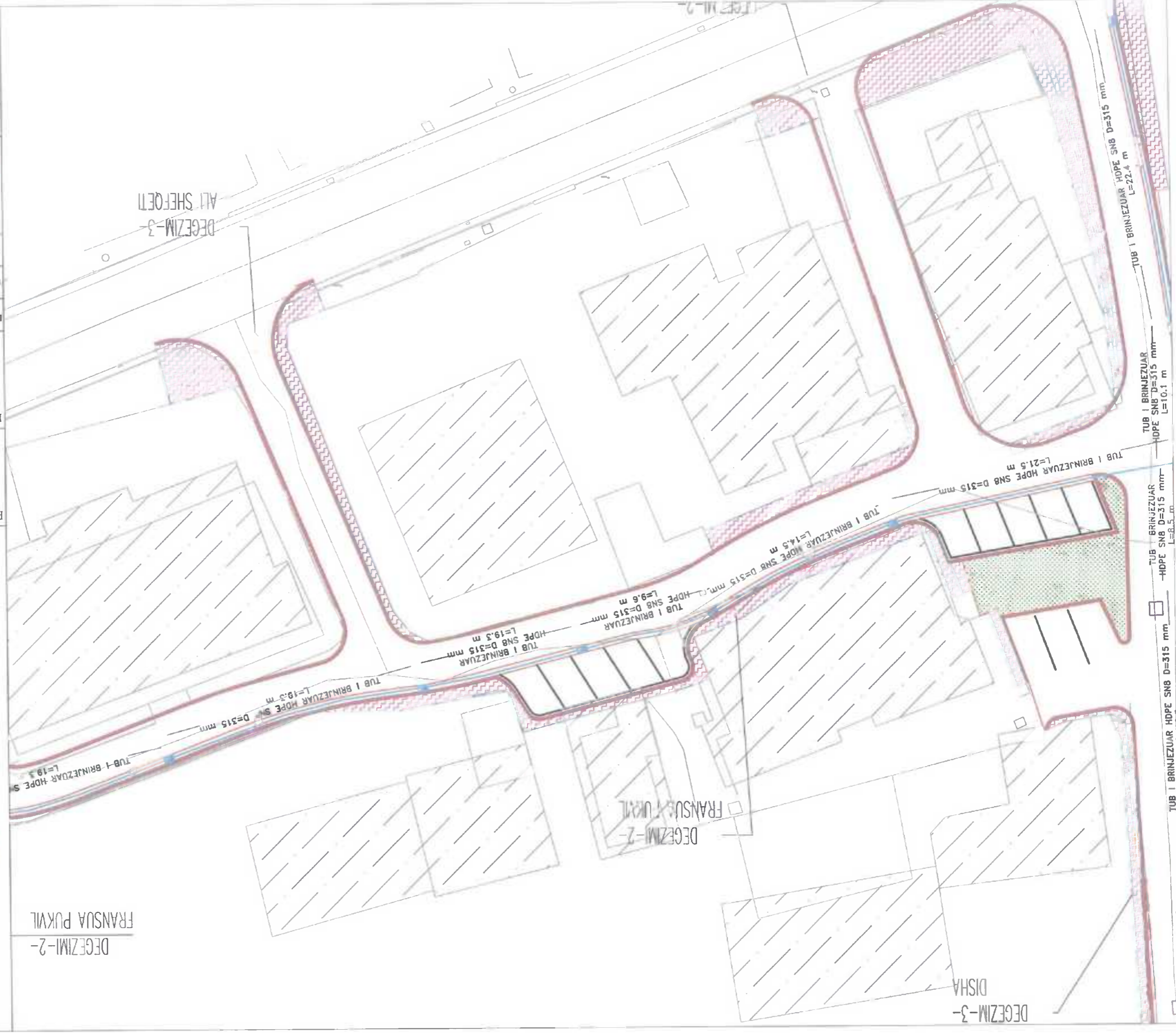

EMERTIMI I FLETES:	Projekt/batum Planimetria e Përgjithshme K U B Drejtuesi: "Ali Shefqet" Drejtuesi: "Ali Shefqet" Drejtuesi: "Ali Shefqet"	Numri i Fletes: 175
PROJEKTI:	Rehabilitimi i rrugëve të rrugës "Leandro Zoto" rrugës "Mari Krafaj" rrugës "Disha" rrugës "Sadik Petrela"	Shtylla

Ing. Nd. V. GRUDA

Projekues

PALMA CONSTRUCTION SHPK

Vula

Ing. Nd. M. BEGA, Ing. Emir M. DANAJ

Ing. Nd. M. BEGA, Ing. Emir M. DANAJ

Ing. Nd. M. BEGA, Ing. Emir M. DANAJ

Ing. Nd. M. BEGA, Ing. Emir M. DANAJ

Projekues

HE & SK 11

Vula

Ing. Nd. M. BEGA, Ing. Emir M. DANAJ

Porositës

BASHKIA E TIRANË

Vula

LEGJENDE

	BORDURE BETONI NE TROTUARIN E RI
	TROTUAR I RI
	KUNETE BETONI E RE
	RRUGE E SISTEMUAR
	NDERTESA EKZISTUESE
	PUSETE K.U.Z EKZISTUESE
	PUSETE K.U.SH 40 X 60 X 100 E RE

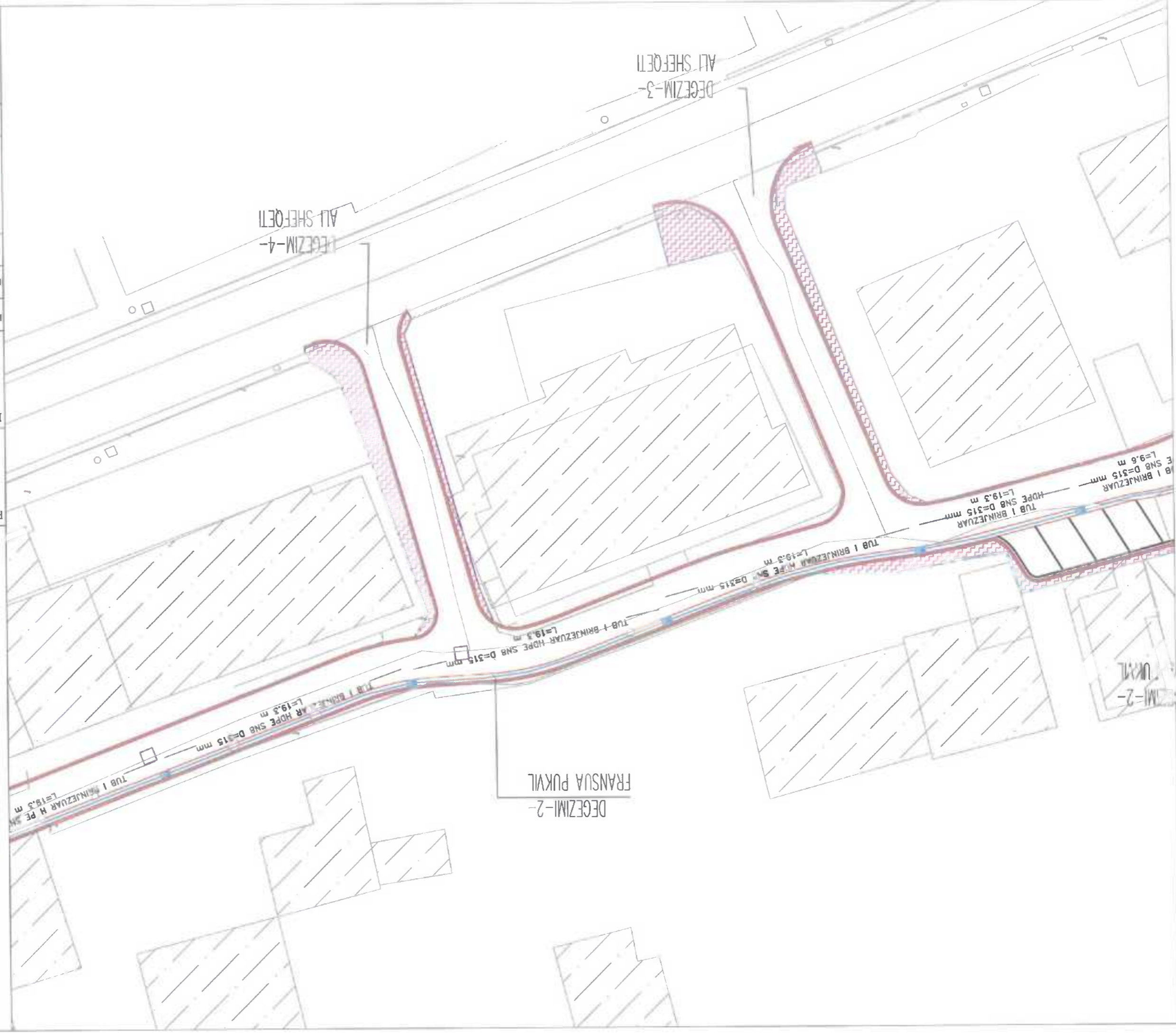

EMERTIMI I FLETES:
 Projekti /-bani
 Planimetria e Përgjithshme K.U.B
 Dëgjimi 2 Rruga "Transua Pukvil"
 Numri i Fletes:
 Shkalla:
 1:75
 F-
 PROJEKTI:
 Rehabilitimi i rrugëve të
 rrugët "Leandro Zoto"
 "Mati Kraja" - "Disha"
 "Sadik Petrela"

Ing. Nd: V. GRUDA

Projektes
 PALMA CONSTRUCTION shpk
 Vula







Ing. Nd: M. BEDAJ
 Ing. Elek. N. DANAJ

Ing. Nd: M. BEKTELARI
 Ing. Top: E. MUCAJ

Ing. Nd: V. VOGLI
 Ing. Top: I. BREGASI

Projektes
 HE & SK 11
 Vula

Porosites
 BASHKIA E TIRANES
 DREKTORIA E PERGJITHSHME
 E PUNES PUBLIKE
 BASHKIA
 TIRANE
 Vula

- LEGJENDE**
-  BORDURE BETONI NE TROTUARIN E RI
 -  TROTUAR I RI
 -  KUNETE BETONI E RE
 -  RRUGE E SISTEMUAR
 -  NDERTESA EKZISTUESE
 -  PUSETE K.U.Z EKZISTUESE
 -  PUSETE K.U.SH 40 X 60 X 100 E RE



ALI SHEFO
 I EGZIM-

EMERTIMI I FLETES

PROJEKTI: Rehabilitim i rrugëve të bllokut që kufizohet nga rrugët "L. e Andro Zoto" - "Mati Krupa" - "Disha" - "Sadik Petekli"

Shkalla: 1:75

Numri i Fletes

Ing. Nd. V. GRUDA

Projekues

PALMA CONSTRUCTION shpk

Ing. Nd. M. BEDI

Ing. Nd. A. KEFATILLARI SH.P.K.

Ing. Elik N. DANAJ

Ing. Mek. E. MUCAJ

Ing. Top. P. BREGASI

Projekues







HE & SK 11

Porositës

BASHKIA E TIRANË





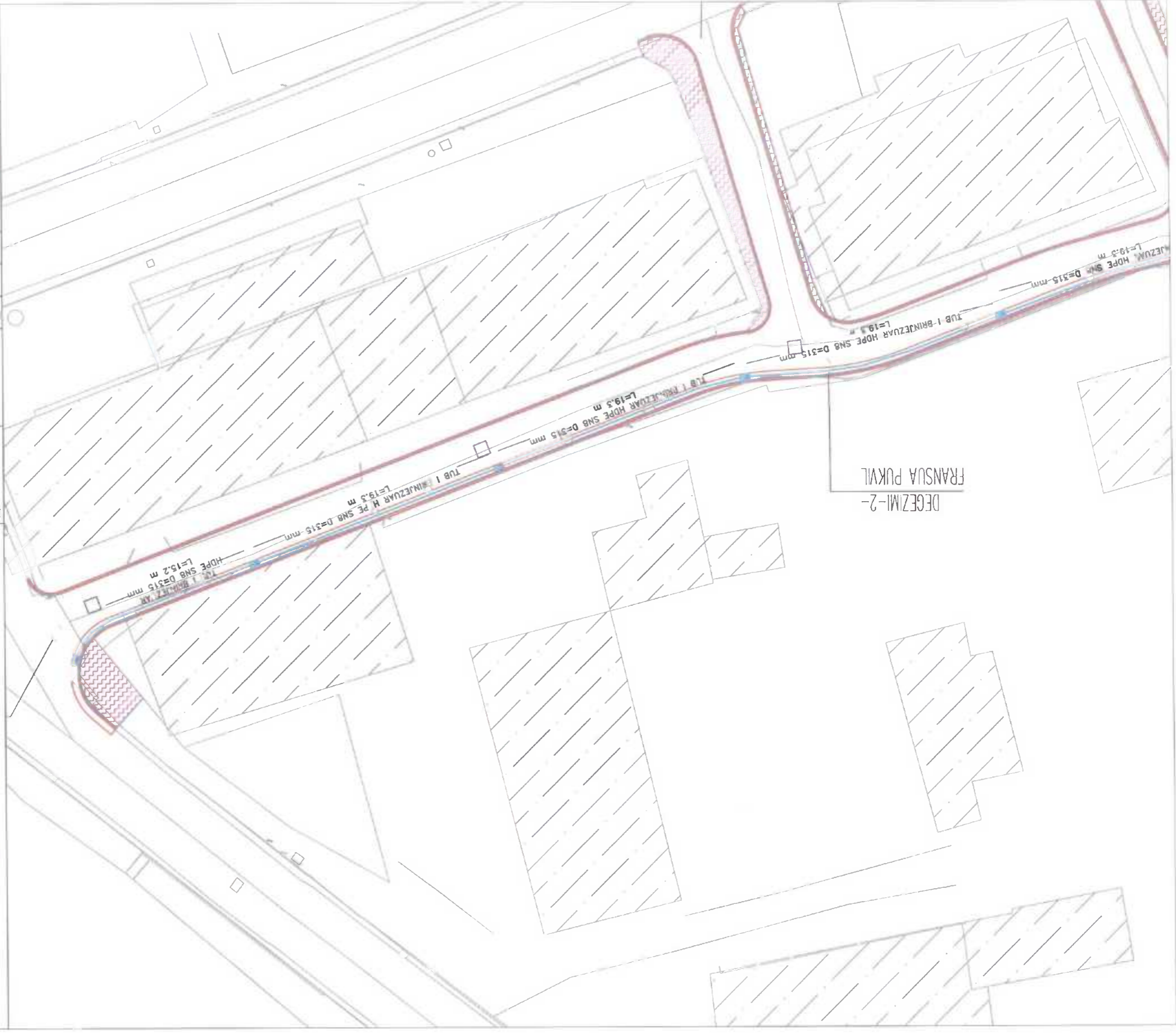

BASHKIA TIRANË

LEGJENDE

-  BORDURE BETONI NE TROTUARIN E RI
-  TROTUAR I RI
-  KUNEFTE BETONI E RE
-  RRUGE E SISTEMUAR
-  NDERPRESA EKZISTUESE
-  PUSFTE K.U.Z EKZISTUESE
-  PUSFTE K.U.SH 40 X 60 X 100 E RE









DEGEZIMI-2-
FRANSUA PUKVIL

- LEGJENDE**
-  BORDURE BETONI NE TROTUARIN E RI
 -  TROTUAR I RI
 -  KUNETE BETONI E RE
 -  RRUGE E SISTEMUAR
 -  NDERTESA EKZISTUESE
 -  PUSETE K.U.Z EKZISTUESE
 -  PUSETE K.U.SH 40 X 60 X 100 E RE

Porositës		 BASHKIA E TIRANËS DREKTORIA E PËRGRITSHMË E PUNËVE PUBLIKE	Vula
Projektores		 HE & SK 11 consulting company	Vula
Projektores		 PALMA CONSTRUCTION SHPK Projektim i ndërtimit dhe inxhinjieri Projektim i ndërtimit dhe inxhinjieri	Vula
Projektores		Ing. Nd. M. BEVVA Ing. ELLI N. DUKAJ	Vula
Projektores		Ing. Nd. A. ATYHE & SHK. ME 1.1 MUDAJ Ing. ELLI N. DUKAJ	Vula
Projektores		Ing. Nd. A. VOGLI Ing. ELLI N. DUKAJ	Vula
Projekti:		Rehabilitimi i rrugëve të "Marti Kralja" - "Disha" - "Sadik Petrela"	Shkallë: 1:75
EMERTIMI I FLETES:		Projekt-Zbatim Planimetria e Përgjithshme K.U.B. Kryega "Illa Shyti"	Numri i Fletes:
Ing. Nd. V. GRUDA			



- LEGJENDE**
-  BORDURE BETONI NE TROTUARIN E RI
 -  TROTUAR I RI
 -  KUNETE BETONI E RE
 -  RRUGE E SISTEMUAR
 -  NDERTESA EKZISTUESE
 -  PUSETE K.U.Z EKZISTUESE
 -  PUSETE K.U.SH 40 X 60 X 100 E RE

Porosites

BASHKIA E TIRANES
DIREKTORA E VEPRIMSHKES
E PUNES PUBLIKES

BASHKIA TIRANE

Vula

Projektes

HE & SK 11
consulting company

Vula

Projektes

HE & SK 11
SH.P.K.

Ing. Nd. VOGLI

Ing. Mok. E. NJUCAJ

Ing. Nd. M. AJ ALBERTI

Ing. E. N. DANAU

Vula

Projektes

PALMA CONSTRUCTION SHPK
Projektimi, studimi, inzhinerimi dhe bashkimi i veprimit

Vula

EMERTIMI I FLETES:





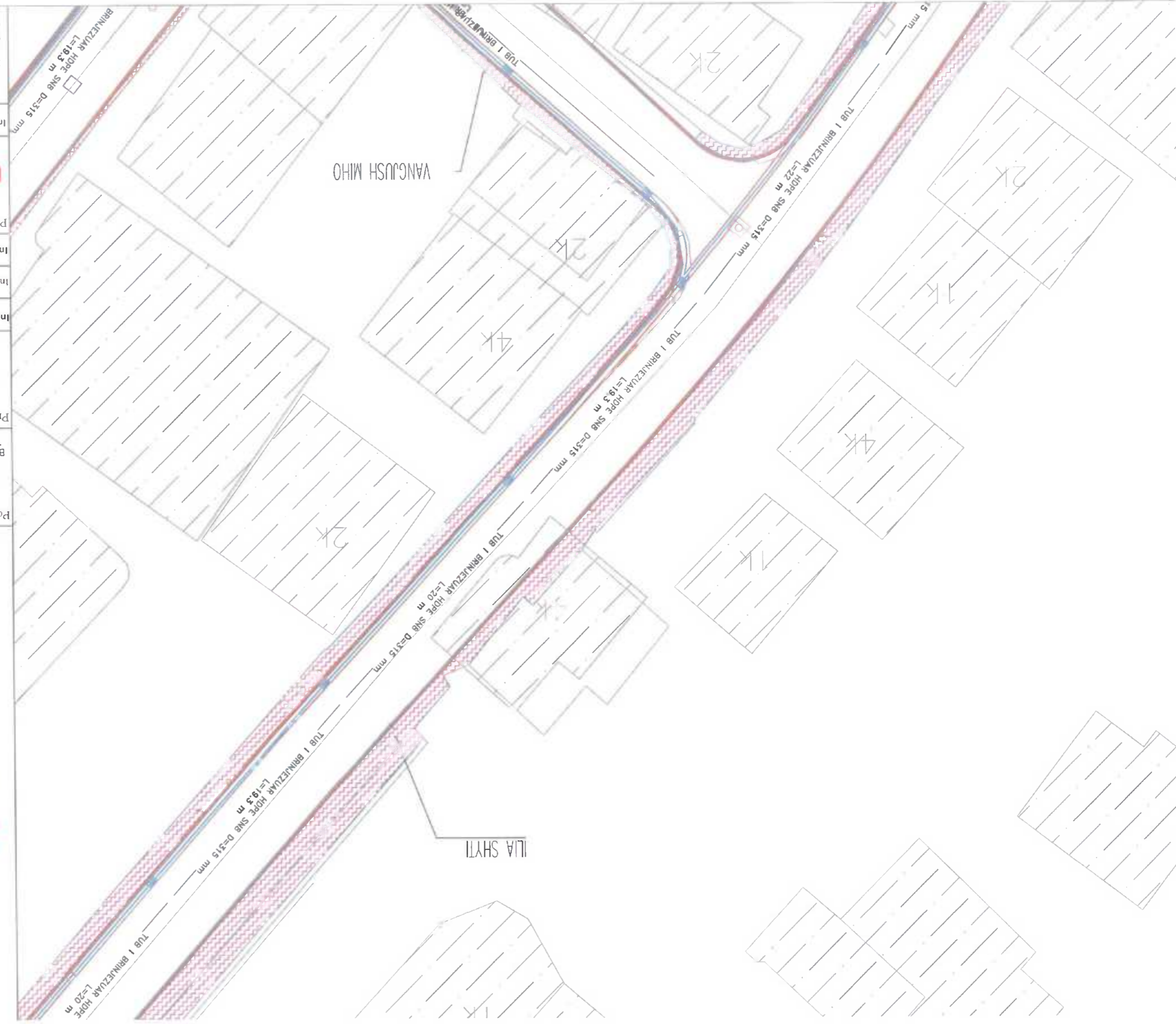

Projekti: Zbatimi i rregullimit dhe rregullimit te bllokut qe kufizohet nga rruges "L. e Candro Zoto" - "Mati Krasta" - "Disha" - "Sadik Petrela"

Shkalla: 1:75

Numri i Fletes: F-

Ing. Nd. V. GRUDA



- LEGJENDE**
-  BORDURE BETONI NE TROTUARIN E RI
 -  TROTUAR I RI
 -  KUNETE BETONI E RE
 -  RRUGE E SISTEMUAR
 -  NDERTESA EKZISTUESE
 -  PUSETE K.U.Z EKZISTUESE
 -  PUSETE K.U.SH 40 X 60 X 100 E RE

Porosites



BASHKIA E TIRANËS
DREJTORIA E PËRQUTSHMIRIA
E PLANITVE PUBLIKE

BASHKIA
TIRANË

Vula

Projektes



HE & SK 11
consulting company

Vula

Projektes



PALMA CONSTRUCTION shpk

Vula

Ing. Nd. V. GRUDA

EMERTIMI I FLETES:
Projekti-Zbatim
Planimetria e Përgjithshme K.U.B
Kruge "Illa Shyti"
"Sadik Petrela"
Rehabilitimi i rrugëve të
rrugët "L. candro Zoto"
- "Mati Kraja" - "Disha"
Shkalla 1:75
Numri i fletes



EMERTIMI I FLETES:
 Projekti-Zbatim
 Planimetria e Përgjithshme K.U.B
 Rruga "Genci Lekaj"
 Numri i Detyrës: P-175

PROJEKTI:
 Rehabilitimi i rrugëve të
 rrugës "Leandro Zoto"
 "Mami Kraqaj" - "Disha"
 "Sadik Petrela"

Ing. Nd. V. GRUDA

PALMA CONSTRUCTION SHPK
 Vula

Projekues

Ing. Nd. M. BEDAJ
 Ing. Nd. A. RE...
 Ing. Nd. E. MUCA

Ing. Nd. A. VOGLI
 Ing. Top. F. BREGASI

HE & SK 11
 Vula

Projekues

BASHKIA E TIRANË
 BASHKIA E TIRANË
 Vula

Porositës

BASHKIA E TIRANË
 BASHKIA E TIRANË
 Vula

LEGJENDE

	BORDURË BETONI NE TROTUARIN E RI
	TROTUAR I RI
	KONKRETE BETONI E RE
	RRUGE E SISTEMUAR
	NDERTESA EKZISTUESE
	PUSETE K.U.Z EKZISTUESE
	PUSETE K.U.SH 40 X 60 X 100 E RE

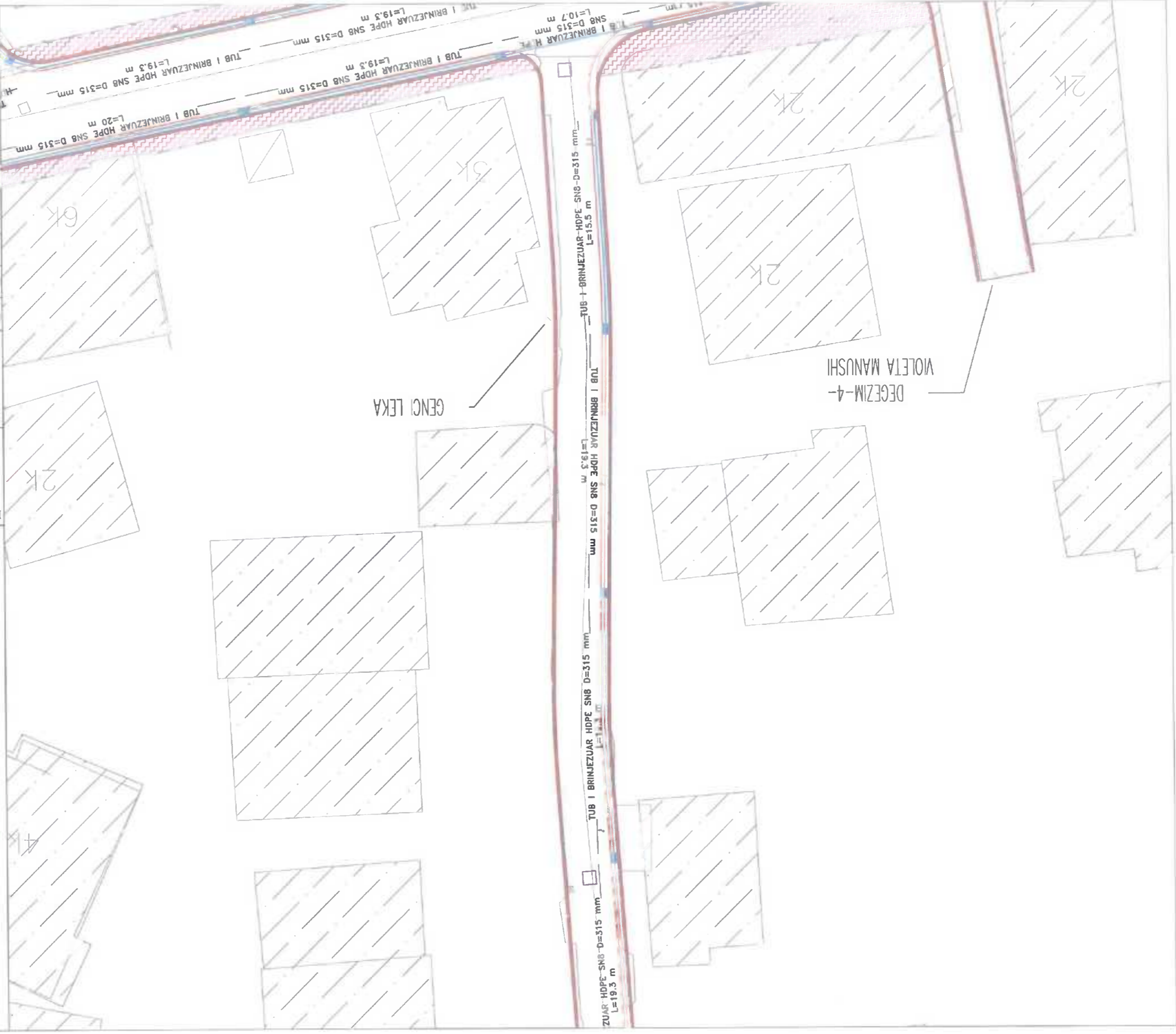

EMERTIMI I FLETES:
 Projekti/batim: Planimetria e Përgjithshme K.T.B. Rruga "Genci Leka"
 "Marti Kraja" - "Disha" - "Sadik Petrela"
 Reabilitimi i rrugëve të rrugët "Landro Zoto" -

Ing. Nd. V. GRUDA

Projektes
 Vula
 PALMA CONSTRUCTION shpk







Ing. Nd. M. BEDAJ

Ing. Nd. A. REF. TILARI

Ing. Top. F. BREGASI

Projektes
 Vula
 HE & SK 11

Porosites
 Vula
 BASHKIA E TIRANË
 DREKTORIA E PËRQYSHMË E PUNËVE PUBLIKE
 BASHKIA TIRANË

- LEGJENDE**
-  BORDURE BETONI NE TROTUARIN E RI
 -  TROTUAR I RI
 -  KUNETE BETONI E RE
 -  RRUGE E SISTEMUAR
 -  NDERTESA EKZISTUESE
 -  PUSETE K.U.Z EKZISTUESE
 -  PUSETE K.U.SH 40 X 60 X 100 E RE



PROJEKTI
 Rehabilitimi i rrugëve të
 bllokut që kufizohet nga
 rrugët "I eandro Zoto"
 - "Mati Kraja" - "Disha"
 - "Sadik Petrela"
 EMERTIMI I FLETES:
 Projekt-batim
 Planimetria e Përgjithshme K.1.13
 Rruga "Genci Lekaj"
 Numri i fletës:
 Shkalla
 1:75
 Niveli i detajit

Ing. Nd. V. GRUDA

PALMA CONSTRUCTION shpk
 Projekti: Shkallëzim dhe rregullim i rrugës
 dhe hapësirës së përbashkët në bllokun
 të kufizuar nga rrugët "I eandro Zoto"
 - "Mati Kraja" - "Disha" - "Sadik Petrela"

Projektes
 Ing. Nd. M. BEDA

Ing. Nd. A. REF.
 Ing. Mek. E. MUGALLI

Ing. Nd. A. VOGLI
 Ing. Top. F. BREGASI

Projektes
 Vula

BASHKIA E TIRANË
 DREKTORIA E PËRGJITHSHME
 E PUNËVE PUBLIKE

Projektes
 Vula

BASHKIA E TIRANË
 DREKTORIA E PËRGJITHSHME
 E PUNËVE PUBLIKE

Porositës
 Vula

Porositës
 Vula

LEGJENDE

	BORDURË BETONI NE TROTUARIN E RI
	TROTUAR I RI
	KUNETE BETONI E RE
	RRUGE E SISTEMUAR
	NDERTESA EKZISTUESE
	PUSETE K.U.Z. EKZISTUESE
	PUSETE K.U.SH 40 X 60 X 100 E RE

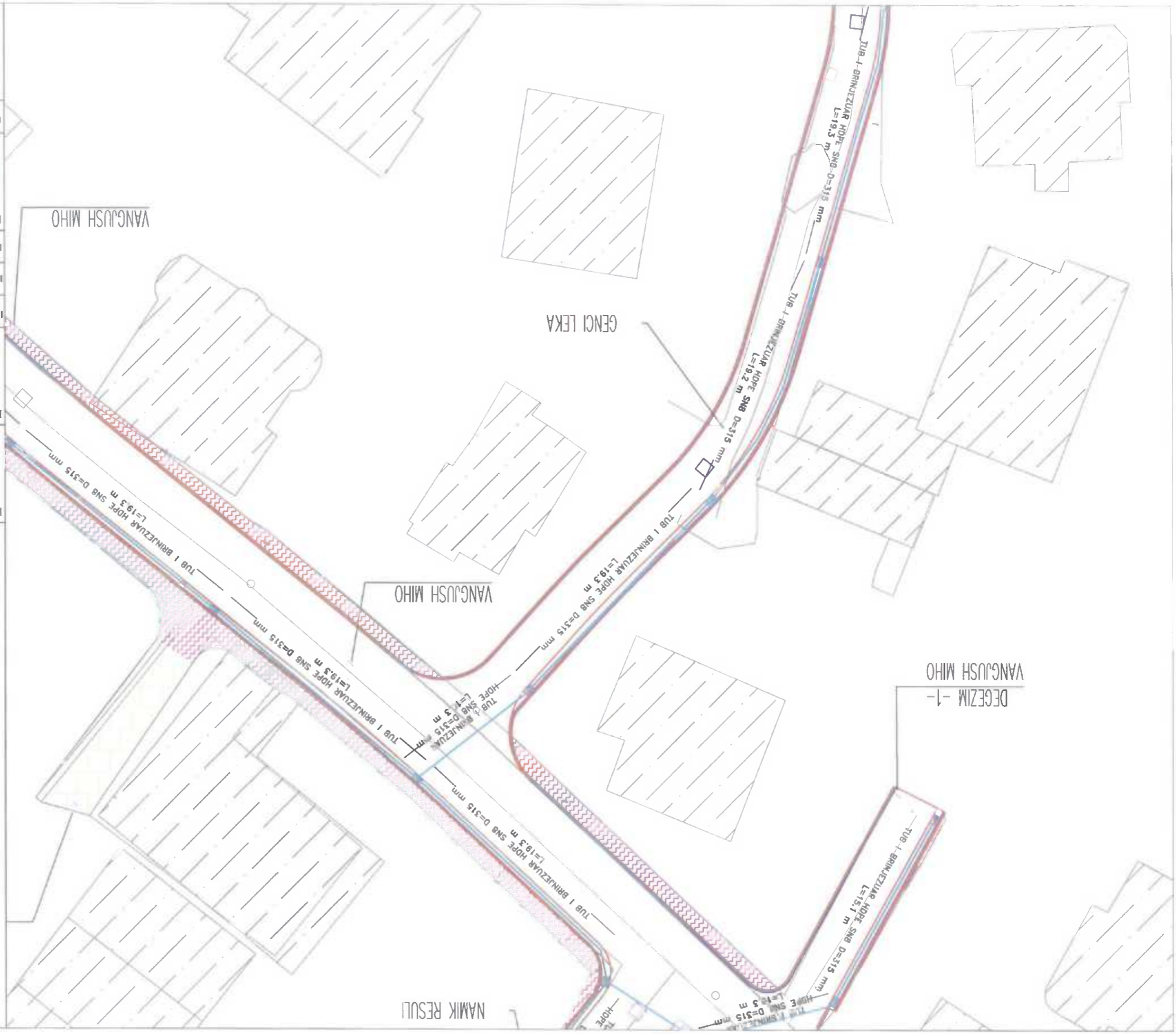

EMERTIMI I FLETES	Projekt-Zbatim Planimetria e Përgjithshme K.U.B. Kryega "Sali Ceka"	Shkalla: 1:75 Numri i Fletes: F-
PROJEKTI: Rrehabilitimi i rrugëve të bllokut që kufizohet nga rrugët "Leandro Zoto" - "Mari Kratja" - "Disha" - "Sadik Petrela"		

Ing. Nd. V. GRUDA

PALMA CONSTRUCTION SHPK
 Projektes
 Vula

Ing. Nd. M. B. AJ

Ing. Nd. A. F. BREGASI

HE & SK 11
 Projektes
 Vula

BASHKIA E TIRANËS
 DRËKTORIA E PËRQITSHMË
 E PUSKËVE PUBLIKE
 TIRANË
 Porosites
 Vula

DEGEZI
 VOLETA M.

LEGJENDE

	BORDURE BETONI NE TROTUARIN E RI
	TROTUAR I RI
	KUNETE BETONI E RE
	RRUGE E SISTEMUAR
	NDERTESA EKZISTUESE
	PUSETE K.U.Z EKZISTUESE
	PUSETE K.U.SH 40 X 60 X 100 E RE



EMERTIMI I FLETES:
 Projekt-zbarrm
 Planimetria e Përgjithshme K.U.B
 "Krahë e Sali Ceka"

Projekti:
 "Këmbimi i rrugëve të
 rrugës "Leandro Zoto" -
 "Marti Kralja" - "Disha" -
 "Sadik Petrela"

Shkalla: 1:75
 Numri i fletës: P-

Ing. Nd. V. GRUDA

Projektes
 Vula

Projektes
 Vula

Ing. Nd. M. BEDAJ





Ing. Nd. A. BEFATILKAM

Ing. Top: F. BREGASI

Projektes
 Vula

Porosites
 Vula

LEGJENDE

-  BORDURE BETONI NE TROTUARIN E RI
-  TROTUAR I RI
-  KUNJETE BETONI E RE
-  RRUGE E SISTEMUAR
-  NDRERTESA EKZISTUESE
-  PUSETE K.U.Z EKZISTUESE
-  PUSETE K.U.SH 40 X 60 X 100 E RE

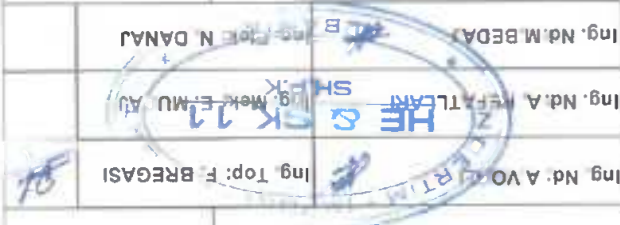
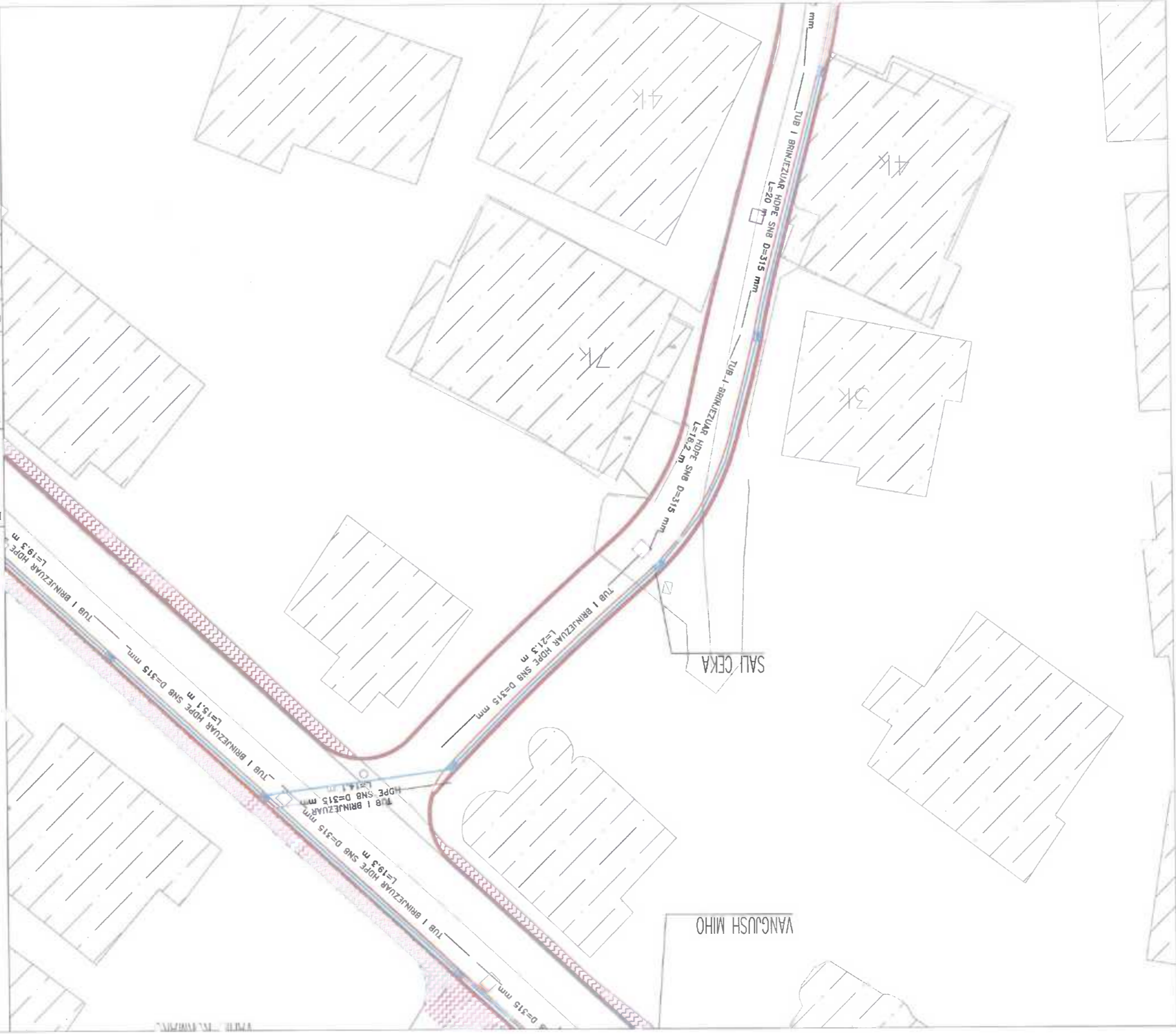

EMERTIMI I FLETES:
 Projekti/batim
 Planimetria e Përgjithshme K.U.B
 Rruga "Vangush Mitho"
 Numri i Fletes
 Shkalla
 1:75

PROJEKTI:
 Rikrahimi i rrugëve të
 "Sadik Petrela"
 "Mari Kraja" - "Disha"
 rrugët "Leandro Zoto"
 bllokut që kufizohet nga

Projekues
 PALMA CONSTRUCTION shpk
 Vite







Projekues
 Ing. Nd. M. BEDA
 Ing. A. Elek N. DANAJ

Projekues
 Ing. Nd. A. EFALLARI
 SH. Ing. M. CAJ

Projekues
 Ing. Nd. A. W. K. L.
 Ing. Top. F. BREGASI

Projekues
 HE & SK 11
 consulting company
 Vite

Porositës
 BASHKIA E TIRANË
 BASHKIA E TIRANË
 TIRANË
 Vite

- LEGJENDE**
-  BORDURË BETONI NE TROTUARIN E RI
 -  TROTUAR I RI
 -  KUNJTE BETONI E RE
 -  RRUGE E SISTEMUAR
 -  NDERTESA EKZISTUESE
 -  PUSËTE K.U.Z. EKZISTUESE
 -  PUSËTE K.U.SH 40 X 60 X 100 E RE

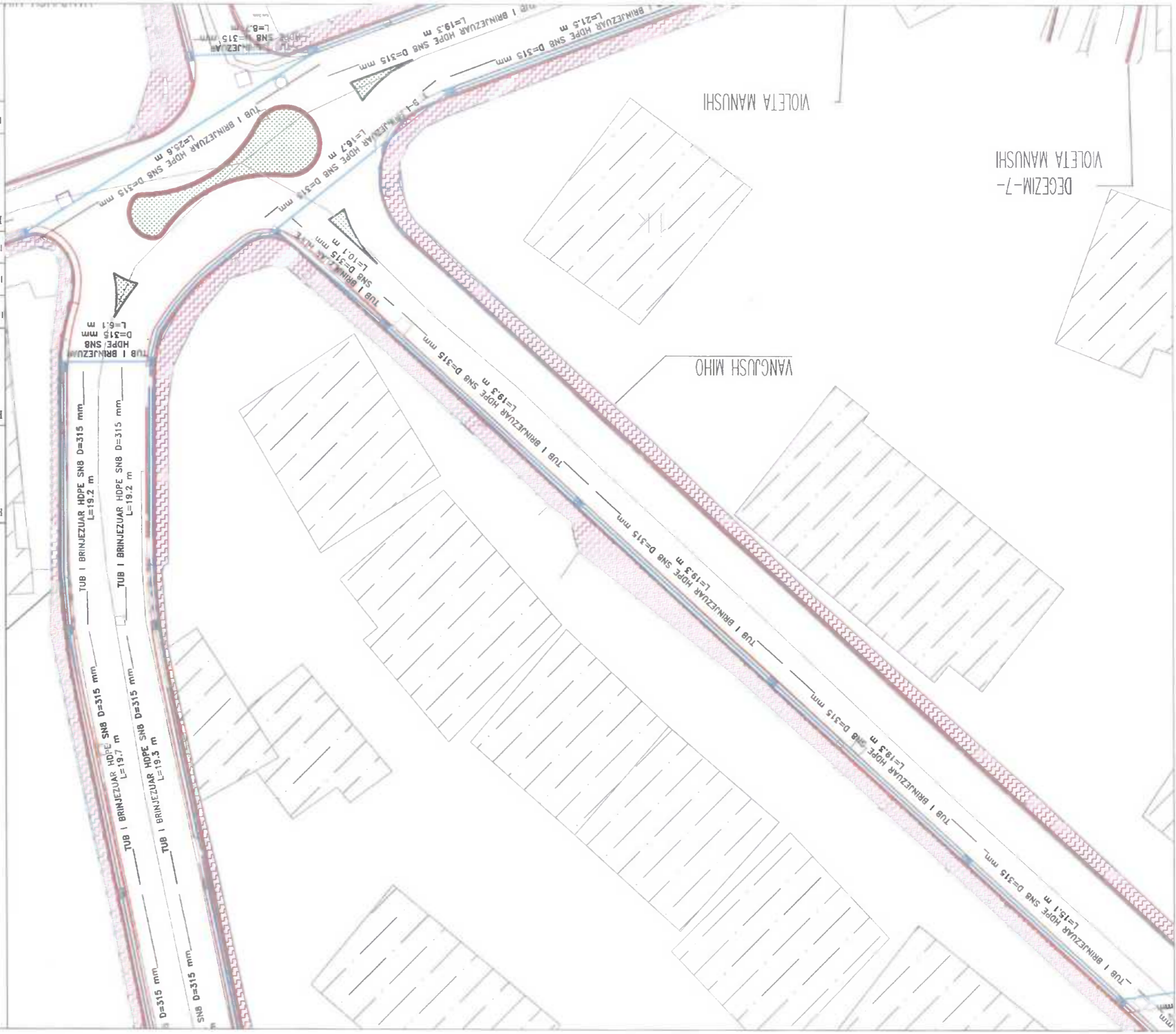

EMERTIMI I FLETES:
 Projekt-Zbatim
 Pharmacia e Përgjithshme K.U.B
 Rruge "Vangush Mihu"
 Degetimi I "Vangush Mihu"
 Numri i Fletes
 Shkalla 1:75
 P.

Ing. Nd. V. GRUDA

Projekues
 PALMA CONSTRUCTION shpk

Ing. Nd. M. BEDI

Ing. Nd. M. REFATILLARI SH.P
 Ing. Mek. E. MULLAJ
 Ing. Top. F. BREGASI

Projekues
 HE & SK 11
 consulting company

Porositës
 BASHKIA E TIRANË
 DREKTORIA E FUNKTSIONIT
 E PUNËVE PUBLIKË
 BASHKIA E TIRANË

LEGJENDE

	BORDURE BETONI NE TROTUARIN E RI
	TROTUAR I RI
	KUNETE BETONI E RE
	RRUGE E SISTEMUAR
	NDERTESA EKZISTIVESE
	PUSËTE K.U.Z EKZISTIVESE
	PUSËTE K.U.SH 40 X 60 X 100 E RE

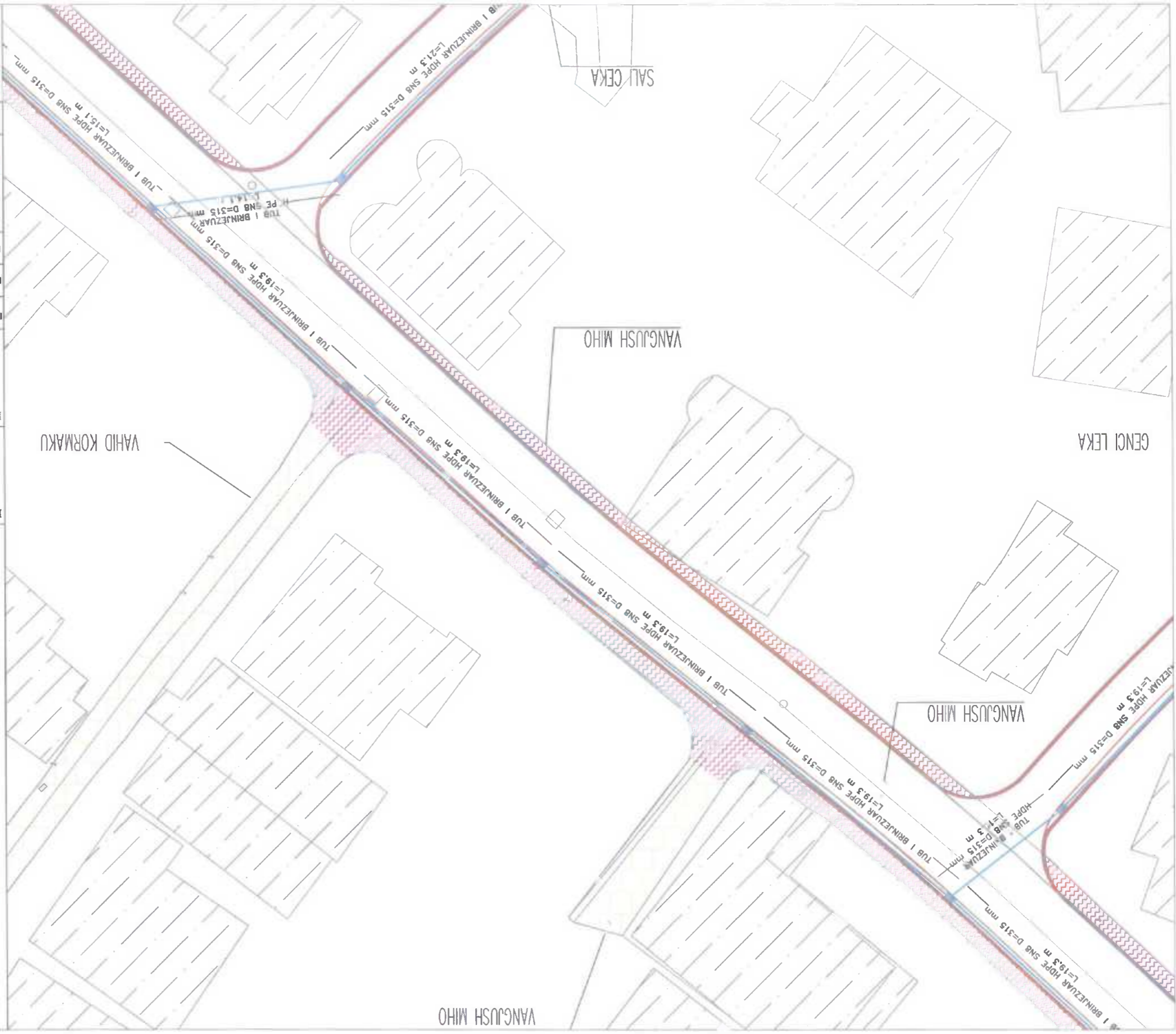

EMERTIMI I FLETES:	Projekti-zbatim Planimetria e Përgjithshme K.1.13 Rruga "Vangjush Mito" Rruga "Vangjush Mito" Dëgjimi I Rrugës "Vangjush Mito"	Shkalla 1:75 Numri i Fletës:
PROJEKTI:	Rehabilitimi i rrugës dhe bllokut që kufizohet nga "Leandro Zoto" - "Mari Krasta" - "Disha" - "Sadik Petrela"	

Ing. Nd. V. GRUDA

PALMA CONSTRUCTION SHPK
 Projektes
 Vula

Ing. Nd. M. ...

Ing. Nd. A. ZEFAR ...

Ing. Top. F. BREGASI

Ing. Nd. A. VOGLI

HE & SK 11
 Projektes
 Vula

BASHKIA E TIRANËS
 DRJUTORIA E PËRGJITHSHME
 E PUNËVE PUBLIKE

Porositës
 Vula

LEGJENDE

	BORDURE BETONI NE TROTUARIN E RI
	TROTUAR I RI
	KUNETE BETONI E RE
	RRUGE E SISTEMUAR
	NDERTESA EKZISTUESE
	PUSETE K.U.Z EKZISTUESE
	PUSETE K.U.SH 40 X 60 X 100 E RE



EMERTIMI I FLETES:	Projekti-Zbatim Planimetria e Përgjithshme K.U.B Rruga "Namik Resuli" Degezim 1 "Kruja Namik Resuli"	Shkalla: 1:75	Numri i Fletes:
PROJEKTI:	Rehabilitimi i rrugëve të rrugët "Leandro Zoto" - "Mati Krapija" - "Disha" - "Sadik Petela"		

Ing. Nd. V. GRUDA

Projektes

PALMA CONSTRUCTION SHPK
 Projekti me mbështetje dhe faktim suksessive ndihmon
 Arkitekturë, Strukturë, Inxhinjeri dhe Inxhinjeri

Vula

Ing. Nd. M. BEDAJ

Ing. Nd. A. REFATLLARI SH. Ing. Mek. E. NUÇI

Ing. Nd. A. VOULLI
Ing. Top. F. REGASI

Projektes

HE & SK 11
 consulting company

Vula







Porosites

BASHKIA E TIRANES
 DREKTORIA E PËRGJITHSHME
 P. JUREVE PUBLIKE

BASHKIA TIRANE

Vula

LEGJENDE

-  BORDURRE BETONI NE TROTUARIN E RI
-  TROTUAR I RI
-  KUNNETE BETONI E RE
-  RRUGE E SISTEMUAR
-  NDERTESA EKZISTUESE
-  PUSETE K.U.Z EKZISTUESE
-  PUSETE K.U.SH 40 X 60 X 100 E RE

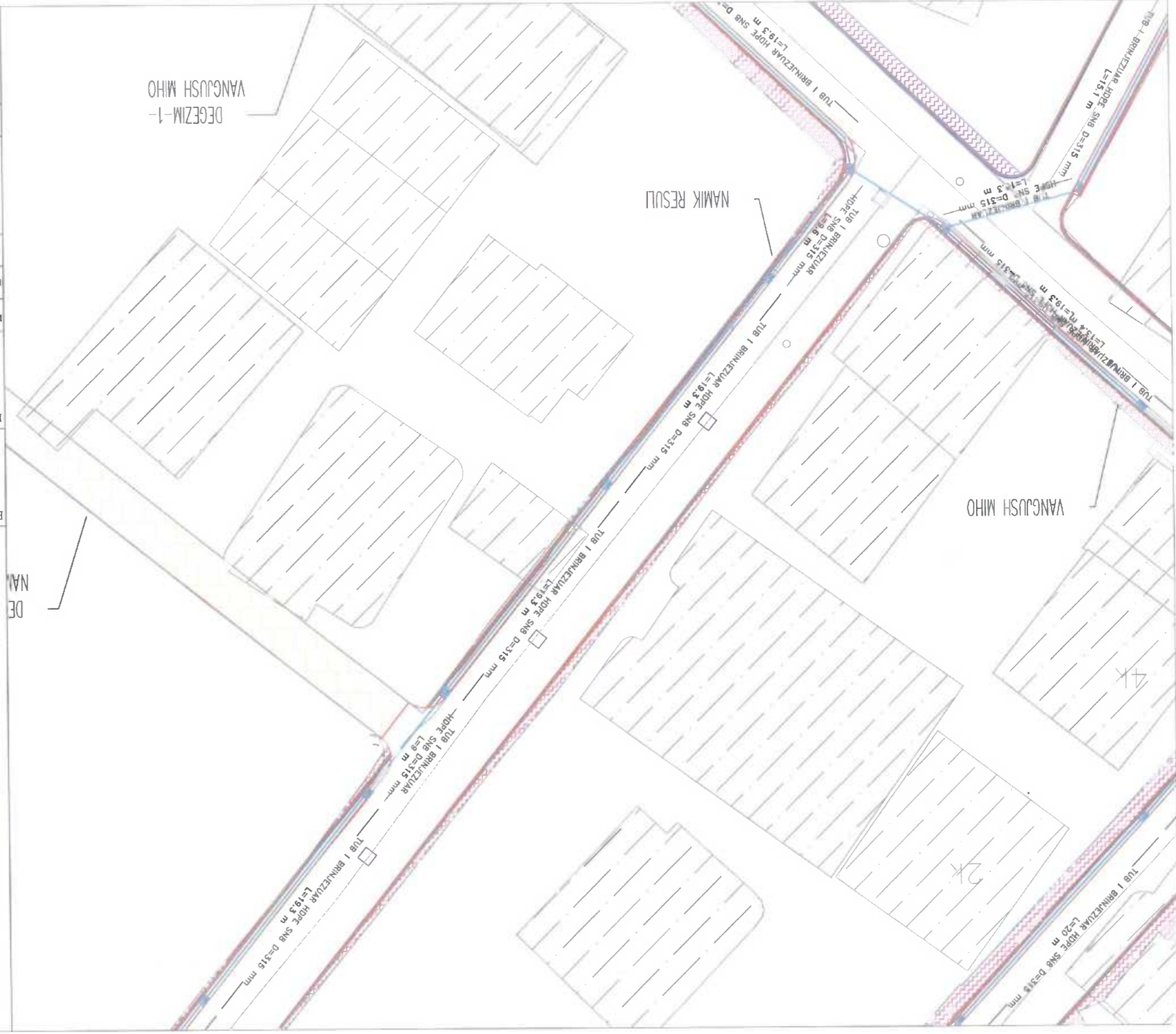

DEGEZIM-1-
VANGJUSH MIHO

VANGJUSH MIHO

DE
NA

EMERTIMI I FLETES:	Projekt-Zbatim	Rehabilitimi i rrugëve të bllokut që kufizohet nga Planimetria e Përgjithshme K.U.B. Rruga "Namik Resuli" dhe rrugët "L.çandro Zoto" - "Marti Krafaj" - "Disha" - "Sadik Petrelaj"
Numri i fletës:	Shkalla:	1-75

Ing. Nd. V. GRUDA

 PALMA CONSTRUCTION shpk
 Projektes
 Vuila

Ing. Nd. M. BE...

Ing. Nd. A. HERATLIM...

Ing. Top. F. BREGASI

Ing. Nd. A. VOGLI

 HE & SK 11
 Projektes
 Vuila

BASHKIA E TIRANES

BASHKIA E TIRANES

Porosites

LEJENDE

-  BORDURE BETONI NE TROTUARIN E RI
-  TROTUAR I RI
-  KURNETE BETONI E RE
-  RRUGE E SISTEMUAR
-  NDERTESA EKZISTUESE
-  PUSETE K.U.Z EKZISTUESE
-  PUSETE K.U.SH 40 X 60 X 100 E RE

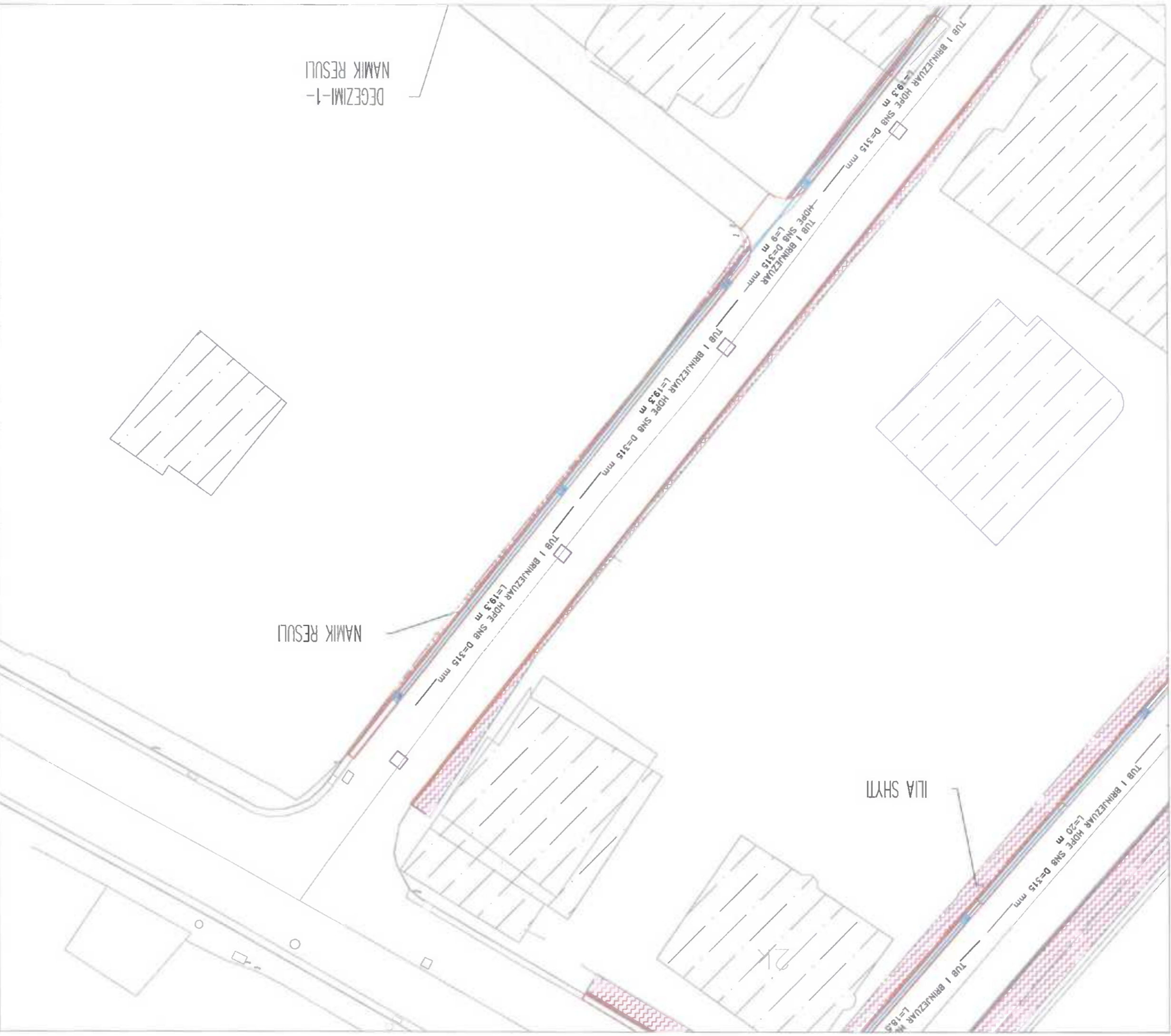

DEGEZIMI-1-
NAMIK RESULI

NAMIK RESULI

ILIA SHYTI

EMERTIMI I FLETES
 Projekt/baum
 Plannocetra e Peregjithsme K U B
 Kruga "Sterio Space"
 "Sadik Pecela"
 Rehabitimi i nugeve te
 rruget "Leandro Zoto"
 - "Mari Kraja"
 - "Disha"
 Shkalla
 Nivni i lites

Ing. Nd. V. GRUDA

Projektes
 PALMA CONSTRUCTION shpk
 Vula

Projektes
 HE & SK 11
 Ing. Nd. M. BEJAI

Projektes
 HE & SK 11
 Ing. Nd. A. RE...
 Ing. Nd. A. VOGLI

Projektes
 HE & SK 11
 Ing. Top. F. B...
 Ing. Nd. A. VOGLI

Projektes
 HE & SK 11
 Vula

Porositcs
 BASHKIA E TIRANES
 BASHKIA TIRANE
 Vula

LEGJENDE

	BORDURE BETONI NE TROTUARIN E RI
	TROTUAR I RI
	KUNETE BETONI E RE
	BRUCE E SISTEMUAR
	NDERTESA EKZISTUESE
	POSETE K.U.Z EKZISTUESE
	POSETE K.U.SH 40 X 60 X 100 E RE



EMERTIMI I FLETES:	Projekti-Zbatim Planimetria e Pergjithshme K.U.B Rruga "Sterio Space" Djeczimi 2 Rruga "Sterio Space"	Numri i Fletes: 1-75	Shkalla: 1:75
PROJEKTI:	Rehabilitimi i rrugëve të bllokut që kufizohet nga "Marti Kraja" - "Disha" "Sadik Petrela"		

Ing. Nd. V. GRUDA

Projektes

PALMA CONSTRUCTION shpk

Vula

Ing. Nd. M. BEO

Ing. Nd. A. ERATLLARI

Ing. Top. E. BREGASI

Ing. Nd. A. VITAJ

Projektes

HE & SK 11

Vula

Porosites

BASHKIA E TIRANES

BASHKIA
E TIRANES
DREKTORIA E PERKULISHIT
E PUNEVE RREJINALE

Vula

LEGJENDE

	BORDURE BETONI NE TROTUARIN E RI
	TROTUAR I RI
	KUNETE BETONI E RE
	RRUGE E SISTEMUAR
	NDERTESA EKZISTUESE
	PUSETE K.U.Z EKZISTUESE
	PUSETE K.U.SH 40 X 60 X 100 E RE



EMERTIMI I FLETES:
 Projekt Zbatim
 Planimetri e Pergjithshme K.U.B
 Rruga "Sterio Spase"
 Rrugët "I. candro Zoto" -
 "Marti Kraja" - "Disha" -
 "Sadik Petrela"
 Projekt Zbatim
 Planimetri e Pergjithshme K.U.B
 Rruga "Sterio Spase"
 Rrugët "I. candro Zoto" -
 "Marti Kraja" - "Disha" -
 "Sadik Petrela"
 Shkalla: 1:75
 Numri i Netes
 P.

Ing Nd V GRUDA

Projektes
 PALMA CONSTRUCTION shpk
 Vula

Ing Nd M BEDAJ

Projektes
 HE & SK 11
 Vula

Ing Nd A VOGLI

Projektes
 HE & SK 11
 Vula

Porosites
 BASHKIA E TIRANES
 BASHKIA E TIRANES
 TIRANE
 Vula

Ing Nd A REFATLARI

Projektes
 HE & SK 11
 Vula

Ing Nd M BEDAJ

Projektes
 HE & SK 11
 Vula

Ing Nd A VOGLI

Projektes
 HE & SK 11
 Vula

Ing Nd M BEDAJ

Projektes
 HE & SK 11
 Vula

Ing Nd A VOGLI

Projektes
 HE & SK 11
 Vula

Ing Nd M BEDAJ

Projektes
 HE & SK 11
 Vula

Ing Nd A VOGLI

Projektes
 HE & SK 11
 Vula

Ing Nd M BEDAJ

Projektes
 HE & SK 11
 Vula

Ing Nd A VOGLI

Projektes
 HE & SK 11
 Vula

Ing Nd M BEDAJ

Projektes
 HE & SK 11
 Vula

- LEGENDE**
- BORDURE BETONI NE TROTUARIN E RI
 - TROTUAR I RI
 - KUNETE BETONI E RE
 - RRUGE E SISTEMUAR
 - NDERTESA EKZISTUESE
 - PUSETE K.U.Z EKZISTUESE
 - PUSETE K.U.SH 40 X 60 X 100 E RE









EMERTIMI I FLETES:	Projekti-Zbatim Planimetri e Përgjithshme K.L.B Rruga "Sterio Space" Rruga "Sterio Space" Dëgjimi 3 Rruga "Sterio Space"	Shkallat: 1:75	Numri i Fletes: F-
PROJEKTI:	Rehabilitimi i rrugëve të bllokut që kufizohet nga rrugët "Luçandro Zoto" - "Marti Kraja" - "Sadik Petrela"		

Ing Nd: V. GRUDA

Projekti:	PALMA CONSTRUCTION shpk
Projekti:	Projekti i rregullimit të bllokut të rregullimit
Ing Nd: M. BEDAJ	SH & SK 11
Ing Nd: A. REFATILARI	HE & SK 11
Ing Mek: E. MUCAJ	HE & SK 11
Ing Nd: A. VOGLI	HE & SK 11
Ing Top: F. BREGASI	HE & SK 11

Projekti:	HE & SK 11
Projekti:	BASHKIA E TIRANES
Projekti:	BASHKIA E TIRANES
Projekti:	BASHKIA E TIRANES

LEGJENDE

-  BORDURE BETONI NE TROTUARIN E RI
-  TROTUAR I RI
-  KUNETE BETONI E RE
-  RRUGE E SISTEMUAR
-  NDERTESA EKZISTUESE
-  PUSETE K.U.Z EKZISTUESE
-  PUSETE K.U.SH 40 X 60 X 100 E RE



EMERTIMI I FLETES:	Projekti/baum Planimetri e Përgjithshme K.U.B Rruga "Vangjush Miho" pjesa 2	Shkalla: 1:75	Numri i fletes: F-
PROJEKTI:	Rehabilitimi i rrugëve të rrugët "Leandro Zoto" - "Mati Kraja" - "Disha" - "Sadik Petrela"		

Ing. Nd. V. GRUDA

PALMA CONSTRUCTION shpk

Projektes
Vula

Ing. Nd. M. BEDA

Ing. Nd. A. REF. D. ARI

Ing. Mek. E. MUCAJ

Ing. Top. F. BREGASI

HE & SK 11
consulting company







Projektes
Vula

BASHKIA E TIRANES
DIREKTORIA E PËRGJITHSHME
E RRUJVE PUBLIKE

BASHKIA TIRANË

Porositës
Vula

LEGJENDE

-  BORDURE BETONI NE TROTUARIN E RI
-  TROTUAR I RI
-  KUNETE BETONI E RE
-  RRUGE E SISTEMUAR
-  NDERTESA EKZISTUESE
-  PUSETE K.U.Z EKZISTUESE
-  PUSETE K.U.SH 40 X 60 X 100 E RE

DEGEZIM -9-
VIOLETA MANUSHI



EMËRTIMI I FLETES:
 Projekti-Zbatim
 Planimetri e Përgjithshme K. U. B
 bllokut që kufizohet nga
 rrugët "Leandro Zoto" -
 "Marti Kraja" - "Disha" -
 "Sadik Petela"
 Shkalla: 1:25
 Numri i Fletes P-

Ing. Nd. V. GRUDA

PALMA CONSTRUCTION shpk
 Projektes
 Vula

Ing. Nd. M. BEDAJ
 Projektes
 Vula

HE & SK 11
 Ing. Nd. A. RENTILAJ
 Projektes
 Vula







HE & SK 11
 Ing. Nd. A. VOGLI
 Projektes
 Vula

HE & SK 11
 Ing. Nd. F. BREGASI
 Projektes
 Vula

HE & SK 11
 Projektes
 Vula

BASHKIA E TIRANË
 BASHKIA E TIRANË
 DREKTORIA E PËRGJITHSHME
 E PUNËVE PUBLIKE
 POROSITES
 Vula

LEGJENDE

-  BORDURE BETONI NE TROTUARIN E RI
-  TROTUAR I RI
-  KUNETE BETONI E RE
-  RRUGE E SISTEMUAR
-  NDRERTESA EKZISTUESE
-  PUSETE K.U.Z EKZISTUESE
-  PUSETE K.U.SH 40 X 60 X 100 E RE



EMERTIMI I FLETES:
 Projekti/batim
 Planimetri e Përgjithshme K. 1 B
 Rruga "Vangush Miho" Pjesa 2
 Numri i Fletes:
 Shkalla:
 1:75

PROJEKTI:
 Reabilitimi i rrugëve të
 rrugët "Leandro Zoto" -
 "Mati Kraja" - "Disha" -
 "Sadik Petrela"

Ing. Nd. V. GRUDA
 Projektes
 PALMA CONSTRUCTION shpk
 Vula

Ing. Nd. M. BEDAJ
 Ing. Nd. A. RIKATTI, RI
 Ing. Nd. A. V. ...
 Ing. Top. F. BR...
 Ing. Mek. E. MU...
 Ing. Ele. ... ANAJ

Projektes
 HE & SK 11
 Vula

Porosites
 BASHKIA E TIRANES
 DIREKTORIA E PËRQYRTSHMIAE
 E PUNËVE PUBLIKE
 BASHKIA TIRANË
 Vula

LEGJENDE

	BORDURE BETONI NE TROTUARIN E RI
	TROTUAR I RI
	KUNETE BETONI E RE
	RRUGE E SISTEMUAR
	NDERTESA EKZISTUESE
	PUSETE K.U.Z. EKZISTUESE
	PUSETE K.U.SH 40 X 60 X 100 E RE



EMERTIMI I FLETES:
 Projekt-Zbatim
 Planimetri e Përgjithshme K.U.B
 Rruga "Paro Kita"
 Dëgjimi 2 Rruga "Paro Kita"
 Numri i Netes
 F-1:75
 Shkalla:







PROJEKTI:
 Reabilitimi i rrugëve të
 bllokut që kufizohet nga
 rrugët "Landro /oto"
 - "Disha"
 - "Sadiq Petrela"
 "Sadiq Petrela"

Ing. Nd. V. GRUDA
 PALMA CONSTRUCTION shpk
 Projektes
 Vula

Ing. Nd. M. BEDI
 Ing. Nd. A. REVAJ LABI
 Ing. Mek. E. MULLA
 Ing. Top. F. BREGASI
 Projektes
 Vula

HE & SK 11
 Projektes
 Vula

BASHKIA E TIRANËS
 DREKTORIA E PËRQYTRISHMË
 E PUNËVE PUBLIKE
 TIRANË
 Porosites
 Vula

- LEGJENDE
-  BORDURE BETONI NE TROTUARIN E RI
 -  TROTUAR I RI
 -  KUNETE BETONI E RE
 -  RRUGE E SISTEMUAR
 -  NDERTESA EKZISTUESE
 -  PUSËTE K.U.Z EKZISTUESE
 -  PUSËTE K.U.SH 40 X 60 X 100 E RE

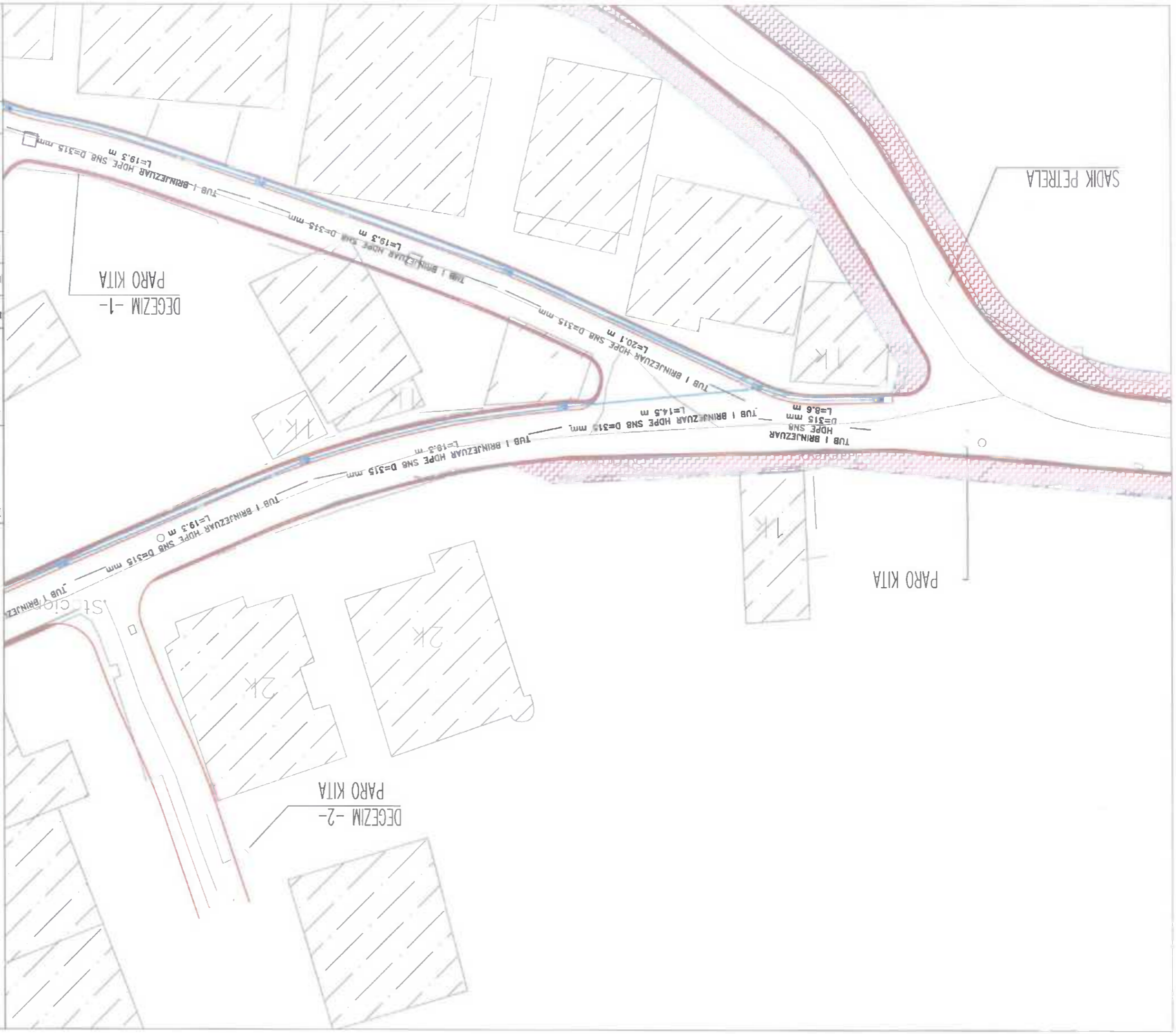

EMERTIMI I FLETES:
 Projekt-Zbatim
 Planimetri e Përgjithshme K.U.B
 Rruga "Paro Kita"
 Dëgjimi 3 Kruga "Paro Kita"
 Numri i Fletes:
 P-1-75

PROJEKTI:
 Rehabilitimi i rrugëve të
 rrugës "Leandro Zoto"
 - "Marti Kraja"
 - "Sadik Petrela"

Shkallja:
 1:75

Ing. Nd. V. GRUDA

Projektes

Ing. Nd. M. BE...

Ing. Nd. A. ...

Ing. Nd. A. VOGLI

Projektes

Vula

Porosites

Vula

Vula

Vula

Vula

Vula

Vula

Vula

Vula

Vula

Vula

Vula

Vula

Vula

Vula

Vula

Vula

Vula

Vula

Vula



- LEGJENDE**
- BORDURE BETONI NE TROTUARIN E RI
 - TROTUAR I RI
 - KUNETE BETONI E RE
 - RRUGE E SISTEMUAR
 - NDERTESA EKZISTUESE
 - PUSËTE K.U.Z EKZISTUESE
 - PUSËTE K.U.SH 40 X 60 X 100 E RE

PALMA CONSTRUCTION SHPK
 Projektes
 Vula

HE & SK 11
 Projektes
 Vula

BASHKIA E TIRANË
 DREKTORIA E PËRCJMTISHMË
 E FUNEVË PUBLIKË
 Porosites
 Vula

EMËRTIMI I FLETES:	Projekt-Zbatim Planimetri e Përgjithshme K.U.B Kruja "Paro Kita"	Shkalla: 1:75	Numri i Fletes
PROJEKTI:	Rehabilitimi i rrugëve të blloku që kufizohet nga rrugët "Leandro Zoto" - "Mati Kraja" - "Disha" - "Sadik Petrela"		

Ing. Nd. V. GRUDA

Projekues

PALMA CONSTRUCTION SHPK

Vula

Ing. Nd. M. BEDA

Ing. Nd. A. FAYTILANI

Ing. Nd. A. VOJCI RTI

Projekues

HE & SK 11

Vula

Porositës

BASHKIA E TIRANËS
DREKTORIA E PËRCJFTSHMËR
E PUNËVE PUBLIKE

BASHKIA TIRANË

Vula

LEGJENDE

- BORDURE BETONI NE TROTUARIN E RI
- TROTUAR I RI
- KUNETE BETONI E RE
- RRUGE E SISTEMUAR
- NDBERTESA EKZISTUESE
- PUSËTE K.U.Z EKZISTUESE
- PUSËTE K.U.SH 40 X 60 X 100 E RE



EMËRTIMI I FLETES:
 Projekti: Zbatim Planimetri e Përgjithshme K.U.B Rruga "Paro Kita"

PROJEKTI:
 Rehabilitimi i rrugëve të rrugët "Leandro Zoto" - "Mati Kraja" - "Disha" - "Sadik Penela"

Shkalla: 1:75
 Numri i Fletes: P-

Ing. Nd. V. GRUDA

Projektes
 PALMA CONSTRUCTION shpk
 Vula

Ing. Nd. M. BEĐAJ







Ing. Nd. A. REKUPARI

Ing. Top. F. BREGASI





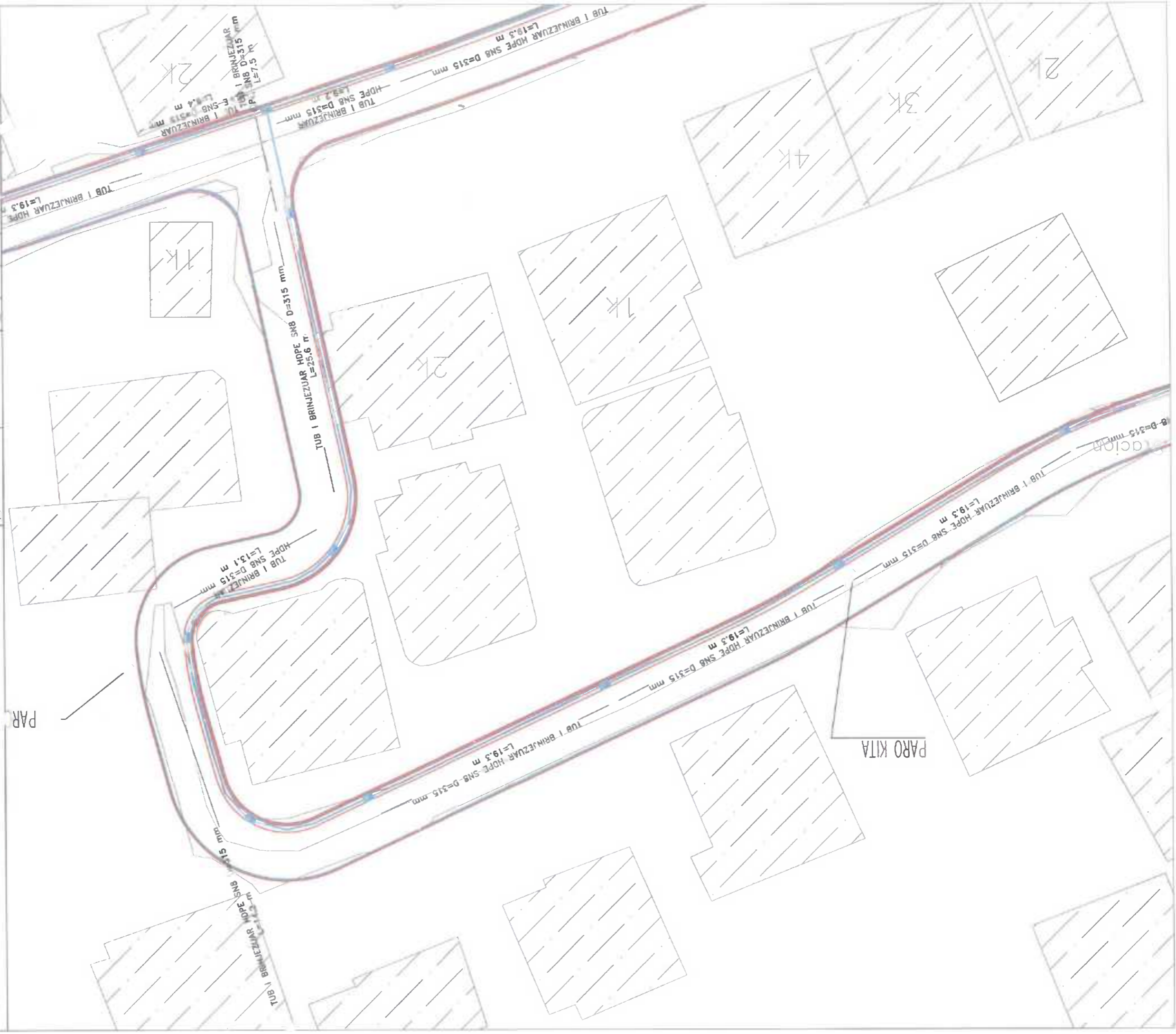

Projektes
 HE & SK 11
 Vula

Porosites
 BASHKIA E TIRANË
 Vula

LEGJENDE

-  BORDURE BETONI NE TROTUARIN E RI
-  TROTUAR I RI
-  KUNETE BETONI E RE
-  RRUGE E SISTEMUAR
-  NDERTESA EKZISTUESE
-  PUSETE K.U.Z EKZISTUESE
-  PUSETE K.U.SH 40 X 60 X 100 E RE



- LEGJENDE**
-  BORDURE BETONI NE TROTUARIN E RI
 -  TROTUAR I RI
 -  KUNETE BETONI E RE
 -  RRUQE E SISTEMUAR
 -  NDERTESA EKZISTUESE
 -  PUSFTE K.U.Z EKZISTUESE
 -  PUSFTE K.U.SH 40 X 60 X 100 E RE

Porosites

BASHKIA E TIRANES
 DEPARTORJA E PËRKËTUESHAR
 E PLANIMETRIKË

BASHKIA TIRANË

Projektes

HE & SK 11
 consulting company

Projektes

PALMA CONSTRUCTION shpk

Ing. Nd. V. GRUDA

EMERTIMI I FLETES:

Projekti-Zbatim	Rehabilitimi i rrugëve të rrugët "Leandro Zoto" - "Mari Krasta" - "Sadik Petrela"
Planimetri e Përgjithshme K.U.B	Rruga "Arian Xhumari"
Degetimi I Rruga "Arian Xhumari"	
Numri i Fletes:	1.75



EMERTIMI I FLETES:
 Projekti: "Rehabilitimi i rrugëve të bllokut që kundërbëhet nga rrugët "Leandro Zoto" - "Miri Krasta" - "Sadik Petrelia"

Ing. Nd. V. GRUDA

Projekues: PALMA CONSTRUCTION shpk
 Vula

Ing. Nd. M. BE...

Ing. Nd. A. H. ...

Ing. Nd. A. V. ...

Projekues: HE & SK 11
 Vula

Porositës: BASHKIA E TIRANES
 Vula

LEGJENDE

	BORDURE BETONI NE TROTUARIN E RI
	TROTUAR I RI
	KUNETE BETONI E RE
	RRUGE E SISTEMUAR
	NDERTESA EKZISTUESE
	PUSETE K.U.Z EKZISTUESE
	PUSETE K.U.SH 40 X 60 X 100 E RE



EMERTIMI I FLETES	Projekti-Zbatim blloku qe kufizohet nga rregull "Leandro Zoro" "Mari Krasta" - "Disha" "Sadik Petrela"	Shkalla: 1:75 Numri i Fletes:
Ing. Nd. V. GRUDA		

Projekti: PALMA CONSTRUCTION shpk

Vula

Ing. Nd. M. BEDAJ

Projekti: HE & SK 11

Vula

Ing. Nd. A. VOGLI

Projekti: BASHKIA E TIRANES

Vula

Ing. Nd. A. VOGLI

Projekti: BASHKIA E TIRANES

Vula

Ing. Nd. A. VOGLI

LEGJENDE

- BORDURE BETONI NE TROTUARIN E RI
- TROTUAR I RI
- KUNETE BETONI E RE
- RRUGE E SISTEMUAR
- NDERTESA EKZISTUESE
- PUSETE K.U.Z EKZISTUESE
- PUSETE K.U.SH 40 X 60 X 100 E RE



Projekti: Rehabilitimi i rrugëve të bllokuar që kufizohen nga rrugët "Leandro Zoto" - "Mari Kraja" - "Disha" - "Sadik Petrela"	Shkallë: 1:75	Numri i Fletës P-
---	------------------	----------------------

Ing. Nd. V. GRUDA

Projektes
Vula

PALMA CONSTRUCTION SHPK
Kryeshtetë, Shqipëri

Ing. Nd. M. P. ALI
Ing. E. K. N. DANAJ

Projektes
Vula

HE & SK 11
consulting company

Ing. Nd. A. VOGLI
Ing. T. F. GASI

Porositës
Vula

BASHKIA E TIRANËS
DREKTORIA E PËRQISHTIME
D. PENALVA PUBLIKE

BASHKIA E TIRANËS
TIRANË

- LEGJENDE**
- BORDURË BETONI NE TROTUARIN E RI
 - TROTUAR I RI
 - KURNETE BETONI E RE
 - RRUGE E SISTEMUAR
 - NDRERTESA EKZISTUESE
 - PUSËTE K.U.Z EKZISTUESE
 - PUSËTE K.U.SH 40 X 60 X 100 E RE



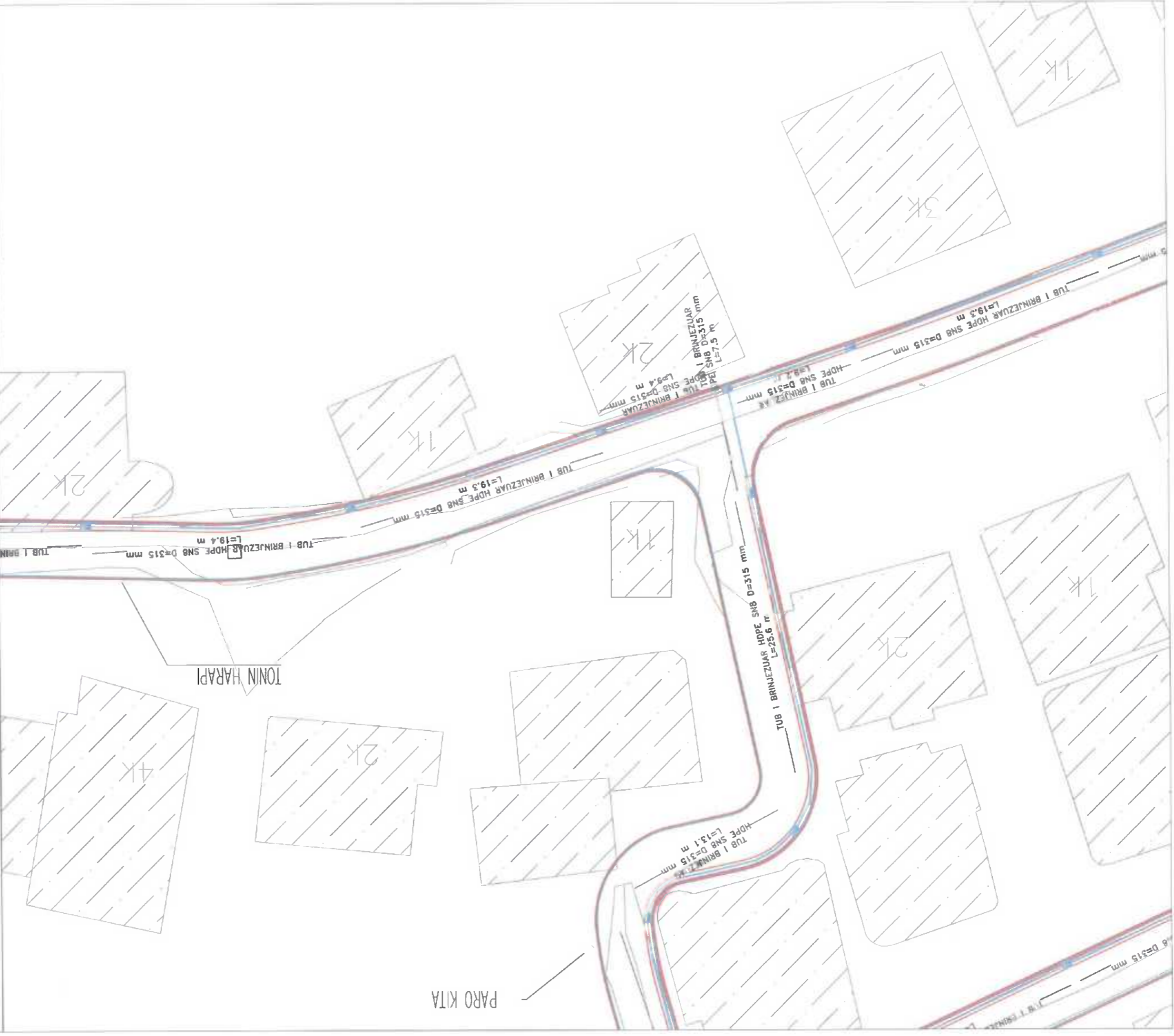

Projekti	Rehabilitimi i rruges e bllokut qe kufizohet nga "Leandro Zoto" - "Mari Krata" - "Disha" - "Sadik Perca"
EMERTIMI I FLETES:	Projekt-Zbatim Planimetria e Përgjithshme K.U.B Kruja "Tonin Harapi"
Shkalla:	1:75
Numri i Fletes	F-
Projektes	Ing. Nd. V. GRUDA
Projektes	Ing. Nd. M. BEDA
Projektes	Ing. Nd. A. R. MULLAJ
Projektes	Ing. Top. F. SHKASI
Projektes	Ing. Nd. A. VOGLI
Projektes	Ing. Nd. M. BEKA
Projektes	Ing. Nd. M. BEKA
Porositës	BASHKIA E TIRANES DREKTORIA E PROJEKTIMIT E PUNIVE PUBLIKE
Porositës	BASHKIA E TIRANES DREKTORIA E PUNIVE PUBLIKE

LEGJENDE

- BORDURE BETONI NE TROTUARIN E RI
- TROTUAR I RI
- KUNETE BETONI E RE
- RRUGE E SISTEMUAR
- NDERTESA EKZISTUESE
- PUSETE K.U.Z EKZISTUESE
- PUSETE K.U.SH 40 X 60 X 100 E RE

HE & SK 11
consulting company

PALMA CONSTRUCTION shpk

HE & SK 11
Ing. M. K. MUKA
Ing. Top. F. SHKASI

EMERTIMI I FLETËS	Projekt-zbatim Planimetria e Përgjithshme K.1.13 Kryegje "Tomir Harapi" Rrugët "Leandro Zoto" - "Mari Krata" - "Disha" - "Sadik Petrela"
Shkallë: 1:75	Numri i Fletës

Ing. Nd. V. GRUDA

Projekues

PALMA CONSTRUCTION shpk

TONIN HARAPI

Ing. Nd. M. BEDAJ

Ing. Mek. E. MUCAJ

Ing. Nd. P. BREGASI



Projekues

Porositës

BASHKIA E TIRANË
RREZJA E PËRQITSHMË
E PUNËV. PUBLIKE

BASHKIA E TIRANË

LEGJENDE

- BORDURË BETONI NE TROTUARIN E RI
- TROTUAR I RI
- KUNËTE BETONI E RE
- RRUQE E SISTEMUAR
- NDERTESA EKZISTUESË
- PUSËTE K.U.Z. EKZISTUESË
- PUSËTE K.U.S.H. 40 X 60 X 100 E RE



EMERTIMI I FLETES
 Projekt-Zbatim
 Planimetria e Përgjithshme K.L.B
 Rruga "Tom Harapi"
 Rrugët "Leandro Zoto" -
 "Mati Krata" - "Disha" -
 "Sadik Petela"
 Shkalla 1:75
 Numri i Fletes

Ing. Nd. V. GRUDA

Projektes
 PALMA CONSTRUCTION shpk

Projektes
 Ing. N. M. E. VJ
 E. D. N. DANAJ

Projektes
 Ing. Nd. V. BREGASI



Projektes
 HE & SK 11
 consulting company

Porosites
 BASHKIA E TIRANES
 DREKTORIA E PERQUTTHSME
 E PUNDE PUBLIKE
 BASHKIA TIRANE

LEGJENDE

- BORDURE BETONI NE TROTUARIN E RI
- TROTUAR I RI
- KUNETE BETONI E RE
- RRUGE E SISTEMUAR
- NDERTESA EKZISTUESE
- PUSETE K.U.Z EKZISTUESE
- PUSETE K.U.SH 40 X 60 X 100 E RE

